

TLC227x-Q1 先進のレール・ツー・レール LinCMOS™ オペアンプ

1 特長

- 車載アプリケーション向けに AEC-Q100 認定済み
 - 温度グレード 1: -40°C ~ 125°C, T_A
- 機能安全対応
 - 機能安全システムの設計に役立つ資料を利用可能 (TLC2272-Q1)
 - 機能安全システムの設計に役立つ資料を利用可能 (TLC2272A-Q1)
- 出力シングに両方の電源レールを含む
- 低いノイズ: f = 1kHz 時に 9nV/√Hz (標準値)
- 低い入力バイアス電流: 1pA (標準値)
- 単一電源と分割電源での動作を完全に規定
- 同相入力電圧範囲に負のレールを含む
- 高ゲイン帯域幅: 2.2MHz (標準値)
- 高いスルーレート: 3.6V/μs (標準値)
- 低い入力オフセット電圧: 950μV 以下 (T_A = 25°C)
- マクロモデル内蔵

2 アプリケーション

- ボディ・コントロール・モジュール
- バッテリー・マネージメント・システム
- カー・オーディオ
- DC/DC コンバータ
- 電動パワー・ステアリング
- エンジン制御ユニット
- ガソリン・エンジン
- インストルメント・クラス
- インバータおよびモータ制御
- オンボード・チャージャ
- テレマティクス制御ユニット
- トランスミッション制御
- 白物家電 (冷蔵庫、洗濯機)

3 概要

TLC227x-Q1 はデュアルおよびクワッド LinCMOS™ オペアンプです。どちらのデバイスも、単一および分割電源アプリケーションで広いダイナミック・レンジが得られるレール・ツー・レールの出力特性を示します。TLC227x-Q1 ファミリーは 2MHz の帯域幅と 3V/μs のスルーレートを実現しており、高速アプリケーションに適しています。これらのデバイスは既存の CMOS オペアンプと同等の AC 性能を備えながら、ノイズ、入力オフセット電圧、消費電力の点で CMOS オペアンプより優れています。TLC227x-Q1 のノイズ電圧は 9nV/√Hz で、競合ソリューションの半分です。

TLC227x-Q1 は入力インピーダンスが高く、ノイズが低いいため、圧電性トランスデューサなど高インピーダンスのソース用の小信号コンディショニングに最適です。さらに、単一

または分割電源でレール・ツー・レール出力が可能なため、このファミリーは A/D コンバータ (ADC) と接続するための優れた選択肢です。

高精度のアプリケーション向けには、最大入力オフセット電圧 950μV の TLC227xA-Q1 ファミリーが利用可能です。このファミリーは 5V および ±5V で完全に動作が規定されています。

これらのデバイスは広い出力ダイナミック・レンジ、小さいノイズ電圧、小さい入力オフセット電圧を実現しています。これらの拡張機能セットから、TLC227x-Q1 は広範なアプリケーションで使用可能です。より高い出力駆動能力と広い入力電圧範囲を必要とするアプリケーションについては、TLV2432-Q1 と TLV2442-Q1 を参照してください。TLC227x-Q1 ファミリーのすべてのパラメータのおかげで、これらのデバイスはほとんどの車載アプリケーションに適用可能です。

パッケージ情報

| 部品番号 | パッケージ ⁽¹⁾ | 本体サイズ (公称) |
|----------------------------|----------------------|-----------------|
| TLC2272-Q1, TLC2272A-Q1 | SOIC (8) | 4.90mm × 3.91mm |
| | TSSOP (8) | 3.00mm × 4.40mm |
| TLC2274-Q1, TLC2274A-Q1 | SOIC (14) | 8.65mm × 3.91mm |
| | TSSOP (14) | 5.00mm × 4.40mm |

- (1) 利用可能なパッケージについては、このデータシートの末尾にある注文情報を参照してください。

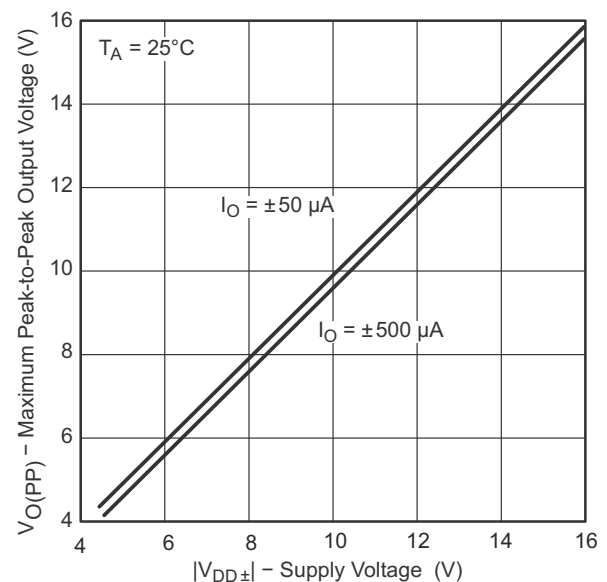

最大ピーク・ツー・ピーク出力電圧と電源電圧との関係



Table of Contents

| | | | |
|---|----|--|----|
| 1 特長 | 1 | 7.1 Overview..... | 22 |
| 2 アプリケーション | 1 | 7.2 Functional Block Diagram..... | 22 |
| 3 概要 | 1 | 7.3 Feature Description..... | 22 |
| 4 Revision History | 2 | 7.4 Device Functional Modes..... | 22 |
| 5 Pin Configuration and Functions | 3 | 8 Application and Implementation | 23 |
| 6 Specifications | 4 | 8.1 Application Information..... | 23 |
| 6.1 Absolute Maximum Ratings..... | 4 | 8.2 Typical Application..... | 24 |
| 6.2 ESD Ratings..... | 4 | 8.3 Power Supply Recommendations..... | 26 |
| 6.3 Recommended Operating Conditions..... | 4 | 8.4 Layout..... | 26 |
| 6.4 Thermal Information..... | 5 | 9 Device and Documentation Support | 28 |
| 6.5 Electrical Characteristics: $V_{DD} = 5\text{ V}$ (TLC2272- Q1 and TLC2272A-Q1)..... | 5 | 9.1 Device Support..... | 28 |
| 6.6 Electrical Characteristics: $V_{DD\pm} = \pm 5\text{ V}$ (TLC2272-Q1 and TLC2272A-Q1)..... | 6 | 9.2 Documentation Support..... | 28 |
| 6.7 Electrical Characteristics: $V_{DD} = 5\text{ V}$ (TLC2274- Q1 and TLC2274A-Q1)..... | 8 | 9.3 Receiving Notification of Documentation Updates...28 | |
| 6.8 Electrical Characteristics: $V_{DD\pm} = \pm 5\text{ V}$ (TLC2274-Q1 and TLC2274A-Q1)..... | 9 | 9.4 サポート・リソース..... | 28 |
| 6.9 Typical Characteristics..... | 11 | 9.5 Trademarks..... | 28 |
| 7 Detailed Description | 22 | 9.6 Electrostatic Discharge Caution..... | 29 |
| | | 9.7 Glossary..... | 29 |
| | | 10 Mechanical, Packaging, and Orderable Information | 29 |

4 Revision History

資料番号末尾の英字は改訂を表しています。その改訂履歴は英語版に準じています。

| Changes from Revision F (March 2016) to Revision G (August 2022) | Page |
|--|------|
| • 文書全体にわたって表、図、相互参照の採番方法を更新..... | 1 |
| • 「特長」の箇条書き項目に機能安全の情報を追加..... | 1 |

| Changes from Revision E (January 2012) to Revision F (March 2016) | Page |
|---|------|
| • 「ピン構成および機能」セクション、「機能説明」セクション、「デバイスの機能モード」セクション、「アプリケーションと実装」セクション、「電源に関する推奨事項」セクション、「レイアウト」セクション、「デバイスおよびドキュメントのサポート」セクション、「メカニカル、パッケージ、および注文情報」セクションを追加..... | 1 |
| • Added <i>ESD ratings</i> table..... | 4 |

| Changes from Revision D (March 2009) to Revision E (January 2012) | Page |
|---|------|
| • Deleted <i>ESD ratings</i> table..... | 4 |

5 Pin Configuration and Functions

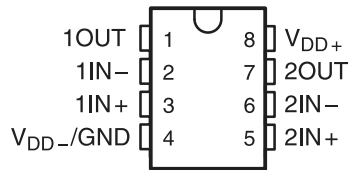

**图 5-1. TLC2272-Q1 and TLC2272A-Q1:
D (8-Pin SOIC) or PW (8-Pin TSSOP)
Packages, Top View**

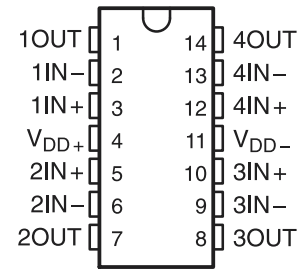

**图 5-2. TLC2274-Q1 and TLC2274A-Q1:
D (14-Pin SOIC) or PW (14-Pin TSSOP)
Packages, Top View**

表 5-1. Pin Functions

| NAME | PIN NO. | | TYPE | DESCRIPTION |
|------------------|----------------------------|----------------------------|--------|-------------------------------|
| | TLC2272-Q1, TLC2272A-Q1 | TLC2274-Q1, TLC2274A-Q1 | | |
| 1IN+ | 3 | 3 | Input | Noninverting input, channel 1 |
| 1IN- | 2 | 2 | Input | Inverting input, channel 1 |
| 1OUT | 1 | 1 | Output | Output, channel 1 |
| 2IN+ | 5 | 5 | Input | Noninverting input, channel 2 |
| 2IN- | 6 | 6 | Input | Inverting input, channel 2 |
| 2OUT | 7 | 7 | Output | Output, channel 2 |
| 3IN+ | — | 10 | Input | Noninverting input, channel 3 |
| 3IN- | — | 9 | Input | Inverting input, channel 3 |
| 3OUT | — | 8 | Output | Output, channel 3 |
| 4IN+ | — | 12 | Input | Noninverting input, channel 4 |
| 4IN- | — | 13 | Input | Inverting input, channel 4 |
| 4OUT | — | 14 | Output | Output, channel 4 |
| V _{DD+} | 8 | 4 | Input | Positive (highest) supply |
| V _{DD-} | 4 | 11 | Input | Negative (lowest) supply |

6 Specifications

6.1 Absolute Maximum Ratings

over operating free-air temperature range (unless otherwise noted)⁽¹⁾

| | MIN | MAX | UNIT |
|---|-----------------|-----------|------|
| Supply voltage, V_{DD+} ⁽²⁾ | | 8 | V |
| V_{DD-} ⁽²⁾ | -8 | | V |
| Differential input voltage, V_{ID} ⁽³⁾ | | ±16 | V |
| Input voltage, V_I (any input) ⁽²⁾ | $V_{DD-} - 0.3$ | V_{DD+} | V |
| Input current, I_I (any input) | | ±5 | mA |
| Output current, I_O | | ±50 | mA |
| Total current into V_{DD+} | | ±50 | mA |
| Total current out of V_{DD-} | | ±50 | mA |
| Duration of short-circuit current at (or below) 25°C ⁽⁴⁾ | Unlimited | | |
| Operating free-air temperature range, T_A | -40 | 125 | °C |
| Lead temperature 1,6 mm (1/16 inch) from case for 10 seconds | D or PW package | | 260 |
| Storage temperature, T_{stg} | -65 | 150 | °C |

- (1) Stresses beyond those listed under *Absolute Maximum Ratings* may cause permanent damage to the device. These are stress ratings only, which do not imply functional operation of the device at these or any other conditions beyond those indicated under [セクション 6.3](#). Exposure to absolute-maximum-rated conditions for extended periods may affect device reliability.
- (2) All voltage values, except differential voltages, are with respect to the midpoint between V_{DD+} and V_{DD-} .
- (3) Differential voltages are at $IN+$ with respect to $IN-$. Excessive current will flow if input is brought below $V_{DD-} - 0.3$ V.
- (4) The output can be shorted to either supply. Temperature or supply voltages must be limited so that the maximum dissipation rating is not exceeded.

6.2 ESD Ratings

| | | VALUE | UNIT |
|-------------|-------------------------|---|-------|
| $V_{(ESD)}$ | Electrostatic discharge | Human-body model (HBM), per AEC Q100-002 ⁽¹⁾ HBM ESD classification level 2 | ±2000 |
| | | Charged-device model (CDM), per AEC Q100-011 CDM ESD classification level C6 | ±1000 |

- (1) AEC Q100-002 indicates that HBM stressing shall be in accordance with the ANSI/ESDA/JEDEC JS-001 specification.

6.3 Recommended Operating Conditions

over operating free-air temperature range (unless otherwise noted)

| | | MIN | MAX | UNIT |
|-----------|--------------------------------|-----------|-----------------|------|
| $V_{DD±}$ | Supply voltage | ±2.2 | ±8 | V |
| V_I | Input voltage | V_{DD-} | $V_{DD+} - 1.5$ | V |
| V_{IC} | Common-mode input voltage | V_{DD-} | $V_{DD+} - 1.5$ | V |
| T_A | Operating free-air temperature | -40 | 125 | °C |

6.4 Thermal Information

| THERMAL METRIC ⁽¹⁾ | | TLC2272-Q1, TLC2272A-Q1 | | TLC2274-Q1, TLC2274A-Q1 | | UNIT |
|-------------------------------|--|-------------------------|------------|-------------------------|------------|------|
| | | D (SOIC) | PW (TSSOP) | D (SOIC) | PW (TSSOP) | |
| | | 8 PINS | 8 PINS | 14 PINS | 14 PINS | |
| R _{θJA} | Junction-to-ambient thermal resistance | 115.6 | 175.8 | 83.8 | 111.6 | °C/W |
| R _{θJC(top)} | Junction-to-case (top) thermal resistance | 61.8 | 58.8 | 43.2 | 41.2 | °C/W |
| R _{θJB} | Junction-to-board thermal resistance | 55.9 | 104.3 | 38.4 | 54.7 | °C/W |
| ψ _{JT} | Junction-to-top characterization parameter | 14.3 | 5.9 | 9.4 | 3.9 | °C/W |
| ψ _{JB} | Junction-to-board characterization parameter | 55.4 | 102.3 | 38.1 | 53.9 | °C/W |
| R _{θJC(bot)} | Junction-to-case (bottom) thermal resistance | — | — | — | — | °C/W |

(1) For more information about traditional and new thermal metrics, see the [Semiconductor and IC Package Thermal Metrics application report](#).

6.5 Electrical Characteristics: V_{DD} = 5 V (TLC2272-Q1 and TLC2272A-Q1)

at specified free-air temperature, V_{DD} = 5 V; T_A = 25°C, unless otherwise noted.

| PARAMETER | | TEST CONDITIONS | | MIN | TYP | MAX | UNIT |
|---------------------------|---|---|---------------------------------------|---------------------------|------------------|------|-------|
| V _{IO} | Input offset voltage | V _{IC} = 0 V, V _{DD±} = ±2.5 V, V _O = 0 V, R _S = 50 Ω | TLC2272-Q1 | T _A = 25°C | 300 | 2500 | μV |
| | | | TLC2272A-Q1 | | 300 | 950 | |
| | | | TLC2272-Q1 | Full Range ⁽¹⁾ | | 3000 | |
| | | | TLC2272A-Q1 | | 1500 | | |
| α _{VIO} | Temperature coefficient of input offset voltage | V _{IC} = 0 V, V _{DD±} = ±2.5 V, V _O = 0 V, R _S = 50 Ω | | | 2 | | μV/°C |
| | Input offset voltage long-term drift ⁽²⁾ | V _{IC} = 0 V, V _{DD±} = ±2.5 V, V _O = 0 V, R _S = 50 Ω | | | 0.002 | | μV/mo |
| I _{IO} | Input offset current | V _{IC} = 0 V, V _{DD±} = ±2.5 V, V _O = 0 V, R _S = 50 Ω | T _A = 25°C | 0.5 | 60 | pA | |
| | | | Full Range ⁽¹⁾ | | 800 | | |
| I _{IB} | Input bias current | V _{IC} = 0 V, V _{DD±} = ±2.5 V, V _O = 0 V, R _S = 50 Ω | T _A = 25°C | 1 | 60 | pA | |
| | | | Full Range ⁽¹⁾ | | 800 | | |
| V _{ICR} | Common-mode input voltage | R _S = 50 Ω; V _{IO} ≤ 5 mV | T _A = 25°C | -0.3 | 2.5 | 4 | V |
| | | | Full Range ⁽¹⁾ | 0 | 2.5 | 3.5 | |
| V _{OH} | High-level output voltage | I _{OH} = -20 μA | T _A = 25°C | 4.85 | 4.93 | V | |
| | | | Full Range ⁽¹⁾ | 4.85 | | | |
| | | | T _A = 25°C | 4.25 | 4.65 | | |
| | | | Full Range ⁽¹⁾ | 4.25 | | | |
| V _{OL} | Low-level output voltage | V _{IC} = 2.5 V | I _{OL} = 50 μA | | 0.01 | V | |
| | | | I _{OL} = 500 μA | T _A = 25°C | 0.09 | | 0.15 |
| | | | | Full Range ⁽¹⁾ | | | 0.15 |
| | | | I _{OL} = 5 mA | T _A = 25°C | 0.9 | | 1.5 |
| Full Range ⁽¹⁾ | | 1.5 | | | | | |
| A _{VD} | Large-signal differential voltage amplification | V _{IC} = 2.5 V, V _O = 1 V to 4 V | R _L = 10 kΩ ⁽³⁾ | T _A = 25°C | 10 | 35 | V/mV |
| | | | R _L = 1 MΩ ⁽³⁾ | Full Range ⁽¹⁾ | 10 | | |
| | | | | | 175 | | |
| r _{id} | Differential input resistance | | | | 10 ¹² | Ω | |
| r _i | Common-mode input resistance | | | | 10 ¹² | Ω | |
| c _i | Common-mode input capacitance | f = 10 kHz, P package | | | 8 | pF | |
| z _o | Closed-loop output impedance | f = 1 MHz, A _v = 10 | | | 140 | Ω | |
| CMRR | Common-mode rejection ratio | V _{IC} = 0 V to 2.7 V, V _O = 2.5 V, R _S = 50 Ω | T _A = 25°C | 70 | 75 | dB | |
| | | | Full Range ⁽¹⁾ | 70 | | | |
| k _{SVR} | Supply-voltage rejection ratio (ΔV _{DD} / ΔV _{IO}) | V _{DD} = 4.4 V to 16 V, V _{IC} = V _{DD} / 2, no load | T _A = 25°C | 80 | 95 | dB | |
| | | | Full Range ⁽¹⁾ | 80 | | | |

6.5 Electrical Characteristics: $V_{DD} = 5\text{ V}$ (TLC2272-Q1 and TLC2272A-Q1) (continued)

 at specified free-air temperature, $V_{DD} = 5\text{ V}$; $T_A = 25^\circ\text{C}$, unless otherwise noted.

| PARAMETER | | TEST CONDITIONS | | MIN | TYP | MAX | UNIT |
|-----------|---|---|---------------------------|-----|---------|-----|------------------------|
| I_{DD} | Supply current | $V_O = 2.5\text{ V}$, no load | $T_A = 25^\circ\text{C}$ | | 2.2 | 3 | mA |
| | | | Full Range ⁽¹⁾ | | | | |
| SR | Slew rate at unity gain | $V_O = 0.5\text{ V}$ to 2.5 V , $R_L = 10\text{ k}\Omega$ ⁽³⁾ , $C_L = 100\text{ pF}$ ⁽³⁾ | $T_A = 25^\circ\text{C}$ | | 2.3 | 3.6 | V/ μs |
| | | | Full Range ⁽¹⁾ | | 1.7 | | |
| V_n | Equivalent input noise voltage | f = 10 Hz | | | 50 | | nV/ $\sqrt{\text{Hz}}$ |
| | | | f = 1 kHz | | | 9 | |
| V_{NPP} | Peak-to-peak equivalent input noise voltage | f = 0.1 Hz to 1 Hz | | | 1 | | μV |
| | | | f = 0.1 Hz to 10 Hz | | | 1.4 | |
| I_n | Equivalent input noise current | | | | 0.6 | | fA/ $\sqrt{\text{Hz}}$ |
| THD+N | Total harmonic distortion + noise | $V_O = 0.5\text{ V}$ to 2.5 V , f = 20 kHz, $R_L = 10\text{ k}\Omega$ ⁽³⁾ | $A_V = 1$ | | 0.0013% | | |
| | | | $A_V = 10$ | | 0.004% | | |
| | | | $A_V = 100$ | | 0.03% | | |
| | Gain-bandwidth product | f = 10 kHz, $R_L = 10\text{ k}\Omega$ ⁽³⁾ , $C_L = 100\text{ pF}$ ⁽³⁾ | | | 2.18 | | MHz |
| B_{OM} | Maximum output-swing bandwidth | $V_{O(PP)} = 2\text{ V}$, $A_V = 1$, $R_L = 10\text{ k}\Omega$ ⁽³⁾ , $C_L = 100\text{ pF}$ ⁽³⁾ | | | 1 | | MHz |
| t_s | Settling time | $A_V = -1$, $R_L = 10\text{ k}\Omega$ ⁽³⁾ , Step = 0.5 V to 2.5 V, $C_L = 100\text{ pF}$ ⁽³⁾ | To 0.1% | | 1.5 | | μs |
| | | | To 0.01% | | 2.6 | | |
| ϕ_m | Phase margin at unity gain | $R_L = 10\text{ k}\Omega$ ⁽³⁾ , $C_L = 100\text{ pF}$ ⁽³⁾ | | | 50° | | |
| | Gain margin | $R_L = 10\text{ k}\Omega$ ⁽³⁾ , $C_L = 100\text{ pF}$ ⁽³⁾ | | | 10 | | dB |

 (1) $T_A = -40^\circ\text{C}$ to 125°C .

 (2) Typical values are based on the input offset voltage shift observed through 168 hours of operating life test at $T_A = 150^\circ\text{C}$ extrapolated to $T_A = 25^\circ\text{C}$ using the Arrhenius equation and assuming an activation energy of 0.96 eV.

(3) Referenced to 0 V.

6.6 Electrical Characteristics: $V_{DD\pm} = \pm 5\text{ V}$ (TLC2272-Q1 and TLC2272A-Q1)

 at specified free-air temperature, $V_{DD\pm} = \pm 5\text{ V}$; $T_A = 25^\circ\text{C}$, unless otherwise noted.

| PARAMETER | | TEST CONDITIONS | | MIN | TYP | MAX | UNIT | |
|----------------|---|--|---------------------------|---------------------------|-------|-------|------------------------------|------|
| V_{IO} | Input offset voltage | $V_{IC} = 0\text{ V}$, $V_O = 0\text{ V}$, $R_S = 50\ \Omega$ | TLC2272-Q1 | $T_A = 25^\circ\text{C}$ | 300 | 2500 | μV | |
| | | | TLC2272A-Q1 | | 300 | 950 | | |
| | | | TLC2272-Q1 | Full Range ⁽¹⁾ | | | | 3000 |
| | | | TLC2272A-Q1 | | | | | 1500 |
| α_{VIO} | Temperature coefficient of input offset voltage | $V_{IC} = 0\text{ V}$, $V_O = 0\text{ V}$, $R_S = 50\ \Omega$ | | | 2 | | $\mu\text{V}/^\circ\text{C}$ | |
| | Input offset voltage long-term drift ⁽²⁾ | $V_{IC} = 0\text{ V}$, $V_O = 0\text{ V}$, $R_S = 50\ \Omega$ | | | 0.002 | | $\mu\text{V}/\text{mo}$ | |
| I_{IO} | Input offset current | $V_{IC} = 0\text{ V}$, $V_O = 0\text{ V}$, $R_S = 50\ \Omega$ | $T_A = 25^\circ\text{C}$ | | 0.5 | 60 | pA | |
| | | | Full Range ⁽¹⁾ | | | 800 | | |
| I_{IB} | Input bias current | $V_{IC} = 0\text{ V}$, $V_O = 0\text{ V}$, $R_S = 50\ \Omega$ | $T_A = 25^\circ\text{C}$ | | 1 | 60 | pA | |
| | | | Full Range ⁽¹⁾ | | | 800 | | |
| V_{ICR} | Common-mode input voltage | $R_S = 50\ \Omega$; $ V_{IO} \leq 5\text{ mV}$ | $T_A = 25^\circ\text{C}$ | | -5.3 | 0 | 4 | V |
| | | | Full Range ⁽¹⁾ | | -5 | 0 | 3.5 | |
| V_{OM+} | Maximum positive peak output voltage | $I_O = -20\ \mu\text{A}$ | | | 4.99 | | V | |
| | | | $T_A = 25^\circ\text{C}$ | | 4.85 | 4.93 | | |
| | | | Full Range ⁽¹⁾ | | 4.85 | | | |
| | | | $T_A = 25^\circ\text{C}$ | | 4.25 | 4.65 | | |
| V_{OM-} | Maximum negative peak output voltage | $V_{IC} = 0\text{ V}$ | | | -4.99 | | V | |
| | | | $T_A = 25^\circ\text{C}$ | | -4.85 | -4.91 | | |
| | | | Full Range ⁽¹⁾ | | -4.85 | | | |
| | | | $T_A = 25^\circ\text{C}$ | | -3.5 | -4.1 | | |
| | | $I_O = 5\text{ mA}$ | | | -3.5 | | | |

6.6 Electrical Characteristics: $V_{DD\pm} = \pm 5\text{ V}$ (TLC2272-Q1 and TLC2272A-Q1) (continued)

at specified free-air temperature, $V_{DD\pm} = \pm 5\text{ V}$; $T_A = 25^\circ\text{C}$, unless otherwise noted.

| PARAMETER | | TEST CONDITIONS | | MIN | TYP | MAX | UNIT |
|-----------|--|---|---------------------------|---------------------------|-----------|-----|------------------------|
| A_{VD} | Large-signal differential voltage amplification | $V_O = \pm 4\text{ V}$ | $R_L = 10\text{ k}\Omega$ | $T_A = 25^\circ\text{C}$ | 20 | 50 | V/mV |
| | | | | Full Range ⁽¹⁾ | 20 | | |
| | | | $R_L = 1\text{ M}\Omega$ | | | 300 | |
| r_{id} | Differential input resistance | | | | 10^{12} | | Ω |
| r_i | Common-mode input resistance | | | | 10^{12} | | Ω |
| c_i | Common-mode input capacitance | $f = 10\text{ kHz}$, P package | | | 8 | | pF |
| Z_o | Closed-loop output impedance | $f = 1\text{ MHz}$, $A_V = 10$ | | | 130 | | Ω |
| CMRR | Common-mode rejection ratio | $V_{IC} = -5\text{ V to } 2.7\text{ V}$, $V_O = 0\text{ V}$, $R_S = 50\ \Omega$ | $T_A = 25^\circ\text{C}$ | 75 | 80 | | dB |
| | | | Full Range ⁽¹⁾ | 75 | | | |
| k_{SVR} | Supply-voltage rejection ratio ($\Delta V_{DD} / \Delta V_{IO}$) | $V_{DD+} = 2.2\text{ V to } \pm 8\text{ V}$, $V_{IC} = 0\text{ V}$, no load | $T_A = 25^\circ\text{C}$ | 80 | 95 | | dB |
| | | | Full Range ⁽¹⁾ | 80 | | | |
| I_{DD} | Supply current | $V_O = 0\text{ V}$, no load | $T_A = 25^\circ\text{C}$ | | 2.4 | 3 | mA |
| | | | Full Range ⁽¹⁾ | | | 3 | |
| SR | Slew rate at unity gain | $V_O = \pm 2.3\text{ V}$, $R_L = 10\text{ k}\Omega$, $C_L = 100\text{ pF}$ | $T_A = 25^\circ\text{C}$ | 2.3 | 3.6 | | V/ μs |
| | | | Full Range ⁽¹⁾ | 1.7 | | | |
| V_n | Equivalent input noise voltage | $f = 10\text{ Hz}$ | | | 50 | | nV/ $\sqrt{\text{Hz}}$ |
| | | $f = 1\text{ kHz}$ | | | 9 | | |
| V_{NPP} | Peak-to-peak equivalent input noise voltage | $f = 0.1\text{ Hz to } 1\text{ Hz}$ | | | 1 | | μV |
| | | $f = 0.1\text{ Hz to } 10\text{ Hz}$ | | | 1.4 | | |
| I_n | Equivalent input noise current | | | | 0.6 | | fA/ $\sqrt{\text{Hz}}$ |
| THD+N | Total harmonic distortion + noise | $V_O = \pm 2.3$, $f = 20\text{ kHz}$, $R_L = 10\text{ k}\Omega$ | $A_V = 1$ | | 0.0011% | | |
| | | | $A_V = 10$ | | 0.004% | | |
| | | | $A_V = 100$ | | 0.03% | | |
| | Gain-bandwidth product | $f = 10\text{ kHz}$, $R_L = 10\text{ k}\Omega$, $C_L = 100\text{ pF}$ | | | 2.25 | | MHz |
| B_{OM} | Maximum output-swing bandwidth | $V_{O(PP)} = 4.6\text{ V}$, $A_V = 1$, $R_L = 10\text{ k}\Omega$, $C_L = 100\text{ pF}$ | | | 0.54 | | MHz |
| t_s | Settling time | $A_V = -1$, $R_L = 10\text{ k}\Omega$, Step = $-2.3\text{ V to } 2.3\text{ V}$, $C_L = 100\text{ pF}$ | To 0.1% | | 1.5 | | μs |
| | | | To 0.01% | | 3.2 | | |
| Φ_m | Phase margin at unity gain | $R_L = 10\text{ k}\Omega$, $C_L = 100\text{ pF}$ | | | 52° | | |
| | Gain margin | $R_L = 10\text{ k}\Omega$, $C_L = 100\text{ pF}$ | | | 10 | | dB |

(1) $T_A = -40^\circ\text{C to } 125^\circ\text{C}$.

(2) Typical values are based on the input offset voltage shift observed through 168 hours of operating life test at $T_A = 150^\circ\text{C}$ extrapolated to $T_A = 25^\circ\text{C}$ using the Arrhenius equation and assuming an activation energy of 0.96 eV.

6.7 Electrical Characteristics: $V_{DD} = 5\text{ V}$ (TLC2274-Q1 and TLC2274A-Q1)

at specified free-air temperature, $V_{DD} = 5\text{ V}$; $T_A = 25^\circ\text{C}$, unless otherwise noted.

| PARAMETER | | TEST CONDITIONS | | MIN | TYP | MAX | UNIT |
|---------------------------|--|---|---------------------------------|---------------------------|-----------|------------------------|------------------------------|
| V_{IO} | Input offset voltage | $V_{IC} = 0\text{ V}$, $V_{DD\pm} = \pm 2.5\text{ V}$, $V_O = 0\text{ V}$, $R_S = 50\ \Omega$ | TLC2274-Q1 | $T_A = 25^\circ\text{C}$ | 300 | 2500 | μV |
| | | | TLC2274A-Q1 | | 300 | 950 | |
| | | | TLC2274-Q1 | Full Range ⁽¹⁾ | | 3000 | |
| | | | TLC2274A-Q1 | | 1500 | | |
| α_{VIO} | Temperature coefficient of input offset voltage | $V_{IC} = 0\text{ V}$, $V_{DD\pm} = \pm 2.5\text{ V}$, $V_O = 0\text{ V}$, $R_S = 50\ \Omega$ | | | 2 | | $\mu\text{V}/^\circ\text{C}$ |
| | Input offset voltage long-term drift ⁽²⁾ | $V_{IC} = 0\text{ V}$, $V_{DD\pm} = \pm 2.5\text{ V}$, $V_O = 0\text{ V}$, $R_S = 50\ \Omega$ | | | 0.002 | | $\mu\text{V}/\text{mo}$ |
| I_{IO} | Input offset current | $V_{IC} = 0\text{ V}$, $V_{DD\pm} = \pm 2.5\text{ V}$, $V_O = 0\text{ V}$, $R_S = 50\ \Omega$ | $T_A = 25^\circ\text{C}$ | 0.5 | 60 | pA | |
| | | | Full Range ⁽¹⁾ | | 800 | | |
| I_{IB} | Input bias current | $V_{IC} = 0\text{ V}$, $V_{DD\pm} = \pm 2.5\text{ V}$, $V_O = 0\text{ V}$, $R_S = 50\ \Omega$ | $T_A = 25^\circ\text{C}$ | 1 | 60 | pA | |
| | | | Full Range ⁽¹⁾ | | 800 | | |
| V_{ICR} | Common-mode input voltage | $R_S = 50\ \Omega$; $ V_{IO} \leq 5\text{ mV}$ | $T_A = 25^\circ\text{C}$ | -0.3 | 2.5 | 4 | V |
| | | | Full Range ⁽¹⁾ | 0 | 2.5 | 3.5 | |
| V_{OH} | High-level output voltage | $I_{OH} = -20\ \mu\text{A}$ $I_{OH} = -200\ \mu\text{A}$ $I_{OH} = -1\text{ mA}$ | $T_A = 25^\circ\text{C}$ | 4.99 | | | V |
| | | | Full Range ⁽¹⁾ | 4.85 | 4.93 | | |
| | | | $T_A = 25^\circ\text{C}$ | 4.25 | 4.65 | | |
| | | | Full Range ⁽¹⁾ | 4.25 | | | |
| V_{OL} | Low-level output voltage | $V_{IC} = 2.5\text{ V}$ | $I_{OL} = 50\ \mu\text{A}$ | | 0.01 | | V |
| | | | $I_{OL} = 500\ \mu\text{A}$ | $T_A = 25^\circ\text{C}$ | 0.09 | 0.15 | |
| | | | | Full Range ⁽¹⁾ | | 0.15 | |
| | | | $I_{OL} = 5\text{ mA}$ | $T_A = 25^\circ\text{C}$ | 0.9 | 1.5 | |
| Full Range ⁽¹⁾ | | 1.5 | | | | | |
| A_{VD} | Large-signal differential voltage amplification | $V_{IC} = 2.5\text{ V}$, $V_O = 1\text{ V to }4\text{ V}$ | $R_L = 10\text{ k}\Omega^{(3)}$ | $T_A = 25^\circ\text{C}$ | 10 | 35 | V/mV |
| | | | $R_L = 1\text{ M}\Omega^{(3)}$ | Full Range ⁽¹⁾ | 10 | | |
| | | | | | | 175 | |
| r_{id} | Differential input resistance | | | | 10^{12} | Ω | |
| r_i | Common-mode input resistance | | | | 10^{12} | Ω | |
| c_i | Common-mode input capacitance | $f = 10\text{ kHz}$, P package | | | 8 | pF | |
| z_o | Closed-loop output impedance | $f = 1\text{ MHz}$, $A_V = 10$ | | | 140 | Ω | |
| CMRR | Common-mode rejection ratio | $V_{IC} = 0\text{ V to }2.7\text{ V}$, $V_O = 2.5\text{ V}$, $R_S = 50\ \Omega$ | $T_A = 25^\circ\text{C}$ | 70 | 75 | dB | |
| | | | Full Range ⁽¹⁾ | 70 | | | |
| k_{SVR} | Supply-voltage rejection ratio ($\Delta V_{DD} / \Delta V_{IO}$) | $V_{DD} = 4.4\text{ V to }16\text{ V}$, $V_{IC} = V_{DD} / 2$, no load | $T_A = 25^\circ\text{C}$ | 80 | 95 | dB | |
| | | | Full Range ⁽¹⁾ | 80 | | | |
| I_{DD} | Supply current | $V_O = 2.5\text{ V}$, no load | $T_A = 25^\circ\text{C}$ | 4.4 | 6 | mA | |
| | | | Full Range ⁽¹⁾ | | 6 | | |
| SR | Slew rate at unity gain | $V_O = 0.5\text{ V to }2.5\text{ V}$, $R_L = 10\text{ k}\Omega^{(3)}$, $C_L = 100\text{ pF}^{(3)}$ | $T_A = 25^\circ\text{C}$ | 2.3 | 3.6 | V/ μs | |
| | | | Full Range ⁽¹⁾ | 1.7 | | | |
| V_n | Equivalent input noise voltage | $f = 10\text{ Hz}$ $f = 1\text{ kHz}$ | | 50 | | nV/ $\sqrt{\text{Hz}}$ | |
| | | | | 9 | | | |
| V_{NPP} | Peak-to-peak equivalent input noise voltage | $f = 0.1\text{ Hz to }1\text{ Hz}$ $f = 0.1\text{ Hz to }10\text{ Hz}$ | | 1 | | μV | |
| | | | | 1.4 | | | |
| I_n | Equivalent input noise current | | | 0.6 | | fA/ $\sqrt{\text{Hz}}$ | |
| THD+N | Total harmonic distortion + noise | $V_O = 0.5\text{ V to }2.5\text{ V}$, $f = 20\text{ kHz}$, $R_L = 10\text{ k}\Omega^{(3)}$ | $A_V = 1$ | 0.0013% | | | |
| | | | $A_V = 10$ | 0.004% | | | |
| | | | $A_V = 100$ | 0.03% | | | |
| | Gain-bandwidth product | $f = 10\text{ kHz}$, $R_L = 10\text{ k}\Omega^{(3)}$, $C_L = 100\text{ pF}^{(3)}$ | | | 2.18 | MHz | |
| B_{OM} | Maximum output-swing bandwidth | $V_{O(PP)} = 2\text{ V}$, $A_V = 1$, $R_L = 10\text{ k}\Omega^{(3)}$, $C_L = 100\text{ pF}^{(3)}$ | | | 1 | MHz | |

6.7 Electrical Characteristics: $V_{DD} = 5\text{ V}$ (TLC2274-Q1 and TLC2274A-Q1) (continued)

at specified free-air temperature, $V_{DD} = 5\text{ V}$; $T_A = 25^\circ\text{C}$, unless otherwise noted.

| PARAMETER | | TEST CONDITIONS | | MIN | TYP | MAX | UNIT |
|-----------|----------------------------|--|----------|-----|-----|-----|---------------|
| t_s | Settling time | $A_V = -1$, $R_L = 10\text{ k}\Omega^{(3)}$, Step = 0.5 V to 2.5 V, $C_L = 100\text{ pF}^{(3)}$ | To 0.1% | | 1.5 | | μs |
| | | | To 0.01% | | 2.6 | | |
| ϕ_m | Phase margin at unity gain | $R_L = 10\text{ k}\Omega^{(3)}$, $C_L = 100\text{ pF}^{(3)}$ | | | 50° | | |
| | Gain margin | $R_L = 10\text{ k}\Omega^{(3)}$, $C_L = 100\text{ pF}^{(3)}$ | | | 10 | | dB |

- $T_A = -40^\circ\text{C}$ to 125°C .
- Typical values are based on the input offset voltage shift observed through 168 hours of operating life test at $T_A = 150^\circ\text{C}$ extrapolated to $T_A = 25^\circ\text{C}$ using the Arrhenius equation and assuming an activation energy of 0.96 eV.
- Referenced to 0 V.

6.8 Electrical Characteristics: $V_{DD\pm} = \pm 5\text{ V}$ (TLC2274-Q1 and TLC2274A-Q1)

at specified free-air temperature, $V_{DD\pm} = \pm 5\text{ V}$; $T_A = 25^\circ\text{C}$, unless otherwise noted.

| PARAMETER | | TEST CONDITIONS | | MIN | TYP | MAX | UNIT | |
|---------------------------|--|--|---------------------------|---------------------------|-----------|-------|------------------------------|-------|
| V_{IO} | Input offset voltage | $V_{IC} = 0\text{ V}$, $V_O = 0\text{ V}$, $R_S = 50\ \Omega$ | TLC2274-Q1 | $T_A = 25^\circ\text{C}$ | 300 | 2500 | μV | |
| | | | TLC2274A-Q1 | | 300 | 950 | | |
| | | | TLC2274-Q1 | Full Range ⁽¹⁾ | | 3000 | | |
| | | | TLC2274A-Q1 | | | 1500 | | |
| α_{VIO} | Temperature coefficient of input offset voltage | $V_{IC} = 0\text{ V}$, $V_O = 0\text{ V}$, $R_S = 50\ \Omega$ | | | 2 | | $\mu\text{V}/^\circ\text{C}$ | |
| | Input offset voltage long-term drift ⁽²⁾ | $V_{IC} = 0\text{ V}$, $V_O = 0\text{ V}$, $R_S = 50\ \Omega$ | | | 0.002 | | $\mu\text{V}/\text{mo}$ | |
| I_{IO} | Input offset current | $V_{IC} = 0\text{ V}$, $V_O = 0\text{ V}$, $R_S = 50\ \Omega$ | $T_A = 25^\circ\text{C}$ | | 0.5 | 60 | pA | |
| | | | Full Range ⁽¹⁾ | | | 800 | | |
| I_{IB} | Input bias current | $V_{IC} = 0\text{ V}$, $V_O = 0\text{ V}$, $R_S = 50\ \Omega$ | $T_A = 25^\circ\text{C}$ | | 1 | 60 | pA | |
| | | | Full Range ⁽¹⁾ | | | 800 | | |
| V_{ICR} | Common-mode input voltage | $R_S = 50\ \Omega$; $ V_{IO} \leq 5\text{ mV}$ | $T_A = 25^\circ\text{C}$ | | -5.3 | 0 | 4 | V |
| | | | Full Range ⁽¹⁾ | | -5 | 0 | 3.5 | |
| V_{OM+} | Maximum positive peak output voltage | $I_O = -20\ \mu\text{A}$ | $T_A = 25^\circ\text{C}$ | | 4.85 | 4.93 | V | |
| | | | Full Range ⁽¹⁾ | | 4.85 | | | |
| | | | $T_A = 25^\circ\text{C}$ | | 4.25 | 4.65 | | |
| | | | Full Range ⁽¹⁾ | | 4.25 | | | |
| V_{OM-} | Maximum negative peak output voltage | $V_{IC} = 0\text{ V}$ | $I_O = 50\ \mu\text{A}$ | | | -4.99 | V | |
| | | | $I_O = 500\ \mu\text{A}$ | $T_A = 25^\circ\text{C}$ | | -4.85 | | -4.91 |
| | | | | Full Range ⁽¹⁾ | | -4.85 | | |
| | | | $I_O = 5\text{ mA}$ | $T_A = 25^\circ\text{C}$ | | -3.5 | | -4.1 |
| Full Range ⁽¹⁾ | | -3.5 | | | | | | |
| A_{VD} | Large-signal differential voltage amplification | $V_O = \pm 4\text{ V}$ | $R_L = 10\text{ k}\Omega$ | $T_A = 25^\circ\text{C}$ | 20 | 50 | V/mV | |
| | | | | Full Range ⁽¹⁾ | 20 | | | |
| | | | $R_L = 1\text{ M}\Omega$ | | 300 | | | |
| r_{id} | Differential input resistance | | | | 10^{12} | | Ω | |
| r_i | Common-mode input resistance | | | | 10^{12} | | Ω | |
| c_i | Common-mode input capacitance | $f = 10\text{ kHz}$, P package | | | 8 | | pF | |
| z_o | Closed-loop output impedance | $f = 1\text{ MHz}$, $A_V = 10$ | | | 130 | | Ω | |
| CMRR | Common-mode rejection ratio | $V_{IC} = -5\text{ V}$ to 2.7 V , $V_O = 0\text{ V}$, $R_S = 50\ \Omega$ | $T_A = 25^\circ\text{C}$ | | 75 | 80 | dB | |
| | | | Full Range ⁽¹⁾ | | 75 | | | |
| k_{SVR} | Supply-voltage rejection ratio ($\Delta V_{DD} / \Delta V_{IO}$) | $V_{DD+} = 2.2\text{ V}$ to $\pm 8\text{ V}$, $V_{IC} = 0\text{ V}$, no load | $T_A = 25^\circ\text{C}$ | | 80 | 95 | dB | |
| | | | Full Range ⁽¹⁾ | | 80 | | | |
| I_{DD} | Supply current | $V_O = 0\text{ V}$, no load | $T_A = 25^\circ\text{C}$ | | 4.8 | 6 | mA | |
| | | | Full Range ⁽¹⁾ | | | 6 | | |

6.8 Electrical Characteristics: $V_{DD\pm} = \pm 5\text{ V}$ (TLC2274-Q1 and TLC2274A-Q1) (continued)

at specified free-air temperature, $V_{DD\pm} = \pm 5\text{ V}$; $T_A = 25^\circ\text{C}$, unless otherwise noted.

| PARAMETER | | TEST CONDITIONS | | MIN | TYP | MAX | UNIT |
|-----------|---|--|-------------------------------------|-----|---------|-----|------------------------|
| SR | Slew rate at unity gain | $V_O = \pm 2.3\text{ V}$, $R_L = 10\text{ k}\Omega$, $C_L = 100\text{ pF}$ | $T_A = 25^\circ\text{C}$ | 2.3 | 3.6 | | V/ μs |
| | | | Full Range ⁽¹⁾ | 1.7 | | | |
| V_n | Equivalent input noise voltage | | $f = 10\text{ Hz}$ | | 50 | | nV/ $\sqrt{\text{Hz}}$ |
| | | | $f = 1\text{ kHz}$ | | 9 | | |
| V_{NPP} | Peak-to-peak equivalent input noise voltage | | $f = 0.1\text{ Hz to }1\text{ Hz}$ | | 1 | | μV |
| | | | $f = 0.1\text{ Hz to }10\text{ Hz}$ | | 1.4 | | |
| I_n | Equivalent input noise current | | | | 0.6 | | fA/ $\sqrt{\text{Hz}}$ |
| THD+N | Total harmonic distortion + noise | $V_O = \pm 2.3$, $f = 20\text{ kHz}$, $R_L = 10\text{ k}\Omega$ | $A_V = 1$ | | 0.0011% | | |
| | | | $A_V = 10$ | | 0.004% | | |
| | | | $A_V = 100$ | | 0.03% | | |
| | Gain-bandwidth product | $f = 10\text{ kHz}$, $R_L = 10\text{ k}\Omega$, $C_L = 100\text{ pF}$ | | | 2.25 | | MHz |
| B_{OM} | Maximum output-swing bandwidth | $V_{O(PP)} = 4.6\text{ V}$, $A_V = 1$, $R_L = 10\text{ k}\Omega$, $C_L = 100\text{ pF}$ | | | 0.54 | | MHz |
| t_s | Settling time | $A_V = -1$, $R_L = 10\text{ k}\Omega$, Step = $-2.3\text{ V to }2.3\text{ V}$, $C_L = 100\text{ pF}$ | To 0.1% | | 1.5 | | μs |
| | | | To 0.01% | | 3.2 | | |
| ϕ_m | Phase margin at unity gain | $R_L = 10\text{ k}\Omega$, $C_L = 100\text{ pF}$ | | | 52° | | |
| | Gain margin | $R_L = 10\text{ k}\Omega$, $C_L = 100\text{ pF}$ | | | 10 | | dB |

(1) $T_A = -40^\circ\text{C to }125^\circ\text{C}$.

(2) Typical values are based on the input offset voltage shift observed through 168 hours of operating life test at $T_A = 150^\circ\text{C}$ extrapolated to $T_A = 25^\circ\text{C}$ using the Arrhenius equation and assuming an activation energy of 0.96 eV.

6.9 Typical Characteristics

表 6-1. Table of Graphs

| | | | FIGURE ⁽¹⁾ |
|-------------------|--|-------------------------------|---------------------------------------|
| V_{IO} | Input offset voltage | Distribution | 1, 2, 3, 4 |
| | | vs Common-mode voltage | 5, 6 |
| α_{VIO} | Input offset voltage temperature coefficient | Distribution | 7, 8, 9, 10 ⁽²⁾ |
| I_{IB} / I_{IO} | Input bias and input offset current | vs Free-air temperature | 11 ⁽²⁾ |
| V_I | Input voltage | vs Supply voltage | 12 |
| | | vs Free-air temperature | 13 ⁽²⁾ |
| V_{OH} | High-level output voltage | vs High-level output current | 14 ⁽²⁾ |
| V_{OL} | Low-level output voltage | vs Low-level output current | 15, 16 ⁽²⁾ |
| V_{OM+} | Maximum positive peak output voltage | vs Output current | 17 ⁽²⁾ |
| V_{OM-} | Maximum negative peak output voltage | vs Output current | 18 ⁽²⁾ |
| $V_{O(PP)}$ | Maximum peak-to-peak output voltage | vs Frequency | 19 |
| I_{OS} | Short-circuit output current | vs Supply voltage | 20 |
| | | vs Free-air temperature | 21 ⁽²⁾ |
| V_O | Output voltage | vs Differential input voltage | 22, 23 |
| A_{VD} | Large-signal differential voltage amplification | vs Load resistance | 24 |
| | Large-signal differential voltage amplification and phase margin | vs Frequency | 25, 26 |
| | Large-signal differential voltage amplification | vs Free-air temperature | 27 ⁽²⁾ , 28 ⁽²⁾ |
| Z_0 | Output impedance | vs Frequency | 29, 30 |
| CMRR | Common-mode rejection ratio | vs Frequency | 31 |
| | | vs Free-air temperature | 32 |
| k_{SVR} | Supply-voltage rejection ratio | vs Frequency | 33, 34 |
| | | vs Free-air temperature | 35 ⁽²⁾ |
| I_{DD} | Supply current | vs Supply voltage | 36 ⁽²⁾ , 37 ⁽²⁾ |
| | | vs Free-air temperature | 38 ⁽²⁾ , 39 ⁽²⁾ |
| SR | Slew rate | vs Load Capacitance | 40 |
| | | vs Free-air temperature | 41 ⁽²⁾ |
| V_O | Inverting large-signal pulse response | | 42, 43 |
| | Voltage-follower large-signal pulse response | | 44, 45 |
| | Inverting small-signal pulse response | | 46, 47 |
| | Voltage-follower small-signal pulse response | | 48, 49 |
| V_n | Equivalent input noise voltage | vs Frequency | 50, 51 |
| | Noise voltage over a 10-second period | | 52 |
| | Integrated noise voltage | vs Frequency | 53 |
| THD+N | Total harmonic distortion + noise | vs Frequency | 54 |
| | Gain-bandwidth product | vs Supply voltage | 55 |
| | | vs Free-air temperature | 56 ⁽²⁾ |
| Φ_m | Phase margin | vs Load capacitance | 57 |
| | Gain margin | vs Load capacitance | 58 |

(1) For all graphs where $V_{DD} = 5\text{ V}$, all loads are referenced to 2.5 V.

(2) Data at high and low temperatures are applicable only within the rated operating free-air temperature ranges of the various devices.

6.9 Typical Characteristics (continued)

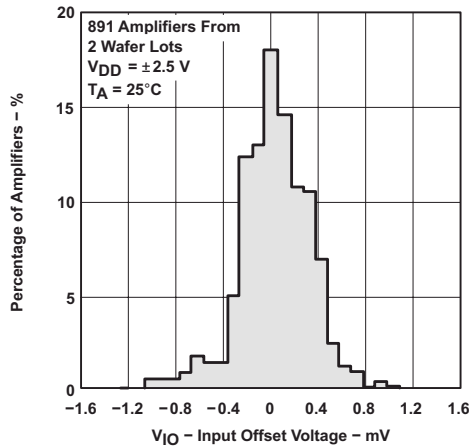

Fig 6-1. Distribution of TLC2272-Q1 Input Offset Voltage

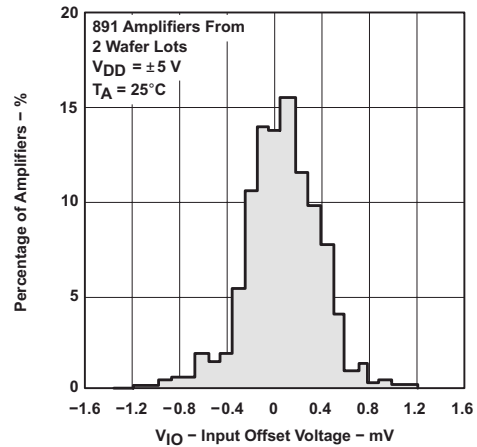

Fig 6-2. Distribution of TLC2272-Q1 Input Offset Voltage

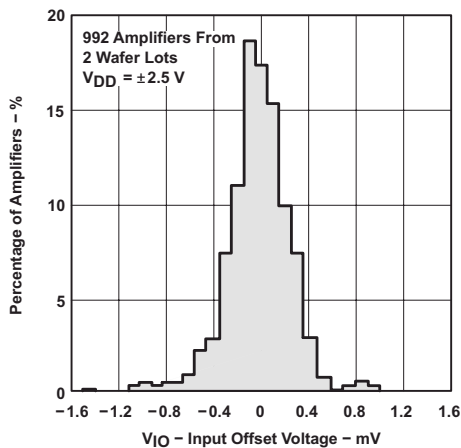

Fig 6-3. Distribution of TLC2274-Q1 Input Offset Voltage

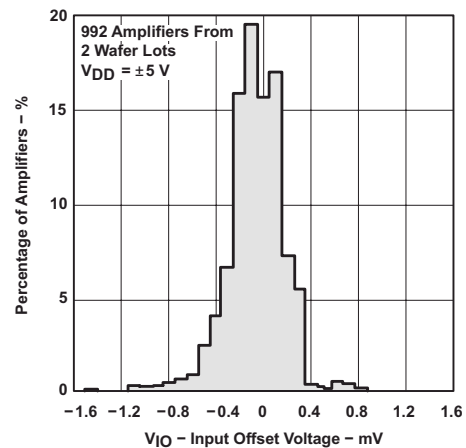

Fig 6-4. Distribution of TLC2274-Q1 Input Offset Voltage

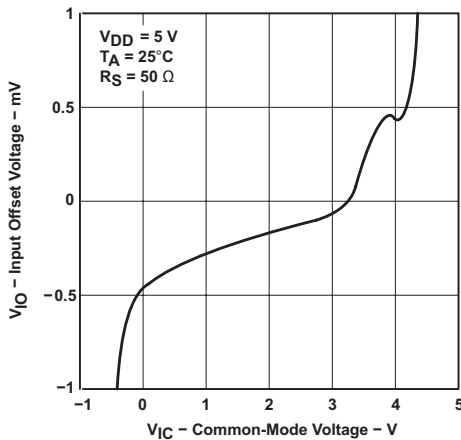

Fig 6-5. Input Offset Voltage vs Common-Mode Voltage

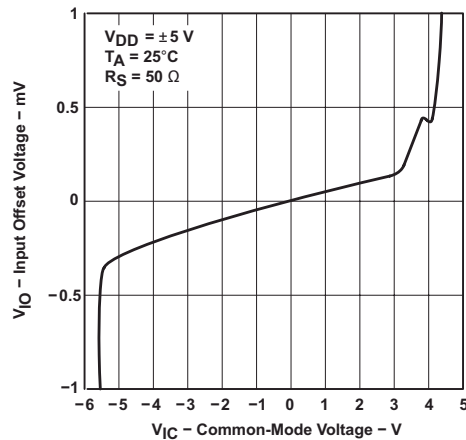
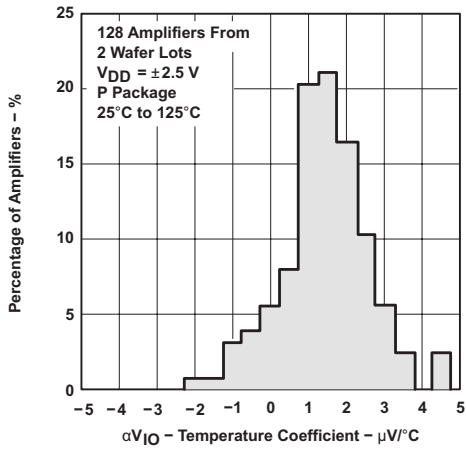

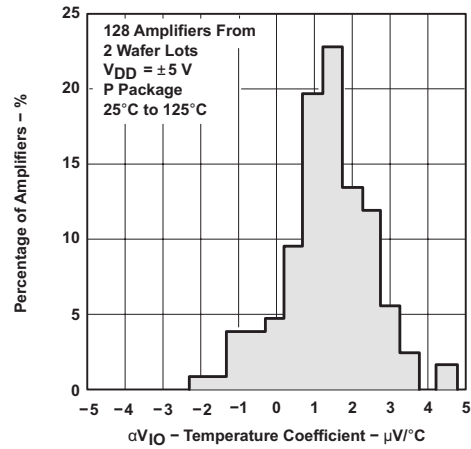



Fig 6-6. Input Offset Voltage vs Common-Mode Voltage

6.9 Typical Characteristics (continued)





6-7. Distribution of TLC2272-Q1 vs Input Offset Voltage Temperature Coefficient



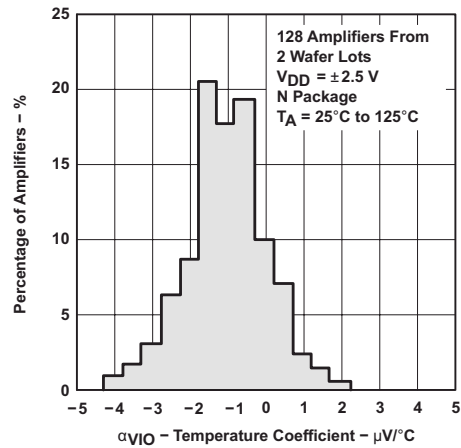

6-8. Distribution of TLC2272-Q1 vs Input Offset Voltage Temperature Coefficient

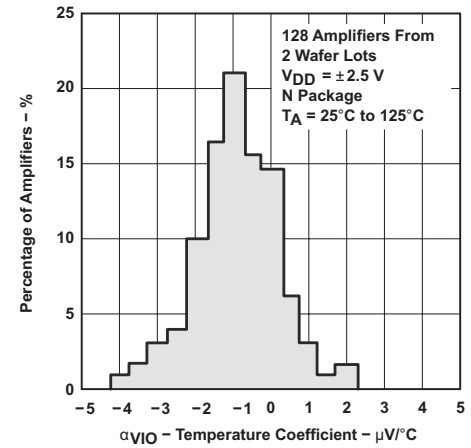



6-9. Distribution of TLC2274-Q1 vs Input Offset Voltage Temperature Coefficient

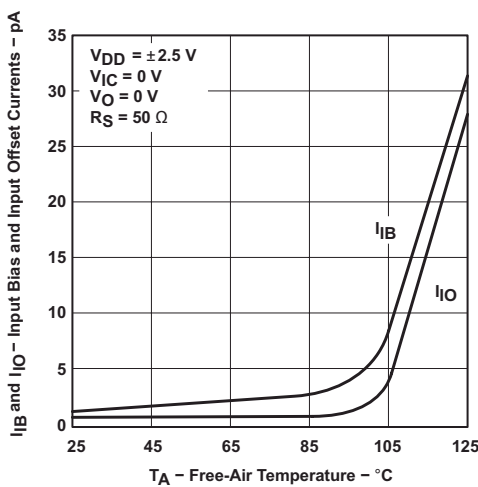

6-10. Distribution of TLC2274-Q1 vs Input Offset Voltage Temperature Coefficient



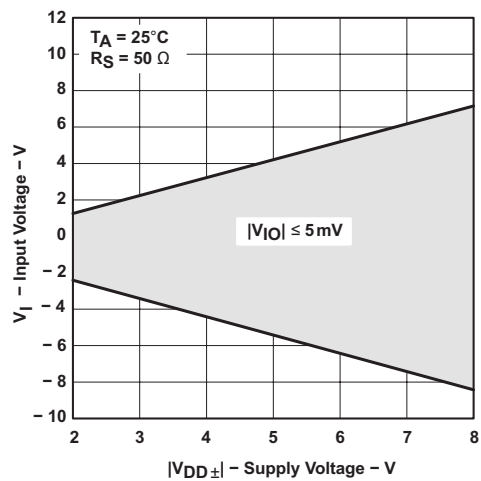

6-11. Input Bias and Input Offset Current vs Free-Air Temperature



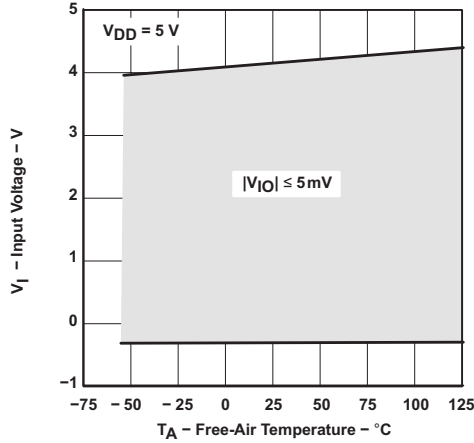

6-12. Input Voltage vs Supply Voltage

6.9 Typical Characteristics (continued)

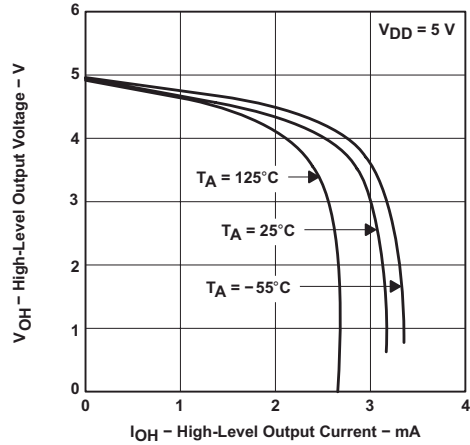

6-13. Input Voltage vs Free-Air Temperature



6-14. High-Level Output Voltage vs High-Level Output Current

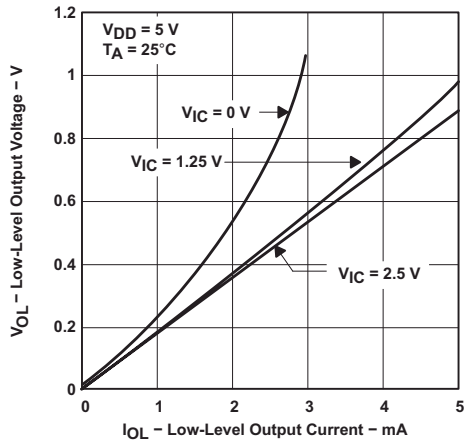

6-15. Low-Level Output Voltage vs Low-Level Output Current

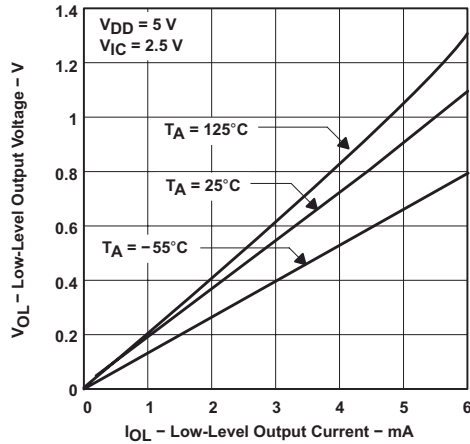

6-16. Low-Level Output Voltage vs Low-Level Output Current

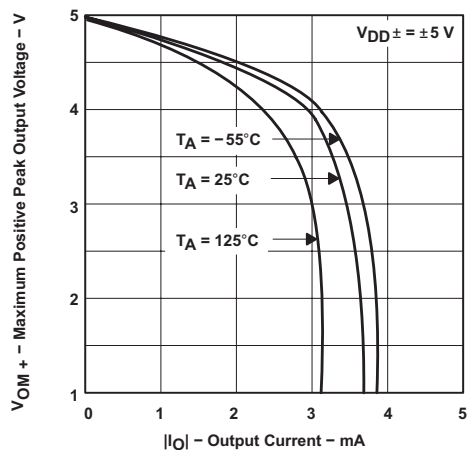

6-17. Maximum Positive Peak Output Voltage vs Output Current

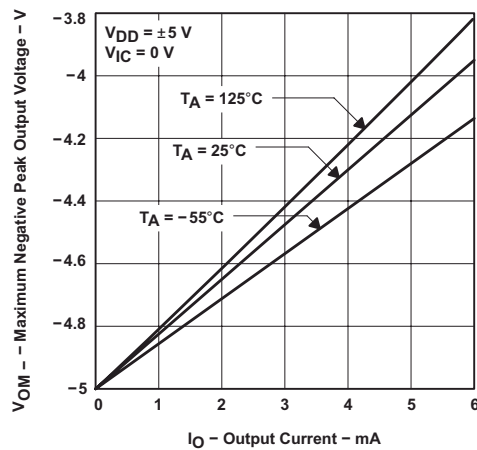

6-18. Maximum Positive Peak Output Voltage vs Output Current

6.9 Typical Characteristics (continued)

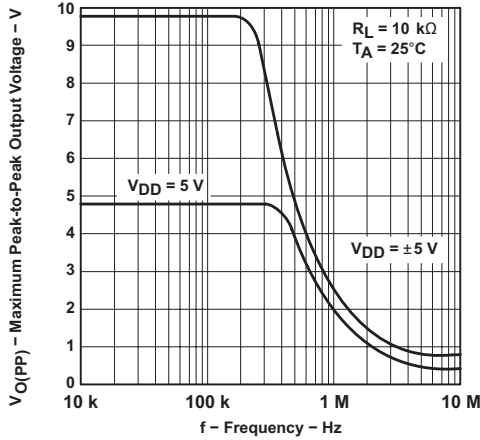

6-19. Maximum Peak-to-Peak Output Voltage vs Frequency

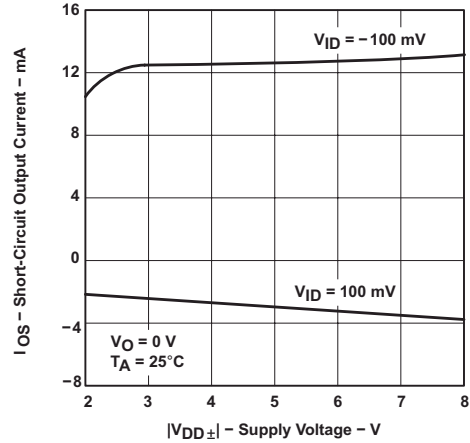

6-20. Short-Circuit Output Current vs Supply Voltage

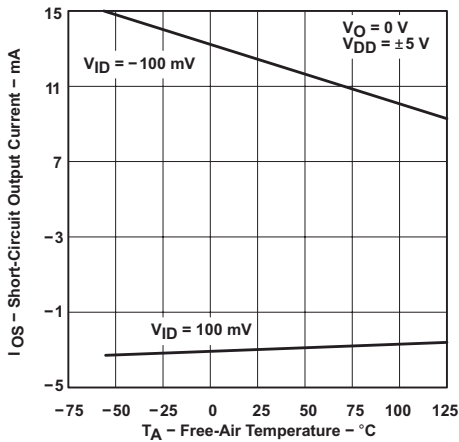

6-21. Short-Circuit Output Current vs Free-Air Temperature

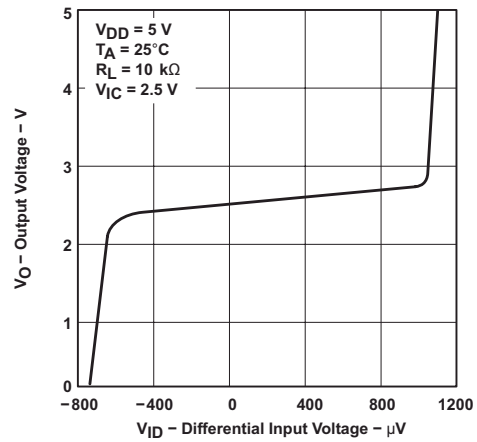

6-22. Output Voltage vs Differential Input Voltage

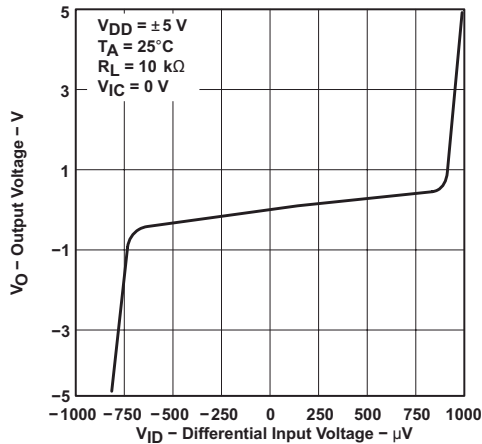

6-23. Output Voltage vs Differential Input Voltage

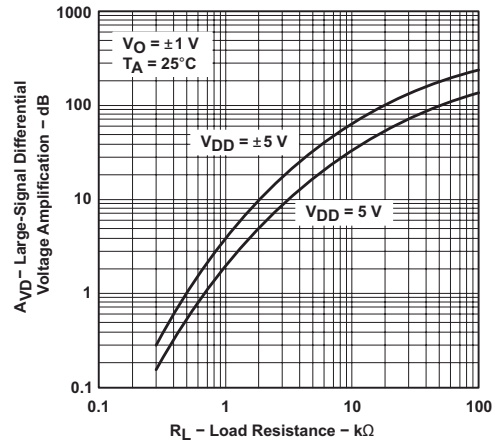

6-24. Large-Signal Differential Voltage Amplification vs Load Resistance

6.9 Typical Characteristics (continued)

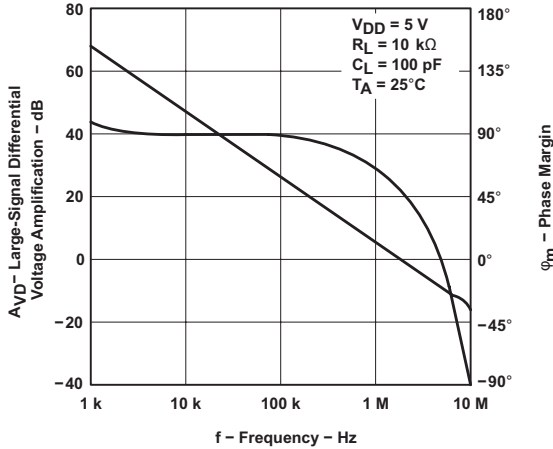

6-25. Large-Signal Differential Voltage Amplification and Phase Margin vs Frequency

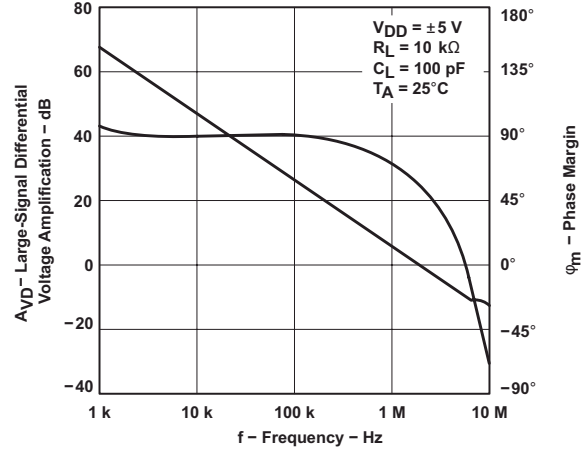

6-26. Large-Signal Differential Voltage Amplification and Phase Margin vs Frequency

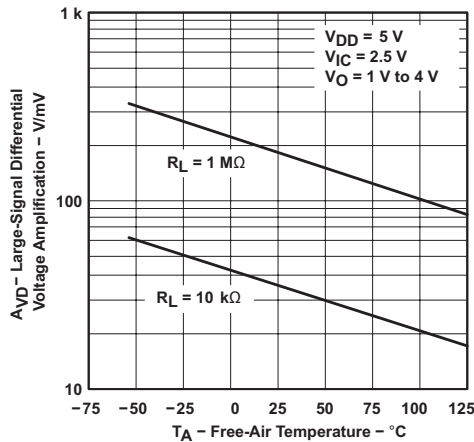

6-27. Large-Signal Differential Voltage Amplification vs Free-Air Temperature

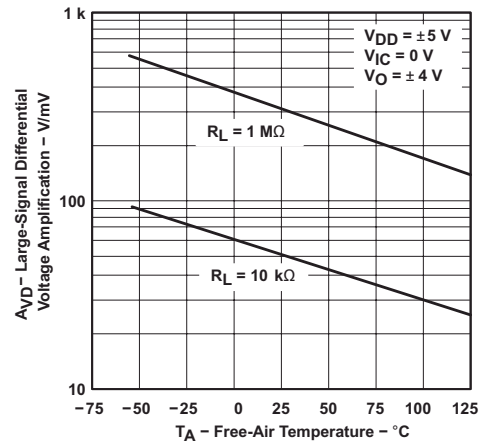

6-28. Large-Signal Differential Voltage Amplification vs Free-Air Temperature

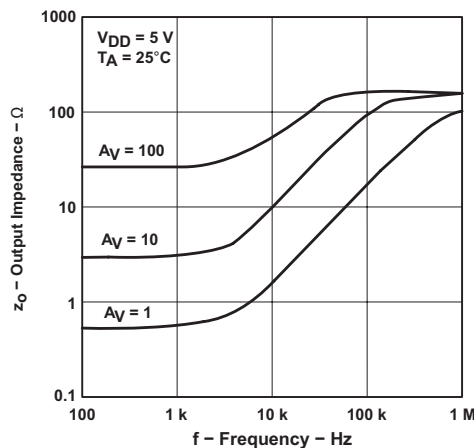

6-29. Output Impedance vs Frequency

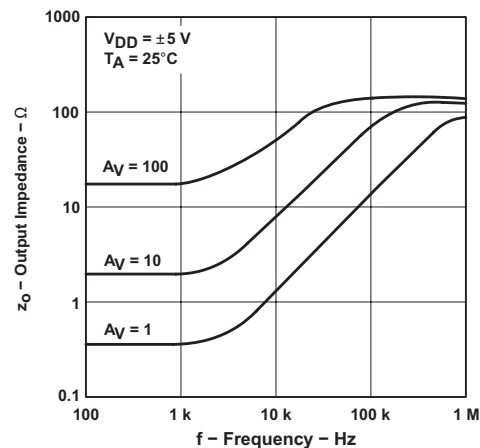

6-30. Output Impedance vs Frequency

6.9 Typical Characteristics (continued)

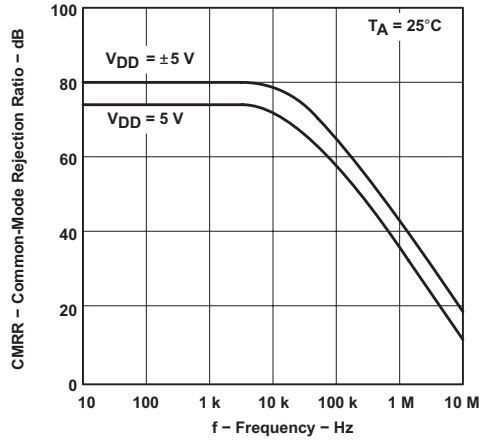

6-31. Common-Mode Rejection Ratio vs Frequency

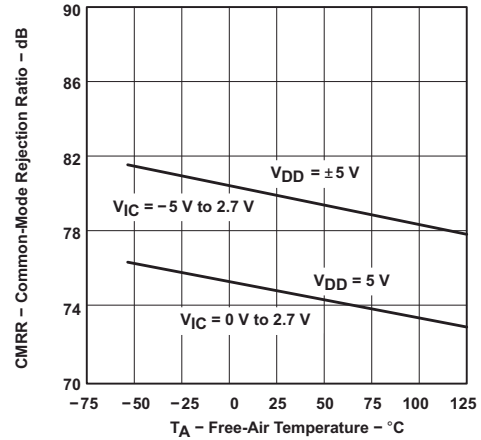

6-32. Common-Mode Rejection Ratio vs Free-Air Temperature

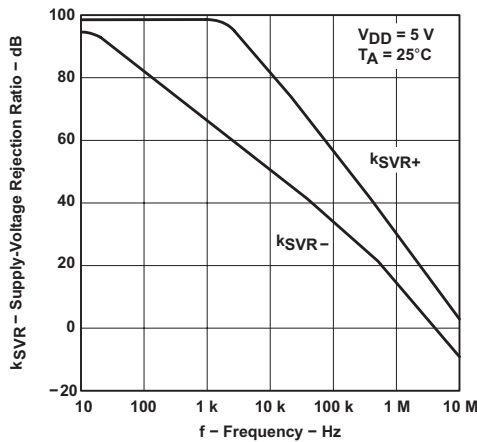

6-33. Supply-Voltage Rejection Ratio vs Frequency

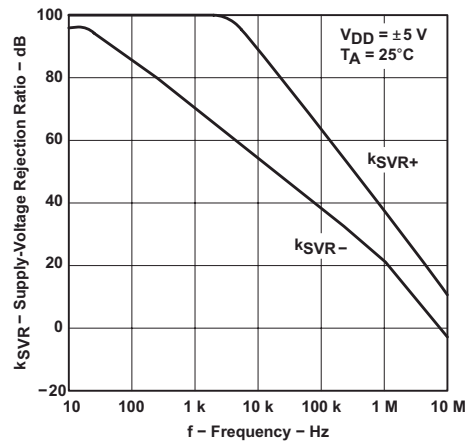

6-34. Supply-Voltage Rejection Ratio vs Frequency

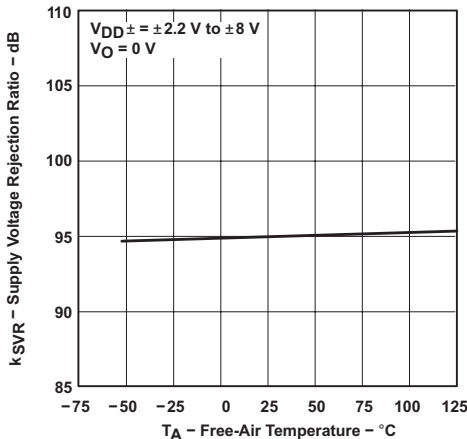

6-35. Supply-Voltage Rejection Ratio vs Free-Air Temperature

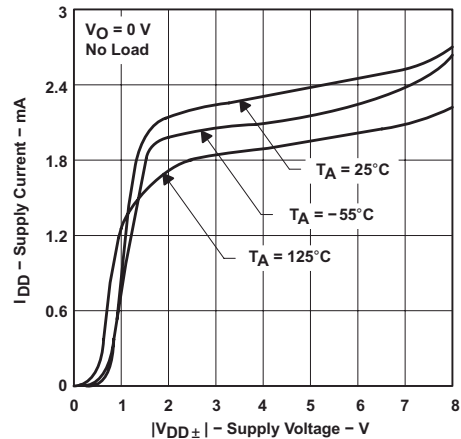

6-36. TLC2272-Q1 Supply Current vs Supply Voltage

6.9 Typical Characteristics (continued)

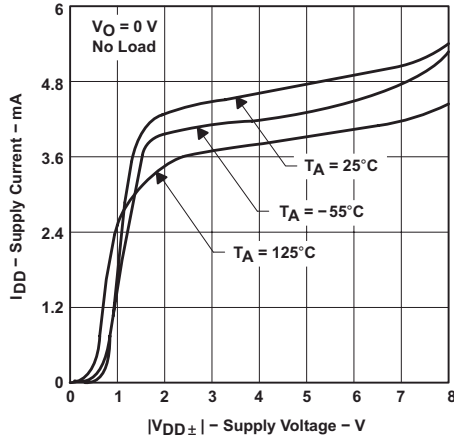

6-37. TLC2274-Q1 Supply Current vs Supply Voltage

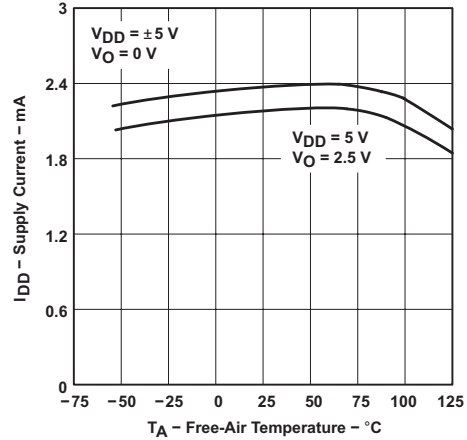

6-38. TLC2272-Q1 Supply Current vs Free-Air Temperature

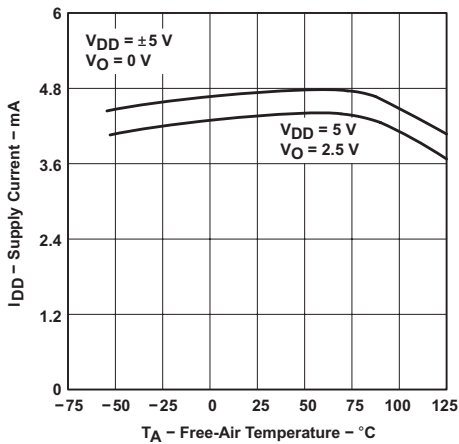

6-39. TLC2274-Q1 Supply Current vs Free-Air Temperature

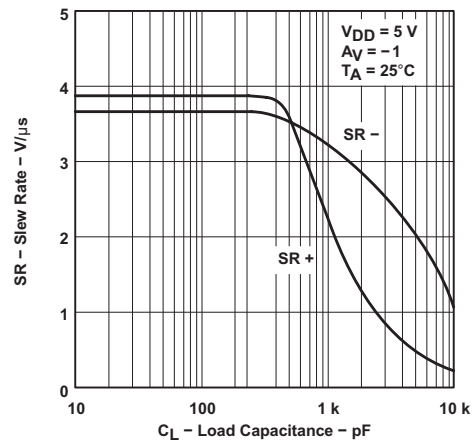

6-40. Slew Rate vs Load Capacitance

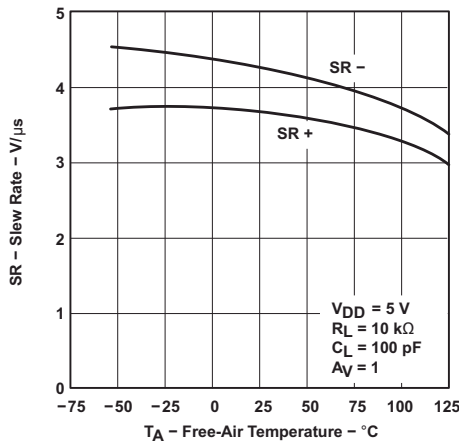

6-41. Slew Rate vs Free-Air Temperature

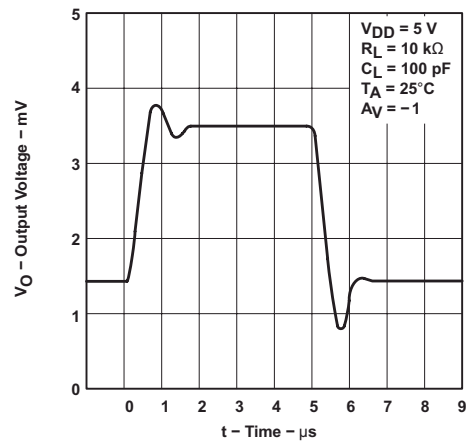

6-42. Inverting Large-Signal Pulse Response

6.9 Typical Characteristics (continued)

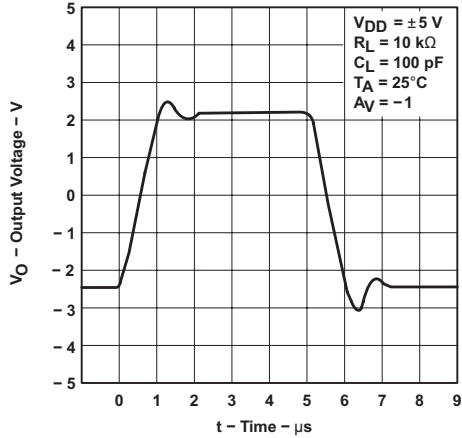

6-43. Inverting Large-Signal Pulse Response

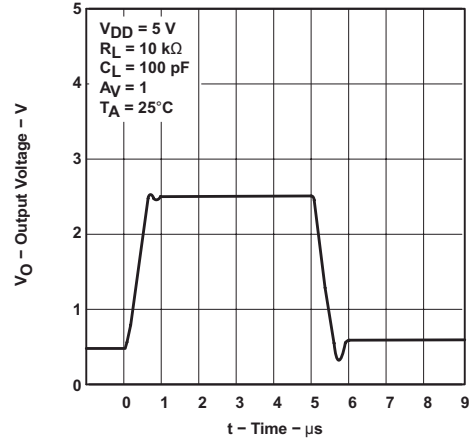

6-44. Voltage-Follower Large-Signal Pulse Response

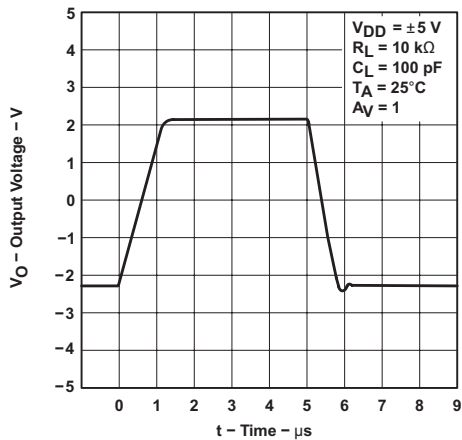

6-45. Voltage-Follower Large-Signal Pulse Response

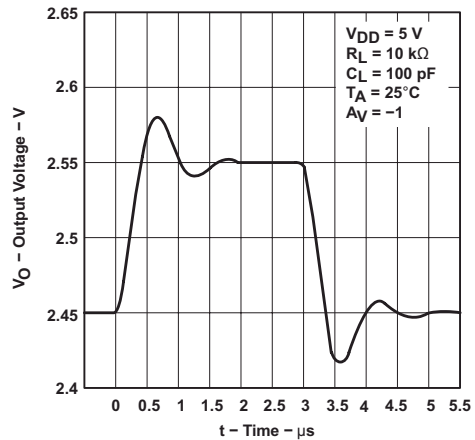

6-46. Inverting Small-Signal Pulse Response

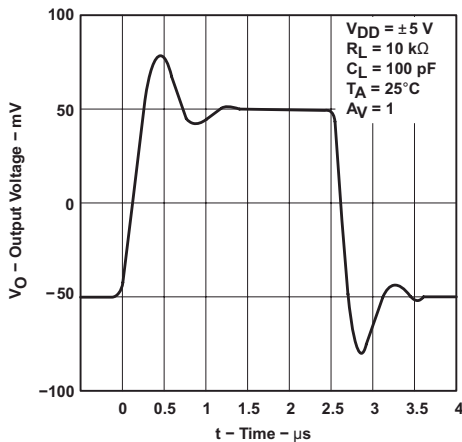

6-47. Inverting Small-Signal Pulse Response

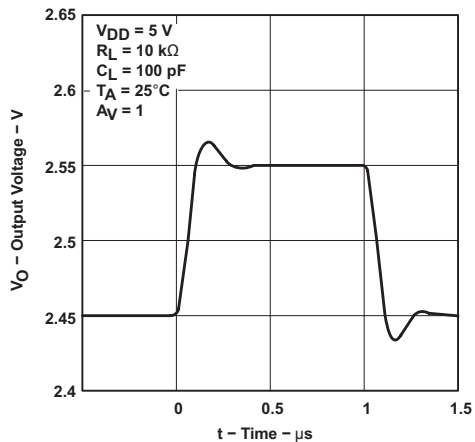

6-48. Voltage-Follower Small-Signal Pulse Response

6.9 Typical Characteristics (continued)

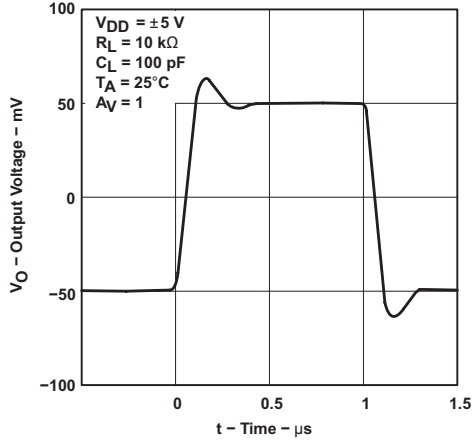

6-49. Voltage-Follower Small-Signal Pulse Response

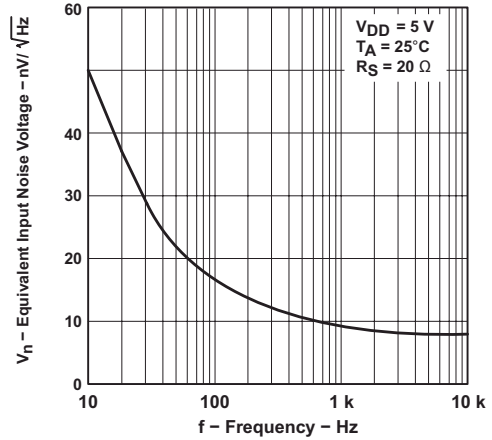

6-50. Equivalent Input Noise Voltage vs Frequency

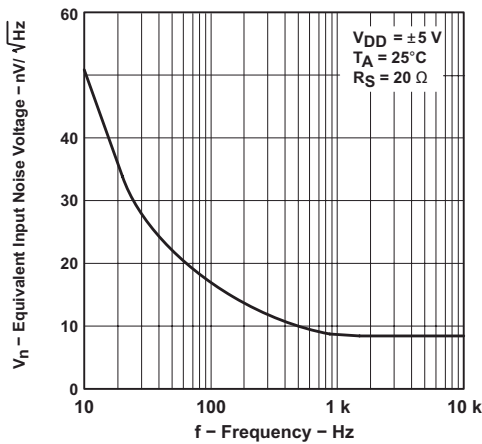

6-51. Equivalent Input Noise Voltage vs Frequency

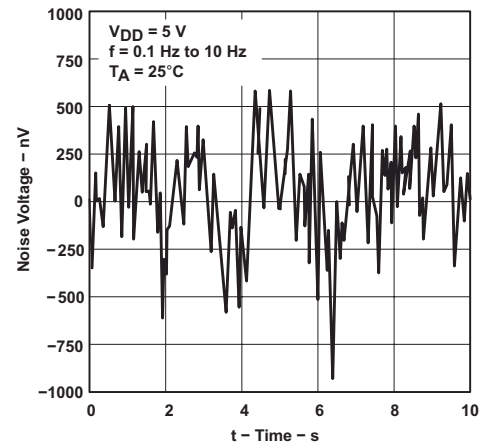

6-52. Noise Voltage Over a 10 Second Period

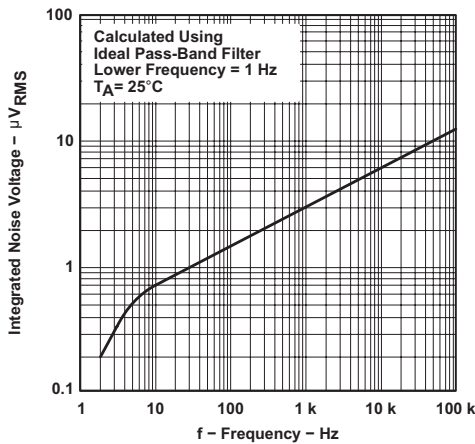

6-53. Integrated Noise Voltage vs Frequency

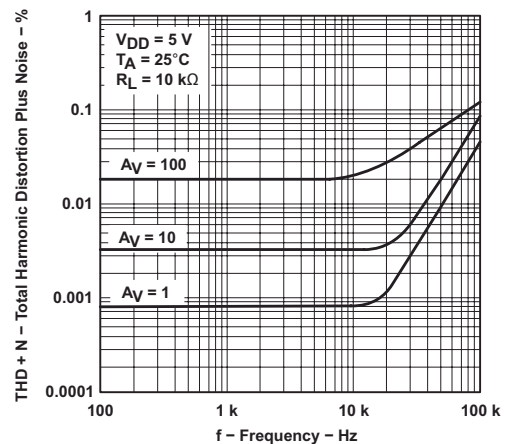

6-54. Total Harmonic Distortion + Noise vs Frequency

6.9 Typical Characteristics (continued)

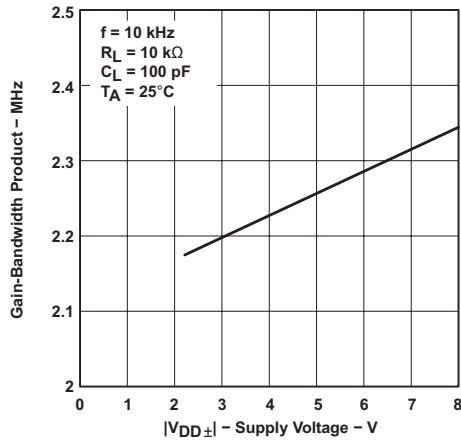

6-55. Gain-Bandwidth Product vs Supply Voltage

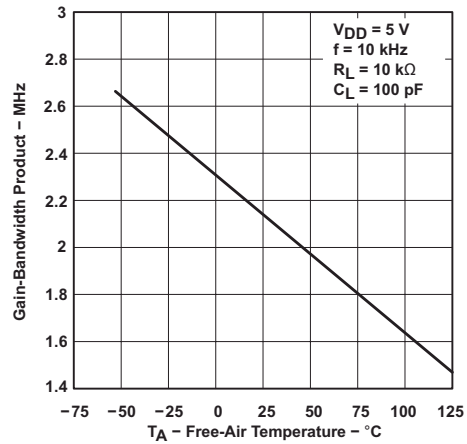

6-56. Gain-Bandwidth Product vs Free-Air Temperature

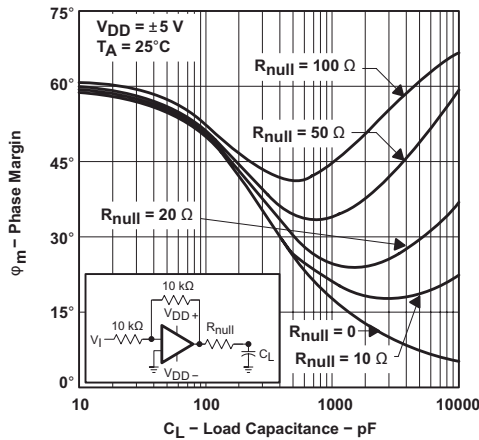

6-57. Phase Margin vs Load Capacitance

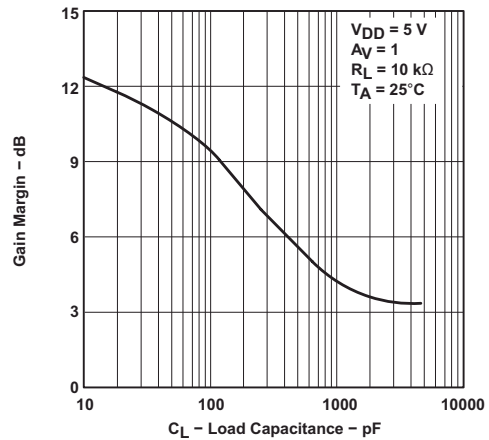

6-58. Gain Margin vs Load Capacitance

7 Detailed Description

7.1 Overview

The TLC227x-Q1 devices are a rail-to-rail output operational amplifiers. These devices operate from a 4.4-V to 16-V single supply and a $\pm 2.2\text{-V}$ $\pm 8\text{-V}$ dual supply, are unity-gain stable, and are an excellent choice for a wide range of general-purpose applications.

7.2 Functional Block Diagram



表 7-1. Actual Device Component Count⁽¹⁾

| COMPONENT | TLC2272-Q1 | TLC2274-Q1 |
|-------------|------------|------------|
| Transistors | 38 | 76 |
| Resistors | 26 | 52 |
| Diodes | 9 | 18 |
| Capacitors | 3 | 6 |

(1) Includes both amplifiers and all ESD, bias, and trim circuitry.

7.3 Feature Description

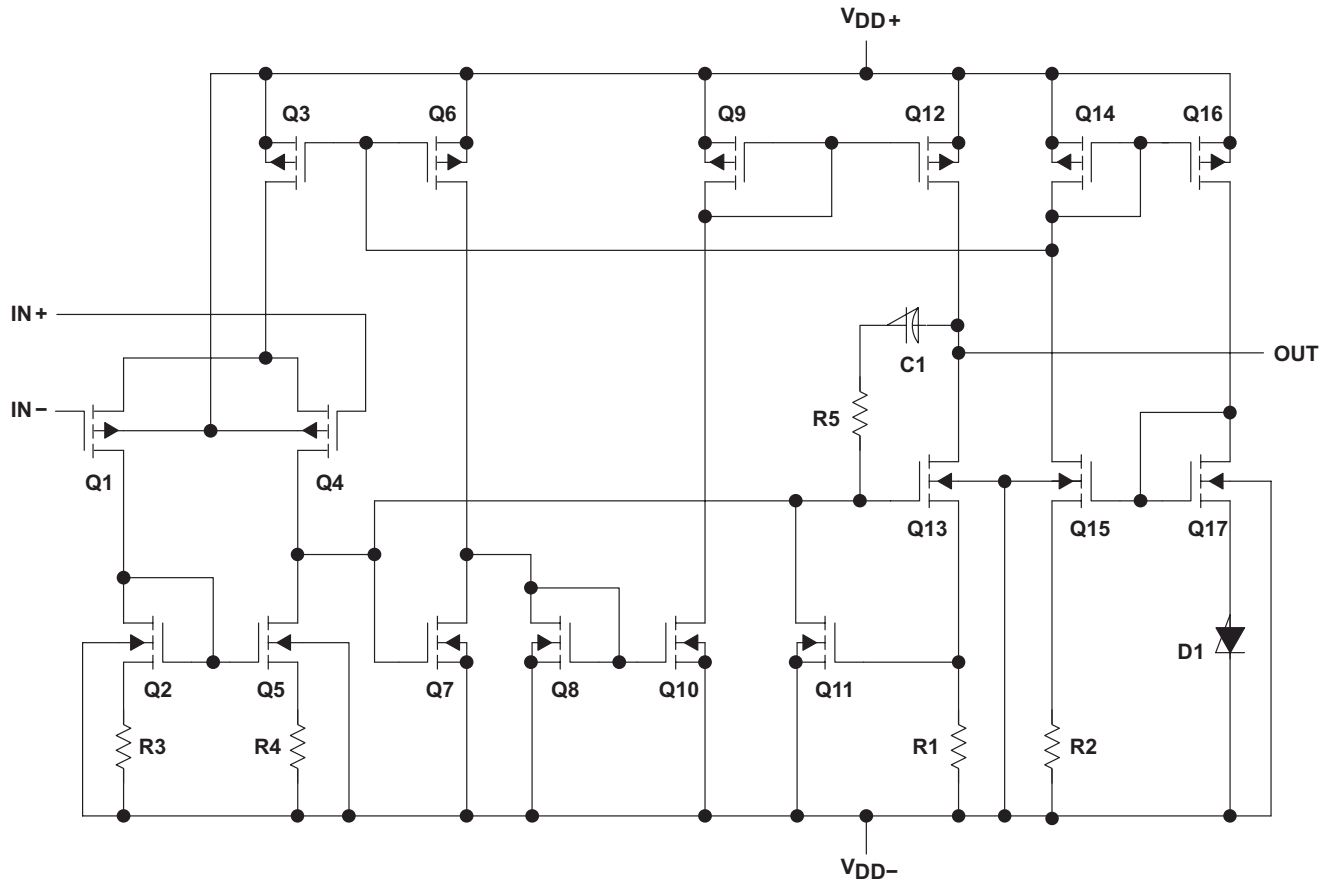
The TLC227x-Q1 family features 2-MHz bandwidth and voltage noise of $9\text{ nV}/\sqrt{\text{Hz}}$ with performance rated from 4.4 V to 16 V across an automotive temperature range (-40°C to $+125^{\circ}\text{C}$). LinMOS is a great choice for a wide range of audio, automotive, industrial, and instrumentation applications.

7.4 Device Functional Modes

The TLC227x-Q1 family of devices is powered on when the supply is connected. The device can operate with single or dual supply, depending on the application. The device is in full performance after the supply is greater than the recommended value.

8 Application and Implementation

注

以下のアプリケーション情報は、TI の製品仕様に含まれるものではなく、TI ではその正確性または完全性を保証いたしません。個々の目的に対する製品の適合性については、お客様の責任で判断していただくこととなります。お客様は自身の設計実装を検証しテストすることで、システムの機能を確認する必要があります。

8.1 Application Information

8.1.1 Macromodel Information

Macromodel information provided was derived using MicroSim Parts, the model generation software used with PSpice®. The Boyle macromodel (see also [セクション 9.2.1](#)) and subcircuit in [図 8-1](#) were generated using the TLC227x typical electrical and operating characteristics at $T_A = 25^\circ\text{C}$. Using this information, output simulations of the following key parameters can be generated to a tolerance of 20% (in most cases):

- Maximum positive output voltage swing
- Maximum negative output voltage swing
- Slew rate
- Quiescent power dissipation
- Input bias current
- Open-loop voltage amplification
- Unity gain frequency
- Common-mode rejection ratio
- Phase margin
- DC output resistance
- AC output resistance
- Short-circuit output current limit



図 8-1. Boyle Macromodels and Subcircuit

8.2 Typical Application

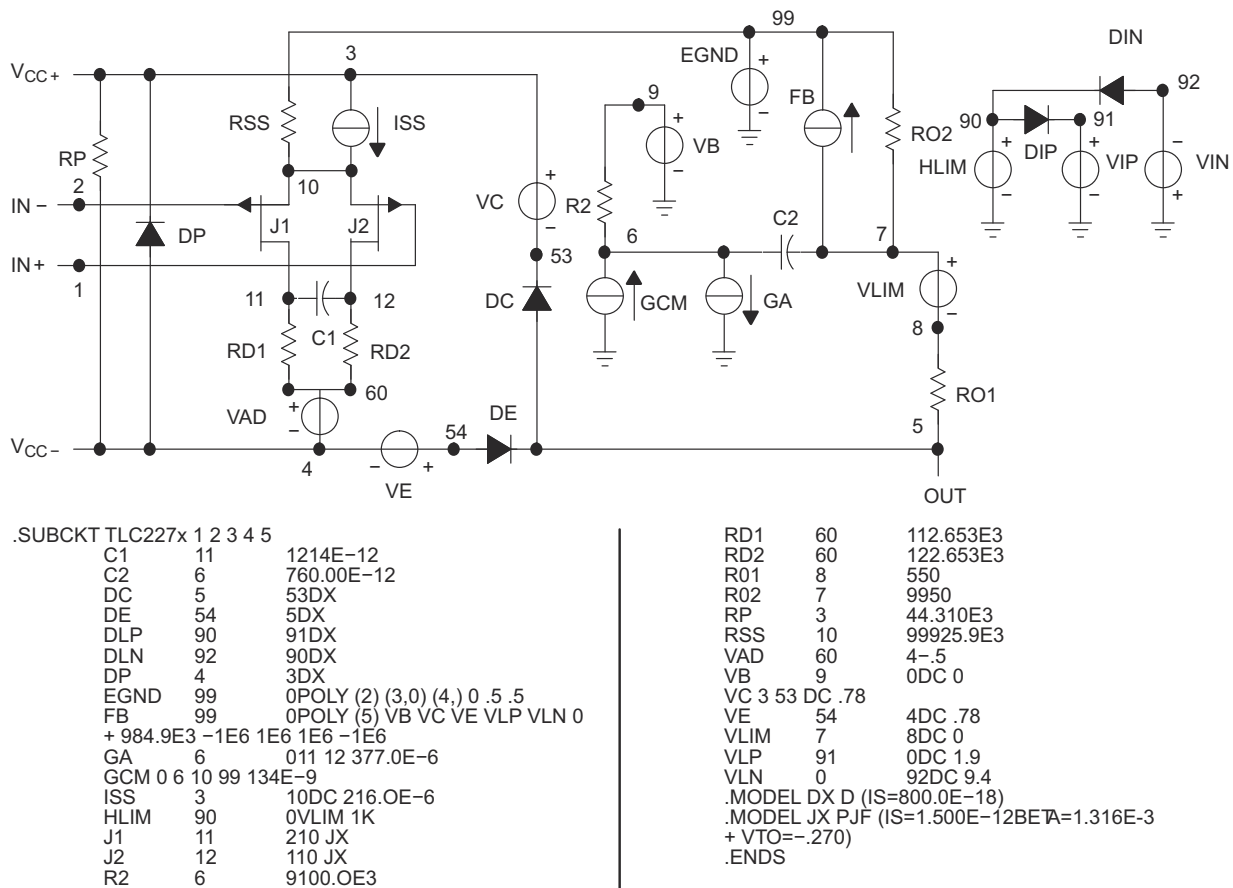

图 8-2. High-Side Current Monitor Equivalent Schematic (Each Amplifier)

8.2.1 Design Requirements

For this design example, use these parameters listed in 表 8-1 as the input parameters.

表 8-1. Design Parameters

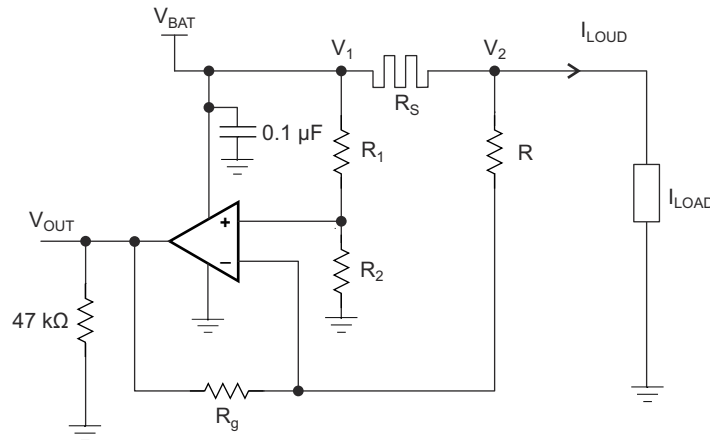
| PARAMETER | | VALUE |
|--------------------|-----------------------|--|
| V _{BAT} | Battery voltage | 12 V |
| R _{SENSE} | Sense resistor | 0.1 Ω |
| I _{LOAD} | Load current | 0 A to 10 A |
| | Operational amplifier | Set in differential configuration with gain = 10 |

8.2.2 Detailed Design Procedure

This circuit is designed for measuring the high-side current in automotive body control modules with a 12-V battery or similar applications. The operational amplifier is set as differential with an external resistor network.

8.2.2.1 Differential Amplifier Equations

式 1 和 式 2 are used to calculate V_{OUT}.

$$V_{OUT} = \frac{R_g}{R} \left(\frac{\frac{R}{R_g} - \frac{R_1}{R_2}}{1 + \frac{R_1}{R_2}} \times \frac{V_1 + V_2}{2} + \frac{1 + \frac{1}{2} \left(\frac{R_1}{R_2} + \frac{R}{R_g} \right)}{1 + \frac{R_1}{R_2}} (V_1 - V_2) \right) \quad (1)$$

$$V_{OUT} = \frac{R_g}{R} \left(\frac{\frac{R}{R_g} - \frac{R_1}{R_2}}{1 + \frac{R_1}{R_2}} \times V_{BAT} + \frac{1 + \frac{1}{2} \left(\frac{R_1}{R_2} + \frac{R}{R_g} \right)}{1 + \frac{R_1}{R_2}} \times R_S \times I_{LOAD} \right) \quad (2)$$

In an ideal case, 式 3 then calculates R₁ = R and R₂ = R_g, and V_{OUT}:

$$V_{OUT} = \frac{R_g}{R} \times R_S \times I_{LOAD} \quad (3)$$

However, the resistors have tolerances; therefore, the resistors cannot be perfectly matched.

$$R_1 = R \pm \Delta R_1$$

$$R_2 = R_2 \pm \Delta R_2$$

$$R = R \pm \Delta R$$

$$R_g = R_g \pm \Delta R_g$$

$$\text{Tol} = \frac{\Delta R}{R} \tag{4}$$

式 5 shows that by developing the equations and neglecting the second order, the worst case is when the tolerances add up:

$$V_{\text{OUT}} = \pm (4 \text{ Tol}) \frac{R_g}{R + R_g} \times V_{\text{BAT}} + \left(1 \pm 2 \text{ Tol} \left(1 + \frac{2R}{R + R_g} \right) \right) \frac{R_g}{R} \times R_S \times I_{\text{LOAD}} \tag{5}$$

where

- Tol = 0.01 for 1%
- Tol = 0.001 for 0.1%

If the resistors are perfectly matched, then Tol = 0 and 式 6 calculates V_{OUT} :

$$V_{\text{OUT}} = \frac{R_g}{R} \times R_S \times I_{\text{LOAD}} \tag{6}$$

The highest error is from the common mode:

$$4 (\text{Tol}) \frac{R_g}{R + R_g} \times V_{\text{BAT}} \tag{7}$$

Gain of 10, $R_g / R = 10$, and Tol = 1%:

$$\text{Common mode error} = ((4 \times 0.01) / 1.1) \times 12 \text{ V} = 0.436 \text{ V}$$

Gain of 10 and Tol = 0.1%:

$$\text{Common mode error} = 43.6 \text{ mV}$$

The resistors were chosen from 2% batches.

R_1 and R 12 k Ω

R_2 and R_g 120 k Ω

$$\text{Ideal Gain} = 120 / 12 = 10$$

The measured value of the resistors:

$$R_1 = 11.835 \text{ k}\Omega$$

$$R = 11.85 \text{ k}\Omega$$

$$R_2 = 117.92 \text{ k}\Omega$$

$$R_g = 118.07 \text{ k}\Omega$$

8.2.3 Application Curves

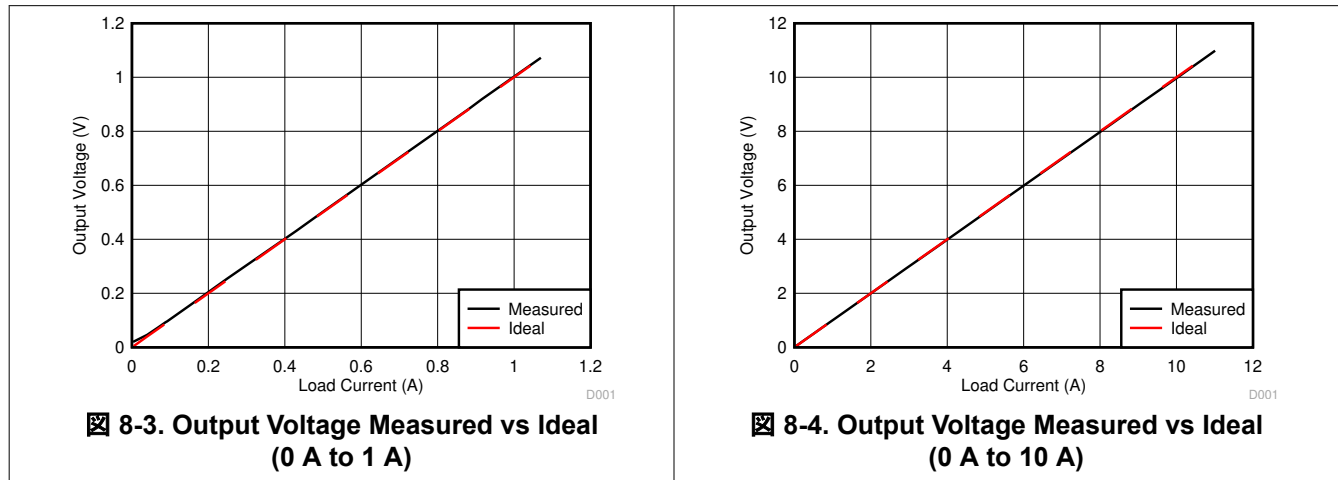

8.3 Power Supply Recommendations

Supply voltage is 4.4 V to 16 V for single supply and ± 2.2 V to ± 8 V for dual. In the high-side sensing application, the supply is connected to a 12-V battery.

8.4 Layout

8.4.1 Layout Guidelines

The TLC227x-Q1 is a wideband amplifier. To realize the full operational performance of the device, good high frequency printed-circuit-board (PCB) layout practices are required. Low-loss 0.1- μ F bypass capacitors must be connected between each supply pin and ground as close to the device as possible. The bypass capacitor traces must be designed for minimum inductance.

8.4.2 Layout Example

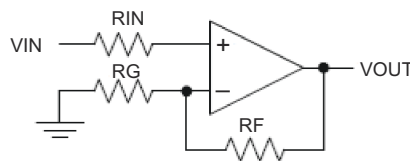
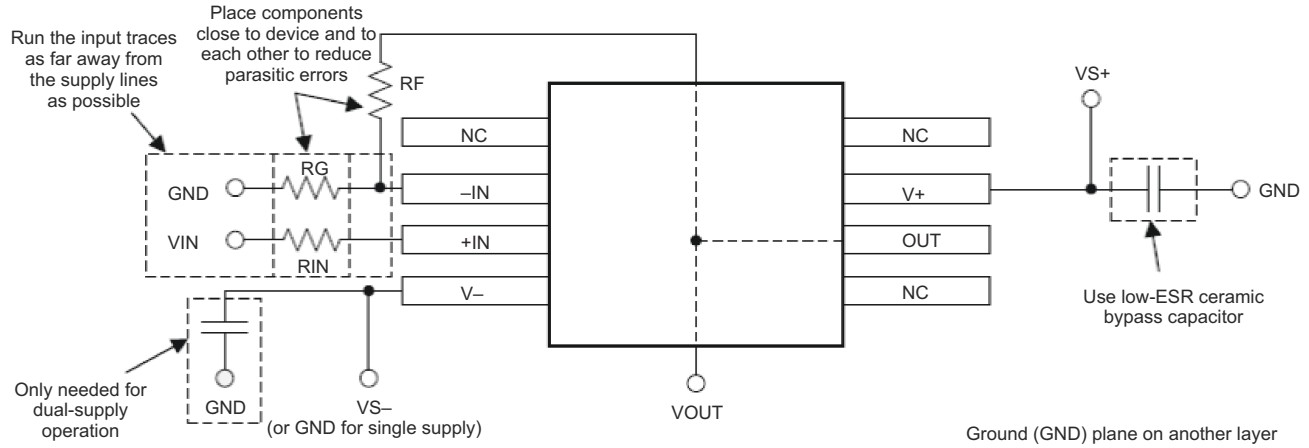

Figure 8-5. Schematic Representation



 **8-6. Operational Amplifier Board Layout for Noninverting Configuration**

9 Device and Documentation Support

9.1 Device Support

9.1.1 Development Support

9.1.1.1 PSpice® for TI

PSpice® for TI は、アナログ回路の性能評価に役立つ設計およびシミュレーション環境です。レイアウトと製造に移る前に、サブシステムの設計とプロトタイプ・ソリューションを作成することで、開発コストを削減し、市場投入までの期間を短縮できます。

9.1.1.2 TINA-TI™ Simulation Software (Free Download)

TINA-TI™ simulation software is a simple, powerful, and easy-to-use circuit simulation program based on a SPICE engine. TINA-TI simulation software is a free, fully-functional version of the TINA™ software, preloaded with a library of macromodels, in addition to a range of both passive and active models. TINA-TI simulation software provides all the conventional dc, transient, and frequency domain analysis of SPICE, as well as additional design capabilities.

Available as a [free download](#) from the [Design tools and simulation](#) web page, TINA-TI simulation software offers extensive post-processing capability that allows users to format results in a variety of ways. Virtual instruments offer the ability to select input waveforms and probe circuit nodes, voltages, and waveforms, creating a dynamic quick-start tool.

注

These files require that either the TINA software or TINA-TI software be installed. Download the free TINA-TI simulation software from the [TINA-TI™ software folder](#).

9.2 Documentation Support

9.2.1 Related Documentation

For related documentation see the following:

- G.R. Boyle, D.O. Pederson, B.M. Cohn, J.E. Solomon (Dec. 1974). *Macromodeling of Integrated Circuit Operational Amplifiers*. IEEE Journal of Solid-State Circuits, Volume 9, Issue 6, pages 353–364. Retrieved from <https://ieeexplore.ieee.org/document/1050528>

9.3 Receiving Notification of Documentation Updates

To receive notification of documentation updates, navigate to the device product folder on [ti.com](#). Click on *Subscribe to updates* to register and receive a weekly digest of any product information that has changed. For change details, review the revision history included in any revised document.

9.4 サポート・リソース

TI E2E™ サポート・フォーラムは、エンジニアが検証済みの回答と設計に関するヒントをエキスパートから迅速かつ直接得ることができる場所です。既存の回答を検索したり、独自の質問をしたりすることで、設計に必要な支援を迅速に得ることができます。

リンクされているコンテンツは、該当する貢献者により、現状のまま提供されるものです。これらは TI の仕様を構成するものではなく、必ずしも TI の見解を反映したものではありません。TI の[使用条件](#)を参照してください。

9.5 Trademarks

LinCMOS™, TINA-TI™, and TI E2E™ are trademarks of Texas Instruments.

TINA™ is a trademark of DesignSoft, Inc.

PSpice® is a registered trademark of Cadence Design Systems, Inc.

すべての商標は、それぞれの所有者に帰属します。

9.6 Electrostatic Discharge Caution



This integrated circuit can be damaged by ESD. Texas Instruments recommends that all integrated circuits be handled with appropriate precautions. Failure to observe proper handling and installation procedures can cause damage.

ESD damage can range from subtle performance degradation to complete device failure. Precision integrated circuits may be more susceptible to damage because very small parametric changes could cause the device not to meet its published specifications.

9.7 Glossary

[TI Glossary](#) This glossary lists and explains terms, acronyms, and definitions.

10 Mechanical, Packaging, and Orderable Information

The following pages include mechanical, packaging, and orderable information. This information is the most current data available for the designated devices. This data is subject to change without notice and revision of this document. For browser-based versions of this data sheet, refer to the left-hand navigation.

PACKAGING INFORMATION

| Orderable Device | Status (1) | Package Type | Package Drawing | Pins | Package Qty | Eco Plan (2) | Lead finish/ Ball material (6) | MSL Peak Temp (3) | Op Temp (°C) | Device Marking (4/5) | Samples |
|------------------|---------------|--------------|-----------------|------|-------------|-----------------|--------------------------------------|----------------------|--------------|-------------------------|-------------------------|
| TLC2272AQDRG4Q1 | ACTIVE | SOIC | D | 8 | 2500 | RoHS & Green | NIPDAU | Level-1-260C-UNLIM | -40 to 125 | 2272AQ | Samples |
| TLC2272AQDRQ1 | ACTIVE | SOIC | D | 8 | 2500 | RoHS & Green | NIPDAU | Level-1-260C-UNLIM | -40 to 125 | 2272AQ | Samples |
| TLC2272AQPWRG4Q1 | ACTIVE | TSSOP | PW | 8 | 2000 | RoHS & Green | NIPDAU | Level-1-260C-UNLIM | -40 to 125 | 2272AQ | Samples |
| TLC2272AQPWRQ1 | ACTIVE | TSSOP | PW | 8 | 2000 | RoHS & Green | NIPDAU | Level-1-260C-UNLIM | -40 to 125 | 2272AQ | Samples |
| TLC2272QDRG4Q1 | ACTIVE | SOIC | D | 8 | 2500 | RoHS & Green | NIPDAU | Level-1-260C-UNLIM | -40 to 125 | 2272Q1 | Samples |
| TLC2272QDRQ1 | ACTIVE | SOIC | D | 8 | 2500 | RoHS & Green | NIPDAU | Level-1-260C-UNLIM | -40 to 125 | 2272Q1 | Samples |
| TLC2272QPWRG4Q1 | ACTIVE | TSSOP | PW | 8 | 2000 | RoHS & Green | NIPDAU | Level-1-260C-UNLIM | -40 to 125 | 2272Q1 | Samples |
| TLC2272QPWRQ1 | ACTIVE | TSSOP | PW | 8 | 2000 | RoHS & Green | NIPDAU | Level-1-260C-UNLIM | -40 to 125 | 2272Q1 | Samples |
| TLC2274AQDRG4Q1 | ACTIVE | SOIC | D | 14 | 2500 | RoHS & Green | NIPDAU | Level-1-260C-UNLIM | -40 to 125 | 2274AQ1 | Samples |
| TLC2274AQDRQ1 | ACTIVE | SOIC | D | 14 | 2500 | RoHS & Green | NIPDAU | Level-1-260C-UNLIM | -40 to 125 | 2274AQ1 | Samples |
| TLC2274AQPWRG4Q1 | ACTIVE | TSSOP | PW | 14 | 2000 | RoHS & Green | NIPDAU | Level-1-260C-UNLIM | -40 to 125 | 2274AQ1 | Samples |
| TLC2274AQPWRQ1 | ACTIVE | TSSOP | PW | 14 | 2000 | RoHS & Green | NIPDAU | Level-1-260C-UNLIM | -40 to 125 | 2274AQ1 | Samples |
| TLC2274QPWRQ1 | ACTIVE | TSSOP | PW | 14 | 2000 | RoHS & Green | NIPDAU | Level-1-260C-UNLIM | -40 to 125 | 2274Q1 | Samples |

(1) The marketing status values are defined as follows:

ACTIVE: Product device recommended for new designs.

LIFEBUY: TI has announced that the device will be discontinued, and a lifetime-buy period is in effect.

NRND: Not recommended for new designs. Device is in production to support existing customers, but TI does not recommend using this part in a new design.

PREVIEW: Device has been announced but is not in production. Samples may or may not be available.

OBSELETE: TI has discontinued the production of the device.

(2) **RoHS:** TI defines "RoHS" to mean semiconductor products that are compliant with the current EU RoHS requirements for all 10 RoHS substances, including the requirement that RoHS substance do not exceed 0.1% by weight in homogeneous materials. Where designed to be soldered at high temperatures, "RoHS" products are suitable for use in specified lead-free processes. TI may reference these types of products as "Pb-Free".

RoHS Exempt: TI defines "RoHS Exempt" to mean products that contain lead but are compliant with EU RoHS pursuant to a specific EU RoHS exemption.

Green: TI defines "Green" to mean the content of Chlorine (Cl) and Bromine (Br) based flame retardants meet JS709B low halogen requirements of <=1000ppm threshold. Antimony trioxide based flame retardants must also meet the <=1000ppm threshold requirement.

(3) MSL, Peak Temp. - The Moisture Sensitivity Level rating according to the JEDEC industry standard classifications, and peak solder temperature.

(4) There may be additional marking, which relates to the logo, the lot trace code information, or the environmental category on the device.

(5) Multiple Device Markings will be inside parentheses. Only one Device Marking contained in parentheses and separated by a "~" will appear on a device. If a line is indented then it is a continuation of the previous line and the two combined represent the entire Device Marking for that device.

(6) Lead finish/Ball material - Orderable Devices may have multiple material finish options. Finish options are separated by a vertical ruled line. Lead finish/Ball material values may wrap to two lines if the finish value exceeds the maximum column width.

Important Information and Disclaimer:The information provided on this page represents TI's knowledge and belief as of the date that it is provided. TI bases its knowledge and belief on information provided by third parties, and makes no representation or warranty as to the accuracy of such information. Efforts are underway to better integrate information from third parties. TI has taken and continues to take reasonable steps to provide representative and accurate information but may not have conducted destructive testing or chemical analysis on incoming materials and chemicals. TI and TI suppliers consider certain information to be proprietary, and thus CAS numbers and other limited information may not be available for release.

In no event shall TI's liability arising out of such information exceed the total purchase price of the TI part(s) at issue in this document sold by TI to Customer on an annual basis.

OTHER QUALIFIED VERSIONS OF TLC2272-Q1, TLC2272A-Q1, TLC2274-Q1, TLC2274A-Q1 :

- Catalog : [TLC2272](#), [TLC2272A](#), [TLC2274](#), [TLC2274A](#)
- Enhanced Product : [TLC2272A-EP](#), [TLC2274-EP](#), [TLC2274A-EP](#)
- Military : [TLC2272M](#), [TLC2272AM](#), [TLC2274M](#), [TLC2274AM](#)

NOTE: Qualified Version Definitions:

- Catalog - TI's standard catalog product
- Enhanced Product - Supports Defense, Aerospace and Medical Applications
- Military - QML certified for Military and Defense Applications

TAPE AND REEL INFORMATION

QUADRANT ASSIGNMENTS FOR PIN 1 ORIENTATION IN TAPE

*All dimensions are nominal

| Device | Package Type | Package Drawing | Pins | SPQ | Reel Diameter (mm) | Reel Width W1 (mm) | A0 (mm) | B0 (mm) | K0 (mm) | P1 (mm) | W (mm) | Pin1 Quadrant |
|------------------|--------------|-----------------|------|------|--------------------|--------------------|---------|---------|---------|---------|--------|---------------|
| TLC2272AQPWRG4Q1 | TSSOP | PW | 8 | 2000 | 330.0 | 12.4 | 7.0 | 3.6 | 1.6 | 8.0 | 12.0 | Q1 |
| TLC2272AQPWRQ1 | TSSOP | PW | 8 | 2000 | 330.0 | 12.4 | 7.0 | 3.6 | 1.6 | 8.0 | 12.0 | Q1 |
| TLC2272QPWRG4Q1 | TSSOP | PW | 8 | 2000 | 330.0 | 12.4 | 7.0 | 3.6 | 1.6 | 8.0 | 12.0 | Q1 |
| TLC2272QPWRQ1 | TSSOP | PW | 8 | 2000 | 330.0 | 12.4 | 7.0 | 3.6 | 1.6 | 8.0 | 12.0 | Q1 |
| TLC2274AQPWRG4Q1 | TSSOP | PW | 14 | 2000 | 330.0 | 12.4 | 6.9 | 5.6 | 1.6 | 8.0 | 12.0 | Q1 |
| TLC2274AQPWRQ1 | TSSOP | PW | 14 | 2000 | 330.0 | 12.4 | 6.9 | 5.6 | 1.6 | 8.0 | 12.0 | Q1 |
| TLC2274QPWRQ1 | TSSOP | PW | 14 | 2000 | 330.0 | 12.4 | 6.9 | 5.6 | 1.6 | 8.0 | 12.0 | Q1 |

TAPE AND REEL BOX DIMENSIONS

*All dimensions are nominal

| Device | Package Type | Package Drawing | Pins | SPQ | Length (mm) | Width (mm) | Height (mm) |
|------------------|--------------|-----------------|------|------|-------------|------------|-------------|
| TLC2272AQPWRG4Q1 | TSSOP | PW | 8 | 2000 | 356.0 | 356.0 | 35.0 |
| TLC2272AQPWRQ1 | TSSOP | PW | 8 | 2000 | 356.0 | 356.0 | 35.0 |
| TLC2272QPWRG4Q1 | TSSOP | PW | 8 | 2000 | 356.0 | 356.0 | 35.0 |
| TLC2272QPWRQ1 | TSSOP | PW | 8 | 2000 | 356.0 | 356.0 | 35.0 |
| TLC2274AQPWRG4Q1 | TSSOP | PW | 14 | 2000 | 356.0 | 356.0 | 35.0 |
| TLC2274AQPWRQ1 | TSSOP | PW | 14 | 2000 | 356.0 | 356.0 | 35.0 |
| TLC2274QPWRQ1 | TSSOP | PW | 14 | 2000 | 356.0 | 356.0 | 35.0 |

D (R-PDSO-G14)

PLASTIC SMALL OUTLINE



- NOTES:
- A. All linear dimensions are in inches (millimeters).
 - B. This drawing is subject to change without notice.
 - $\triangle C$ Body length does not include mold flash, protrusions, or gate burrs. Mold flash, protrusions, or gate burrs shall not exceed 0.006 (0,15) each side.
 - $\triangle D$ Body width does not include interlead flash. Interlead flash shall not exceed 0.017 (0,43) each side.
 - E. Reference JEDEC MS-012 variation AB.

D (R-PDSO-G14)

PLASTIC SMALL OUTLINE



4211283-3/E 08/12

- NOTES:
- A. All linear dimensions are in millimeters.
 - B. This drawing is subject to change without notice.
 - C. Publication IPC-7351 is recommended for alternate designs.
 - D. Laser cutting apertures with trapezoidal walls and also rounding corners will offer better paste release. Customers should contact their board assembly site for stencil design recommendations. Refer to IPC-7525 for other stencil recommendations.
 - E. Customers should contact their board fabrication site for solder mask tolerances between and around signal pads.

PW (R-PDSO-G14)

PLASTIC SMALL OUTLINE



- NOTES:
- A. All linear dimensions are in millimeters. Dimensioning and tolerancing per ASME Y14.5M-1994.
 - B. This drawing is subject to change without notice.
 - C. Body length does not include mold flash, protrusions, or gate burrs. Mold flash, protrusions, or gate burrs shall not exceed 0,15 each side.
 - D. Body width does not include interlead flash. Interlead flash shall not exceed 0,25 each side.
 - E. Falls within JEDEC MO-153

PW (R-PDSO-G14)

PLASTIC SMALL OUTLINE



4211284-2/G 08/15

- NOTES:
- All linear dimensions are in millimeters.
 - This drawing is subject to change without notice.
 - Publication IPC-7351 is recommended for alternate designs.
 - Laser cutting apertures with trapezoidal walls and also rounding corners will offer better paste release. Customers should contact their board assembly site for stencil design recommendations. Refer to IPC-7525 for other stencil recommendations.
 - Customers should contact their board fabrication site for solder mask tolerances between and around signal pads.



D0008A

PACKAGE OUTLINE

SOIC - 1.75 mm max height

SMALL OUTLINE INTEGRATED CIRCUIT



4214825/C 02/2019

NOTES:

1. Linear dimensions are in inches [millimeters]. Dimensions in parenthesis are for reference only. Controlling dimensions are in inches. Dimensioning and tolerancing per ASME Y14.5M.
2. This drawing is subject to change without notice.
3. This dimension does not include mold flash, protrusions, or gate burrs. Mold flash, protrusions, or gate burrs shall not exceed $.006$ [0.15] per side.
4. This dimension does not include interlead flash.
5. Reference JEDEC registration MS-012, variation AA.

EXAMPLE BOARD LAYOUT

D0008A

SOIC - 1.75 mm max height

SMALL OUTLINE INTEGRATED CIRCUIT



LAND PATTERN EXAMPLE
 EXPOSED METAL SHOWN
 SCALE:8X



SOLDER MASK DETAILS

4214825/C 02/2019

NOTES: (continued)

- 6. Publication IPC-7351 may have alternate designs.
- 7. Solder mask tolerances between and around signal pads can vary based on board fabrication site.

EXAMPLE STENCIL DESIGN

D0008A

SOIC - 1.75 mm max height

SMALL OUTLINE INTEGRATED CIRCUIT



SOLDER PASTE EXAMPLE
BASED ON .005 INCH [0.125 MM] THICK STENCIL
SCALE:8X

4214825/C 02/2019

NOTES: (continued)

8. Laser cutting apertures with trapezoidal walls and rounded corners may offer better paste release. IPC-7525 may have alternate design recommendations.
9. Board assembly site may have different recommendations for stencil design.

EXAMPLE BOARD LAYOUT

PW0008A

TSSOP - 1.2 mm max height

SMALL OUTLINE PACKAGE



LAND PATTERN EXAMPLE
SCALE:10X



SOLDER MASK DETAILS
NOT TO SCALE

4221848/A 02/2015

NOTES: (continued)

- 6. Publication IPC-7351 may have alternate designs.
- 7. Solder mask tolerances between and around signal pads can vary based on board fabrication site.

EXAMPLE STENCIL DESIGN

PW0008A

TSSOP - 1.2 mm max height

SMALL OUTLINE PACKAGE



SOLDER PASTE EXAMPLE
BASED ON 0.125 mm THICK STENCIL
SCALE:10X

4221848/A 02/2015

NOTES: (continued)

8. Laser cutting apertures with trapezoidal walls and rounded corners may offer better paste release. IPC-7525 may have alternate design recommendations.
9. Board assembly site may have different recommendations for stencil design.

重要なお知らせと免責事項

TI は、技術データと信頼性データ(データシートを含みます)、設計リソース(リファレンス・デザインを含みます)、アプリケーションや設計に関する各種アドバイス、Web ツール、安全性情報、その他のリソースを、欠陥が存在する可能性のある「現状のまま」提供しており、商品性および特定目的に対する適合性の黙示保証、第三者の知的財産権の非侵害保証を含むいかなる保証も、明示的または黙示的にかかわらず拒否します。

これらのリソースは、TI 製品を使用する設計の経験を積んだ開発者への提供を意図したものです。(1) お客様のアプリケーションに適した TI 製品の選定、(2) お客様のアプリケーションの設計、検証、試験、(3) お客様のアプリケーションに該当する各種規格や、その他のあらゆる安全性、セキュリティ、規制、または他の要件への確実な適合に関する責任を、お客様のみが単独で負うものとし、

上記の各種リソースは、予告なく変更される可能性があります。これらのリソースは、リソースで説明されている TI 製品を使用するアプリケーションの開発の目的でのみ、TI はその使用をお客様に許諾します。これらのリソースに関して、他の目的で複製することや掲載することは禁止されています。TI や第三者の知的財産権のライセンスが付与されている訳ではありません。お客様は、これらのリソースを自身で使用した結果発生するあらゆる申し立て、損害、費用、損失、責任について、TI およびその代理人を完全に補償するものとし、TI は一切の責任を拒否します。

TI の製品は、[TI の販売条件](#)、または [ti.com](#) やかかる TI 製品の関連資料などのいずれかを通じて提供する適用可能な条項の下で提供されています。TI がこれらのリソースを提供することは、適用される TI の保証または他の保証の放棄の拡大や変更を意味するものではありません。

お客様がいかなる追加条項または代替条項を提案した場合でも、TI はそれらに異議を唱え、拒否します。

郵送先住所 : Texas Instruments, Post Office Box 655303, Dallas, Texas 75265
Copyright © 2024, Texas Instruments Incorporated