

TLV360x-Q1 伝搬遅延時間 2.5ns の 325MHz 高速コンパレータ

1 特長

- 車載アプリケーション認定済み
- 下記内容で AEC-Q100 認定済み:
 - デバイス温度グレード 1: -40°C ~ 125°C の動作時周囲温度範囲
 - デバイス HBM ESD 分類レベル 2
 - デバイス CDM ESD 分類レベル C3
- 小さい伝搬遅延時間: 2.5ns
- 小さいオーバードライブ分散: 600ps
- 高いトグル周波数: 325MHz
- 狭パルス幅検出機能: 1.25ns
- プッシュプル出力
- 広い電源電圧範囲: 2.4V ~ 5.5V
- 両方のレールから 200mV 拡張された入力同相モード範囲
- 低い入力オフセット電圧: $\pm 5\text{mV}$
- 既知の出力スタートアップ条件
- TLV3603 に特有の機能:
 - 可変ヒステリシス制御ピン
 - ラッチ機能
- パッケージ: TLV3601 (SC70-5)、(SOT23-5)、TLV3603 (SC70-6)、

TLV3602 (VSSOP-8)、(WSO8-8)

- 機能安全対応
 - 機能安全システムの設計に役立つ資料を利用可能 [TLV3601/2-Q1]
 - 機能安全システムの設計に役立つ資料を利用可能 [TLV3603-Q1]

2 アプリケーション

- DC/DC コンバータ
- インバータおよびモーター制御
- 燃料電池制御ユニット (FCCU)
- バッテリ管理システム (BMS)
- 機械式スキャン LIDAR
- オーディオ・アンプ

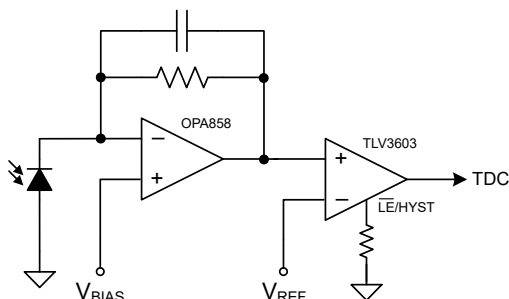

TLV3603 のアプリケーション回路

3 概要

TLV360x は、レール・ツー・レール入力伝搬遅延時間が 2.5ns の、325MHz 高速コンパレータのファミリーです。本コンパレータは、速い応答と広い動作電圧範囲を備えており、LIDAR、レンジ・ファインダー、ライン・レシーバの狭信号パルス検出およびデータ/クロック/リカバリ・アプリケーションに適しています。

TLV360x ファミリのプッシュプル (シングルエンド) 出力を使うと、他の高速差動出力コンパレータに比べて消費電力を低減できるとともに、I/O インターフェイスの基板間配線を簡素化し、コストを低減できます。これらのデバイスは、下流回路でよく使われるほとんどのデジタル・コントローラおよび IO エクスパンダと直接接続できます。

TLV3601-Q1 は小型の 5 ピン SC70 および SOT23 パッケージで供給されるため、コンパレータの高速応答時間を活用できる、スペースに制約のある機器に最適です。TLV3603-Q1 は 6 ピン SC70 パッケージで供給され、調整可能なヒステリシス制御と出力ラッチ機能という追加機能を備えていながら TLV3601-Q1 と同じ速度とサイズを維持しています。TLV3602-Q1 は TLV3601-Q1 のデュアル・チャンネル・バージョンで、8 ピンの VSSOP および WSON パッケージで供給されます。

製品情報

部品番号	パッケージ (1)	本体サイズ (公称)
TLV3601-Q1	SC70 (5)	1.25mm × 2.00mm
	SOT-23 (5)	2.90mm × 1.60mm
TLV3603-Q1	SC70 (6)	1.25mm × 2.00mm
TLV3602-Q1	VSSOP (8)	3.00mm × 3.00mm
	WSO8 (8) (プレビュー)	2.00mm × 2.00mm

- (1) 利用可能なパッケージについては、このデータシートの末尾にある注文情報を参照してください。

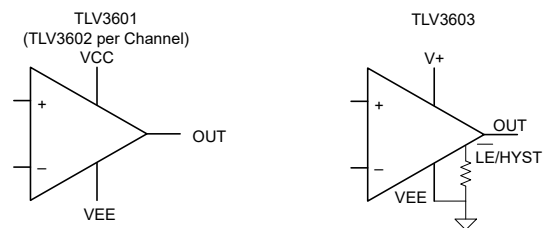

機能ブロック図



Table of Contents

1 特長	1	7.4 Device Functional Modes.....	18
2 アプリケーション	1	8 Application and Implementation	20
3 概要	1	8.1 Application Information.....	20
4 Revision History	2	8.2 Typical Application.....	21
5 Pin Configuration and Functions	3	9 Power Supply Recommendations	25
6 Specifications	5	10 Layout	26
6.1 Absolute Maximum Ratings.....	5	10.1 Layout Guidelines.....	26
6.2 ESD Ratings.....	5	10.2 Layout Example.....	26
6.3 Recommended Operating Conditions.....	5	11 Device and Documentation Support	27
6.4 Thermal Information.....	6	11.1 Device Support.....	27
6.5 Electrical Characteristics.....	7	11.2 Receiving Notification of Documentation Updates..	27
6.6 Timing Diagrams.....	8	11.3 サポート・リソース.....	27
6.7 Typical Characteristics.....	10	11.4 Trademarks.....	27
7 Detailed Description	18	11.5 Electrostatic Discharge Caution.....	27
7.1 Overview.....	18	11.6 Glossary.....	27
7.2 Functional Block Diagram.....	18	12 Mechanical, Packaging, and Orderable Information	27
7.3 Feature Description.....	18		

4 Revision History

資料番号末尾の英字は改訂を表しています。その改訂履歴は英語版に準じています。

Changes from Revision C (July 2022) to Revision D (August 2022) Page

- TLV3602-Q1 の VSSOP パッケージからプレビューを削除..... 1

Changes from Revision B (November 2021) to Revision C (July 2022) Page

- TLV3602-Q1 のプレビュー版に VSSOP および WSON パッケージ・オプションを追加..... 1
- TLV3601-Q1 の SOT-23 パッケージからプレビューを削除..... 1

Changes from Revision A (August 2021) to Revision B (November 2021) Page

- TLV3603-Q1 からプレビューを削除..... 1
- プレビューの TLV3601-Q1 に DBV パッケージ・オプションを追加..... 1
- Added typical performance curves..... 10

Changes from Revision * (June 2021) to Revision A (August 2021) Page

- 量産データのリリース..... 1

5 Pin Configuration and Functions

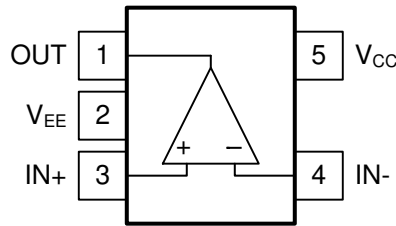

**图 5-1. DCK, DBV Package
5-Pin SC70, SOT-23
Top View**

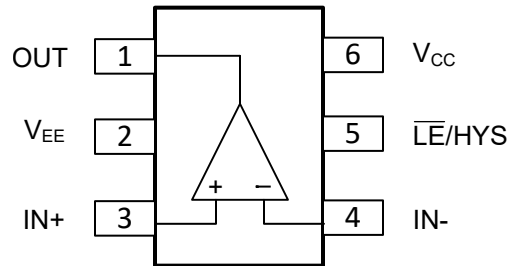

**图 5-2. DCK Package
6-Pin SC70
Top View**

表 5-1. Pin Functions

NAME	PIN		I/O	DESCRIPTION
	TLV3601	TLV3603		
IN+	3	3	I	Non-inverting input
IN-	4	4	I	Inverting input
OUT	1	1	O	Output (Push-pull)
V _{EE}	2	2	I	Negative power supply
V _{CC}	5	6	I	Positive power supply
LE/HYS	-	5	I	Adjustable hysteresis control and latch

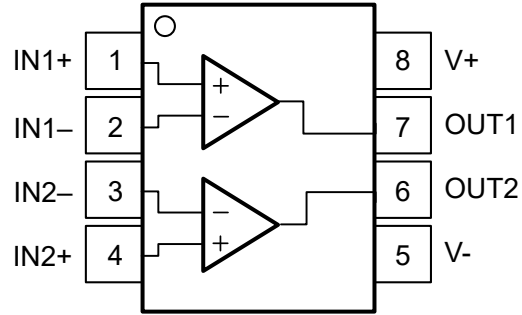

**图 5-3. TLV3602 DGK, DSG Packages
8-Pin VSSOP, WSON**

表 5-2. Pin Functions: TLV3602 (Dual)

PIN		I/O	DESCRIPTION
NAME	NO.		
IN1+	1	I	Noninverting input, channel 1
IN1-	2	I	Inverting input, channel 1
IN2-	3	I	Inverting input, channel 2
IN2+	4	I	Noninverting input, channel 2
OUT1	7	O	Output, channel 1
OUT2	6	O	Output, channel 2
V-	5	P	Negative (lowest) supply or ground
V+	8	P	Positive (highest) supply
Thermal PAD		-	Connect directly to V- pin

6 Specifications

6.1 Absolute Maximum Ratings

over operating free-air temperature range (unless otherwise noted)⁽¹⁾

	MIN	MAX	UNIT
Input Supply Voltage: $V_{CC} - V_{EE}$	-0.3	6	V
Input Voltage (IN+, IN-) ⁽²⁾	$V_{EE} - 0.3$	$V_{CC} + 0.3$	V
Differential Input Voltage ($V_{DI} = IN+ - IN-$)	$-(V_{CC} - V_{EE} + 0.3)$	$+(V_{CC} - V_{EE} + 0.3)$	V
Output Voltage (OUT) ⁽³⁾	$V_{EE} - 0.3$	$V_{CC} + 0.3$	V
Latch and Hysteresis Control (\overline{LE}/HYS)	$V_{EE} - 0.3$	$V_{CC} + 0.3$	V
Current into Input pins (IN+, IN-, \overline{LE}/HYS) ⁽²⁾		±10	mA
Current into Output pins (OUT) ⁽³⁾		±50	mA
Junction temperature, T_J		150	°C
Storage temperature, T_{stg}	-65	150	°C

- Operation outside the Absolute Maximum Ratings may cause permanent device damage. Absolute Maximum Ratings do not imply functional operation of the device at these or any other conditions beyond those listed under Recommended Operating Conditions. If used outside the Recommended Operating Conditions but within the Absolute Maximum Ratings, the device may not be fully functional, and this may affect device reliability, functionality, performance, and shorten the device lifetime.
- Input terminals are diode-clamped to the power-supply rails. Input signals that can swing more than 0.3 V beyond the supply rails must be current-limited to 10 mA or less.
- Output terminals are diode-clamped to the power-supply rails. Output signals that can swing more than 0.3 V beyond the supply rails must be current-limited to 50 mA or less.

6.2 ESD Ratings

			VALUE	UNIT
TLV3601(DCK), TLV3603				
$V_{(ESD)}$	Electrostatic discharge	Human-body model (HBM), per AEC Q100-002 ⁽¹⁾	±2000	V
		Charged-device model (CDM), per AEC Q100-011	±1000	
TLV3601(DBV)				
$V_{(ESD)}$	Electrostatic discharge	Human-body model (HBM), per AEC Q100-002 ⁽¹⁾	±2000	V
		Charged-device model (CDM), per AEC Q100-011	±750	
TLV3602				
$V_{(ESD)}$	Electrostatic discharge	Human-body model (HBM), per AEC Q100-002 ⁽¹⁾	±2000	V
		Charged-device model (CDM), per AEC Q100-011	±500	

- AEC Q100-002 indicates that HBM stressing shall be in accordance with the ANSI/ESDA/JEDEC JS-001 specification.

6.3 Recommended Operating Conditions

over operating free-air temperature range (unless otherwise noted)

	MIN	MAX	UNIT
Input Supply Voltage: $V_{CC} - V_{EE}$	2.4	5.5	V
Input Voltage Range (IN+, IN-)	$V_{EE} - 0.3$	$V_{CC} + 0.3$	V
Latch and Hysteresis Control (\overline{LE}/HYS)	$V_{EE} - 0.3$	$V_{CC} + 0.3$	V
Ambient temperature, T_A	-40	125	°C

6.4 Thermal Information

THERMAL METRIC		TLV3601	TLV3601	TLV3602	TLV3602	TLV3603	UNIT
		DBV (SOT-23)	DCK (SC70)	DGK (VSSOP)	DSG (WSON)	DCK (SC70)	
		5 PINS	5 PINS	8 PINS	8 PINS	6 PINS	
$R_{\theta JA}$	Junction-to-ambient thermal resistance	176.5	187.5	170.5	64.9	165.1	°C/W
$R_{\theta JC(top)}$	Junction-to-case (top) thermal resistance	74.7	139.2	61.7	83.9	129.1	°C/W
$R_{\theta JC(bottom)}$	Junction-to-case (bottom) thermal resistance	N/A	N/A	N/A	5.5	N/A	°C/W
$R_{\theta JB}$	Junction-to-board thermal resistance	43.4	65.8	92.4	32.0	58.9	°C/W
Ψ_{JT}	Junction-to-top characterization parameter	16.7	43.0	8.9	2.1	39.4	°C/W
Ψ_{JB}	Junction-to-board characterization parameter	43.1	65.5	90.8	32.0	58.7	°C/W

6.5 Electrical Characteristics

$V_{CC} = 2.5, 3.3$ and 5 V , $V_{EE} = 0\text{ V}$, $V_{CM} = V_{EE} + 300\text{ mV}$, $C_L = 5\text{ pF}$ probe capacitance, typical at $T_A = 25^\circ\text{C}$ (unless otherwise noted).

PARAMETER		TEST CONDITIONS	MIN	TYP	MAX	UNIT
DC Input Characteristics						
V_{IO}	Input offset voltage	$T_A = -40^\circ\text{C}$ to $+125^\circ\text{C}$	-5	± 0.5	5	mV
dV_{IO}/dT	Input offset voltage drift			± 3.0		$\mu\text{V}/^\circ\text{C}$
V_{CM}	Input common mode voltage range	$T_A = -40^\circ\text{C}$ to $+125^\circ\text{C}$	$V_{EE} - 0.2$		$V_{CC} + 0.2$	V
V_{HYST} (TLV3601)	Input hysteresis voltage	$T_A = -40^\circ\text{C}$ to $+125^\circ\text{C}$	1.5	3	5 ⁽¹⁾	mV
C_{IN}	Input capacitance			1		pF
R_{DM}	Input differential mode resistance			67		k Ω
R_{CM}	Input common mode resistance			5		M Ω
I_B	Input bias current	$T_A = -40^\circ\text{C}$ to $+125^\circ\text{C}$		1	5	μA
I_{OS}	Input offset current			± 0.03		μA
CMRR	Common-mode rejection ratio	$V_{CM} = V_{EE} - 0.2\text{V}$ to $V_{CC} + 0.2\text{V}$		80		dB
PSRR	Power-supply rejection ratio	$V_{CC} = 2.4$ to 5.5V		80		dB
DC Output Characteristics						
V_{OH}	Output high voltage from V_{CC}	$I_{SOURCE} = 1\text{ mA}$ $T_A = -40^\circ\text{C}$ to $+125^\circ\text{C}$		60	80	mV
V_{OL}	Output low voltage from V_{EE}	$I_{SINK} = 1\text{ mA}$ $T_A = -40^\circ\text{C}$ to $+125^\circ\text{C}$		60	80	mV
I_{SC_SOURCE}	Output Short-Circuit Current - Source	$T_A = -40^\circ\text{C}$ to $+125^\circ\text{C}$	10	30		mA
I_{SC_SINK}	Output Short-Circuit Current - Sink	$T_A = -40^\circ\text{C}$ to $+125^\circ\text{C}$	10	30		mA
Power Supply						
I_{CC} (TLV3601)	quiescent current	Output being high $T_A = -40^\circ\text{C}$ to $+125^\circ\text{C}$		4.9	7	mA
I_{CC} (TLV3602)	quiescent current per channel	Output being high $T_A = -40^\circ\text{C}$ to $+125^\circ\text{C}$		4.9	7	mA
I_{CC} (TLV3603)	quiescent current	Output being high $T_A = -40^\circ\text{C}$ to $+125^\circ\text{C}$		5.7	7.8	mA
V_{POR} (postive)	Power-On Reset Voltage			2.1		V
AC Characteristics						
t_{PD}	Propagation delay	$V_{OVERDRIVE} = V_{UNDERDRIVE} = 50\text{mV}$		2.5	3.5 ⁽¹⁾	ns
t_{PD}	Propagation delay	$V_{OVERDRIVE} = V_{UNDERDRIVE} = 50\text{mV}$ $T_A = -40^\circ\text{C}$ to $+125^\circ\text{C}$			4.5 ⁽¹⁾	ns
Δt_{PD} (TLV3602 only)	Channel-to-channel propagation delay skew ⁽²⁾	$V_{CM} = V_{CC}/2$, $V_{OVERDRIVE} = V_{UNDERDRIVE} = 50\text{mV}$, 50 MHz Squarewave		24		ps
$t_{CM_DISPERSION}$	Common dispersion	V_{CM} varied from V_{EE} to V_{CC}		80		ps
$t_{OD_DISPERSION}$	Overdrive dispersion	Overdrive varied from 10 mV to 125 mV		600		ps
$t_{UD_DISPERSION}$	Underdrive dispersion	Underdrive varied from 10mV to 125 mV		330		ps
t_R	Rise time	10% to 90%		0.75		ns
t_F	Fall time	90% to 10%		0.75		ns
t_{JITTER}	RMS Jitter	$V_{IN} = 100\text{mV}_{P-P}$, $f_{IN} = 100\text{MHz}$, Jitter BW = 10Hz – 50MHz		4		ps
f_{TOGGLE}	Input toggle frequency	$V_{IN} = 200\text{ mV}_{PP}$ Sine Wave, When output high reaches 90% of $V_{CC} - V_{EE}$ or output low reaches 10% of $V_{CC} - V_{EE}$		325		MHz
PulseWidth	Minimum allowed input pulse width	$V_{OVERDRIVE} = V_{UNDERDRIVE} = 50\text{mV}$ $PW_{OUT} = 90\%$ of PW_{IN}		1.25		ns

6.5 Electrical Characteristics (continued)

$V_{CC} = 2.5, 3.3$ and 5 V , $V_{EE} = 0\text{ V}$, $V_{CM} = V_{EE} + 300\text{ mV}$, $C_L = 5\text{ pF}$ probe capacitance, typical at $T_A = 25^\circ\text{C}$ (unless otherwise noted).

PARAMETER	TEST CONDITIONS	MIN	TYP	MAX	UNIT
Latching/Adjustable Hysteresis					
V_{HYST}	Input hysteresis voltage	$V_{HYST} = \text{Logic High}$	0		mV
V_{HYST}	Input hysteresis voltage	$R_{HYST} = \text{Floating}$	3		mV
V_{HYST}	Input hysteresis voltage	$R_{HYST} = 150\text{ k}\Omega$	30		mV
V_{HYST}	Input hysteresis voltage	$R_{HYST} = 56\text{ k}\Omega$	60		mV
V_{IH_LE}	\overline{LE} pin input high level	$T_A = -40^\circ\text{C to } +125^\circ\text{C}$	$V_{EE} + 1.5$		V
V_{IL_LE}	\overline{LE} pin input low level	$T_A = -40^\circ\text{C to } +125^\circ\text{C}$		$V_{EE} + 0.35$	V
I_{IH_LE}	\overline{LE} pin input leakage current	$V_{LE} = V_{CC}$ $T_A = -40^\circ\text{C to } +125^\circ\text{C}$		15	μA
I_{IL_LE}	\overline{LE} pin input leakage current	$V_{LE} = V_{EE}$ $T_A = -40^\circ\text{C to } +125^\circ\text{C}$		40	μA
t_{SETUP}	Latch setup time		-1.4		ns
t_{HOLD}	Latch hold time		7.2		ns
t_{PL}	Latch to OUT delay		7		ns

- Ensured by characterization
- Differential propagation delay is defined as the larger of the two:
 $\Delta t_{PDLH} = t_{PDLH}(\text{MAX}) - t_{PDLH}(\text{MIN})$
 $\Delta t_{PDHL} = t_{PDHL}(\text{MAX}) - t_{PDHL}(\text{MIN})$
 where (MAX) and (MIN) denote the maximum and minimum values of a given measurement across the different comparator channels.

6.6 Timing Diagrams



图 6-1. General Timing Diagram



6-2. Overdrive Dispersion

6.7 Typical Characteristics

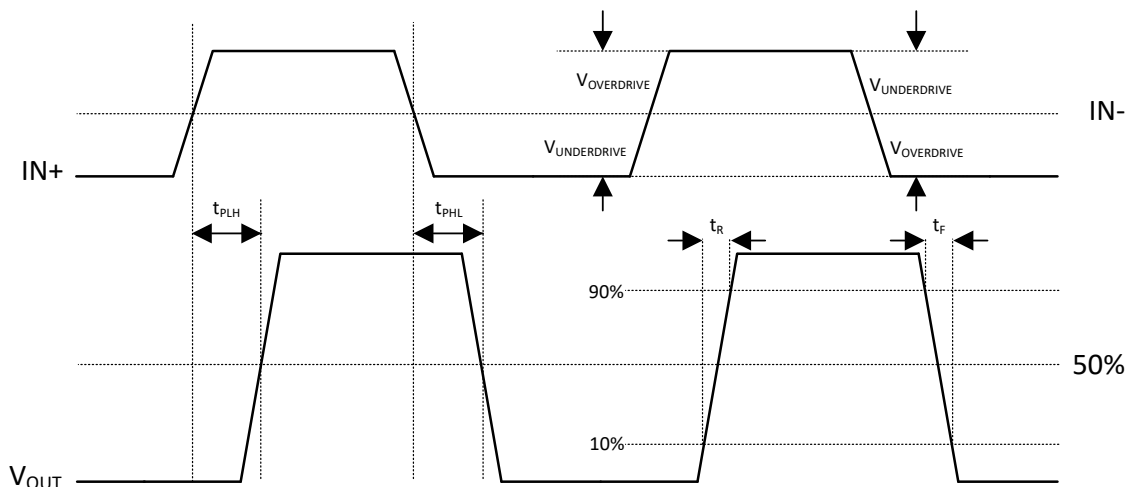
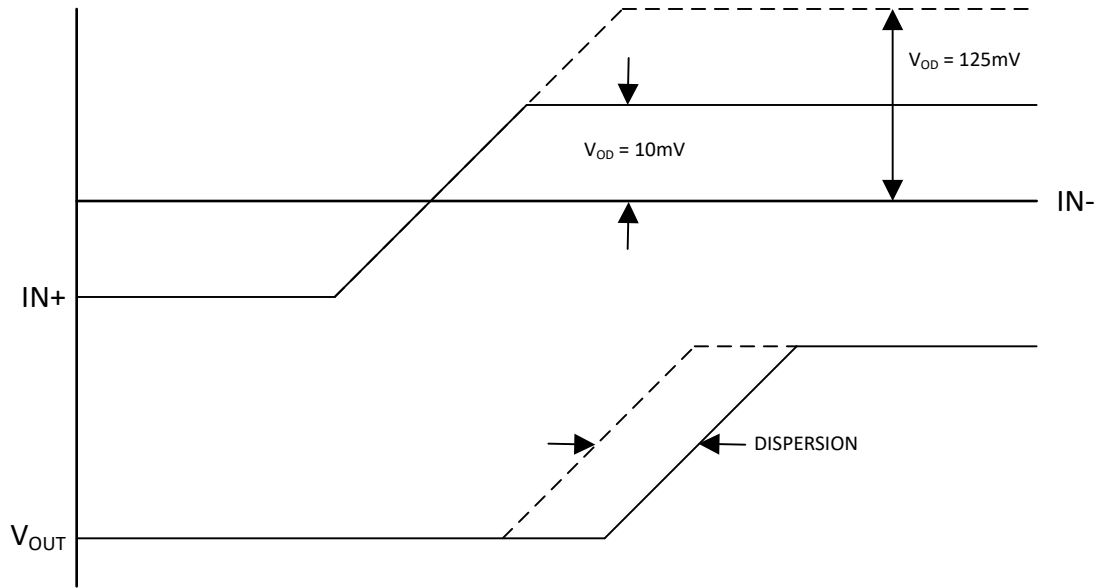
At $T_A = 25^\circ\text{C}$, $V_{CC} - V_{EE} = 2.5\text{ V to }5\text{ V}$, $V_{CM} = 300\text{ mV}$, $R_{HYST} = 150\text{ k}\Omega$ (TLV3603-Q1 only), and input overdrive = 50 mV, unless otherwise noted.

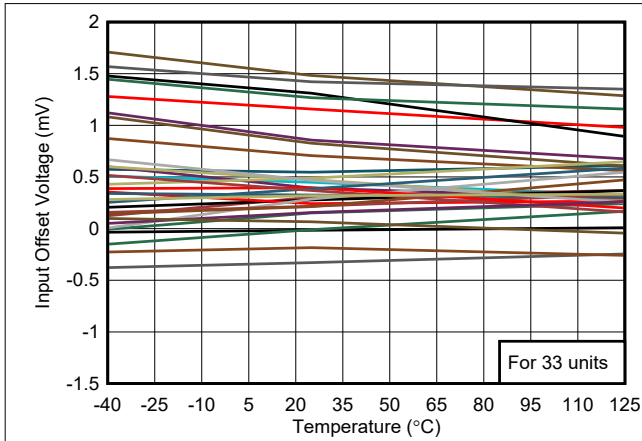

6-3. TLV3601 Offset vs. Temperature

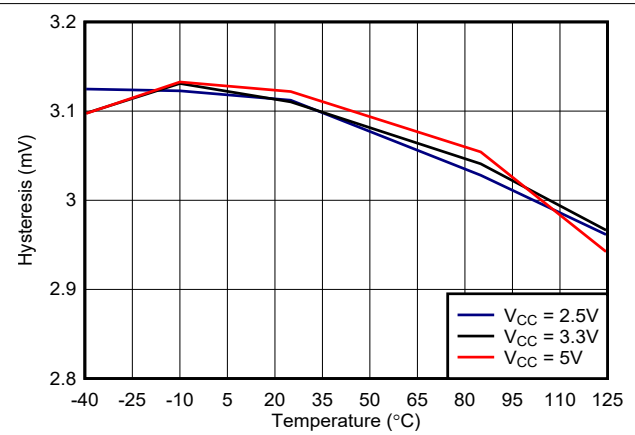

6-4. TLV3601 Hysteresis vs. Temperature

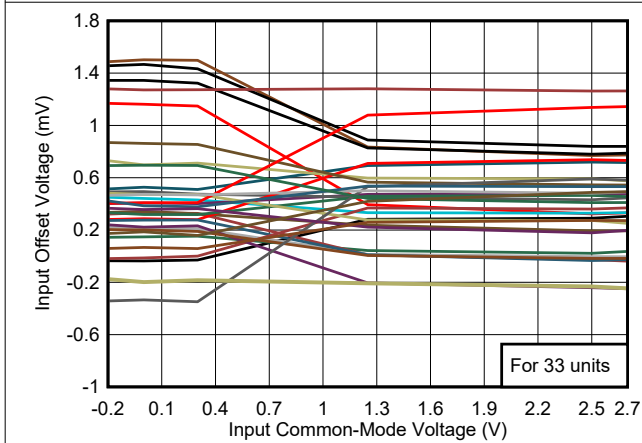

6-5. TLV3601 Offset vs. Common-Mode, 2.5 V

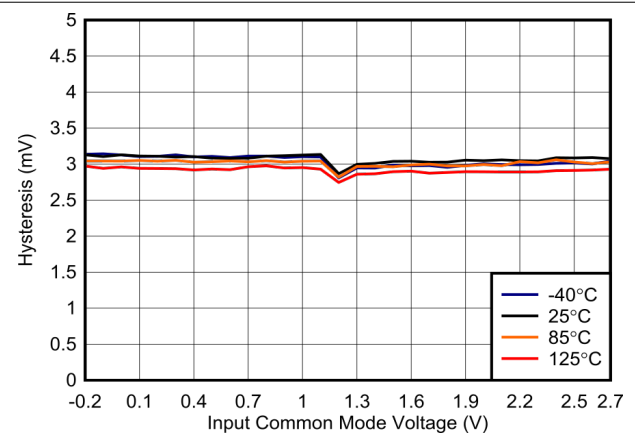

6-6. TLV3601 Hysteresis vs. Common-Mode, 2.5 V

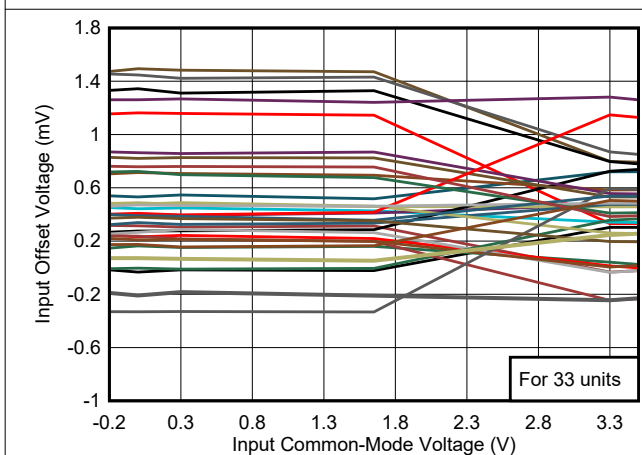

6-7. TLV3601 Offset vs. Common-Mode, 3.3 V

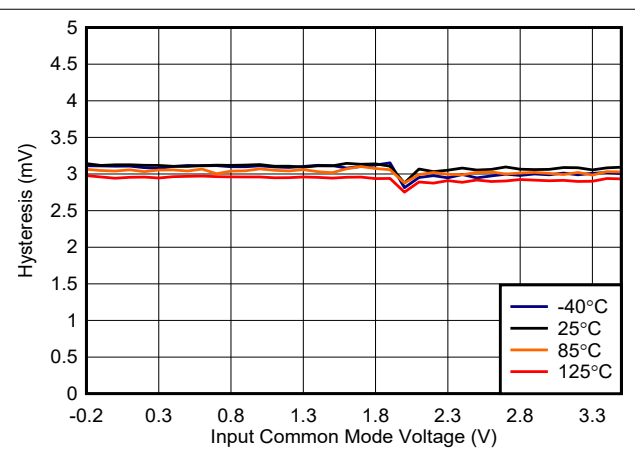

6-8. TLV3601 Hysteresis vs. Common-Mode, 3.3 V

6.7 Typical Characteristics (continued)

At $T_A = 25^\circ\text{C}$, $V_{CC} - V_{EE} = 2.5\text{ V to }5\text{ V}$, $V_{CM} = 300\text{ mV}$, $R_{HYST} = 150\text{ k}\Omega$ (TLV3603-Q1 only), and input overdrive = 50 mV, unless otherwise noted.

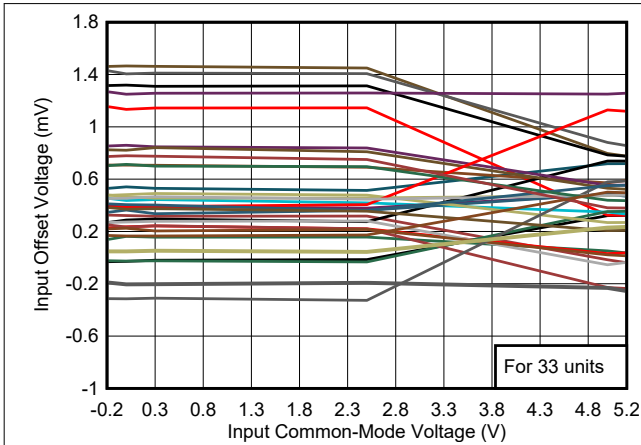

Figure 6-9. TLV3601 Offset vs. Common-Mode, 5 V

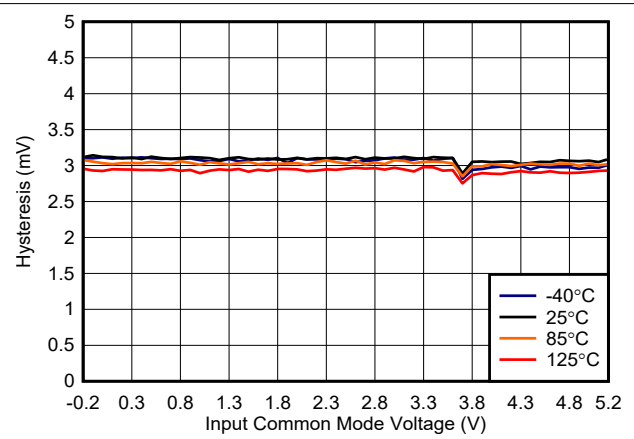

Figure 6-10. TLV3601 Hysteresis vs. Common-Mode, 5 V

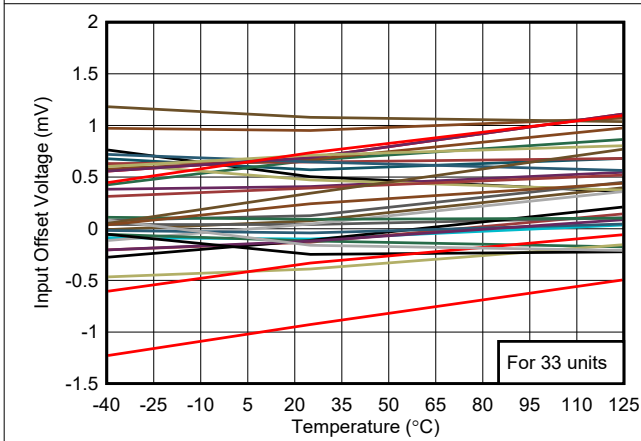

Figure 6-11. TLV3603 Offset vs. Temperature

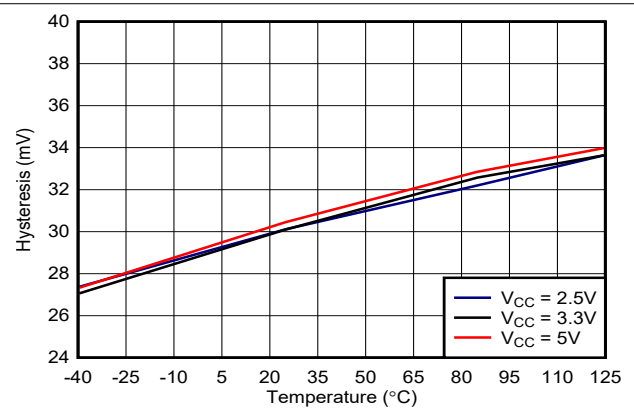

Figure 6-12. TLV3603 Hysteresis vs. Temperature

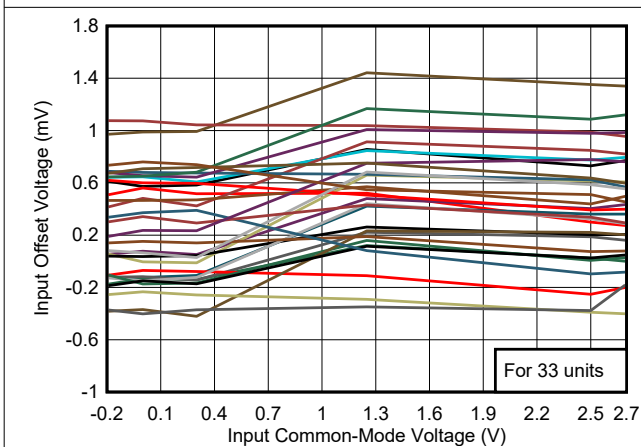

Figure 6-13. TLV3603 Offset vs. Common-Mode, 2.5 V

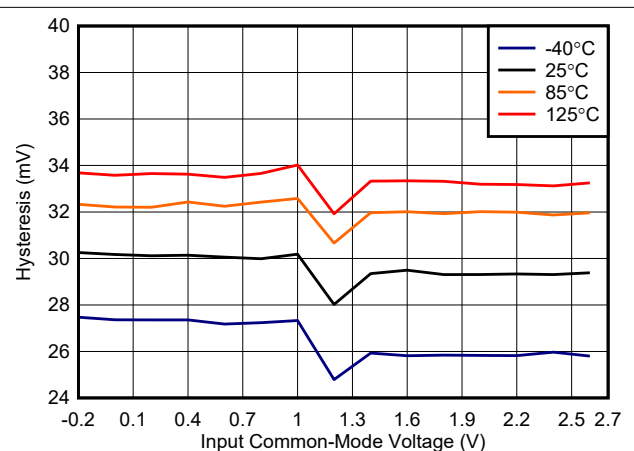
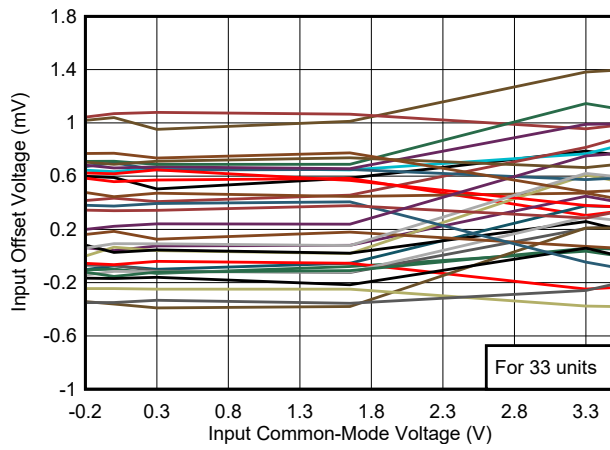

Figure 6-14. TLV3603 Hysteresis vs. Common-Mode, 2.5 V

6.7 Typical Characteristics (continued)

At $T_A = 25^\circ\text{C}$, $V_{CC} - V_{EE} = 2.5\text{ V to }5\text{ V}$, $V_{CM} = 300\text{ mV}$, $R_{HYST} = 150\text{ k}\Omega$ (TLV3603-Q1 only), and input overdrive = 50 mV, unless otherwise noted.



6-15. TLV3603 Offset vs. Common-Mode, 3.3 V

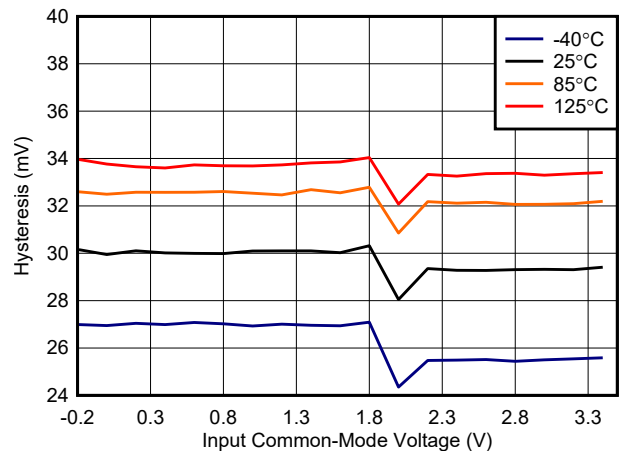

6-16. TLV3603 Hysteresis vs. Common-Mode, 3.3 V

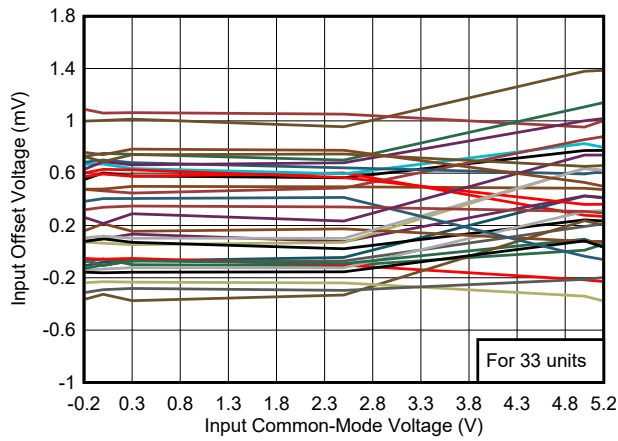

6-17. TLV3603 Offset vs. Common-Mode, 5 V

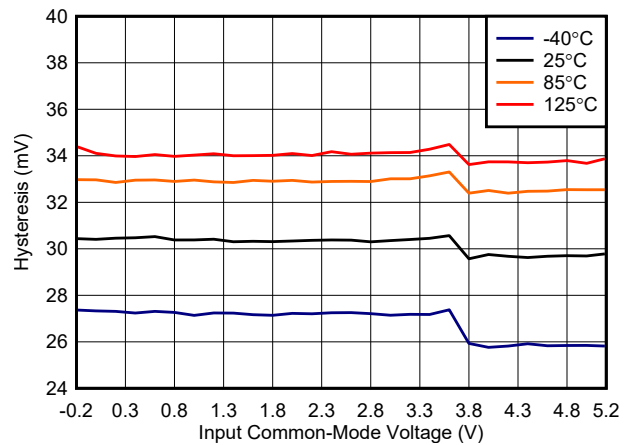

6-18. TLV3603 Hysteresis vs. Common-Mode, 5 V

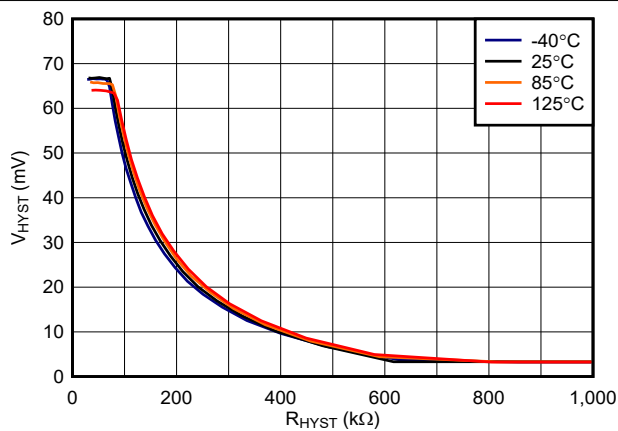

6-19. TLV3603 Hysteresis vs. Resistance, 2.5 V

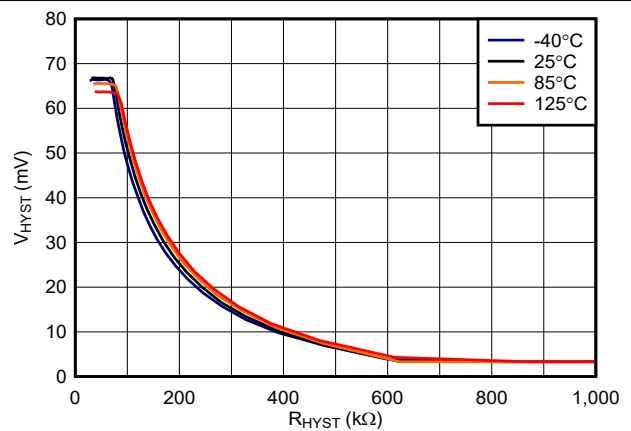

6-20. TLV3603 Hysteresis vs. Resistance, 3.3 V

6.7 Typical Characteristics (continued)

At $T_A = 25^\circ\text{C}$, $V_{CC} - V_{EE} = 2.5\text{ V}$ to 5 V , $V_{CM} = 300\text{ mV}$, $R_{HYST} = 150\text{ k}\Omega$ (TLV3603-Q1 only), and input overdrive = 50 mV , unless otherwise noted.

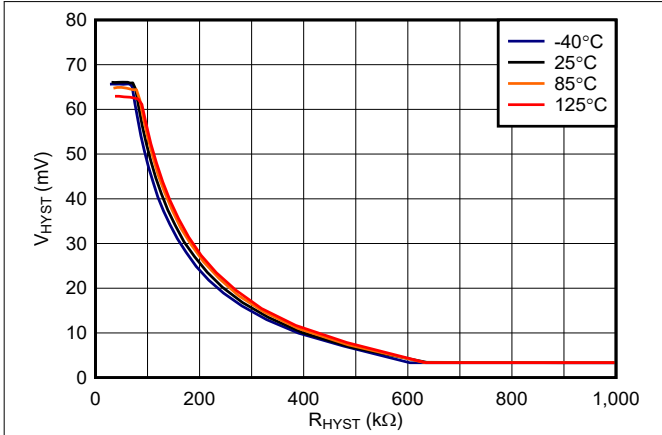

6-21. TLV3603 Hysteresis vs. Resistance, 5 V

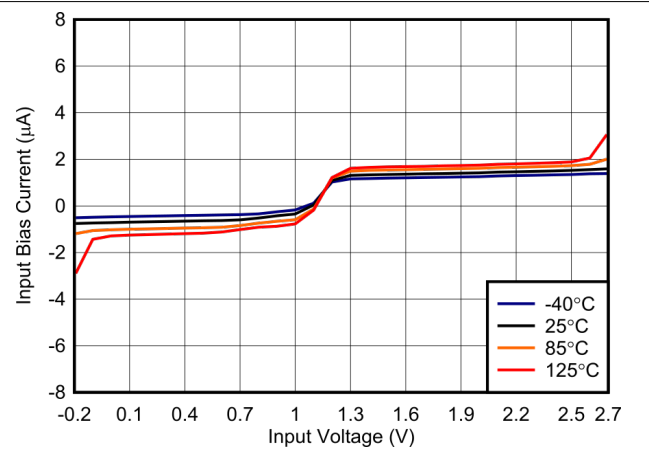

6-22. Bias Current vs. Input Voltage, 2.5 V

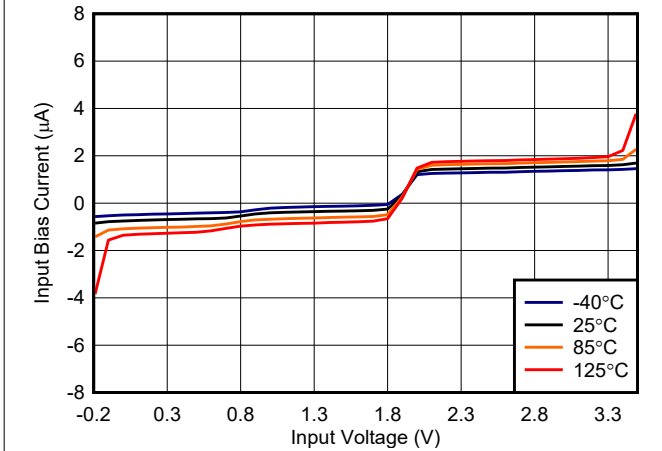

6-23. Bias Current vs. Input Voltage, 3.3 V

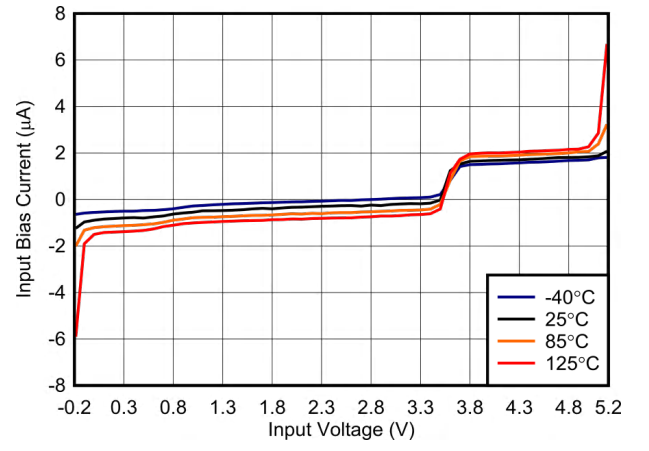

6-24. Bias Current vs. Input Voltage, 5 V

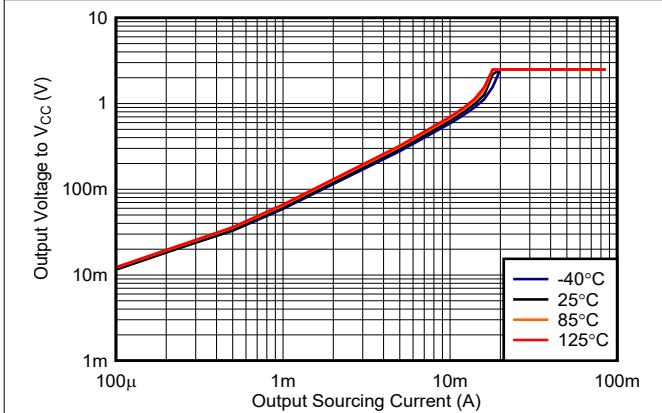

6-25. Output Voltage vs. Output Sourcing Current, 2.5 V

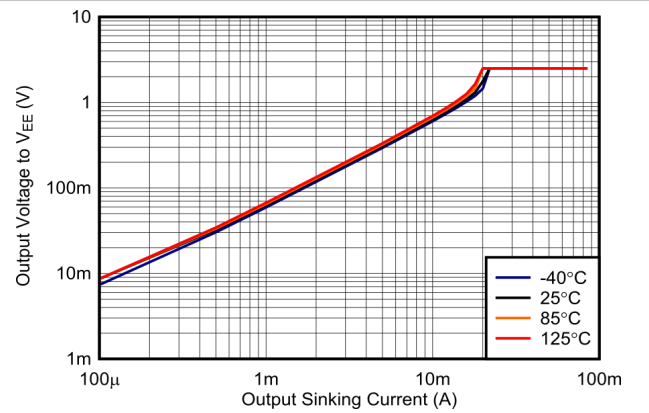

6-26. Output Voltage vs. Output Sinking Current, 2.5 V

6.7 Typical Characteristics (continued)

At $T_A = 25^\circ\text{C}$, $V_{CC} - V_{EE} = 2.5\text{ V to }5\text{ V}$, $V_{CM} = 300\text{ mV}$, $R_{HYST} = 150\text{ k}\Omega$ (TLV3603-Q1 only), and input overdrive = 50 mV, unless otherwise noted.

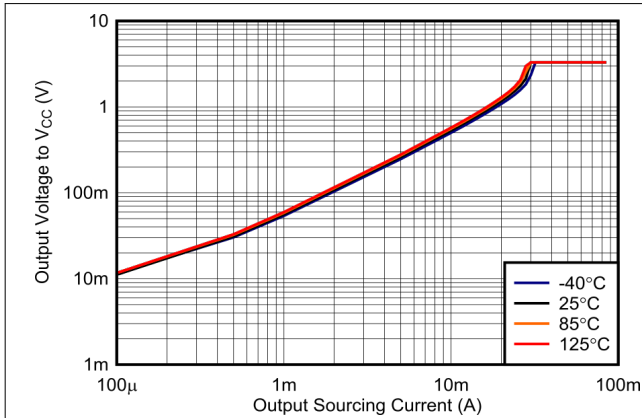

6-27. Output Voltage vs. Output Sourcing Current, 3.3 V

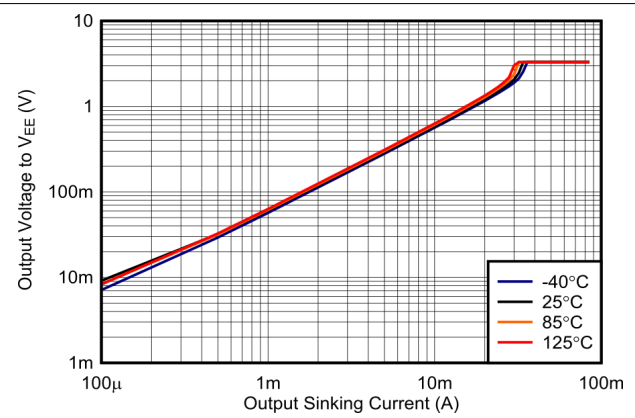

6-28. Output Voltage vs. Output Sinking Current, 3.3 V

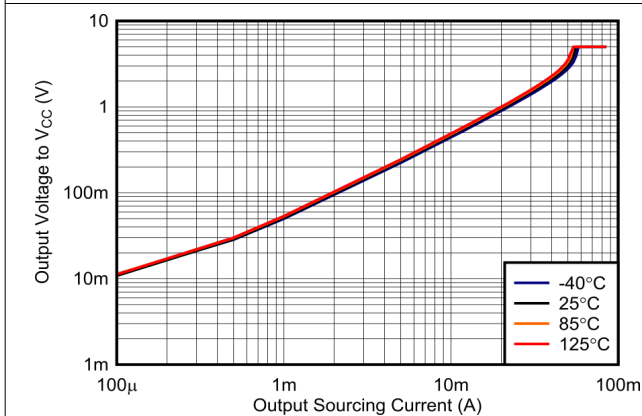

6-29. Output Voltage vs. Output Sourcing Current, 5 V

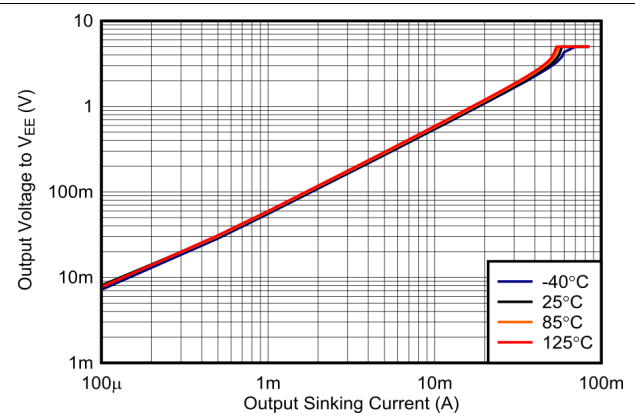

6-30. Output Voltage vs. Output Sinking Current, 5 V

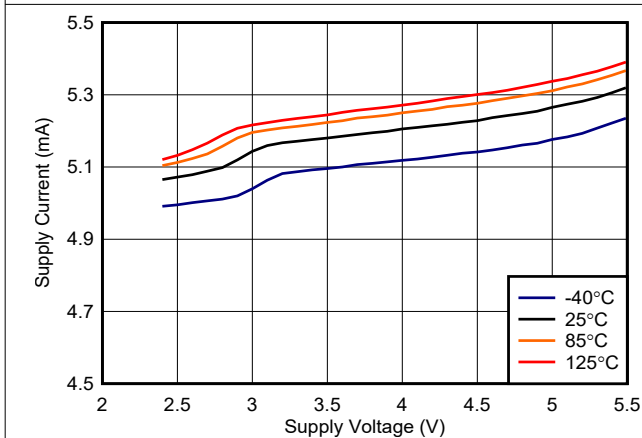

6-31. TLV3601 Supply Current vs. Voltage (Output Low)

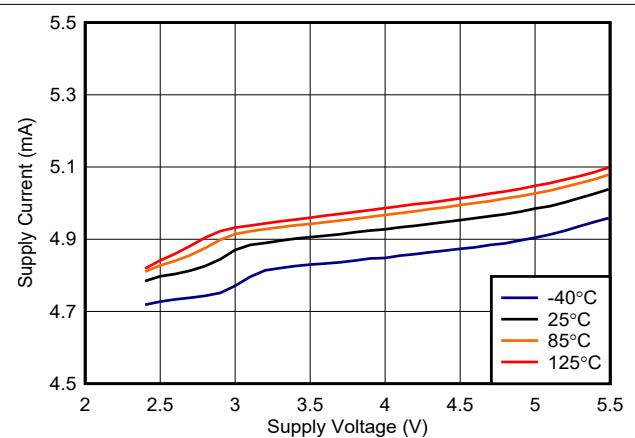

6-32. TLV3601 Supply Current vs. Voltage (Output High)

6.7 Typical Characteristics (continued)

At $T_A = 25^\circ\text{C}$, $V_{CC} - V_{EE} = 2.5\text{ V to }5\text{ V}$, $V_{CM} = 300\text{ mV}$, $R_{HYST} = 150\text{ k}\Omega$ (TLV3603-Q1 only), and input overdrive = 50 mV, unless otherwise noted.

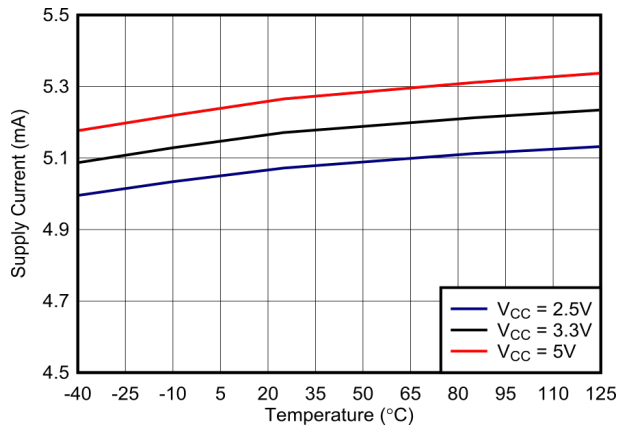

Figure 6-33. TLV3601 Supply Current vs. Temp (Output Low)

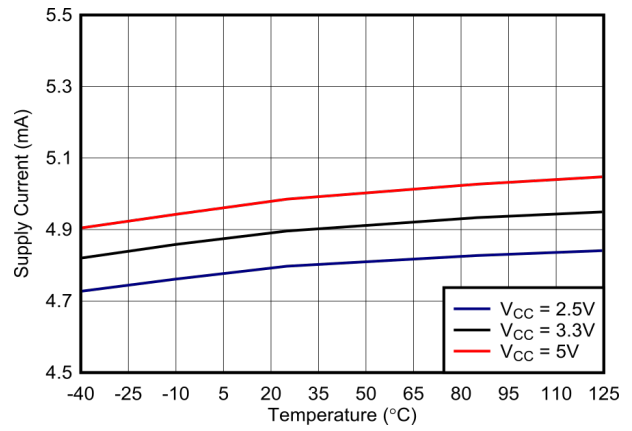

Figure 6-34. TLV3601 Supply Current vs. Temp (Output High)

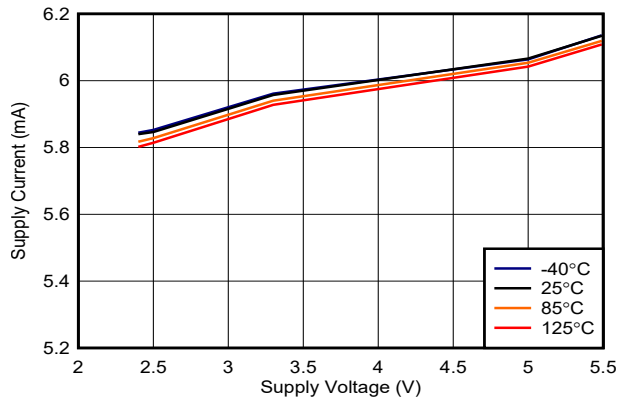

Figure 6-35. TLV3603 Supply Current vs. Voltage (Output Low)

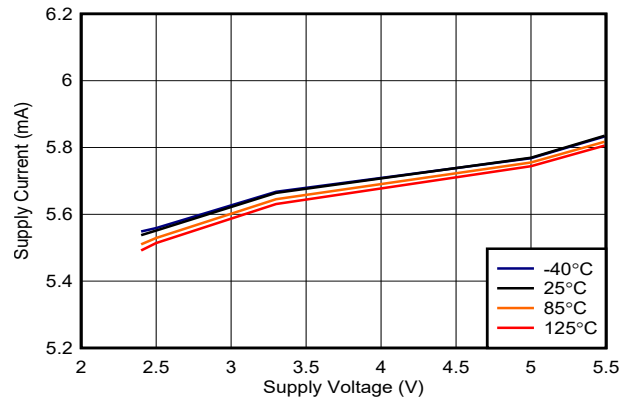

Figure 6-36. TLV3603 Supply Current vs. Voltage (Output High)

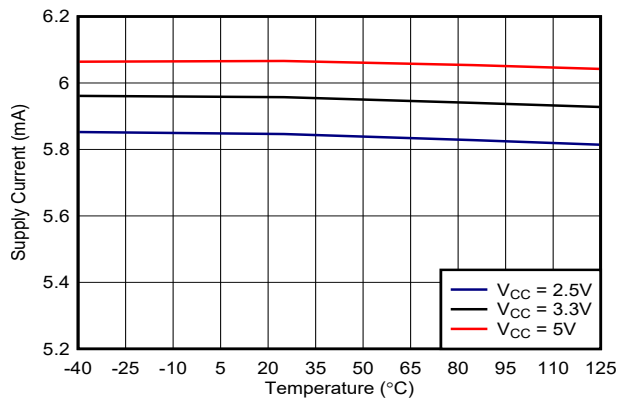

Figure 6-37. TLV3603 Supply Current vs. Temp (Output Low)

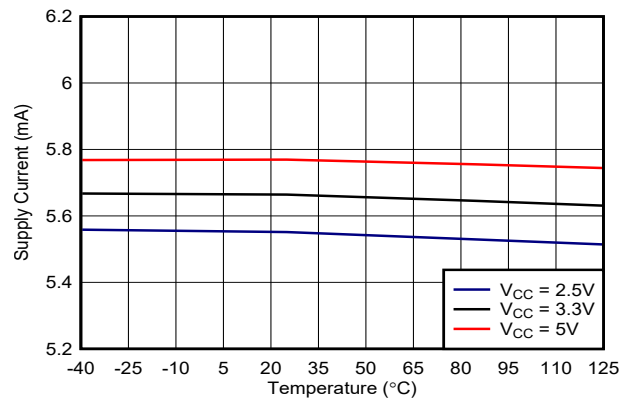
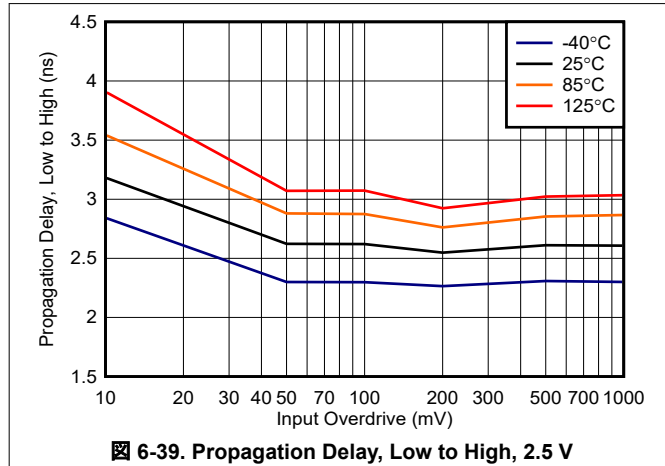

Figure 6-38. TLV3603 Supply Current vs. Temp (Output High)

6.7 Typical Characteristics (continued)

At $T_A = 25^\circ\text{C}$, $V_{CC} - V_{EE} = 2.5\text{ V to }5\text{ V}$, $V_{CM} = 300\text{ mV}$, $R_{HYST} = 150\text{ k}\Omega$ (TLV3603-Q1 only), and input overdrive = 50 mV, unless otherwise noted.



6-39. Propagation Delay, Low to High, 2.5 V

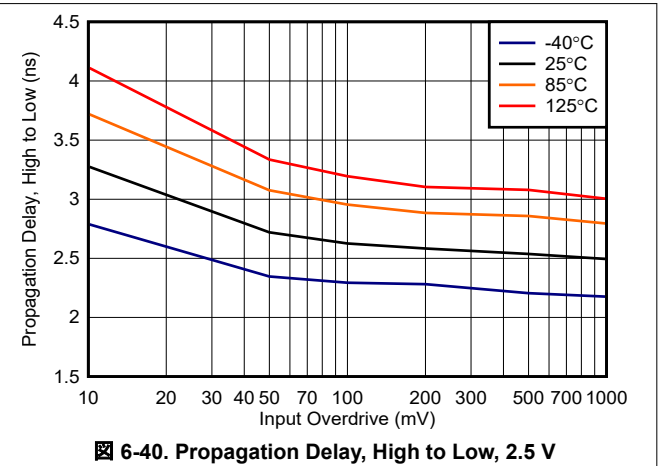

6-40. Propagation Delay, High to Low, 2.5 V

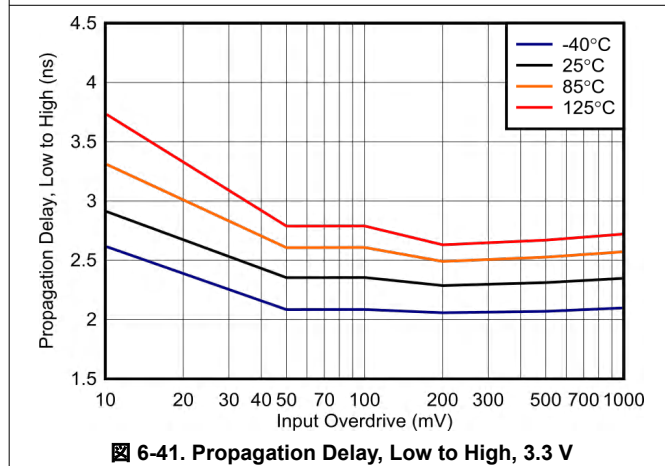

6-41. Propagation Delay, Low to High, 3.3 V

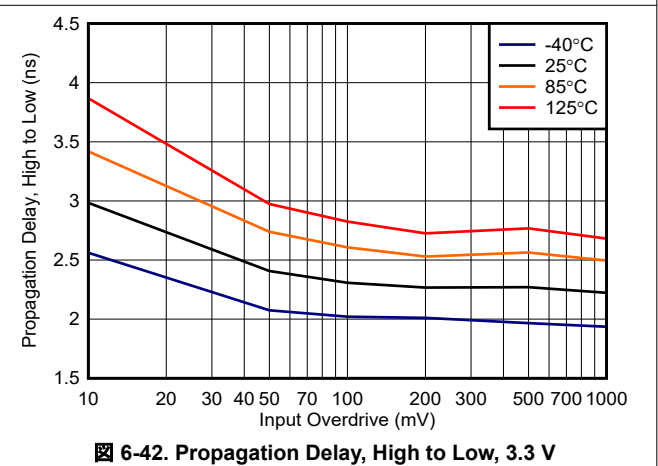

6-42. Propagation Delay, High to Low, 3.3 V

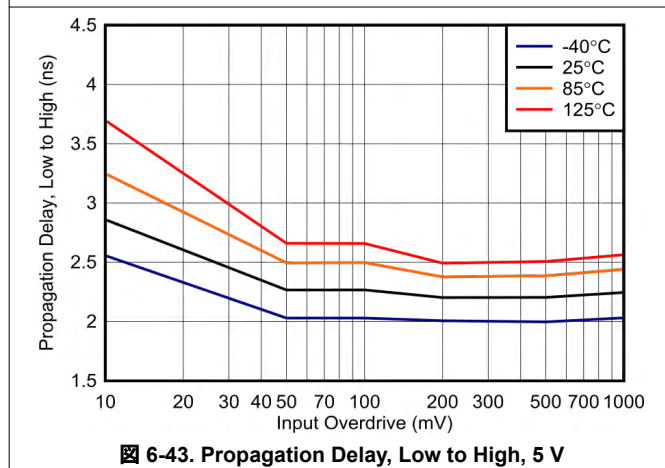

6-43. Propagation Delay, Low to High, 5 V

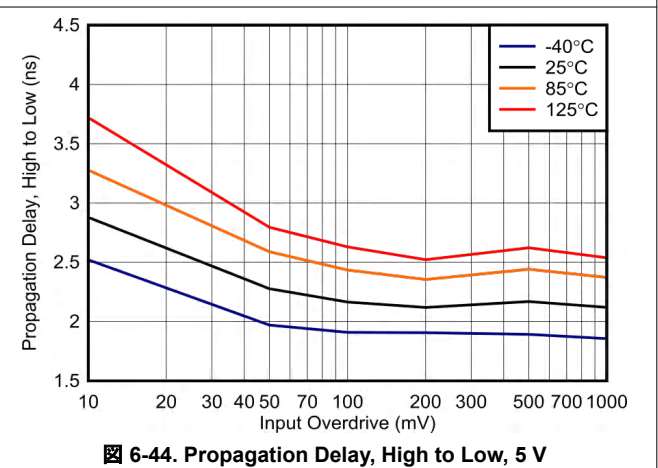

6-44. Propagation Delay, High to Low, 5 V

6.7 Typical Characteristics (continued)

At $T_A = 25^\circ\text{C}$, $V_{CC} - V_{EE} = 2.5\text{ V to }5\text{ V}$, $V_{CM} = 300\text{ mV}$, $R_{HYST} = 150\text{ k}\Omega$ (TLV3603-Q1 only), and input overdrive = 50 mV, unless otherwise noted.

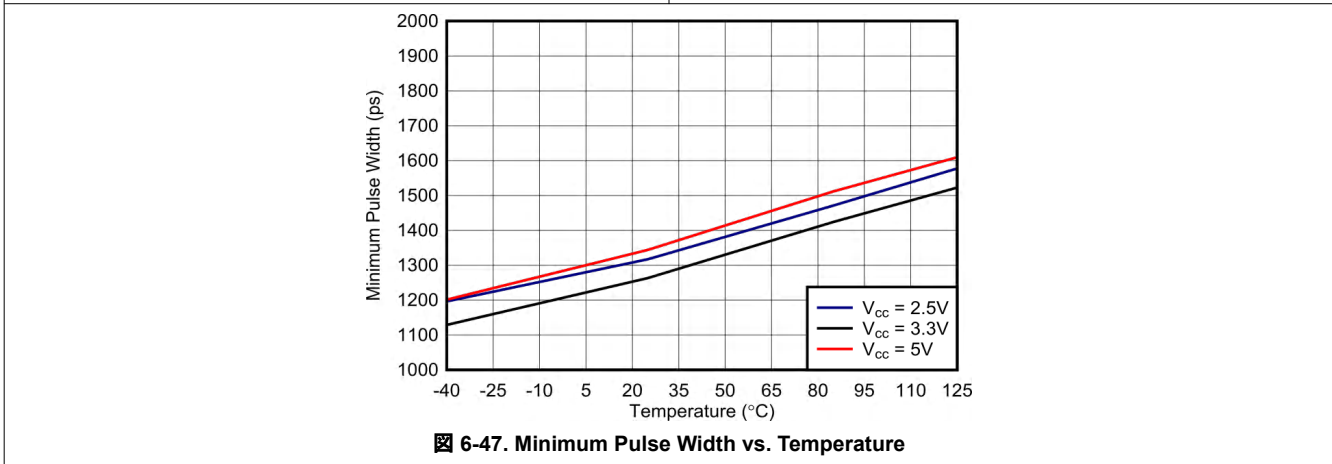
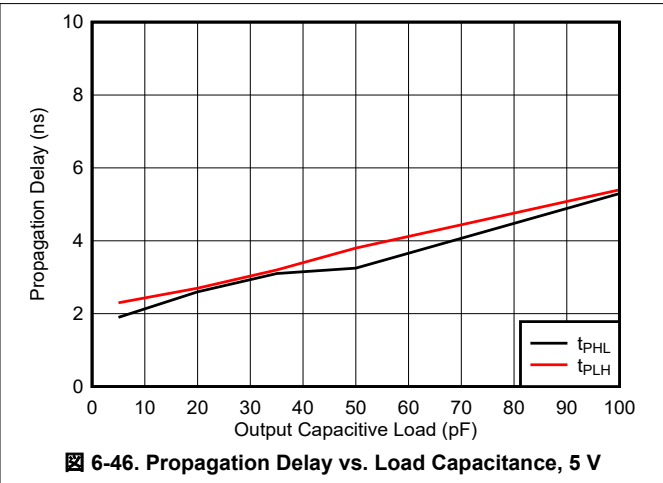
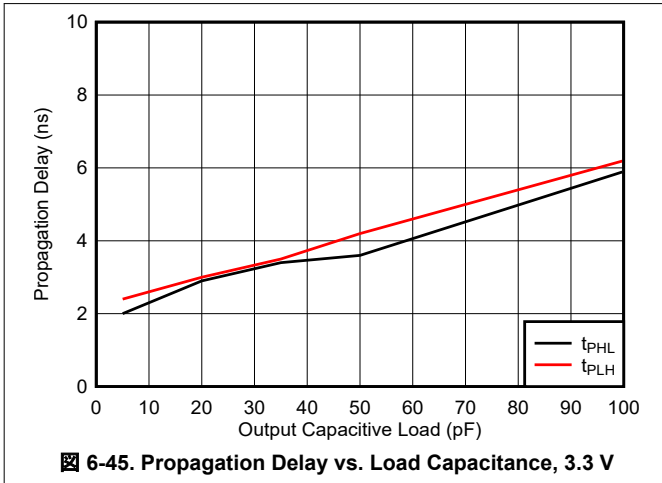

7 Detailed Description

7.1 Overview

The TLV360x family are high-speed comparators with single-ended (push-pull) output stages. The fast response time of these comparators make them well suited for applications that require narrow pulse width detection or high toggle frequencies. The TLV3601-Q1 is available in a 5-pin SC70 and SOT23 package, while the TLV3603-Q1 is packaged in a 6-pin SC70. The TLV3602-Q1 is a dual channel version of the TLV3601-Q1 and is packaged in an 8-pin VSSOP and WSON package.

7.2 Functional Block Diagram

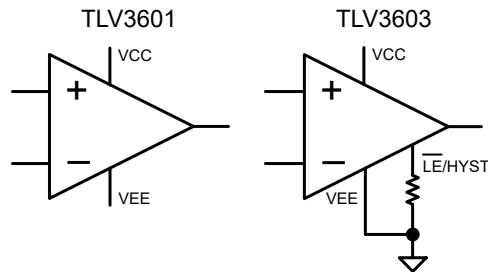

7.3 Feature Description

The TLV3601-Q1, TLV3603-Q1, and TLV3602-Q1 are single and dual channel, high speed comparators with a typical propagation delay of 2.5 ns and push-pull outputs. The minimum pulse width detection capability is 1.25 ns and the typical toggle rate is 325 MHz. These comparators are well-suited for distance measurement applications that utilize a time-of-flight architecture as well as systems that suffer from capacitive loading and require data and clock recovery. In addition to their high speed, the TLV360x family offers rail-to-rail input stages capable of operating up to 200 mV beyond each power supply rail combined with a maximum 5 mV input offset. The TLV3603-Q1 also provides adjustable hysteresis via an external resistor for noise suppression or a latching mode to hold the output of the comparators.

7.4 Device Functional Modes

The TLV3601-Q1 has a single functional mode and is active when the power supply voltage is greater than 2.4V. The TLV3603-Q1 has two modes of operation. The first is an active mode where the output reflects the condition at the inputs when an external resistor is connected to ground on the $\overline{\text{LE}}/\text{HYS}$ pin. The second is a latch mode where the output is held at its last active state when the $\overline{\text{LE}}/\text{HYS}$ pin is pulled low. The TLV3603-Q1 returns to active mode after a short delay when the pin is pulled high.

7.4.1 Inputs

The TLV360x family features input stages capable of operating 200 mV below negative power supply (ground) and 200 mV beyond the positive supply voltage, allowing for zero cross detection and maximizing input dynamic range given a certain power supply. The input stages are protected from conditions where the voltage on either pin exceeds this level by internal ESD protection diodes to VCC and VEE. To avoid damaging the inputs when exceeding the recommended input voltage range, an external resistor should be used to limit the current.

7.4.2 Push-Pull (Single-Ended) Output

The TLV360x outputs have excellent drive capability and are designed to connect directly to CMOS logic input devices. Likewise, the comparator output stages can drive capacitive loads. Transient performance parameters in the Electrical Characteristics Tables and Typical Characteristics section are for a load of 5pF, corresponding to a standard CMOS load. Device performance for larger capacitive loads can be found in the typical performance curves titled Propagation Delay vs Capacitive Load. For optimal speed and performance, output load capacitance should be reduced as much as possible.

7.4.3 Known Startup Condition

The TLV360x have a Power-on-Reset (POR) circuit which provides system designers a known start-up condition for the output of the comparators. When the power supply (VCC) is ramping up or ramping down, the POR circuit will be active when VCC is below V_{POR} . When active, the POR circuit holds the output low at VEE. When VCC is greater than or equal to V_{POR} as stated in [セクション 6.5](#), the comparator output reflects the state of the input pins.

7-1 shows how the TLV360x outputs respond for VCC rising. The input is configured with a logic high input to highlight the transition from the POR circuit control (logic low output) to a standard comparator operation where the output reflects the input condition. Note how the output goes high when VCC reaches 2.1V.

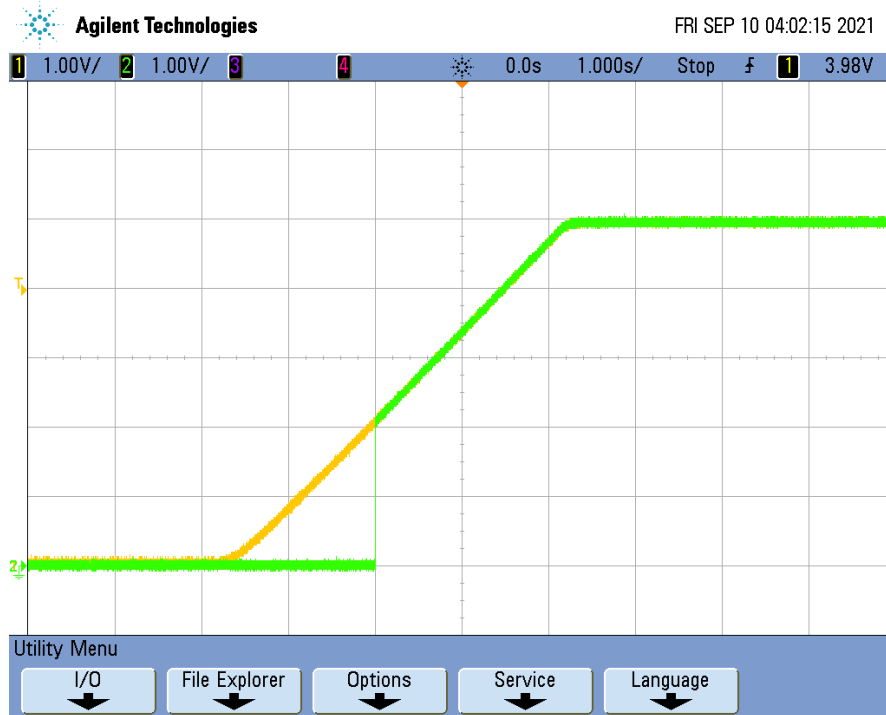

 7-1. TLV3601/TLV3603 Output for VCC Rising

8 Application and Implementation

注

Information in the following applications sections is not part of the TI component specification, and TI does not warrant its accuracy or completeness. TI's customers are responsible for determining suitability of components for their purposes, as well as validating and testing their design implementation to confirm system functionality.

8.1 Application Information

8.1.1 Adjustable Hysteresis

As a result of a comparator's high open loop gain, there is a small band of input differential voltage where the output can toggle back and forth between "logic high" and "logic low" states. This can cause design challenges for inputs with slow rise and fall times or systems with excessive noise. These challenges can be overcome by adding hysteresis to the comparator.

Since the TLV3601-Q1 and TLV3602-Q1 only has a minimal amount of internal hysteresis, external hysteresis can be applied in the form of a positive feedback loop that adjusts the trip point of the comparator depending on its current output state. See the [Implementing Hysteresis](#) section for more details.

The TLV3603-Q1 on the other hand has a $\overline{\text{LE}}/\text{HYS}$ pin that can be used to increase or eliminate the internal hysteresis of the comparator. In order to increase the internal hysteresis of the TLV3603-Q1, connect a single resistor as shown in the adjusting hysteresis figure between the $\overline{\text{LE}}/\text{HYS}$ pin and VEE. A curve of hysteresis versus resistance is provided below to provide guidance in setting the desired amount of hysteresis. Likewise, for applications where no hysteresis is desired, the $\overline{\text{LE}}/\text{HYS}$ pin can be connected to VCC.

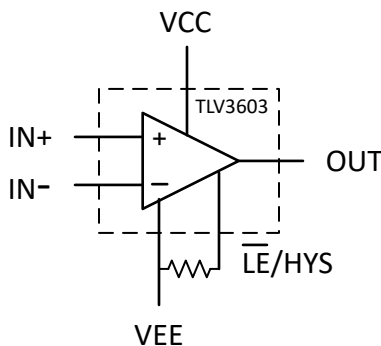

8-1. Adjustable Hysteresis with an External Resistor

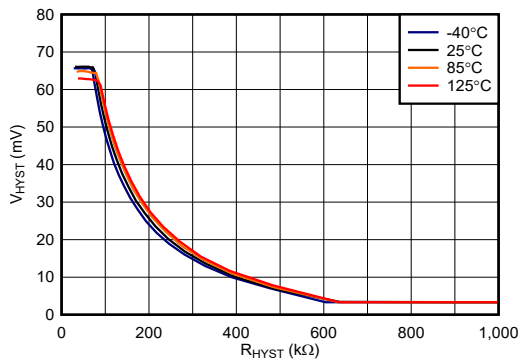

8-2. V_{HYST} (mV) vs R_{HYST} (k Ω), $V_{\text{CC}} = 5 \text{ V}$

8.1.2 Capacitive Loads

For capacitive loads under 100 pF, the propagation delay has minimum change (see [Propagation Delay vs. Capacitive Load](#)). However, excessive capacitive loading under high switching frequencies may increase supply current, propagation delay, or induce decreased slew rate.

8.1.3 Latch Functionality

The latch pin for the TLV3603-Q1 holds the output state of the device when the voltage at the $\overline{\text{LE}}/\text{HYS}$ pin is a logic low. This is particularly useful when the output state is intended to remain unchanged. An important consideration of the latch functionality is the latch hold and setup times. Latch hold time is the minimum time required (after the latch pin is asserted) for properly latching the comparator output. Likewise, latch setup time is defined as the time that the input must be stable before the latch pin is asserted low. The figure below illustrates when the input can transition for a valid latch. Note that the typical setup time in the EC table is negative; this is due to the internal trace delays of the $\overline{\text{LE}}/\text{HYS}$ pin relative to the input pin trace delays. A small delay (t_{PL}) in the output response is shown below when the TLV3603-Q1 exits a latched output stage.

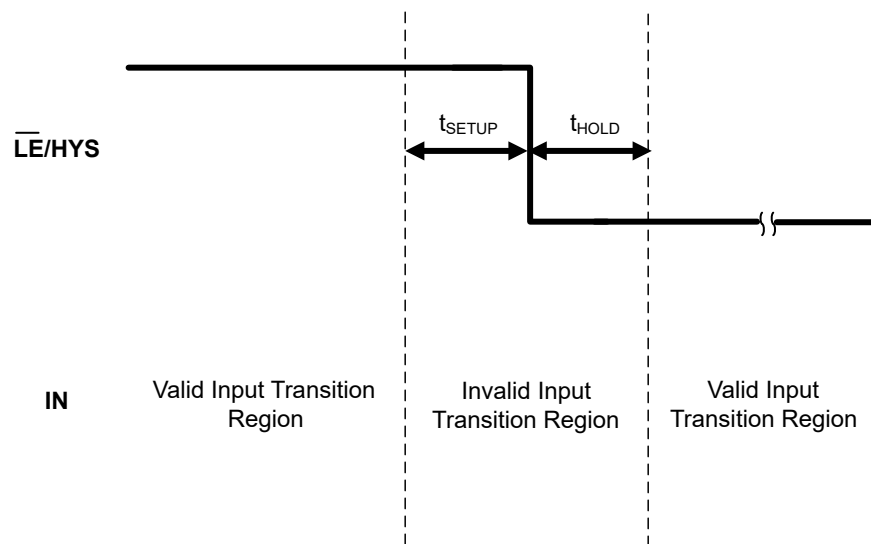

8-3. Input Change Properly Latched

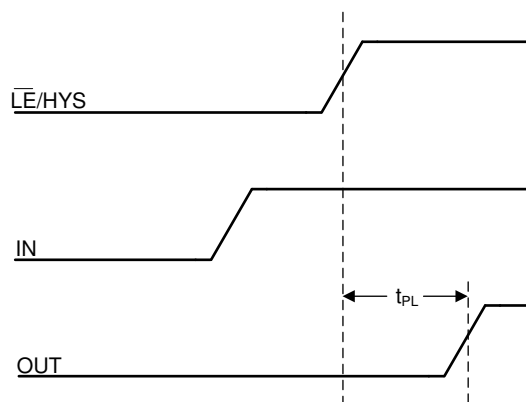

8-4. Latch Disable with Input Change

8.2 Typical Application

8.2.1 Implementing Hysteresis

A comparator may produce “chatter” (multiple transitions) at the output when there are noise or signal variations around the reference threshold; this causes the output to change states in rapid random successions as the

comparator input goes above and below the threshold of the reference. This usually occurs when the input signal is moving very slowly across the switching threshold of the comparator. This problem can be prevented by using the internal hysteresis feature of the comparator or by the addition of external hysteresis.

The TLV3603-Q1 has a $\overline{\text{LE}}/\text{HYS}$ pin that allows for variable internal hysteresis depending on the resistor value connected between the pin and VEE, where increasing the resistance decreases the hysteresis to a minimum level.

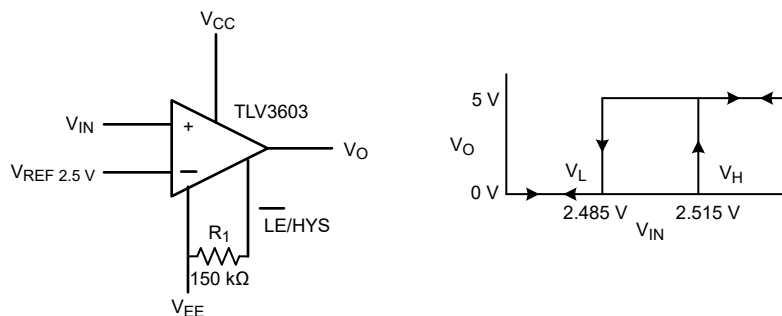

Figure 8-5. Adjustable Hysteresis with a 150kΩ Resistor using TLV3603

Since the TLV3601-Q1 and TLV3602-Q1 only have a minimal amount of internal hysteresis, external hysteresis can be added in the form of a positive feedback loop. A non-inverting comparator with hysteresis requires a two-resistor network and a voltage reference (V_{REF}) at the inverting input, as shown in [Figure 8-6](#).

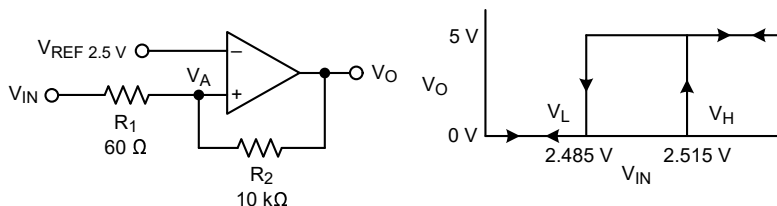

Figure 8-6. Non-Inverting Configuration for Hysteresis using TLV3601

8.2.1.1 Design Requirements

For this design, follow these design requirements.

表 8-1. Design Parameters

PARAMETER	VALUE
Supply Voltage (V_{CC})	5 V
V_{REF}	2.5 V
V_{HYS}	30 mV
Lower Threshold (V_{L})	2.485 V
Upper Threshold (V_{H})	2.515 V

8.2.1.2 Detailed Design Procedure

For the TLV3603-Q1, the hysteresis vs. resistance curve ([Figure 8-2](#)) can be used as a guidance to set the desired amount of hysteresis. [Figure 8-2](#) shows that for a 30-mV hysteresis, a 150 kΩ resistor must be placed from the $\overline{\text{LE}}/\text{HYS}$ pin to VEE.

For the TLV3601-Q1 and TLV3602-Q1, the following procedure can be used to add external hysteresis for a non-inverting configuration. Note that $V_{\text{HYS}} \ll V_{\text{REF}}$, so V_{HYS} can be ignored and is not included in the following equations for simpler calculation.

The equivalent resistor networks when the output is high and low are shown in [Figure 8-7](#).

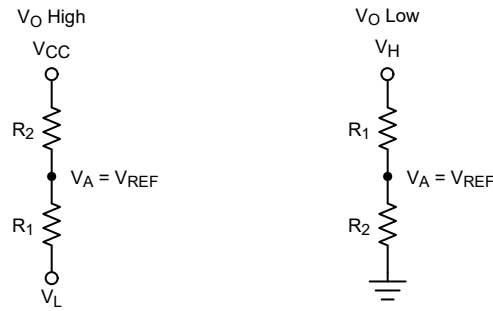

Figure 8-7. Equivalent Resistor Networks for Non-Inverting Configuration with Hysteresis

When V_{IN} is less than V_{REF} , the output is low. For the output to switch from low to high, V_{IN} must rise above the V_H threshold. Use [Equation 1](#) to calculate V_H .

$$V_H = (R_1 \times V_{REF}/R_2) + V_{REF} \quad (1)$$

When V_{IN} is greater than V_{REF} , the output is high. For the comparator to switch back to a low state, V_{IN} must drop below the V_L threshold. Use [Equation 2](#) to calculate V_L .

$$V_L = [V_{REF} (R_1 + R_2) - V_{CC} \times R_1] / R_2 \quad (2)$$

The hysteresis of this circuit is the difference between V_H and V_L , as shown in [Equation 3](#).

$$\Delta V_{IN} = V_{HYS} = (V_{CC} \times R_1/R_2) \quad (3)$$

Select a value for R_2 . Plug in given values for V_{CC} , V_{REF} , V_H , and V_L . For the given example, $R_2 = 10 \text{ k}\Omega$, and R_1 is solved as 60Ω .

For more information, please see Application Notes SNOA997 "Inverting Comparator with Hysteresis Circuit", SBOA313 "Non-Inverting Comparator With Hysteresis Circuit", SBOA219 "Comparator with and without hysteresis circuit".

8.2.1.3 Application Curve

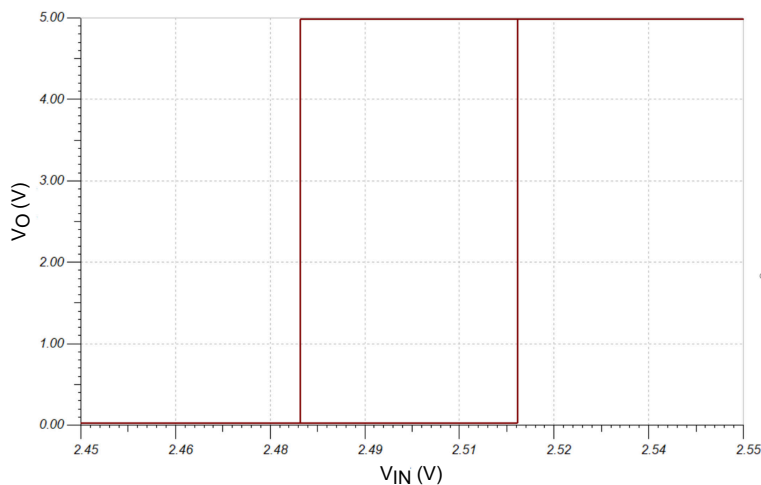
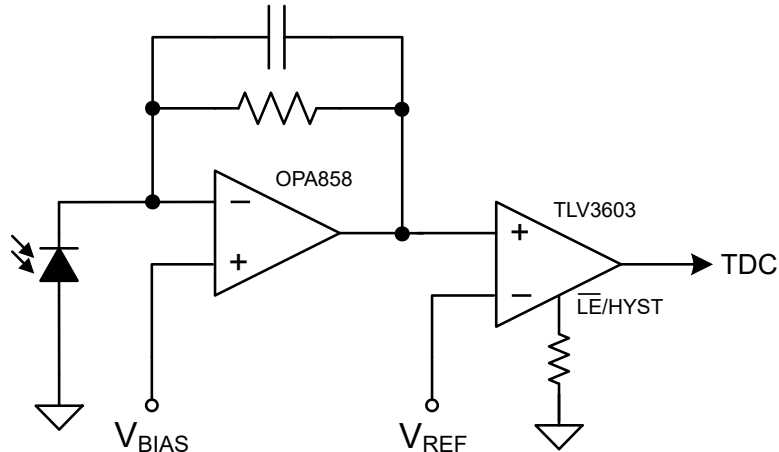

Figure 8-8. Hysteresis Transfer Curve using TLV3601/TLV3603

8.2.2 Optical Receiver

The TLV360x can be used in conjunction with a high speed amplifier such as the OPA858 to create an optical receiver as shown in the figure below. The photodiode is connected to a bias voltage and is being driven with a pulsed laser. The OPA858 takes the current conducting through the diode and translates it into a voltage for a high speed comparator to detect. The comparators will then output the proper output signal according to the threshold set (V_{REF}).



8-9. Optical Receiver

8.2.3 Over-Current Latch Condition

When it is important for a system to detect a brief over-current condition, it is advisable to utilize the latching feature of the TLV3603-Q1. By latching the comparator output, the MCU is reassured not to miss the over-current occurrence. The circuit below shows one way to implement the latching function.

When an over-current condition is detected by the TLV3603-Q1, the output will go high. The occurrence of the output going high coupled with a logic high from the \overline{RESET} signal from the MCU will create a logic low signal at the output of the 2-channel NAND gate. This will cause the output of the TLV3603-Q1 to be held in a logic high state (latched), thus allowing the MCU to detect the fault condition regardless of how narrow the over-current condition persists. The addition of the NAND gate also provides a means of clearing the latch state of the comparator once the MCU is done processing the event. This is accomplished by the MCU passing a logic low state to the NAND input causing the \overline{LE}/HYS pin of the comparator to be returned to a logic high state. The TLV3603-Q1 latched status is cleared and the TLV3603-Q1 output can continue to track the status of the input pins.

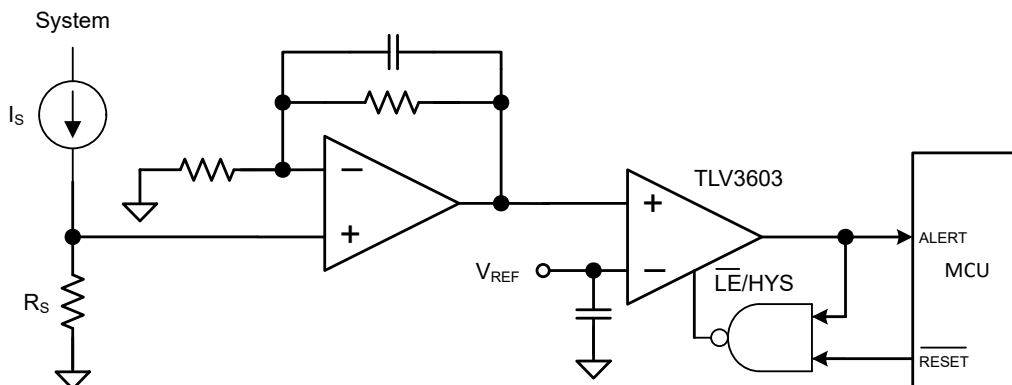

8-10. Over-Current Latched Output Circuit

8.2.4 External Trigger Function for Oscilloscopes

Below is a typical configuration for creating an external trigger on oscilloscopes. The user adjusts the trigger level by programming a DAC that the TLV360x can use as a reference. The input from an oscilloscope channel is then compared to the trigger reference voltage, and the comparator sends a signal to a downstream FPGA to begin a capture.



图 8-11. External Trigger Function

9 Power Supply Recommendations

The TLV360x are specified for operation from 2.4 V to 5.5 V. While most applications will require single supply operation where VEE is connected to the ground plane and VCC is connected to the intended power supply level, the comparators can also be operated with split supplies. One caution when using split supplies is that the output logic levels are determined by the VCC and VEE levels. For example, if split supplies of +/- 2.5V are used, the output levels will be 2.5V and -2.5V accordingly. In addition, the logic level of the \overline{LE}/HYS pin will also be referenced to VEE. This means that the external hysteresis resistor on the TLV3603-Q1 needs to be connected between the \overline{LE}/HYS pin and VEE (not to ground) for proper operation.

Regardless of single supply or split supply operation, proper decoupling capacitors are required. It is recommended to use a scheme of multiple, low-ESR ceramic capacitors from the supply pins to the ground plane for optimum performance. A good combination would be 100 pF, 10 nF, and 1 uF with the lowest value capacitor closest to the comparator.

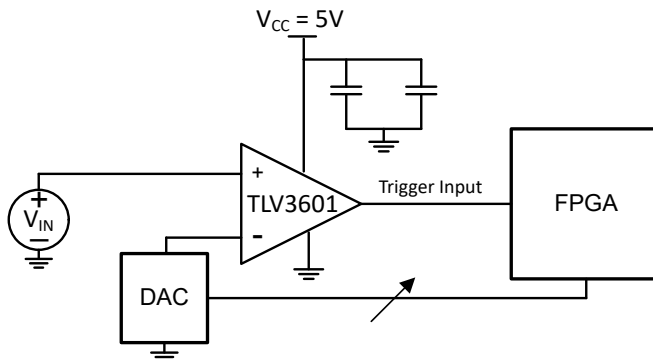
10 Layout

10.1 Layout Guidelines

Comparators are very sensitive to input noise. For best results, adhere to the following layout guidelines.

1. Use a printed-circuit-board (PCB) with a good, unbroken, low-inductance ground plane. Proper grounding (use of a ground plane) helps maintain specified device performance.

Likewise, high performance board materials such as Rogers or high speed FR4 is also recommended.

2. Place a decoupling capacitor (100-pF ceramic, surface-mount capacitor) between V_{CC} and V_{EE} as close to the device as possible. Using multiple bypass capacitors in different decade ranges such as 100-pF, 100-nF, and 1- μ F provides the best noise reduction across frequency ranges.
3. On the inputs and the output, keep lead lengths as short and minimize capacitive coupling to the traces by having a keepout area around the traces that is 3x the width of the traces. It is also recommended to keep inputs away from the output.
4. Solder the device directly to the PCB rather than using a socket.

10.2 Layout Example

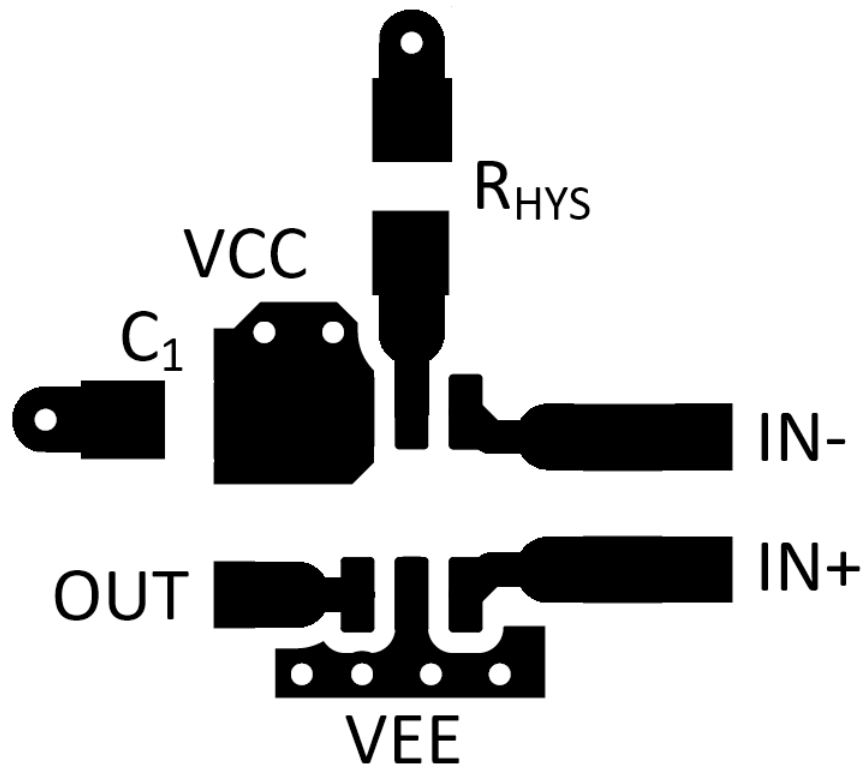

✎ 10-1. TLV3603 Layout Example

11 Device and Documentation Support

11.1 Device Support

11.1.1 Development Support

[LIDAR Pulsed Time of Flight Reference Design](#)

11.2 Receiving Notification of Documentation Updates

To receive notification of documentation updates, navigate to the device product folder on [ti.com](#). Click on *Subscribe to updates* to register and receive a weekly digest of any product information that has changed. For change details, review the revision history included in any revised document.

11.3 サポート・リソース

TI E2E™ サポート・フォーラムは、エンジニアが検証済みの回答と設計に関するヒントをエキスパートから迅速かつ直接得ることができる場所です。既存の回答を検索したり、独自の質問をしたりすることで、設計に必要な支援を迅速に得ることができます。

リンクされているコンテンツは、該当する貢献者により、現状のまま提供されるものです。これらは TI の仕様を構成するものではなく、必ずしも TI の見解を反映したものではありません。TI の[使用条件](#)を参照してください。

11.4 Trademarks

TI E2E™ is a trademark of Texas Instruments.

すべての商標は、それぞれの所有者に帰属します。

11.5 Electrostatic Discharge Caution



This integrated circuit can be damaged by ESD. Texas Instruments recommends that all integrated circuits be handled with appropriate precautions. Failure to observe proper handling and installation procedures can cause damage.

ESD damage can range from subtle performance degradation to complete device failure. Precision integrated circuits may be more susceptible to damage because very small parametric changes could cause the device not to meet its published specifications.

11.6 Glossary

[TI Glossary](#) This glossary lists and explains terms, acronyms, and definitions.

12 Mechanical, Packaging, and Orderable Information

The following pages include mechanical, packaging, and orderable information. This information is the most current data available for the designated devices. This data is subject to change without notice and revision of this document. For browser-based versions of this data sheet, refer to the left-hand navigation.

PACKAGING INFORMATION

Orderable Device	Status (1)	Package Type	Package Drawing	Pins	Package Qty	Eco Plan (2)	Lead finish/ Ball material (6)	MSL Peak Temp (3)	Op Temp (°C)	Device Marking (4/5)	Samples
TLV3601QDBVRQ1	ACTIVE	SOT-23	DBV	5	3000	RoHS & Green	NIPDAU	Level-1-260C-UNLIM	-40 to 125	601Q	Samples
TLV3601QDCKRQ1	ACTIVE	SC70	DCK	5	3000	RoHS & Green	NIPDAU	Level-1-260C-UNLIM	-40 to 125	1JG	Samples
TLV3602QDGKRQ1	ACTIVE	VSSOP	DGK	8	2500	RoHS & Green	NIPDAU	Level-1-260C-UNLIM	-40 to 125	602Q	Samples
TLV3603QDCKRQ1	ACTIVE	SC70	DCK	6	3000	RoHS & Green	NIPDAU	Level-1-260C-UNLIM	-40 to 125	1JH	Samples

(1) The marketing status values are defined as follows:

ACTIVE: Product device recommended for new designs.

LIFEBUY: TI has announced that the device will be discontinued, and a lifetime-buy period is in effect.

NRND: Not recommended for new designs. Device is in production to support existing customers, but TI does not recommend using this part in a new design.

PREVIEW: Device has been announced but is not in production. Samples may or may not be available.

OBSOLETE: TI has discontinued the production of the device.

(2) **RoHS:** TI defines "RoHS" to mean semiconductor products that are compliant with the current EU RoHS requirements for all 10 RoHS substances, including the requirement that RoHS substance do not exceed 0.1% by weight in homogeneous materials. Where designed to be soldered at high temperatures, "RoHS" products are suitable for use in specified lead-free processes. TI may reference these types of products as "Pb-Free".

RoHS Exempt: TI defines "RoHS Exempt" to mean products that contain lead but are compliant with EU RoHS pursuant to a specific EU RoHS exemption.

Green: TI defines "Green" to mean the content of Chlorine (Cl) and Bromine (Br) based flame retardants meet JS709B low halogen requirements of <=1000ppm threshold. Antimony trioxide based flame retardants must also meet the <=1000ppm threshold requirement.

(3) MSL, Peak Temp. - The Moisture Sensitivity Level rating according to the JEDEC industry standard classifications, and peak solder temperature.

(4) There may be additional marking, which relates to the logo, the lot trace code information, or the environmental category on the device.

(5) Multiple Device Markings will be inside parentheses. Only one Device Marking contained in parentheses and separated by a "-" will appear on a device. If a line is indented then it is a continuation of the previous line and the two combined represent the entire Device Marking for that device.

(6) Lead finish/Ball material - Orderable Devices may have multiple material finish options. Finish options are separated by a vertical ruled line. Lead finish/Ball material values may wrap to two lines if the finish value exceeds the maximum column width.

Important Information and Disclaimer:The information provided on this page represents TI's knowledge and belief as of the date that it is provided. TI bases its knowledge and belief on information provided by third parties, and makes no representation or warranty as to the accuracy of such information. Efforts are underway to better integrate information from third parties. TI has taken and

continues to take reasonable steps to provide representative and accurate information but may not have conducted destructive testing or chemical analysis on incoming materials and chemicals. TI and TI suppliers consider certain information to be proprietary, and thus CAS numbers and other limited information may not be available for release.

In no event shall TI's liability arising out of such information exceed the total purchase price of the TI part(s) at issue in this document sold by TI to Customer on an annual basis.

OTHER QUALIFIED VERSIONS OF TLV3601-Q1, TLV3602-Q1, TLV3603-Q1 :

- Catalog : [TLV3601](#), [TLV3602](#), [TLV3603](#)

NOTE: Qualified Version Definitions:

- Catalog - TI's standard catalog product

TAPE AND REEL INFORMATION



QUADRANT ASSIGNMENTS FOR PIN 1 ORIENTATION IN TAPE



*All dimensions are nominal

Device	Package Type	Package Drawing	Pins	SPQ	Reel Diameter (mm)	Reel Width W1 (mm)	A0 (mm)	B0 (mm)	K0 (mm)	P1 (mm)	W (mm)	Pin1 Quadrant
TLV3601QDBVRQ1	SOT-23	DBV	5	3000	180.0	8.4	3.2	3.2	1.4	4.0	8.0	Q3
TLV3601QDCKRQ1	SC70	DCK	5	3000	180.0	8.4	2.47	2.3	1.25	4.0	8.0	Q3
TLV3602QDQKRQ1	VSSOP	DGK	8	2500	330.0	12.4	5.3	3.4	1.4	8.0	12.0	Q1
TLV3603QDCKRQ1	SC70	DCK	6	3000	180.0	8.4	2.47	2.3	1.25	4.0	8.0	Q3

TAPE AND REEL BOX DIMENSIONS

*All dimensions are nominal

Device	Package Type	Package Drawing	Pins	SPQ	Length (mm)	Width (mm)	Height (mm)
TLV3601QDBVRQ1	SOT-23	DBV	5	3000	210.0	185.0	35.0
TLV3601QDCKRQ1	SC70	DCK	5	3000	183.0	183.0	20.0
TLV3602QDGKRQ1	VSSOP	DGK	8	2500	366.0	364.0	50.0
TLV3603QDCKRQ1	SC70	DCK	6	3000	183.0	183.0	20.0

EXAMPLE BOARD LAYOUT

DBV0005A

SOT-23 - 1.45 mm max height

SMALL OUTLINE TRANSISTOR

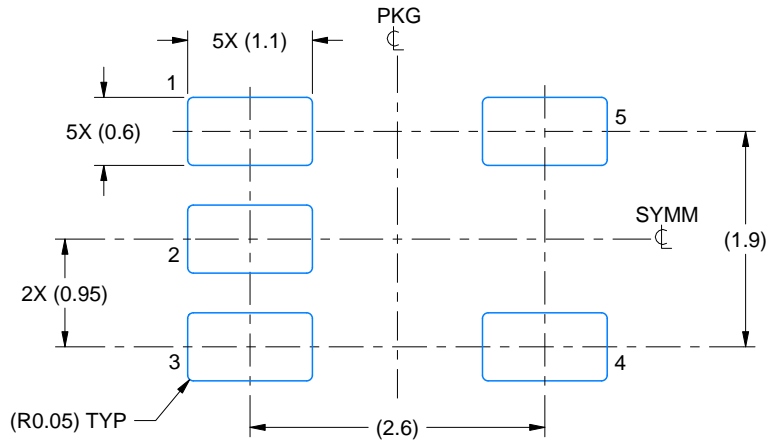

LAND PATTERN EXAMPLE
EXPOSED METAL SHOWN
SCALE:15X



SOLDER MASK DETAILS

4214839/K 08/2024

NOTES: (continued)

- 6. Publication IPC-7351 may have alternate designs.
- 7. Solder mask tolerances between and around signal pads can vary based on board fabrication site.

EXAMPLE STENCIL DESIGN

DBV0005A

SOT-23 - 1.45 mm max height

SMALL OUTLINE TRANSISTOR



SOLDER PASTE EXAMPLE
BASED ON 0.125 mm THICK STENCIL
SCALE:15X

4214839/K 08/2024

NOTES: (continued)

8. Laser cutting apertures with trapezoidal walls and rounded corners may offer better paste release. IPC-7525 may have alternate design recommendations.
9. Board assembly site may have different recommendations for stencil design.

EXAMPLE BOARD LAYOUT

DGK0008A

™ VSSOP - 1.1 mm max height

SMALL OUTLINE PACKAGE



LAND PATTERN EXAMPLE
EXPOSED METAL SHOWN
SCALE: 15X

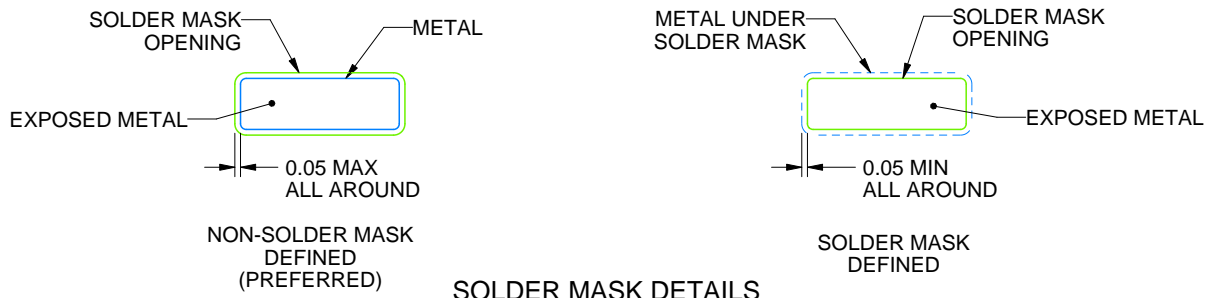

SOLDER MASK DETAILS

4214862/A 04/2023

NOTES: (continued)

6. Publication IPC-7351 may have alternate designs.
7. Solder mask tolerances between and around signal pads can vary based on board fabrication site.
8. Vias are optional depending on application, refer to device data sheet. If any vias are implemented, refer to their locations shown on this view. It is recommended that vias under paste be filled, plugged or tented.
9. Size of metal pad may vary due to creepage requirement.

EXAMPLE STENCIL DESIGN

DGK0008A

TM VSSOP - 1.1 mm max height

SMALL OUTLINE PACKAGE



SOLDER PASTE EXAMPLE
SCALE: 15X

4214862/A 04/2023

NOTES: (continued)

11. Laser cutting apertures with trapezoidal walls and rounded corners may offer better paste release. IPC-7525 may have alternate design recommendations.
12. Board assembly site may have different recommendations for stencil design.

DCK0006A



PACKAGE OUTLINE

SOT - 1.1 max height

SMALL OUTLINE TRANSISTOR

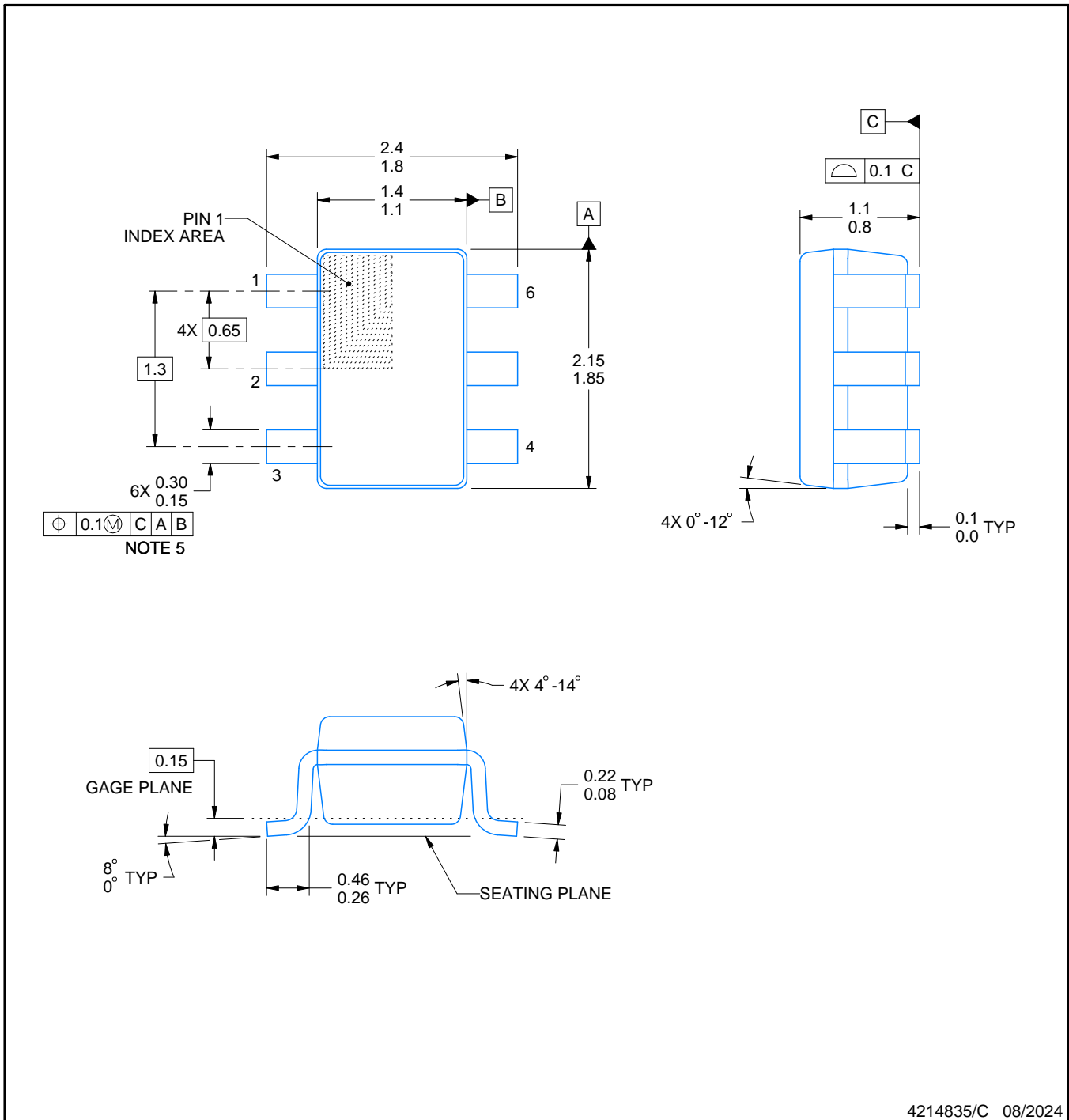

4214835/C 08/2024

NOTES:

1. All linear dimensions are in millimeters. Any dimensions in parenthesis are for reference only. Dimensioning and tolerancing per ASME Y14.5M.
2. This drawing is subject to change without notice.
3. Body dimensions do not include mold flash or protrusion. Mold flash and protrusion shall not exceed 0.15 per side.
4. Falls within JEDEC MO-203 variation AB.

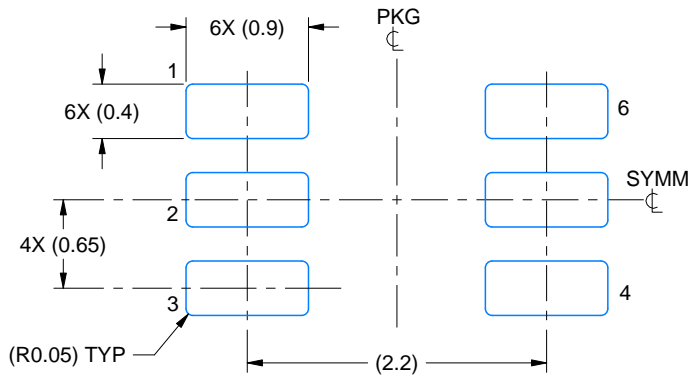

LAND PATTERN EXAMPLE
EXPOSED METAL SHOWN
SCALE:18X

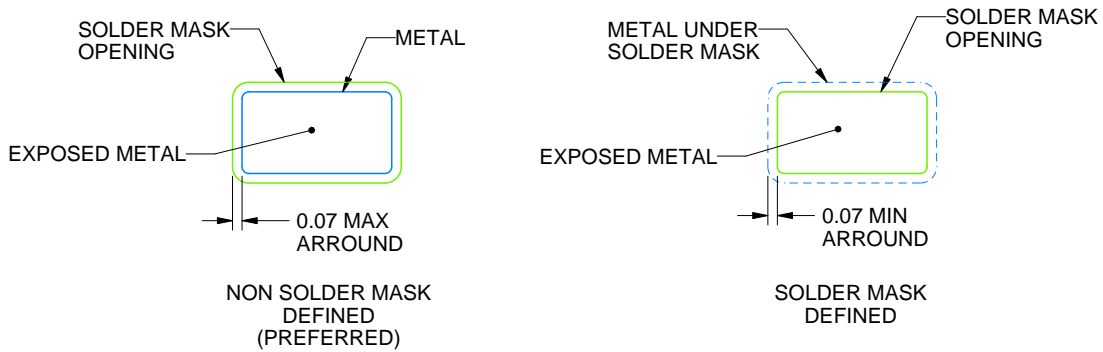

SOLDER MASK DETAILS

4214835/C 08/2024

NOTES: (continued)

- 5. Publication IPC-7351 may have alternate designs.
- 6. Solder mask tolerances between and around signal pads can vary based on board fabrication site.

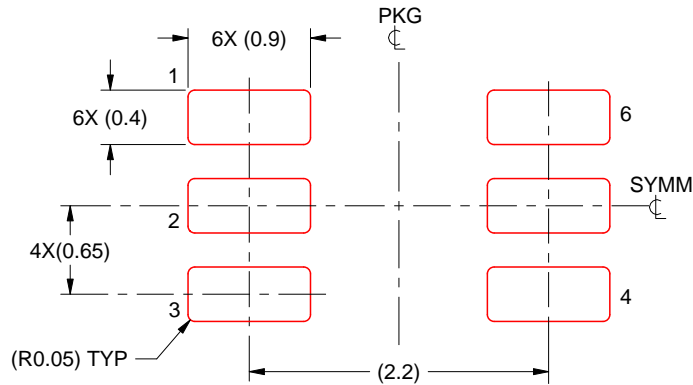

SOLDER PASTE EXAMPLE
BASED ON 0.125 THICK STENCIL
SCALE:18X

4214835/C 08/2024

NOTES: (continued)

7. Laser cutting apertures with trapezoidal walls and rounded corners may offer better paste release. IPC-7525 may have alternate design recommendations.
8. Board assembly site may have different recommendations for stencil design.

DCK0005A



PACKAGE OUTLINE

SOT - 1.1 max height

SMALL OUTLINE TRANSISTOR

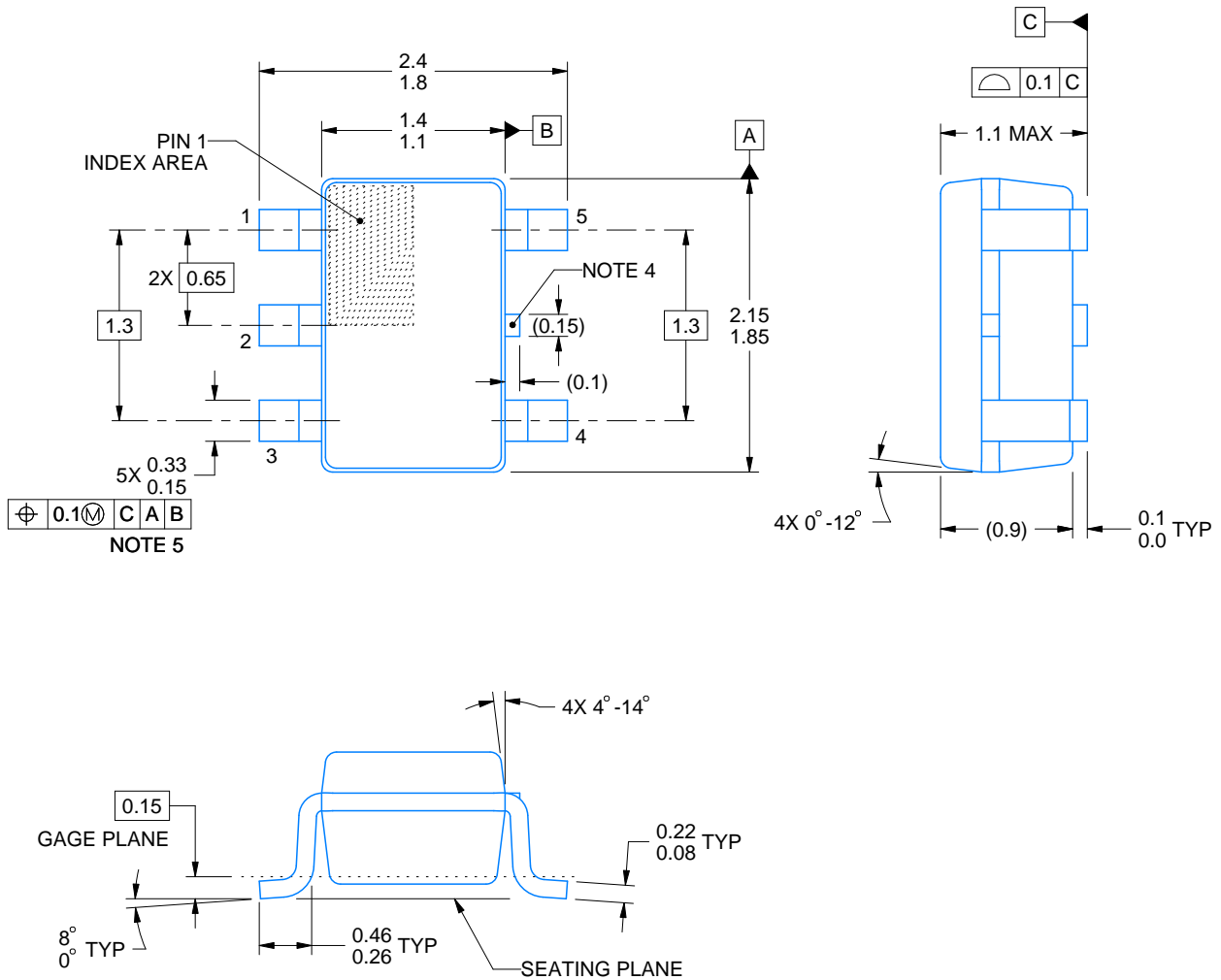

4214834/F 08/2024

NOTES:

1. All linear dimensions are in millimeters. Any dimensions in parenthesis are for reference only. Dimensioning and tolerancing per ASME Y14.5M.
2. This drawing is subject to change without notice.
3. Reference JEDEC MO-203.
4. Support pin may differ or may not be present.
5. Lead width does not comply with JEDEC.
6. Body dimensions do not include mold flash, protrusions, or gate burrs. Mold flash, protrusions, or gate burrs shall not exceed 0.25mm per side

EXAMPLE BOARD LAYOUT

DCK0005A

SOT - 1.1 max height

SMALL OUTLINE TRANSISTOR

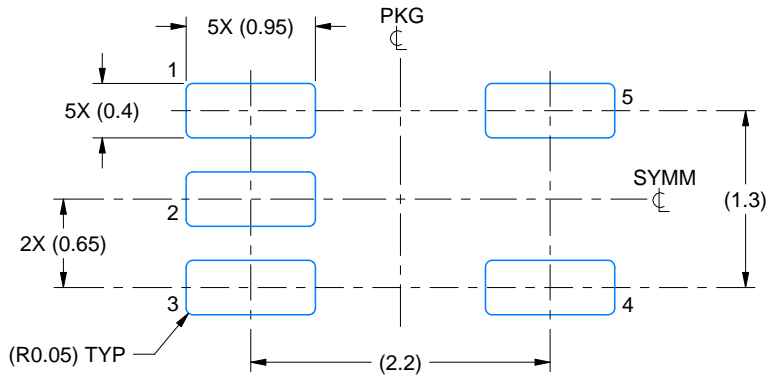

LAND PATTERN EXAMPLE
EXPOSED METAL SHOWN
SCALE:18X



SOLDER MASK DETAILS

4214834/F 08/2024

NOTES: (continued)

- 7. Publication IPC-7351 may have alternate designs.
- 8. Solder mask tolerances between and around signal pads can vary based on board fabrication site.

EXAMPLE STENCIL DESIGN

DCK0005A

SOT - 1.1 max height

SMALL OUTLINE TRANSISTOR



SOLDER PASTE EXAMPLE
BASED ON 0.125 THICK STENCIL
SCALE: 18X

4214834/F 08/2024

NOTES: (continued)

9. Laser cutting apertures with trapezoidal walls and rounded corners may offer better paste release. IPC-7525 may have alternate design recommendations.
10. Board assembly site may have different recommendations for stencil design.

重要なお知らせと免責事項

TI は、技術データと信頼性データ (データシートを含みます)、設計リソース (リファレンス・デザインを含みます)、アプリケーションや設計に関する各種アドバイス、Web ツール、安全性情報、その他のリソースを、欠陥が存在する可能性のある「現状のまま」提供しており、商品性および特定目的に対する適合性の黙示保証、第三者の知的財産権の非侵害保証を含むいかなる保証も、明示的または黙示的にかかわらず拒否します。

これらのリソースは、TI 製品を使用する設計の経験を積んだ開発者への提供を意図したものです。(1) お客様のアプリケーションに適した TI 製品の選定、(2) お客様のアプリケーションの設計、検証、試験、(3) お客様のアプリケーションに該当する各種規格や、その他のあらゆる安全性、セキュリティ、規制、または他の要件への確実な適合に関する責任を、お客様のみが単独で負うものとします。

上記の各種リソースは、予告なく変更される可能性があります。これらのリソースは、リソースで説明されている TI 製品を使用するアプリケーションの開発の目的でのみ、TI はその使用をお客様に許諾します。これらのリソースに関して、他の目的で複製することや掲載することは禁止されています。TI や第三者の知的財産権のライセンスが付与されている訳ではありません。お客様は、これらのリソースを自身で使用した結果発生するあらゆる申し立て、損害、費用、損失、責任について、TI およびその代理人を完全に補償するものとし、TI は一切の責任を拒否します。

TI の製品は、[TI の販売条件](#)、または [ti.com](#) やかかる TI 製品の関連資料などのいずれかを通じて提供する適用可能な条項の下で提供されています。TI がこれらのリソースを提供することは、適用される TI の保証または他の保証の放棄の拡大や変更を意味するものではありません。

お客様がいかなる追加条項または代替条項を提案した場合でも、TI はそれらに異議を唱え、拒否します。

郵送先住所 : Texas Instruments, Post Office Box 655303, Dallas, Texas 75265
Copyright © 2024, Texas Instruments Incorporated