

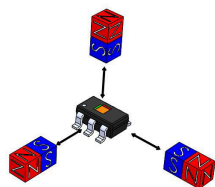
TMAG511x-Q1 2D、デュアルチャネル、高感度、ホール効果ラッチ

1 特長

- 下記内容で AEC-Q100 認定済み:
 - デバイス温度グレード 1: -40°C ~ +125°C の動作時周囲温度範囲
 - デバイス HBM ESD 分類レベル H3A
 - デバイス CDM ESD 分類レベル C6
- 平面型および垂直型ホール・センサによる 2D センシング
- 磁気整列とも磁極ピッチとも無関係な固有の直交性
- 2 つの機能を選択可能:
 - TMAG5110-Q1: 独立した 2D 出力
 - TMAG5111-Q1: 速度と方向の出力
- 非常に高い磁気感度:
 - TMAG511xx2-Q1: $\pm 1.4\text{mT}$ (標準値)
 - TMAG511xx4-Q1: $\pm 3\text{mT}$ (標準値)
- 高速な 40kHz センシング帯域幅
- 2.5V ~ 38V の V_{CC} 範囲で動作
- オープン・ドレイン出力 (10mA シンク)
- 広い動作時周囲温度範囲:
 - 40°C ~ +125°C
- 保護機能
 - 電源逆接続保護 (最大 -20V)
 - 最大 40V の電圧耐性
 - 出力短絡保護
 - 出力電流制限

2 アプリケーション

- インクリメンタル・ロータリー・エンコーダ
- 線速度および方向の制御
 - ルーフとトランクのモータ制御
 - 窓とドアのモータ制御
- 角度位置検出
 - ノブ制御 (ラジオ、エアコン)
 - 電動パワー・ステアリング
 - 流量測定
- 角速度および方向
 - 電気ポンプ
 - 換気扇
 - ホイールとモータの速度



デバイス軸の極性

3 概要

TMAG5110-Q1 と TMAG5111-Q1 は、2.5V ~ 38V の電源で動作する 2 次元のデュアル・ホール・エフェクト・ラッチです。

高速高温のモーター・アプリケーション向けに設計されたこれらのデバイスは、回転する磁石を利用したアプリケーションに最適化されています。2 つのセンサと 2 つの独立した信号チェーンを統合した TMAG511x-Q1 は、2 つの独立したデジタル出力を備えており、速度と方向の計算値を出力し (TMAG5111-Q1)、または独立した各ラッチのデジタル信号を直接出力します (TMAG5110-Q1)。デバイスが高集積なので、2 つの独立したラッチを使わなくても、TMAG511x-Q1 デバイス 1 つだけで済みます。

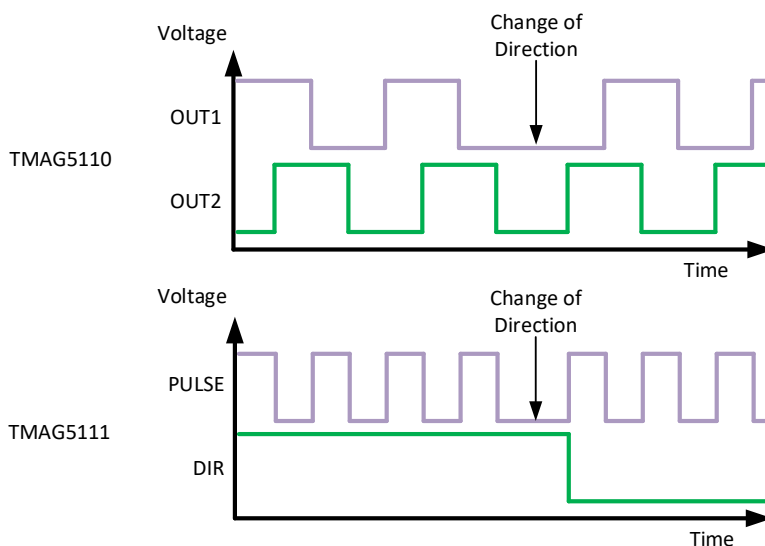
このデバイスは、動作点 3mT の標準品と動作点 1.4mT の高感度品として提供しています。磁気感度が高いため、低コストの磁石を柔軟に選択し、機械的部品を柔軟に配置できます。また TMAG511x-Q1 では、磁石に対してセンサを柔軟に配置できるように 3 種類の 2 軸組み合わせ (X-Y、Z-X、Z-Y) を選択できます。

このデバイスは、-40°C ~ +125°C の広い周囲温度範囲で確実に動作します。

製品情報

部品番号	パッケージ ⁽¹⁾	本体サイズ (公称)
TMAG5110-Q1	SOT-23 (5)	2.9mm × 1.6mm
TMAG5111-Q1		

- (1) 提供されているすべてのパッケージについては、データシートの末尾にあるパッケージ・オプションについての付録を参照してください。



デバイス出力



Table of Contents

1 特長	1	8.3 Feature Description.....	21
2 アプリケーション	1	8.4 Device Functional Modes.....	30
3 概要	1	9 Application and Implementation	31
4 Revision History	2	9.1 Application Information.....	31
5 Device Comparison	3	9.2 Typical Applications.....	31
6 Pin Configuration and Functions	4	10 Power Supply Recommendations	33
7 Specifications	5	11 Layout	33
7.1 Absolute Maximum Ratings	5	11.1 Layout Guidelines.....	33
7.2 ESD Ratings	5	11.2 Layout Example.....	33
7.3 Recommended Operating Conditions	5	12 Device and Documentation Support	34
7.4 Thermal Information	5	12.1 Receiving Notification of Documentation Updates..	34
7.5 Electrical Characteristics	6	12.2 サポート・リソース.....	34
7.6 Magnetic Characteristics	6	12.3 Trademarks.....	34
7.7 Typical Characteristics.....	7	12.4 Electrostatic Discharge Caution.....	34
8 Detailed Description	21	12.5 Glossary.....	34
8.1 Overview.....	21	13 Mechanical, Packaging, and Orderable Information	34
8.2 Functional Block Diagram.....	21		

4 Revision History

資料番号末尾の英字は改訂を表しています。その改訂履歴は英語版に準じています。

Changes from Revision A (September 2021) to Revision B (June 2022)	Page
• Changed <i>Layout Example</i>	33

Changes from Revision * (July 2021) to Revision A (September 2021)	Page
• Removed the preview notes from the <i>Device Comparison</i> table.....	3
• Added operating supply current for the TMAG511xx4-Q1.....	6
• Added graphs to the <i>Typical Characteristics</i> section.....	7

5 Device Comparison

表 5-1. Device Comparison

DEVICE	DEVICE OPTION	SENSITIVITY (BOP TYP)	AXIS OF SENSITIVITY	OUT1	OUT2
TMAG5110-Q1	A2	1.4 mT	XY	X	Y
	A4	3 mT			
	B2	1.4 mT	ZX	Z	X
	B4	3 mT			
	C2	1.4 mT	ZY	Z	Y
	C4	3 mT			
TMAG5111-Q1	A2	1.4 mT	XY	Speed	Direction
	A4	3 mT			
	B2	1.4 mT	ZX		
	B4	3 mT			
	C2	1.4 mT	ZY		
	C4	3 mT			

6 Pin Configuration and Functions

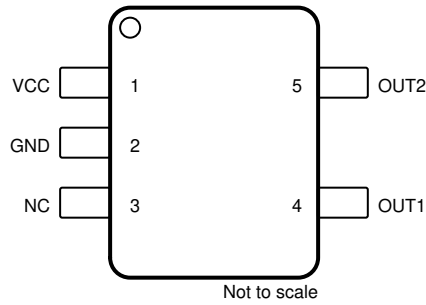


图 6-1. DBV Package 5-Pin SOT-23 Top View

表 6-1. Pin Functions

PIN		TYPE	DESCRIPTION
NO.	NAME		
1	V _{CC}	Power supply	2.5-V to 38-V power supply. Connect a ceramic capacitor with a value of at least 0.01 μF between V _{CC} and ground.
2	GND	Ground	Ground reference.
3	NC	—	Not internally connected. Connection to the ground pin is recommended.
4	OUT1	Output	Open-drain output 1. For TMAG5110A-Q1: X axis. For TMAG5110B-Q1: Z axis. For TMAG5110C-Q1: Z axis. For TMAG5111-Q1: Speed.
5	OUT2	Output	Open-drain output 2. For TMAG5110A-Q1: Y axis. For TMAG5110B-Q1: X axis. For TMAG5110C-Q1: Y axis. For TMAG5111-Q1: Direction.

7 Specifications

7.1 Absolute Maximum Ratings

over operating free-air temperature range (unless otherwise noted)⁽¹⁾

		MIN	MAX	UNIT
Power Supply Voltage	V _{CC}	-20	40	V
	Voltage ramp rate (V _{CC} < 5V)	Unlimited		V/μs
	Voltage ramp rate (V _{CC} > 5V)	0	2	
Output Pin Voltage	V _{OUT1} , V _{OUT2}	GND – 0.5	40	V
Output pin reverse current during reverse supply condition		0	100	mA
Magnetic flux density, B _{MAX}		Unlimited		T
Junction temperature, T _J	Junction temperature, T _J	-40	150	°C
Storage temperature, T _{stg}		-65	150	°C

- (1) Stresses beyond those listed under *Absolute Maximum Rating* may cause permanent damage to the device. These are stress ratings only, which do not imply functional operation of the device at these or any other conditions beyond those indicated under *Recommended Operating Condition*. Exposure to absolute-maximum-rated conditions for extended periods may affect device reliability.

7.2 ESD Ratings

			VALUE	UNIT
V _(ESD)	Electrostatic discharge	Human body model (HBM), per AEC Q100-002 ⁽¹⁾ HBM ESD Classification Level 2	±2000	V
		Charged device model (CDM), per AEC Q100-011 CDM ESD Classification Level C4A	± 500	V

- (1) AECQ 100-002 indicates that HBM stressing shall be in accordance with the ANSI/ESDA/JEDEC JS-001 specification.

7.3 Recommended Operating Conditions

over operating free-air temperature range (unless otherwise noted)

		MIN	MAX	UNIT
V _{CC}	Power supply voltage	2.5	38	V
VO	Output pin voltage (OUT1, OUT2)	0	38	V
ISINK	Output pin current sink (OUT1, OUT2) ⁽¹⁾	0	10	mA
T _A	Ambient temperature	-40	125	°C

- (1) Power dissipation and thermal limits must be observed

7.4 Thermal Information

THERMAL METRIC ⁽¹⁾		TMAG5110	UNIT
		DBV (SOT-23)	
		5 PINS	
R _{θJA}	Junction-to-ambient thermal resistance	166.5	°C/W
R _{θJC(top)}	Junction-to-case (top) thermal resistance	86.0	
R _{θJB}	Junction-to-board thermal resistance	37.6	
Ψ _{JT}	Junction-to-top characterization parameter	14.1	
Ψ _{JB}	Junction-to-board characterization parameter	37.3	
R _{θJC(bot)}	Junction-to-case (bottom) thermal resistance	—	°C/W

- (1) For more information about traditional and new thermal metrics, see the [Semiconductor and IC Package Thermal Metrics](#) application report.

7.5 Electrical Characteristics

over operating free-air temperature range (unless otherwise noted)

PARAMETER		TEST CONDITIONS	MIN	TYP	MAX	UNIT
POWER SUPPLY						
I_{CC}	Operating supply current for TMAG511xx2-Q1	$V_{CC} = 2.5\text{ V to }38\text{ V}$, $T_A = -40^\circ\text{C to }125^\circ\text{C}$		6	8	mA
I_{CC}	Operating supply current for TMAG511xx4-Q1	$V_{CC} = 2.5\text{ V to }38\text{ V}$, $T_A = -40^\circ\text{C to }125^\circ\text{C}$		6	8.5	mA
I_{RCC}	Reverse-battery current	$V_{CC} = -20\text{ V}$	-100			μA
t_{ON}	Power-on-time			52.5		μs
OUTPUT						
V_{OL}	Low-level output voltage	$I_{OL} = 10\text{mA}$	0		0.5	V
I_{OH}	Output leakage current	$V_{CC} = 5\text{V}$		0.1	1	μA
I_{SC}	Output short-circuit current			65	110	mA
t_{PD}	Propagation delay time	Change in B_{OP} or B_{RP} to change in output		12.5		μs
t_R	Output rise time	$R_L = 1\text{k}\Omega$, $C_L = 50\text{pF}$		0.2		
t_F	Output fall time	$R_L = 1\text{k}\Omega$, $C_L = 50\text{pF}$		0.2		
FREQUENCY RESPONSE						
f_{CHOP}	Chopping frequency			320		kHz
f_{BW}	Signal bandwidth			40		kHz

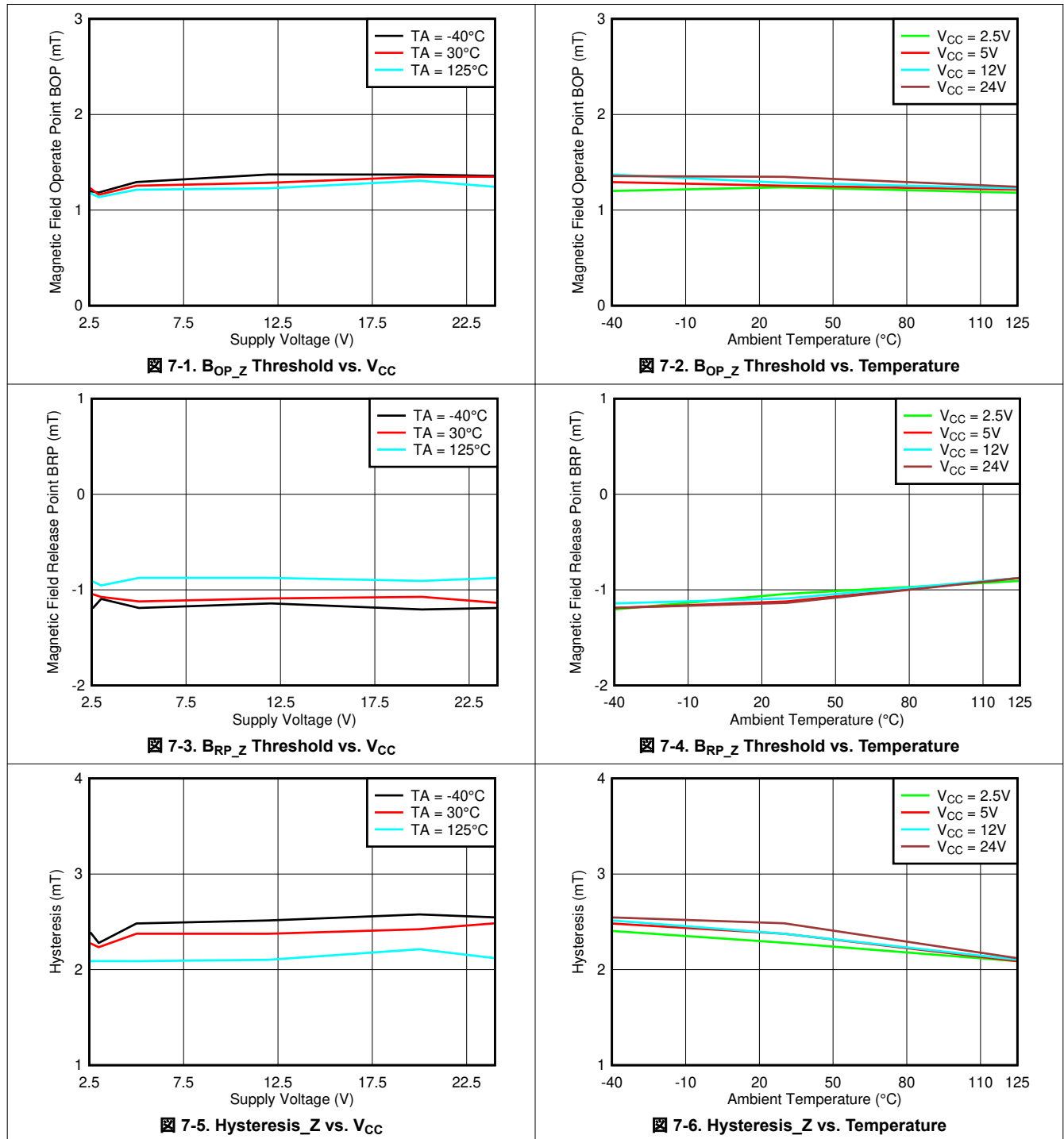
7.6 Magnetic Characteristics

over operating free-air temperature range (unless otherwise noted)

PARAMETER		TEST CONDITIONS	MIN	TYP	MAX	UNIT
TMAG5110x2-Q1						
$B_{OP(1)}, B_{OP(2)}$	Magnetic field operating point	$V_{CC} = 2.5\text{ V to }38\text{ V}$, $T_A = -40^\circ\text{C to }125^\circ\text{C}$	0.2	1.4	2.6	mT
$B_{RP(1)}, B_{RP(2)}$	Magnetic field release point		-2.6	-1.4	-0.2	
$B_{HYS(1)}, B_{HYS(2)}$	Magnetic hysteresis $B_{OP} - B_{RP}$		0.9	2.75	4.6	
$B_{SYM(1)}, B_{SYM(2)}$	Symmetry	$B_{OP(1)} + B_{RP(1)}, B_{OP(2)} + B_{RP(2)}$	-2		2	mT
B_{SYM_OP}	Operating point symmetry	$B_{OP(1)} - B_{OP(2)}$	-1.5		1.5	
B_{SYM_RP}	Release point symmetry	$B_{RP(1)} - B_{RP(2)}$	-1.5		1.5	
TMAG5110x4-Q1						
$B_{OP(1)}, B_{OP(2)}$	Magnetic field operating point	$V_{CC} = 2.5\text{ V to }38\text{ V}$, $T_A = -40^\circ\text{C to }125^\circ\text{C}$	0.8	3	5.3	mT
$B_{RP(1)}, B_{RP(2)}$	Magnetic field release point		-5.3	-3	-0.8	
$B_{HYS(1)}, B_{HYS(2)}$	Magnetic hysteresis $B_{OP} - B_{RP}$		3	6	9	
$B_{SYM(1)}, B_{SYM(2)}$	Symmetry	$B_{OP(1)} + B_{RP(1)}, B_{OP(2)} + B_{RP(2)}$	-2		2	mT
B_{SYM_OP}	Operating point symmetry	$B_{OP(1)} - B_{OP(2)}$	-1.5		1.5	
B_{SYM_RP}	Release point symmetry	$B_{RP(1)} - B_{RP(2)}$	-1.5		1.5	

7.7 Typical Characteristics

TMAG511xx2-Q1 versions



7.7 Typical Characteristics (continued)

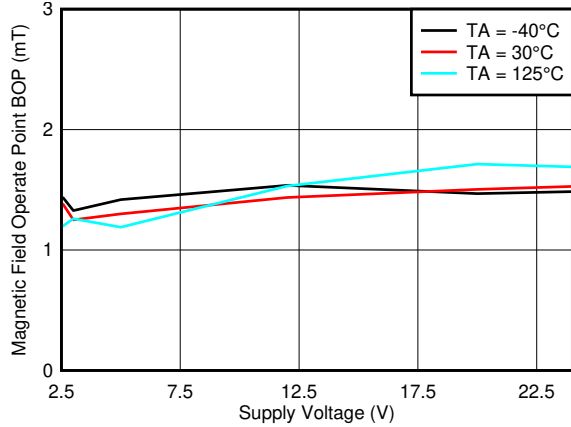


Figure 7-7. B_{OP_X} Threshold vs. V_{CC}

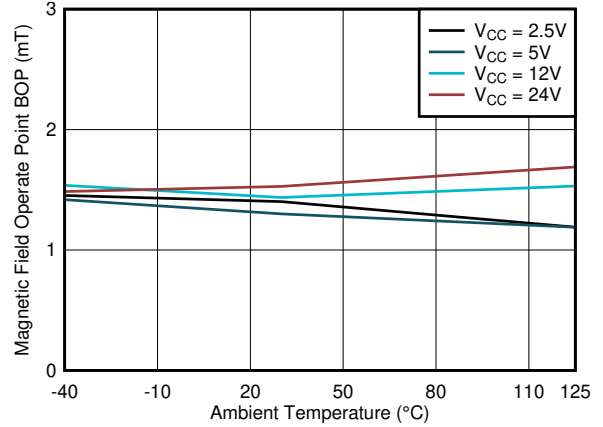


Figure 7-8. B_{OP_X} Threshold vs. Temperature

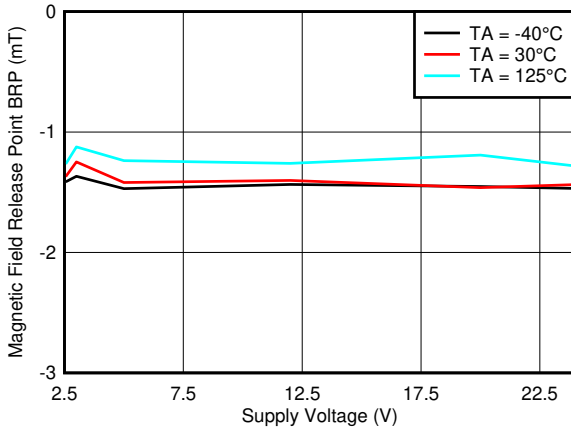


Figure 7-9. B_{RP_X} Threshold vs. V_{CC}

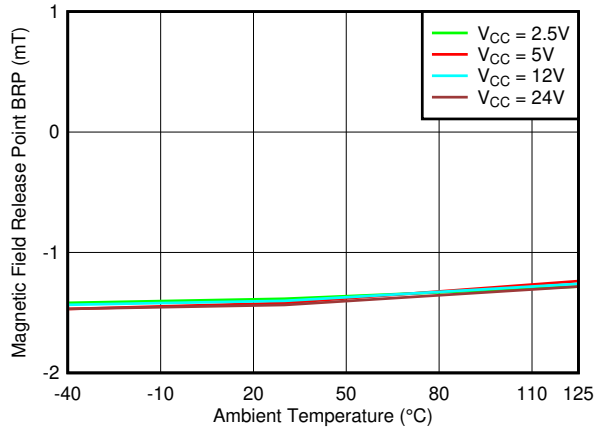


Figure 7-10. B_{RP_X} Threshold vs. Temperature

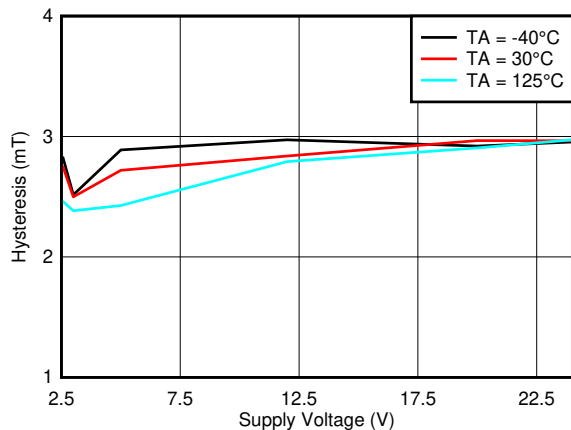


Figure 7-11. Hysteresis_X vs. V_{CC}

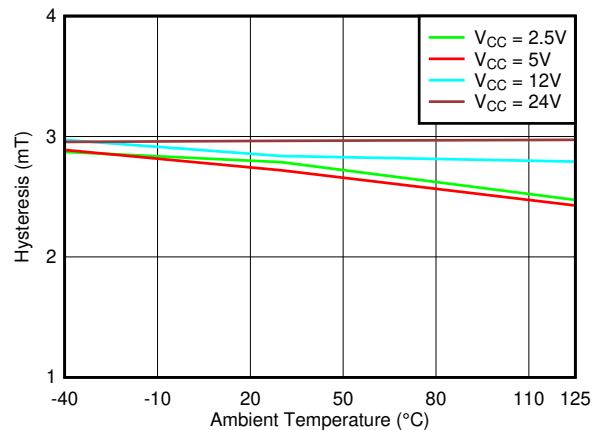
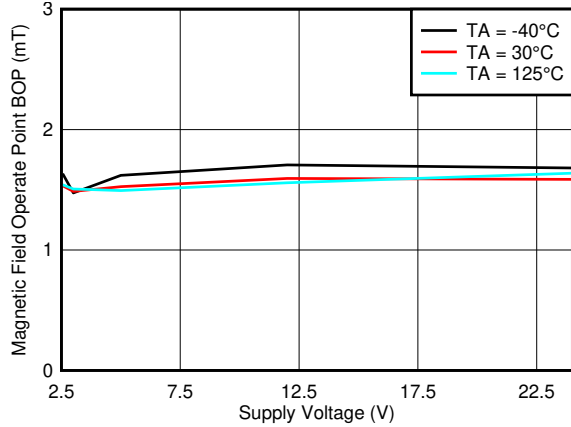
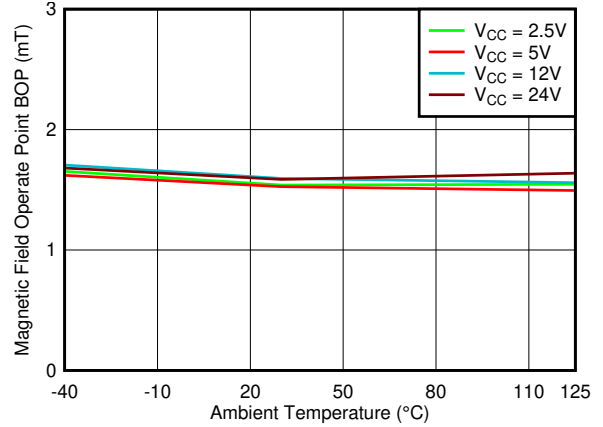


Figure 7-12. Hysteresis_X vs. Temperature

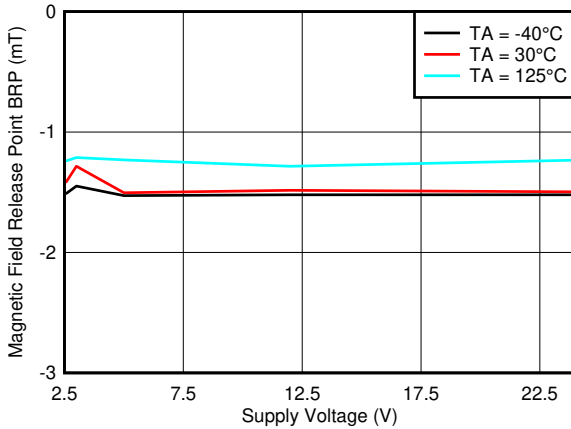
7.7 Typical Characteristics (continued)



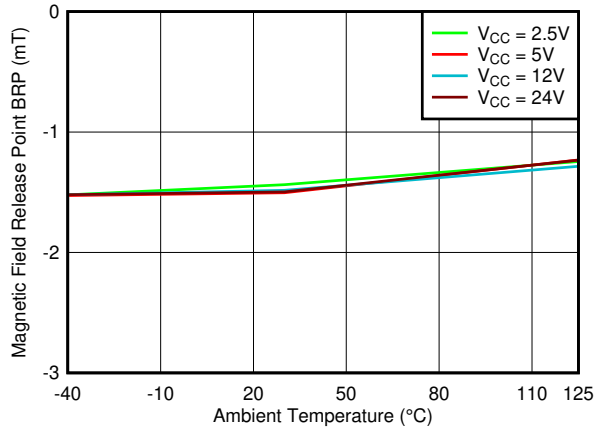
7-13. BOP_Y Threshold vs. VCC



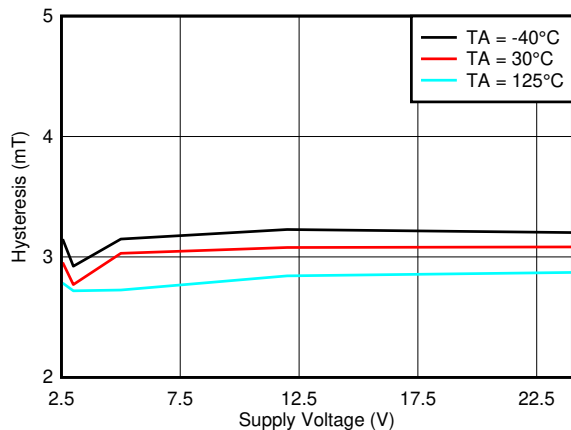
7-14. BOP_Y Threshold vs. Temperature



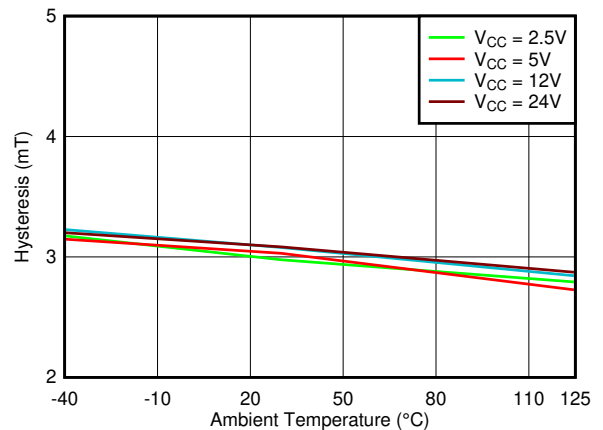
7-15. BRP_Y Threshold vs. VCC



7-16. BRP_Y Threshold vs. Temperature



7-17. Hysteresis_Y vs. VCC



7-18. Hysteresis_Y vs. Temperature

7.7 Typical Characteristics (continued)

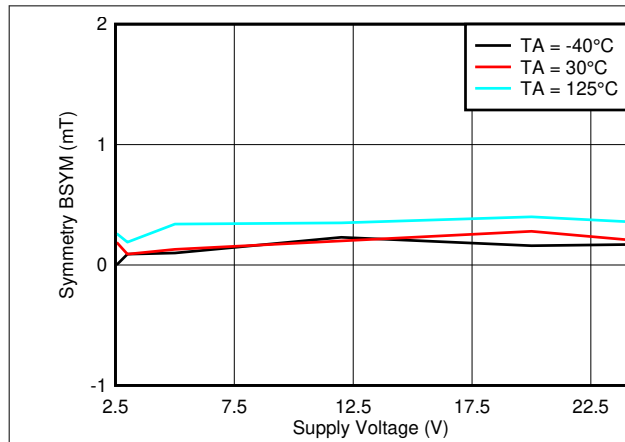


图 7-19. $B_{SYM(Z)}$ vs. V_{CC}

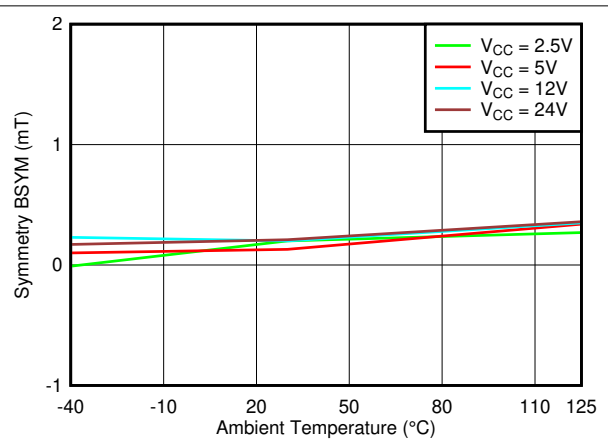


图 7-20. $B_{SYM(Z)}$ vs. Temperature

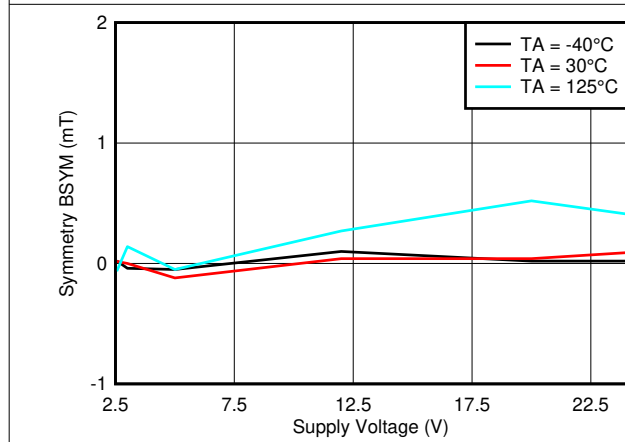


图 7-21. $B_{SYM(X)}$ vs. V_{CC}

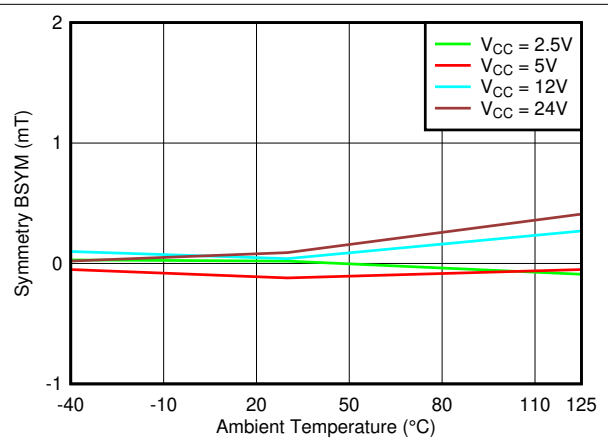


图 7-22. $B_{SYM(X)}$ vs. Temperature

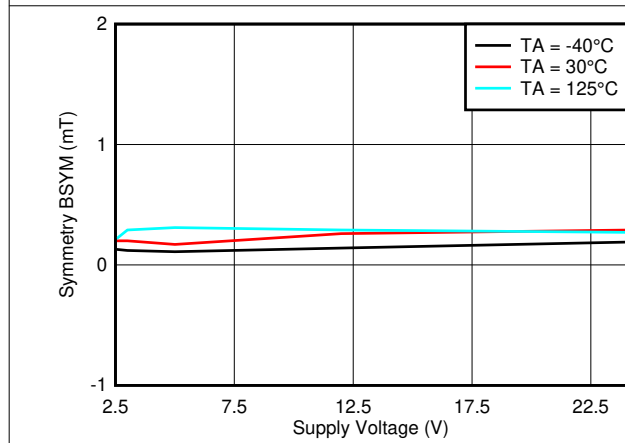


图 7-23. $B_{SYM(Y)}$ vs. V_{CC}

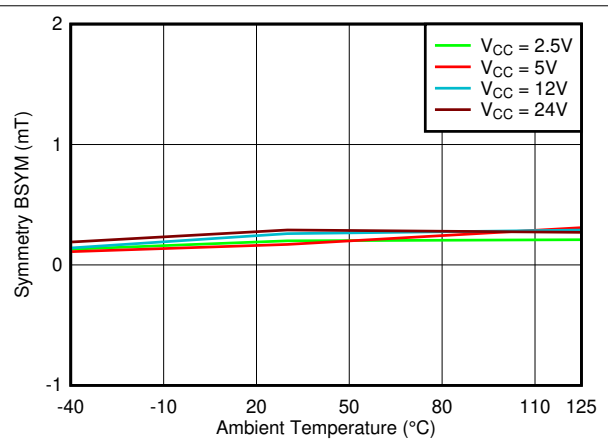


图 7-24. $B_{SYM(Y)}$ vs. Temperature

7.7 Typical Characteristics (continued)

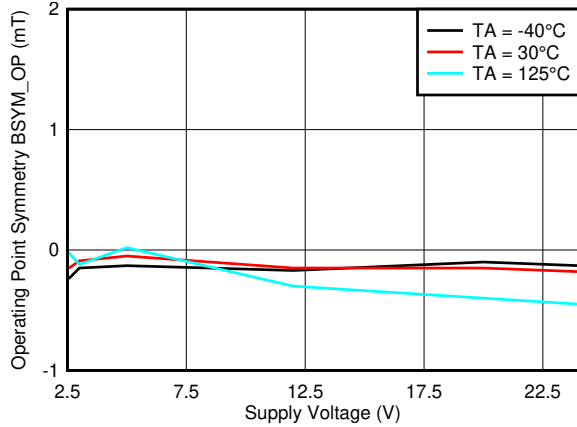


Figure 7-25. $B_{SYM_OP(ZX)}$ vs. V_{CC}

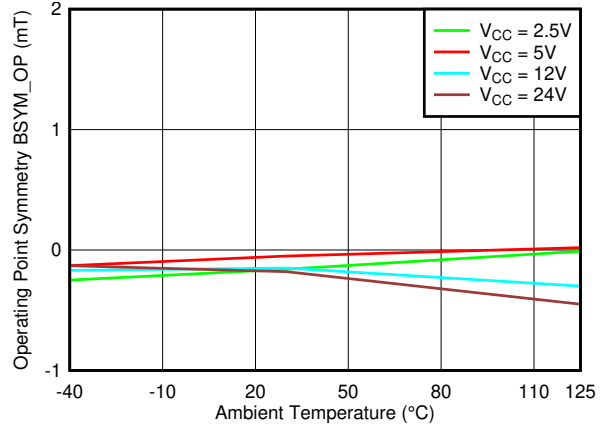


Figure 7-26. $B_{SYM_OP(ZX)}$ vs. Temperature

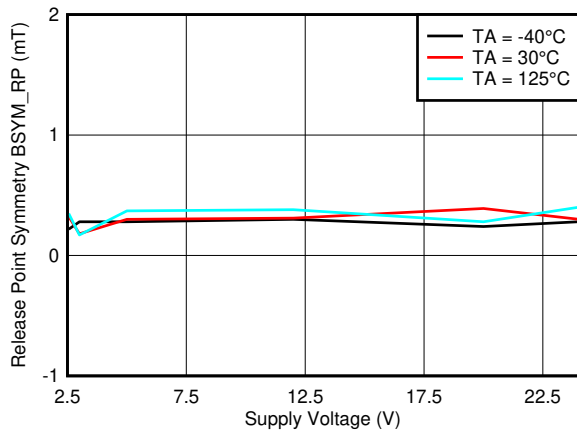


Figure 7-27. $B_{SYM_RP(ZX)}$ vs. V_{CC}

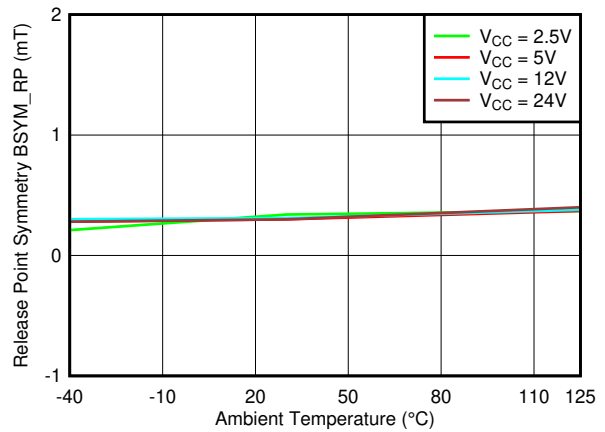


Figure 7-28. $B_{SYM_RP(ZX)}$ vs. Temperature

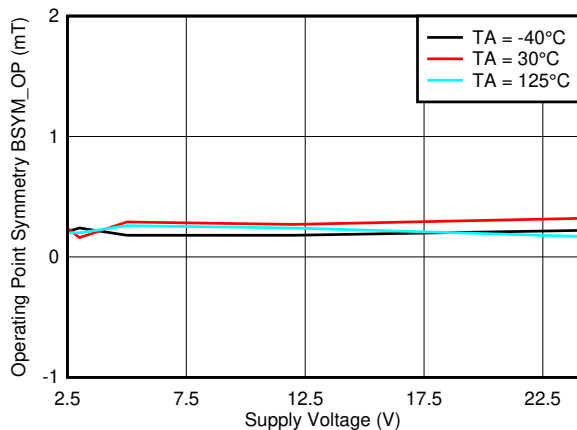


Figure 7-29. $B_{SYM_OP(ZY)}$ vs. V_{CC}

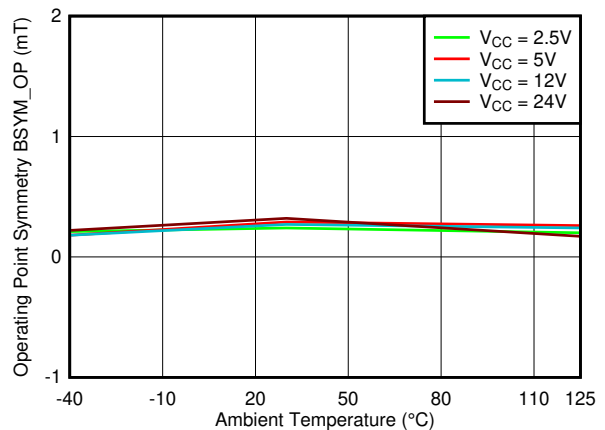
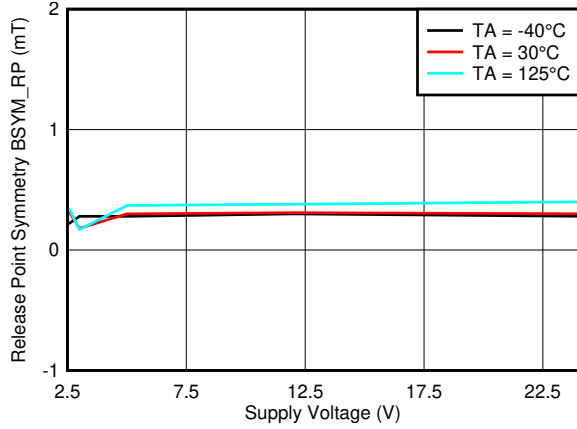
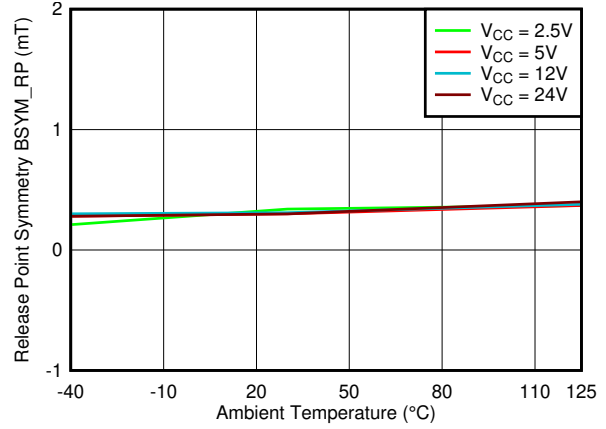


Figure 7-30. $B_{SYM_OP(ZY)}$ vs. Temperature

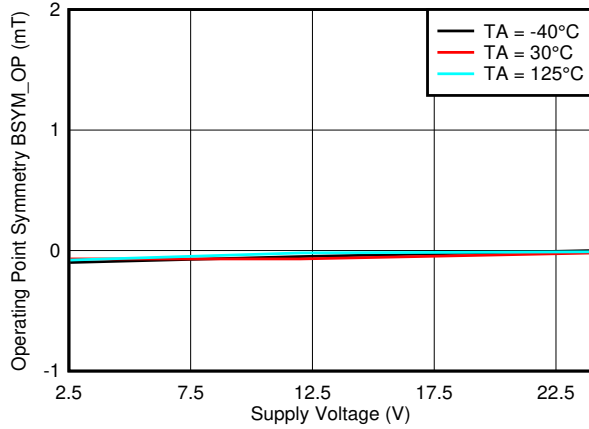
7.7 Typical Characteristics



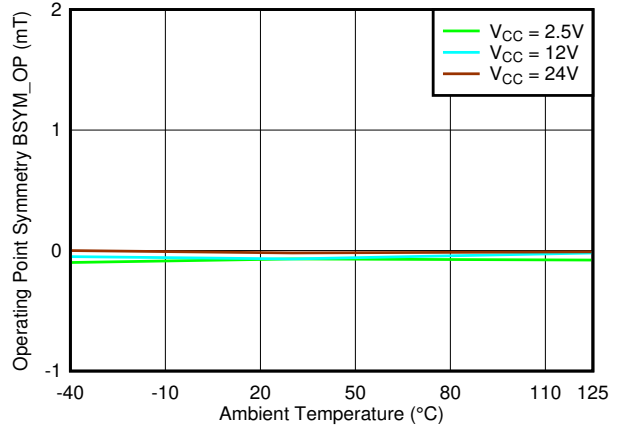
7-31. $B_{SYM_RP(ZY)}$ vs. V_{CC}



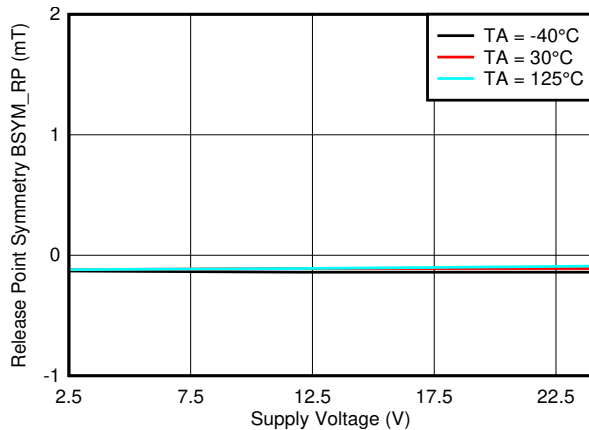
7-32. $B_{SYM_RP(ZY)}$ vs. Temperature



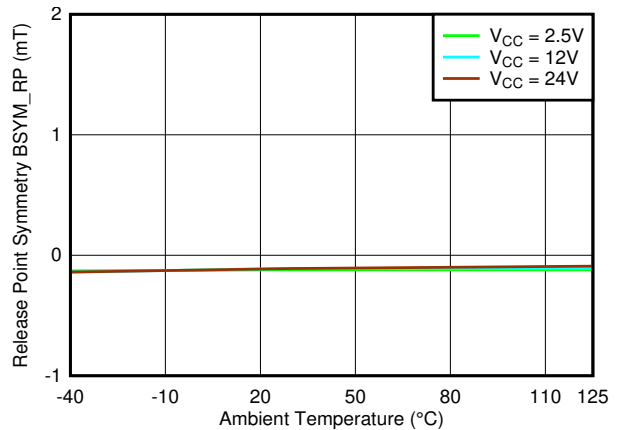
7-33. $B_{SYM_OP(XY)}$ vs. V_{CC}



7-34. $B_{SYM_OP(XY)}$ vs. Temperature

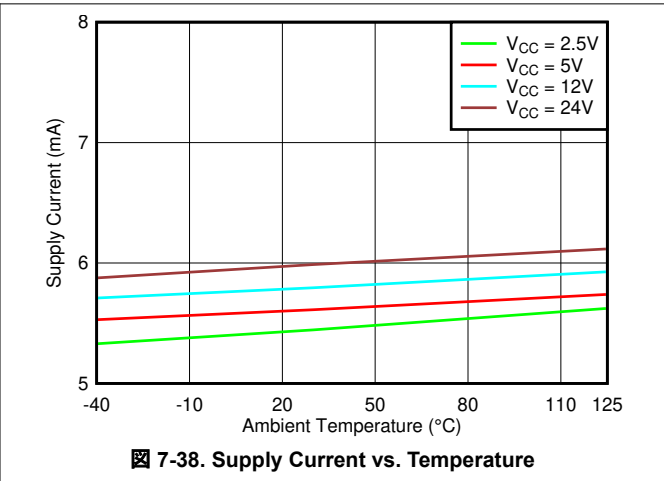
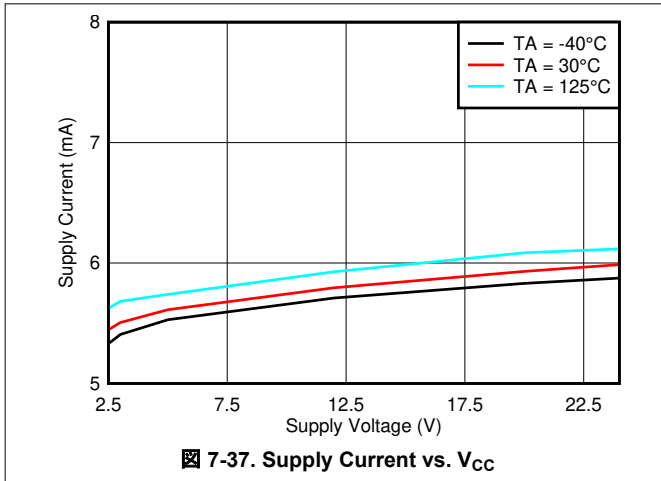


7-35. $B_{SYM_RP(XY)}$ vs. V_{CC}



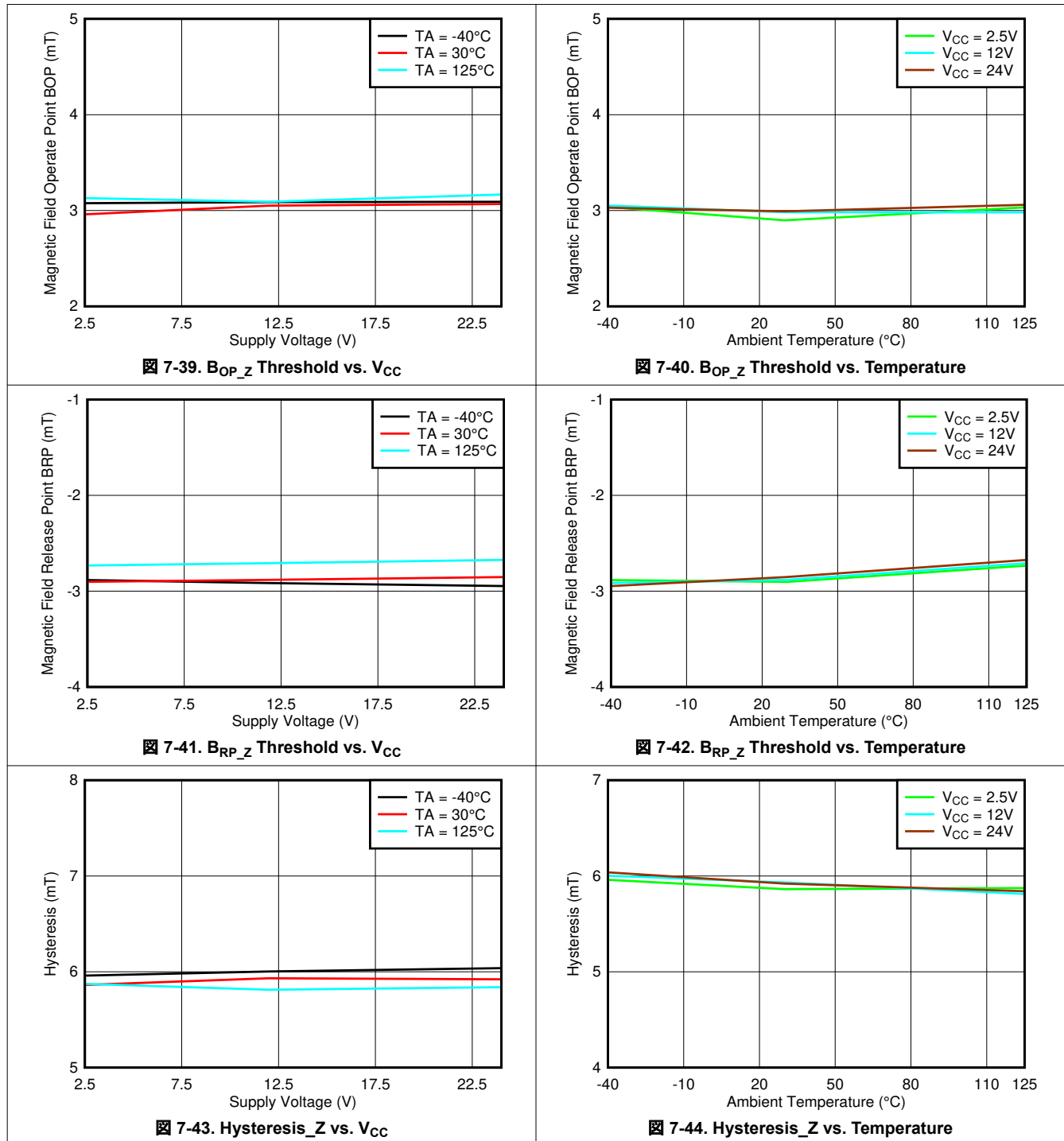
7-36. $B_{SYM_RP(XY)}$ vs. Temperature

7.7 Typical Characteristics (continued)



7.7 Typical Characteristics

TMAG511xx4-Q1 versions



7.7 Typical Characteristics (continued)

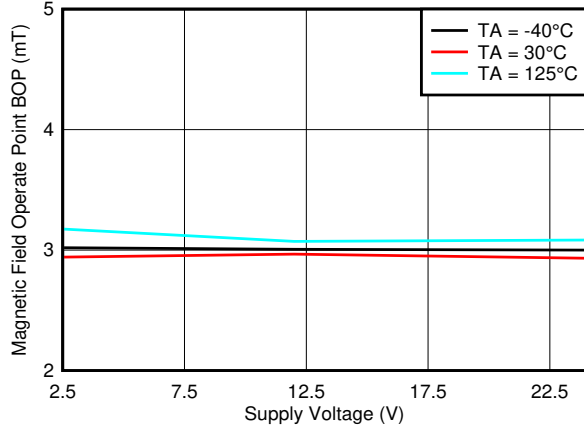


图 7-45. BOP_X Threshold vs. VCC

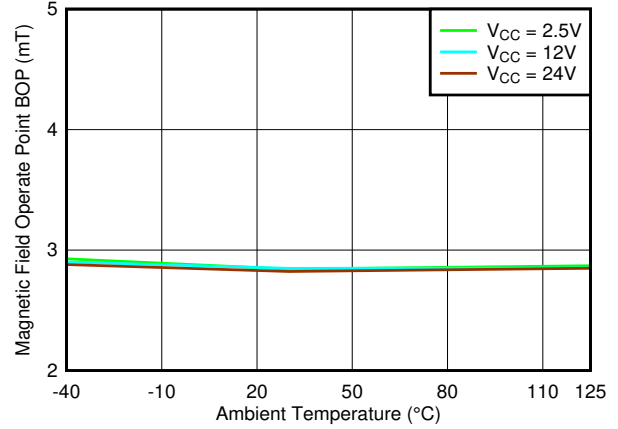


图 7-46. BOP_X Threshold vs. Temperature

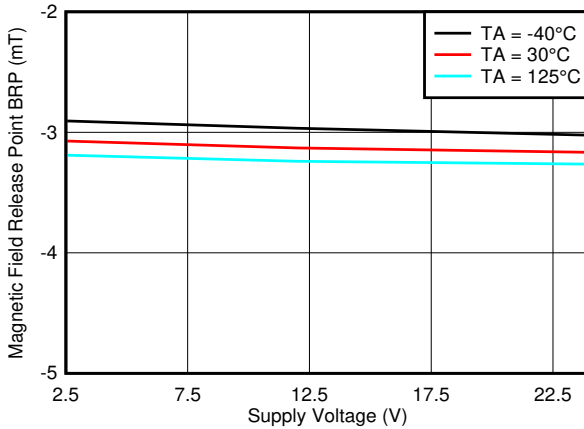


图 7-47. BRP_X Threshold vs. VCC

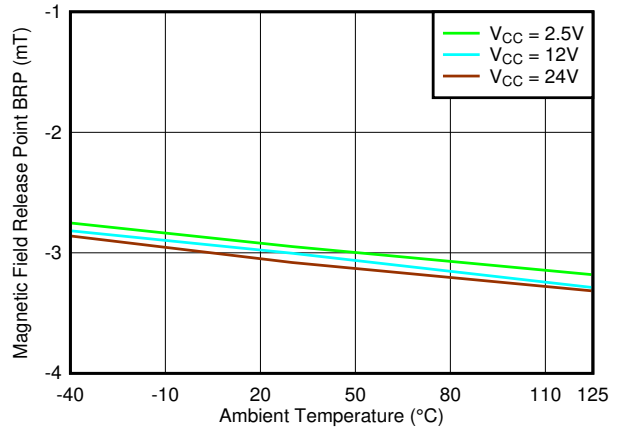


图 7-48. BRP_X Threshold vs. Temperature

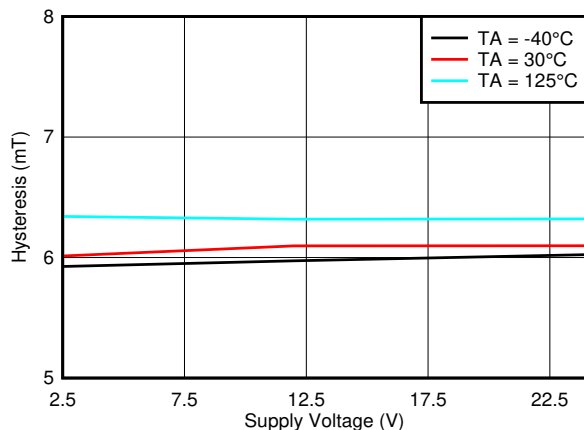


图 7-49. Hysteresis_X vs. VCC

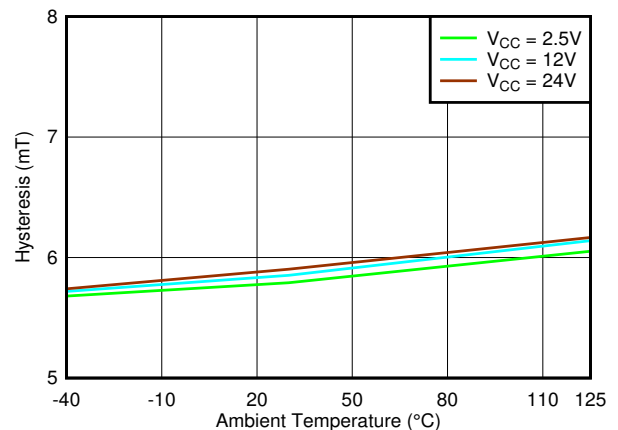


图 7-50. Hysteresis_X vs. Temperature

7.7 Typical Characteristics (continued)

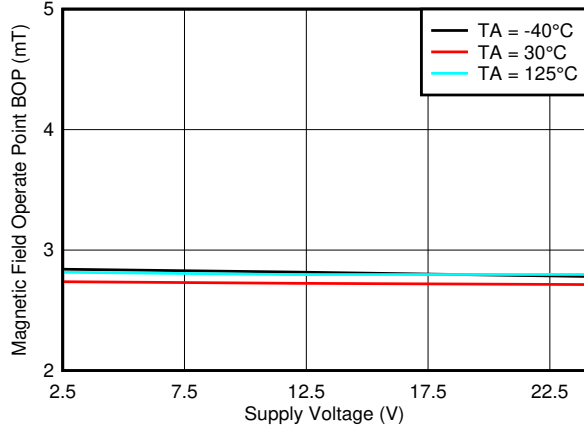


图 7-51. BOP_Y Threshold vs. VCC

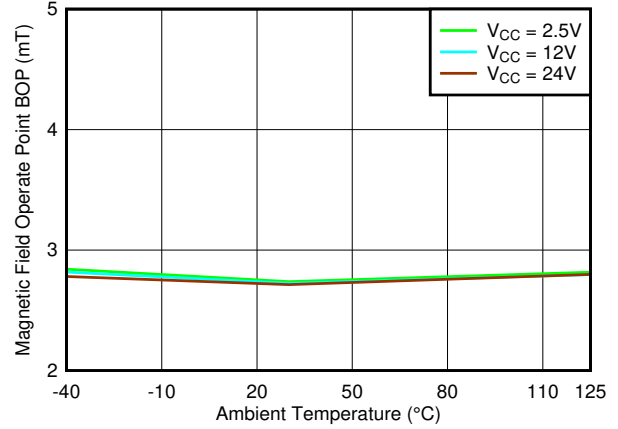


图 7-52. BOP_Y Threshold vs. Temperature

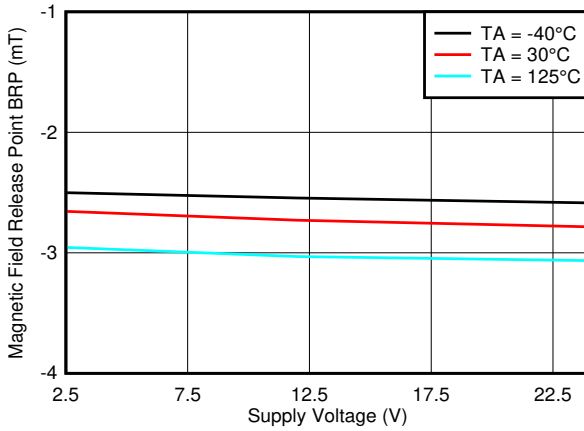


图 7-53. BRP_Y Threshold vs. VCC

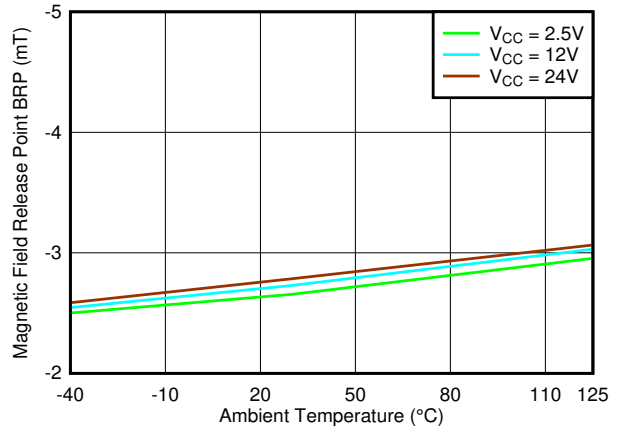


图 7-54. BRP_Y Threshold vs. Temperature

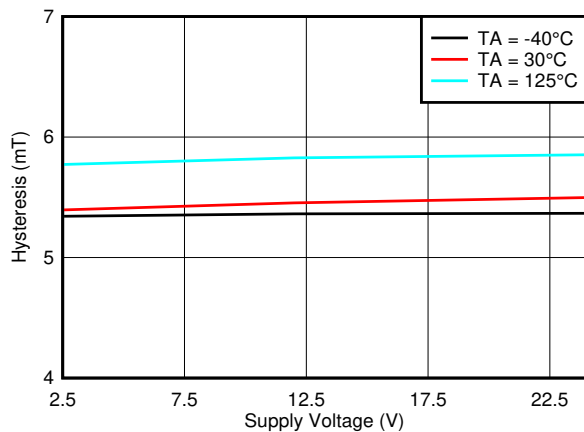


图 7-55. Hysteresis_Y vs. VCC

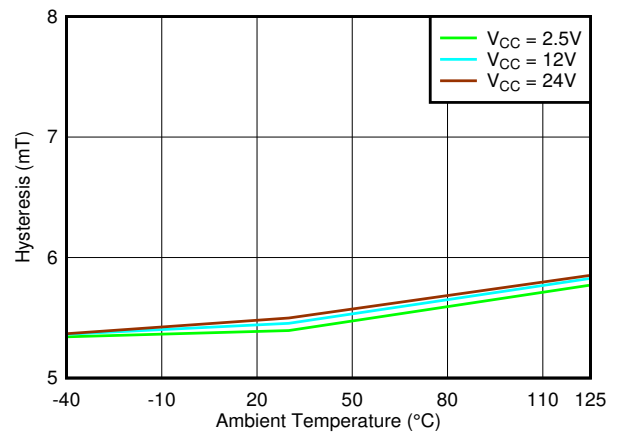


图 7-56. Hysteresis_Y vs. Temperature

7.7 Typical Characteristics (continued)

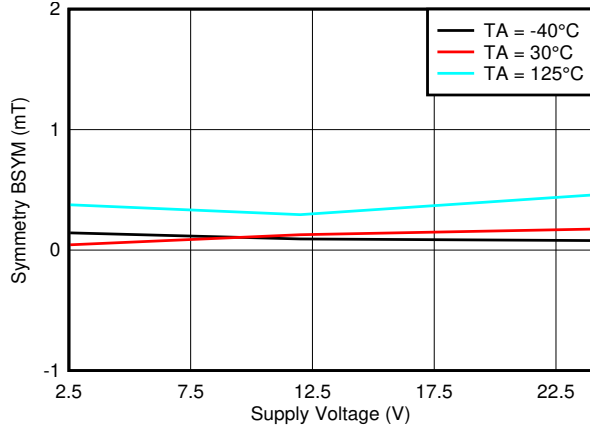


图 7-57. $B_{SYM}(Z)$ vs. V_{CC}

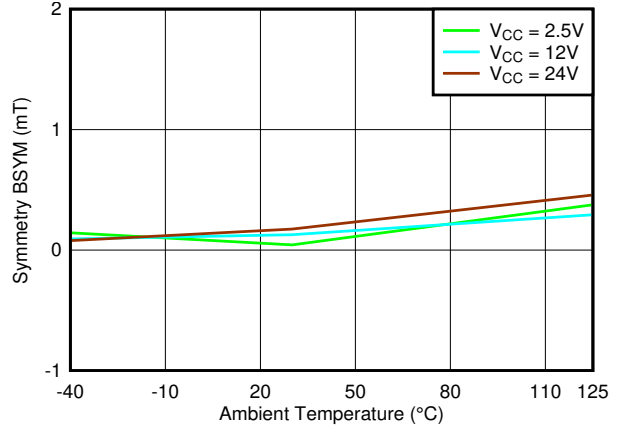


图 7-58. $B_{SYM}(Z)$ vs. Temperature

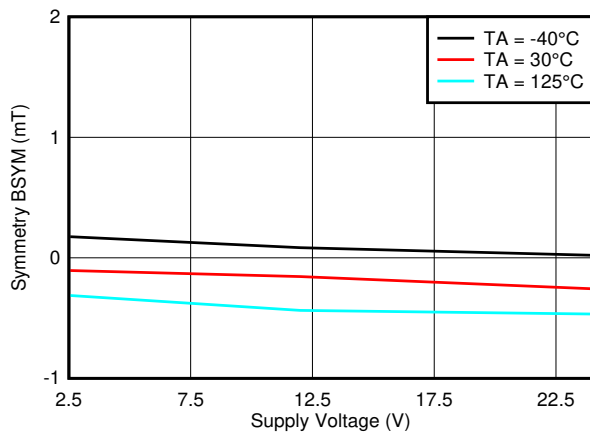


图 7-59. $B_{SYM}(X)$ vs. V_{CC}

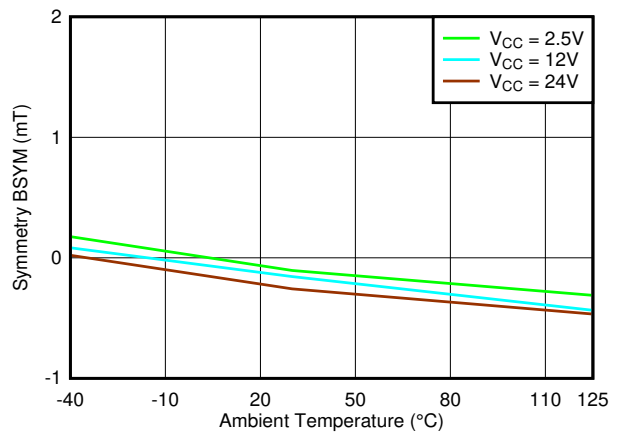


图 7-60. $B_{SYM}(X)$ vs. Temperature

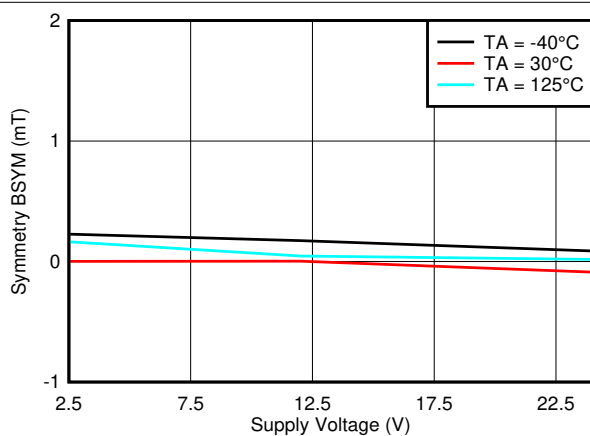


图 7-61. $B_{SYM}(Y)$ vs. V_{CC}

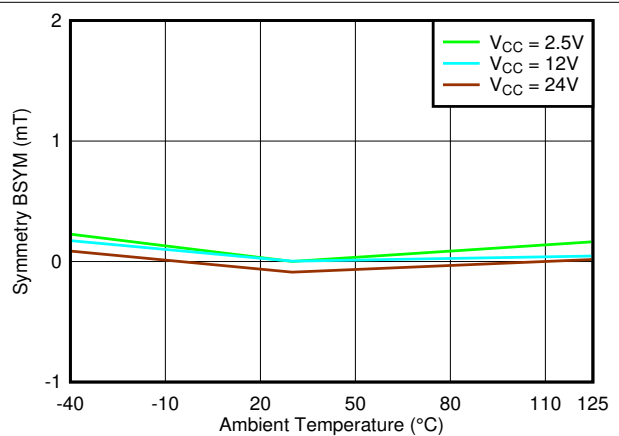
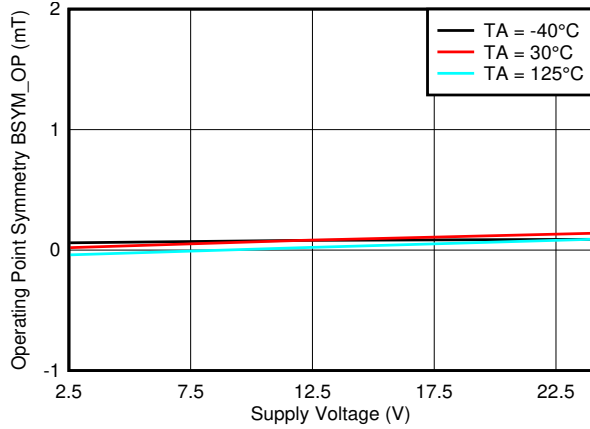
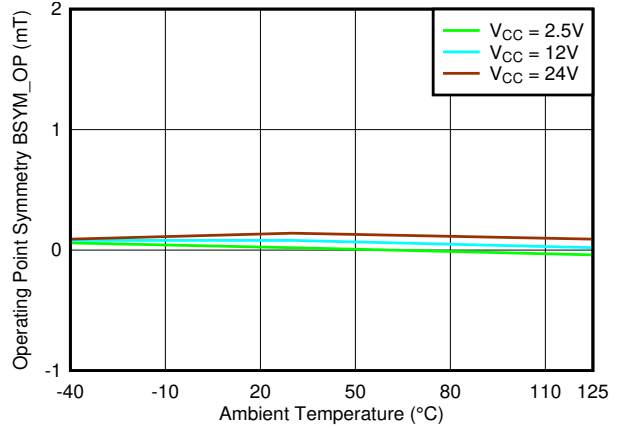


图 7-62. $B_{SYM}(Y)$ vs. Temperature

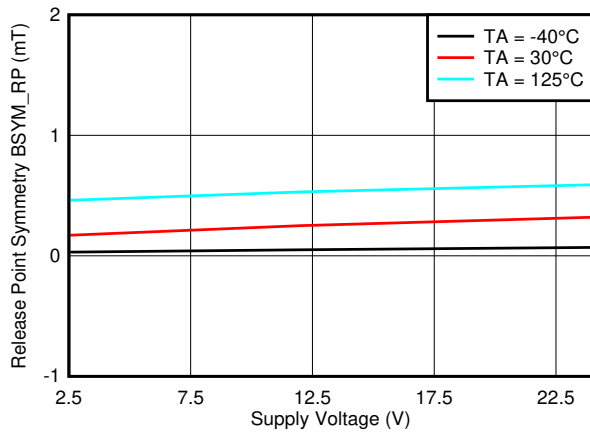
7.7 Typical Characteristics (continued)



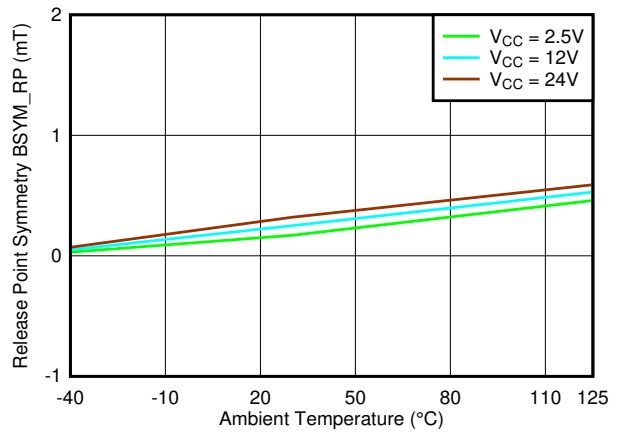
7-63. $B_{SYM_OP(ZX)}$ vs. V_{CC}



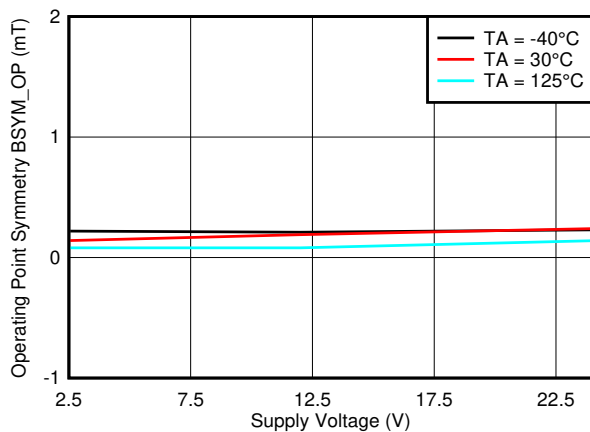
7-64. $B_{SYM_OP(ZX)}$ vs. Temperature



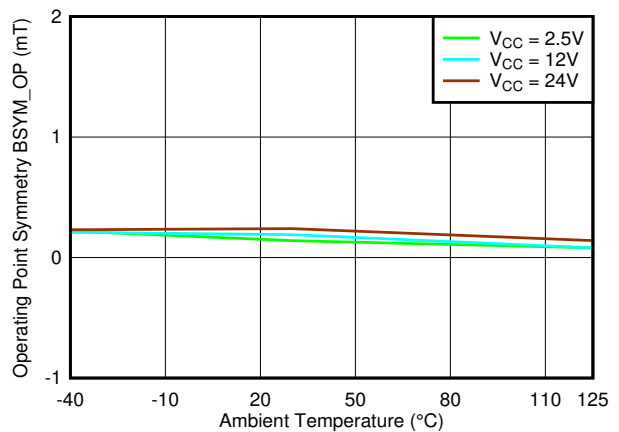
7-65. $B_{SYM_RP(ZX)}$ vs. V_{CC}



7-66. $B_{SYM_RP(ZX)}$ vs. Temperature

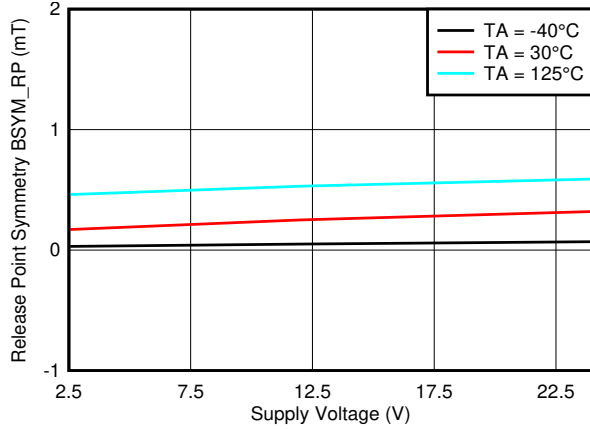


7-67. $B_{SYM_OP(ZY)}$ vs. V_{CC}

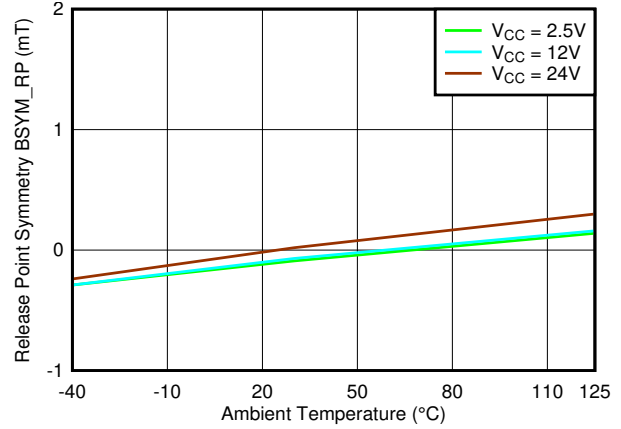


7-68. $B_{SYM_OP(ZY)}$ vs. Temperature

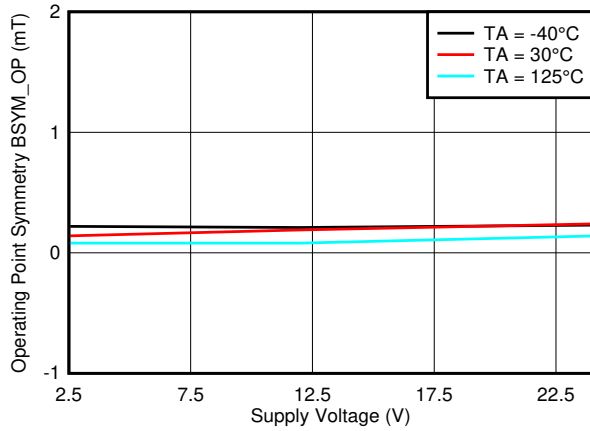
7.7 Typical Characteristics



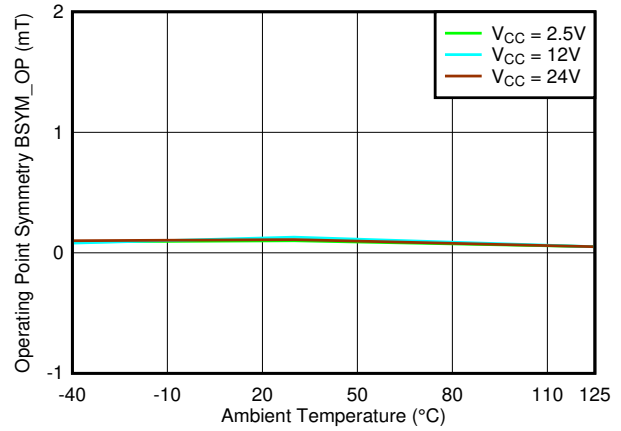
7-69. $B_{SYM_RP(ZY)}$ vs. V_{CC}



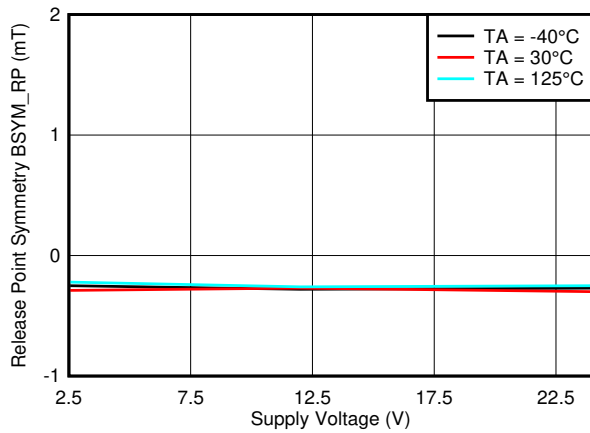
7-70. $B_{SYM_RP(ZY)}$ vs. Temperature



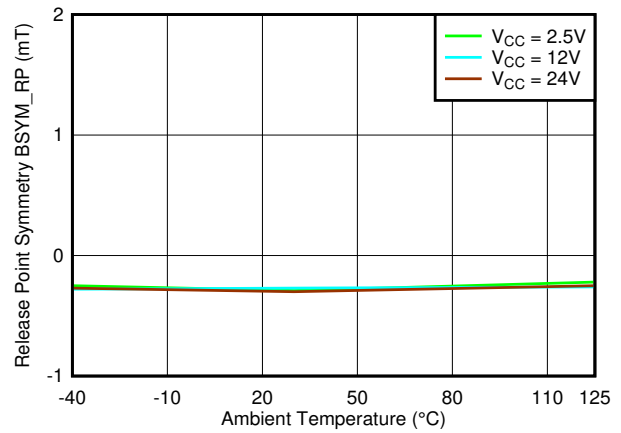
7-71. $B_{SYM_OP(XY)}$ vs. V_{CC}



7-72. $B_{SYM_OP(XY)}$ vs. Temperature

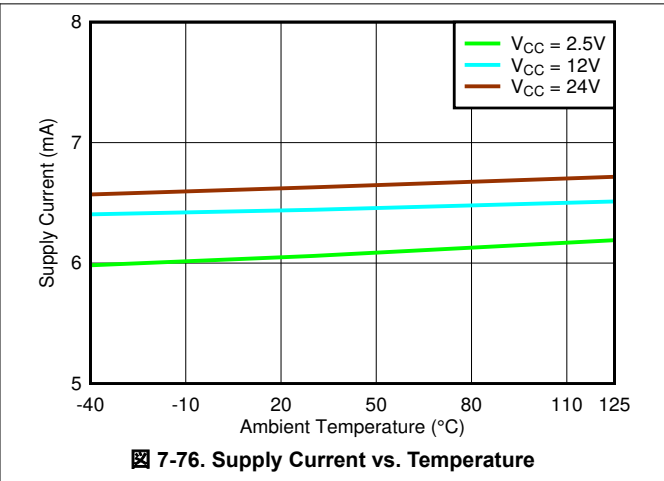
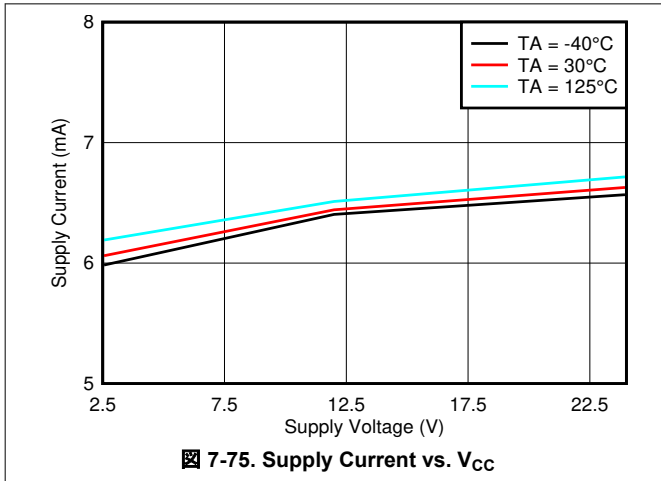


7-73. $B_{SYM_RP(XY)}$ vs. V_{CC}



7-74. $B_{SYM_RP(XY)}$ vs. Temperature

7.7 Typical Characteristics (continued)



8 Detailed Description

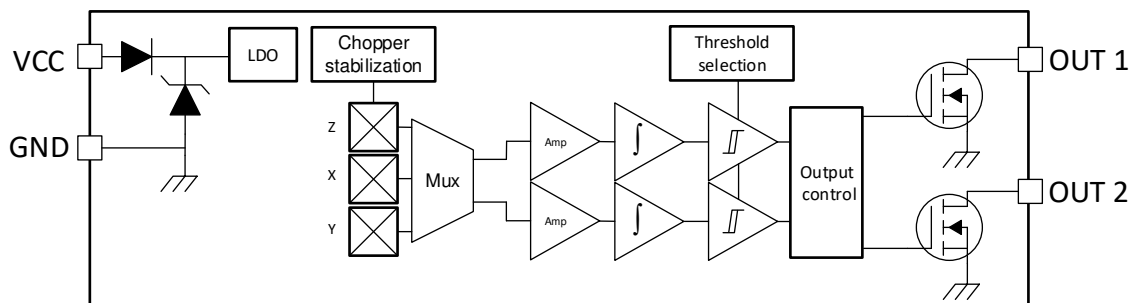
8.1 Overview

The TMAG5110-Q1 and TMAG5111-Q1 are dual chopper-stabilized Hall effect sensors with two digital latched outputs for rotational magnetic sensing applications. The TMAG511x-Q1 device can be powered with a supply voltage between 2.5 V and 38 V, and survives continuous -20 V reverse-battery conditions. The TMAG511x-Q1 device only operates when a voltage of 2.5 V to 38 V applied to the V_{CC} pin (with respect to the GND pin). In addition, the device can withstand voltages up to 40 V for transient durations.

Alternating north and south magnetic poles are required to toggle the outputs of each Hall-effect latch.

The device is offered in a standard 3 mT typical operating point, as well as a high-sensitivity 1.4 mT typical operating point. The higher magnetic sensitivity provides flexibility in low-cost magnet selection and mechanical component placement. The TMAG511x-Q1 is also available in three 2-axis combination options (X-Y, Z-X, Z-Y) to support flexible multiple installation orientations relative to the magnet.

8.2 Functional Block Diagram



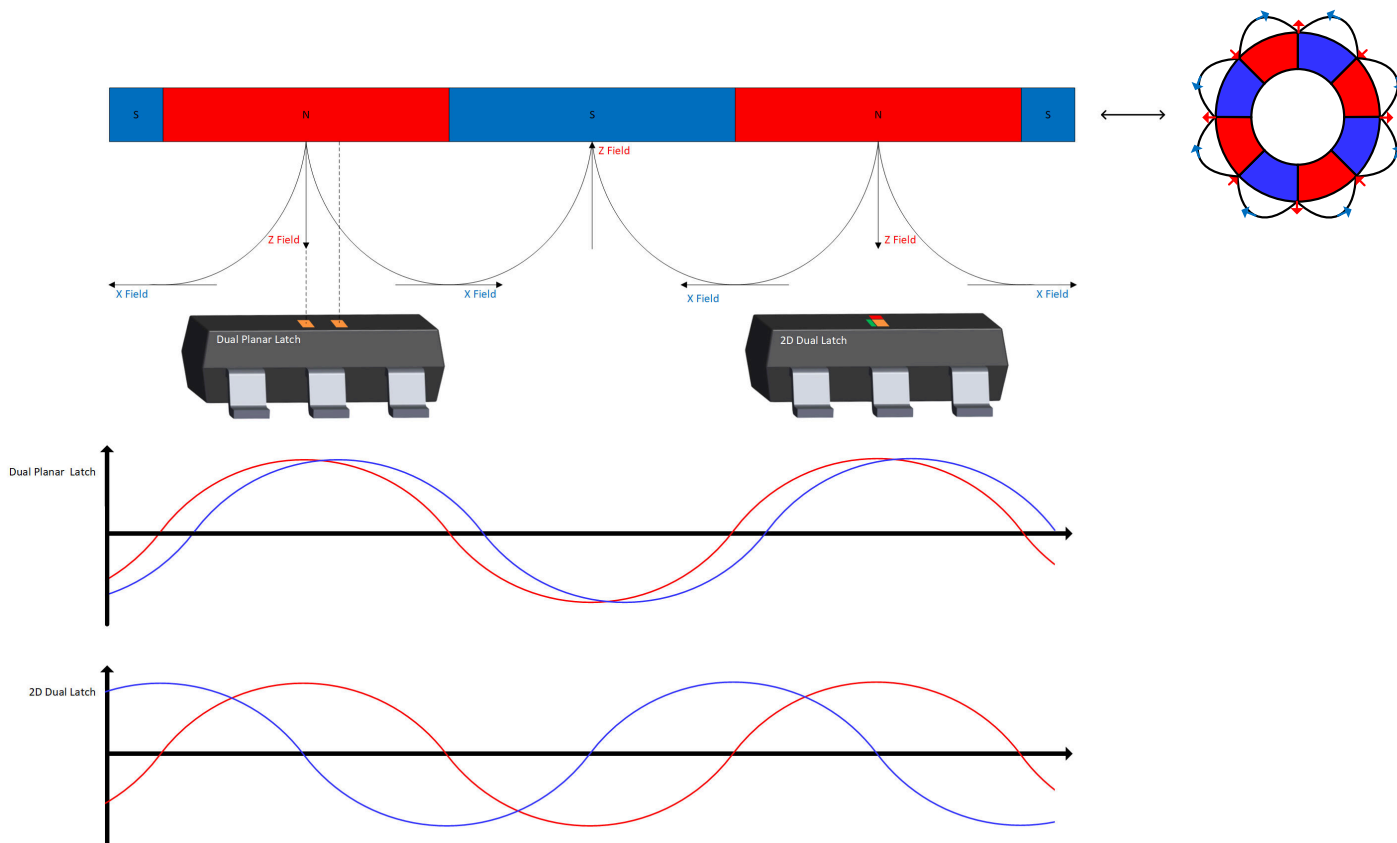
8.3 Feature Description

8.3.1 2D Description

8.3.1.1 2D General Description and Advantages

The best way to understand the advantage of a 2D dual latch hall sensor is to compare its behavior with others solutions used in the market. The two most common methods are: dual planar hall latch sensors or two single hall latch sensors. Those methods are used in applications such as rotary encoding or speed and direction sensing. The principle is to set two sensors apart at a certain angle such that they will sense the same magnetic field but with a fixed phase difference. The frequency of the signal will give the speed or incremental information while the phase will give the direction of rotation. For an easy read, the signals should be as close to a quadrature signal as possible, meaning there is a 90° phase shift between the two signals. To create those two signals in quadrature, the two latches must be placed at a distance of $\frac{1}{2}$ pole + n pole from one another.

The TMAG511x-Q1 can be used instead of a dual planar hall latch or two single hall latch sensors. The TMAG511x-Q1 has two integrated hall latch sensors spaced at a 90° angle from each other, which allows each sensor to detect a quadrature component of the same magnetic field. For A, B, and C device variants, the magnetic direction detected will be XY, ZX, and ZY, respectively. Each of those components are placed at 90° from each other by design, therefore the output signals will also be separated with the same angle value. Wherever the sensor is placed to catch the right two components of the field, the output will be in quadrature from one another. [Figure 8-1](#) shows the result of two different type of sensors when the devices are placed close to a ring magnet.

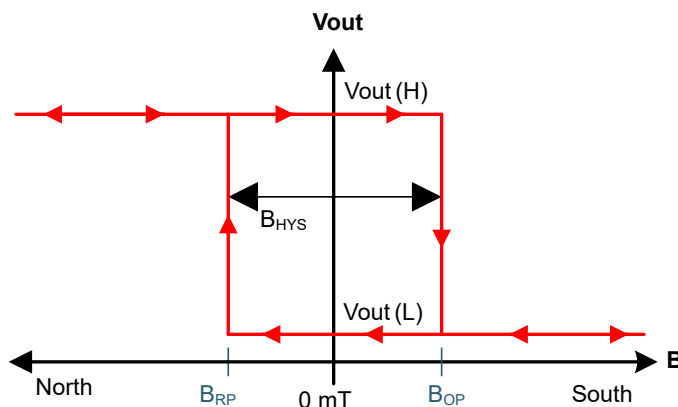


8-1. Dual Planar Latch vs. 2D Dual Latch

8.3.1.2 2D Magnetic Sensor Response

The TMAG5110-Q1 has two integrated latches that update their results to the OUT1 and OUT2 pins. Each one of these outputs will then have a latch functionality. 8-2 shows the response to different magnetic poles for each output.

The TMAG5111-Q1 outputs are not directly connected to the two integrated latches. Additional processing is available to generate the speed and direction outputs.



8-2. Latch Functionality

Figure 8-3 shows the magnetic response of both the TMAG5110-Q1 and TMAG5111-Q1 to a sinusoidal field. The sinusoidal curves represent the evaluation of the magnetic field seen by both integrated hall sensors.

The TMAG5110-Q1 response shows both outputs reacting to this signal by going low once the field is higher than B_{OP} and going high when the field is lower than B_{RP} .

The TMAG5111-Q1 response shows how those two signals are processed to create a speed output and a direction output.

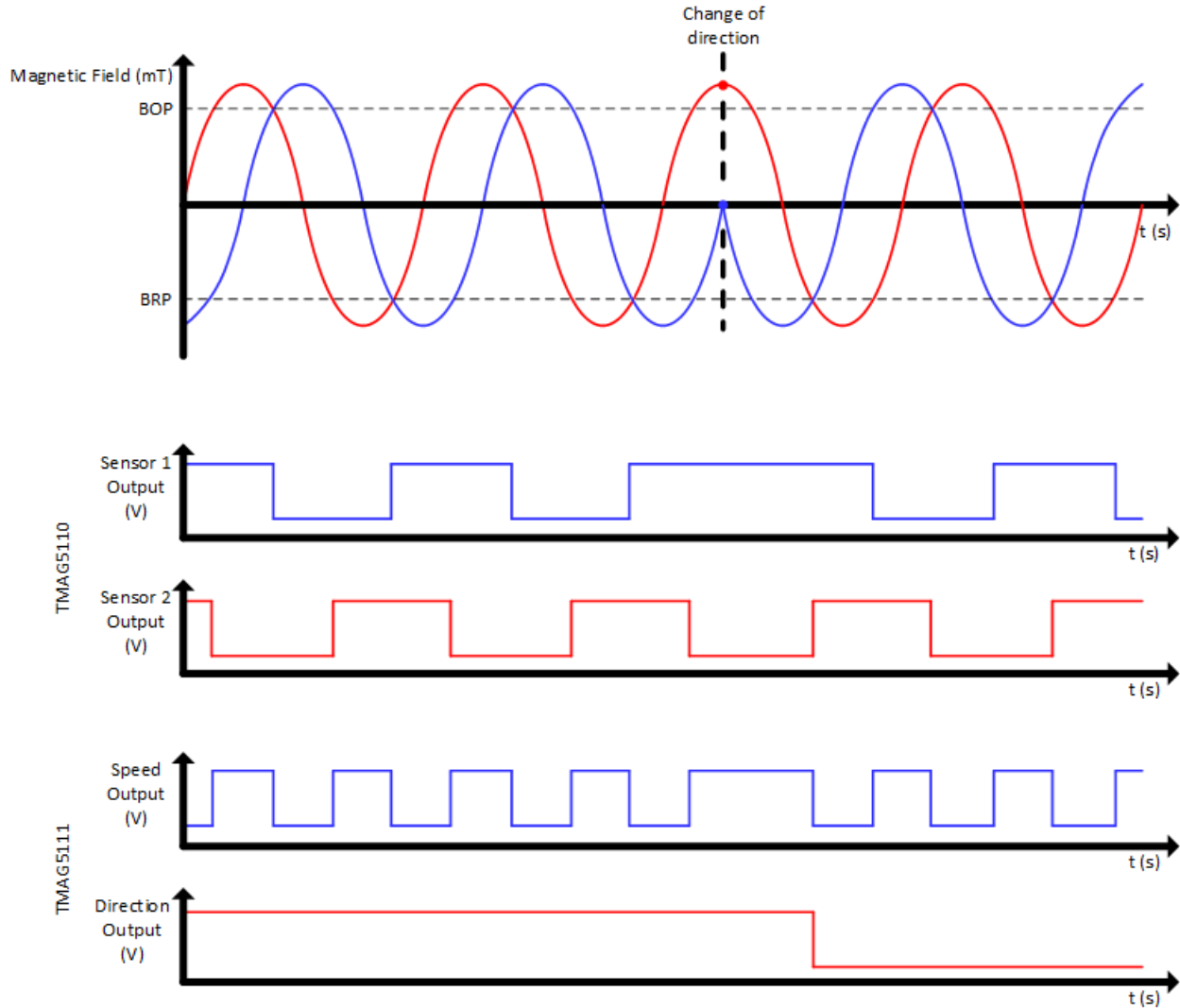


Figure 8-3. TMAG511x-Q1 Output Behavior

8.3.1.3 Axis Polarities

Figure 8-4 shows the directions from where each axis is sensitive to a south pole. This also shows that the opposite directions are sensitive to the north pole.

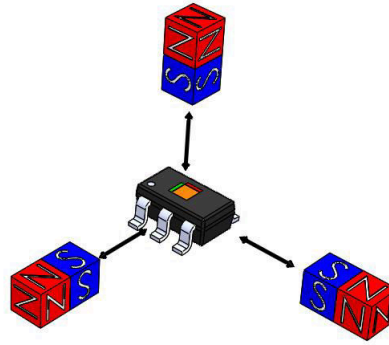


图 8-4. Axis Polarities

8.3.2 Axis Options

8.3.2.1 Device Placed In-Plane to Magnet

The outer edge of the magnet is the area where the magnetic field is the strongest. Placing the sensor on the outer edge of the magnet enables the sensor to get the best flexibility in terms of distance and sensitivity selection. The different figures below show how to use the different versions of the TMAG511x-Q1 in regards to the magnet and sensor placement.

The options shown in 图 8-5 and 图 8-6 composed of the X and Y axes enable the sensor to be placed in the same plane as the ring magnet. The sensor can be placed facing the magnet or on the side of the magnet. The part can also be turned at 180 degrees along the Z axis.

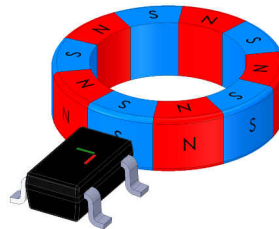


图 8-5. XY Outer Edge 1

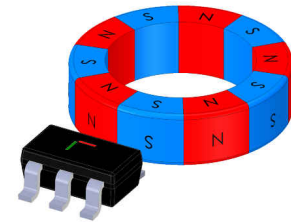


图 8-6. XY Outer Edge 2

The options shown in 图 8-7 and 图 8-8 composed of Z and X axes enable the sensor to be placed below the magnet, or facing the front side of the device. The part can also be turned at 180 degrees along the Z axis.



图 8-7. ZX Outer Edge 1



图 8-8. ZX Outer Edge 2

The options shown in 图 8-9 and 图 8-10 composed of Z and Y axes also enable the sensor to be placed below the magnet in a different position, as well as facing the ring magnet with the side of the device. The part can also be turned at 180 degrees along the Z axis.



图 8-9. ZY Outer Edge 1

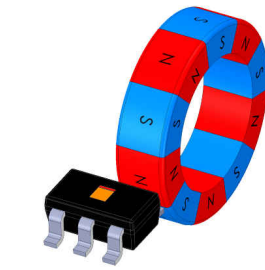
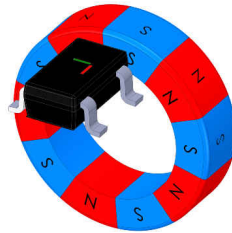


图 8-10. ZY Outer Edge 1

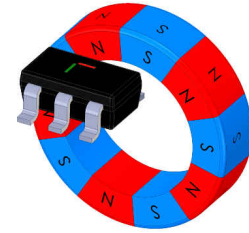
8.3.2.2 Device Placed on the Side Edge of the Magnet

The side edge of the magnet still provides a magnetic field, but the field is much weaker than the field on the outer edge. Placing the sensor on the side edge minimizes the flexibility as of how far the device can be placed from the ring magnet. The 2 mT version enables high sensitivity, allowing the application to work as well as when the device is placed on the outer edge. Nevertheless this option can be helpful in application where the sensor has to fit within the magnet diameter.

The options shown in [8-11](#) and [8-12](#) composed of X and Y axes enable the sensor to be placed facing the side edge of the magnet. The side of the sensor can also be placed next to the side edge of the magnet. The part can also be turned at 180 degrees along the Z axis.



8-11. XY Side Edge 1

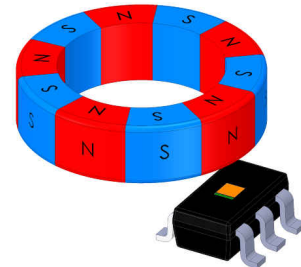


8-12. XY Side Edge 2

The options shown in [8-13](#) and [8-14](#) composed of Z and X axis enable another way to place the sensor facing the side edge of the magnet. The top of the sensor can also be placed facing the side edge of the magnet. The part can also be turned at 180 degrees along the Z axis.



8-13. ZX Side Edge 1

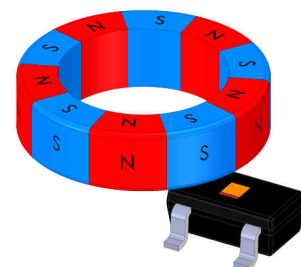


8-14. ZX Side Edge 2

The options shown in [8-15](#) and [8-16](#) composed of Z and Y axes enable the placement of the sensor on the side edge of a magnet with the pins facing the magnet, or with top of the sensor facing the side edge of the magnet. The part can also be turned at 180 degrees along the Z axis.



8-15. ZY Side Edge 1



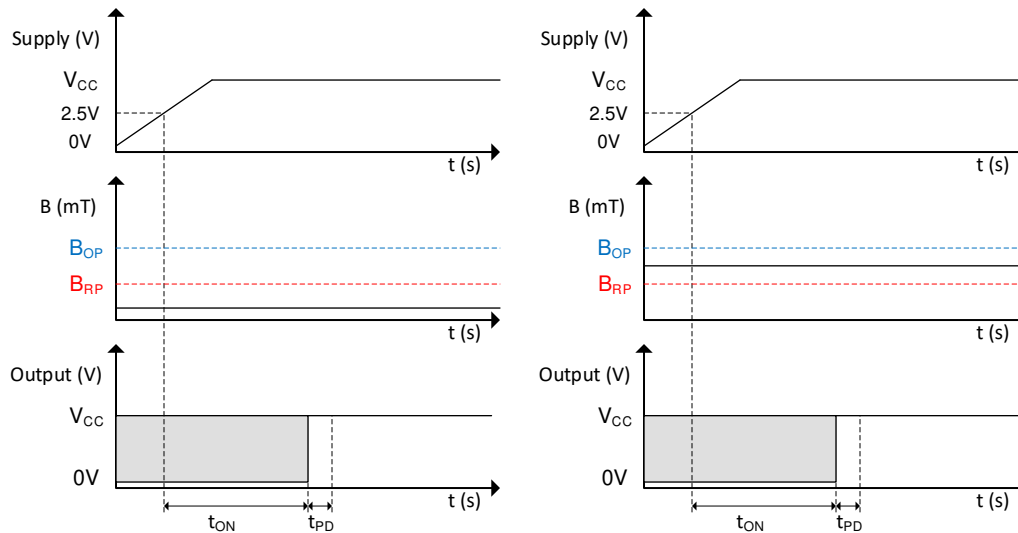
8-16. ZY Side Edge 1

8.3.3 Power-On Time

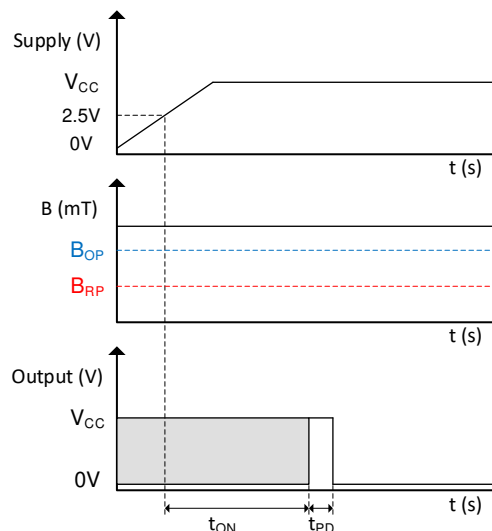
☒ 8-17 shows the behavior of the device after the V_{CC} voltage is applied and when the field is below the B_{OP} threshold. Once the minimum value for V_{CC} is reached, the TMAG5110-Q1 will take time t_{ON} to power up and then time t_{PD} to update the output to a level High.

☒ 8-18 shows the behavior of the device after the V_{CC} voltage is applied and when the field is above the B_{OP} threshold. Once the minimum value for V_{CC} is reached, the TMAG5110-Q1 will take time t_{ON} to power up and then time t_{PD} to update the output to a level High.

For the TMAG5111-Q1 the power-on behavior is similar but OUT1 will be updated to Low during the t_{PD} time. OUT2 will be updated to High during the t_{PD} time. The output value following the power-on sequence will then depend on the magnet placement, the sense of rotation and the device variant.



☒ 8-17. Power-On Time When $B < B_{OP}$

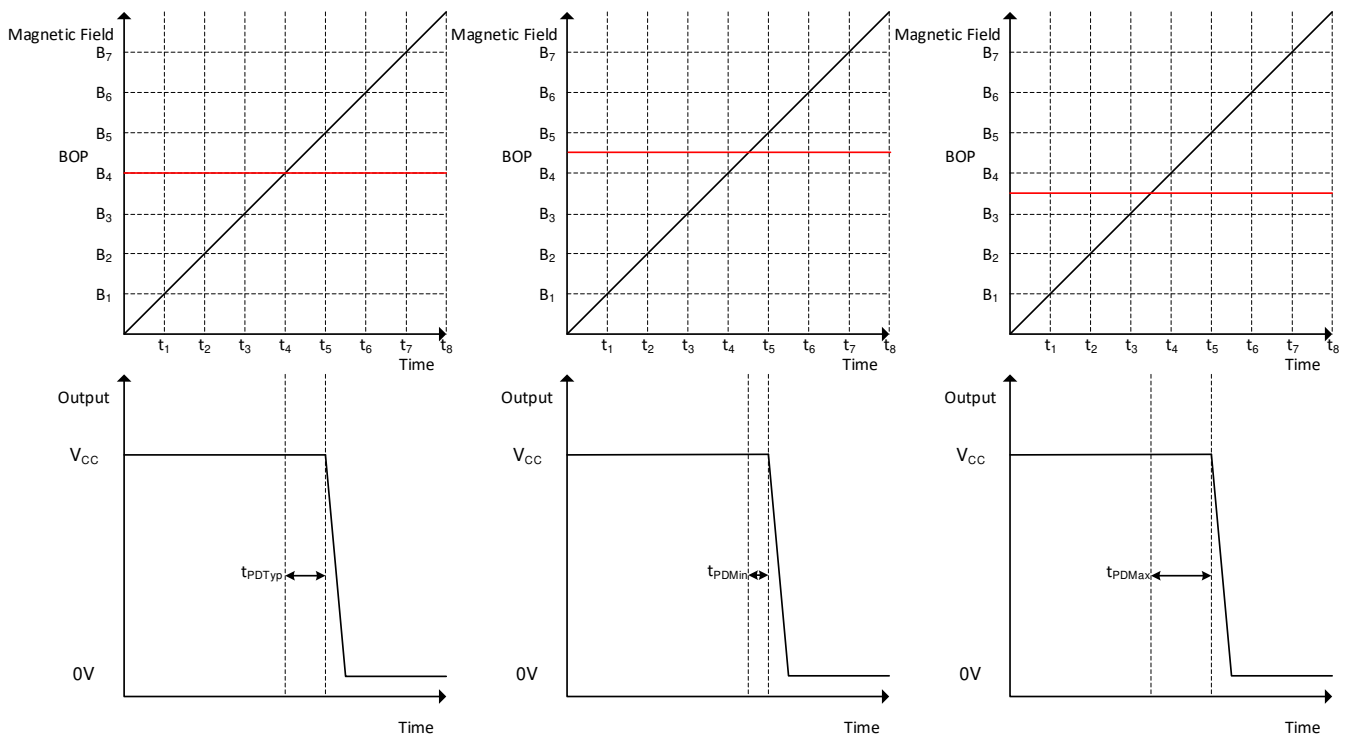


☒ 8-18. Power-On Time When $B > B_{OP}$

8.3.4 Propagation Delay

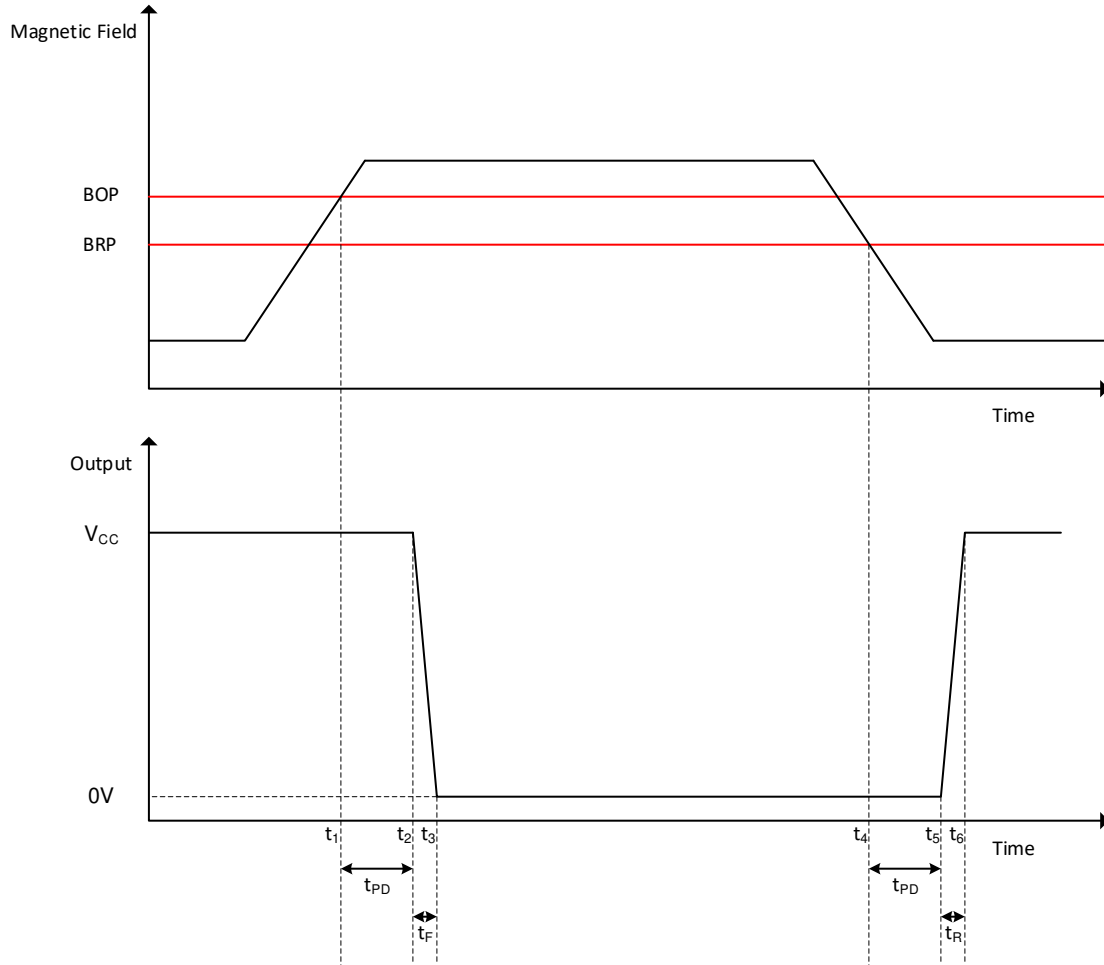
The TMAG511x-Q1 samples the Hall element at a nominal sampling interval of t_{PD} to detect the presence of a magnetic south pole. Between each sampling interval, the device calculates the average magnetic field applied to the device. As defined in [8-20](#), if this average value crosses the B_{OP} or B_{RP} threshold, the device changes the corresponding level. Because the system, Hall sensor + magnet is by nature asynchronous, the propagation delay t_d will vary depending on when the magnetic field goes above the B_{OP} value. As shown in [8-19](#) the output delay will then depend on when the magnetic field will get higher than the B_{OP} value. The first graph shows the typical case.

The magnetic field goes above the B_{OP} value at the moment where the output is updated. The part will then only need one cycle of t_{PD} to update the output. The second graph shows a magnetic field going above the B_{OP} value just right before half of the sampling period. This is the best case possible where the output will be updated in just half of the sampling period. Finally, the third graph shows the worst possible case where the magnetic field goes above the B_{OP} value just after half of the sampling period. At the next output update, the value will still see a value under the threshold and will need a whole new period to update the output



8-19. Field Sampling Timing

[8-20](#) shows TMAG511x-Q1 propagation delay analysis when a magnetic south pole is applied. The Hall element of the TMAG511x-Q1 experiences an increasing magnetic field as a magnetic south pole approaches near the device as well as a decreasing magnetic field as a magnetic south pole leaves away. At time t_1 the magnetic field goes above the B_{OP} threshold. The output will then start to move after the time t_{PD} . As shown in [8-20](#), this time will vary depending on when the sampling period is. At t_2 the output start pulling to the low voltage value. At t_3 the output is completely pulled down to the lower voltage value. The same process happen on the other way when the magnetic value is going under the B_{OP} threshold.



8-20. Propagation Delay

The [Figure 8-22](#) can also be calculated using the following formulas:

$$T_J = T_A + \Delta T \quad (1)$$

where

- T_J is the junction temperature
- T_A is the ambient temperature
- ΔT is the difference between the junction temperature and the ambient temperature

$$\Delta T = P_D \times R_{\theta JA} \quad (2)$$

where

- P_D is the power dissipated by the part
- $R_{\theta JA}$ is the junction to ambient thermal resistance

$$P_D = V_{CC} \times I_{CC} \quad (3)$$

where

- V_{CC} is the voltage supply of the device
- I_{CC} is the current consumption of the device

Combining the three equations above gives [Equation 4](#) below:

$$V_{CC \max} = \frac{T_{J \max} - T_A}{I_{CC \max} \times R_{\theta JA}} \quad (4)$$

This equation gives the maximum voltage the part can handle in regards of the ambient temperature.

For example, with an the application required to work within a ambient temperature of maximum 85 °C, and $T_{J \max}$, $R_{\theta JA}$ and $I_{CC \max}$ are defined in the data sheet, the maximum voltage allowed for this application is determined in [Equation 5](#):

$$V_{CC \max} = \frac{170^\circ\text{C} - 140^\circ\text{C}}{6.5 \text{ mA} \times 166.5^\circ\text{C} / \text{W}} = 27.72 \text{ V}$$

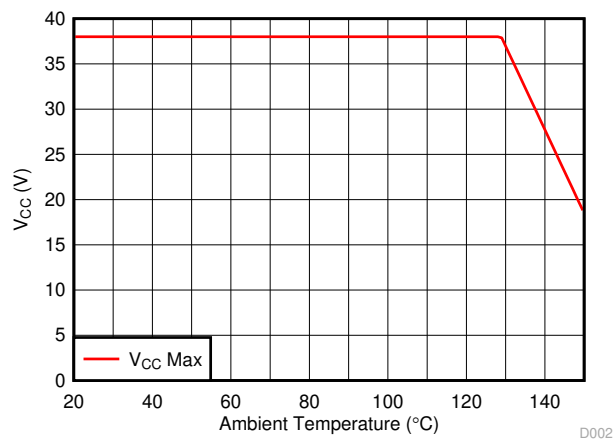


Figure 8-22. Power Derating Curve

8.4 Device Functional Modes

The TMAG511x-Q1 device has one mode of operation that applies when the [Recommended Operating Conditions](#) are met.

9 Application and Implementation

Note

以下のアプリケーション情報は、TI の製品仕様に含まれるものではなく、TI ではその正確性または完全性を保証いたしません。個々の目的に対する製品の適合性については、お客様の責任で判断していただくこととなります。お客様は自身の設計実装を検証しテストすることで、システムの機能を確認する必要があります。

9.1 Application Information

The TMAG511x-Q1 is designed for rotary applications for DC motor sensors or incremental rotary encoding.

For reliable functionality, the magnet must apply a flux density at the sensor greater than the corresponding maximum B_{OP} or B_{RP} numbers specified in the [Magnetic Characteristics](#) table. Add additional margin to account for mechanical tolerance, temperature effects, and magnet variation. Magnets generally produce weaker fields as temperature increases.

9.2 Typical Applications

9.2.1 Incremental Rotary Encoding Application

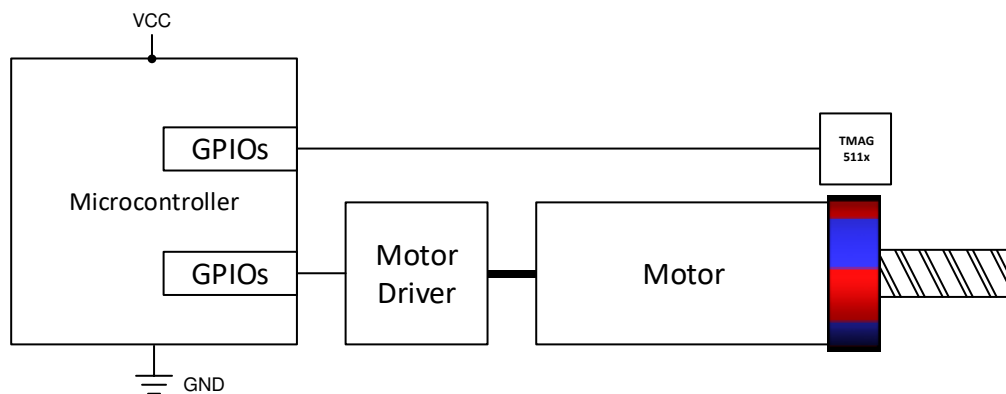


図 9-1. Incremental Encoding

9.2.1.1 Design Requirements

表 9-1 lists the use the parameters for this design.

表 9-1. Design Parameters

DESIGN PARAMETER	EXAMPLE VALUE
Motor speed	22.5 kRPM
Number of magnet poles	8
Dimensions	9.7 mm diameter × 2 mm thick
Magnetic material	Ceramic 8D
Air gap above the Hall sensors	2.5 mm
Radial magnetic flux density peak	±12.5 mT
Tangential magnetic flux density peak	±9.5 mT

9.2.1.2 Detailed Design Procedure

Incremental encoders are used on knobs, wheels, motors, and flow meters to measure relative rotary movement. By attaching a ring magnet to the rotating component and placing the TMAG511x-Q1 nearby, the sensor will generate voltage pulses as the magnet turns. The TMAG511x-Q1 integrates two sensors and two signal chains. This means each channel can go up to the maximum speed independently from each other.

When the magnet rotates, the TMAG5110-Q1 will generate alternate pulses on each output. One input will be the result of what is sensed from one specific axis, while the other output will sense from another specific axis. In [表 9-1](#), this is also referred as Radial and Tangential magnetic flux. Those two signals are the result of two different components of the same magnetic field resulting in the two signals being 90° from one another. Also called quadrature output, this type of signal is ideal to measure a rotational count as well as a change in direction of the ring magnet.

The TMAG5111-Q1 directly generates the speed and direction outputs. This eliminates the need for external processing.

The maximum rotational speed that can be measured is limited by the sensor bandwidth and the magnetic strength of the magnet.

Generally, the bandwidth must be faster than two times the number of poles per second. In this design example, the maximum speed is 22500 RPM, which involves a rotation of 3000 poles per second when using an 8-pole magnet. The TMAG511x-Q1 sensing bandwidth is typically 40 kHz, which is more than thirteen times the pole frequency.

The strength of the magnet also has an impact on how fast the magnet can turn. A weaker magnet with a maximum strength very close to the threshold value will limit the maximum speed by limiting the amount of time where this field will be higher than the B_{OP} . The time spent above the B_{OP} value will be longer for a magnet with stronger field.

When the magnet strength is significantly higher than B_{OP} , [式 5](#) can be used to calculate the allowed speed.

$$\text{Speed (RPM)} \leq \frac{\text{Bandwidth (Hz)} \times 60}{\text{Number of poles}} \tag{5}$$

9.2.1.3 Application Curve

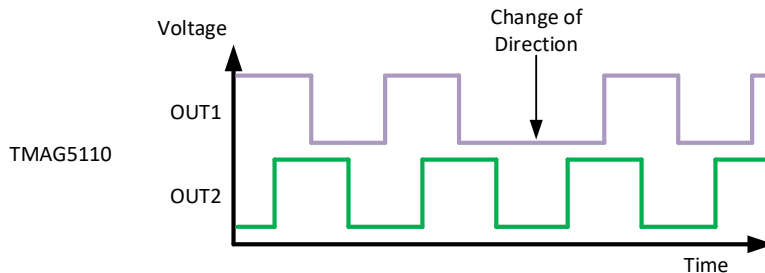


图 9-2. TMAG5110-Q1 Output Response

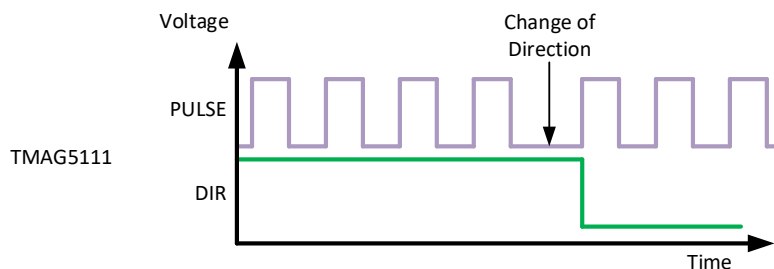


图 9-3. TMAG5111-Q1 Output Response

10 Power Supply Recommendations

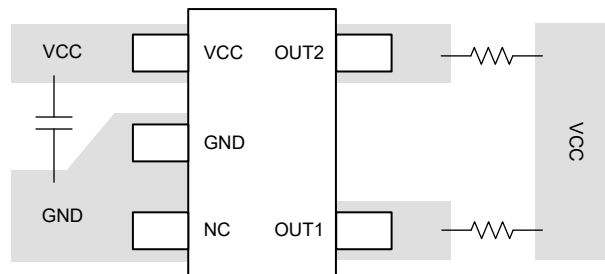
The TMAG511x-Q1 is powered by 2.5-V to 38-V DC power supplies. A decoupling capacitor placed close to the device must be used to provide local energy with minimal inductance. TI recommends using a ceramic capacitor with a value of at least 0.01 μF .

11 Layout

11.1 Layout Guidelines

Magnetic fields pass through most non-ferromagnetic materials with no significant disturbance. Embedding Hall effect sensors within plastic or aluminum enclosures and sensing magnets on the outside is common practice. Magnetic fields also easily pass through most printed-circuit boards (PCBs), which makes placing the magnet on the opposite side of the PCB possible.

11.2 Layout Example



11-1. Layout Example

12 Device and Documentation Support

12.1 Receiving Notification of Documentation Updates

To receive notification of documentation updates, navigate to the device product folder on [ti.com](https://www.ti.com). Click on *Subscribe to updates* to register and receive a weekly digest of any product information that has changed. For change details, review the revision history included in any revised document.

12.2 サポート・リソース

TI E2E™ サポート・フォーラムは、エンジニアが検証済みの回答と設計に関するヒントをエキスパートから迅速かつ直接得ることができる場所です。既存の回答を検索したり、独自の質問をしたりすることで、設計に必要な支援を迅速に得ることができます。

リンクされているコンテンツは、該当する貢献者により、現状のまま提供されるものです。これらは TI の仕様を構成するものではなく、必ずしも TI の見解を反映したものではありません。TI の [使用条件](#) を参照してください。

12.3 Trademarks

TI E2E™ is a trademark of Texas Instruments.

すべての商標は、それぞれの所有者に帰属します。

12.4 Electrostatic Discharge Caution



This integrated circuit can be damaged by ESD. Texas Instruments recommends that all integrated circuits be handled with appropriate precautions. Failure to observe proper handling and installation procedures can cause damage.

ESD damage can range from subtle performance degradation to complete device failure. Precision integrated circuits may be more susceptible to damage because very small parametric changes could cause the device not to meet its published specifications.

12.5 Glossary

[TI Glossary](#) This glossary lists and explains terms, acronyms, and definitions.

13 Mechanical, Packaging, and Orderable Information

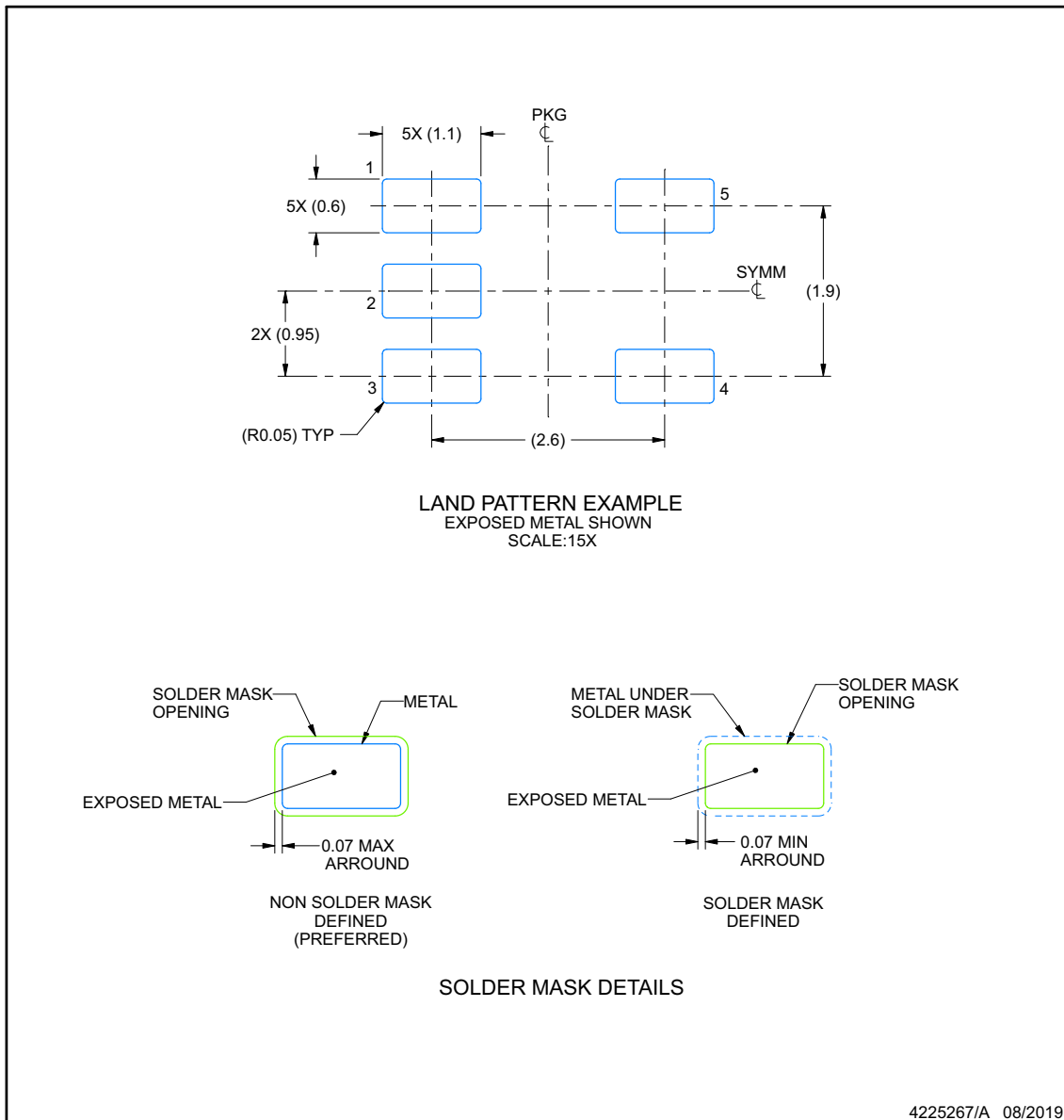
The following pages include mechanical, packaging, and orderable information. This information is the most current data available for the designated devices. This data is subject to change without notice and revision of this document. For browser-based versions of this data sheet, refer to the left-hand navigation.

EXAMPLE BOARD LAYOUT

DBV0005A-C01

SOT-23 - 1.25 mm max height

SMALL OUTLINE TRANSISTOR



NOTES: (continued)

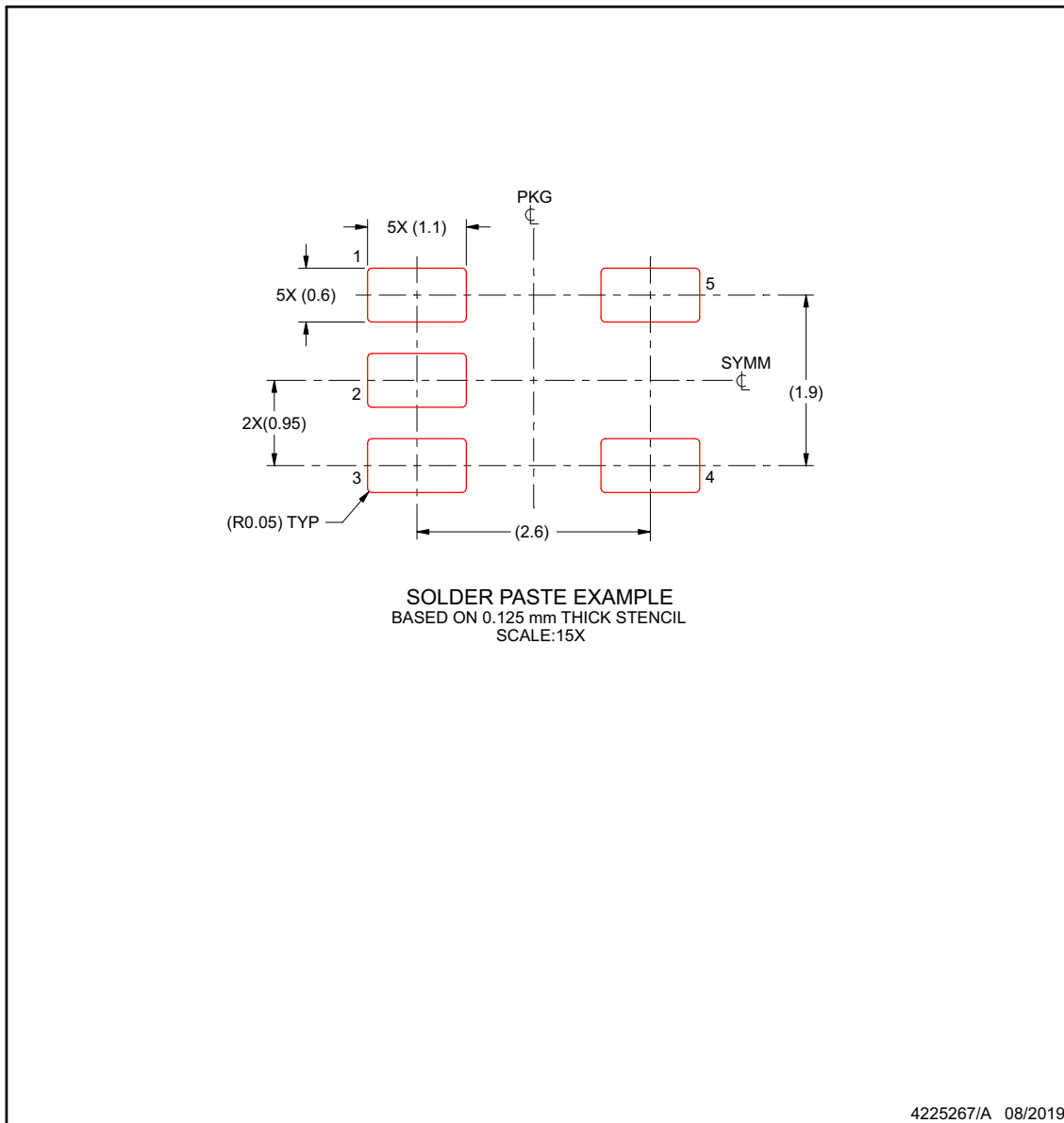
5. Publication IPC-7351 may have alternate designs.
6. Solder mask tolerances between and around signal pads can vary based on board fabrication site.

EXAMPLE STENCIL DESIGN

DBV0005A-C01

SOT-23 - 1.25 mm max height

SMALL OUTLINE TRANSISTOR



NOTES: (continued)

7. Laser cutting apertures with trapezoidal walls and rounded corners may offer better paste release. IPC-7525 may have alternate design recommendations.
8. Board assembly site may have different recommendations for stencil design.

PACKAGING INFORMATION

Orderable Device	Status (1)	Package Type	Package Drawing	Pins	Package Qty	Eco Plan (2)	Lead finish/ Ball material (6)	MSL Peak Temp (3)	Op Temp (°C)	Device Marking (4/5)	Samples
TMAG5110A2AQDBVRQ1	ACTIVE	SOT-23	DBV	5	3000	RoHS & Green	SN	Level-3-260C-168 HR	-40 to 125	0A2Z	Samples
TMAG5110A4AQDBVRQ1	ACTIVE	SOT-23	DBV	5	3000	RoHS & Green	SN	Level-3-260C-168 HR	-40 to 125	0A4Z	Samples
TMAG5110B2AQDBVRQ1	ACTIVE	SOT-23	DBV	5	3000	RoHS & Green	SN	Level-3-260C-168 HR	-40 to 125	0B2Z	Samples
TMAG5110B4AQDBVRQ1	ACTIVE	SOT-23	DBV	5	3000	RoHS & Green	SN	Level-3-260C-168 HR	-40 to 125	0B4Z	Samples
TMAG5110C2AQDBVRQ1	ACTIVE	SOT-23	DBV	5	3000	RoHS & Green	SN	Level-3-260C-168 HR	-40 to 125	0C2Z	Samples
TMAG5110C4AQDBVRQ1	ACTIVE	SOT-23	DBV	5	3000	RoHS & Green	SN	Level-3-260C-168 HR	-40 to 125	0C4Z	Samples
TMAG5111A2AQDBVRQ1	ACTIVE	SOT-23	DBV	5	3000	RoHS & Green	SN	Level-3-260C-168 HR	-40 to 125	1A2Z	Samples
TMAG5111A4AQDBVRQ1	ACTIVE	SOT-23	DBV	5	3000	RoHS & Green	SN	Level-3-260C-168 HR	-40 to 125	1A4Z	Samples
TMAG5111B2AQDBVRQ1	ACTIVE	SOT-23	DBV	5	3000	RoHS & Green	SN	Level-3-260C-168 HR	-40 to 125	1B2Z	Samples
TMAG5111B4AQDBVRQ1	ACTIVE	SOT-23	DBV	5	3000	RoHS & Green	SN	Level-3-260C-168 HR	-40 to 125	1B4Z	Samples
TMAG5111C2AQDBVRQ1	ACTIVE	SOT-23	DBV	5	3000	RoHS & Green	SN	Level-3-260C-168 HR	-40 to 125	1C2Z	Samples
TMAG5111C4AQDBVRQ1	ACTIVE	SOT-23	DBV	5	3000	RoHS & Green	SN	Level-3-260C-168 HR	-40 to 125	1C4Z	Samples

(1) The marketing status values are defined as follows:

ACTIVE: Product device recommended for new designs.

LIFEBUY: TI has announced that the device will be discontinued, and a lifetime-buy period is in effect.

NRND: Not recommended for new designs. Device is in production to support existing customers, but TI does not recommend using this part in a new design.

PREVIEW: Device has been announced but is not in production. Samples may or may not be available.

OBSELETE: TI has discontinued the production of the device.

(2) **RoHS:** TI defines "RoHS" to mean semiconductor products that are compliant with the current EU RoHS requirements for all 10 RoHS substances, including the requirement that RoHS substance do not exceed 0.1% by weight in homogeneous materials. Where designed to be soldered at high temperatures, "RoHS" products are suitable for use in specified lead-free processes. TI may reference these types of products as "Pb-Free".

RoHS Exempt: TI defines "RoHS Exempt" to mean products that contain lead but are compliant with EU RoHS pursuant to a specific EU RoHS exemption.

Green: TI defines "Green" to mean the content of Chlorine (Cl) and Bromine (Br) based flame retardants meet JS709B low halogen requirements of <=1000ppm threshold. Antimony trioxide based flame retardants must also meet the <=1000ppm threshold requirement.

- (3) MSL, Peak Temp. - The Moisture Sensitivity Level rating according to the JEDEC industry standard classifications, and peak solder temperature.
- (4) There may be additional marking, which relates to the logo, the lot trace code information, or the environmental category on the device.
- (5) Multiple Device Markings will be inside parentheses. Only one Device Marking contained in parentheses and separated by a "~" will appear on a device. If a line is indented then it is a continuation of the previous line and the two combined represent the entire Device Marking for that device.
- (6) Lead finish/Ball material - Orderable Devices may have multiple material finish options. Finish options are separated by a vertical ruled line. Lead finish/Ball material values may wrap to two lines if the finish value exceeds the maximum column width.

Important Information and Disclaimer:The information provided on this page represents TI's knowledge and belief as of the date that it is provided. TI bases its knowledge and belief on information provided by third parties, and makes no representation or warranty as to the accuracy of such information. Efforts are underway to better integrate information from third parties. TI has taken and continues to take reasonable steps to provide representative and accurate information but may not have conducted destructive testing or chemical analysis on incoming materials and chemicals. TI and TI suppliers consider certain information to be proprietary, and thus CAS numbers and other limited information may not be available for release.

In no event shall TI's liability arising out of such information exceed the total purchase price of the TI part(s) at issue in this document sold by TI to Customer on an annual basis.

OTHER QUALIFIED VERSIONS OF TMAG5110-Q1, TMAG5111-Q1 :

- Catalog : [TMAG5110](#), [TMAG5111](#)

NOTE: Qualified Version Definitions:

- Catalog - TI's standard catalog product

TAPE AND REEL INFORMATION

QUADRANT ASSIGNMENTS FOR PIN 1 ORIENTATION IN TAPE


*All dimensions are nominal

Device	Package Type	Package Drawing	Pins	SPQ	Reel Diameter (mm)	Reel Width W1 (mm)	A0 (mm)	B0 (mm)	K0 (mm)	P1 (mm)	W (mm)	Pin1 Quadrant
TMAG5110A2AQDBVRQ1	SOT-23	DBV	5	3000	178.0	9.0	3.3	3.2	1.4	4.0	8.0	Q3
TMAG5110A4AQDBVRQ1	SOT-23	DBV	5	3000	178.0	9.0	3.3	3.2	1.4	4.0	8.0	Q3
TMAG5110B2AQDBVRQ1	SOT-23	DBV	5	3000	178.0	9.0	3.3	3.2	1.4	4.0	8.0	Q3
TMAG5110B4AQDBVRQ1	SOT-23	DBV	5	3000	178.0	9.0	3.3	3.2	1.4	4.0	8.0	Q3
TMAG5110C2AQDBVRQ1	SOT-23	DBV	5	3000	178.0	9.0	3.3	3.2	1.4	4.0	8.0	Q3
TMAG5110C4AQDBVRQ1	SOT-23	DBV	5	3000	178.0	9.0	3.3	3.2	1.4	4.0	8.0	Q3
TMAG5111A2AQDBVRQ1	SOT-23	DBV	5	3000	178.0	9.0	3.3	3.2	1.4	4.0	8.0	Q3
TMAG5111A4AQDBVRQ1	SOT-23	DBV	5	3000	178.0	9.0	3.3	3.2	1.4	4.0	8.0	Q3
TMAG5111B2AQDBVRQ1	SOT-23	DBV	5	3000	178.0	9.0	3.3	3.2	1.4	4.0	8.0	Q3
TMAG5111B4AQDBVRQ1	SOT-23	DBV	5	3000	178.0	9.0	3.3	3.2	1.4	4.0	8.0	Q3
TMAG5111C2AQDBVRQ1	SOT-23	DBV	5	3000	178.0	9.0	3.3	3.2	1.4	4.0	8.0	Q3
TMAG5111C4AQDBVRQ1	SOT-23	DBV	5	3000	178.0	9.0	3.3	3.2	1.4	4.0	8.0	Q3

TAPE AND REEL BOX DIMENSIONS


*All dimensions are nominal

Device	Package Type	Package Drawing	Pins	SPQ	Length (mm)	Width (mm)	Height (mm)
TMAG5110A2AQDBVRQ1	SOT-23	DBV	5	3000	190.0	190.0	30.0
TMAG5110A4AQDBVRQ1	SOT-23	DBV	5	3000	190.0	190.0	30.0
TMAG5110B2AQDBVRQ1	SOT-23	DBV	5	3000	190.0	190.0	30.0
TMAG5110B4AQDBVRQ1	SOT-23	DBV	5	3000	190.0	190.0	30.0
TMAG5110C2AQDBVRQ1	SOT-23	DBV	5	3000	190.0	190.0	30.0
TMAG5110C4AQDBVRQ1	SOT-23	DBV	5	3000	190.0	190.0	30.0
TMAG5111A2AQDBVRQ1	SOT-23	DBV	5	3000	190.0	190.0	30.0
TMAG5111A4AQDBVRQ1	SOT-23	DBV	5	3000	190.0	190.0	30.0
TMAG5111B2AQDBVRQ1	SOT-23	DBV	5	3000	190.0	190.0	30.0
TMAG5111B4AQDBVRQ1	SOT-23	DBV	5	3000	190.0	190.0	30.0
TMAG5111C2AQDBVRQ1	SOT-23	DBV	5	3000	190.0	190.0	30.0
TMAG5111C4AQDBVRQ1	SOT-23	DBV	5	3000	190.0	190.0	30.0

重要なお知らせと免責事項

TI は、技術データと信頼性データ(データシートを含みます)、設計リソース(リファレンス・デザインを含みます)、アプリケーションや設計に関する各種アドバイス、Web ツール、安全性情報、その他のリソースを、欠陥が存在する可能性のある「現状のまま」提供しており、商品性および特定目的に対する適合性の黙示保証、第三者の知的財産権の非侵害保証を含むいかなる保証も、明示的または黙示的にかかわらず拒否します。

これらのリソースは、TI 製品を使用する設計の経験を積んだ開発者への提供を意図したものです。(1) お客様のアプリケーションに適した TI 製品の選定、(2) お客様のアプリケーションの設計、検証、試験、(3) お客様のアプリケーションに該当する各種規格や、その他のあらゆる安全性、セキュリティ、規制、または他の要件への確実な適合に関する責任を、お客様のみが単独で負うものとし、

上記の各種リソースは、予告なく変更される可能性があります。これらのリソースは、リソースで説明されている TI 製品を使用するアプリケーションの開発の目的でのみ、TI はその使用をお客様に許諾します。これらのリソースに関して、他の目的で複製することや掲載することは禁止されています。TI や第三者の知的財産権のライセンスが付与されている訳ではありません。お客様は、これらのリソースを自身で使用した結果発生するあらゆる申し立て、損害、費用、損失、責任について、TI およびその代理人を完全に補償するものとし、TI は一切の責任を拒否します。

TI の製品は、[TI の販売条件](#)、または [ti.com](#) やかかる TI 製品の関連資料などのいずれかを通じて提供する適用可能な条項の下で提供されています。TI がこれらのリソースを提供することは、適用される TI の保証または他の保証の放棄の拡大や変更を意味するものではありません。

お客様がいかなる追加条項または代替条項を提案した場合でも、TI はそれらに異議を唱え、拒否します。

郵送先住所 : Texas Instruments, Post Office Box 655303, Dallas, Texas 75265
Copyright © 2024, Texas Instruments Incorporated