



## 1-W MONO AUDIO POWER AMPLIFIER

### FEATURES

- 1-W BTL Output (5 V, 0.2 % THD+N)
- 3.3-V and 5-V Operation
- No Output Coupling Capacitors Required
- Shutdown Control ( $I_{DD} = 0.6 \mu\text{A}$ )
- Headphone Interface Logic
- Uncompensated Gains of 2 to 20 (BTL Mode)
- Surface-Mount Packaging
- Thermal and Short-Circuit Protection
- High Power Supply Rejection(56-dB at 1 kHz)
- LM4860 Drop-In Compatible

**D PACKAGE  
(TOP VIEW)**

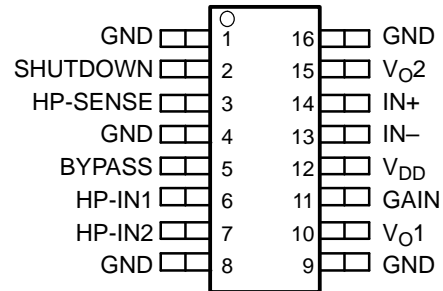

### DESCRIPTION

The TPA4860 is a bridge-tied load (BTL) audio power amplifier capable of delivering 1 W of continuous average power into an 8- $\Omega$  load at 0.4 % THD+N from a 5-V power supply in voiceband frequencies ( $f < 5 \text{ kHz}$ ). A BTL configuration eliminates the need for external coupling capacitors on the output in most applications. Gain is externally configured by means of two resistors and does not require compensation for settings of 2 to 20. Features of this amplifier are a shutdown function for power-sensitive applications as well as headphone interface logic that mutes the output when the speaker drive is not required. Internal thermal and short-circuit protection increases device reliability. It also includes headphone interface logic circuitry to facilitate headphone applications. The amplifier is available in a 16-pin SOIC surface-mount package that reduces board space and facilitates automated assembly.

### TYPICAL APPLICATION CIRCUIT

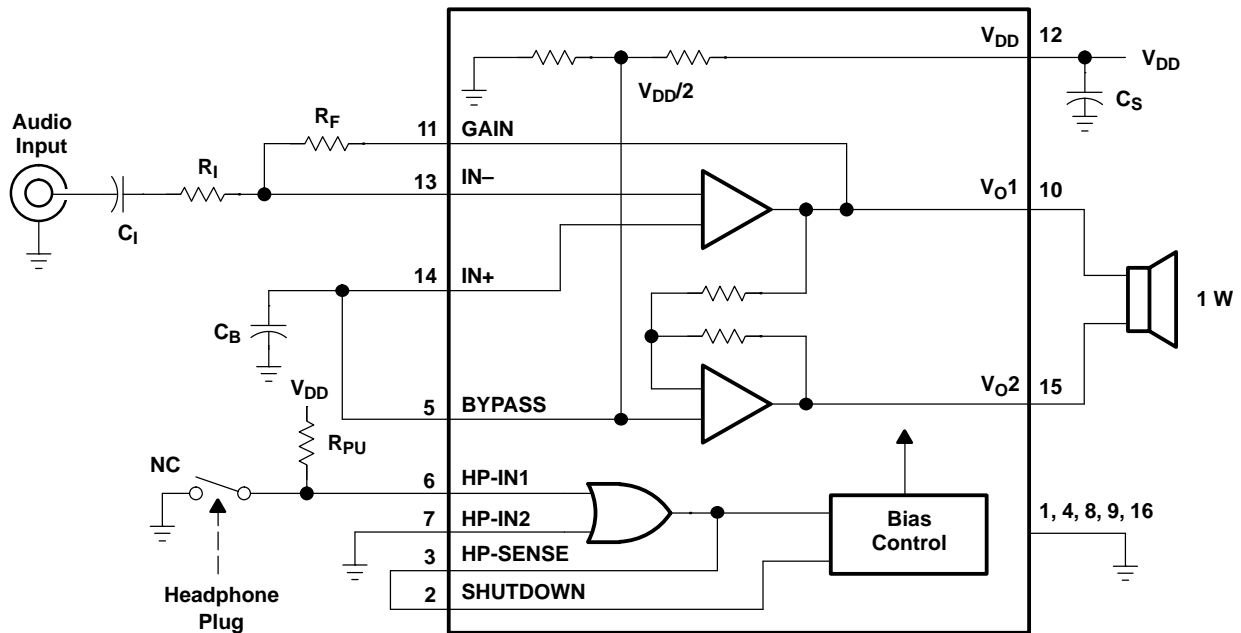

Please be aware that an important notice concerning availability, standard warranty, and use in critical applications of Texas Instruments semiconductor products and disclaimers thereto appears at the end of this data sheet.



These devices have limited built-in ESD protection. The leads should be shorted together or the device placed in conductive foam during storage or handling to prevent electrostatic damage to the MOS gates.

**AVAILABLE OPTIONS**

$T_A$	<b>PACKAGED DEVICE</b>
	<b>SMALL OUTLINE (D)</b>
–40°C to 85°C	TPA4860D

**ABSOLUTE MAXIMUM RATINGS**

over operating free-air temperature range (unless otherwise noted) <sup>(1)</sup>

	<b>UNIT</b>
$V_{DD}$ Supply voltage	6 V
$V_I$ Input voltage	–0.3 V to $V_{DD}$ +0.3 V
Continuous total power dissipation	Internally Limited (See Dissipation Rating Table)
$T_A$ Operating free-air temperature range	–40°C to 85°C
$T_{stg}$ Storage temperature range	–65°C to 150°C
Lead temperature 1,6 mm (1/16 inch) from case for 10 seconds	260°C

(1) Stresses beyond those listed under "absolute maximum ratings" may cause permanent damage to the device. These are stress ratings only, and functional operation of the device at these or any other conditions beyond those indicated under "recommended operating conditions" is not implied. Exposure to absolute-maximum-rated conditions for extended periods may affect device reliability.

**DISSIPATION RATING TABLE**

<b>PACKAGE</b>	$T_A \leq 25^\circ\text{C}$	<b>DERATING FACTOR</b>	$T_A = 70^\circ\text{C}$	$T_A = 85^\circ\text{C}$
D	1250 mW	10 mW/°C	800 mW	650 mW

**RECOMMENDED OPERATING CONDITIONS**

		<b>MIN</b>	<b>MAX</b>	<b>UNIT</b>
$V_{DD}$ Supply voltage		2.7	5.5	V
$V_{IC}$ Common-mode input voltage	$V_{DD} = 3.3\text{ V}$	1.25	2.7	V
	$V_{DD} = 5\text{ V}$	1.25	4.5	V
$T_A$ Operating free-air temperature		–40	85	°C

## ELECTRICAL CHARACTERISTICS

at specified free-air temperature range,  $V_{DD} = 3.3\text{ V}$  (unless otherwise noted)

PARAMETER		TEST CONDITIONS	TPA4860			UNIT
			MIN	TYP	MAX	
$V_{OO}$	Output offset voltage (measured differentially)	See <sup>(1)</sup>		5	20	mV
	Supply ripple rejection ratio	$V_{DD} = 3.2\text{ V to }3.4\text{ V}$		75		dB
$I_{DD}$	Quiescent current			2.5		mA
$I_{DD(M)}$	Quiescent current, mute mode			750		$\mu\text{A}$
$I_{DD(SD)}$	Quiescent current, shutdown mode			0.6		$\mu\text{A}$
$V_{IH}$	High-level input voltage (HP-IN)			1.7		V
$V_{IL}$	Low-level input voltage (HP-IN)			1.7		V
$V_{OH}$	High-level output voltage (HP-SENSE)	$I_O = 100\ \mu\text{A}$	2.5	2.8		V
$V_{OL}$	Low-level output voltage (HP-SENSE)	$I_O = -100\ \mu\text{A}$		0.2	0.8	V

(1) At  $3\text{ V} < V_{DD} < 5\text{ V}$  the dc output voltage is approximately  $V_{DD}/2$ .

## OPERATING CHARACTERISTICS

 $V_{DD} = 3.3\text{ V}$ ,  $T_A = 25^\circ\text{C}$ ,  $R_L = 8\ \Omega$ 

PARAMETER		TEST CONDITIONS	TPA4860			UNIT
			MIN	TYP	MAX	
$P_O$	Output power <sup>(1)</sup>	THD = 0.2%, $f = 1\text{ kHz}$ , $A_V = 2$		350		mW
		THD = 2%, $f = 1\text{ kHz}$ , $A_V = 2$		500		mW
$B_{OM}$	Maximum output power bandwidth	Gain = 10, THD = 2%		20		kHz
$B_1$	Unity-gain bandwidth	Open loop		1.5		MHz
	Supply ripple rejection ratio	BTL	$f = 1\text{ kHz}$	56		dB
		SE	$f = 1\text{ kHz}$	30		dB
$V_n$	Noise output voltage <sup>(2)</sup>	Gain = 2		20		$\mu\text{V}$

(1) Output power is measured at the output terminals of the device.

(2) Noise voltage is measured in a bandwidth of 20 Hz to 20 kHz.

### ELECTRICAL CHARACTERISTICS

at specified free-air temperature range,  $V_{DD} = 5\text{ V}$  (unless otherwise noted)

PARAMETER		TEST CONDITIONS	TPA4860			UNIT
			MIN	TYP	MAX	
$V_{OO}$	Output offset voltage	See <sup>(1)</sup>		5	20	mV
	Supply ripple rejection ratio	$V_{DD} = 4.9\text{ V to }5.1\text{ V}$		70		dB
$I_{DD}$	Supply current			3.5		mA
$I_{DD(M)}$	Supply current, mute			750		$\mu\text{A}$
$I_{DD(SD)}$	Supply current, shutdown			0.6		$\mu\text{A}$
$V_{IH}$	High-level input voltage (HP-IN)			2.5		V
$V_{IL}$	Low-level input voltage (HP-IN)			2.5		V
$V_{OH}$	High-level output voltage (HP-SENSE)	$I_O = 500\ \mu\text{A}$	2.5	2.8		V
$V_{OL}$	Low-level output voltage (HP-SENSE)	$I_O = -500\ \mu\text{A}$		0.2	0.8	V

(1) At  $3\text{ V} < V_{DD} < 5\text{ V}$  the dc output voltage is approximately  $V_{DD}/2$ .

### OPERATING CHARACTERISTICS

$V_{DD} = 5\text{ V}$ ,  $T_A = 25^\circ\text{C}$ ,  $R_L = 8\ \Omega$

PARAMETER		TEST CONDITIONS	TPA4860			UNIT
			MIN	TYP	MAX	
$P_O$	Output power <sup>(1)</sup>	THD = 0.2%, $f = 1\text{ kHz}$ , $A_V = 2$		1000		mW
		THD = 2%, $f = 1\text{ kHz}$ , $A_V = 2$		1100		mW
$B_{OM}$	Maximum output power bandwidth	Gain = 10, THD = 2%		20		kHz
$B_1$	Unity-gain bandwidth	Open loop		1.5		MHz
	Supply ripple rejection ratio	BTL		56		dB
		SE	$f = 1\text{ kHz}$	30		dB
$V_n$	Noise output voltage <sup>(2)</sup>	Gain = 2		20		$\mu\text{V}$

(1) Output power is measured at the output terminals of the device.

(2) Noise voltage is measured in a bandwidth of 20 Hz to 20 kHz.

**TYPICAL CHARACTERISTICS**

**Table of Graphs**

			FIGURE
$V_{OO}$	Output offset voltage	Distribution	1,2
$I_{DD}$	Supply current distribution	vs Free-air temperature	3,4
THD+N	Total harmonic distortion plus noise	vs Frequency	5, 6, 7, 8, 9, 10,11,15, 16,17,18
		vs Output power	12, 13, 14, 19,20,21
$I_{DD}$	Supply current	vs Supply voltage	22
$V_n$	Output noise voltage	vs Frequency	23, 24
	Maximum package power dissipation	vs Free-air temperature	25
	Power dissipation	vs Output power	26, 27
	Maximum output power	vs Free-air temperature	28
	Output power	vs Load resistance	29
		vs Supply voltage	30
	Open-loop frequency response	vs Frequency	31
	Supply ripple rejection ratio	vs Frequency	32, 33

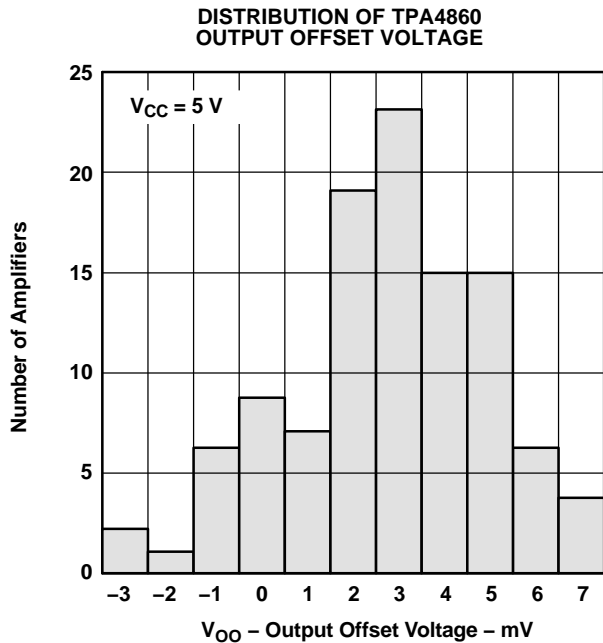

Figure 1.

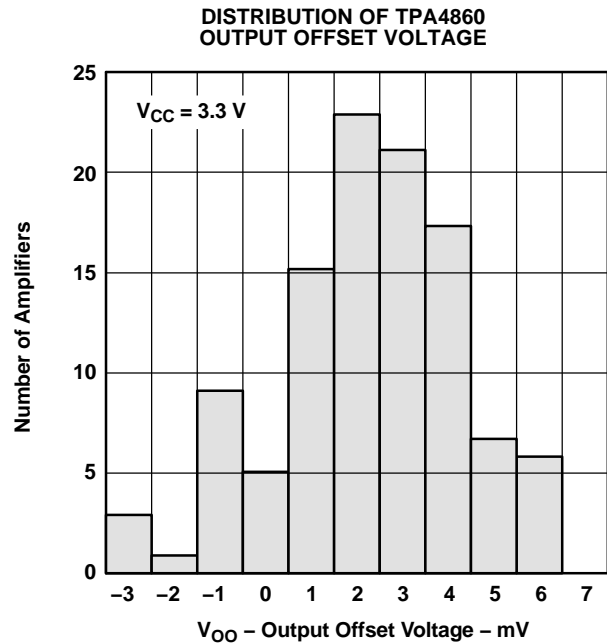

Figure 2.

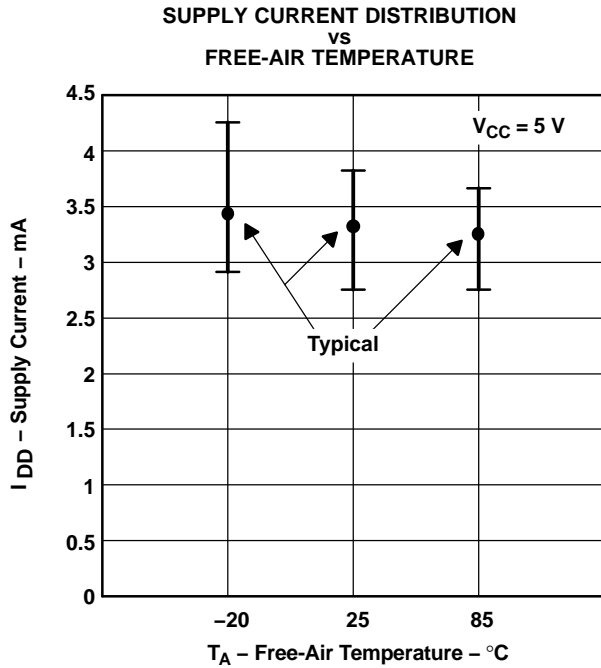

Figure 3.

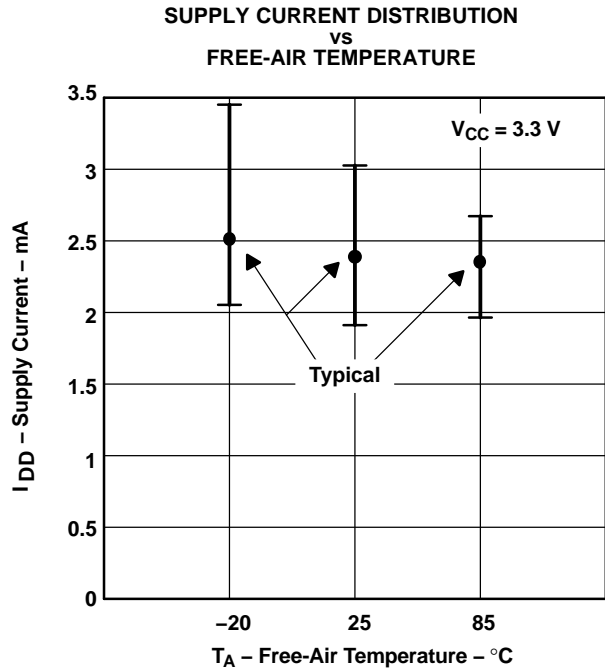

Figure 4.

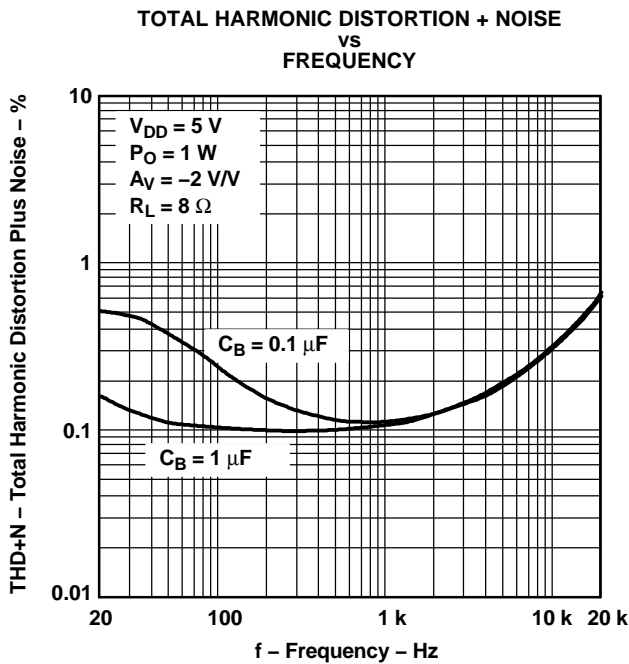

Figure 5.

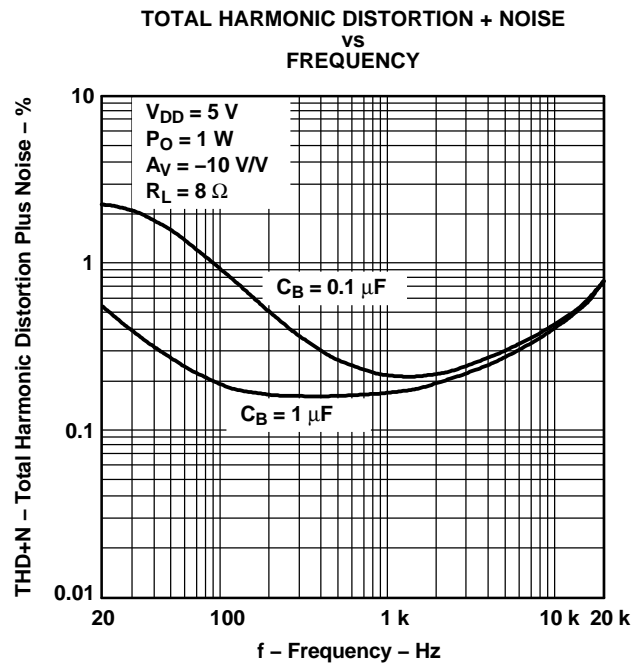

Figure 6.

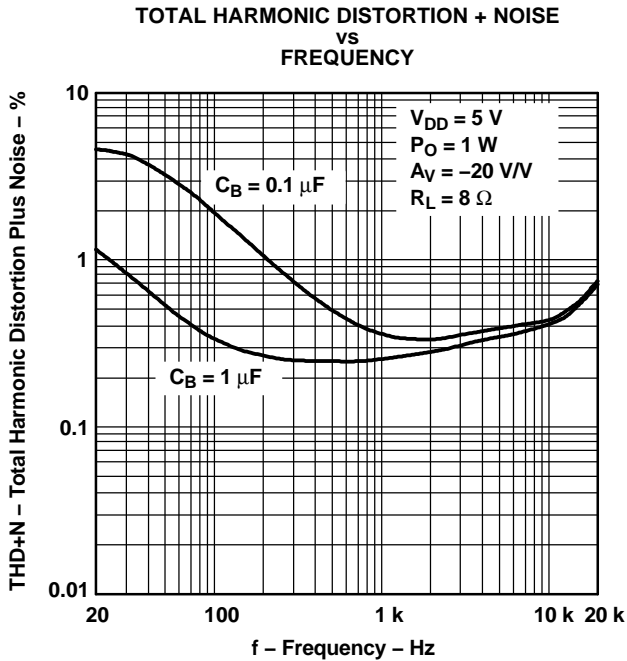

Figure 7.

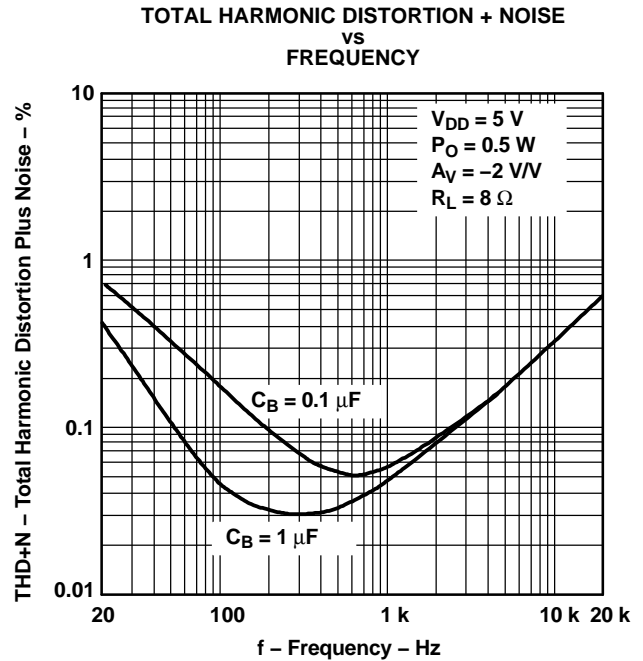

Figure 8.

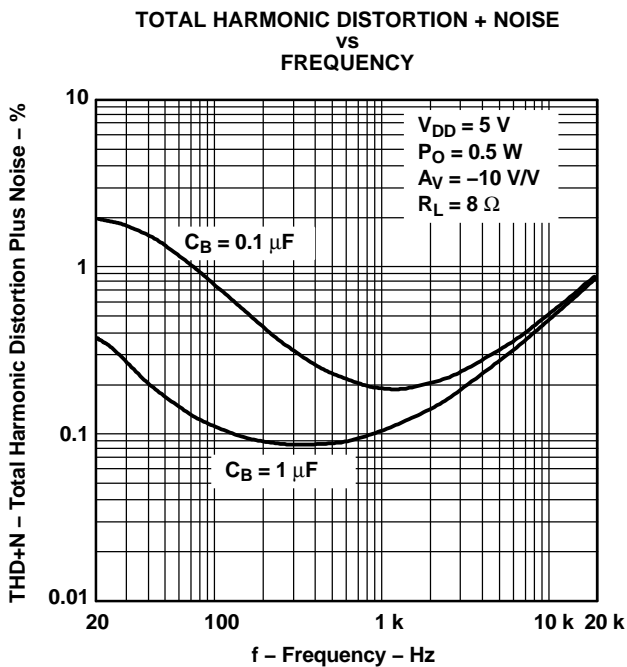

Figure 9.

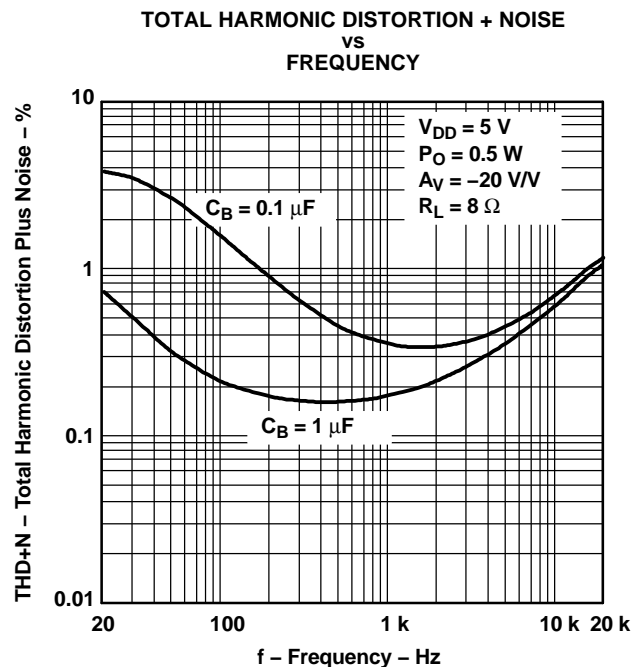

Figure 10.

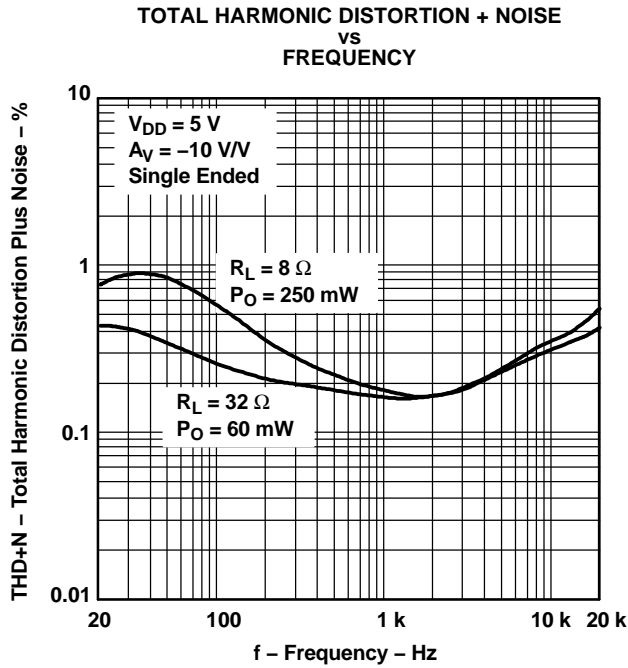

Figure 11.

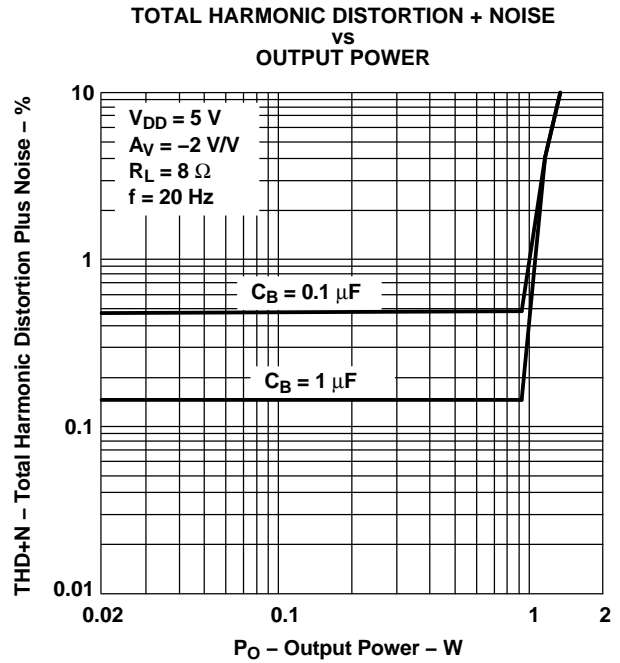

Figure 12.

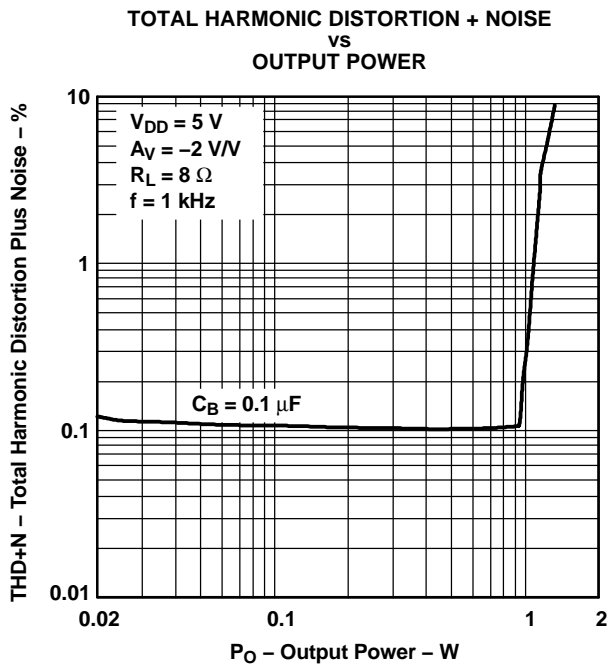

Figure 13.

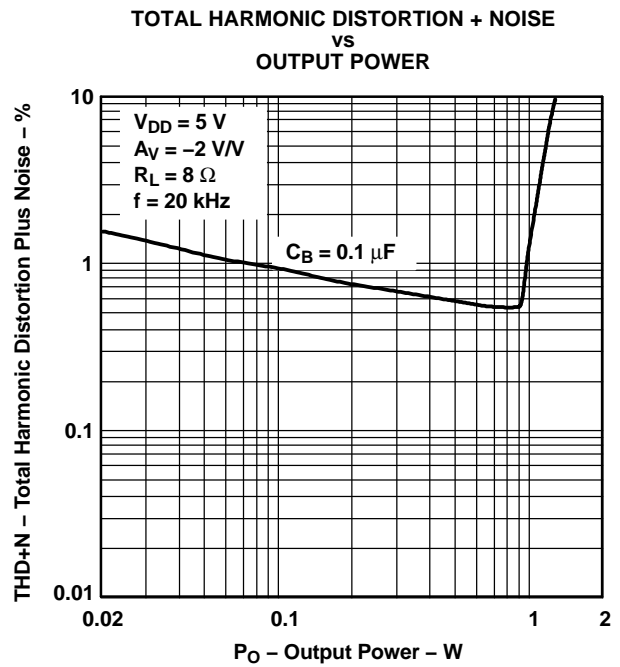

Figure 14.



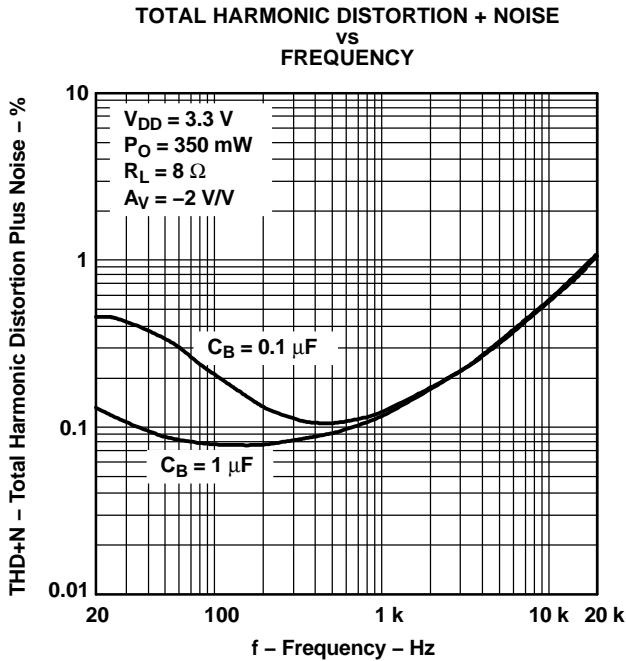

Figure 15.

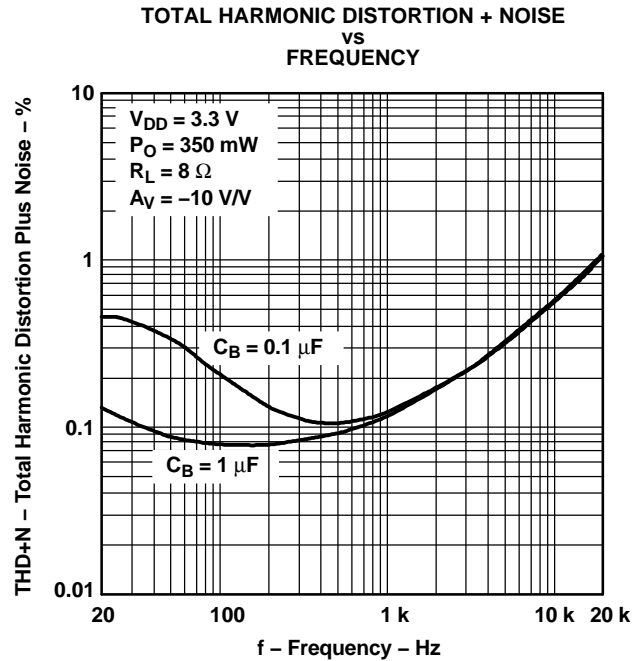

Figure 16.

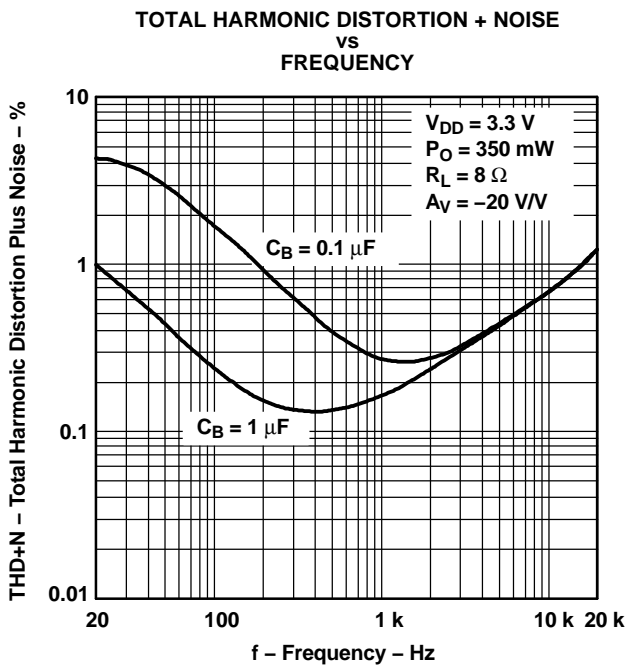

Figure 17.

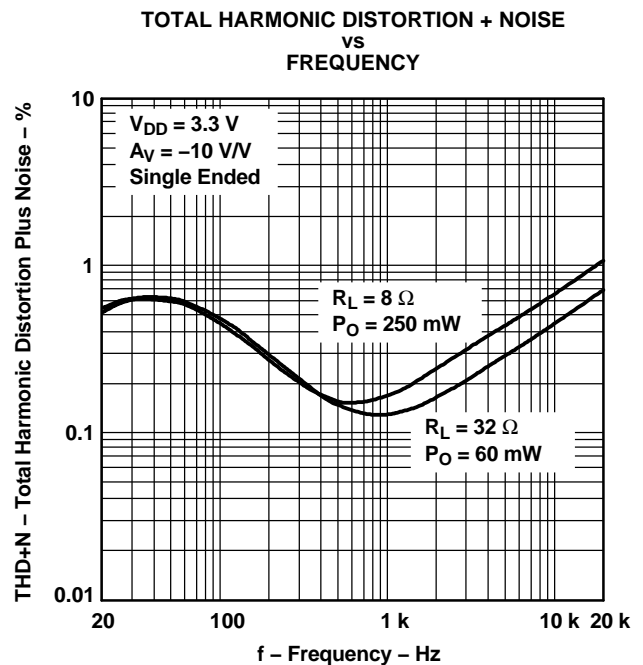

Figure 18.

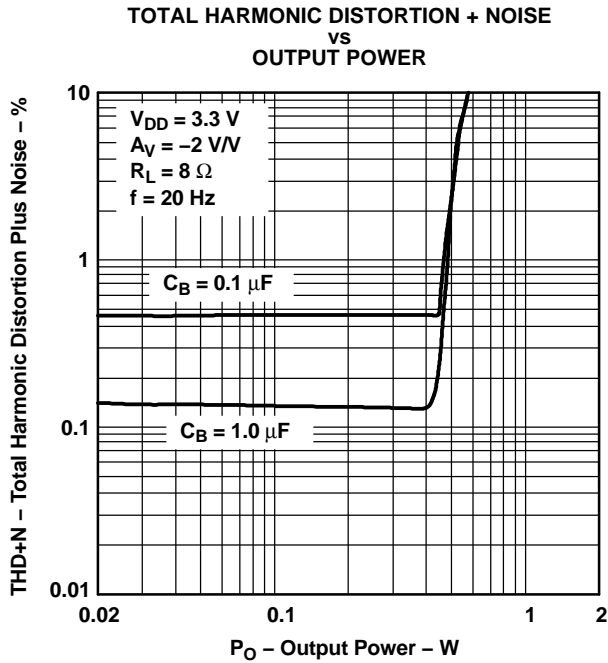

Figure 19.

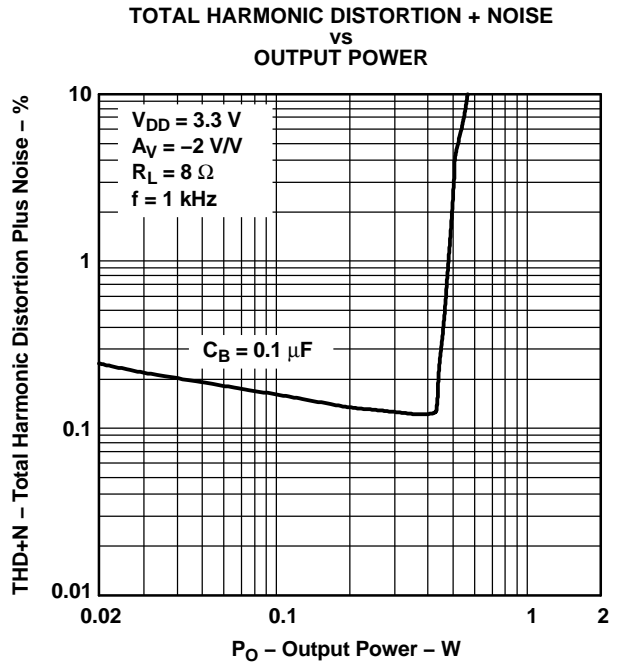

Figure 20.

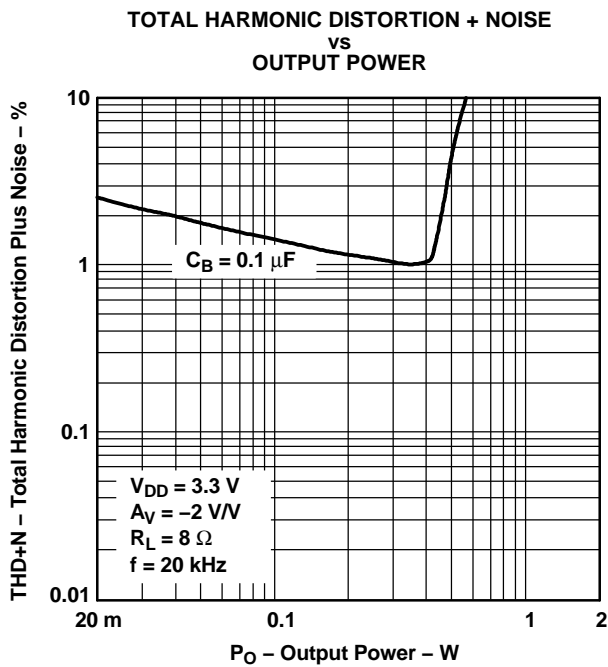

Figure 21.

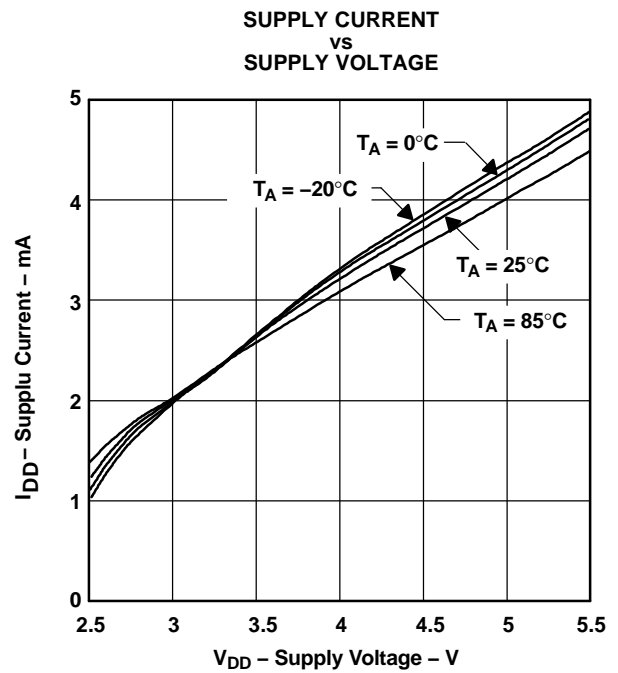

Figure 22.

**OUTPUT NOISE VOLTAGE  
VS  
FREQUENCY**

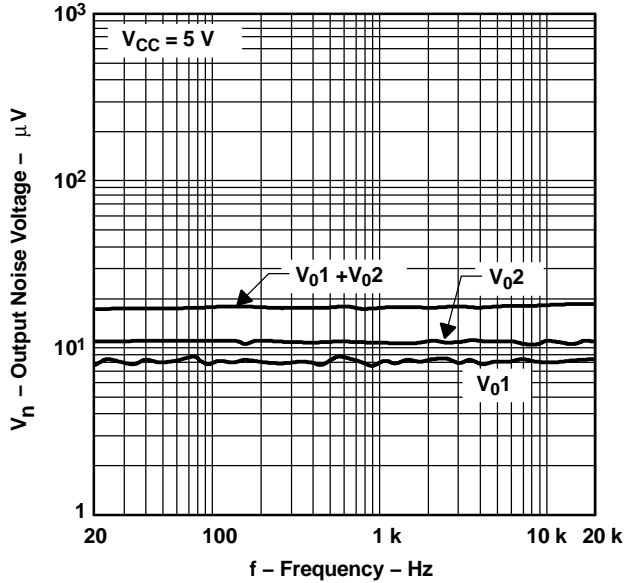

Figure 23.

**OUTPUT NOISE VOLTAGE  
VS  
FREQUENCY**

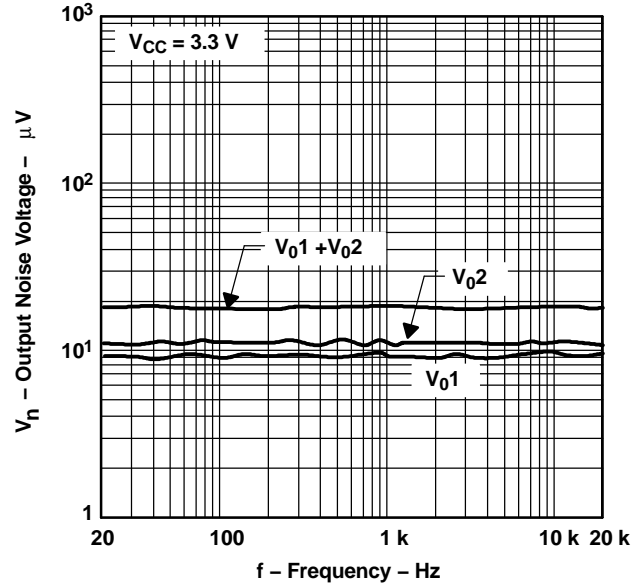

Figure 24.

**MAXIMUM PACKAGE POWER DISSIPATION  
VS  
FREE-AIR TEMPERATURE**

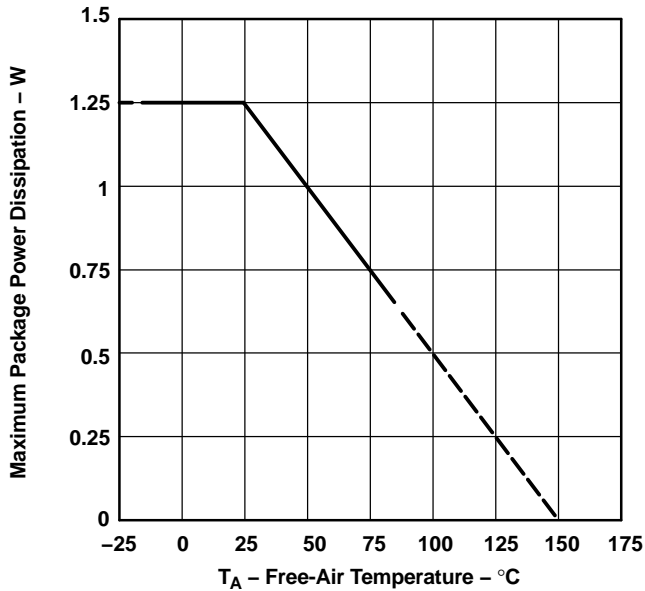

Figure 25.

**POWER DISSIPATION  
VS  
OUTPUT POWER**

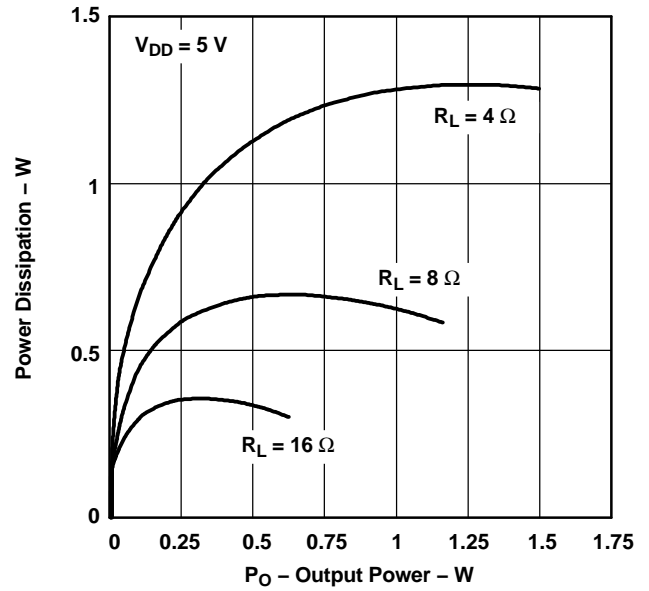
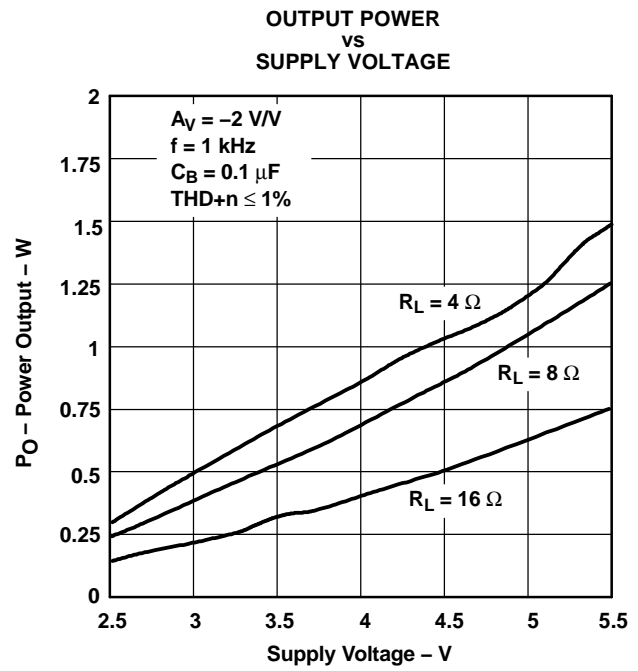
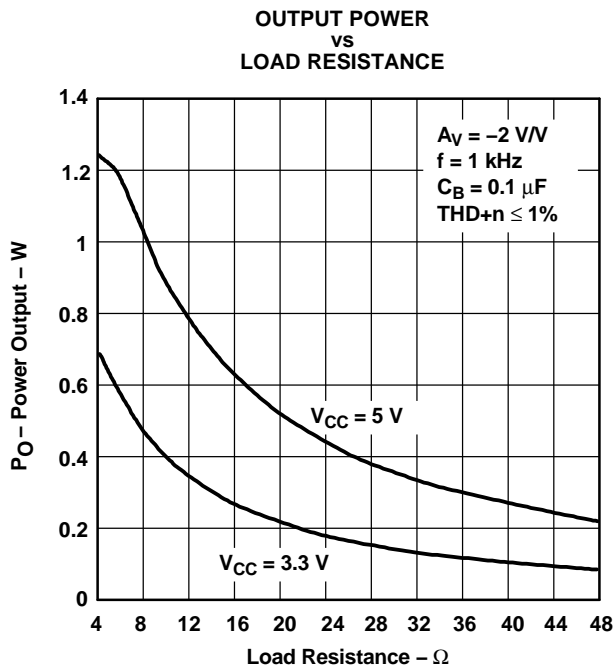
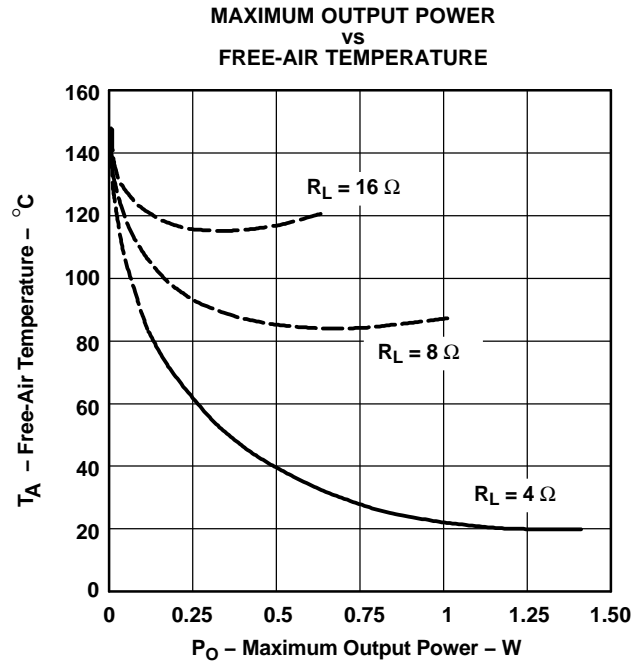
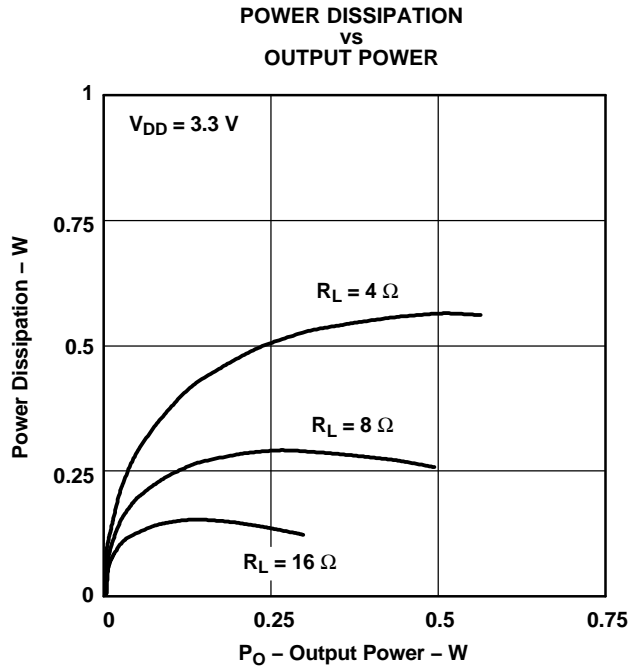

Figure 26.



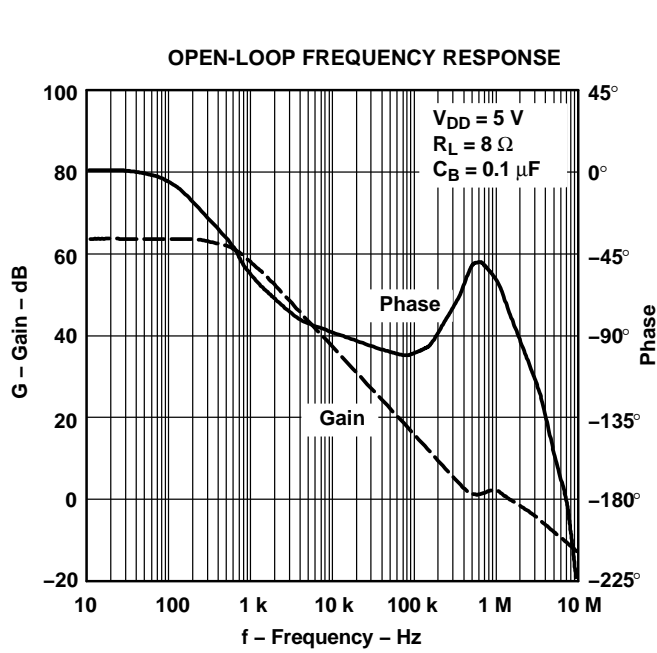

Figure 31.

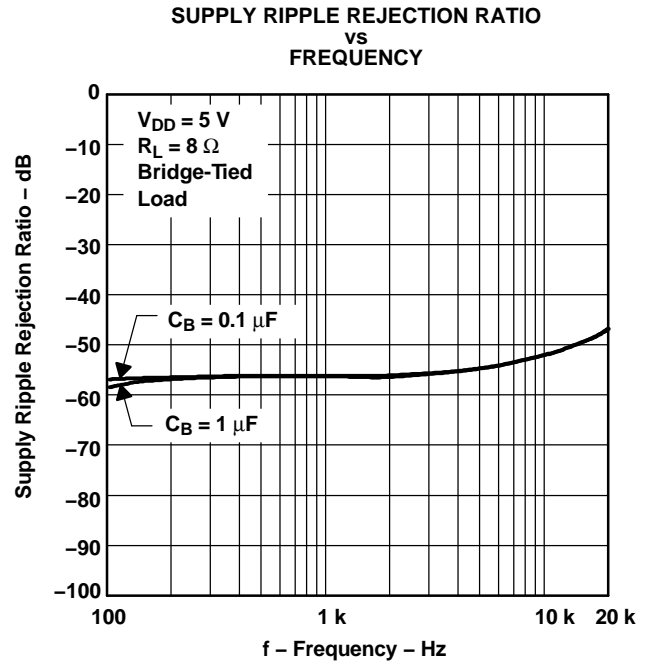

Figure 32.

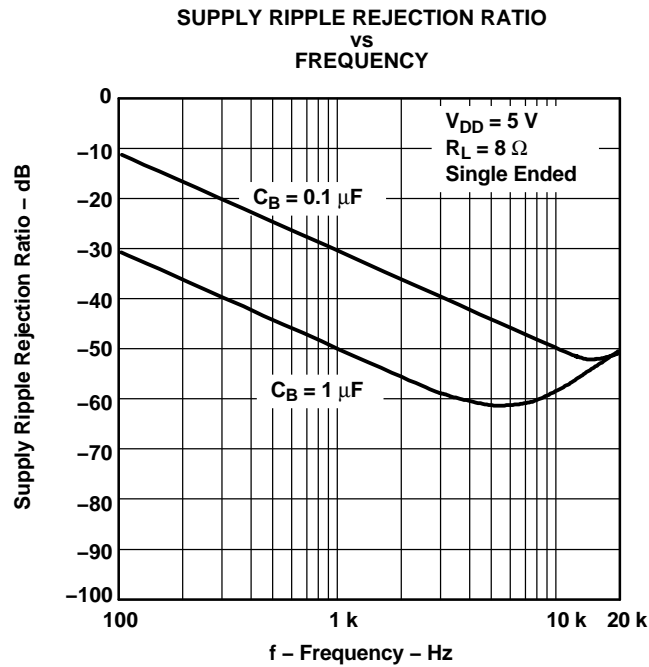

Figure 33.

APPLICATION INFORMATION

BRIDGED-TIED LOAD VERSUS SINGLE-ENDED MODE

Figure 34 shows a linear audio power amplifier (APA) in a bridge-tied load (BTL) configuration. A BTL amplifier actually consists of two linear amplifiers driving both ends of the load. There are several potential benefits to this differential drive configuration but initially let us consider power to the load. The differential drive to the speaker means that as one side is slewing up the other side is slewing down and vice versa. This, in effect, doubles the voltage swing on the load as compared to a ground-referenced load. Plugging twice the voltage into the power equation, where voltage is squared, yields 4 times the output power from the same supply rail and load impedance (see Equation 1).

$$V_{(RMS)} = \frac{V_{O(PP)}}{2\sqrt{2}}$$

$$Power = \frac{V_{(RMS)}^2}{R_L} \tag{1}$$

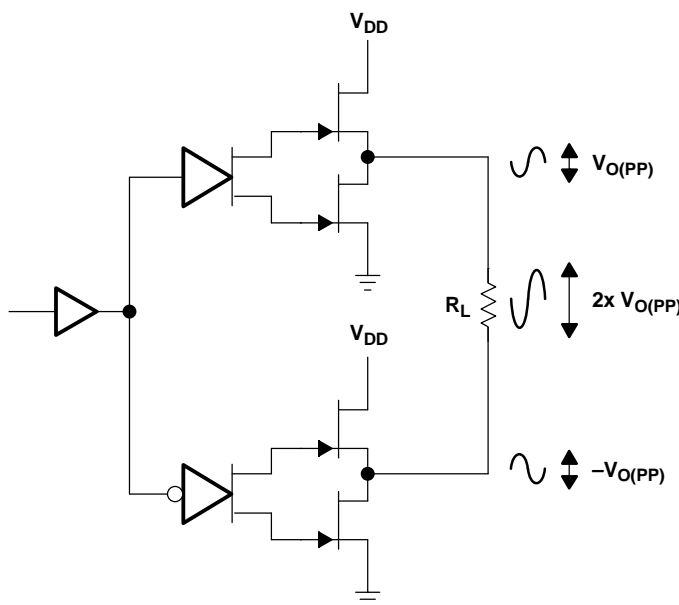

Figure 34. Bridge-Tied Load Configuration

In a typical computer sound channel operating at 5 V, bridging raises the power into an 8-Ω speaker from a singled-ended (SE) limit of 250 mW to 1 W. In sound power, that is a 6-dB improvement which is loudness that can be heard. In addition to increased power there are frequency response concerns; consider the single-supply SE configuration shown in Figure 35. A coupling capacitor is required to block the dc offset voltage from reaching the load. These capacitors can be quite large (approximately 40 μF to 1000 μF); so, they tend to be expensive, occupy valuable PCB area, and have the additional drawback of limiting low-frequency performance of the system. This frequency-limiting effect is due to the high-pass filter network created with the speaker impedance and the coupling capacitance and is calculated with Equation 2.

$$f_c = \frac{1}{2\pi R_L C_C} \tag{2}$$

For example, a 68-μF capacitor with an 8-Ω speaker would attenuate low frequencies below 293 Hz. The BTL configuration cancels the dc offsets, which eliminates the need for the blocking capacitors. Low-frequency performance is then limited only by the input network and speaker response. Cost and PCB space are also minimized by eliminating the bulky coupling capacitor.

**APPLICATION INFORMATION (continued)**

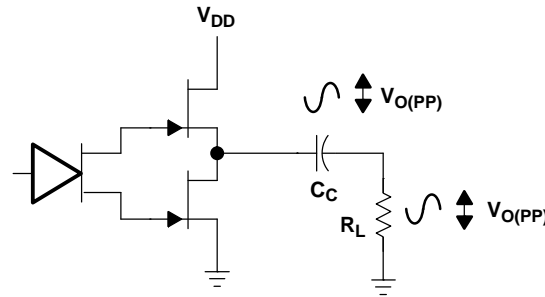

**Figure 35. Single-Ended Configuration**

Increasing power to the load does carry a penalty of increased internal power dissipation. The increased dissipation is understandable considering that the BTL configuration produces 4 times the output power of the SE configuration. Internal dissipation versus output power is discussed further in the *thermal considerations* section.

**BTL AMPLIFIER EFFICIENCY**

Linear amplifiers are notoriously inefficient. The primary cause of these inefficiencies is voltage drop across the output stage transistors. The internal voltage drop has two components. One is the headroom or dc voltage drop that varies inversely to output power. The second component is due to the sine-wave nature of the output. The total voltage drop can be calculated by subtracting the RMS value of the output voltage from  $V_{DD}$ . The internal voltage drop multiplied by the RMS value of the supply current,  $I_{DD(RMS)}$ , determines the internal power dissipation of the amplifier.

An easy-to-use equation to calculate efficiency starts out as being equal to the ratio of power from the power supply to the power delivered to the load. To accurately calculate the RMS values of power in the load and in the amplifier, the current and voltage waveform shapes must first be understood (see Figure 36).

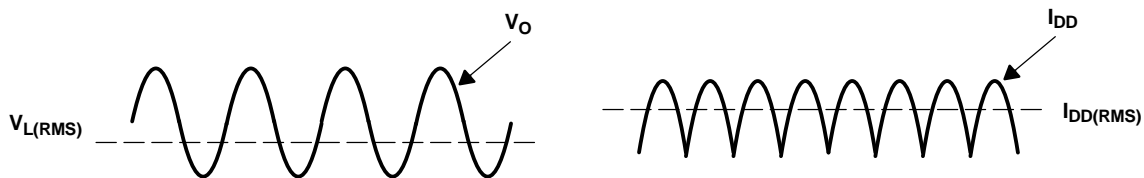

**Figure 36. Voltage and Current Waveforms for BTL Amplifiers**

Although the voltages and currents for SE and BTL are sinusoidal in the load, currents from the supply are different between SE and BTL configurations. In an SE application the current waveform is a half-wave rectified shape, whereas in BTL it is a full-wave rectified waveform. This means RMS conversion factors are different. Keep in mind that for most of the waveform both the push and pull transistor are not on at the same time, which supports the fact that each amplifier in the BTL device only draws current from the supply for half the waveform. The following equations are the basis for calculating amplifier efficiency.

**APPLICATION INFORMATION (continued)**

$$\text{Efficiency} = \frac{P_L}{P_{SUP}}$$

Where:

$$V_{L(RMS)} = \frac{V_P}{\sqrt{2}}$$

$$P_L = \frac{V_{L(RMS)}^2}{R_L} = \frac{V_P^2}{2R_L}$$

$$P_{SUP} = V_{DD} I_{DD(RMS)} = \frac{V_{DD} 2V_P}{\pi R_L}$$

$$I_{DD(RMS)} = \frac{2V_P}{\pi R_L}$$

(3)

$$\text{Efficiency of a BTL configuration} = \frac{\pi V_P}{2V_{DD}} = \frac{\pi \left( \frac{P_L R_L}{2} \right)^{1/2}}{2V_{DD}}$$

(4)

Table 1 employs Equation 4 to calculate efficiencies for four different output power levels. Note that the efficiency of the amplifier is quite low for lower power levels and rises sharply as power to the load is increased, resulting in a nearly flat internal power dissipation over the normal operating range. Note that the internal dissipation at full output power is less than in the half power range. Calculating the efficiency for a specific system is the key to proper power supply design. For a stereo 1-W audio system with 8-Ω loads and a 5-V supply, the maximum draw on the power supply is almost 3.25 W.

**Table 1. Efficiency vs Output Power in 5-V 8-Ω BTL Systems**

OUTPUT POWER (W)	EFFICIENCY (%)	PEAK-TO-PEAK VOLTAGE (V)	INTERNAL DISSIPATION (W)
0.25	31.4	2.00	0.55
0.50	44.4	2.83	0.62
1.00	62.8	4.00	0.59
1.25	70.2	4.47 <sup>(1)</sup>	0.53

(1) High peak voltages cause the THD to increase.

A final point to remember about linear amplifiers whether they are SE or BTL configured is how to manipulate the terms in the efficiency equation to utmost advantage when possible. Note that in Equation 4,  $V_{DD}$  is in the denominator. This indicates that as  $V_{DD}$  goes down, efficiency goes up.

For example, if the 5-V supply is replaced with a 10-V supply (TPA4860 has a maximum recommended  $V_{DD}$  of 5.5 V) in the calculations of Table 1, then efficiency at 1 W would fall to 31% and internal power dissipation would rise to 2.18 W from 0.59 W at 5 V. Then, for a stereo 1-W system from a 10-V supply, the maximum draw would be almost 6.5 W. Choose the correct supply voltage and speaker impedance for the application.



## SELECTION OF COMPONENTS

Figure 37 is a schematic diagram of a typical notebook computer application circuit.

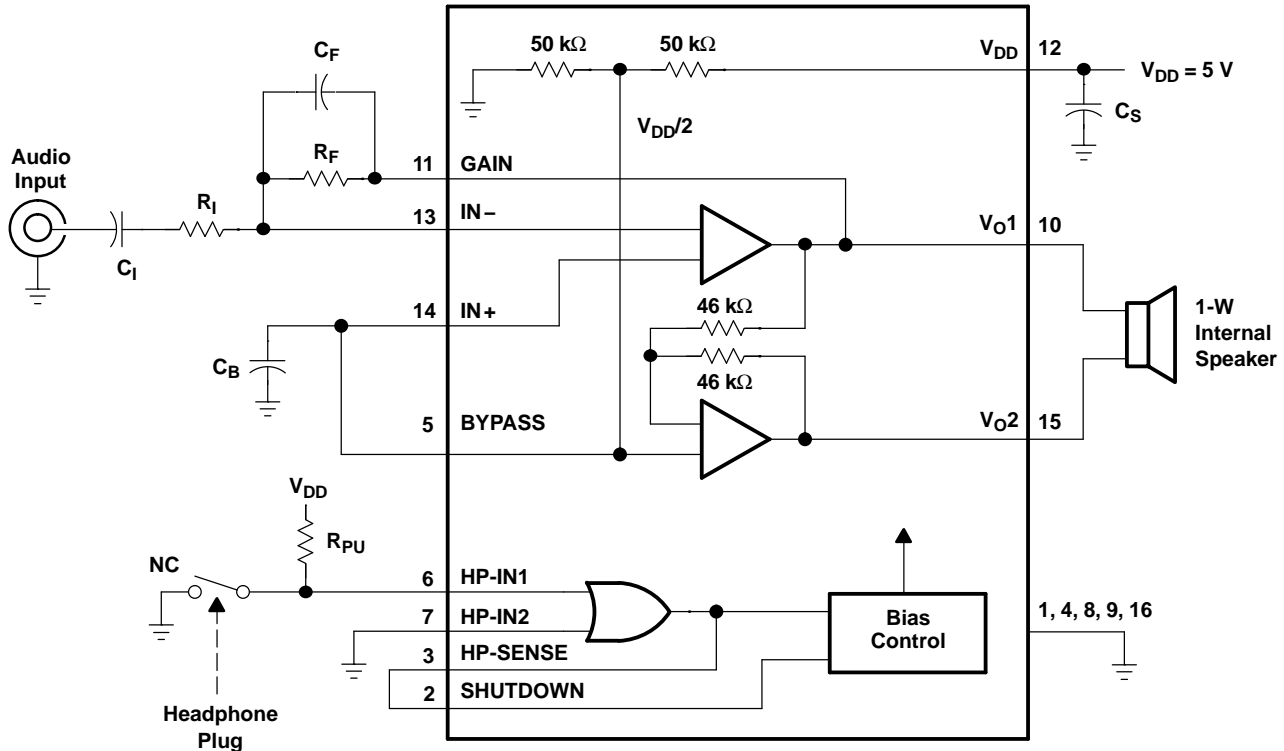

Figure 37. TPA4860 Typical Notebook Computer Application Circuit

### Gain Setting Resistors, $R_F$ and $R_I$

The gain for the TPA4860 is set by resistors  $R_F$  and  $R_I$  according to Equation 5.

$$\text{Gain} = -2 \left( \frac{R_F}{R_I} \right) \quad (5)$$

BTL mode operation brings about the factor of 2 in the gain equation due to the inverting amplifier mirroring the voltage swing across the load. Given that the TPA4860 is a MOS amplifier, the input impedance is high; consequently, input leakage currents are not generally a concern although noise in the circuit increases as the value of  $R_F$  increases. In addition, a certain range of  $R_F$  values is required for proper start-up operation of the amplifier. Taken together, it is recommended that the effective impedance seen by the inverting node of the amplifier be set between 5 k $\Omega$  and 20 k $\Omega$ . The effective impedance is calculated in Equation 6.

$$\text{Effective Impedance} = \frac{R_F R_I}{R_F + R_I} \quad (6)$$

As an example, consider an input resistance of 10 k $\Omega$  and a feedback resistor of 50 k $\Omega$ . The gain of the amplifier would be  $-10$  and the effective impedance at the inverting terminal would be 8.3 k $\Omega$ , which is well within the recommended range.

For high-performance applications metal film resistors are recommended because they tend to have lower noise levels than carbon resistors. For values of  $R_F$  above 50 k $\Omega$ , the amplifier tends to become unstable due to a pole formed from  $R_F$  and the inherent input capacitance of the MOS input structure. For this reason, a small compensation capacitor of approximately 5 pF should be placed in parallel with  $R_F$ . In effect, this creates a low-pass filter network with the cutoff frequency defined in Equation 7.

$$f_{c(\text{lowpass})} = \frac{1}{2\pi R_F C_F} \quad (7)$$

For example, if  $R_F$  is 100 k $\Omega$  and  $C_F$  is 5 pF, then  $f_c$  is 318 kHz, which is well outside of the audio range.

### Input Capacitor, $C_I$

In the typical application, an input capacitor,  $C_I$  is required to allow the amplifier to bias the input signal to the proper dc level for optimum operation. In this case,  $C_I$  and  $R_I$  form a high-pass filter with the corner frequency determined in Equation 8.

$$f_{c(\text{highpass})} = \frac{1}{2\pi R_I C_I} \quad (8)$$

The value of  $C_I$  is important to consider as it directly affects the bass (low-frequency) performance of the circuit. Consider the example where  $R_I$  is 10 k $\Omega$  and the specification calls for a flat bass response down to 40 Hz. Equation 8 is reconfigured as Equation 9.

$$C_I = \frac{1}{2\pi R_I f_c} \quad (9)$$

In this example,  $C_I$  is 0.40  $\mu\text{F}$ ; so, one would likely choose a value in the range of 0.47  $\mu\text{F}$  to 1  $\mu\text{F}$ . A further consideration for this capacitor is the leakage path from the input source through the input network ( $R_I$ ,  $C_I$ ) and the feedback resistor ( $R_F$ ) to the load. This leakage current creates a dc-offset voltage at the input to the amplifier that reduces useful headroom, especially in high-gain applications. For this reason a low-leakage tantalum or ceramic capacitor is the best choice. When polarized capacitors are used, the positive side of the capacitor should face the amplifier input in most applications as the dc level there is held at  $V_{DD}/2$ , which is likely higher than the source dc level. Note that it is important to confirm the capacitor polarity in the application.

### POWER SUPPLY DECOUPLING $C_S$

The TPA4860 is a high-performance CMOS audio amplifier that requires adequate power supply decoupling to ensure the output total harmonic distortion (THD) is as low as possible. Power supply decoupling also prevents oscillations for long lead lengths between the amplifier and the speaker. The optimum decoupling is achieved by using two capacitors of different types that target different types of noise on the power supply leads. For higher frequency transients, spikes, or digital hash on the line, a good low equivalent-series-resistance (ESR) ceramic capacitor, typically 0.1  $\mu\text{F}$  placed as close as possible to the device  $V_{DD}$  lead, works best. For filtering lower-frequency noise signals, a larger aluminum electrolytic capacitor of 10  $\mu\text{F}$  or greater placed near the power amplifier is recommended.

### MIDRAIL BYPASS CAPACITOR, $C_B$

The midrail bypass capacitor,  $C_B$ , serves several important functions. During start-up or recovery from shutdown mode,  $C_B$  determines the rate at which the amplifier starts up. This helps to push the start-up pop noise into the subaudible range (so low it cannot be heard). The second function is to reduce noise produced by the power supply caused by coupling into the output drive signal. This noise is from the midrail generation circuit internal to the amplifier. The capacitor is fed from a 25-k $\Omega$  source inside the amplifier. To keep the start-up pop as low as possible, the relationship shown in Equation 10 should be maintained.

$$\frac{1}{(C_B \times 25 \text{ k}\Omega)} \leq \frac{1}{(C_I R_I)} \quad (10)$$

As an example, consider a circuit where  $C_B$  is 0.1  $\mu\text{F}$ ,  $C_I$  is 0.22  $\mu\text{F}$  and  $R_I$  is 10 k $\Omega$ . Inserting these values into the Equation 9, we get:  $400 \leq 454$  which satisfies the rule. Recommended value for bypass capacitor  $C_B$  is 0.1- $\mu\text{F}$  to 1- $\mu\text{F}$  ceramic or tantalum low-ESR for the best THD and noise performance.

## SINGLE-ENDED OPERATION

Figure 38 is a schematic diagram of the recommended SE configuration. In SE mode configurations, the load should be driven from the primary amplifier output ( $V_{O1}$ , terminal 10).

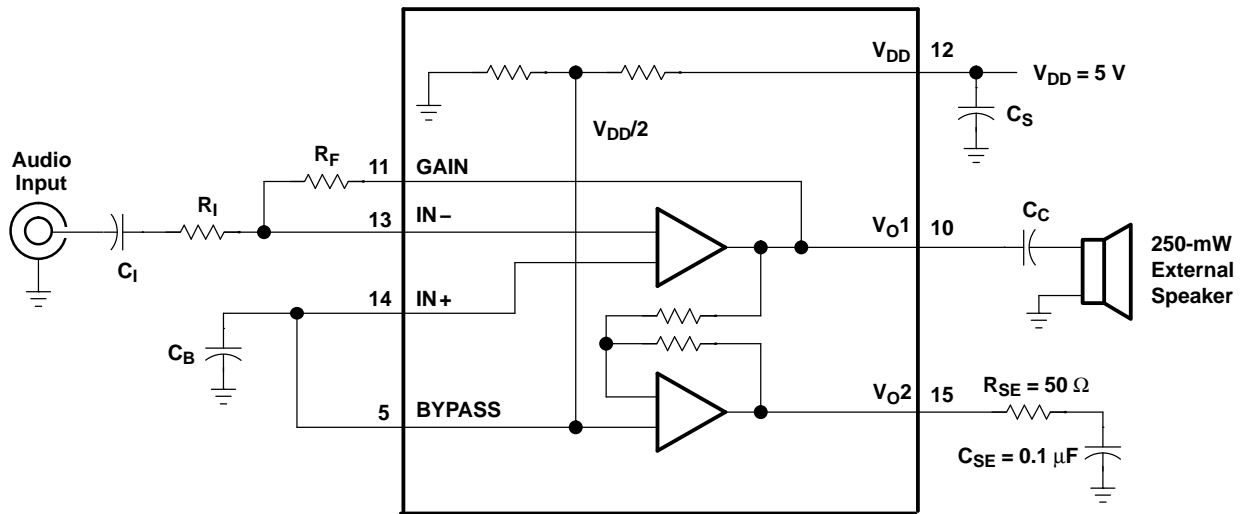

**Figure 38. Single-Ended Mode**

Gain is set by the  $R_F$  and  $R_I$  resistors and is shown in Equation 11. Because the inverting amplifier is not used to mirror the voltage swing on the load, the factor of 2 is not included.

$$\text{Gain} = - \left( \frac{R_F}{R_I} \right) \quad (11)$$

The phase margin of the inverting amplifier into an open circuit is not adequate to ensure stability, so a termination load should be connected to  $V_{O2}$ . This consists of a 50- $\Omega$  resistor in series with a 0.1- $\mu\text{F}$  capacitor to ground. It is important to avoid oscillation of the inverting output to minimize noise and power dissipation.

The output coupling capacitor required in single-supply SE mode also places additional constraints on the selection of other components in the amplifier circuit. The rules described earlier still hold with the addition of the following relationship:

$$\frac{1}{(C_B \times 25 \text{ k}\Omega)} \leq \frac{1}{(C_I R_I)} \ll \frac{1}{R_L C_C} \quad (12)$$

## OUTPUT COUPLING CAPACITOR, $C_C$

In the typical single-supply SE configuration, an output coupling capacitor ( $C_C$ ) is required to block the dc bias at the output of the amplifier, thus preventing dc currents in the load. As with the input coupling capacitor, the output coupling capacitor and impedance of the load form a high-pass filter governed by Equation 13.

$$f_{c \text{ high}} = \frac{1}{2\pi R_L C_C} \quad (13)$$

The main disadvantage, from a performance standpoint, is that the load impedances are typically small, which drives the low-frequency corner higher. Large values of  $C_C$  are required to pass low frequencies into the load. Consider the example where a  $C_C$  of 68  $\mu\text{F}$  is chosen and loads vary from 8  $\Omega$ , 32  $\Omega$ , to 47 k $\Omega$ . Table 2 summarizes the frequency response characteristics of each configuration.

**Table 2. Common Load Impedances vs Low Frequency Output Characteristics in SE Mode**

$R_L$	$C_C$	LOWEST FREQUENCY
8 $\Omega$	68 $\mu\text{F}$	293 Hz
32 $\Omega$	68 $\mu\text{F}$	73 Hz
47,000 $\Omega$	68 $\mu\text{F}$	0.05 Hz

As Table 2 indicates, most of the bass response is attenuated into 8- $\Omega$  loads while headphone response is adequate and drive into line level inputs (a home stereo for example) is good.

**HEADPHONE SENSE CIRCUITRY,  $R_{pu}$**

The TPA4860 is commonly used in systems where there is an internal speaker and a jack for driving external loads (i.e., headphones). In these applications, it is usually desirable to mute the internal speaker(s) when the external load is in use. The headphone inputs (HP-1, HP-2) and headphone output (HP-SENSE) of the TPA4860 were specifically designed for this purpose. Many standard headphone jacks are available with an internal single-pole single-throw (SPST) switch that makes or breaks a circuit when the headphone plug is inserted. Asserting either or both HP-1 and/or HP-2 high mutes the output stage of the amplifier and causes HP-SENSE to go high. In battery-powered applications where power conservation is critical, HP-SENSE can be connected to the shutdown input as shown in Figure 39. This places the amplifier in a low current state for maximum power savings. Pullup resistors in the range from 1 k $\Omega$  to 10 k $\Omega$  are recommended for 5-V and 3.3-V operation.

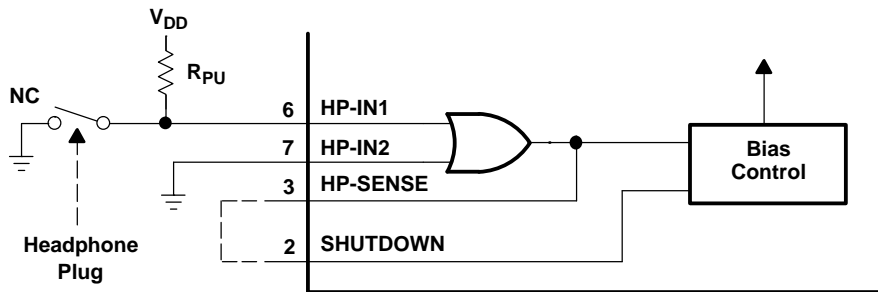

**Figure 39. Schematic Diagram of Typical Headphone Sense Application**

Table 3 details the logic for the mute function of the TPA4860.

**Table 3. Truth Table for Headphone Sense and Shutdown Functions**

INPUTS <sup>(1)</sup>			OUTPUT	AMPLIFIER STATE
HP-1	HP-2	SHUTDOWN	HP-SENSE	
Low	Low	Low	Low	Active
Low	High	Low	High	Mute
High	Low	Low	High	Mute
High	High	Low	High	Mute
X <sup>(2)</sup>	X <sup>(2)</sup>	High	X <sup>(2)</sup>	Shutdown

(1) Inputs should never be left unconnected.

(2) X = do not care

## SHUTDOWN MODE

The TPA4860 employs a shutdown mode of operation designed to reduce quiescent supply current,  $I_{DD(q)}$ , to the absolute minimum level during periods of nonuse for battery-power conservation. For example, during device sleep modes or when other audio-drive currents are used (i.e., headphone mode), the speaker drive is not required. The SHUTDOWN input terminal should be held low during normal operation when the amplifier is in use. Pulling SHUTDOWN high causes the outputs to mute and the amplifier to enter a low-current state,  $I_{DD} \sim 0.6 \mu\text{A}$ . SHUTDOWN should never be left unconnected because amplifier operation would be unpredictable.

## USING LOW-ESR CAPACITORS

Low-ESR capacitors are recommended throughout this applications section. A real capacitor can be modeled simply as a resistor in series with an ideal capacitor. The voltage drop across this resistor minimizes the beneficial effects of the capacitor in the circuit. The lower the equivalent value of this resistance, the more the real capacitor behaves like an ideal capacitor.

## THERMAL CONSIDERATIONS

A prime consideration when designing an audio amplifier circuit is internal power dissipation in the device. The curve in Figure 40 provides an easy way to determine what output power can be expected out of the TPA4860 for a given system ambient temperature in designs using 5-V supplies. This curve assumes no forced airflow or additional heat sinking.

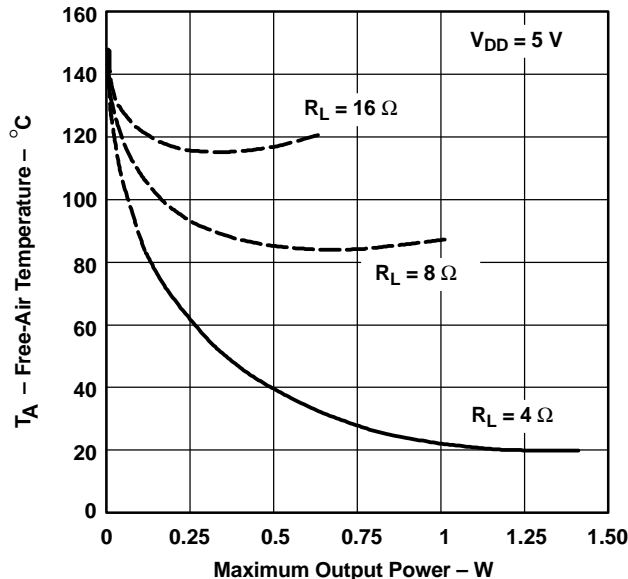

**Figure 40. Free-Air Temperature Versus Maximum Continuous Output Power**

## 5-V VERSUS 3.3-V OPERATION

The TPA4860 was designed for operation over a supply range of 2.7 V to 5.5 V. This data sheet provides full specifications for 5-V and 3.3-V operation, as these are considered to be the two most common standard voltages. There are no special considerations for 3.3-V versus 5-V operation as far as supply bypassing, gain setting, or stability. Supply current is slightly reduced from 3.5 mA (typical) to 2.5 mA (typical). The most important consideration is that of output power. Each amplifier in TPA4860 can produce a maximum voltage swing of  $V_{DD} - 1 \text{ V}$ . This means, for 3.3-V operation, clipping starts to occur when  $V_{O(PP)} = 2.3 \text{ V}$  as opposed to when  $V_{O(PP)} = 4 \text{ V}$  while operating at 5 V. The reduced voltage swing subsequently reduces maximum output power into an 8- $\Omega$  load to less than 0.33 W before distortion begins to become significant.

Operation at 3.3-V supplies, as can be shown from the efficiency formula in Equation 4, consumes approximately two-thirds the supply power for a given output-power level than operation from 5-V supplies. When the application demands less than 500 mW, 3.3-V operation should be strongly considered, especially in battery-powered applications.

**PACKAGING INFORMATION**

Orderable Device	Status (1)	Package Type	Package Drawing	Pins	Package Qty	Eco Plan (2)	Lead finish/ Ball material (6)	MSL Peak Temp (3)	Op Temp (°C)	Device Marking (4/5)	Samples
TPA4860D	ACTIVE	SOIC	D	16	40	RoHS & Green	NIPDAU	Level-1-260C-UNLIM	-40 to 85	TPA4860	<a href="#">Samples</a>
TPA4860DR	ACTIVE	SOIC	D	16	2500	RoHS & Green	NIPDAU	Level-1-260C-UNLIM	-40 to 85	TPA4860	<a href="#">Samples</a>

(1) The marketing status values are defined as follows:

**ACTIVE:** Product device recommended for new designs.

**LIFEBUY:** TI has announced that the device will be discontinued, and a lifetime-buy period is in effect.

**NRND:** Not recommended for new designs. Device is in production to support existing customers, but TI does not recommend using this part in a new design.

**PREVIEW:** Device has been announced but is not in production. Samples may or may not be available.

**OBSOLETE:** TI has discontinued the production of the device.

(2) **RoHS:** TI defines "RoHS" to mean semiconductor products that are compliant with the current EU RoHS requirements for all 10 RoHS substances, including the requirement that RoHS substance do not exceed 0.1% by weight in homogeneous materials. Where designed to be soldered at high temperatures, "RoHS" products are suitable for use in specified lead-free processes. TI may reference these types of products as "Pb-Free".

**RoHS Exempt:** TI defines "RoHS Exempt" to mean products that contain lead but are compliant with EU RoHS pursuant to a specific EU RoHS exemption.

**Green:** TI defines "Green" to mean the content of Chlorine (Cl) and Bromine (Br) based flame retardants meet JS709B low halogen requirements of <=1000ppm threshold. Antimony trioxide based flame retardants must also meet the <=1000ppm threshold requirement.

(3) MSL, Peak Temp. - The Moisture Sensitivity Level rating according to the JEDEC industry standard classifications, and peak solder temperature.

(4) There may be additional marking, which relates to the logo, the lot trace code information, or the environmental category on the device.

(5) Multiple Device Markings will be inside parentheses. Only one Device Marking contained in parentheses and separated by a "~" will appear on a device. If a line is indented then it is a continuation of the previous line and the two combined represent the entire Device Marking for that device.

(6) Lead finish/Ball material - Orderable Devices may have multiple material finish options. Finish options are separated by a vertical ruled line. Lead finish/Ball material values may wrap to two lines if the finish value exceeds the maximum column width.

**Important Information and Disclaimer:**The information provided on this page represents TI's knowledge and belief as of the date that it is provided. TI bases its knowledge and belief on information provided by third parties, and makes no representation or warranty as to the accuracy of such information. Efforts are underway to better integrate information from third parties. TI has taken and continues to take reasonable steps to provide representative and accurate information but may not have conducted destructive testing or chemical analysis on incoming materials and chemicals. TI and TI suppliers consider certain information to be proprietary, and thus CAS numbers and other limited information may not be available for release.

In no event shall TI's liability arising out of such information exceed the total purchase price of the TI part(s) at issue in this document sold by TI to Customer on an annual basis.



**TAPE AND REEL INFORMATION**

**QUADRANT ASSIGNMENTS FOR PIN 1 ORIENTATION IN TAPE**

\*All dimensions are nominal

Device	Package Type	Package Drawing	Pins	SPQ	Reel Diameter (mm)	Reel Width W1 (mm)	A0 (mm)	B0 (mm)	K0 (mm)	P1 (mm)	W (mm)	Pin1 Quadrant
TPA4860DR	SOIC	D	16	2500	330.0	16.4	6.5	10.3	2.1	8.0	16.0	Q1



**TAPE AND REEL BOX DIMENSIONS**

\*All dimensions are nominal

Device	Package Type	Package Drawing	Pins	SPQ	Length (mm)	Width (mm)	Height (mm)
TPA4860DR	SOIC	D	16	2500	350.0	350.0	43.0

**TUBE**

\*All dimensions are nominal

Device	Package Name	Package Type	Pins	SPQ	L (mm)	W (mm)	T (μm)	B (mm)
TPA4860D	D	SOIC	16	40	505.46	6.76	3810	4

D (R-PDSO-G16)

PLASTIC SMALL OUTLINE

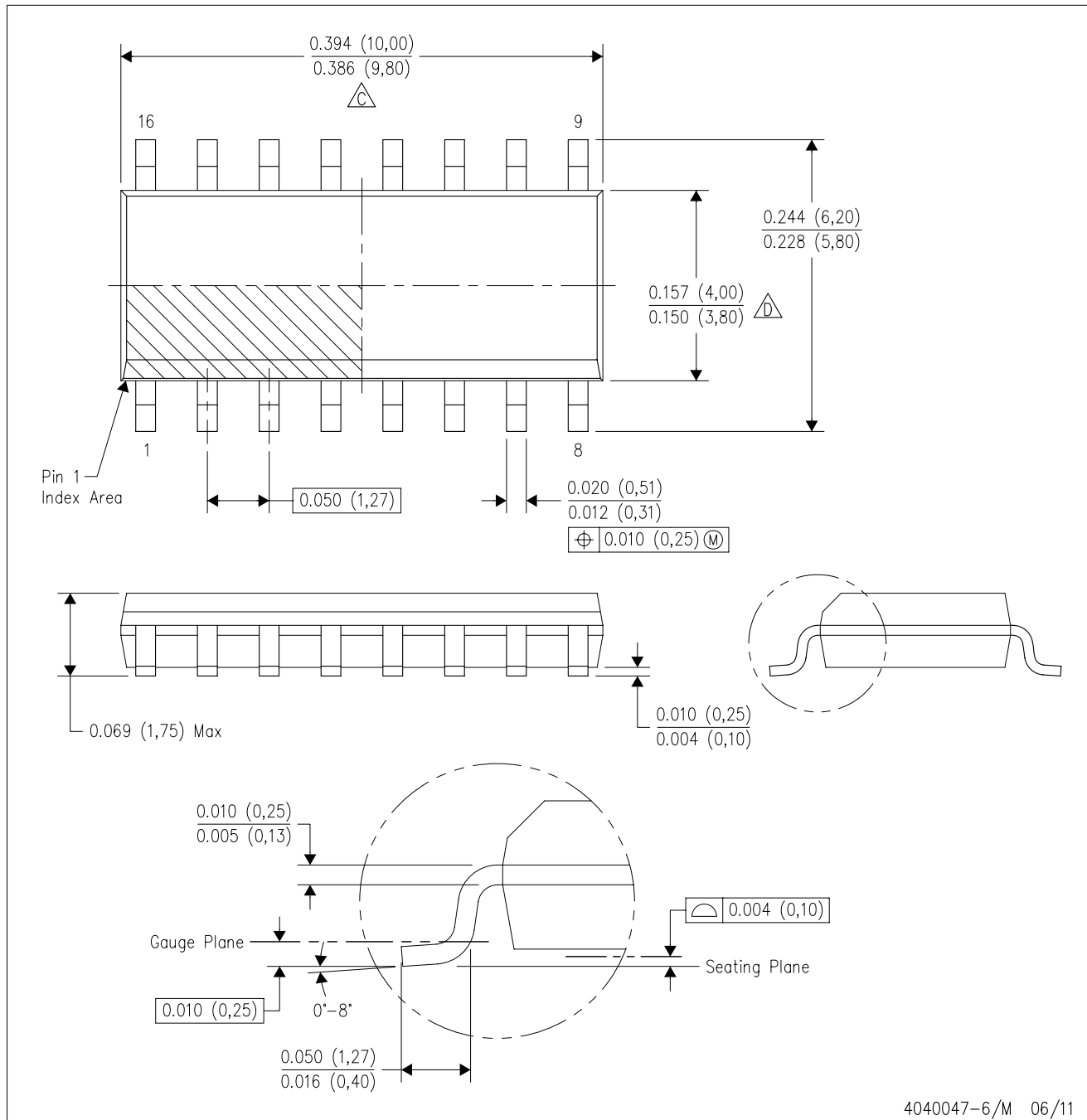

4040047-6/M 06/11

- NOTES:
- A. All linear dimensions are in inches (millimeters).
  - B. This drawing is subject to change without notice.
  -  C. Body length does not include mold flash, protrusions, or gate burrs. Mold flash, protrusions, or gate burrs shall not exceed 0.006 (0,15) each side.
  -  D. Body width does not include interlead flash. Interlead flash shall not exceed 0.017 (0,43) each side.
  - E. Reference JEDEC MS-012 variation AC.

## IMPORTANT NOTICE AND DISCLAIMER

TI PROVIDES TECHNICAL AND RELIABILITY DATA (INCLUDING DATA SHEETS), DESIGN RESOURCES (INCLUDING REFERENCE DESIGNS), APPLICATION OR OTHER DESIGN ADVICE, WEB TOOLS, SAFETY INFORMATION, AND OTHER RESOURCES "AS IS" AND WITH ALL FAULTS, AND DISCLAIMS ALL WARRANTIES, EXPRESS AND IMPLIED, INCLUDING WITHOUT LIMITATION ANY IMPLIED WARRANTIES OF MERCHANTABILITY, FITNESS FOR A PARTICULAR PURPOSE OR NON-INFRINGEMENT OF THIRD PARTY INTELLECTUAL PROPERTY RIGHTS.

These resources are intended for skilled developers designing with TI products. You are solely responsible for (1) selecting the appropriate TI products for your application, (2) designing, validating and testing your application, and (3) ensuring your application meets applicable standards, and any other safety, security, regulatory or other requirements.

These resources are subject to change without notice. TI grants you permission to use these resources only for development of an application that uses the TI products described in the resource. Other reproduction and display of these resources is prohibited. No license is granted to any other TI intellectual property right or to any third party intellectual property right. TI disclaims responsibility for, and you will fully indemnify TI and its representatives against, any claims, damages, costs, losses, and liabilities arising out of your use of these resources.

TI's products are provided subject to [TI's Terms of Sale](#) or other applicable terms available either on [ti.com](https://www.ti.com) or provided in conjunction with such TI products. TI's provision of these resources does not expand or otherwise alter TI's applicable warranties or warranty disclaimers for TI products.

TI objects to and rejects any additional or different terms you may have proposed.

Mailing Address: Texas Instruments, Post Office Box 655303, Dallas, Texas 75265  
Copyright © 2023, Texas Instruments Incorporated