

- **95-mΩ Max (5.5-V Input) High-Side MOSFET Switch With Logic Compatible Enable Input**
- **Short-Circuit and Thermal Protection**
- **Typical Short-Circuit Current Limits:**
0.4 A, TPS2010; 1.2 A, TPS2011;
2 A, TPS2012; 2.6 A, TPS2013
- **Electrostatic-Discharge Protection, 12-kV Output, 6-kV All Other Terminals**
- **Controlled Rise and Fall Times to Limit Current Surges and Minimize EMI**
- **SOIC-8 Package Pin Compatible With the Popular Littlefoot™ Series When GND Is Connected**
- **2.7-V to 5.5-V Operating Range**
- **10-μA Maximum Standby Current**
- **Surface-Mount SOIC-8 and TSSOP-14 Packages**
- **-40°C to 125°C Operating Junction Temperature Range**

**D PACKAGE
(TOP VIEW)**

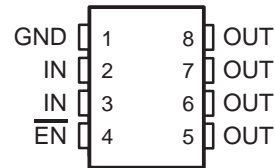

**PW PACKAGE
(TOP VIEW)**

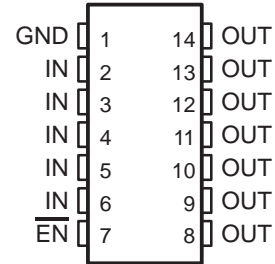

description

The TPS201x family of power-distribution switches is intended for applications where heavy capacitive loads and short circuits are likely to be encountered. The high-side switch is a 95-mΩ N-channel MOSFET. Gate drive is provided by an internal driver and charge pump designed to control the power switch rise times and fall times to minimize current surges during switching. The charge pump operates at 100 kHz, requires no external components, and allows operation from supplies as low as 2.7 V. When the output load exceeds the current-limit threshold or a short circuit is present, the TPS201x limits the output current to a safe level by switching into a constant-current mode. Continuous heavy overloads and short circuits increase power dissipation in the switch and cause the junction temperature to rise. If the junction temperature reaches approximately 180°C, a thermal protection circuit shuts the switch off to prevent damage. Recovery from thermal shutdown is automatic once the device has cooled sufficiently.

The members of the TPS201x family differ only in short-circuit current threshold. The TPS2010 is designed to limit at 0.4-A load; the other members of the family limit at 1.2 A, 2 A, and 2.6 A (see the available options table). The TPS201x family is available in 8-pin small-outline integrated circuit (SOIC) and 14-pin thin shink small-outline (TSSOP) packages and operates over a junction temperature range of -40°C to 125°C. Versions in the 8-pin SOIC package are drop-in replacements for Siliconix's Littlefoot™ power PMOS switches, except that GND must be connected.



Please be aware that an important notice concerning availability, standard warranty, and use in critical applications of Texas Instruments semiconductor products and disclaimers thereto appears at the end of this data sheet.

PRODUCTION DATA information is current as of publication date. Products conform to specifications per the terms of Texas Instruments standard warranty. Production processing does not necessarily include testing of all parameters.

 **TEXAS
INSTRUMENTS**

POST OFFICE BOX 655303 • DALLAS, TEXAS 75265

Copyright © 1995, Texas Instruments Incorporated

TPS2010, TPS2011, TPS2012, TPS2013 POWER-DISTRIBUTION

SLVS097A – DECEMBER 1994 – REVISED AUGUST 1995

AVAILABLE OPTIONS

T _J	RECOMMENDED MAXIMUM CONTINUOUS LOAD CURRENT (A)	TYPICAL SHORT-CIRCUIT OUTPUT CURRENT LIMIT AT 25°C (A)	PACKAGED DEVICES		CHIP FORM (Y)
			SOIC (D) [†]	TSSOP (PW) [‡]	
–40°C to 125°C	0.2	0.4	TPS2010D	TPS2010PWLE	TPS2010Y
	0.6	1.2	TPS2011D	TPS2011PWLE	TPS2011Y
	1	2	TPS2012D	TPS2012PWLE	TPS2012Y
	1.5	2.6	TPS2013D	TPS2013PWLE	TPS2013Y

[†] The D package is available taped and reeled. Add an R suffix to device type (e.g., TPS2010DR).

[‡] The PW package is only available left-end taped and reeled (indicated by the LE suffix on the device type; e.g., TPS2010PWLE).

functional block diagram

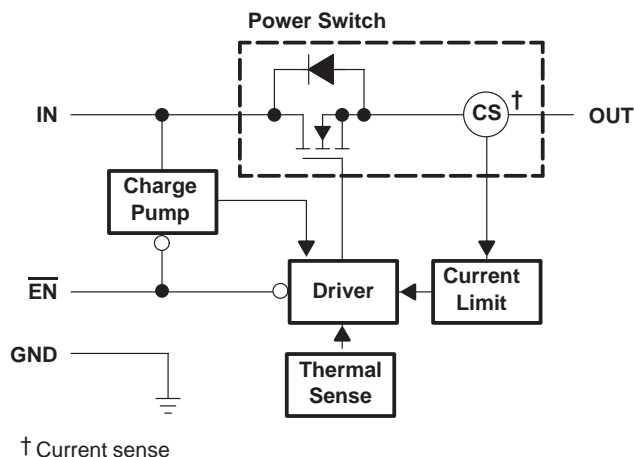

Terminal Functions

TERMINAL		I/O	DESCRIPTION	
NAME	NO.			
	D	PW		
$\overline{\text{EN}}$	4	7	I	Enable input. Logic low turns power switch on.
GND	1	1	I	Ground
IN	2, 3	2–6	I	Input voltage
OUT	5–8	8–14	O	Power-switch output

detailed description

power switch

The power switch is an N-channel MOSFET with a maximum on-state resistance of 95 m Ω ($V_{I(IN)} = 5.5$ V), configured as a high-side switch.

charge pump

An internal 100-kHz charge pump supplies power to the driver circuit and provides the necessary voltage to pull the gate of the MOSFET above the source. The charge pump operates from input voltages as low as 2.7 V and requires very little supply current.

detailed description (continued)**driver**

The driver controls the gate voltage of the power switch. To limit large current surges and reduce the associated electromagnetic interference (EMI) produced, the driver incorporates circuitry that controls the rise times and fall times of the output voltage. The rise and fall times are typically in the 2-ms to 4-ms range instead of the microsecond or nanosecond range for a standard FET.

enable (\overline{EN})

A logic high on the \overline{EN} input turns off the power switch and the bias for the charge pump, driver, and other circuitry to reduce the supply current to less than 10 μA . A logic zero input restores bias to the drive and control circuits and turns the power on. The enable input is compatible with both TTL and CMOS logic levels.

current sense

A sense FET monitors the current supplied to the load. The sense FET is a much more efficient way to measure current than conventional resistance methods. When an overload or short circuit is encountered, the current-sense circuitry sends a control signal to the driver. The driver in turn reduces the gate voltage and drives the power FET into its linear region, which switches the output into a constant current mode and simply holds the current constant while varying the voltage on the load.

thermal sense

An internal thermal-sense circuit shuts the power switch off when the junction temperature rises to approximately 180°C. Hysteresis is built into the thermal sense, and after the device has cooled approximately 20 degrees, the switch turns back on. The switch continues to cycle off and on until the fault is removed.

TPS201xY chip information

This chip, when properly assembled, displays characteristics similar to the TPS201xC. Thermal compression or ultrasonic bonding may be used on the doped aluminum bonding pads. The chip may be mounted with conductive epoxy or a gold-silicon preform.

TPS2010, TPS2011, TPS2012, TPS2013 POWER-DISTRIBUTION

SLVS097A – DECEMBER 1994 – REVISED AUGUST 1995

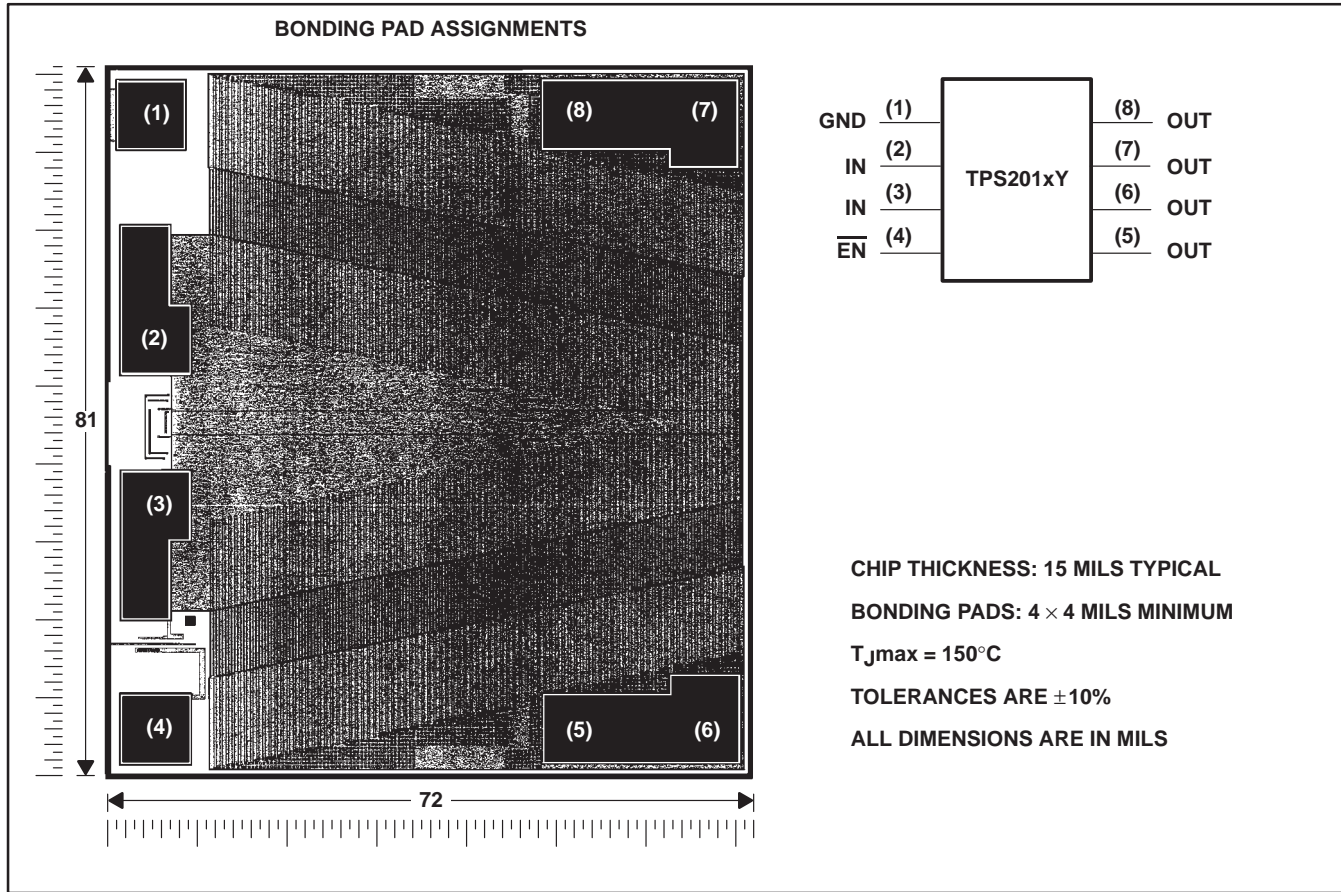

absolute maximum ratings over operating free-air temperature range (unless otherwise noted)†

Input voltage range, $V_{I(IN)}$ (see Note 1)	-0.3 V to 7 V
Output voltage range, V_O (see Note 1)	-0.3 V to $V_{I(IN)} + 0.3$ V
Input voltage range, V_I at $\overline{\text{EN}}$	-0.3 V to 7 V
Continuous output current, I_O	internally limited
Continuous total power dissipation	See Dissipation Rating Table
Operating virtual junction temperature range, T_J	-40°C to 125°C
Storage temperature range, T_{stg}	-65°C to 150°C
Lead temperature soldering 1,6 mm (1/16 inch) from case for 10 seconds	260°C

† Stresses beyond those listed under “absolute maximum ratings” may cause permanent damage to the device. These are stress ratings only, and functional operation of the device at these or any other conditions beyond those indicated under “recommended operating conditions” is not implied. Exposure to absolute-maximum-rated conditions for extended periods may affect device reliability.

NOTE 1: All voltages are with respect to GND.

DISSIPATION RATING TABLE

PACKAGE	$T_A \leq 25^{\circ}\text{C}$ POWER RATING	DERATING FACTOR ABOVE $T_A = 25^{\circ}\text{C}$	$T_A = 70^{\circ}\text{C}$ POWER RATING	$T_A = 125^{\circ}\text{C}$ POWER RATING
D	725 mW	5.8 mW/°C	464 mW	145 mW
PW	700 mW	5.6 mW/°C	448 mW	140 mW



POST OFFICE BOX 655303 • DALLAS, TEXAS 75265

recommended operating conditions

		MIN	MAX	UNIT
Input voltage, $V_{I(IN)}$		2.7	5.5	V
Input voltage, V_I at \overline{EN}		0	5.5	V
Continuous output current, I_O	TPS2010	0	0.2	A
	TPS2011	0	0.6	
	TPS2012	0	1	
	TPS2013	0	1.5	
Operating virtual junction temperature, T_J		-40	125	°C

electrical characteristics over recommended operating junction temperature range, $V_{I(IN)} = 5.5$ V, $I_O =$ rated current, $\overline{EN} = 0$ V (unless otherwise noted)

power switch

PARAMETER	TEST CONDITIONS†	TPS2010, TPS2011 TPS2012, TPS2013			UNIT
		MIN	TYP	MAX	
On-state resistance	$V_{I(IN)} = 5.5$ V, $T_J = 25^\circ\text{C}$		75	95	mΩ
	$V_{I(IN)} = 4.5$ V, $T_J = 25^\circ\text{C}$		80	110	
	$V_{I(IN)} = 3$ V, $T_J = 25^\circ\text{C}$		120	175	
	$V_{I(IN)} = 2.7$ V, $T_J = 25^\circ\text{C}$		140	215	
Output leakage current	$\overline{EN} = V_{I(IN)}$, $T_J = 25^\circ\text{C}$		0.001	1	μA
	$-40^\circ\text{C} \leq T_J \leq 125^\circ\text{C}$			10	
t_r Output rise time	$V_{I(IN)} = 5.5$ V, $T_J = 25^\circ\text{C}$, $C_L = 1$ μF		4		ms
	$V_{I(IN)} = 2.7$ V, $T_J = 25^\circ\text{C}$, $C_L = 1$ μF		3.8		
t_f Output fall time	$V_{I(IN)} = 5.5$ V, $T_J = 25^\circ\text{C}$, $C_L = 1$ μF		3.9		ms
	$V_{I(IN)} = 2.7$ V, $T_J = 25^\circ\text{C}$, $C_L = 1$ μF		3.5		

† Pulse-testing techniques maintain junction temperature close to ambient temperature; thermal effects must be taken into account separately.

enable input (\overline{EN})

PARAMETER	TEST CONDITIONS	TPS2010, TPS2011 TPS2012, TPS2013			UNIT
		MIN	TYP	MAX	
High-level input voltage	$2.7 \text{ V} \leq V_{I(IN)} \leq 5.5 \text{ V}$	2			V
Low-level input voltage	$4.5 \text{ V} \leq V_{I(IN)} \leq 5.5 \text{ V}$			0.8	V
	$2.7 \text{ V} \leq V_{I(IN)} < 4.5 \text{ V}$			0.4	
Input current	$\overline{EN} = 0$ V or $\overline{EN} = V_{I(IN)}$	-0.5		0.5	μA
t_{PLH} Propagation (delay) time, low-to-high-level output	$C_L = 1$ μF			20	ms
t_{PHL} Propagation (delay) time, high-to-low-level output	$C_L = 1$ μF			40	

current limit

PARAMETER	TEST CONDITIONS†	TPS2010, TPS2011 TPS2012, TPS2013			UNIT	
		MIN	TYP	MAX		
Short-circuit current	$T_J = 25^\circ\text{C}$, $V_{I(IN)} = 5.5$ V, OUT connected to GND, device enabled into short circuit	TPS2010	0.22	0.4	0.6	A
		TPS2011	0.66	1.2	1.8	
		TPS2012	1.1	2	3	
		TPS2013	1.65	2.6	4.5	

† Pulse-testing techniques maintain junction temperature close to ambient temperature; thermal effects must be taken into account separately.

TPS2010, TPS2011, TPS2012, TPS2013 POWER-DISTRIBUTION

SLVS097A – DECEMBER 1994 – REVISED AUGUST 1995

electrical characteristics over recommended operating junction temperature range, $V_{I(IN)} = 5.5\text{ V}$, $I_O = \text{rated current}$, $\overline{EN} = 0\text{ V}$ (unless otherwise noted) (continued)

supply current

PARAMETER	TEST CONDITIONS	TPS2010, TPS2011 TPS2012, TPS2013			UNIT
		MIN	TYP	MAX	
Supply current, low-level output	$\overline{EN} = V_{I(IN)}$	$T_J = 25^\circ\text{C}$	0.015	1	μA
		$-40^\circ\text{C} \leq T_J \leq 125^\circ\text{C}$		10	
Supply current, high-level output	$\overline{EN} = 0\text{ V}$	$T_J = 25^\circ\text{C}$	73	100	μA
		$-40^\circ\text{C} \leq T_J \leq 125^\circ\text{C}$		100	

electrical characteristics over recommended operating junction temperature range, $V_{I(IN)} = 5.5\text{ V}$, $I_O = \text{rated current}$, $\overline{EN} = 0\text{ V}$, $T_J = 25^\circ\text{C}$ (unless otherwise noted)

power switch

PARAMETER	TEST CONDITIONST	TPS2010Y, TPS2011Y TPS2012Y, TPS2013Y			UNIT
		MIN	TYP	MAX	
On-state resistance	$V_{I(IN)} = 5.5\text{ V}$,		75		$\text{m}\Omega$
	$V_{I(IN)} = 4.5\text{ V}$,		80		
	$V_{I(IN)} = 3\text{ V}$,		120		
	$V_{I(IN)} = 2.7\text{ V}$,		140		
Output leakage current	$\overline{EN} = V_{I(IN)}$		0.001		μA
Output rise time	$V_{I(IN)} = 5.5\text{ V}$, $C_L = 1\text{ }\mu\text{F}$		4		ms
	$V_{I(IN)} = 2.7\text{ V}$, $C_L = 1\text{ }\mu\text{F}$		3.8		
Output fall time	$V_{I(IN)} = 5.5\text{ V}$, $C_L = 1\text{ }\mu\text{F}$		3.9		ms
	$V_{I(IN)} = 2.7\text{ V}$, $C_L = 1\text{ }\mu\text{F}$		3.5		

† Pulse-testing techniques maintain junction temperature close to ambient temperature; thermal effects must be taken into account separately.

current limit

PARAMETER	TEST CONDITIONST	TPS2010Y, TPS2011Y TPS2012Y, TPS2013Y			UNIT
		MIN	TYP	MAX	
Short-circuit current	$V_{I(IN)} = 5.5\text{ V}$, OUT connected to GND, Device enabled into short circuit		0.4		A

† Pulse-testing techniques maintain junction temperature close to ambient temperature; thermal effects must be taken into account separately.

supply current

PARAMETER	TEST CONDITIONS	TPS2010Y, TPS2011Y TPS2012Y, TPS2013Y			UNIT
		MIN	TYP	MAX	
Supply current, low-level output	$\overline{EN} = V_{I(IN)}$		0.015		μA
Supply current, high-level output	$\overline{EN} = 0\text{ V}$		73		μA



PARAMETER MEASUREMENT INFORMATION

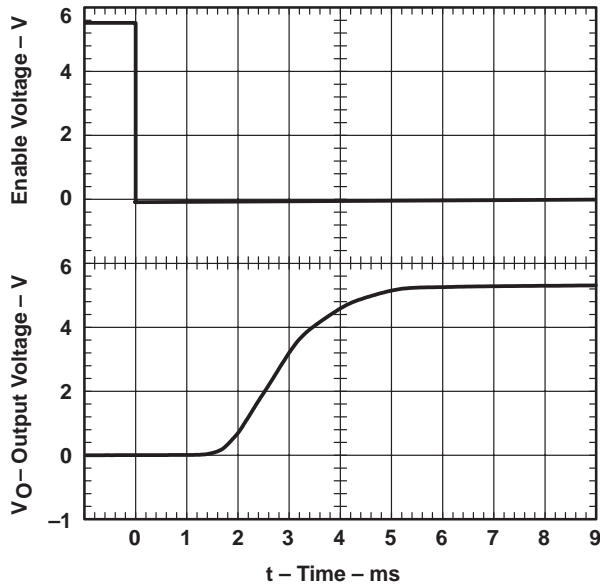

Figure 1. Propagation Delay and Rise Time With 1- μ F Load, $V_{I(IN)} = 5.5$ V

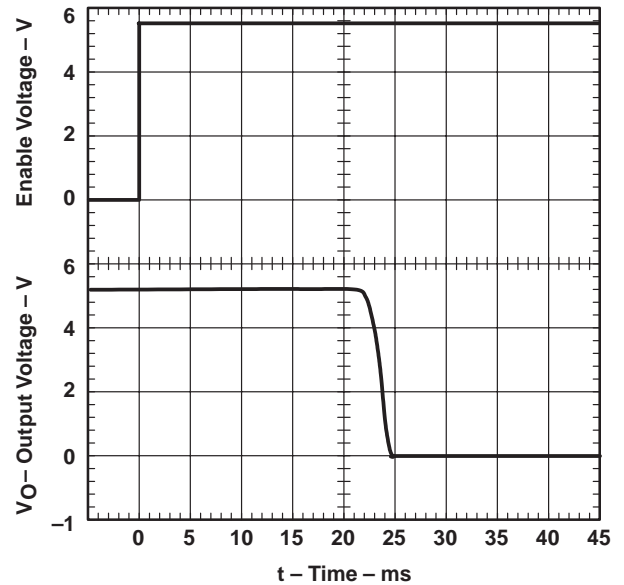

Figure 2. Propagation Delay and Fall Time With 1- μ F Load, $V_{I(IN)} = 5.5$ V

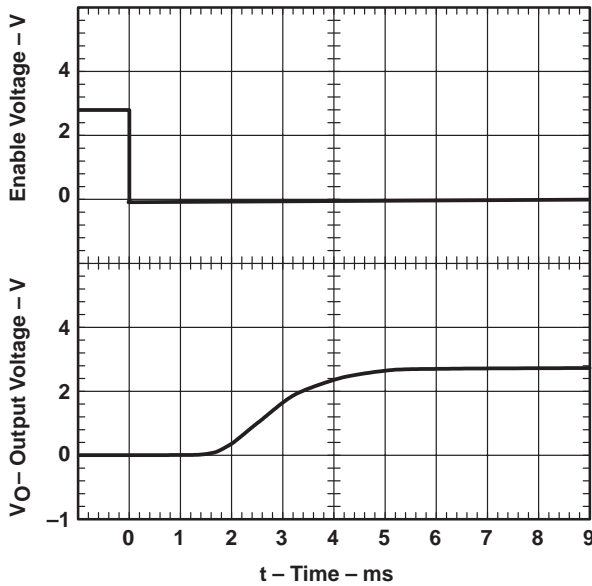

Figure 3. Propagation Delay and Rise Time With 1- μ F Load, $V_{I(IN)} = 2.7$ V

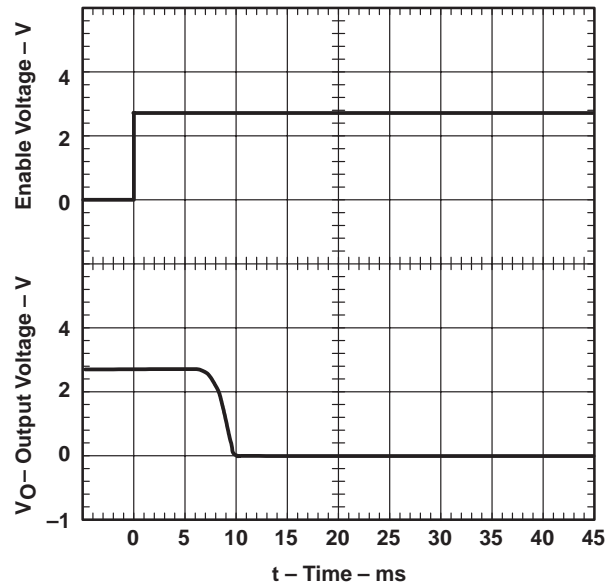

Figure 4. Propagation Delay and Fall Time With 1- μ F Load, $V_{I(IN)} = 2.7$ V

PARAMETER MEASUREMENT INFORMATION

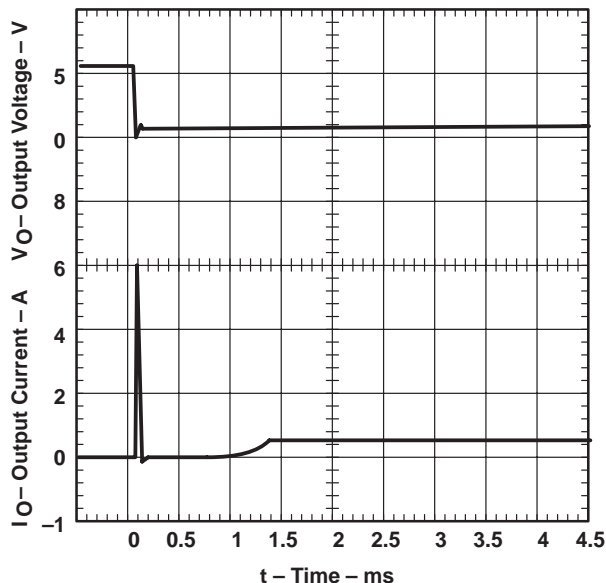

Figure 5. TPS2010, Short-Circuit Current.
Short is Applied to Enabled Device, $V_{I(IN)} = 5.5\text{ V}$

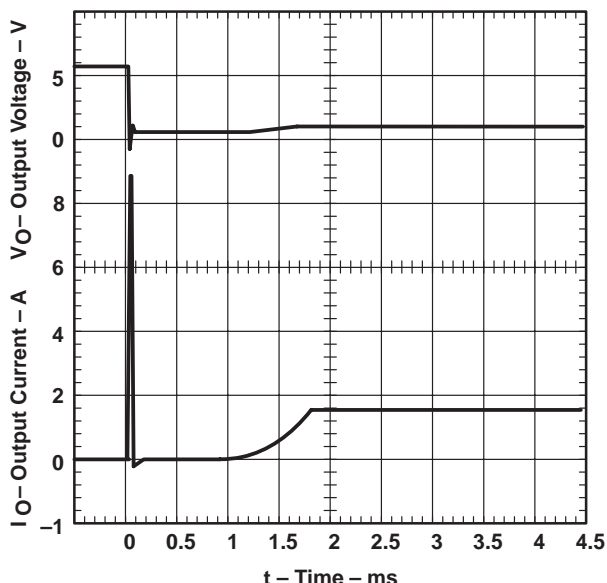

Figure 6. TPS2011, Short-Circuit Current.
Short is Applied to Enabled Device, $V_{I(IN)} = 5.5\text{ V}$

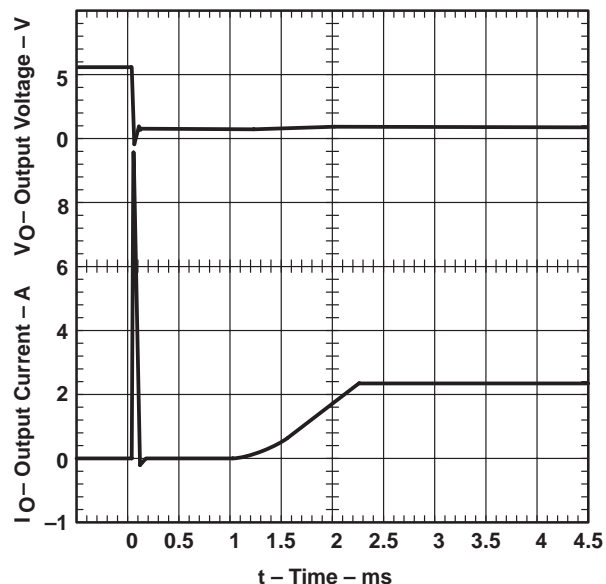

Figure 7. TPS2012, Short-Circuit Current.
Short is Applied to Enabled Device, $V_{I(IN)} = 5.5\text{ V}$

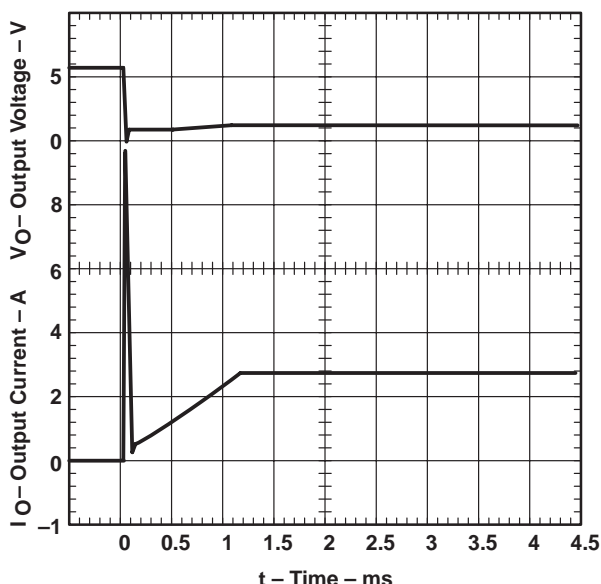

Figure 8. TPS2013 – Short-Circuit Current.
Short is Applied to Enabled Device, $V_{I(IN)} = 5.5\text{ V}$

PARAMETER MEASUREMENT INFORMATION

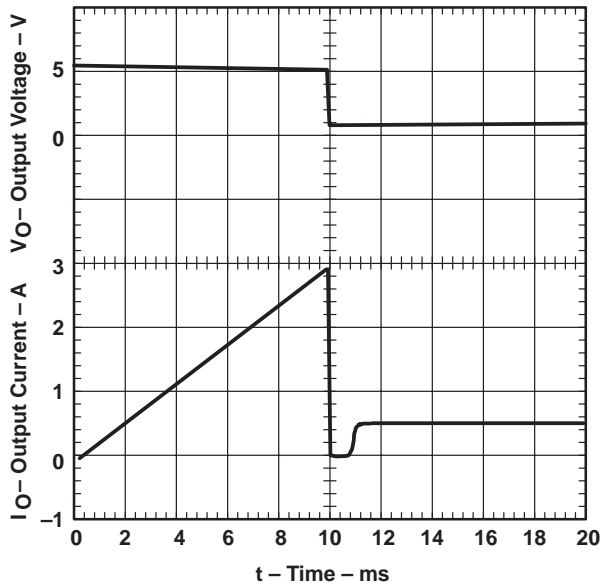

Figure 9. TPS2010 – Threshold Current,
 $V_{I(IN)} = 5.5\text{ V}$

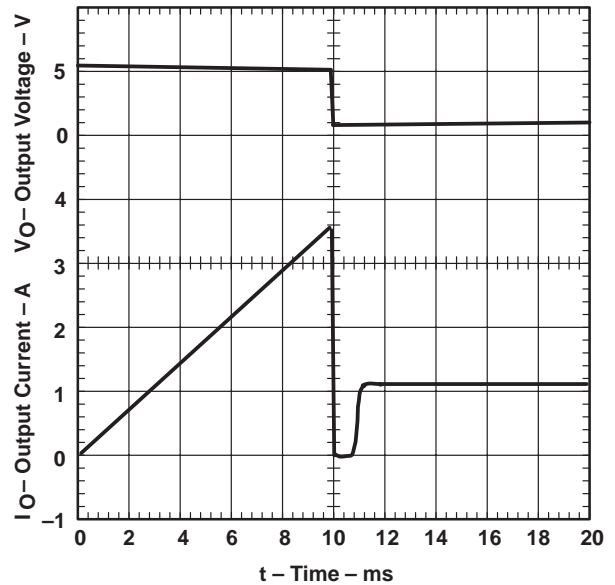

Figure 10. TPS2011 – Threshold Current,
 $V_{I(IN)} = 5.5\text{ V}$

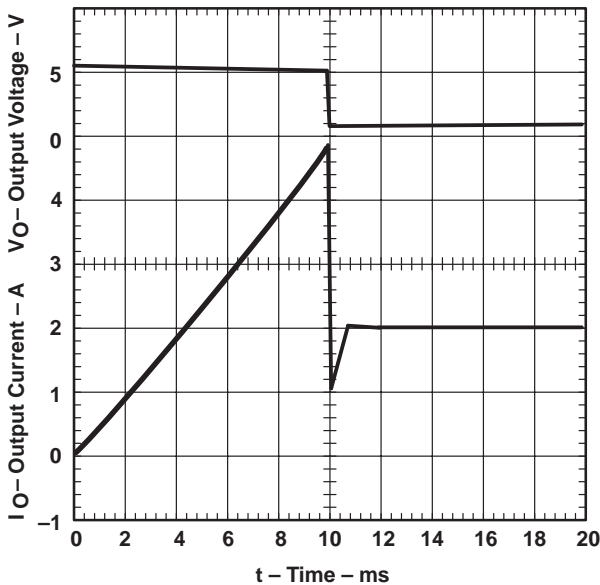

Figure 11. TPS2012 – Threshold Current,
 $V_{I(IN)} = 5.5\text{ V}$

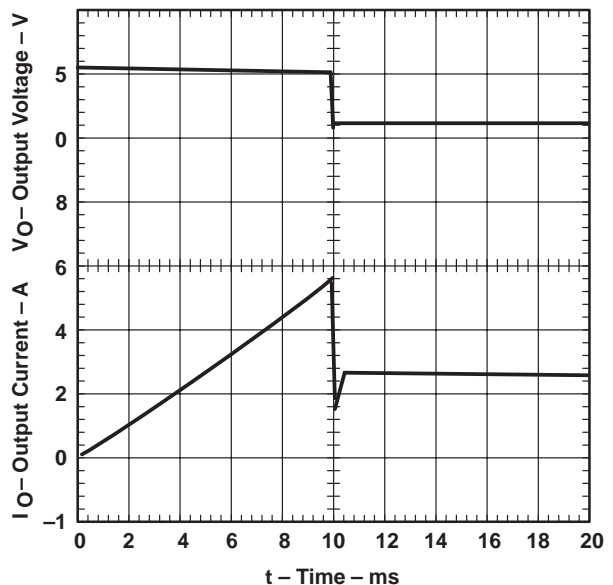

Figure 12. TPS2013 – Threshold Current,
 $V_{I(IN)} = 5.5\text{ V}$

PARAMETER MEASUREMENT INFORMATION

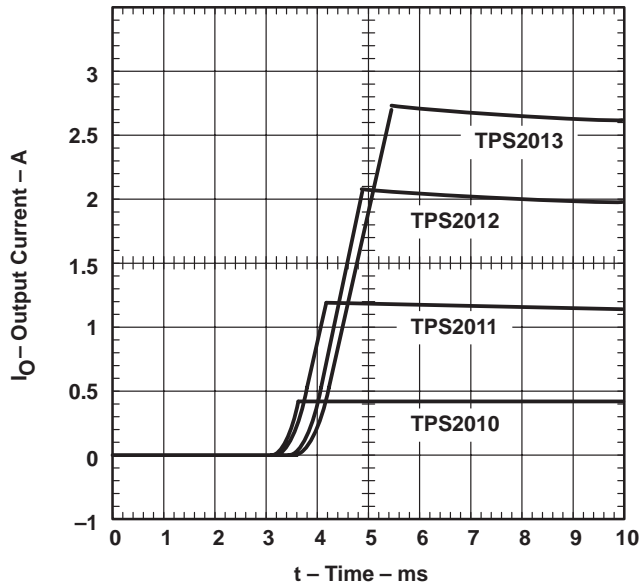

Figure 13. Turned-On (Enabled) Into Short Circuit, $V_{I(IN)} = 5.5 V$

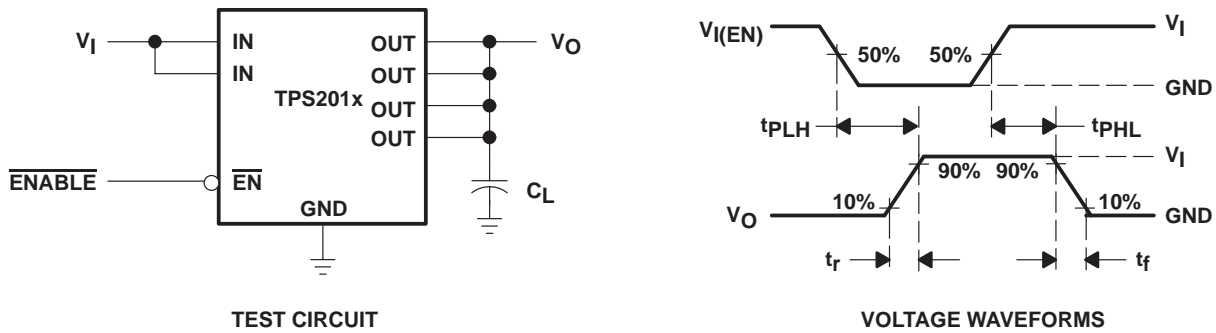

Figure 14. Test Circuit and Voltage Waveforms

TYPICAL CHARACTERISTICS

TURN-ON DELAY TIME
vs
INPUT VOLTAGE

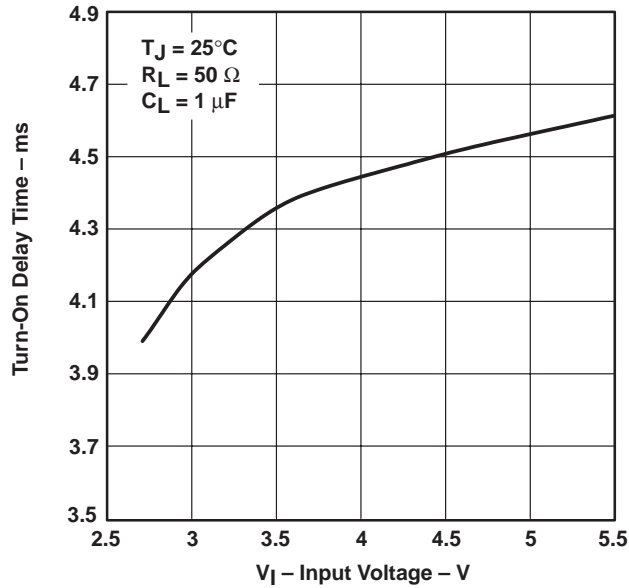

Figure 15

TURN-OFF DELAY TIME
vs
INPUT VOLTAGE

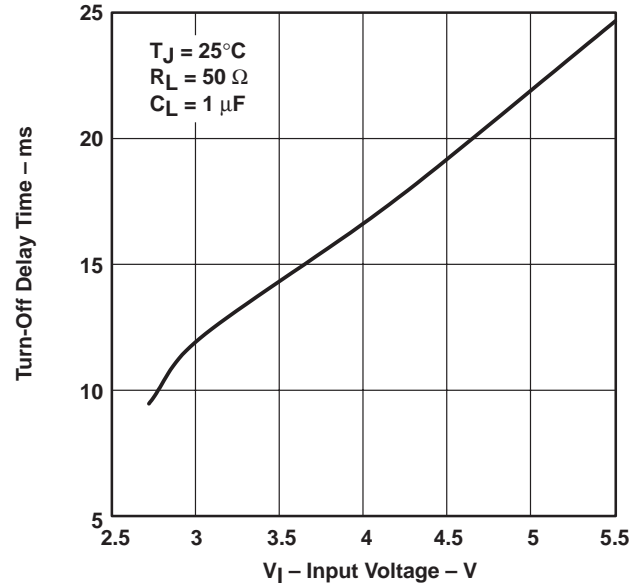

Figure 16

RISE TIME
vs
OUTPUT CURRENT

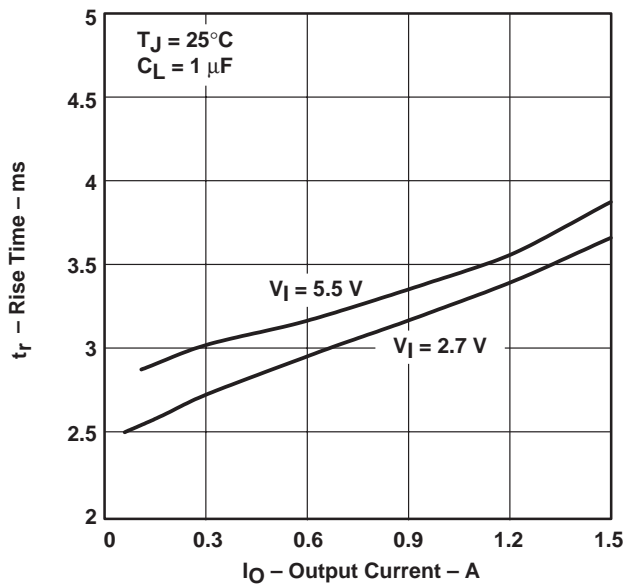

Figure 17

FALL TIME
vs
OUTPUT CURRENT

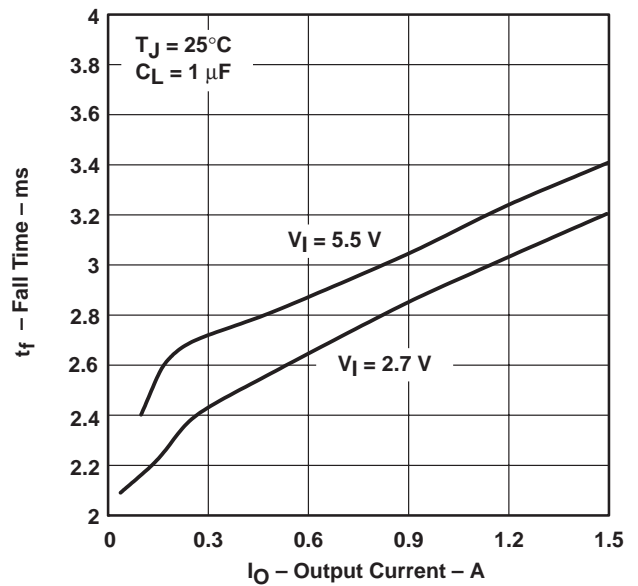

Figure 18

TYPICAL CHARACTERISTICS

SUPPLY CURRENT (OUTPUT ENABLED)
vs
JUNCTION TEMPERATURE

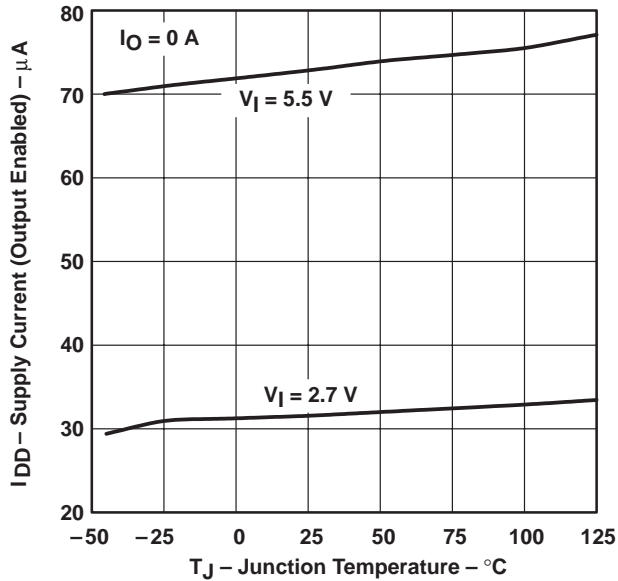

Figure 19

SUPPLY CURRENT (OUTPUT DISABLED)
vs
JUNCTION TEMPERATURE

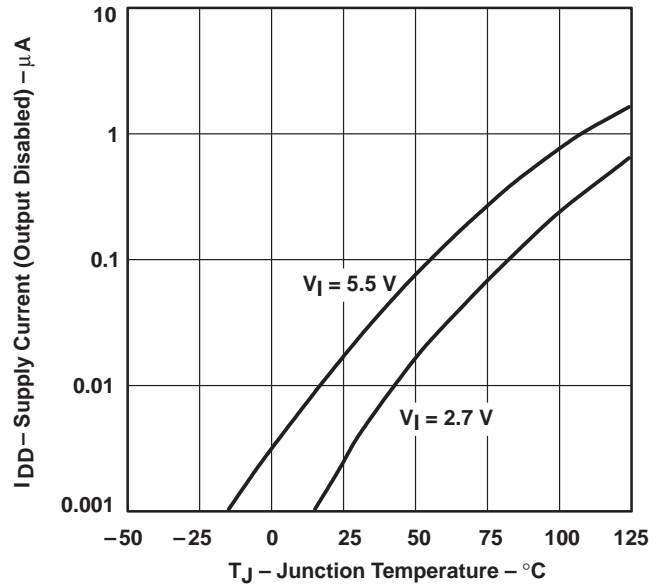

Figure 20

SUPPLY CURRENT (OUTPUT ENABLED)
vs
INPUT VOLTAGE

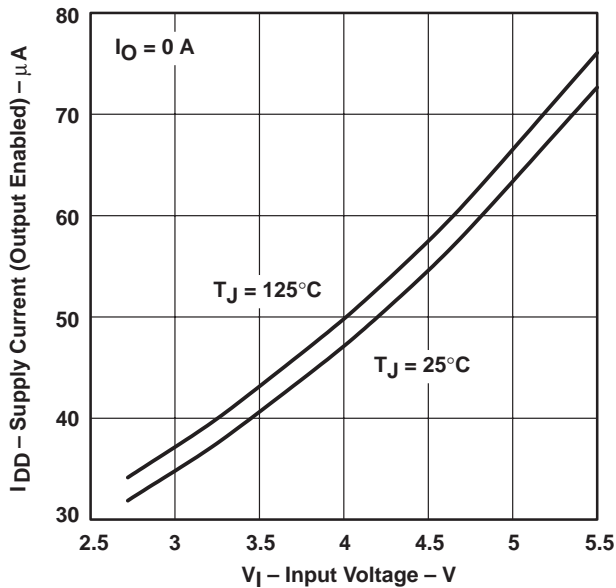

Figure 21

SUPPLY CURRENT (OUTPUT DISABLED)
vs
INPUT VOLTAGE

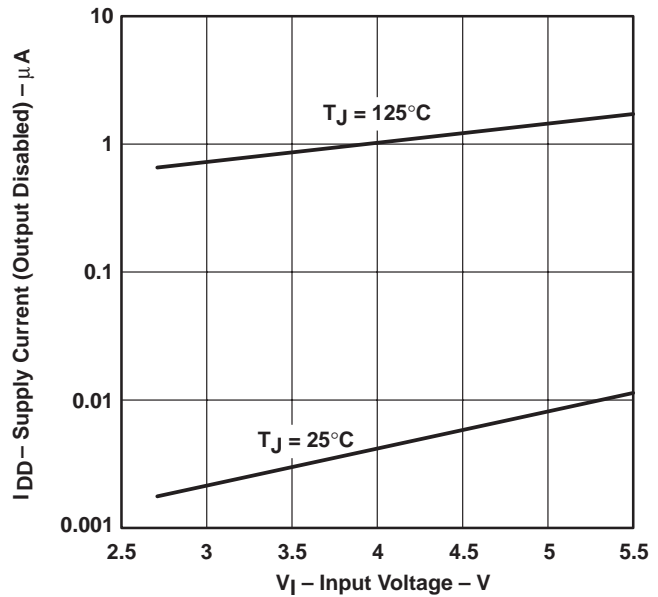

Figure 22

TYPICAL CHARACTERISTICS

ON-STATE RESISTANCE
vs
JUNCTION TEMPERATURE

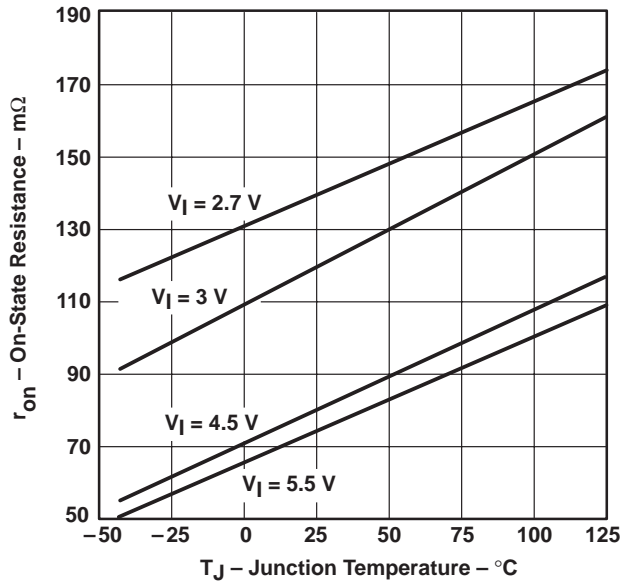

Figure 23

ON-STATE RESISTANCE
vs
INPUT VOLTAGE

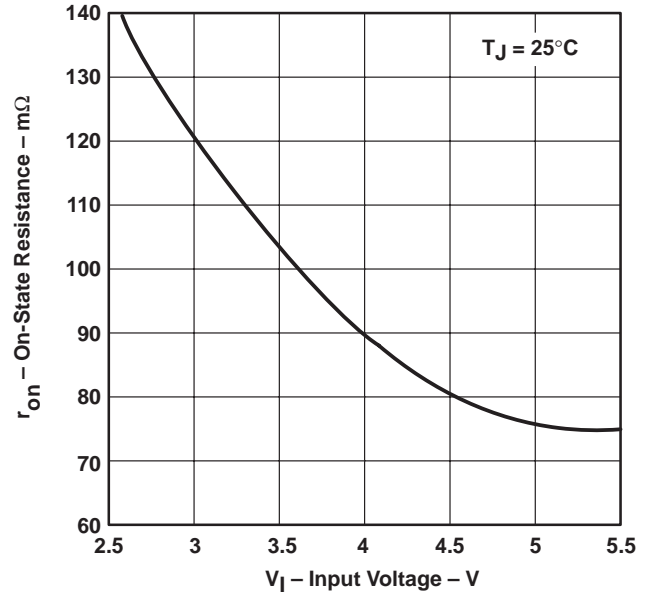

Figure 24

INPUT VOLTAGE TO OUTPUT VOLTAGE
vs
INPUT VOLTAGE

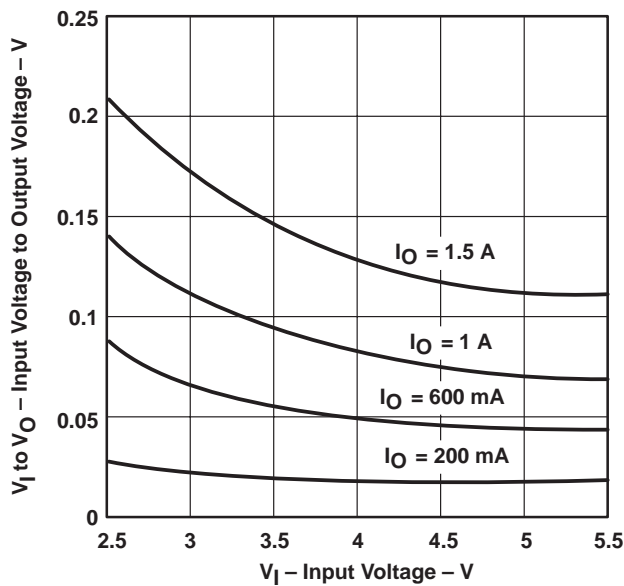

Figure 25

SHORT-CIRCUIT CURRENT
vs
INPUT VOLTAGE

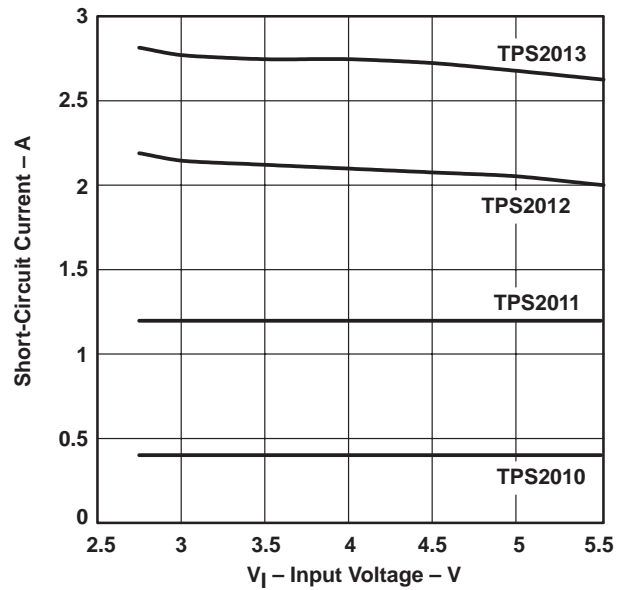

Figure 26

TYPICAL CHARACTERISTICS

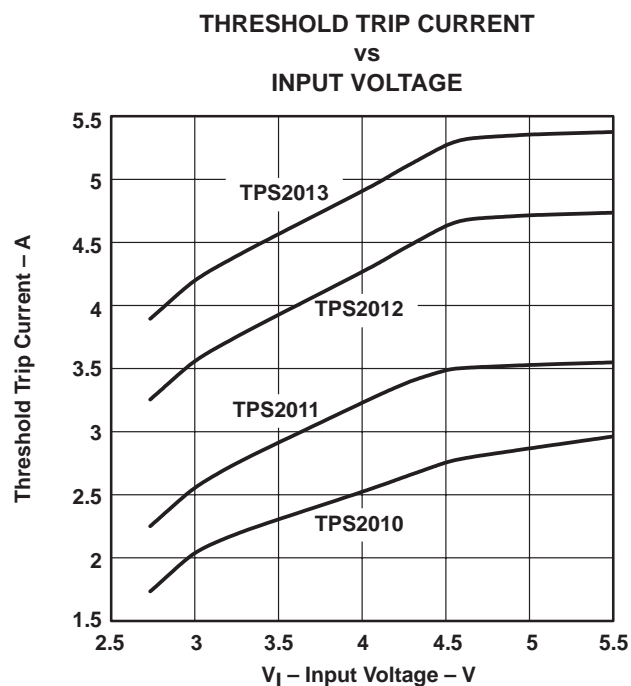

Figure 27

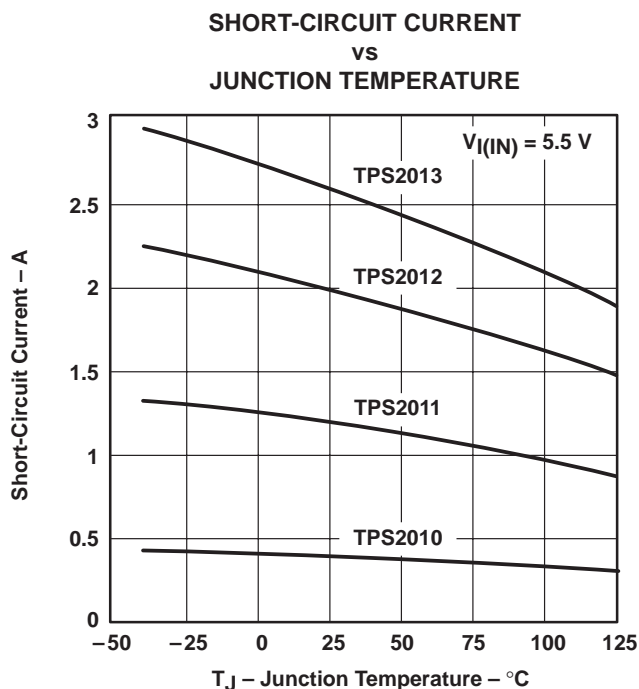

Figure 28

APPLICATION INFORMATION

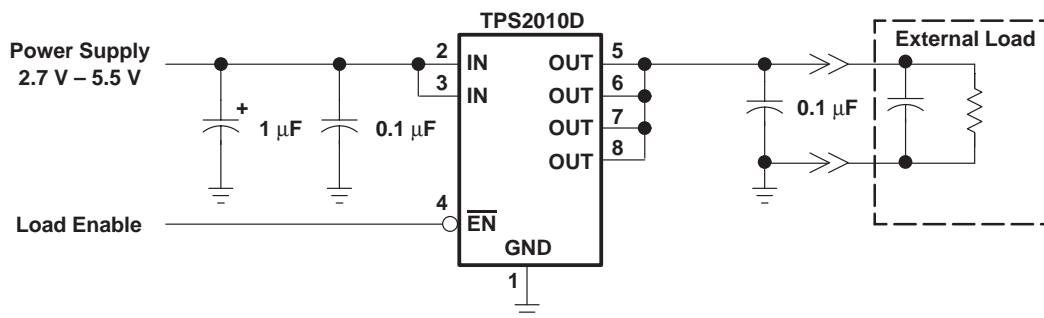

Figure 29. Typical Application

power supply considerations

The TPS201x family has multiple inputs and outputs, which must be connected in parallel to minimize voltage drop and prevent unnecessary power dissipation.

A 0.047-µF to 0.1-µF ceramic bypass capacitor between IN and GND, close to the device, is recommended. A high-value electrolytic capacitor is also desirable when the output load is heavy or has large paralleled capacitors. Bypassing the output with a 0.1-µF ceramic capacitor improves the immunity of the device to electrostatic discharge (ESD).

APPLICATION INFORMATION

overcurrent

A sense FET is employed to check for overcurrent conditions. Unlike sense resistors and polyfuses, sense FETs do not increase series resistance to the current path. When an overcurrent condition is detected, the device maintains a constant output current and reduces the output voltage accordingly. Shutdown only occurs if the fault is present long enough to activate thermal limiting.

Three possible overload conditions can occur. In the first condition, the output has been shorted before the device is enabled or before $V_{I(IN)}$ has been applied (see Figure 30). The TPS201x senses the short and immediately switches into a constant-current output.

Under the second condition, the short occurs while the device is enabled. At the instant the short occurs, very high currents flow for a short time before the current-limit circuit can react (see Figures 5, 6, 7, and 8). After the current-limit circuit has tripped, the device limits normally.

Under the third condition, the load has been gradually increased beyond the recommended operating current. The current is permitted to rise until the current-limit threshold is reached (see Figures 9, 10, 11, and 12). The TPS201x family is capable of delivering currents up to the current-limit threshold without damage. Once the threshold has been reached, the device switches into its constant-current mode.

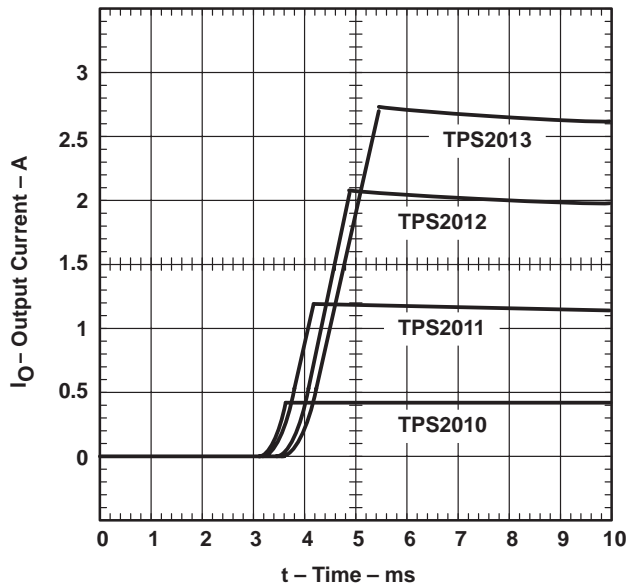

Figure 30. Turned-On (Enabled) Into Short Circuit, $V_{I(IN)} = 5.5\text{ V}$

APPLICATION INFORMATION

power dissipation and junction temperature

The low on resistance of the N-channel MOSFET allows small surface-mount packages, such as SOIC or TSSOP to pass large currents. The thermal resistances of these packages are high compared to that of power packages; it is good design practice to check power dissipation and junction temperature. The first step is to find r_{on} at the input voltage and operating temperature. As an initial estimate, use the highest operating ambient temperature of interest and read r_{on} from Figure 23. Next calculate the power dissipation using:

$$P_D = r_{on} \times I^2$$

Finally, calculate the junction temperature:

$$T_J = P_D \times R_{\theta JA} + T_A$$

Where:

T_A = Ambient temperature

$R_{\theta JA}$ = Thermal resistance SOIC = 172°C/W, TSSOP = 179°C/W

Compare the calculated junction temperature with the initial estimate. If they do not agree within a few degrees, repeat the calculation using the calculated value as the new estimate. Two or three iterations are generally sufficient to get a reasonable answer.

thermal protection

Thermal protection is provided to prevent damage to the IC when heavy-overload or short-circuit faults are present for extended periods of time. The faults force the TPS201x into its constant current mode, which causes the voltage across the high-side switch to increase; under short-circuit conditions, the voltage across the switch is equal to the input voltage. The increased dissipation causes the junction temperature to rise to dangerously high levels. The protection circuit senses the junction temperature of the switch and shuts it off. The switch remains off until the junction has dropped approximately 20°C. The switch continues to cycle in this manner until the load fault or input power is removed.

ESD protection

All TPS201x terminals incorporate ESD-protection circuitry designed to withstand a 6-kV human-body-model discharge as defined in MIL-STD-883C. Additionally, the output is protected from discharges up to 12 kV.

PACKAGING INFORMATION

Orderable Device	Status (1)	Package Type	Package Drawing	Pins	Package Qty	Eco Plan (2)	Lead finish/ Ball material (6)	MSL Peak Temp (3)	Op Temp (°C)	Device Marking (4/5)	Samples
TPS2010D	NRND	SOIC	D	8	75	RoHS & Green	NIPDAU	Level-1-260C-UNLIM	-40 to 85	2010	
TPS2010DR	NRND	SOIC	D	8	2500	RoHS & Green	NIPDAU	Level-1-260C-UNLIM	-40 to 85	2010	
TPS2010DRG4	NRND	SOIC	D	8	2500	RoHS & Green	NIPDAU	Level-1-260C-UNLIM	-40 to 85	2010	
TPS2011D	NRND	SOIC	D	8	75	RoHS & Green	NIPDAU	Level-1-260C-UNLIM	-40 to 85	2011	
TPS2011DR	NRND	SOIC	D	8	2500	RoHS & Green	NIPDAU	Level-1-260C-UNLIM	-40 to 85	2011	
TPS2012D	NRND	SOIC	D	8	75	RoHS & Green	NIPDAU	Level-1-260C-UNLIM	-40 to 85	2012	
TPS2012DR	NRND	SOIC	D	8	2500	RoHS & Green	NIPDAU	Level-1-260C-UNLIM	-40 to 85	2012	
TPS2013D	NRND	SOIC	D	8	75	RoHS & Green	NIPDAU	Level-1-260C-UNLIM	-40 to 85	2013	
TPS2013DR	NRND	SOIC	D	8	2500	RoHS & Green	NIPDAU	Level-1-260C-UNLIM	-40 to 85	2013	
TPS2013DRG4	NRND	SOIC	D	8	2500	RoHS & Green	NIPDAU	Level-1-260C-UNLIM	-40 to 85	2013	

(1) The marketing status values are defined as follows:

ACTIVE: Product device recommended for new designs.

LIFEBUY: TI has announced that the device will be discontinued, and a lifetime-buy period is in effect.

NRND: Not recommended for new designs. Device is in production to support existing customers, but TI does not recommend using this part in a new design.

PREVIEW: Device has been announced but is not in production. Samples may or may not be available.

OBSOLETE: TI has discontinued the production of the device.

(2) **RoHS:** TI defines "RoHS" to mean semiconductor products that are compliant with the current EU RoHS requirements for all 10 RoHS substances, including the requirement that RoHS substance do not exceed 0.1% by weight in homogeneous materials. Where designed to be soldered at high temperatures, "RoHS" products are suitable for use in specified lead-free processes. TI may reference these types of products as "Pb-Free".

RoHS Exempt: TI defines "RoHS Exempt" to mean products that contain lead but are compliant with EU RoHS pursuant to a specific EU RoHS exemption.

Green: TI defines "Green" to mean the content of Chlorine (Cl) and Bromine (Br) based flame retardants meet JS709B low halogen requirements of <=1000ppm threshold. Antimony trioxide based flame retardants must also meet the <=1000ppm threshold requirement.

(3) MSL, Peak Temp. - The Moisture Sensitivity Level rating according to the JEDEC industry standard classifications, and peak solder temperature.

(4) There may be additional marking, which relates to the logo, the lot trace code information, or the environmental category on the device.

(5) Multiple Device Markings will be inside parentheses. Only one Device Marking contained in parentheses and separated by a "~" will appear on a device. If a line is indented then it is a continuation of the previous line and the two combined represent the entire Device Marking for that device.

⁽⁶⁾ Lead finish/Ball material - Orderable Devices may have multiple material finish options. Finish options are separated by a vertical ruled line. Lead finish/Ball material values may wrap to two lines if the finish value exceeds the maximum column width.

Important Information and Disclaimer:The information provided on this page represents TI's knowledge and belief as of the date that it is provided. TI bases its knowledge and belief on information provided by third parties, and makes no representation or warranty as to the accuracy of such information. Efforts are underway to better integrate information from third parties. TI has taken and continues to take reasonable steps to provide representative and accurate information but may not have conducted destructive testing or chemical analysis on incoming materials and chemicals. TI and TI suppliers consider certain information to be proprietary, and thus CAS numbers and other limited information may not be available for release.

In no event shall TI's liability arising out of such information exceed the total purchase price of the TI part(s) at issue in this document sold by TI to Customer on an annual basis.

TAPE AND REEL INFORMATION

QUADRANT ASSIGNMENTS FOR PIN 1 ORIENTATION IN TAPE

*All dimensions are nominal

Device	Package Type	Package Drawing	Pins	SPQ	Reel Diameter (mm)	Reel Width W1 (mm)	A0 (mm)	B0 (mm)	K0 (mm)	P1 (mm)	W (mm)	Pin1 Quadrant
TPS2010DR	SOIC	D	8	2500	330.0	12.4	6.4	5.2	2.1	8.0	12.0	Q1
TPS2011DR	SOIC	D	8	2500	330.0	12.4	6.4	5.2	2.1	8.0	12.0	Q1
TPS2012DR	SOIC	D	8	2500	330.0	12.4	6.4	5.2	2.1	8.0	12.0	Q1
TPS2013DR	SOIC	D	8	2500	330.0	12.4	6.4	5.2	2.1	8.0	12.0	Q1

TAPE AND REEL BOX DIMENSIONS

*All dimensions are nominal

Device	Package Type	Package Drawing	Pins	SPQ	Length (mm)	Width (mm)	Height (mm)
TPS2010DR	SOIC	D	8	2500	340.5	338.1	20.6
TPS2011DR	SOIC	D	8	2500	340.5	338.1	20.6
TPS2012DR	SOIC	D	8	2500	340.5	338.1	20.6
TPS2013DR	SOIC	D	8	2500	340.5	338.1	20.6

TUBE

*All dimensions are nominal

Device	Package Name	Package Type	Pins	SPQ	L (mm)	W (mm)	T (μm)	B (mm)
TPS2010D	D	SOIC	8	75	507	8	3940	4.32
TPS2011D	D	SOIC	8	75	507	8	3940	4.32
TPS2012D	D	SOIC	8	75	507	8	3940	4.32
TPS2013D	D	SOIC	8	75	507	8	3940	4.32

IMPORTANT NOTICE AND DISCLAIMER

TI PROVIDES TECHNICAL AND RELIABILITY DATA (INCLUDING DATA SHEETS), DESIGN RESOURCES (INCLUDING REFERENCE DESIGNS), APPLICATION OR OTHER DESIGN ADVICE, WEB TOOLS, SAFETY INFORMATION, AND OTHER RESOURCES "AS IS" AND WITH ALL FAULTS, AND DISCLAIMS ALL WARRANTIES, EXPRESS AND IMPLIED, INCLUDING WITHOUT LIMITATION ANY IMPLIED WARRANTIES OF MERCHANTABILITY, FITNESS FOR A PARTICULAR PURPOSE OR NON-INFRINGEMENT OF THIRD PARTY INTELLECTUAL PROPERTY RIGHTS.

These resources are intended for skilled developers designing with TI products. You are solely responsible for (1) selecting the appropriate TI products for your application, (2) designing, validating and testing your application, and (3) ensuring your application meets applicable standards, and any other safety, security, regulatory or other requirements.

These resources are subject to change without notice. TI grants you permission to use these resources only for development of an application that uses the TI products described in the resource. Other reproduction and display of these resources is prohibited. No license is granted to any other TI intellectual property right or to any third party intellectual property right. TI disclaims responsibility for, and you will fully indemnify TI and its representatives against, any claims, damages, costs, losses, and liabilities arising out of your use of these resources.

TI's products are provided subject to [TI's Terms of Sale](#) or other applicable terms available either on [ti.com](https://www.ti.com) or provided in conjunction with such TI products. TI's provision of these resources does not expand or otherwise alter TI's applicable warranties or warranty disclaimers for TI products.

TI objects to and rejects any additional or different terms you may have proposed.

Mailing Address: Texas Instruments, Post Office Box 655303, Dallas, Texas 75265
Copyright © 2023, Texas Instruments Incorporated