

TPS6213x 3V~17V、3A、3mm × 3mm QFN パッケージ、降圧型コンバータ

1 特長

- DCS-Control™ トポロジ
- 入力電圧範囲: 3V~17V
- 最大 3A の出力電流
- 出力電圧を 0.9V~6V の範囲で調整可能
- ピンにより出力電圧を選択可能 (公称値、+5%)
- ソフトスタートとトラッキングをプログラム可能
- シームレスなパワーセーブ・モード移行
- 静止電流 17μA (標準値)
- 動作周波数を選択可能
- パワー・グッド出力
- 100% デューティ・サイクル・モード
- 短絡保護
- 過熱保護
- [TPS62140](#) および [TPS62150](#) とピン互換
- 3mm × 3mm の QFN-16 パッケージで供給
- [TPS82130](#) を使用することで設計を迅速化

2 アプリケーション

- 標準の 12V レール電源
- 単一または複数のリチウムイオン・バッテリーを使用する POL 電源
- ソリッドステート・ドライブ
- 組み込みシステム
- LDO の置き換え
- モバイル PC、タブレット、モデム、カメラ
- サーバー、マイクロサーバー
- データ端末、ePOS (販売時点情報管理)

3 概要

TPS6213x ファミリーは、簡単に使用できる同期整流降圧型 DC/DC コンバータで、電力密度の高いアプリケーション向けに最適化されています。スイッチング周波数が標準値で 2.5MHz と高いため、小型のインダクタを使用でき、高速な過渡応答が実現されるとともに、DCS-Control トポロジの使用によって出力電圧の高い精度が得られます。

3V~17V の広い入力電圧範囲で動作するため、このデバイスはリチウムイオンや他のバッテリー、および 12V の中間電力レールで動作するシステムに理想的です。0.9V~6V の出力電圧で、3A までの出力電流を連続的にサポートします (100% デューティ・サイクル・モード時)。出力電圧のスタートアップ・ランプはソフトスタート・ピンにより制御されるため、スタンドアロンの電源またはトラッキング構成で動作できます。イネーブル・ピンおよびオープン・ドレインのパワー・グッド・ピンの構成により、電源シーケンスも可能です。

パワーセービング・モードでは、このデバイスは V_{IN} から約 17μA の静止電流を消費します。負荷が小さい時には自動的かつシームレスにパワーセーブ・モードへ移行するため、負荷範囲全体にわたって高い効率が維持されます。シャットダウン・モードではデバイスがオフになり、シャットダウン時の消費電流は 2μA 未満です。

このデバイスには可変出力電圧と固定出力電圧のバージョンがあり、3mm×3mm (RGT) の 16 ピン VQFN パッケージで供給されます。

製品情報

| 部品番号 | パッケージ ⁽¹⁾ | 本体サイズ (公称) |
|----------|----------------------|-----------------|
| TPS6213x | VQFN (16) | 3.00mm × 3.00mm |

- (1) 利用可能なすべてのパッケージについては、このデータシートの末尾にある注文情報を参照してください。

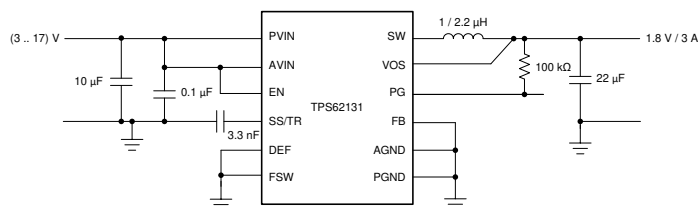

代表的なアプリケーション回路図

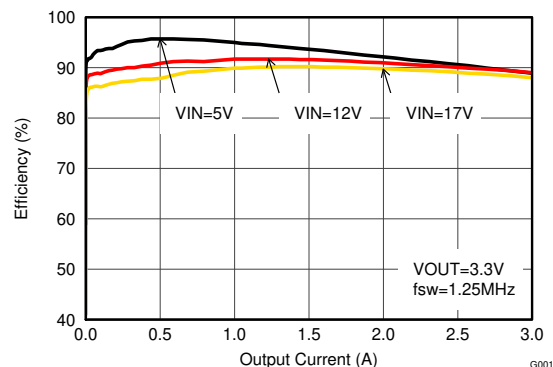

効率と出力電流との関係



Table of Contents

| | | | |
|---|----|---|-----------|
| 1 特長..... | 1 | 9.1 Application Information..... | 13 |
| 2 アプリケーション..... | 1 | 9.2 Typical Application..... | 13 |
| 3 概要..... | 1 | 9.3 System Examples..... | 25 |
| 4 Revision History..... | 2 | 10 Power Supply Recommendations..... | 28 |
| 5 Device Comparison Table..... | 3 | 11 Layout..... | 28 |
| 6 Pin Configuration and Functions..... | 3 | 11.1 Layout Guidelines..... | 28 |
| 7 Specifications..... | 4 | 11.2 Layout Example..... | 29 |
| 7.1 Absolute Maximum Ratings ⁽¹⁾ | 4 | 11.3 Thermal Information..... | 29 |
| 7.2 ESD Ratings..... | 4 | 12 Device and Documentation Support..... | 30 |
| 7.3 Recommended Operating Conditions..... | 4 | 12.1 Device Support..... | 30 |
| 7.4 Thermal Information..... | 4 | 12.2 Documentation Support..... | 30 |
| 7.5 Electrical Characteristics..... | 5 | 12.3 Receiving Notification of Documentation Updates..... | 30 |
| 7.6 Typical Characteristics..... | 6 | 12.4 サポート・リソース..... | 30 |
| 8 Detailed Description..... | 7 | 12.5 Trademarks..... | 30 |
| 8.1 Overview..... | 7 | 12.6 Electrostatic Discharge Caution..... | 30 |
| 8.2 Functional Block Diagram..... | 8 | 12.7 Glossary..... | 30 |
| 8.3 Feature Description..... | 9 | 13 Mechanical, Packaging, and Orderable Information..... | 31 |
| 8.4 Device Functional Modes..... | 11 | | |
| 9 Application and Implementation..... | 13 | | |

4 Revision History

資料番号末尾の英字は改訂を表しています。その改訂履歴は英語版に準じています。

| Changes from Revision E (August 2016) to Revision F (November 2021) | | Page |
|---|--|-------------|
| • TPS62130 製品ページへのリンクを追加..... | | 1 |
| • 文書全体にわたって表、図、相互参照の採番方法を更新..... | | 1 |
| • データシートの文法的な問題を修正..... | | 1 |
| Changes from Revision D (June 2016) to Revision E (August 2016) | | Page |
| • Changed the T _J MAX value From: 125°C To: 150°C in the Absolute Maximum Ratings | | 4 |
| • Changed (T _J = -40°C to 85°C) To: (T _J = -40°C to 125°C) in the セクション 7.5 conditions..... | | 5 |
| • Added a test condition for I _Q at T _A = -40°C to +85°C in the セクション 7.5 | | 5 |
| • Added 表 8-1 and 表 8-2 | | 10 |

5 Device Comparison Table

| PART NUMBER | OUTPUT VOLTAGE | POWER GOOD LOGIC LEVEL (EN = LOW) |
|-------------|----------------|-----------------------------------|
| TPS62130 | adjustable | High Impedance |
| TPS62130A | adjustable | Low |
| TPS62131 | 1.8 V | High Impedance |
| TPS62132 | 3.3 V | High Impedance |
| TPS62133 | 5.0 V | High Impedance |

6 Pin Configuration and Functions



图 6-1. 16-Pin VQFN With Exposed Thermal Pad (RGT) Top View

表 6-1. Pin Functions

| PIN ⁽¹⁾ | | I/O | DESCRIPTION |
|--------------------|---------------------|-----|--|
| NO. | NAME | | |
| 1,2,3 | SW | O | Switch node, which is connected to the internal MOSFET switches. Connect an inductor between SW and the output capacitor. |
| 4 | PG | O | Output power good (High = V_{OUT} ready, Low = V_{OUT} below nominal regulation); open drain (requires pullup resistor) |
| 5 | FB | I | Voltage feedback of adjustable version. Connect a resistive voltage divider to this pin. It is recommended to connect FB to AGND on fixed output voltage versions for improved thermal performance. |
| 6 | AGND | | Analog Ground. Must be connected directly to the Exposed Thermal Pad and common ground plane. |
| 7 | FSW | I | Switching Frequency Select (Low \approx 2.5 MHz, High \approx 1.25 MHz ⁽²⁾ for typical operation) ⁽³⁾ |
| 8 | DEF | I | Output voltage scaling (Low = nominal, High = nominal + 5%) ⁽³⁾ |
| 9 | SS/TR | I | Soft-Start/Tracking Pin. An external capacitor connected to this pin sets the internal voltage reference rise time. It can be used for tracking and sequencing. |
| 10 | AVIN | I | Supply voltage for control circuitry. Connect to the same source as PVIN. |
| 11,12 | PVIN | I | Supply voltage for power stage. Connect to the same source as AVIN. |
| 13 | EN | I | Enable input (High = enabled, Low = disabled) ⁽³⁾ |
| 14 | VOS | I | Output voltage sense pin and connection for the control loop circuitry |
| 15,16 | PGND | | Power Ground. Must be connected directly to the Exposed Thermal Pad and common ground plane. |
| | Exposed Thermal Pad | | Must be connected to AGND (pin 6), PGND (pin 15,16), and common ground plane. See the Layout Example . Must be soldered to achieve appropriate power dissipation and mechanical reliability. |

- (1) For more information about connecting pins, see the [Detailed Description](#) and [Application and Implementation](#) sections.
(2) Connect FSW to V_{OUT} or PG in this case.
(3) An internal pulldown resistor keeps logic level low if pin is floating.

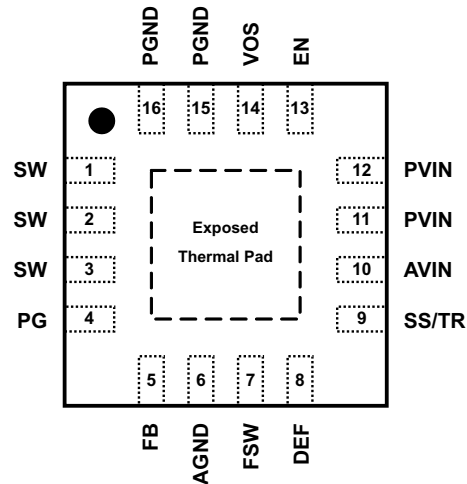
7 Specifications

7.1 Absolute Maximum Ratings⁽¹⁾

over operating junction temperature range (unless otherwise noted)

| | | MIN | MAX | UNIT |
|--|-----------------------|------|----------------------|------|
| Pin voltage range ⁽²⁾ | AVIN, PVIN | -0.3 | 20 | V |
| | EN, SS/TR | -0.3 | V _{IN} +0.3 | |
| | SW | -0.3 | V _{IN} +0.3 | V |
| | DEF, FSW, FB, PG, VOS | -0.3 | 7 | V |
| Power Good sink current | PG | | 10 | mA |
| Operating junction temperature, T _J | | -40 | 150 | °C |
| Storage temperature, T _{stg} | | -65 | 150 | °C |

- (1) Stresses beyond those listed under *absolute maximum ratings* may cause permanent damage to the device. These are stress ratings only, and functional operation of the device at these or any other conditions beyond those indicated under *recommended operating conditions* is not implied. Exposure to absolute-maximum-rated conditions for extended periods may affect device reliability.
- (2) All voltages are with respect to network ground terminal.

7.2 ESD Ratings

| | | VALUE | UNIT |
|---|--|-------|------|
| V _(ESD) Electrostatic discharge ⁽¹⁾ | Human-body model (HBM), per ANSI/ESDA/JEDEC JS-001 ⁽²⁾ | ±2000 | V |
| | Charged-device model (CDM), per JEDEC specification JESD22-C101 ⁽³⁾ | ±500 | |

- (1) ESD testing is performed according to the respective JESD22 JEDEC standard.
- (2) JEDEC document JEP155 states that 500-V HBM allows safe manufacturing with a standard ESD control process.
- (3) JEDEC document JEP157 states that 250-V CDM allows safe manufacturing with a standard ESD control process.

7.3 Recommended Operating Conditions

over operating junction temperature range (unless otherwise noted)

| | MIN | MAX | UNIT |
|--|-----|-----|------|
| Supply Voltage, V _{IN} (at AVIN and PVIN) | 3 | 17 | V |
| Operating junction temperature, T _J | -40 | 125 | °C |

7.4 Thermal Information

| THERMAL METRIC ⁽¹⁾ | | TPS6213X | UNITS |
|-------------------------------|--|-------------|-------|
| | | RGT 16 PINS | |
| R _{θJA} | Junction-to-ambient thermal resistance | 45 | °C/W |
| R _{θJctop} | Junction-to-case(top) thermal resistance | 53.6 | |
| R _{θJB} | Junction-to-board thermal resistance | 17.4 | |
| ψ _{JT} | Junction-to-top characterization parameter | 1.1 | |
| ψ _{JB} | Junction-to-board characterization parameter | 17.4 | |
| R _{θJcbot} | Junction-to-case(bottom) thermal resistance | 4.5 | |

- (1) For more information about traditional and new thermal metrics, see the [Semiconductor and IC Package Thermal Metrics](#) application report.

7.5 Electrical Characteristics

over operating junction temperature ($T_J = -40^{\circ}\text{C}$ to 125°C), typical values at $V_{IN} = 12\text{ V}$ and $T_A = 25^{\circ}\text{C}$ (unless otherwise noted)

| PARAMETER | | TEST CONDITIONS | MIN | TYP | MAX | UNIT | |
|--|--|--|--|-----------------|-----|--------------------|----|
| SUPPLY | | | | | | | |
| V_{IN} | Input voltage range ⁽¹⁾ | | 3 | | 17 | V | |
| I_Q | Operating quiescent current | EN=High, $I_{OUT} = 0\text{ mA}$, device not switching | | 17 | 30 | μA | |
| | | $T_A = -40^{\circ}\text{C}$ to $+85^{\circ}\text{C}$ | | 17 | 25 | | |
| I_{SD} | Shutdown current ⁽²⁾ | EN=Low | | 1.5 | 25 | μA | |
| | | $T_A = -40^{\circ}\text{C}$ to $+85^{\circ}\text{C}$ | | 1.5 | 4 | | |
| V_{UVLO} | Undervoltage lockout threshold | Falling Input Voltage (PWM mode operation) | 2.6 | 2.7 | 2.8 | V | |
| | | Hysteresis | | 200 | | mV | |
| T_{SD} | Thermal shutdown temperature | | | 160 | | $^{\circ}\text{C}$ | |
| | Thermal shutdown hysteresis | | | 20 | | | |
| CONTROL (EN, DEF, FSW, SS/TR, PG) | | | | | | | |
| V_H | High level input threshold voltage (EN, DEF, FSW) | | 0.9 | 0.65 | | V | |
| V_L | Low level input threshold voltage (EN, DEF, FSW) | | | 0.45 | 0.3 | V | |
| I_{LKG} | Input leakage current (EN, DEF, FSW) | EN= V_{IN} or GND; DEF, FSW= V_{OUT} or GND | | 0.01 | 1 | μA | |
| V_{TH_PG} | Power good threshold voltage | Rising (% V_{OUT}) | 92% | 95% | 98% | | |
| | | Falling (% V_{OUT}) | 87% | 90% | 94% | | |
| V_{OL_PG} | Power good output low | $I_{PG} = -2\text{ mA}$ | | 0.07 | 0.3 | V | |
| I_{LKG_PG} | Input leakage current (PG) | $V_{PG} = 1.8\text{ V}$ | | 1 | 400 | nA | |
| $I_{SS/TR}$ | SS/TR pin source current | | 2.3 | 2.5 | 2.7 | μA | |
| POWER SWITCH | | | | | | | |
| $R_{DS(ON)}$ | High-side MOSFET ON-resistance | $V_{IN} \geq 6\text{ V}$ | | 90 | 170 | m Ω | |
| | | $V_{IN} = 3\text{ V}$ | | 120 | | | |
| | Low-side MOSFET ON-resistance | $V_{IN} \geq 6\text{ V}$ | | 40 | 70 | m Ω | |
| | | $V_{IN} = 3\text{ V}$ | | 50 | | | |
| I_{LIMF} | High-side MOSFET forward current limit ⁽³⁾ | $V_{IN} = 12\text{ V}$, $T_A = 25^{\circ}\text{C}$ | 3.6 | 4.2 | 4.9 | A | |
| OUTPUT | | | | | | | |
| I_{LKG_FB} | Input leakage current (FB) | TPS62130, $V_{FB} = 0.8\text{ V}$ | | 1 | 100 | nA | |
| V_{OUT} | Output voltage range (TPS62130) | $V_{IN} \geq V_{OUT}$ | 0.9 | | 6.0 | V | |
| | DEF (Output voltage programming) | DEF=0 (GND) | | V_{OUT} | | | |
| | | DEF=1 (V_{OUT}) | | $V_{OUT} + 5\%$ | | | |
| | Initial output voltage accuracy ⁽⁴⁾ | PWM mode operation, $V_{IN} \geq V_{OUT} + 1\text{ V}$ | $T_A = -10^{\circ}\text{C}$ to 85°C | 785.6 | 800 | 814.4 | mV |
| | | | | 788.0 | 800 | 812.8 | |
| | | | Power Save Mode operation, $C_{OUT} = 22\mu\text{F}$ | 781.6 | 800 | 822.4 | |
| | Tracking Feedback Voltage (TPS62130) | $V_{SS/TR} = 350\text{ mV}$ | | 212.6 | 225 | 237.4 | mV |
| Load regulation ⁽⁵⁾ | $V_{IN} = 12\text{ V}$, $V_{OUT} = 3.3\text{ V}$, PWM mode operation | | | 0.05 | | %/A | |
| Line regulation ⁽⁵⁾ | $3\text{ V} \leq V_{IN} \leq 17\text{ V}$, $V_{OUT} = 3.3\text{ V}$, $I_{OUT} = 1\text{ A}$, PWM mode operation | | | 0.02 | | %/V | |

(1) The device is still functional down to Under Voltage Lockout (see parameter V_{UVLO}).

(2) Current into AVIN+PVIN pin.

(3) This is the static current limit. It can be temporarily higher in applications due to internal propagation delay (see [セクション 8.4.4](#) section).

(4) This is the accuracy provided at the FB pin for the adjustable V_{OUT} version (line and load regulation effects are not included). For the fixed output voltage versions the (internal) resistive divider is included.

(5) Line and load regulation depend on external component selection and layout (see [9-16](#) and [9-17](#)).

7.6 Typical Characteristics

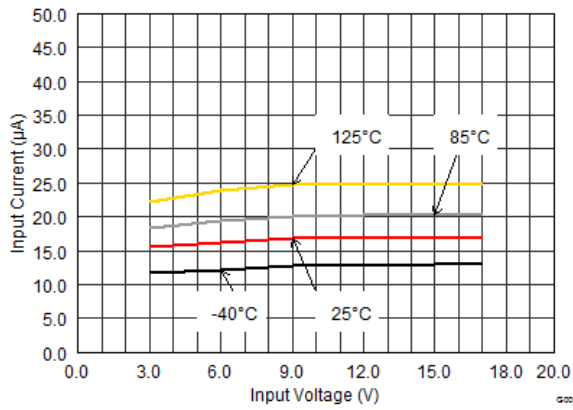

7-1. Quiescent Current

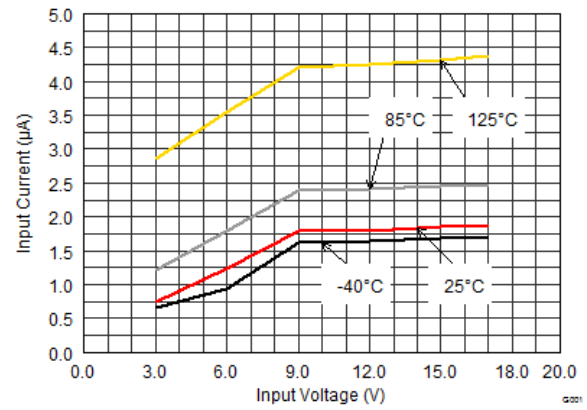

7-2. Shutdown Current

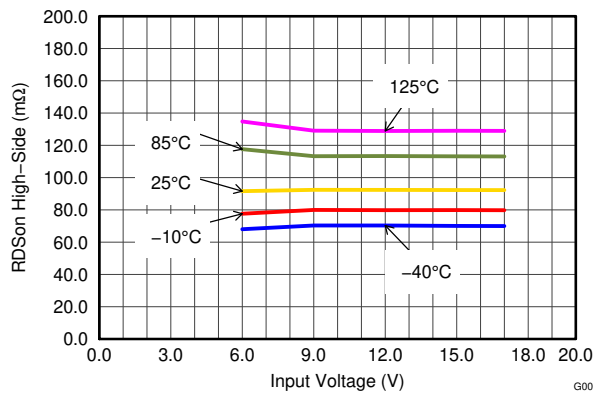

7-3. High-Side Switch Resistance

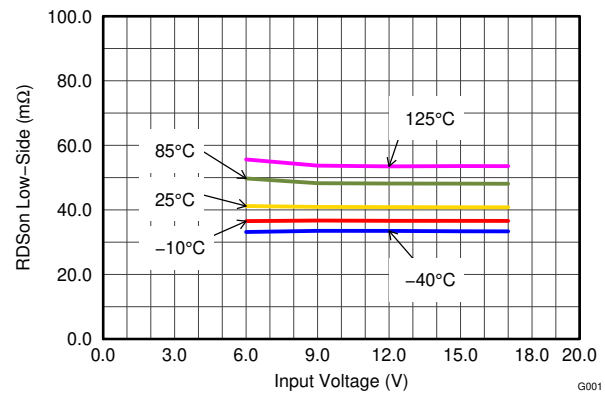

7-4. Low-Side Switch Resistance

8 Detailed Description

8.1 Overview

The TPS6213x synchronous switched mode power converters are based on DCS-Control (**D**irect **C**ontrol with **S**eamless **T**ransition into power save mode), an advanced regulation topology that combines the advantages of hysteretic, voltage mode, and current mode control including an AC loop directly associated to the output voltage. This control loop takes information about output voltage changes and feeds it directly to a fast comparator stage. It sets the switching frequency, which is constant for steady state operating conditions, and provides immediate response to dynamic load changes. To get accurate DC load regulation, a voltage feedback loop is used. The internally compensated regulation network achieves fast and stable operation with small external components and low-ESR capacitors.

The DCS-Control topology supports PWM (Pulse Width Modulation) mode for medium and heavy load conditions and a power save mode at light loads. During PWM, the device operates at its nominal switching frequency in continuous conduction mode. This frequency is typically approximately 2.5 MHz or 1.25 MHz with a controlled frequency variation depending on the input voltage. If the load current decreases, the converter enters power save mode to sustain high efficiency down to very light loads. In power save mode, the switching frequency decreases linearly with the load current. Since DCS-Control supports both operation modes within one single building block, the transition from PWM to power save mode is seamless without effects on the output voltage.

Fixed output voltage versions provide the smallest solution size and lowest current consumption, requiring only four external components. An internal current limit supports nominal output currents of up to 3 A.

The TPS6213x family offers both excellent DC voltage and superior load transient regulation, combined with very low output voltage ripple, minimizing interference with RF circuits.

8.2 Functional Block Diagram

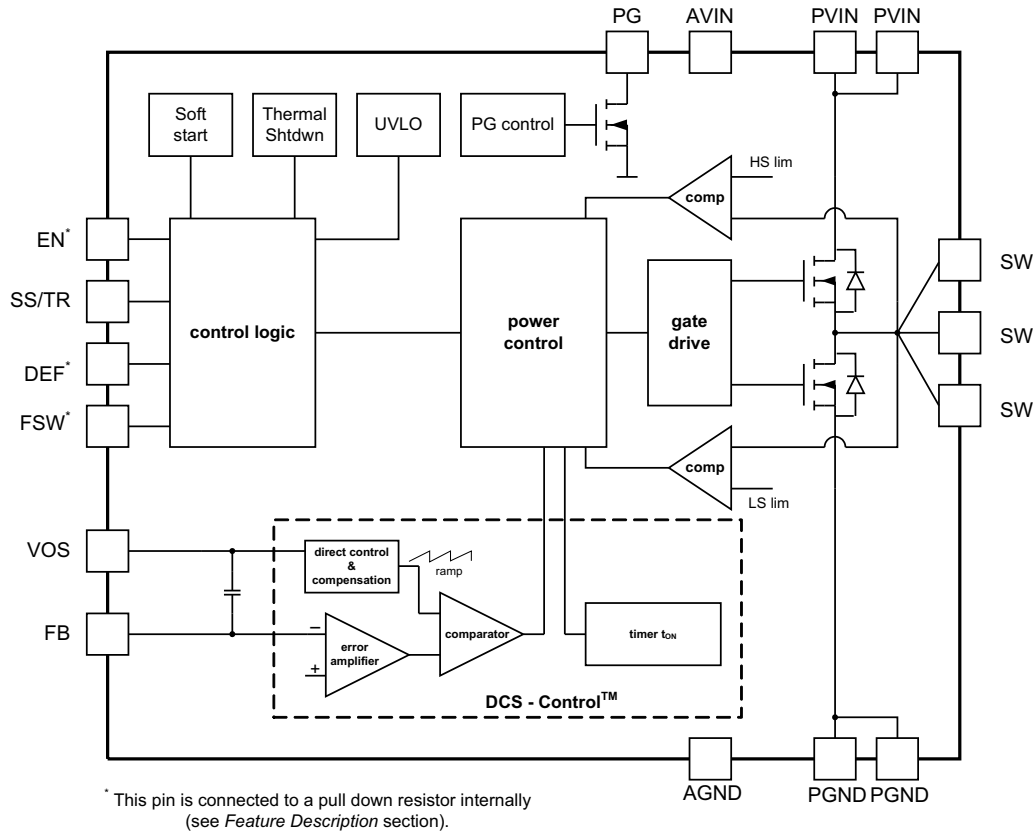

* This pin is connected to a pulldown resistor internally (see [セクション 8.3](#)).

図 8-1. TPS62130 and TPS62130A (Adjustable Output Voltage)



図 8-2. TPS62131/2/3 (Fixed Output Voltage)

8.3 Feature Description

8.3.1 Enable / Shutdown (EN)

When Enable (EN) is set High, the device starts operation. Shutdown is forced if EN is pulled Low with a shutdown current of typically 1.5 μ A. During shutdown, the internal power MOSFETs as well as the entire control circuitry are turned off. The internal resistive divider pulls down the output voltage smoothly. The EN signal must be set externally to High or Low. An internal pulldown resistor of approximately 400 k Ω is connected and keeps EN logic low, if Low is set initially and then the pin gets floating. It is disconnected if the pin is set High.

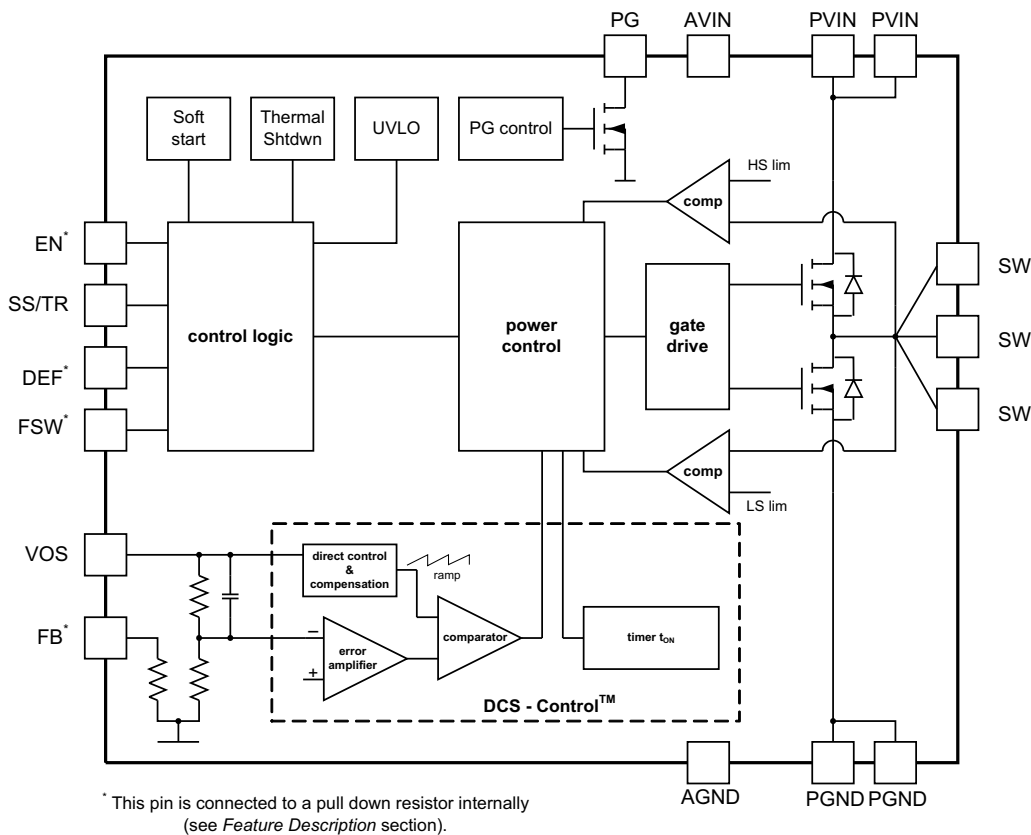
Connecting the EN pin to an appropriate output signal of another power rail provides sequencing of multiple power rails.

8.3.2 Soft Start / Tracking (SS/TR)

The internal soft start circuitry controls the output voltage slope during start-up. This avoids excessive inrush current and ensures a controlled output voltage rise time. It also prevents unwanted voltage drops from high-impedance power sources or batteries. When EN is set to start device operation, the device starts switching after a delay of approximately 50 μ s and V_{OUT} rises with a slope controlled by an external capacitor connected to the SS/TR pin. See 図 9-34 and 図 9-35 for typical start-up operation.

Using a very small capacitor (or leaving SS/TR pin un-connected) provides fastest start-up behavior. There is no theoretical limit for the longest start-up time. The TPS6213x can start into a pre-biased output. During monotonic pre-biased start-up, both the power MOSFETs are not allowed to turn on until the internal ramp of the device sets an output voltage above the pre-bias voltage. As long as the output is below approximately 0.5 V, a reduced current limit of typically 1.6 A is set internally. If the device is set to shutdown (EN = GND), undervoltage lockout, or thermal shutdown, an internal resistor pulls the SS/TR pin down to ensure a proper low level. Returning from those states causes a new start-up sequence as set by the SS/TR connection.

A voltage supplied to SS/TR can be used for tracking a primary voltage. The output voltage will follow this voltage in both directions up and down (see [セクション 9](#)).

8.3.3 Power Good (PG)

The TPS6213x has a built-in power good (PG) function to indicate whether the output voltage has reached its appropriate level or not. The PG signal can be used for start-up sequencing of multiple rails. The PG pin is an open-drain output that requires a pullup resistor (to any voltage below 7 V). It can sink 2 mA of current and maintain its specified logic low level. With TPS62130, it is high impedance when the device is turned off due to EN, UVLO, or thermal shutdown. The TPS62130A features PG = Low in this case and can be used to actively discharge V_{OUT} (see [図 9-41](#)). V_{IN} must remain present for the PG pin to stay Low. See the [TPS62130A Differences to TPS62130 Application Report](#) for application details. If not used, the PG pin should be connected to GND but may be left floating.

表 8-1. Power Good Pin Logic Table (TPS62130)

| DEVICE STATE | | PG LOGIC STATUS | |
|----------------------|------------------------------------|-----------------|-----|
| | | HIGH IMPEDANCE | LOW |
| Enable (EN = High) | $V_{FB} \geq V_{TH_PG}$ | √ | |
| | $V_{FB} \leq V_{TH_PG}$ | | √ |
| Shutdown (EN = Low) | | √ | |
| UVLO | $0.7\text{ V} < V_{IN} < V_{UVLO}$ | √ | |
| Thermal Shutdown | $T_J > T_{SD}$ | √ | |
| Power Supply Removal | $V_{IN} < 0.7\text{ V}$ | √ | |

表 8-2. Power Good Pin Logic Table (TPS62130A)

| DEVICE STATE | | PG LOGIC STATUS | |
|----------------------|------------------------------------|-----------------|-----|
| | | HIGH IMPEDANCE | LOW |
| Enable (EN = High) | $V_{FB} \geq V_{TH_PG}$ | √ | |
| | $V_{FB} \leq V_{TH_PG}$ | | √ |
| Shutdown (EN = Low) | | | √ |
| UVLO | $0.7\text{ V} < V_{IN} < V_{UVLO}$ | | √ |
| Thermal Shutdown | $T_J > T_{SD}$ | | √ |
| Power Supply Removal | $V_{IN} < 0.7\text{ V}$ | √ | |

8.3.4 Pin-Selectable Output Voltage (DEF)

The output voltage of the TPS6213x devices can be increased by 5% above the nominal voltage by setting the DEF pin to High.¹ When DEF is Low, the device regulates to the nominal output voltage. Increasing the nominal voltage allows the user to adapt the power supply voltage to the variations of the application hardware. More detailed information on voltage margining using TPS6213x can be found in [Voltage Margining Using the TPS62130 Application Report](#). A pulldown resistor of approximately 400 kΩ is internally connected to the pin to ensure a proper logic level if the pin is high impedance or floating after initially set to Low. The resistor is disconnected if the pin is set High.

8.3.5 Frequency Selection (FSW)

To get high power density with a very small solution size, a high switching frequency allows the use of small external components for the output filter. However, switching losses increase with the switching frequency. If

¹ Maximum allowed voltage is 7 V. Therefore, it is recommended to connect it to V_{OUT} or PG, not V_{IN} .

efficiency is the key parameter, more than solution size, the switching frequency can be set to half (1.25 MHz typical) by pulling FSW to High. It is mandatory to start with FSW = Low to limit inrush current, which can be done by connecting the pin to V_{OUT} or PG. Running with lower frequency, a higher efficiency, but also a higher output voltage ripple, is achieved. Pull FSW to Low for high frequency operation (2.5 MHz typical). To get low ripple and full output current at the lower switching frequency, it is recommended to use an inductor of at least 2.2 µH. The switching frequency can be changed during operation, if needed. A pulldown resistor of about 400 kΩ is internally connected to the pin, acting the same way as at the DEF pin (see above).

8.3.6 Undervoltage Lockout (UVLO)

If the input voltage drops, the undervoltage lockout prevents misoperation of the device by switching off both the power FETs. The undervoltage lockout threshold is set typically to 2.7 V. The device is fully operational for voltages above the UVLO threshold and turns off if the input voltage trips the threshold. The converter starts operation again once the input voltage exceeds the threshold by a hysteresis of typically 200 mV.

8.3.7 Thermal Shutdown

The junction temperature (T_J) of the device is monitored by an internal temperature sensor. If T_J exceeds 160°C (typical), the device goes into thermal shutdown. Both the high-side and low-side power FETs are turned off and PG goes high impedance. When T_J decreases below the hysteresis amount, the converter resumes normal operation, beginning with soft start. To avoid unstable conditions, a hysteresis of typically 20°C is implemented on the thermal shutdown temperature.

8.4 Device Functional Modes

8.4.1 Pulse Width Modulation (PWM) Operation

The TPS6213x operates with pulse width modulation in continuous conduction mode (CCM) with a nominal switching frequency of 2.5 MHz or 1.25 MHz, selectable with the FSW pin. The frequency variation in PWM is controlled and depends on V_{IN}, V_{OUT}, and the inductance. The device operates in PWM mode as long the output current is higher than half the ripple current of the inductor. To maintain high efficiency at light loads, the device enters power save mode at the boundary to discontinuous conduction mode (DCM). This happens if the output current becomes smaller than half the ripple current of the inductor.

8.4.2 Power Save Mode Operation

The TPS6213x enters its built-in power save mode seamlessly if the load current decreases. This secures a high efficiency in light-load operation. The device remains in power save mode as long as the inductor current is discontinuous.

In power save mode, the switching frequency decreases linearly with the load current maintaining high efficiency. The transition into and out of power save mode happens within the entire regulation scheme and is seamless in both directions.

The TPS6213x includes a fixed on-time circuitry. An estimate for this on time in steady-state operation with FSW = Low is:

$$t_{ON} = \frac{V_{OUT}}{V_{IN}} \cdot 400ns \quad (1)$$

For very small output voltages, an absolute minimum on time of approximately 80 ns is kept to limit switching losses. The operating frequency is thereby reduced from its nominal value, which keeps efficiency high. Also, the off time can reach its minimum value at high duty cycles. The output voltage remains regulated in such case. Using t_{ON}, the typical peak inductor current in power save mode can be approximated by:

$$I_{LPSM(peak)} = \frac{(V_{IN} - V_{OUT})}{L} \cdot t_{ON} \quad (2)$$

When V_{IN} decreases to typically 15% above V_{OUT}, the TPS6213x does not enter power save mode, regardless of the load current. The device maintains output regulation in PWM mode.

8.4.3 100% Duty-Cycle Operation

The duty cycle of the buck converter is given by $D = V_{OUT} / V_{IN}$ and increases as the input voltage comes close to the output voltage. In this case, the device starts 100% duty cycle operation turning on the high-side switch 100% of the time. The high-side switch stays turned on as long as the output voltage is below the internal set point. This allows the conversion of small input to output voltage differences (for example, for the longest operation time of battery-powered applications). In 100% duty cycle mode, the low-side FET is switched off.

The minimum input voltage to maintain output voltage regulation, depending on the load current and the output voltage level, can be calculated as:

$$V_{IN(min)} = V_{OUT(min)} + I_{OUT} (R_{DS(on)} + R_L) \quad (3)$$

where

- I_{OUT} is the output current.
- $R_{DS(on)}$ is the $R_{DS(on)}$ of the high-side FET.
- R_L is the DC resistance of the inductor used.

8.4.4 Current Limit And Short Circuit Protection

The TPS6213x devices have protection against heavy load and short circuit events. If a short circuit is detected (V_{OUT} drops below 0.5 V), the current limit is reduced to 1.6 A typically. If the output voltage rises above 0.5 V, the device runs in normal operation again. At heavy loads, the current limit determines the maximum output current. If the current limit is reached, the high-side FET is turned off. Avoiding shoot-through current, then the low-side FET switches on to allow the inductor current to decrease. The low-side current limit is typically 3.5 A. The high-side FET turns on again only if the current in the low-side FET has decreased below the low-side current limit threshold.

The output current of the device is limited by the current limit. Due to internal propagation delay, the actual current can exceed the static current limit during that time. The dynamic current limit can be calculated as follows:

$$I_{peak(typ)} = I_{LIMF} + \frac{V_L}{L} \cdot t_{PD} \quad (4)$$

where

- I_{LIMF} is the static current limit, specified in the [Electrical Characteristics](#).
- L is the inductor value.
- V_L is the voltage across the inductor ($V_{IN} - V_{OUT}$).
- t_{PD} is the internal propagation delay.

The current limit can exceed static values, especially if the input voltage is high and very small inductances are used. The dynamic high-side switch peak current can be calculated as follows:

$$I_{peak(typ)} = I_{LIMF} + \frac{(V_{IN} - V_{OUT})}{L} \cdot 30ns \quad (5)$$

9 Application and Implementation

Note

以下のアプリケーション情報は、TI の製品仕様に含まれるものではなく、TI ではその正確性または完全性を保証いたしません。個々の目的に対する製品の適合性については、お客様の責任で判断していただくこととなります。お客様は自身の設計実装を検証しテストすることで、システムの機能を確認する必要があります。

9.1 Application Information

The TPS6213x is a switched mode step-down converter that is able to convert a 3V- to 17-V input voltage into a 0.9-V to 6-V output voltage, providing up to 3 A. The device needs a minimum amount of external components. Apart from the LC output filter and the input capacitors, only the TPS62130 (TPS62130A) with adjustable output voltage needs an additional resistive divider to set the output voltage level.

9.2 Typical Application



図 9-1. 3-A Step-Down Converter for Point-Of-Load Power Supply Using the TPS62130

9.2.1 Design Requirements

The following design guideline provides a component selection to operate the device within the recommended operating conditions. Using the FSW pin, the design can be optimized for highest efficiency or smallest solution size and lowest output voltage ripple. For highest efficiency set FSW = High and the device operates at the lower switching frequency. For the smallest solution size and lowest output voltage ripple, set FSW = Low and the device operates with higher switching frequency. The typical values for all measurements are $V_{IN} = 12\text{ V}$, $V_{OUT} = 3.3\text{ V}$ and $T = 25^\circ\text{C}$, using the external components of 表 9-1.

The component selection used for measurements is given as follows:

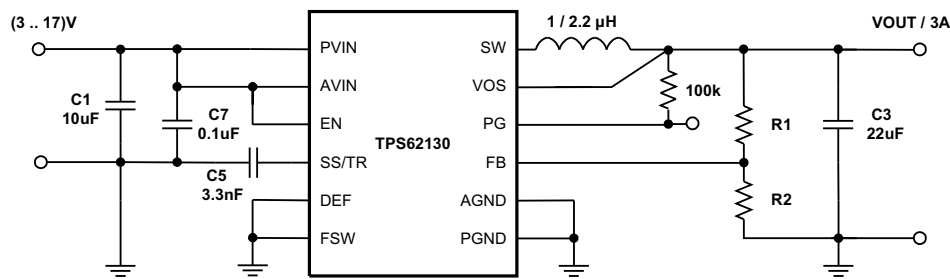
表 9-1. List Of Components

| REFERENCE | DESCRIPTION | MANUFACTURER ⁽¹⁾ |
|-----------|---|--------------------------------|
| IC | 17-V, 3-A Step-Down Converter, QFN | TPS62130RGT, Texas Instruments |
| L1 | 2.2 μH , 0.165 inch x 0.165 inch | XFL4020-222MEB, Coilcraft |
| C1 | 10 μF , 25 V, Ceramic, 1210 | Standard |
| C3 | 22 μF , 6.3 V, Ceramic, 0805 | Standard |
| C5 | 3300 pF, 25 V, Ceramic, 0603 | Standard |
| C7 | 0.1 μF , 25 V, Ceramic, 0603 | Standard |
| R1 | depending on V_{OUT} | |
| R2 | depending on V_{OUT} | |
| R3 | 100 k Ω , Chip, 0603, 1/16W, 1% | Standard |

(1) See the [Third-Party Products Disclaimer](#).

9.2.2 Detailed Design Procedure

9.2.2.1 Programming The Output Voltage

While the output voltage of the TPS62130 (TPS62130A) is adjustable, the TPS62131, TPS62132, and TPS62133 are programmed to fixed output voltages. For fixed output voltage versions, the FB pin is pulled down internally and can be left floating. It is recommended to connect to AGND to improve thermal resistance. The adjustable version can be programmed for output voltages from 0.9 V to 6 V by using a resistive divider from V_{OUT} to AGND. The voltage at the FB pin is regulated to 800 mV. The value of the output voltage is set by the selection of the resistive divider from 式 6. It is recommended to choose resistor values that allow a current of at least 2 μA, meaning the value of R₂ should not exceed 400 kΩ. Lower resistor values are recommended for the highest accuracy and most robust design. For applications requiring lowest current consumption, the use of fixed output voltage versions is recommended.

$$R_1 = R_2 \left(\frac{V_{OUT}}{0.8V} - 1 \right) \quad (6)$$

In case the FB pin gets opened, the device clamps the output voltage at the VOS pin internally to approximately 7.4 V.

9.2.2.2 External Component Selection

The external components have to fulfill the needs of the application, but also the stability criteria of the devices control loop. The TPS6213x is optimized to work within a range of external components. The inductance of the LC output filter and capacitance have to be considered together, creating a double pole, responsible for the corner frequency of the converter (see セクション 9.2.2.4). 表 9-2 can be used to simplify the output filter component selection. Checked cells represent combinations that are proven for stability by simulation and lab test. Further combinations should be checked for each individual application. See [Optimizing the TPS62130/40/50/60 Output Filter Application Report](#) for details.

表 9-2. Recommended LC Output Filter Combinations

| | 4.7 μF | 10 μF | 22 μF | 47 μF | 100 μF | 200 μF | 400 μF |
|------------------------|--------|-------|------------------|-------|--------|--------|--------|
| 0.47 μH ⁽¹⁾ | | | | | | | |
| 1 μH ⁽¹⁾ | | | √ | √ | √ | √ | |
| 2.2 μH ⁽¹⁾ | | √ | √ ⁽²⁾ | √ | √ | √ | |
| 3.3 μH ⁽¹⁾ | | √ | √ | √ | √ | | |
| 4.7 μH ⁽¹⁾ | | | | | | | |

(1) The values in the table are nominal values. The effective capacitance was considered to vary by +20% and -50%.

(2) This LC combination is the standard value and recommended for most applications.

The TPS6213x can be run with an inductor as low as 1 μH. FSW should be set Low in this case. However, for applications running with the low frequency setting (FSW = High) or with low input voltages, 2.2 μH is recommended.

9.2.2.2.1 Inductor Selection

The inductor selection is affected by several effects like inductor ripple current, output ripple voltage, PWM-to-PSM transition point, and efficiency. In addition, the inductor selected has to be rated for appropriate saturation current and DC resistance (DCR). 式 7 and 式 8 calculate the maximum inductor current under static load conditions.

$$I_{L(max)} = I_{OUT(max)} + \frac{\Delta I_{L(max)}}{2} \quad (7)$$

$$\Delta I_{L(\max)} = V_{OUT} \cdot \left(\frac{1 - \frac{V_{OUT}}{V_{IN(\max)}}}{L_{(\min)} \cdot f_{SW}} \right) \quad (8)$$

where

- $I_{L(\max)}$ is the maximum inductor current.
- ΔI_L is the peak-to-peak inductor ripple current.
- $L_{(\min)}$ is the minimum effective inductor value.
- f_{SW} is the actual PWM switching frequency.

Calculating the maximum inductor current using the actual operating conditions gives the required minimum saturation current of the inductor. It is recommended to add a margin of approximately 20%. A larger inductor value is also useful to get lower ripple current, but increases the transient response time and size as well. The following inductors have been used with the TPS6213x and are recommended for use:

表 9-3. List Of Inductors

| TYPE | INDUCTANCE [μH] | CURRENT [A] ⁽¹⁾ | DIMENSIONS [L × B × H] mm | MANUFACTURER ⁽²⁾ |
|----------------|-----------------|----------------------------|---------------------------|-----------------------------|
| XFL4020-102ME_ | 1.0 μH, ±20% | 4.7 | 4 × 4 × 2.1 | Coilcraft |
| XFL4020-152ME_ | 1.5 μH, ±20% | 4.2 | 4 × 4 × 2.1 | Coilcraft |
| XFL4020-222ME_ | 2.2 μH, ±20% | 3.8 | 4 × 4 × 2.1 | Coilcraft |
| IHLP1212BZ-11 | 1.0 μH, ±20% | 4.5 | 3 × 3.6 × 2 | Vishay |
| IHLP1212BZ-11 | 2.2 μH, ±20% | 3.0 | 3 × 3.6 × 2 | Vishay |
| SRP4020-3R3M | 3.3μH, ±20% | 3.3 | 4.8 × 4 × 2 | Bourns |
| VLC5045T-3R3N | 3.3μH, ±30% | 4.0 | 5 × 5 × 4.5 | TDK |

(1) Lower of I_{RMS} at 40°C rise or I_{SAT} at 30% drop.

(2) See the [Third-Party Products Disclaimer](#).

The inductor value also determines the load current at which power save mode is entered:

$$I_{load(PSM)} = \frac{1}{2} \Delta I_L \quad (9)$$

Using 式 9, this current level can be adjusted by changing the inductor value.

9.2.2.2.2 Capacitor Selection

9.2.2.2.2.1 Output Capacitor

The recommended value for the output capacitor is 22 μF. The architecture of the TPS6213x allows the use of tiny ceramic output capacitors with low-equivalent series resistance (ESR). These capacitors provide low output voltage ripple and are recommended. To keep its low resistance up to high frequencies and to get narrow capacitance variation with temperature, it is recommended to use X7R or X5R dielectric. Using a higher value can have some advantages like smaller voltage ripple and a tighter DC output accuracy in power save mode (see [Optimizing the TPS62130/40/50/60 Output Filter Application Report](#)).

Note

In power save mode, the output voltage ripple depends on the output capacitance, its ESR, and the peak inductor current. Using ceramic capacitors provides small ESR and low ripple.

9.2.2.2.2 Input Capacitor

For most applications, 10 μF will be sufficient and is recommended, though a larger value reduces input current ripple further. The input capacitor buffers the input voltage for transient events and also decouples the converter from the supply. A low-ESR multilayer ceramic capacitor is recommended for best filtering and should be placed between PVIN and PGND as close as possible to those pins. Even though AVIN and PVIN must be supplied from the same input source, it is required to place a capacitance of 0.1 μF from AVIN to AGND, to avoid potential noise coupling. An RC, low-pass filter from PVIN to AVIN can be used but is not required.

9.2.2.2.3 Soft-Start Capacitor

A capacitance connected between the SS/TR pin and AGND allows a user-programmable start-up slope of the output voltage. A constant current source supports 2.5 μA to charge the external capacitance. The capacitor required for a given soft-start ramp time for the output voltage is given by:

$$C_{SS} = t_{SS} \cdot \frac{2.5\mu\text{A}}{1.25\text{V}} \quad [\text{F}] \quad (10)$$

where

- C_{SS} is the capacitance (F) required at the SS/TR pin.
- t_{SS} is the desired soft-start ramp time (s).

Note

DC Bias effect: High capacitance ceramic capacitors have a DC Bias effect, which will have a strong influence on the final effective capacitance. Therefore the right capacitor value has to be chosen carefully. Package size and voltage rating in combination with dielectric material are responsible for differences between the rated capacitor value and the effective capacitance.

9.2.2.3 Tracking Function

If a tracking function is desired, the SS/TR pin can be used for this purpose by connecting it to an external tracking voltage. The output voltage tracks that voltage. If the tracking voltage is between 50 mV and 1.2 V, the FB pin will track the SS/TR pin voltage as described in 式 11 and shown in 图 9-2.

$$V_{FB} \approx 0.64 \cdot V_{SS/TR} \quad (11)$$



图 9-2. Voltage Tracking Relationship

Once the SS/TR pin voltage reaches approximately 1.2 V, the internal voltage is clamped to the internal feedback voltage and device goes to normal regulation. This works for rising and falling tracking voltages with the same behavior, as long as the input voltage is inside the recommended operating conditions. For decreasing SS/TR pin voltage, the device does not sink current from the output. So, the resulting decrease of the output voltage can be slower than the SS/TR pin voltage if the load is light. When driving the SS/TR pin with an external voltage, do not exceed the voltage rating of the SS/TR pin which is $V_{IN} + 0.3\text{ V}$.

If the input voltage drops into undervoltage lockout or even down to zero, the output voltage will go to zero, independent of the tracking voltage.  9-3 shows how to connect devices to get ratiometric and simultaneous sequencing by using the tracking function.

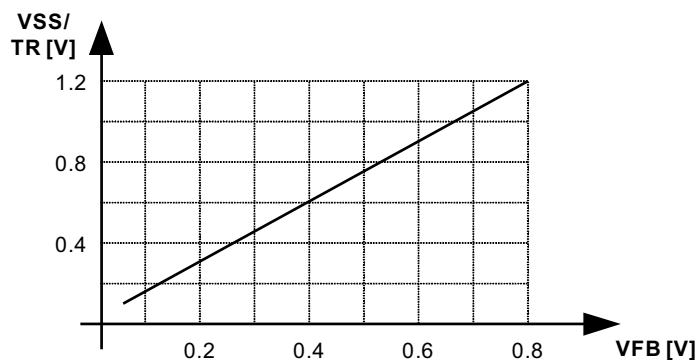
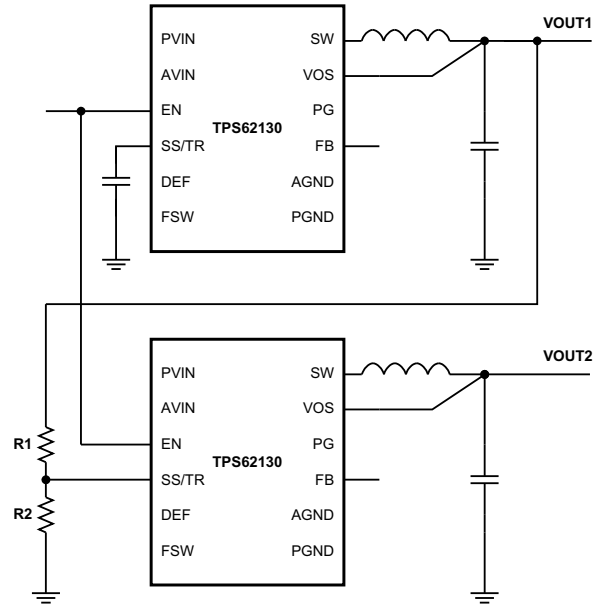
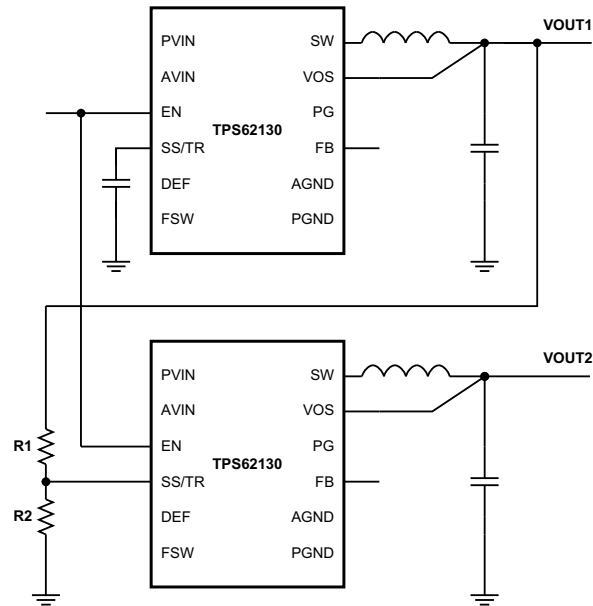

Copyright © 2016, Texas Instruments Incorporated

9-3. Sequence For Ratiometric And Simultaneous Start-Up

The resistive divider of R1 and R2 can be used to change the ramp rate of V_{OUT2} faster, slower, or the same as V_{OUT1} .

A sequential start-up is achieved by connecting the PG pin of V_{OUT1} to the EN pin of V_{OUT2} . A ratiometric start-up sequence happens if both supplies are sharing the same soft-start capacitor. 式 10 calculates the soft-start time, though the SS/TR current has to be doubled. Details about these and other tracking and sequencing circuits are found in [Sequencing and Tracking With the TPS621-Family and TPS821-Family Application Report](#).

Note

If the voltage at the FB pin is below its typical value of 0.8 V, the output voltage accuracy may have a wider tolerance than specified.

9.2.2.4 Output Filter And Loop Stability

The devices of the TPS6213x family are internally compensated to be stable with L-C filter combinations corresponding to a corner frequency to be calculated with 式 12:

$$f_{LC} = \frac{1}{2\pi\sqrt{L \cdot C}} \quad (12)$$

Proven nominal values for inductance and ceramic capacitance are given in 表 9-2 and are recommended for use. Different values can work, but care has to be taken on the loop stability which will be affected. More information including a detailed LC stability matrix can be found in [Optimizing the TPS62130/40/50/60 Output Filter Application Report](#).

The TPS6213x devices, both fixed and adjustable output voltage versions, include an internal 25-pF feedforward capacitor, connected between the VOS and FB pins. This capacitor impacts the frequency behavior and sets a pole and zero in the control loop with the resistors of the feedback divider, per 式 13 and 式 14:

$$f_{zero} = \frac{1}{2\pi \cdot R_1 \cdot 25 pF} \quad (13)$$

$$f_{pole} = \frac{1}{2\pi \cdot 25 pF} \cdot \left(\frac{1}{R_1} + \frac{1}{R_2} \right) \quad (14)$$

Though the TPS6213x devices are stable without the pole and zero being in a particular location, adjusting their location to the specific needs of the application can provide better performance in power save mode, improved transient response, or both. An external feedforward capacitor can also be added. A more detailed discussion on the optimization for stability versus transient response can be found in [Optimizing Transient Response of Internally Compensated DC-DC Converters Application Report](#) and [Feedforward Capacitor to Improve Stability and Bandwidth of TPS621/821-Family Application Report](#).

9.2.3 Application Curves

$V_{IN} = 12\text{ V}$, $V_{OUT} = 3.3\text{ V}$, $T_A = 25^\circ\text{C}$, (unless otherwise noted)

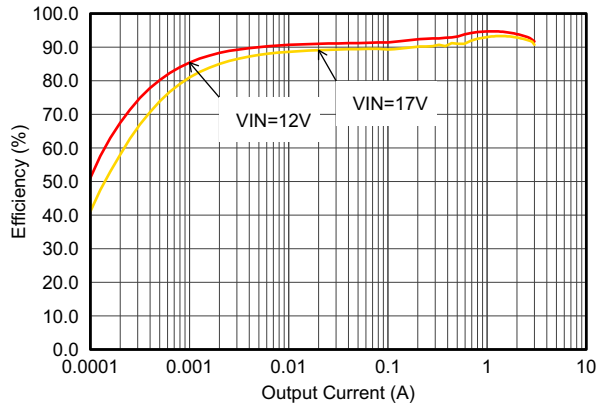

$V_{OUT} = 5\text{ V}$

9-4. Efficiency with 1.25 MHz

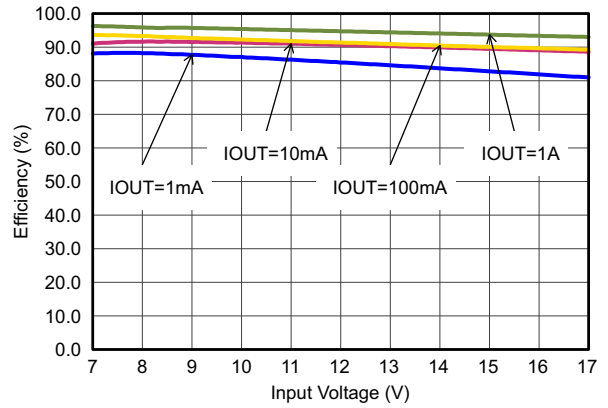

$V_{OUT} = 5\text{ V}$

9-5. Efficiency with 1.25 MHz

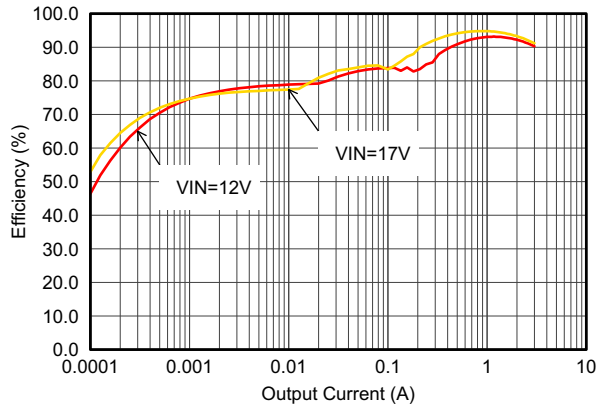

$V_{OUT} = 5\text{ V}$

9-6. Efficiency with 2.5 MHz

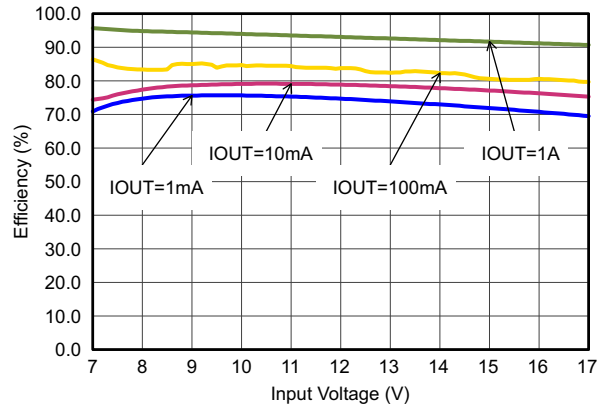

$V_{OUT} = 5\text{ V}$

9-7. Efficiency with 2.5 MHz

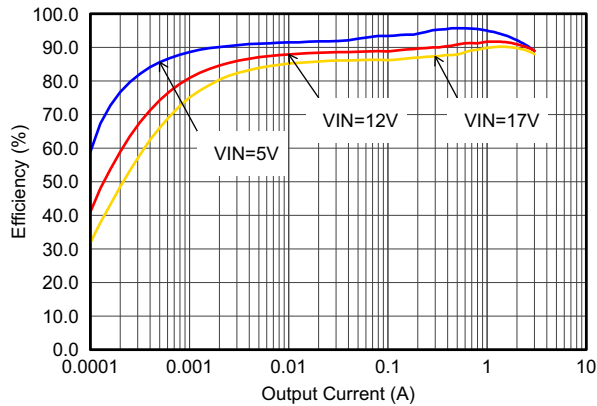

$V_{OUT} = 3.3\text{ V}$

9-8. Efficiency with 1.25 MHz

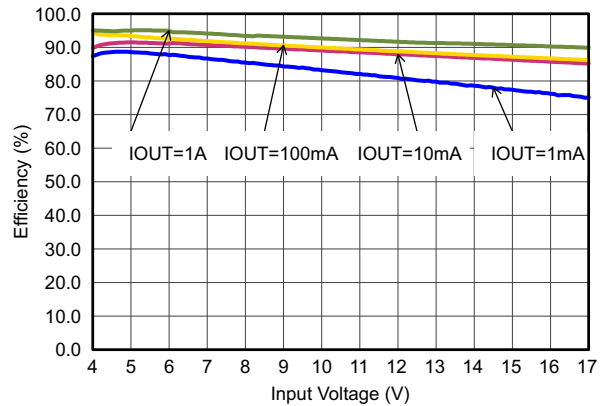

$V_{OUT} = 3.3\text{ V}$

9-9. Efficiency with 1.25 MHz

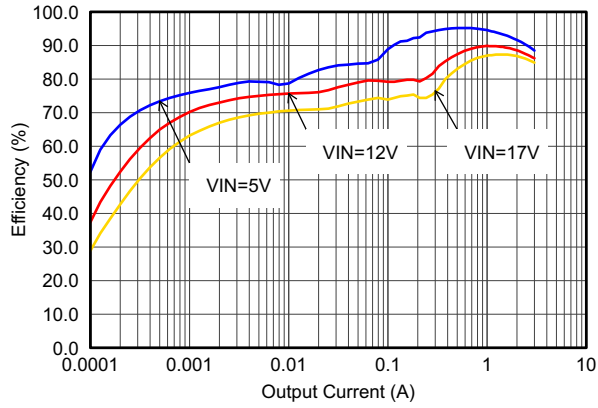

$V_{OUT} = 3.3\text{ V}$

9-10. Efficiency with 2.5 MHz

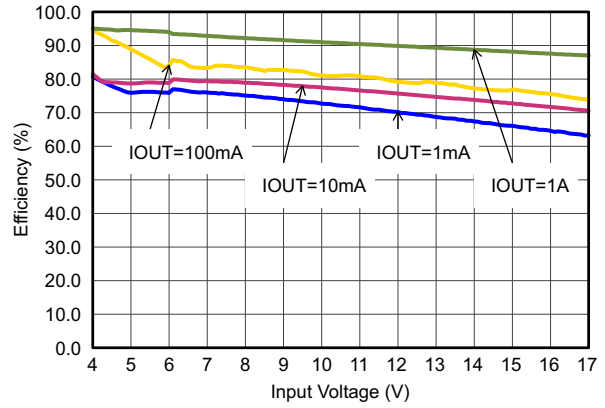

$V_{OUT} = 3.3\text{ V}$

9-11. Efficiency with 2.5 MHz

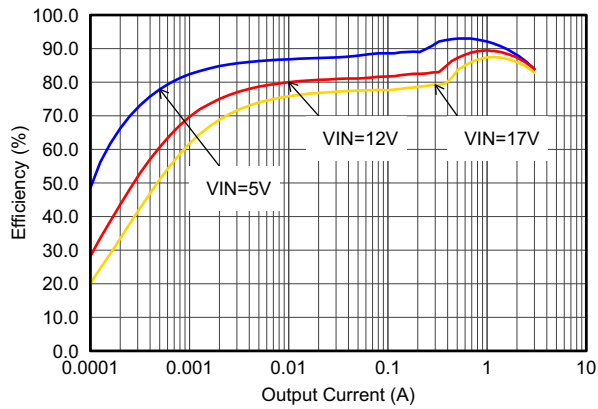

$V_{OUT} = 1.8\text{ V}$

9-12. Efficiency with 1.25 MHz

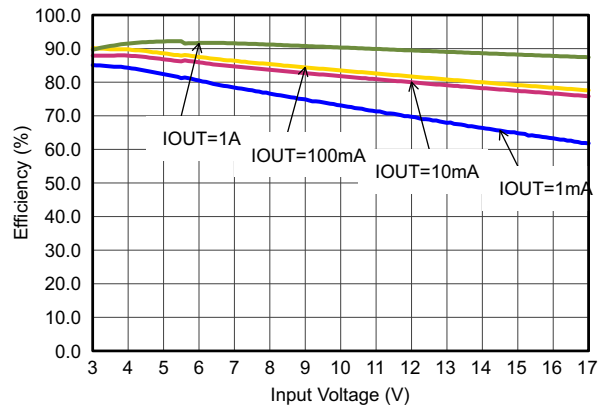

$V_{OUT} = 1.8\text{ V}$

9-13. Efficiency with 1.25 MHz

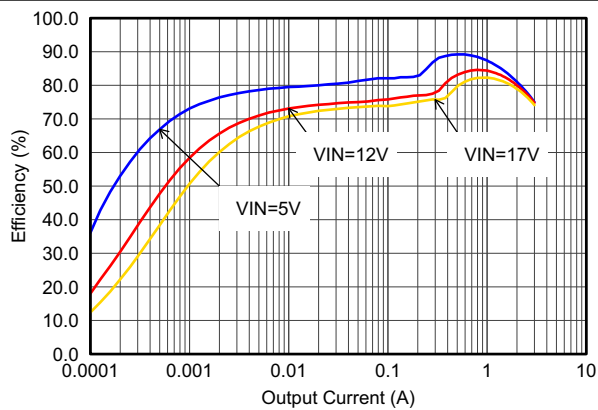

$V_{OUT} = 0.9\text{ V}$

9-14. Efficiency with 1.25 MHz

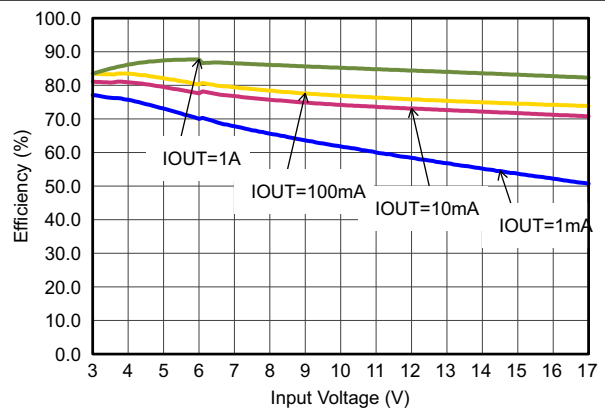

$V_{OUT} = 0.9\text{ V}$

9-15. Efficiency with 1.25 MHz

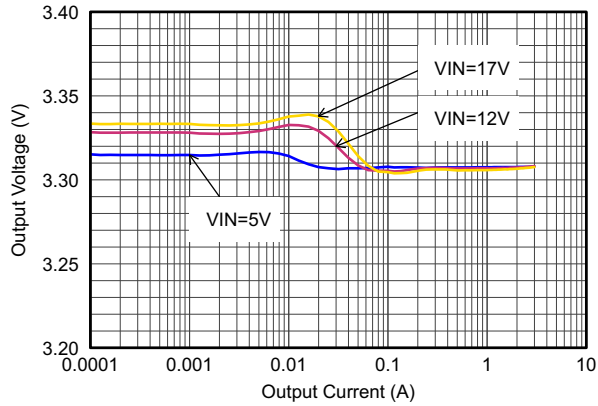

9-16. Output Voltage Accuracy (Load Regulation)

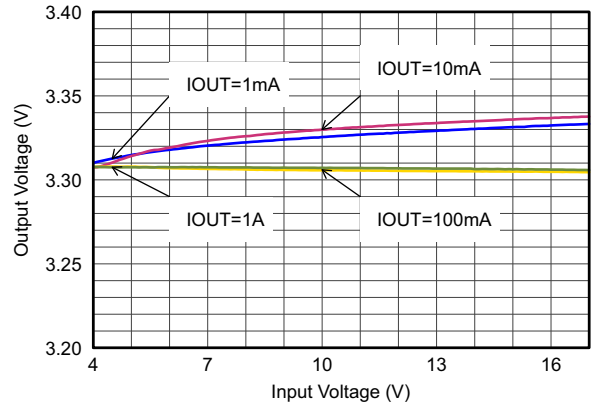

9-17. Output Voltage Accuracy (Line Regulation)

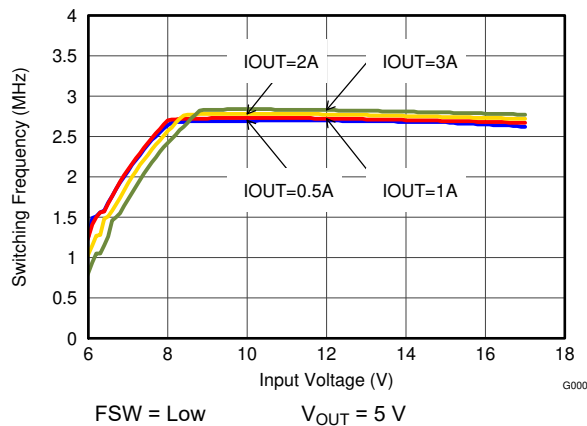

9-18. Switching Frequency vs Input Voltage

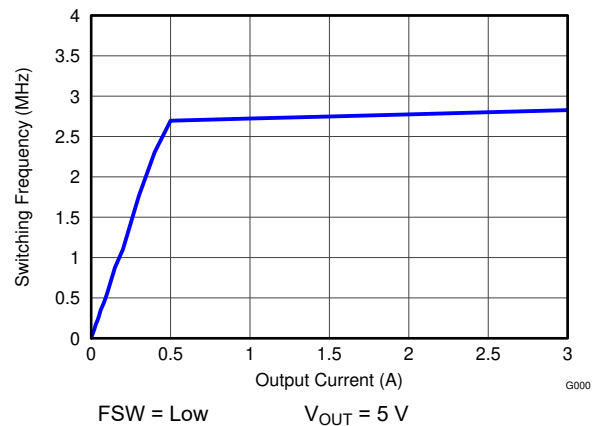

9-19. Switching Frequency vs Output Current

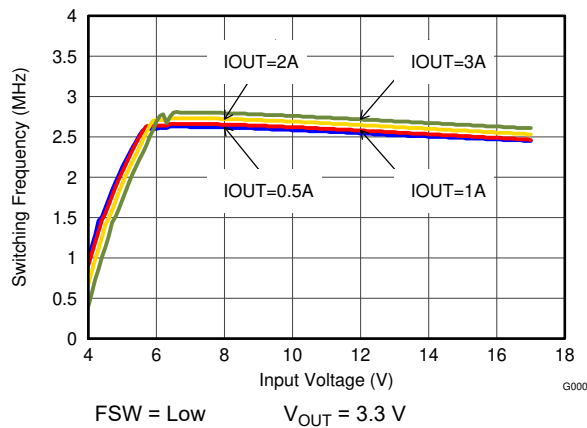

9-20. Switching Frequency vs Input Voltage

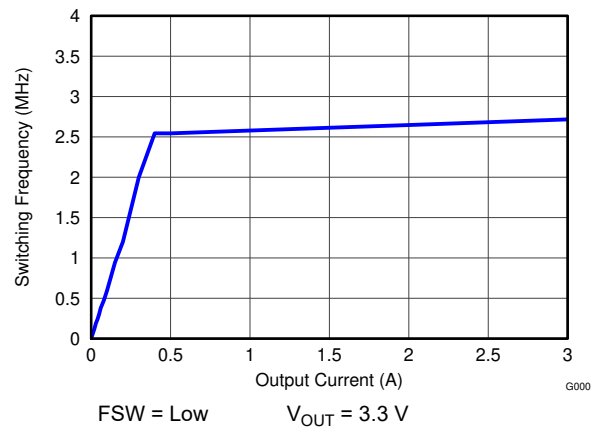

9-21. Switching Frequency vs Output Current,

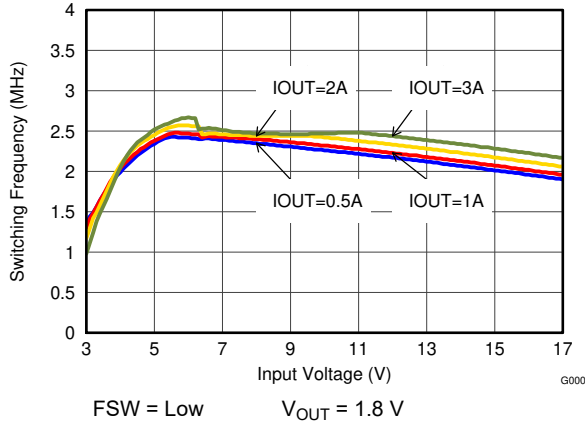

9-22. Switching Frequency vs Input Voltage

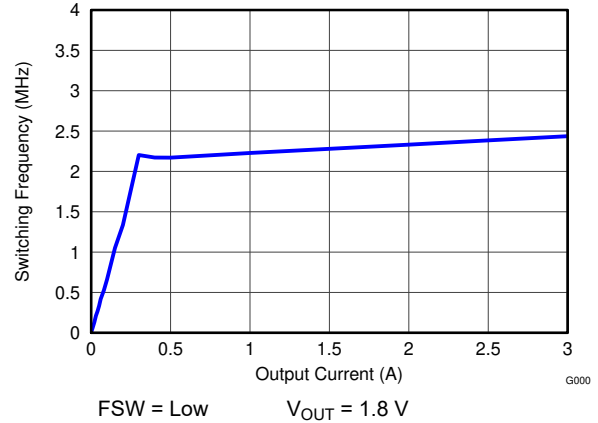

9-23. Switching Frequency vs Output Current

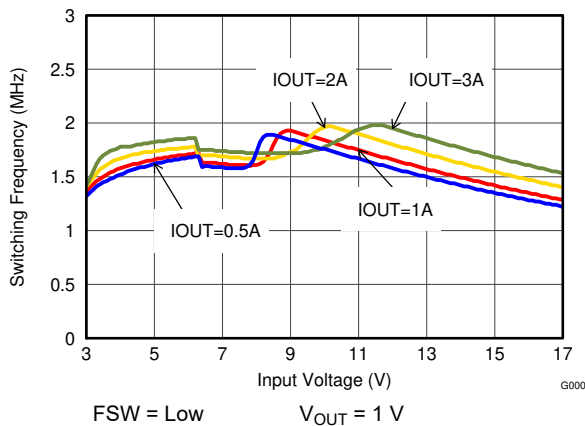

9-24. Switching Frequency vs Input Voltage

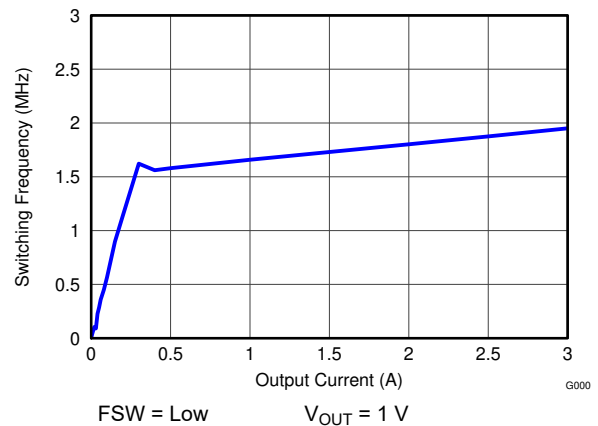

9-25. Switching Frequency vs Output Current

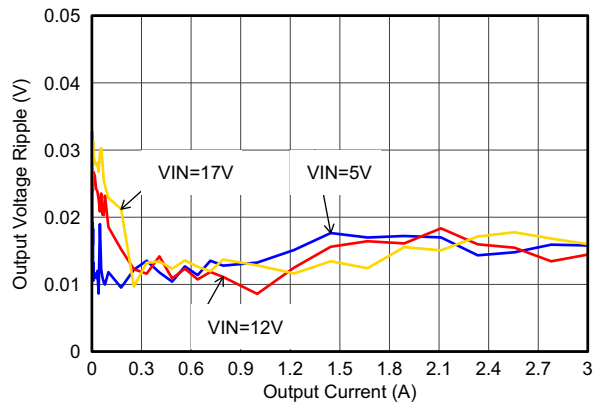

9-26. Output Voltage Ripple

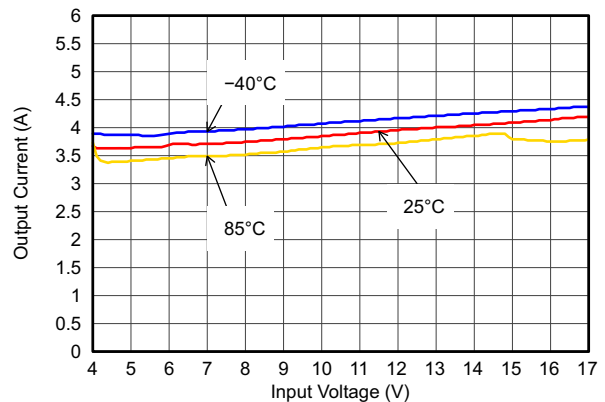

9-27. Maximum Output Current

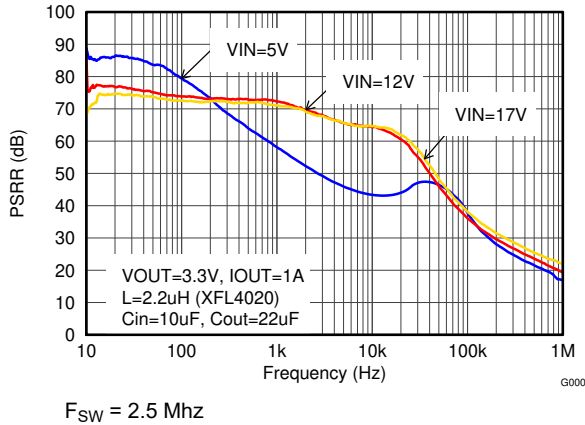

9-28. Power Supply Rejection Ratio

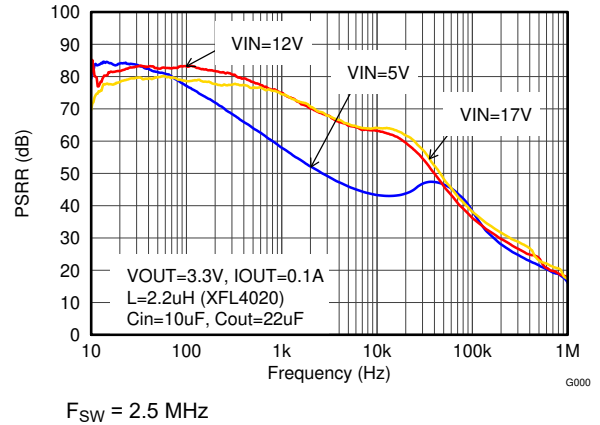

9-29. Power Supply Rejection Ratio

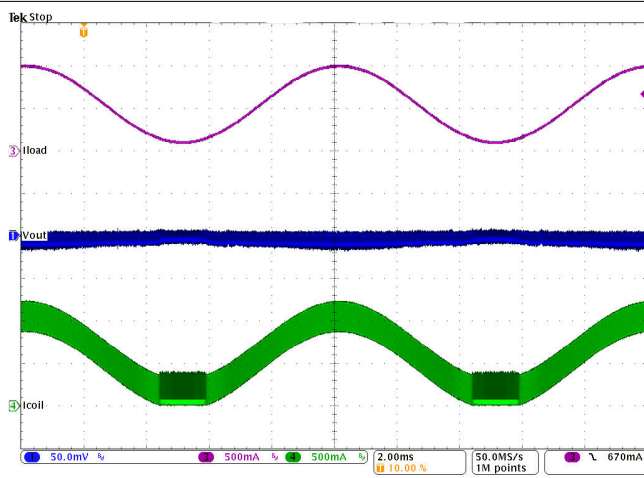

9-30. PWM-PSM-Transition

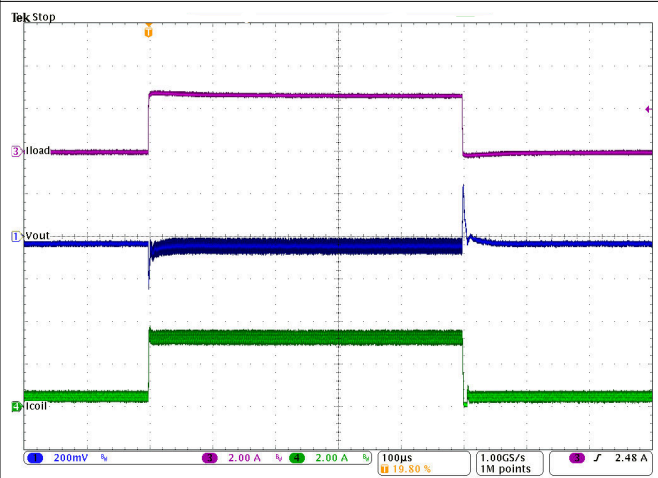

9-31. Load Transient Response

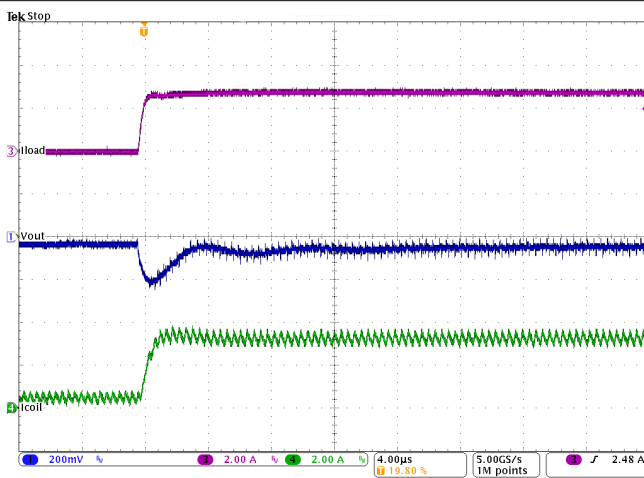

9-32. Load Transient Response of 9-31, Rising Edge

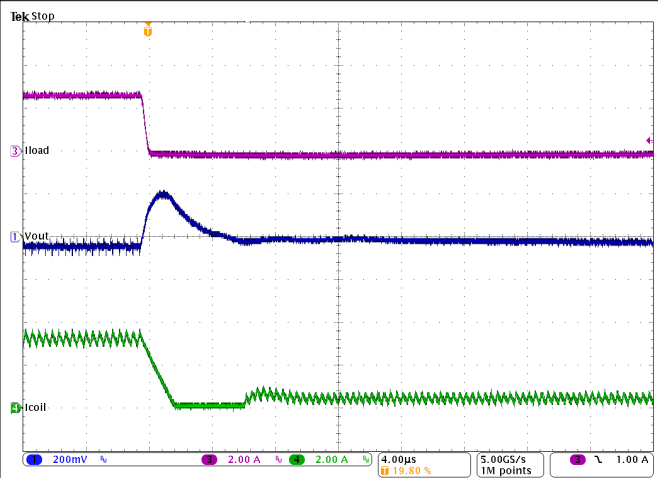

9-33. Load Transient Response of 9-31, Falling Edge

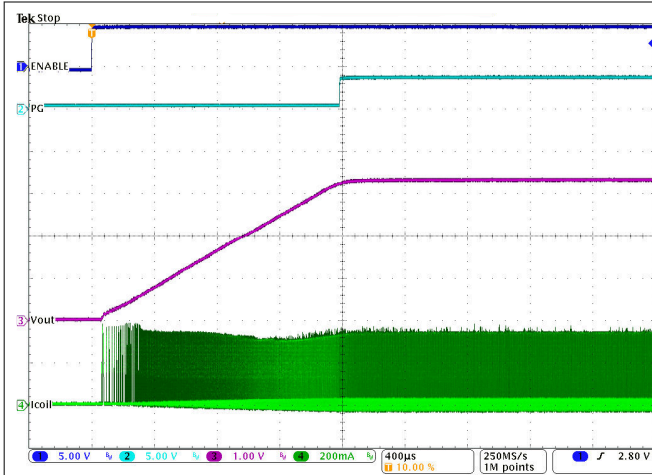

9-34. Start-Up Into 100 mA

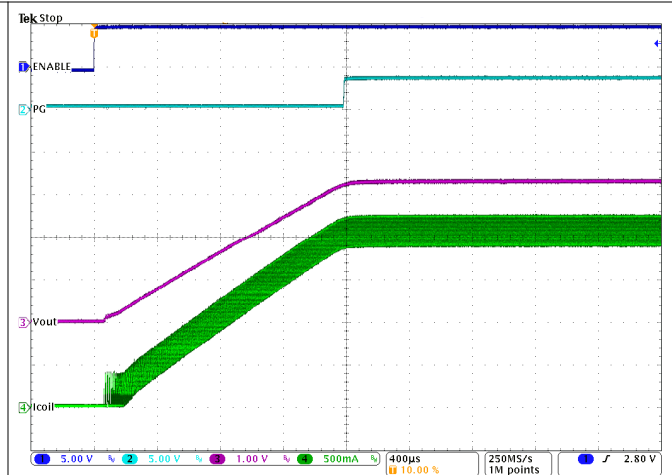

9-35. Start-Up Into 3 A

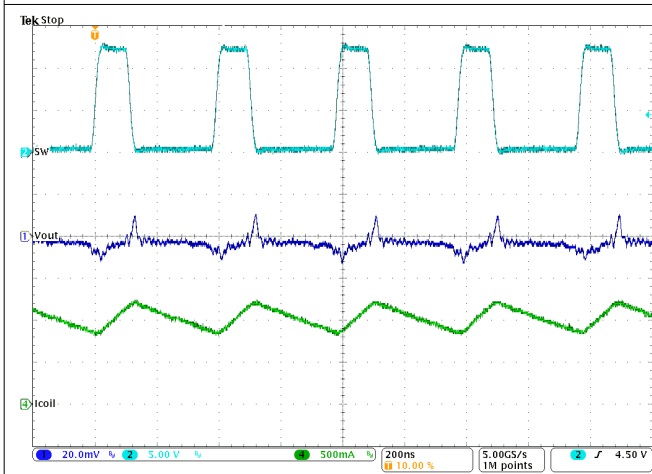

$I_{OUT} = 1 \text{ A}$

9-36. Typical Operation In PWM Mode

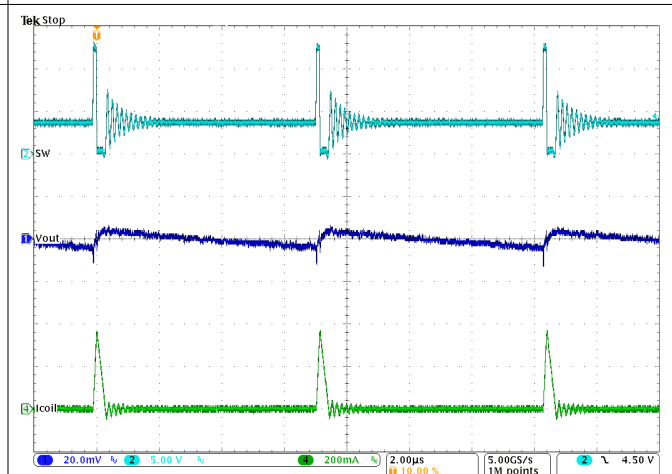

$I_{OUT} = 10 \text{ mA}$

9-37. Typical Operation In Power Save Mode

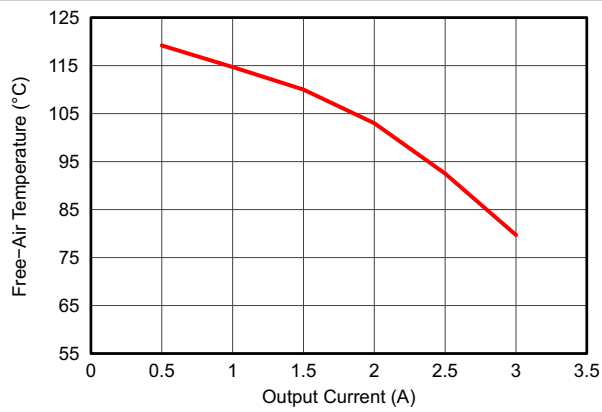

$F_{SW} = 2.5 \text{ MHz}$

TPS62130EVM
 $L = 2.2 \mu\text{H}$ (XFL4020)

9-38. Maximum Ambient Temperature

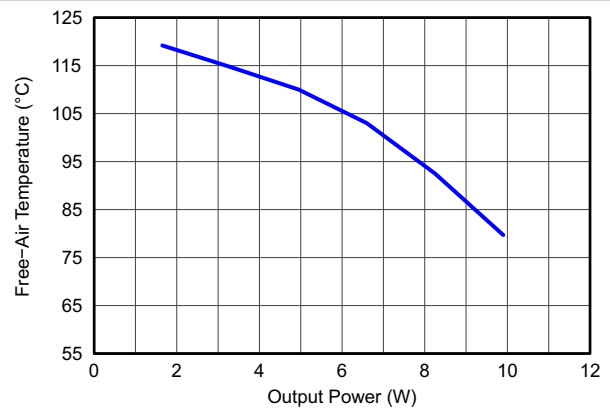

$F_{SW} = 2.5 \text{ MHz}$

TPS62130EVM
 $L = 2.2 \mu\text{H}$ (XFL4020)

9-39. Maximum Ambient Temperature

9.3 System Examples

9.3.1 LED Power Supply

The TPS62130 can be used as a power supply for power LEDs. The FB pin can be easily set down to lower values than nominal by using the SS/TR pin. With that, the voltage drop on the sense resistor is low to avoid excessive power loss. Since this pin provides 2.5 μA , the feedback pin voltage can be adjusted by an external resistor per 式 15. This drop, proportional to the LED current, is used to regulate the output voltage (anode voltage) to a proper level to drive the LED. Both analog and PWM dimming are supported with the TPS62130. 图 9-40 shows an application circuit, tested with analog dimming:



图 9-40. Single Power LED Supply

The resistor at SS/TR sets the FB voltage to a level of approximately 300 mV and is calculated from 式 15.

$$V_{FB} = 0.64 \cdot 2.5\mu\text{A} \cdot R_{SS/TR} \quad (15)$$

The device now supplies a constant current, set by the resistor at the FB pin, by regulating the output voltage accordingly. The minimum input voltage has to be rated according the forward voltage needed by the LED used. More information is available in the [Step-Down LED Driver With Dimming With the TPS621-Family and TPS821-Family Application Report](#).

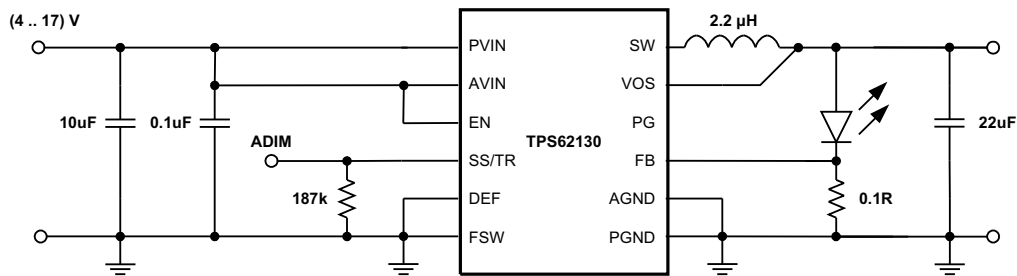
9.3.2 Active Output Discharge

The TPS62130A pulls the PG pin Low when the device is shut down by EN, UVLO, or thermal shutdown. Connecting PG to V_{OUT} through a resistor can be used to discharge V_{OUT} in those cases (see 图 9-41). The discharge rate can be adjusted by R3, which is also used to pull up the PG pin in normal operation. For reliability, keep the maximum current into the PG pin less than 10 mA.



图 9-41. Discharge V_{OUT} Through PG Pin with TPS62130A

9.3.3 –3.3-V Inverting Power Supply

The TPS62130 can be used as an inverting power supply by rearranging external circuitry as shown in 图 9-42. As the former GND node now represents a voltage level below system ground, the voltage difference between V_{IN} and V_{OUT} has to be limited for operation to the maximum supply voltage of 17 V (see 式 16).

$$V_{IN} + |V_{OUT}| \leq V_{INmax} \quad (16)$$

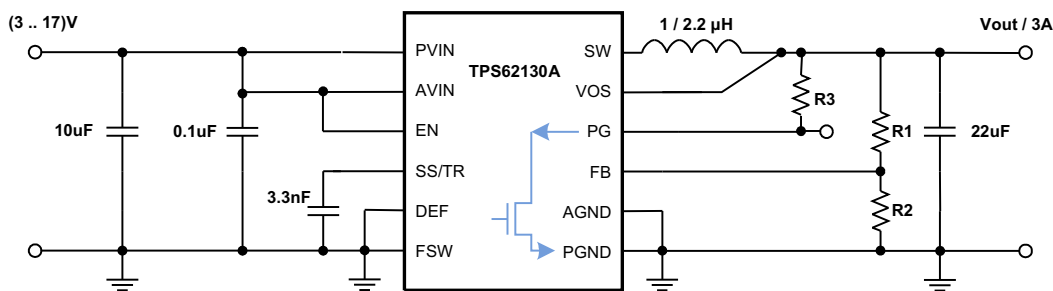
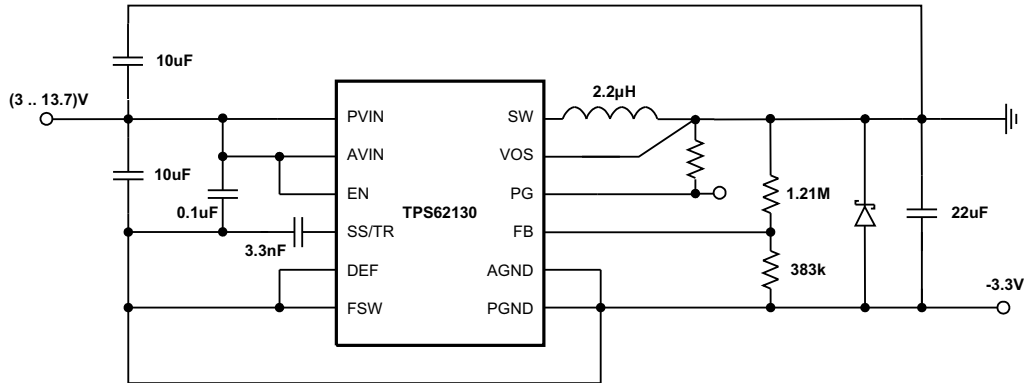

9-42. -3.3-V Inverting Power Supply

The transfer function of the inverting power supply configuration differs from the buck mode transfer function, incorporating a right half plane zero additionally. The loop stability has to be adapted and an output capacitance of at least 22 µF is recommended. A detailed design example is given in [Using the TPS6215x in an Inverting Buck-Boost Topology Application Report](#).

9.3.4 Various Output Voltages

The following example circuits show how to use the various devices and configure the external circuitry to furnish different output voltages at 3 A.

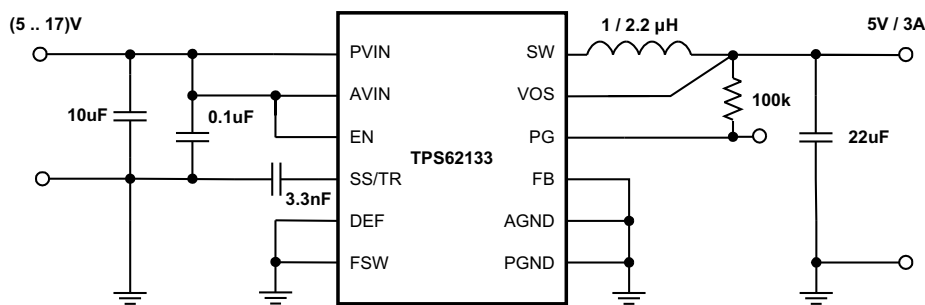

9-43. 5-V/3-A Power Supply

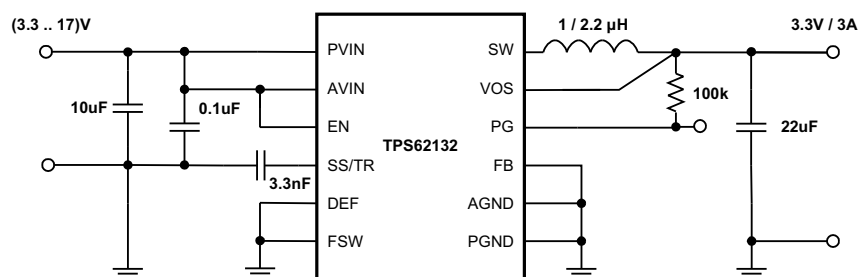

9-44. 3.3-V/3-A Power Supply

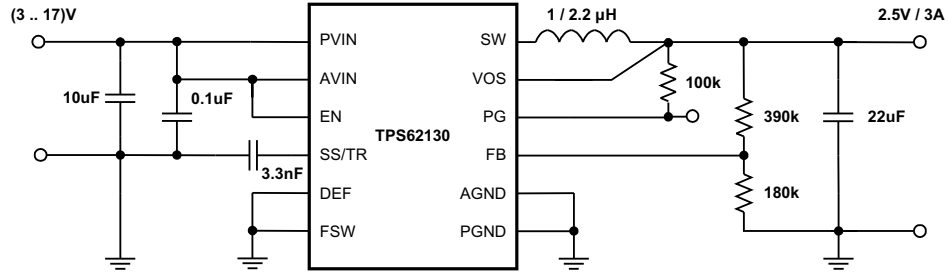

9-45. 2.5-V/3-A Power Supply

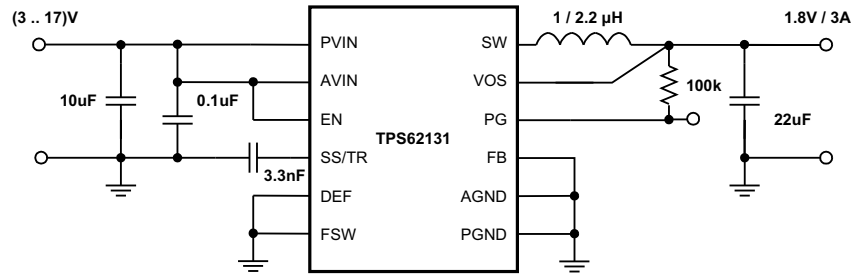

9-46. 1.8-V/3-A Power Supply

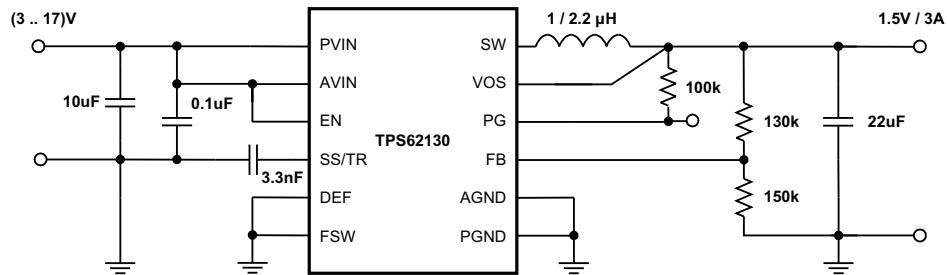

9-47. 1.5-V/3-A Power Supply

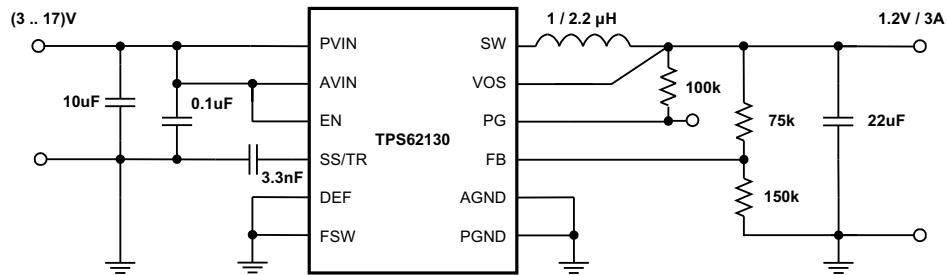

9-48. 1.2-V/3-A Power Supply

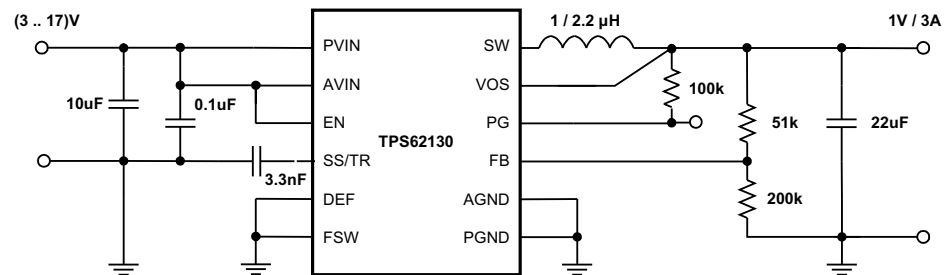

9-49. 1-V/3-A Power Supply

10 Power Supply Recommendations

The TPS6213x are designed to operate from a 3-V to 17-V input voltage supply. The output current of the input power supply needs to be rated according to the output voltage and the output current of the power rail application.

11 Layout

11.1 Layout Guidelines

A proper layout is critical for the operation of a switched mode power supply, even more at high switching frequencies. Therefore, the PCB layout of the TPS6213x demands careful attention to ensure operation and to get the performance specified. A poor layout can lead to issues like the following:

- Poor regulation (both line and load)
- Stability and accuracy weaknesses
- Increased EMI radiation
- Noise sensitivity

See [Figure 11-1](#) for the recommended layout of the TPS6213x, which is designed for common external ground connections. Therefore, both AGND and PGND pins are directly connected to the exposed thermal pad. On the PCB, the direct common ground connection of AGND and PGND to the exposed thermal pad and the system ground (ground plane) is mandatory. Also connect the VOS pin in the shortest way to V_{OUT} at the output capacitor. To avoid noise coupling into the VOS line, this connection should be separated from the V_{OUT} power line/plane as shown in [Section 11.2](#).

Provide low inductive and resistive paths for loops with high di/dt. Therefore, paths conducting the switched load current should be as short and wide as possible. Provide low capacitive paths (with respect to all other nodes) for wires with high dv/dt. Therefore, the input and output capacitance should be placed as close as possible to the IC pins and parallel wiring over long distances as well as narrow traces should be avoided. Loops which conduct an alternating current should outline an area as small as possible, as this area is proportional to the energy radiated.

Sensitive nodes like FB and VOS need to be connected with short wires and not nearby high dv/dt signals (for example, SW). As they carry information about the output voltage, they should be connected as close as possible to the actual output voltage (at the output capacitor). The capacitor on the SS/TR pin and on AVIN as well as the FB resistors, R1 and R2, should be kept close to the IC and connect directly to those pins and the system ground plane.

The exposed thermal pad must be soldered to the circuit board for mechanical reliability and to achieve appropriate power dissipation.

The recommended layout is implemented on the EVM and shown in the [TPS6213x Buck Converter Evaluation Module User's Guide](#). Additionally, the [Gebers for HPA505 EVM](#) are available for download.

11.2 Layout Example

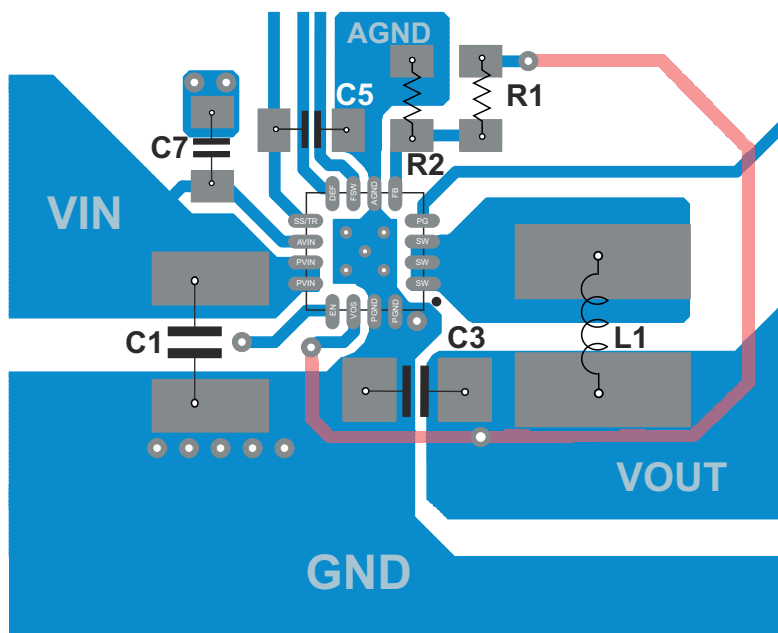

✎ 11-1. Layout Example

11.3 Thermal Information

Implementation of integrated circuits in low-profile and fine-pitch surface-mount packages typically requires special attention to power dissipation. Many system-dependent issues such as thermal coupling, airflow, added heat sinks and convection surfaces, and the presence of other heat-generating components affect the power-dissipation limits of a given component.

Three basic approaches for enhancing thermal performance are listed below:

- Improving the power dissipation capability of the PCB design
- Improving the thermal coupling of the component to the PCB by soldering the Exposed Thermal Pad
- Introducing airflow in the system

For more details on how to use the thermal parameters, see the application notes: [Thermal Characteristics of Linear and Logic Packages Using JEDEC PCB Designs Application Report](#) and [Semiconductor and IC Package Thermal Metrics Application Report](#).

The TPS6213x is designed for a maximum operating junction temperature (T_J) of 125°C. Therefore, the maximum output power is limited by the power losses that can be dissipated over the actual thermal resistance, given by the package and the surrounding PCB structures. Since the thermal resistance of the package is fixed, increasing the size of the surrounding copper area and improving the thermal connection to the IC can reduce the thermal resistance. To get an improved thermal behavior, it is recommended to use top layer metal to connect the device with wide and thick metal lines. Internal ground layers can connect to vias directly under the IC for improved thermal performance.

If short circuit or overload conditions are present, the device is protected by limiting internal power dissipation. Experimental data, taken from the TPS62130 EVM, shows the maximum ambient temperature (without additional cooling like airflow or heat sink), that can be allowed to limit the junction temperature to at most 125°C (see [✎ 9-38](#)).

12 Device and Documentation Support

12.1 Device Support

12.1.1 Third-Party Products Disclaimer

TI'S PUBLICATION OF INFORMATION REGARDING THIRD-PARTY PRODUCTS OR SERVICES DOES NOT CONSTITUTE AN ENDORSEMENT REGARDING THE SUITABILITY OF SUCH PRODUCTS OR SERVICES OR A WARRANTY, REPRESENTATION OR ENDORSEMENT OF SUCH PRODUCTS OR SERVICES, EITHER ALONE OR IN COMBINATION WITH ANY TI PRODUCT OR SERVICE.

12.2 Documentation Support

12.2.1 Related Documentation

- Texas Instruments, [Voltage Margining Using the TPS62130 Application Report](#)
- Texas Instruments, [Using the TPS62150 as Step-Down LED Driver With Dimming Application Report](#)
- Texas Instruments, [Using the TPS6215x in an Inverting Buck-Boost Topology Application Report](#)
- Texas Instruments, [Optimizing the TPS62130/40/50/60/70 Output Filter Application Report](#)
- Texas Instruments, [TPS62130/40/50 Sequencing and Tracking Application Report](#)
- Texas Instruments, [Optimizing Transient Response of Internally Compensated dc-dc Converters With Feedforward Capacitor Application Report](#)
- Texas Instruments, [Using a Feedforward Capacitor to Improve Stability and Bandwidth of TPS62130/40/50/60/70 Application Report](#)
- Texas Instruments, [Thermal Characteristics of Linear and Logic Packages Using JEDEC PCB Designs Application Report](#)
- Texas Instruments, [Semiconductor and IC Package Thermal Metrics Application Report](#)
- Texas Instruments, [TPS62130EVM-505, TPS62140EVM-505, and TPS62150EVM-505 Evaluation Modules User's Guide](#)
- Texas Instruments, [EVM Gerber Data](#)

12.3 Receiving Notification of Documentation Updates

To receive notification of documentation updates, navigate to the device product folder on [ti.com](#). Click on *Subscribe to updates* to register and receive a weekly digest of any product information that has changed. For change details, review the revision history included in any revised document.

12.4 サポート・リソース

TI E2E™ サポート・フォーラムは、エンジニアが検証済みの回答と設計に関するヒントをエキスパートから迅速かつ直接得ることができる場所です。既存の回答を検索したり、独自の質問をしたりすることで、設計に必要な支援を迅速に得ることができます。

リンクされているコンテンツは、該当する貢献者により、現状のまま提供されるものです。これらは TI の仕様を構成するものではなく、必ずしも TI の見解を反映したものではありません。TI の [使用条件](#)を参照してください。

12.5 Trademarks

DCS-Control™ and TI E2E™ are trademarks of Texas Instruments.

すべての商標は、それぞれの所有者に帰属します。

12.6 Electrostatic Discharge Caution



This integrated circuit can be damaged by ESD. Texas Instruments recommends that all integrated circuits be handled with appropriate precautions. Failure to observe proper handling and installation procedures can cause damage.

ESD damage can range from subtle performance degradation to complete device failure. Precision integrated circuits may be more susceptible to damage because very small parametric changes could cause the device not to meet its published specifications.

12.7 Glossary

[TI Glossary](#) This glossary lists and explains terms, acronyms, and definitions.

13 Mechanical, Packaging, and Orderable Information

The following pages include mechanical, packaging, and orderable information. This information is the most current data available for the designated devices. This data is subject to change without notice and revision of this document. For browser-based versions of this data sheet, refer to the left-hand navigation.

PACKAGING INFORMATION

| Orderable Device | Status (1) | Package Type | Package Drawing | Pins | Package Qty | Eco Plan (2) | Lead finish/ Ball material (6) | MSL Peak Temp (3) | Op Temp (°C) | Device Marking (4/5) | Samples |
|------------------|---------------|--------------|-----------------|------|-------------|-----------------|--------------------------------------|----------------------|--------------|-------------------------|-------------------------|
| TPS62130ARGTR | ACTIVE | VQFN | RGT | 16 | 3000 | RoHS & Green | NIPDAU | Level-2-260C-1 YEAR | -40 to 125 | PA6I | Samples |
| TPS62130ARGTT | ACTIVE | VQFN | RGT | 16 | 250 | RoHS & Green | NIPDAU | Level-2-260C-1 YEAR | -40 to 125 | PA6I | Samples |
| TPS62130RGTR | ACTIVE | VQFN | RGT | 16 | 3000 | RoHS & Green | NIPDAU | Level-2-260C-1 YEAR | -40 to 125 | PTSI | Samples |
| TPS62130RGTT | ACTIVE | VQFN | RGT | 16 | 250 | RoHS & Green | NIPDAU | Level-2-260C-1 YEAR | -40 to 125 | PTSI | Samples |
| TPS62131RGTR | ACTIVE | VQFN | RGT | 16 | 3000 | RoHS & Green | NIPDAU | Level-2-260C-1 YEAR | -40 to 125 | QVX | Samples |
| TPS62131RGTT | ACTIVE | VQFN | RGT | 16 | 250 | RoHS & Green | NIPDAU | Level-2-260C-1 YEAR | -40 to 125 | QVX | Samples |
| TPS62132RGTR | ACTIVE | VQFN | RGT | 16 | 3000 | RoHS & Green | NIPDAU | Level-2-260C-1 YEAR | -40 to 125 | QVY | Samples |
| TPS62132RGTT | ACTIVE | VQFN | RGT | 16 | 250 | RoHS & Green | NIPDAU | Level-2-260C-1 YEAR | -40 to 125 | QVY | Samples |
| TPS62133RGTR | ACTIVE | VQFN | RGT | 16 | 3000 | RoHS & Green | NIPDAU | Level-2-260C-1 YEAR | -40 to 125 | QVZ | Samples |
| TPS62133RGTT | ACTIVE | VQFN | RGT | 16 | 250 | RoHS & Green | NIPDAU | Level-2-260C-1 YEAR | -40 to 125 | QVZ | Samples |

(1) The marketing status values are defined as follows:

ACTIVE: Product device recommended for new designs.

LIFEBUY: TI has announced that the device will be discontinued, and a lifetime-buy period is in effect.

NRND: Not recommended for new designs. Device is in production to support existing customers, but TI does not recommend using this part in a new design.

PREVIEW: Device has been announced but is not in production. Samples may or may not be available.

OBSOLETE: TI has discontinued the production of the device.

(2) **RoHS:** TI defines "RoHS" to mean semiconductor products that are compliant with the current EU RoHS requirements for all 10 RoHS substances, including the requirement that RoHS substance do not exceed 0.1% by weight in homogeneous materials. Where designed to be soldered at high temperatures, "RoHS" products are suitable for use in specified lead-free processes. TI may reference these types of products as "Pb-Free".

RoHS Exempt: TI defines "RoHS Exempt" to mean products that contain lead but are compliant with EU RoHS pursuant to a specific EU RoHS exemption.

Green: TI defines "Green" to mean the content of Chlorine (Cl) and Bromine (Br) based flame retardants meet JS709B low halogen requirements of <=1000ppm threshold. Antimony trioxide based flame retardants must also meet the <=1000ppm threshold requirement.

(3) MSL, Peak Temp. - The Moisture Sensitivity Level rating according to the JEDEC industry standard classifications, and peak solder temperature.

(4) There may be additional marking, which relates to the logo, the lot trace code information, or the environmental category on the device.

⁽⁵⁾ Multiple Device Markings will be inside parentheses. Only one Device Marking contained in parentheses and separated by a "~" will appear on a device. If a line is indented then it is a continuation of the previous line and the two combined represent the entire Device Marking for that device.

⁽⁶⁾ Lead finish/Ball material - Orderable Devices may have multiple material finish options. Finish options are separated by a vertical ruled line. Lead finish/Ball material values may wrap to two lines if the finish value exceeds the maximum column width.

Important Information and Disclaimer:The information provided on this page represents TI's knowledge and belief as of the date that it is provided. TI bases its knowledge and belief on information provided by third parties, and makes no representation or warranty as to the accuracy of such information. Efforts are underway to better integrate information from third parties. TI has taken and continues to take reasonable steps to provide representative and accurate information but may not have conducted destructive testing or chemical analysis on incoming materials and chemicals. TI and TI suppliers consider certain information to be proprietary, and thus CAS numbers and other limited information may not be available for release.

In no event shall TI's liability arising out of such information exceed the total purchase price of the TI part(s) at issue in this document sold by TI to Customer on an annual basis.

OTHER QUALIFIED VERSIONS OF TPS62130A :

- Automotive : [TPS62130A-Q1](#)

NOTE: Qualified Version Definitions:

- Automotive - Q100 devices qualified for high-reliability automotive applications targeting zero defects

TAPE AND REEL INFORMATION



QUADRANT ASSIGNMENTS FOR PIN 1 ORIENTATION IN TAPE



*All dimensions are nominal

| Device | Package Type | Package Drawing | Pins | SPQ | Reel Diameter (mm) | Reel Width W1 (mm) | A0 (mm) | B0 (mm) | K0 (mm) | P1 (mm) | W (mm) | Pin1 Quadrant |
|---------------|--------------|-----------------|------|------|--------------------|--------------------|---------|---------|---------|---------|--------|---------------|
| TPS62130ARGTR | VQFN | RGT | 16 | 3000 | 330.0 | 12.4 | 3.3 | 3.3 | 1.1 | 8.0 | 12.0 | Q2 |
| TPS62130ARGTT | VQFN | RGT | 16 | 250 | 180.0 | 12.4 | 3.3 | 3.3 | 1.1 | 8.0 | 12.0 | Q2 |
| TPS62130RGTR | VQFN | RGT | 16 | 3000 | 330.0 | 12.4 | 3.3 | 3.3 | 1.1 | 8.0 | 12.0 | Q2 |
| TPS62130RGTT | VQFN | RGT | 16 | 250 | 180.0 | 12.4 | 3.3 | 3.3 | 1.1 | 8.0 | 12.0 | Q2 |
| TPS62131RGTR | VQFN | RGT | 16 | 3000 | 330.0 | 12.4 | 3.3 | 3.3 | 1.1 | 8.0 | 12.0 | Q2 |
| TPS62131RGTT | VQFN | RGT | 16 | 250 | 180.0 | 12.4 | 3.3 | 3.3 | 1.1 | 8.0 | 12.0 | Q2 |
| TPS62131RGTT | VQFN | RGT | 16 | 250 | 180.0 | 12.4 | 3.3 | 3.3 | 1.1 | 8.0 | 12.0 | Q2 |
| TPS62132RGTR | VQFN | RGT | 16 | 3000 | 330.0 | 12.4 | 3.3 | 3.3 | 1.1 | 8.0 | 12.0 | Q2 |
| TPS62132RGTR | VQFN | RGT | 16 | 3000 | 330.0 | 12.4 | 3.3 | 3.3 | 1.1 | 8.0 | 12.0 | Q2 |
| TPS62132RGTT | VQFN | RGT | 16 | 250 | 180.0 | 12.4 | 3.3 | 3.3 | 1.1 | 8.0 | 12.0 | Q2 |
| TPS62132RGTT | VQFN | RGT | 16 | 250 | 180.0 | 12.4 | 3.3 | 3.3 | 1.1 | 8.0 | 12.0 | Q2 |
| TPS62133RGTR | VQFN | RGT | 16 | 3000 | 330.0 | 12.4 | 3.3 | 3.3 | 1.1 | 8.0 | 12.0 | Q2 |
| TPS62133RGTT | VQFN | RGT | 16 | 250 | 180.0 | 12.4 | 3.3 | 3.3 | 1.1 | 8.0 | 12.0 | Q2 |
| TPS62133RGTT | VQFN | RGT | 16 | 250 | 180.0 | 12.4 | 3.3 | 3.3 | 1.1 | 8.0 | 12.0 | Q2 |

TAPE AND REEL BOX DIMENSIONS

*All dimensions are nominal

| Device | Package Type | Package Drawing | Pins | SPQ | Length (mm) | Width (mm) | Height (mm) |
|---------------|--------------|-----------------|------|------|-------------|------------|-------------|
| TPS62130ARGTR | VQFN | RGT | 16 | 3000 | 552.0 | 346.0 | 36.0 |
| TPS62130ARGTT | VQFN | RGT | 16 | 250 | 552.0 | 185.0 | 36.0 |
| TPS62130RGTR | VQFN | RGT | 16 | 3000 | 552.0 | 346.0 | 36.0 |
| TPS62130RGTT | VQFN | RGT | 16 | 250 | 552.0 | 185.0 | 36.0 |
| TPS62131RGTR | VQFN | RGT | 16 | 3000 | 552.0 | 346.0 | 36.0 |
| TPS62131RGTT | VQFN | RGT | 16 | 250 | 552.0 | 185.0 | 36.0 |
| TPS62131RGTT | VQFN | RGT | 16 | 250 | 210.0 | 185.0 | 35.0 |
| TPS62132RGTR | VQFN | RGT | 16 | 3000 | 367.0 | 367.0 | 35.0 |
| TPS62132RGTR | VQFN | RGT | 16 | 3000 | 552.0 | 346.0 | 36.0 |
| TPS62132RGTT | VQFN | RGT | 16 | 250 | 552.0 | 185.0 | 36.0 |
| TPS62132RGTT | VQFN | RGT | 16 | 250 | 210.0 | 185.0 | 35.0 |
| TPS62133RGTR | VQFN | RGT | 16 | 3000 | 552.0 | 346.0 | 36.0 |
| TPS62133RGTT | VQFN | RGT | 16 | 250 | 552.0 | 185.0 | 36.0 |
| TPS62133RGTT | VQFN | RGT | 16 | 250 | 210.0 | 185.0 | 35.0 |

TUBE

*All dimensions are nominal

| Device | Package Name | Package Type | Pins | SPQ | L (mm) | W (mm) | T (μm) | B (mm) |
|---------------|--------------|--------------|------|------|--------|--------|--------|--------|
| TPS62130ARGTR | RGT | VQFN | 16 | 3000 | 381 | 4.83 | 2286 | 0 |
| TPS62130ARGTT | RGT | VQFN | 16 | 250 | 381 | 4.83 | 2286 | 0 |
| TPS62130RGTR | RGT | VQFN | 16 | 3000 | 381 | 4.83 | 2286 | 0 |
| TPS62130RGTT | RGT | VQFN | 16 | 250 | 381 | 4.83 | 2286 | 0 |
| TPS62131RGTR | RGT | VQFN | 16 | 3000 | 381 | 4.83 | 2286 | 0 |
| TPS62131RGTT | RGT | VQFN | 16 | 250 | 381 | 4.83 | 2286 | 0 |
| TPS62132RGTR | RGT | VQFN | 16 | 3000 | 381 | 4.83 | 2286 | 0 |
| TPS62132RGTT | RGT | VQFN | 16 | 250 | 381 | 4.83 | 2286 | 0 |
| TPS62133RGTR | RGT | VQFN | 16 | 3000 | 381 | 4.83 | 2286 | 0 |
| TPS62133RGTT | RGT | VQFN | 16 | 250 | 381 | 4.83 | 2286 | 0 |

RGT 16

GENERIC PACKAGE VIEW

VQFN - 1 mm max height

PLASTIC QUAD FLATPACK - NO LEAD



Images above are just a representation of the package family, actual package may vary.
Refer to the product data sheet for package details.

4203495/1



| SIDE WALL METAL THICKNESS DIM A | |
|---------------------------------|----------|
| OPTION 1 | OPTION 2 |
| 0.1 | 0.2 |



4222419/D 04/2022

NOTES:

1. All linear dimensions are in millimeters. Any dimensions in parenthesis are for reference only. Dimensioning and tolerancing per ASME Y14.5M.
2. This drawing is subject to change without notice.
3. The package thermal pad must be soldered to the printed circuit board for thermal and mechanical performance.

EXAMPLE BOARD LAYOUT

RGT0016C

VQFN - 1 mm max height

PLASTIC QUAD FLATPACK - NO LEAD

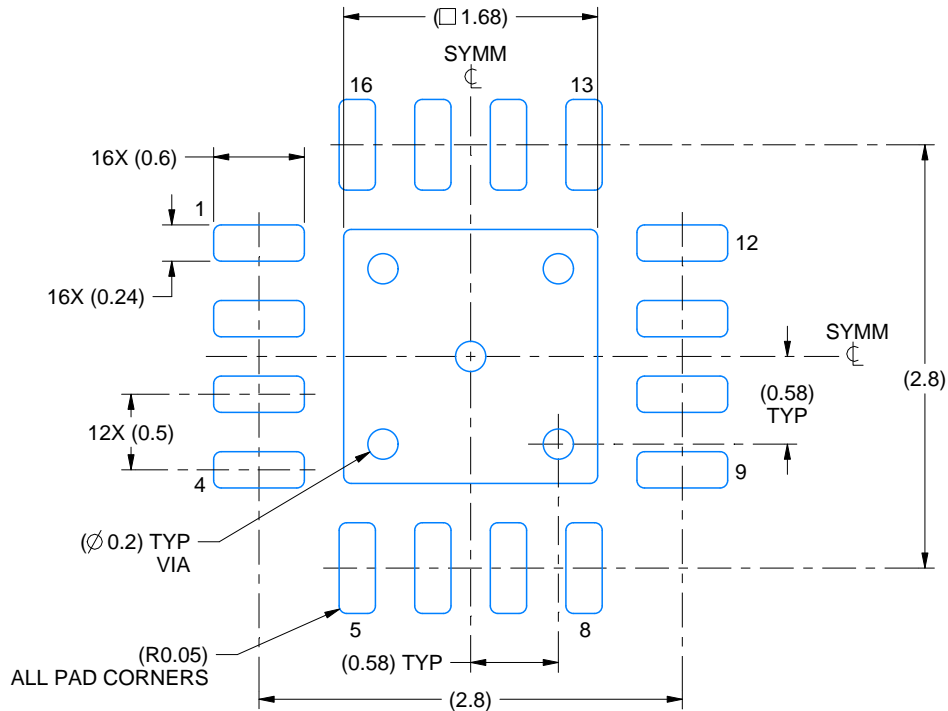

LAND PATTERN EXAMPLE
EXPOSED METAL SHOWN
SCALE:20X

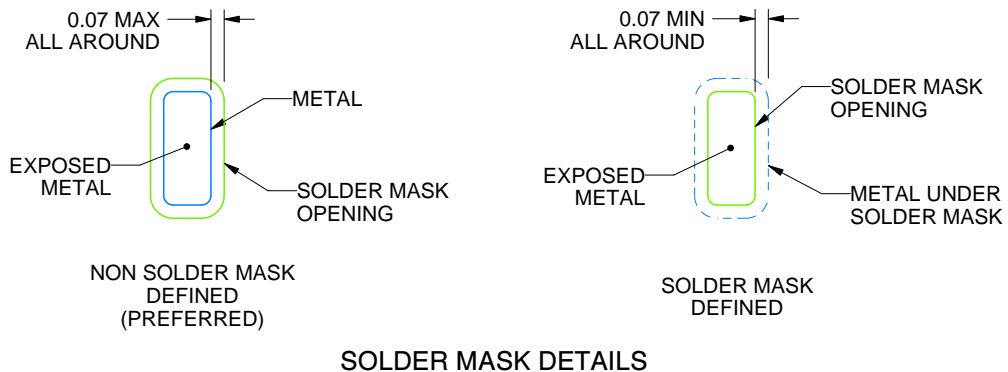

SOLDER MASK DETAILS

4222419/D 04/2022

NOTES: (continued)

4. This package is designed to be soldered to a thermal pad on the board. For more information, see Texas Instruments literature number SLUA271 (www.ti.com/lit/slua271).
5. Vias are optional depending on application, refer to device data sheet. If any vias are implemented, refer to their locations shown on this view. It is recommended that vias under paste be filled, plugged or tented.

EXAMPLE STENCIL DESIGN

RGT0016C

VQFN - 1 mm max height

PLASTIC QUAD FLATPACK - NO LEAD



SOLDER PASTE EXAMPLE
BASED ON 0.125 mm THICK STENCIL

EXPOSED PAD 17:
85% PRINTED SOLDER COVERAGE BY AREA UNDER PACKAGE
SCALE:25X

4222419/D 04/2022

NOTES: (continued)

6. Laser cutting apertures with trapezoidal walls and rounded corners may offer better paste release. IPC-7525 may have alternate design recommendations.

重要なお知らせと免責事項

TI は、技術データと信頼性データ（データシートを含みます）、設計リソース（リファレンス・デザインを含みます）、アプリケーションや設計に関する各種アドバイス、Web ツール、安全性情報、その他のリソースを、欠陥が存在する可能性のある「現状のまま」提供しており、商品性および特定目的に対する適合性の黙示保証、第三者の知的財産権の非侵害保証を含むいかなる保証も、明示的または黙示的にかかわらず拒否します。

これらのリソースは、TI 製品を使用する設計の経験を積んだ開発者への提供を意図したものです。(1) お客様のアプリケーションに適した TI 製品の選定、(2) お客様のアプリケーションの設計、検証、試験、(3) お客様のアプリケーションに該当する各種規格や、その他のあらゆる安全性、セキュリティ、規制、または他の要件への確実な適合に関する責任を、お客様のみが単独で負うものとし、

上記の各種リソースは、予告なく変更される可能性があります。これらのリソースは、リソースで説明されている TI 製品を使用するアプリケーションの開発の目的でのみ、TI はその使用をお客様に許諾します。これらのリソースに関して、他の目的で複製することや掲載することは禁止されています。TI や第三者の知的財産権のライセンスが付与されている訳ではありません。お客様は、これらのリソースを自身で使用した結果発生するあらゆる申し立て、損害、費用、損失、責任について、TI およびその代理人を完全に補償するものとし、TI は一切の責任を拒否します。

TI の製品は、[TI の販売条件](#)、または [ti.com](#) やかかる TI 製品の関連資料などのいずれかを通じて提供する適用可能な条項の下で提供されています。TI がこれらのリソースを提供することは、適用される TI の保証または他の保証の放棄の拡大や変更を意味するものではありません。

お客様がいかなる追加条項または代替条項を提案した場合でも、TI はそれらに異議を唱え、拒否します。

郵送先住所：Texas Instruments, Post Office Box 655303, Dallas, Texas 75265
Copyright © 2024, Texas Instruments Incorporated