

TPS62480 2.4-V to 5.5-V, 6-A, 2-Phase Step-Down Converter

1 Features

- Dual Phase Current Mode Topology
- Input Voltage Range 2.4 to 5.5 V
- Output Voltage Range 0.6 to 5.5 V
- Output Current of 6 A
- Typical Quiescent Current of 23 μ A
- Feedback Voltage Accuracy of $\pm 1\%$ (PWM Mode)
- Output Voltage Select
- Phase Shifted Operation
- Automatic Power Save Modes
- Forced PWM Mode
- Adjustable Soft Start
- Power Good / Thermal Good Outputs
- Undervoltage Lockout
- Overcurrent and Short-Circuit Protection
- Overtemperature Protection
- 3 \times 2.5 mm HotRod™ Package

2 Applications

- Low Profile Point-of-Load Supply
- Solid State Drives
- Ultra Portable/Tablet/Embedded PC
- Optical Modules, CMOS Cameras
- Wireless Modules, Network Cards

3 Description

The TPS62480 is a synchronous 2-phase step-down DC-DC converter for low profile point-of-load power supplies. The input voltage range of 2.4 to 5.5 V enables operation from typical 3.3-V or 5-V interface supplies as well as from backup circuits dropping down as low as 2.4 V. The output current is up to 6 A continuously provided by two phases of 3 A each, allowing the use of low-profile external components. Both the rails are running out of phase, reducing pulse current noise significantly.

The TPS62480 provides an automatically entered power save mode to maintain high efficiency down to very light loads. This incorporates an automatic phase adding and shedding feature using both or only one phase according to the actual load.

The device features a Power Good signal and an adjustable soft start. Also, the device features a Thermal Good signal to detect excessive internal temperature. The output voltage can be changed to a preselected value by VSEL pin. TPS62480 is able to operate in 100% duty cycle mode.

The TPS62480 is packaged in a small 3 \times 2.5 mm HotRod™ package (RNC).

Device Information⁽¹⁾

PART NUMBER	PACKAGE	BODY SIZE (NOM)
TPS62480	VQFN (16)	3.00 \times 2.50 mm

(1) For all available packages, see the orderable addendum at the end of the data sheet.

Typical Application Schematic

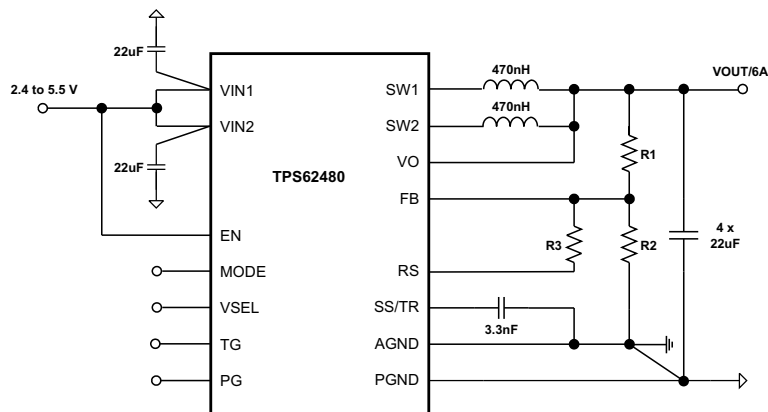

Efficiency vs Output Current

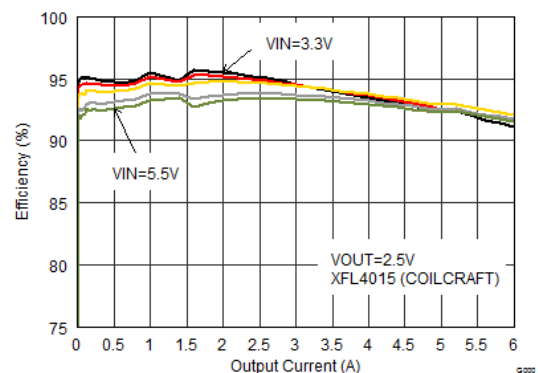

Table of Contents

1 Features	1	7.4 Device Functional Modes.....	10
2 Applications	1	8 Application and Implementation	12
3 Description	1	8.1 Application Information.....	12
4 Revision History	2	8.2 Typical Application	12
5 Pin Configuration and Functions	3	8.3 System Examples	25
6 Specifications	4	9 Power Supply Recommendations	26
6.1 Absolute Maximum Ratings	4	10 Layout	27
6.2 ESD Ratings	4	10.1 Layout Guidelines	27
6.3 Recommended Operating Conditions.....	4	10.2 Layout Example	27
6.4 Thermal Information	4	11 Device and Documentation Support	28
6.5 Electrical Characteristics.....	5	11.1 Third-Party Products Disclaimer	28
6.6 Typical Characteristics.....	7	11.2 Community Resources.....	28
7 Detailed Description	8	11.3 Trademarks	28
7.1 Overview	8	11.4 Electrostatic Discharge Caution.....	28
7.2 Functional Block Diagram	8	11.5 Glossary	28
7.3 Feature Description.....	9	12 Mechanical, Packaging, and Orderable Information	28

4 Revision History

Changes from Original (February 2016) to Revision A	Page
• Changed RCN Package To: RNC Package in Pin Configuration and Functions	3
• Changed RCN 16 PINS To: RNC 16 PINS in the Thermal Information table.....	4
• Changed the Test Conditions for I _{SD} Shutdown Current From: EN = Low (≤ 0.4 V) To: EN = Low (≤ 0.3 V) in the Electrical Characteristics	5
• Changed the V _{OUT} Feedback Voltage Accuracy, MAX value From: 25% To: 2.5% in the Electrical Characteristics	6
• Changed TPS62480RCN To: TPS62480RNC in Table 1	13

5 Pin Configuration and Functions

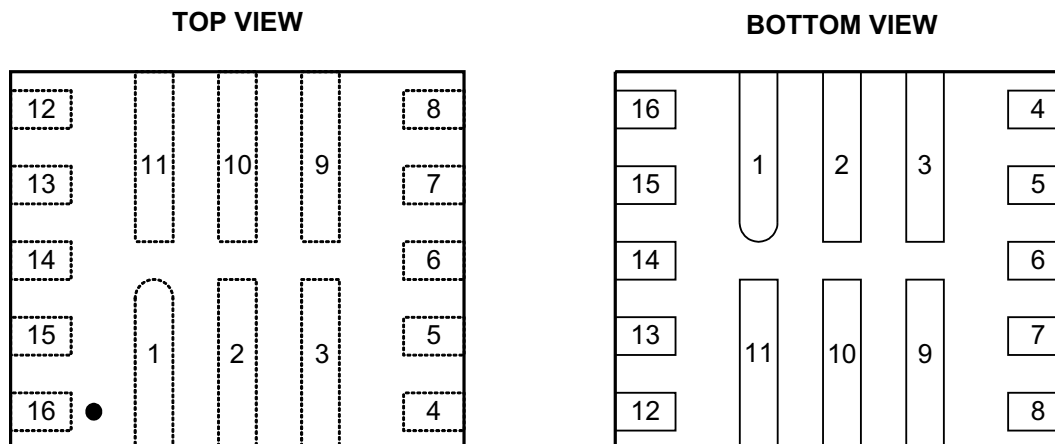
**RNC Package
16-Pin (VQFN)**

Pin Functions

PIN		I/O	DESCRIPTION
NAME	NO.		
PGND1	1		Power Ground Phase 1 (master)
SW1	2		Switch Node Phase 1 (master) , connected to the internal MOSFET switches
VIN1	3		Supply voltage Phase 1 (master)
EN	4	I	Enable input (High=Enabled, Low = Disabled)
PG	5	O	Power Good (open drain, requires pull-up resistor)
VSEL	6	I	Output Voltage Select (High = VOUT2, Low=VOUT1) , VOUT1 < VOUT2
TG	7	O	Thermal Good (open drain, requires pull-up resistor)
MODE	8	I	Operating mode selection (Low=Automatic PWM/PSM, High = Forced PWM)
VIN2	9		Supply voltage Phase 2
SW2	10		Switch node Phase 2, connected to the internal MOSFET switches
PGND2	11		Power Ground Phase 2
SS/TR	12	O	Soft-Start / Tracking. An external capacitor connected to this pin sets the output voltage rise time.
AGND	13		Analog Ground
FB	14		Output voltage feedback for the adjustable version. Connect resistive voltage divider to this pin.
RS	15		Resistor Select. Connect resistor that sets the level for the second output voltage here (activated by VSEL= High)
VO	16		VOUT detection (connect to VOUT, output discharge is internally connected to this pin)

6 Specifications

6.1 Absolute Maximum Ratings

over operating free-air temperature range (unless otherwise noted) ⁽¹⁾

		MIN	MAX	UNIT
Pin Voltage Range ⁽²⁾	VIN	-0.3	6	V
	SW1, SW2	-0.3	V _{IN} +0.3	V
	EN, VSEL, MODE, SS/TR, PG, TG	-0.3	6	V
	FB, RS	-0.3	3	V
Power Good / Thermal Good Sink Current	PG, TG		10	mA
Operating Junction Temperature Range, T _J		-40	150	°C
Storage Temperature Range, T _{stg}		-65	150	°C

- (1) Stresses beyond those listed under *Absolute Maximum Ratings* may cause permanent damage to the device. These are stress ratings only, which do not imply functional operation of the device at these or any other conditions beyond those indicated under *Recommended Operating Conditions*. Exposure to absolute-maximum-rated conditions for extended periods may affect device reliability.
- (2) All voltages are with respect to network ground terminal.

6.2 ESD Ratings

			VALUE	UNIT
V _(ESD)	Electrostatic discharge	Human body model (HBM), per ANSI/ESDA/JEDEC JS-001, all pins ⁽¹⁾	±1000	V
		Charged device model (CDM), per JEDEC specification JESD22-C101, all pins ⁽²⁾	±500	

- (1) JEDEC document JEP155 states that 500-V HBM allows safe manufacturing with a standard ESD control process.
- (2) JEDEC document JEP157 states that 250-V CDM allows safe manufacturing with a standard ESD control process.

6.3 Recommended Operating Conditions

over operating junction temperature range (unless otherwise noted)

	MIN	TYP	MAX	UNIT
Supply Voltage Range, V _{IN}	2.4		5.5	V
Output Voltage Range, V _{OUT}	0.6		5.5	V
Maximum Output Current, I _{OUT}	6			A
Operating junction temperature, T _J	-40		125	°C

6.4 Thermal Information

THERMAL METRIC ⁽¹⁾		TPS62480		UNIT
		RNC 16 PINS		
		JEDEC with thermal vias ⁽²⁾	JEDEC standard	
R _{θJA}	Junction-to-ambient thermal resistance	26.4	56.4	°C/W
R _{θJC(top)}	Junction-to-case (top) thermal resistance	32.2	32.2	°C/W
R _{θJB}	Junction-to-board thermal resistance	10.2	26.5	°C/W
ψ _{JT}	Junction-to-top characterization parameter	0.9	1.3	°C/W
ψ _{JB}	Junction-to-board characterization parameter	10.2	26.5	°C/W
R _{θJC(bot)}	Junction-to-case (bottom) thermal resistance	-	-	°C/W

- (1) For more information about traditional and new thermal metrics, see the *IC Package Thermal Metrics* application report, [SPRA953](#).
- (2) See the *Layout* section.

6.5 Electrical Characteristics

over operating junction temperature range ($T_J = -40^\circ\text{C}$ to 125°C) and $V_{IN} = 2.4\text{ V}$ to 5.5 V . Typical values at $V_{IN} = 3.6\text{ V}$ and $T_J = 25^\circ\text{C}$ (unless otherwise noted).

PARAMETER		TEST CONDITIONS	MIN	TYP	MAX	UNIT	
SUPPLY							
V_{IN}	Input Voltage Range	V_{IN} rising	2.6		5.5	V	
		V_{IN} falling	2.4		5.5		
I_Q	Operating Quiescent Current	EN = High, $V_{IN} \geq 3\text{ V}$, $I_{OUT} = 0\text{ mA}$, device not switching, $T_J = -40^\circ\text{C}$ to $+85^\circ\text{C}$		23	38	μA	
		100% Mode operation		3.5	6.5	mA	
I_{SD}	Shutdown Current	EN = Low ($\leq 0.3\text{ V}$), $T_J = -40^\circ\text{C}$ to $+85^\circ\text{C}$		0.5	18.5	μA	
V_{UVLO}	Undervoltage Lockout Threshold	Falling Input Voltage	2.2	2.3	2.4	V	
		Hysteresis		200		mV	
T_{SD}	Thermal Shutdown Temperature	PWM Mode, Rising Junction Temperature		160		$^\circ\text{C}$	
	Thermal Shutdown Hysteresis	PWM Mode		10			
CONTROL (EN, VSEL, MODE, SS/TR, PG, TG)							
V_H	Input Threshold Voltage (EN, VSEL, MODE)	to ensure High Level	1.2			V	
V_L	Input Threshold Voltage (EN, VSEL, MODE)	to ensure Low Level			0.4		
$I_{LKG(EN)}$	Input Leakage Current (EN)	EN = V_{IN} or GND		10	200	nA	
$I_{LKG(MODE)}$	Input Leakage Current (MODE, VSEL)			10	200	nA	
$I_{SS/TR}$	SS/TR pin source current		4.7	5.25	5.8	μA	
$V_{TH(TG)}$	Thermal Good Threshold Temperature	PWM Mode		120		$^\circ\text{C}$	
	Thermal Good Hysteresis	PWM Mode		10			
$V_{TH(PG)}$	Power Good Threshold Voltage	Rising ($\%V_{OUT}$)	93%	96%	99%		
		Falling ($\%V_{OUT}$)	89%	92%	95%		
$V_{L(PG)}$	Output Low Threshold (PG, TG)	$I_{PG} = -2\text{ mA}$			0.4	V	
$I_{LKG(PG)}$	Input Leakage Current (PG)			2	700	nA	
$I_{LKG(TG)}$	Input Leakage Current (TG)			2	100	nA	
t_{SS}	Internal Soft-Start Time	SS/TR = V_{IN} or floating		80		μs	
t_{DELAY}	Time from EN rising until start switching		100	200	400	μs	
POWER SWITCH							
$R_{DS(ON)}$	High-Side MOSFET ON-Resistance	$V_{IN} \geq 3\text{ V}$	Phase1		36	98	$\text{m}\Omega$
			Phase2				
	Low-Side MOSFET ON-Resistance		Phase1		29	72	$\text{m}\Omega$
			Phase2				
I_{LIM}	High-Side MOSFET Current Limit	per phase	4.3	5.0	5.8	A	

Electrical Characteristics (continued)

over operating junction temperature range ($T_J = -40^\circ\text{C}$ to 125°C) and $V_{IN} = 2.4\text{ V}$ to 5.5 V . Typical values at $V_{IN} = 3.6\text{ V}$ and $T_J = 25^\circ\text{C}$ (unless otherwise noted).

PARAMETER		TEST CONDITIONS		MIN	TYP	MAX	UNIT
OUTPUT							
V_{REF}	Internal Reference Voltage			0.6			V
$I_{LKG(FB)}$	Input Leakage Current (FB)	EN = High	$V_{FB} = 0.6\text{ V}$	1	65		nA
$I_{LKG(RS)}$	Input Leakage Current (RS)		VSEL = Low, $V_{RS} = 0.6\text{ V}$	1	65		nA
R_{RS}	Internal resistance (RS to GND)		VSEL = High, $I_{RS} = 1\text{ mA}$	10	50		Ω
V_{OUT}	Output Voltage Range	$V_{IN} \geq V_{OUT}$		0.6		5.5	V
V_{OUT}	Feedback Voltage Accuracy	PWM Mode, $V_{IN} \geq V_{OUT} + 1\text{ V}$	$T_J = -20^\circ\text{C}$ to 85°C	-1%		1%	
			$T_J = -40^\circ\text{C}$ to 125°C	-1.4%		1.3%	
V_{OUT}	Feedback Voltage Accuracy	Power Save Mode, $L = 0.47\text{ }\mu\text{H}$, $C_{OUT} = 4 \times 22\text{ }\mu\text{F}^{(1)}$		-1.4%		2.5%	
	Output Discharge Current ⁽²⁾	EN = Low, $V_{OUT} = 2.5\text{ V}$			120		mA
	Load Regulation	$V_{OUT} = 1.8\text{ V}$, PWM mode operation			0.02		%/A
	Line Regulation	$2.6\text{ V} \leq V_{IN} \leq 5.5\text{ V}$, $V_{OUT} = 1.8\text{ V}$, $I_{OUT} = 6\text{ A}$, PWM mode operation			0.02		%/V

- (1) The output voltage accuracy in Power Save Mode can be improved by increasing the output capacitor value, reducing the output voltage ripple.
- (2) For detailed information on output discharge see [Active Output Discharge](#).

6.6 Typical Characteristics

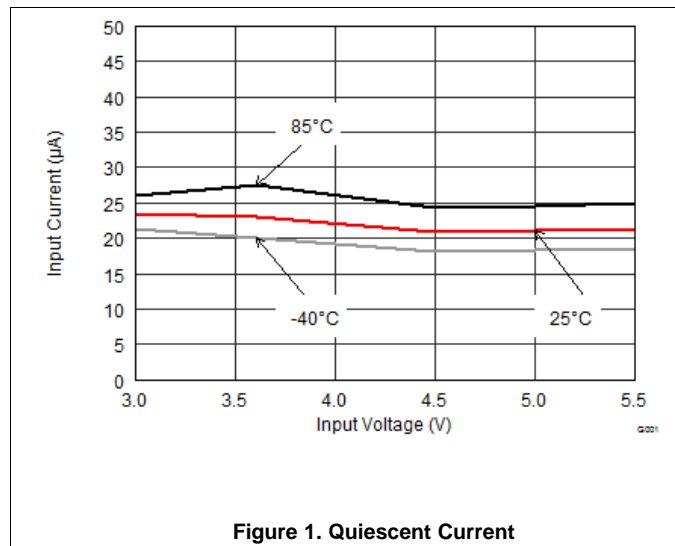

Figure 1. Quiescent Current

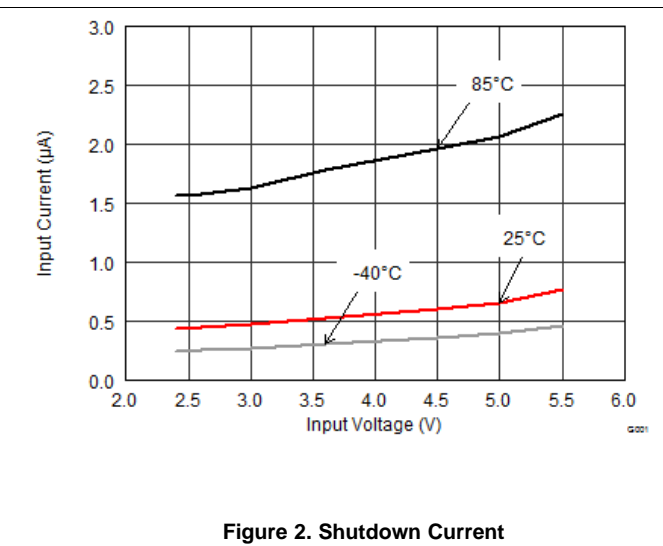

Figure 2. Shutdown Current

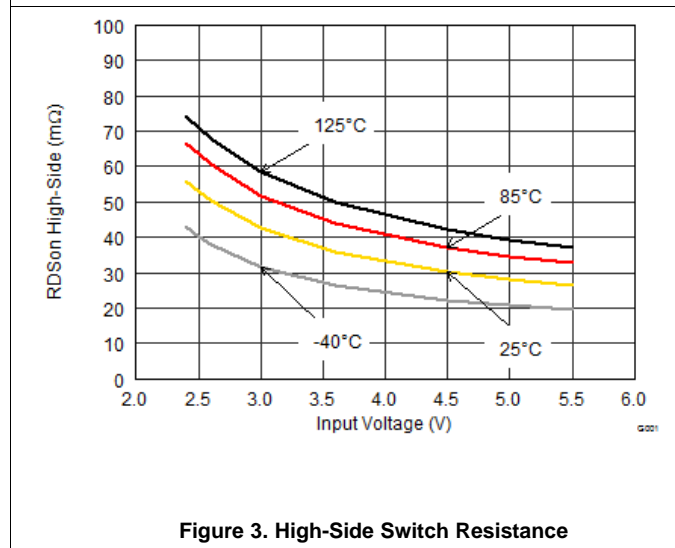

Figure 3. High-Side Switch Resistance

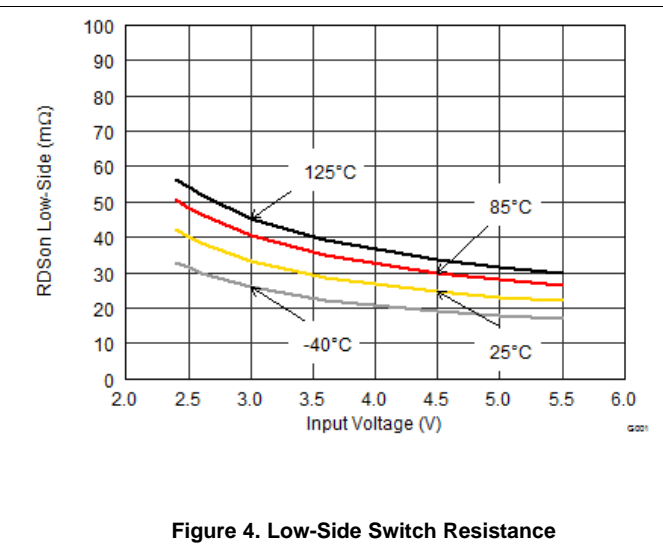

Figure 4. Low-Side Switch Resistance

7 Detailed Description

7.1 Overview

The TPS62480 is a high efficiency synchronous switched mode step-down converter based on a 2-phase peak current control topology. It is designed for smallest solution size low-profile applications, converting a 2.4 V to 5.5 V input voltage into a lower 0.6 V to 5.5 V output voltage. While an outer voltage loop sets the regulation threshold for the inner current loop, based on the actual V_{OUT} level, the inner current loop regulates to the actual peak inductor current level for every switching cycle. The regulation network is internally compensated. While the ON-time is determined by duty cycle, inductance and cycle peak current, the switching frequency of typically 2.2 MHz is set by a predicted OFF-time. The device features a Power Save Mode (PSM) to keep the conversion efficiency high over the whole load current range.

The TPS62480 is a 2-phase converter, sharing the load among the phases. Identical in construction, the second phase control is connected with an adaptive delay to the first phase. Both the phases use the same regulation threshold and cycle-by-cycle peak current setpoint. This ensures a phase-shifted as well as current-balanced operation. Using the advantages of the 2-phase topology, a 6-A continuous output current is provided with high performance and as small as possible solution size.

7.2 Functional Block Diagram

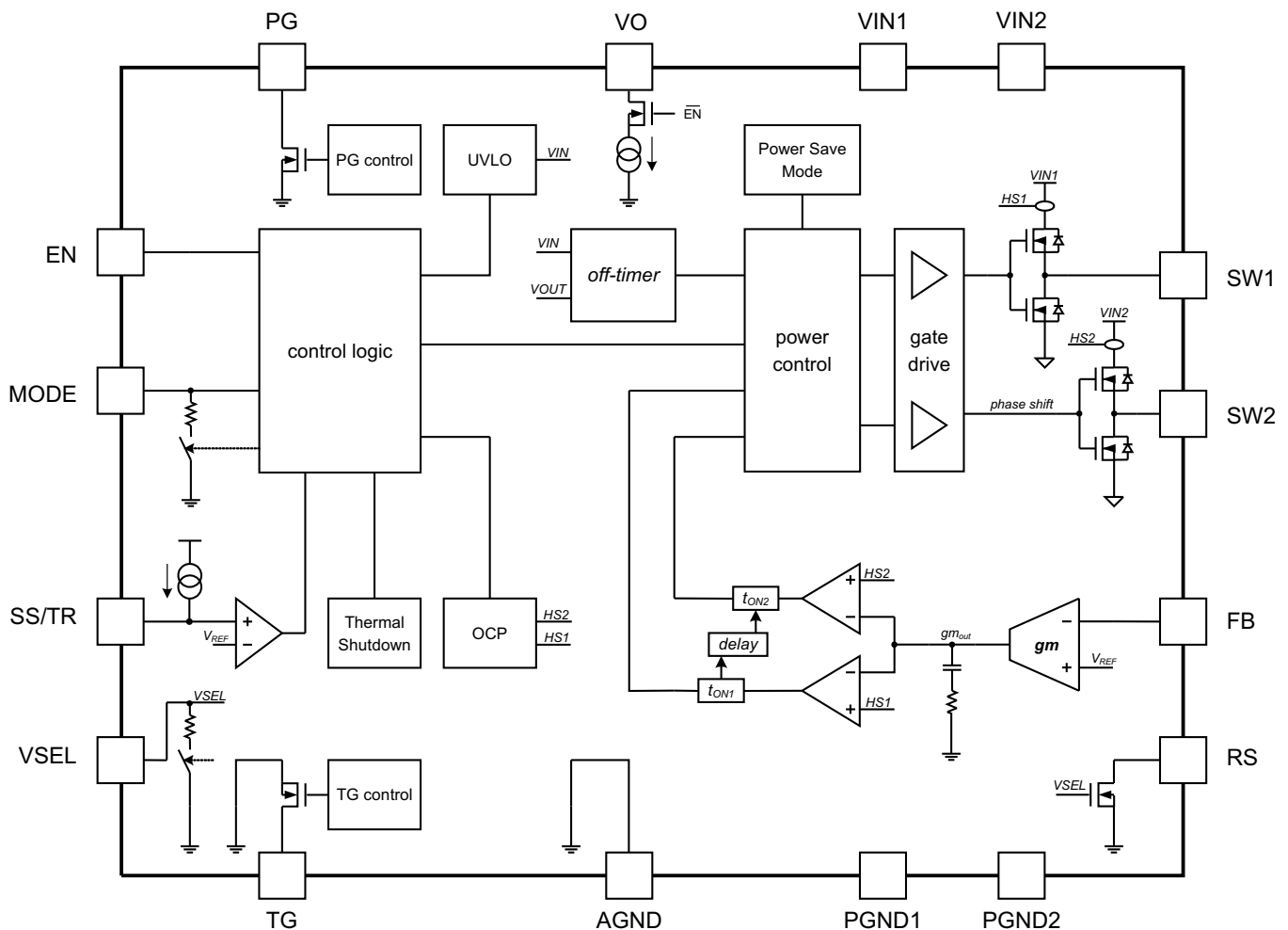

Figure 5. TPS62480 (Adjustable Output Voltage)

7.3 Feature Description

7.3.1 Enable / Shutdown (EN)

The device starts operation, when VIN is present and enable (EN) is set High. Since the boundary EN thresholds are specified with 1.2 V for rising and 0.4 V for falling voltages, the typical values are 0.85 V (rising) and 0.65 V (falling). The device is disabled by pulling EN Low. Leaving the EN pin floating is not recommended.

7.3.2 Soft Start (SS), Pre-biased Output

The internal soft start circuit controls the output voltage slope during startup. This avoids excessive inrush current and provides an adjustable controlled output-voltage rise time. The soft start also prevents unwanted voltage drop from high impedance power sources or batteries.

When EN is set to start device operation, the device starts switching after a delay of typically 200 μ s and VOUT rises with a slope, controlled by the external capacitor which is connected to the SS/TR pin (soft start). Leaving the SS/TR pin floating or connecting to VIN provides internally set fastest startup with a soft start slope of about 80us. See [Application Curves](#) for typical startup operation.

The device can start into a pre-biased output. In this case, the device starts switching, only when the internal set point for VOUT increases above the pre-biased voltage level.

7.3.3 Tracking (TR)

The device tracks an external voltage applied to the SS/TR pin. The FB voltage tracks the external voltage as long as it is below about 0.6V. Above 0.6V the device goes to normal operation. If the voltage at the SS/TR pin decreases below about 0.6V, the FB voltage tracks again this voltage. See [Tracking](#) for further details.

7.3.4 Output Voltage Select (VSEL)

A resistive divider (VOUT to FB to AGND) sets the output voltage of the TPS62480. Providing a logic High level at the VSEL pin, another resistor, connected between FB and RS pins is connected in parallel to the lower resistor of the divider. This sets a different higher output voltage and can be used for dynamic voltage scaling (see [Setting V_{OUT2} Using the VSEL Feature](#)).

If the VSEL pin is set Low, the device connects an internal pull down resistor to keep the internal logic level Low, even if the pin is floating afterwards. The device disconnects the resistor, if the pin is set to High.

7.3.5 Forced PWM (MODE)

To avoid [Power Save Mode \(PSM\) Operation](#), the device can be forced to PWM mode operation by pulling the MODE pin High. In this case the device operates continuously with its nominal switching frequency and the minimum peak current can go as low as -500 mA.

If the MODE pin is set Low, the device connects an internal pull down resistor to keep the internal logic level Low, even if the pin is floating afterwards. The device disconnects the resistor, if the pin is set to High.

7.3.6 Power Good (PG)

The TPS62480 has a built in power good function. The PG pin goes High, when the output voltage has reached its nominal value. Otherwise, including when disabled, in UVLO or thermal shutdown, PG is Low. The PG pin is an open drain output that requires a pull-up resistor and can sink typically 2mA. If not used, the PG pin can be left floating or grounded.

7.3.7 Thermal Good (TG)

As long as the junction temperature of the TPS62480 is below the thermal good temperature of typically 120°C, the logic level at the TG pin is High. If the junction temperature exceeds that temperature, the TG pin goes Low. This can be used for the system to take action preventing excessive heating or even thermal shutdown. The TG pin is an open drain output that requires a pull-up resistor and can sink typically 2mA. If not used, the TG pin can be left floating or grounded.

Feature Description (continued)

7.3.8 Active Output Discharge

The VO pin, connected to the output voltage, provides an active discharge path when the device is switched off by setting EN Low or UVLO event. In case of being activated, this discharge circuit sinks typically 120mA for output voltages of typically 1 V and above. If V_{OUT} is lower, the active current sink enters linear operation mode and the discharge current decreases.

7.3.9 Undervoltage Lockout (UVLO)

The undervoltage lockout prevents misoperation of the device, if the input voltage drops below the UVLO threshold which is set to typically 2.3 V. The converter starts operation again once the input voltage exceeds the threshold by a hysteresis of typically 200 mV.

7.3.10 Thermal Shutdown

The junction temperature (T_J) of the device is monitored by an internal temperature sensor. If T_J exceeds 160°C (typical), the device goes in thermal shutdown with a hysteresis of about 10°C. Both the power FETs are turned off and the PG pin goes Low. Once T_J has decreased enough, the device resumes normal operation with Soft Start.

7.4 Device Functional Modes

7.4.1 Pulse Width Modulation (PWM) Operation

The TPS62480 is based on a predictive OFF-time peak current control topology, operating with PWM in continuous conduction mode for heavier loads. The switching frequency is typically 2.2MHz. Both the master and follower phase regulate to the same VOUT level, each with a separate current loop, using the same peak current set point, cycle by cycle. This provides excellent peak current balancing, independent of inductor dc resistance matching. Since the follower phase operates with an adaptive delay to the master phase, phase shifted operation is always obtained. If the load current decreases, the device runs with the master phase only (see [Phase Add/Shed and Current Balancing](#)).

PWM only mode can be forced by pulling MODE pin High. If MODE is set Low, the device features an automatic transition into Power Save Mode, entered at light loads, running in discontinuous conduction mode (DCM).

7.4.2 Power Save Mode (PSM) Operation

As the load current decreases to half the ripple current, the converter enters Power Save Mode operation. During PSM, the converter operates with reduced switching frequency maintaining high conversion efficiency. Power Save Mode is based on an adaptive peak current target, to keep output voltage ripple low. Since each pulse shifts V_{OUT} up, a pause time happens until V_{OUT} trips the internal V_{OUT_Low} threshold again and the next pulse takes place.

The switching frequency in PSM (one phase operation) calculates as:

$$f_{SW(PSM)} = \frac{2 \cdot I_{OUT} \cdot V_{OUT} (V_{IN} - V_{OUT})}{L \cdot I_{PEAK}^2 \cdot V_{IN}} \quad (1)$$

Device Functional Modes (continued)

7.4.3 Minimum Duty Cycle and 100% Mode Operation

The minimum on-time, which is typically 70ns, normally determines a limit on the minimum operating duty cycle. The calculation is:

$$DC_{\min} = 70\text{ns} \cdot 100\% \cdot f_{\text{SW}} [\text{Hz}] \quad (2)$$

However, a frequency foldback lowers the switching frequency depending on the duty cycle and ensures proper regulation for every duty cycle.

There is no limit towards maximum duty cycle. When the input voltage becomes close to the output voltage, the device enters automatically 100% duty cycle mode and both high-side FETs switch on as long as V_{OUT} remains below the regulation setpoint. In this case, the voltage drop across the high-side FETs and the inductors determines the output voltage level. An estimate for the minimum input voltage to maintain output voltage regulation is:

$$V_{\text{IN}(\min)} = V_{\text{OUT}(\min)} + I_{\text{OUT}} \left[\frac{R_{\text{DS(ON)}}}{2} + \text{DCR}_{\text{L1}} // \text{DCR}_{\text{L2}} \right] \quad (3)$$

In 100% duty cycle mode, the low-side FETs are switched off. The typical quiescent current in 100% mode is 3.5 mA.

7.4.4 Phase Shifted Operation

Using an inherent benefit of the two-phase conversion, the two phases of TPS6248X run out of phase. For every switching cycle, the second phase is not allowed to turn on its high-side FET until the master phase has reached its peak current value. This limits the input RMS current and corresponding switching noise.

7.4.5 Phase Add/Shed and Current Balancing

When the load current is below the internal threshold, only the master phase operates. The second phase activates, if the load current exceeds the threshold of typically 1.7 A. The second phase powers off with a hysteresis of about 0.5 A, when the load current decreases.

Since the internal circuitry and layout matches both phase circuits, the peak currents balance with less than 15% deviation at heavy loads. This is independent of the inductor's tolerance. However, the maximum peak current, specified as High-Side MOSFET Current Limit in [Electrical Characteristics](#) is not exceeded at any time. A detailed example about current balancing is given in [Figure 28](#).

7.4.6 Current Limit and Short Circuit Protection

Each phase has a separate integrated peak current limit. The dc values are specified in the [Electrical Characteristics](#). While its minimum value limits the output current of the phase, the maximum number gives the current that must be considered to flow in some operating case. At the peak current limit, the device provides its maximum output current.

However, if the current limit situation remains for 512 consecutive switching cycles, the peak current folds back to about 1/3 of the regular limit. This limits the output power for over current and short circuit events. The foldback current limit is released to the normal one only if the load current has decreased as far as needed to undercut the (foldback) peak current limit.

8 Application and Implementation

NOTE

Information in the following applications sections is not part of the TI component specification, and TI does not warrant its accuracy or completeness. TI's customers are responsible for determining suitability of components for their purposes. Customers should validate and test their design implementation to confirm system functionality.

8.1 Application Information

The TPS62480 is a switched mode step-down converter, able to convert a 2.4-V to 5.5-V input voltage into a lower 0.6-V to 5.5-V output voltage, providing up to 6 A continuous output current. It needs a minimum amount of external components. Apart from the LC output filter and the input capacitors, additional resistors or capacitors are only needed to enable features like soft start, adjustable and selectable output voltage as well as Power Good and/or Thermal Good.

8.2 Typical Application

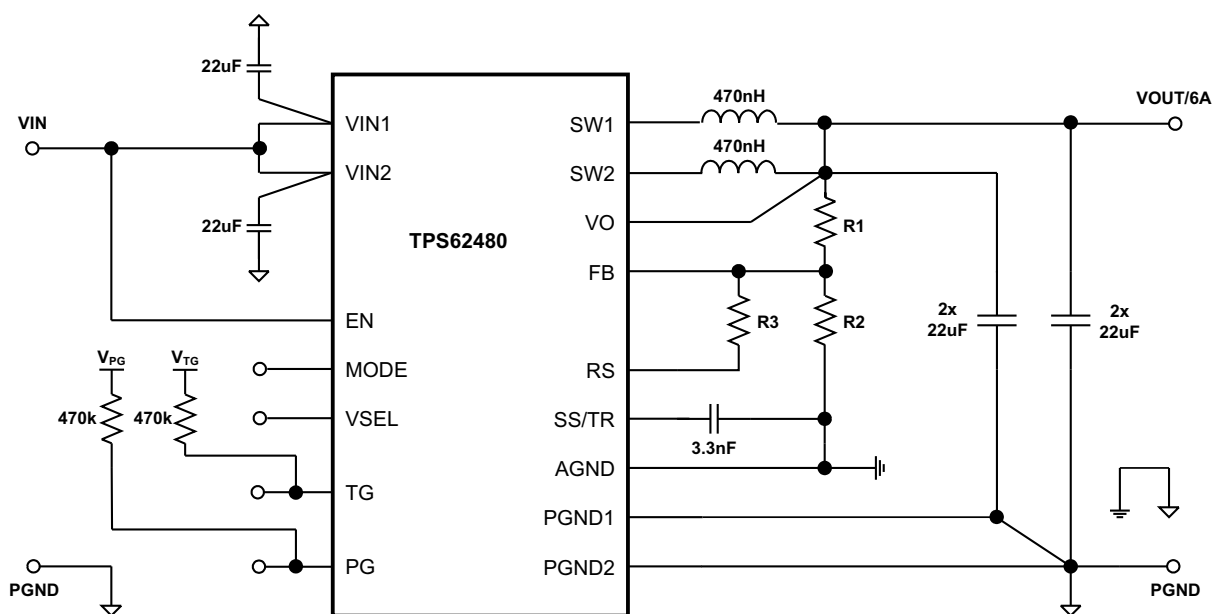

Figure 6. Typical Application using TPS62480 for a 6A Point-Of-Load Power Supply

8.2.1 Design Requirements

The following design guideline provides a range for the component selection to operate within the recommended operating conditions. [Table 1](#) shows the components selection that was used for the measurements shown in the [Application Curves](#).

Typical Application (continued)

Table 1. List of Components

REFERENCE	DESCRIPTION	MANUFACTURER
IC	5.5-V, 6-A step-down converter, QFN	TPS62480RNC, Texas Instruments
L	2x0.47-μH ±20%, (2.5x2x1.2) mm	DFE252012P-R47M, Toko
Cin	2x22-μF, 10-V, ceramic, 0603, X5R	GRM188R61A226ME15#, muRata
Cout	4x22-μF, 25-V, ceramic, 0805, X5R	GRM21BR61E226ME44L, muRata
Css	3300-pF, 10-V, ceramic, 0402	Standard
R1	Depending on Vout1, chip, 0402, 0.1%	Standard
R2	Depending on Vout1, chip, 0402, 0.1%	Standard
R3	Depending on Vout2, chip, 0402, 0.1%	Standard
R4, R5	470-kΩ, chip, 0603, 1/16-W, 1%	Standard

8.2.2 Detailed Design Procedure

8.2.2.1 Setting the Adjustable Output Voltage

While the device regulates the FB voltage to 0.6V, the output voltage is specified from 0.6 to 5.5 V. A resistive divider (from VOUT to FB to AGND) sets the actual output voltage of the TPS62480. [Equation 4](#) and [Equation 5](#) are calculating the values of the resistors. First, determining the current through the resistive divider leads to the total resistance ($R_1 + R_2$). A minimum divider current of about 5 μA is recommended and can be higher if needed.

$$R_1 + R_2 = \frac{V_{OUT}}{I_{FB}} \quad (4)$$

$$R_2 = \frac{V_{REF}}{V_{OUT}} (R_1 + R_2) \quad (5)$$

8.2.2.2 Setting V_{OUT2} Using the VSEL Feature

A V_{OUT} level, different as set with R_1 and R_2 (see [Setting the Adjustable Output Voltage](#)), can be forced by connecting R_3 between FB and RS pins and pulling VSEL High. R_3 is calculated using [Equation 6](#).

$$R_3 = \frac{V_1 \cdot R_1 \cdot R_2^2}{(V_2 - V_1) \cdot (R_1 \cdot R_2 + R_2^2)} \quad \text{for } (V_2 > V_1) \quad (6)$$

where:

V_1 is the lower level output voltage and

V_2 the higher level output voltage.

8.2.2.3 Output Filter Selection

The TPS62480 is internally compensated and optimized to work for a certain range of L-C combinations. The recommended minimum output capacitance is 4 x 22 μF, that can be ceramic capacitors exclusively. A larger value of C_{OUT} might be needed for $V_{OUT} \leq 1.8V$, to improve transient response performance, as well as for $V_{OUT} > 3.3 V$ to compensate for voltage bias effects of the ceramic capacitors. The other way round, using of an additional feed forward capacitor can help reducing amount of output capacitance that is needed to achieve a certain transient response target (see [Output Capacitor Selection](#)).

8.2.2.4 Inductor Selection

The TPS62480 is designed to operate with two inductors of nominal 470 nH each. Inductors must be selected for adequate saturation current and for low dc resistance (DCR). The minimum inductor current rating $I_{L(\min)}$ that is needed under static load conditions calculates using [Equation 7](#) and [Equation 8](#). A current imbalance of 10% is incorporated.

$$I_{L(\min)} = I_{\text{PEAK}(\max)} = \frac{1.1 \cdot I_{\text{OUT}(\max)}}{2} + \frac{\Delta I_{L(\max)}}{2} \quad (7)$$

$$\Delta I_{L(\max)} = V_{\text{OUT}} \left(\frac{1 - \frac{V_{\text{OUT}}}{V_{\text{IN}}}}{L_{(\min)} \cdot f_{\text{SW}}} \right) \quad (8)$$

Choosing $V_{\text{IN}} = 2 V_{\text{OUT}}$, this calculation provides the minimum saturation current of the inductor needed. Additional margin is recommended to cover dynamic overshoot due to load transients. For low profile solutions, the physical inductor size and the power losses have to be traded off. Smallest solution size gives less efficiency and thermal performance due to larger DCR and/or core losses. The inductors shown in [Table 2](#) have been tested with the TPS62480:

Table 2. List of Inductors

TYPE	INDUCTANCE [μH]	CURRENT RATING MIN/TYP [A]		DCR MAX [mΩ]	DIMENSIONS (LxBxH) [mm]	MANUFACTURER
		ΔL/L = 30%	ΔT = 40K			
DFE201612E-R47M	0.47 ±20%	5.5/6.1	4.5/5.0	26	2.0 x 1.6 x 1.2	TOKO
DFE252012F-R47M	0.47 ±20%	6.7/7.4	4.9/5.8	22	2.5 x 2.0 x 1.2	TOKO
DFE252010F-R47M	0.47 ±20%	6.0/6.6	4.4/5.2	27	2.5 x 2.0 x 1.0	TOKO
HMLQ25201B-R47MSR-11	0.47 ±20%	5.6/6.2	4.2/4.7	28	2.5 x 2.0 x 1.2	CYNTEC
HMLQ20161T-R47MDR-11	0.47 ±20%	4.4/4.9	4.0/4.4	32	2.0 x 1.6 x 1.0	CYNTEC
GLCLMR4701A	0.47 ±20%	3.6/4.5	3.8/4.7	32	2.5 x 2.0 x 1.2	ALPS
GLCLKR4701A	0.47 ±20%	3.5/4.4	3.7/4.6	38	2.5 x 2.0 x 1.0	ALPS
XFL4015-471ME	0.47 ±20%	6.6	11.2	8.36	4.0 x 4.0 x 1.5	COILCRAFT

8.2.2.5 Output Capacitor Selection

The TPS62480 provides a wide output voltage range of 0.6 V to 5.5 V. While stability is a critical criteria for the output filter selection, the output capacitor value also determines transient response behavior, ripple and accuracy of V_{OUT} . The internal compensation is designed for an output capacitance range from about 50 μF to 150 μF effectively. Since ceramic capacitors are used preferably, this translates into nominal values of 4 x 22 μF to 4 x 47 μF and mainly depends on the output voltage. The following values are recommended:

Table 3. Recommended Output Capacitor Values (nominal)

	$V_{\text{OUT}} \leq 1.0\text{V}$	$1.0\text{V} \leq V_{\text{OUT}} \leq 3.3\text{V}$	$V_{\text{OUT}} \geq 3.3\text{V}$
2x22μF			
4x22μF		√	
4x47μF	√	√	√
6x47μF			

Beyond the recommendations in [Table 3](#), other values can be chosen and might be suitable depending on VOUT and actual effective capacitance. In such case, stability needs to be checked within the actual environment.

Even if the output capacitance is sufficient for stability, a different value might be desirable to improve the transient response behavior. [Table 4](#) can be used to determine capacitor values for specific transient response targets:

Table 4. Recommended Output Capacitor Values (nominal)

Output Voltage [V]	Load Step [A]	Output Capacitor Value ⁽¹⁾	Feedforward Capacitor ⁽¹⁾	Typical Transient Response Accuracy	
				±mV	±%
1.0	0 - 3	4 x 47µF	-	50	5
	3 - 6			50	5
1.8	0 - 3	4 x 22µF	36pF	50	3
	3 - 6			50	3
2.5	0 - 3	4 x 22µF	36pF	62	2.5
	3 - 6			50	2
3.3	0 - 3	4 x 47µF	36pF	100	3
	3 - 6			80	2.5

(1) The values in the table are nominal values. The effective capacitance can differ significantly, depending on package size, voltage rating and dielectric material.

The architecture of the TPS62480 allows the use of tiny ceramic output capacitors with low equivalent series resistance (ESR). These capacitors provide low output voltage ripple and are recommended. To keep its low resistance up to high frequencies and to get narrow capacitance variation with temperature, it is recommended to use X5R or X7R dielectrics. Using even higher values than demanded for stability and transient response has further advantages like smaller voltage ripple and tighter dc output accuracy in Power Save Mode.

8.2.2.6 Input Capacitor Selection

The input current of a buck converter is pulsating. Therefore, a low ESR input capacitor is required to prevent large voltage transients at the source but to provide peak currents to the device. The recommended value for most applications is 2 x 22 µF, split between the VIN1 and VIN2 inputs and placed as close as possible to these pins and PGND pins. If additional capacitance is needed, it can be added as bulk capacitance. To ensure proper operation, the effective capacitance at the VIN pins must not fall below 2 x 5 µF.

Low ESR multilayer ceramic capacitors are recommended for best filtering. Increasing with input voltage, the dc bias effect reduces the nominal capacitance value significantly. To decrease input ripple current further, larger values of input capacitors can be used.

8.2.2.7 Soft Start Capacitor Selection

The soft start ramp time can be set externally connecting a capacitor between the SS/TR and AGND pins. The capacitor value C_{SS} that is needed to get a specific rising time Δt_{SS} calculates as:

$$C_{SS} = \Delta t_{SS} \cdot \frac{5.25\mu A}{0.6V} \quad (9)$$

Since the device has an internal delay time Δt_{DELAY} from EN=High to start switching, the overall startup time is longer as shown in [Figure 7](#).

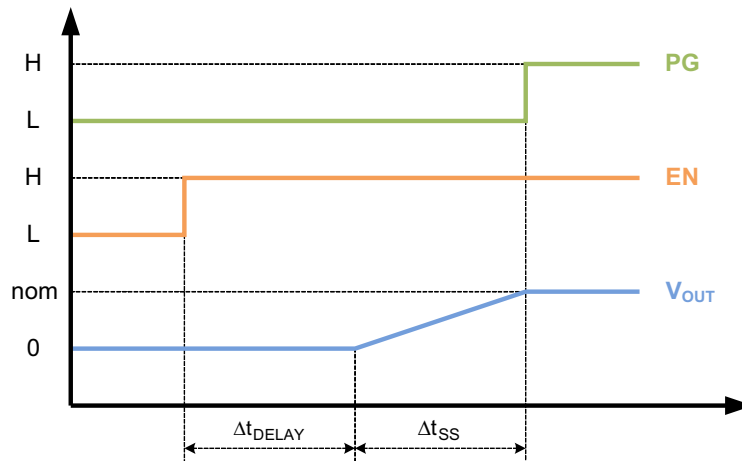

Figure 7. Soft Start Δt_{SS}

If very large output capacitances are used (e.g. $>4x47\mu F$), the use of a soft start capacitor is mandatory to secure complete startup.

8.2.2.8 Tracking

For values up to 0.6V, an external voltage, connected to the SS/TR pin, drives the voltage level at the FB pin. In doing so, the voltage at the FB pin is directly proportional to the voltage at the SS/TR pin.

When choosing the resistive divider proportion according to Equation 10, V_{OUT} tracks V_{TR} simultaneously.

$$\frac{R_1}{R_2} = \frac{R_3}{R_4} \tag{10}$$

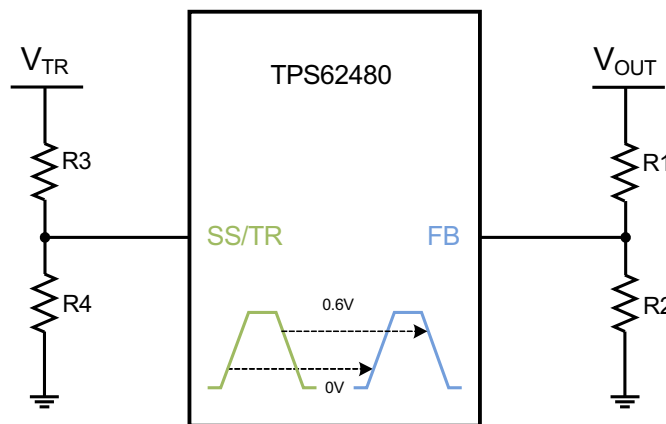

Figure 8. Voltage Tracking

Following the example of [Setting the Adjustable Output Voltage](#) with $V_{OUT} = 1.8\text{ V}$, $R_1 = 240\text{ k}\Omega$ and $R_2 = 120\text{ k}\Omega$, [Equation 11](#) and [Equation 12](#) calculate R_3 and R_4 , connected to the SS/TR pin. Different to the resistive divider at the FB pin, a larger current must be chosen, to avoid a tracking offset caused by the $5.25\text{ }\mu\text{A}$ current that flows out of the SS/TR pin. Assuming a $250\text{ }\mu\text{A}$ current, R_4 calculates as follows:

$$R_4 = \frac{0.6V}{250\mu A} = 2.4k\Omega \tag{11}$$

R₃ calculates now rearranging [Equation 10](#):

$$R_3 = R_4 \cdot \frac{R_1}{R_2} = 2.4k\Omega \cdot \frac{240k\Omega}{120k\Omega} = 4.8k\Omega \tag{12}$$

However, the following limitations can influence the tracking accuracy:

- The upper limit of the SS/TR voltage that can be tracked is about 0.6V. Since it is detected internally by a comparator, process variation and ramp speed can cause up to ±30 mV different threshold.
- In case that the voltage at SS/TR ramps up immediately when VIN is supplied or EN is set High, the internal startup delay, Δt_{DELAY}, delays the ramp of V_{OUT}. The internal ramp starts after Δt_{DELAY} at the voltage level, which is actually present at the SS/TR pin.
- The tracking down speed is limited by the RC time constant of the internal output discharge (always connected when tracking down) and the actual load with the output capacitance. Note: The device tracks down with the same behavior for MODE High (Forced PWM) or Low (Auto PSM).

8.2.2.9 Current Sharing

The TPS62480 is designed to share load current wisely between the 2 phases. The current imbalance is less than 15% over VIN and temperature range and independent on inductor mismatch.

However, the mismatch between the two inductors itself causes additional imbalance of the average inductor currents, caused by different ripple current. The mismatch can be calculated as shown in the following example, assuming that the nominal inductance of 470 nH can vary ±20%, the switching frequency is 2 MHz. Converting 5 V into 2.5 V gives a duty cycle of 0.5, which effects maximum ripple current. Since the ripple current is calculated with:

$$I_{ripple} = V_{OUT} \left(\frac{1 - \frac{V_{OUT}}{V_{IN}}}{f_{SW} \cdot L} \right) \tag{13}$$

the ripple currents in the two inductors are calculated with I_{ripple1} = 1.69 A and I_{ripple2} = 1.1 A which gives a ΔI_{ripple} of 0.59 A as worst case number based on the maximum inductor tolerance. [Figure 9](#) shows the relation of the two inductor currents in such case.

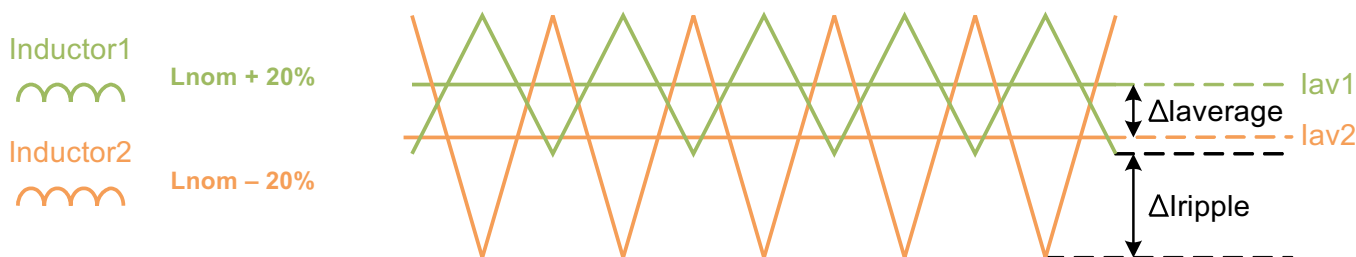

Figure 9. Inductor Currents

The difference in the average current is calculated using:

$$\Delta I_{av} = \frac{\Delta I_{ripple}}{2} \quad (14)$$

In this worst case calculation the average inductor current mismatch is 0.295A, less than 10% at the full load current of 3A per phase.

8.2.2.10 Thermal Good

The Thermal Good pin provides an open drain output. The logic level is given by the pull up source which can be VOUT. In this case, TG goes or stays Low, when the device switches off due to EN, UVLO or Thermal Shutdown.

When using an independent source for the pull up logic, the logic behavior at shutdown differs, because the TG pin internally goes high impedance. As before, TG goes Low when TG threshold is reached, but goes back High in the event of being switched off (e.g. Thermal Shutdown).

8.2.3 Application Curves

$V_{IN} = 3.6\text{ V}$, $V_{OUT} = 1.8\text{ V}$ ($R1 / R2 = 240\text{ k}\Omega / 120\text{ k}\Omega$), $T_A = 25^\circ\text{C}$, (unless otherwise noted)

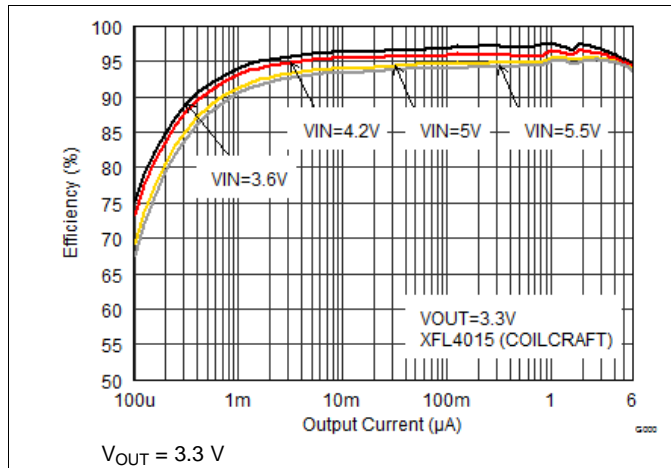

Figure 10. Efficiency vs Output Current

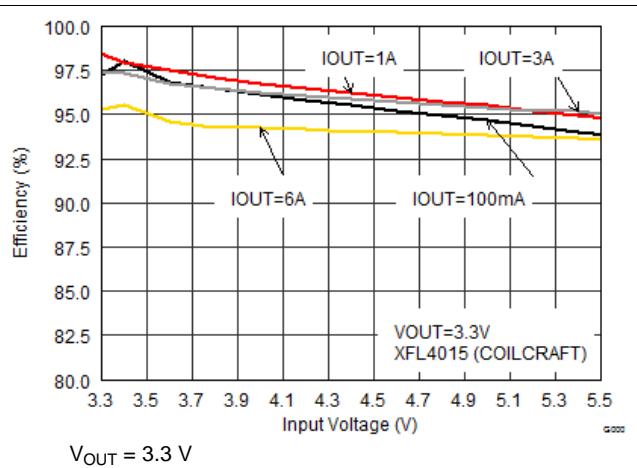

Figure 11. Efficiency vs Input Voltage

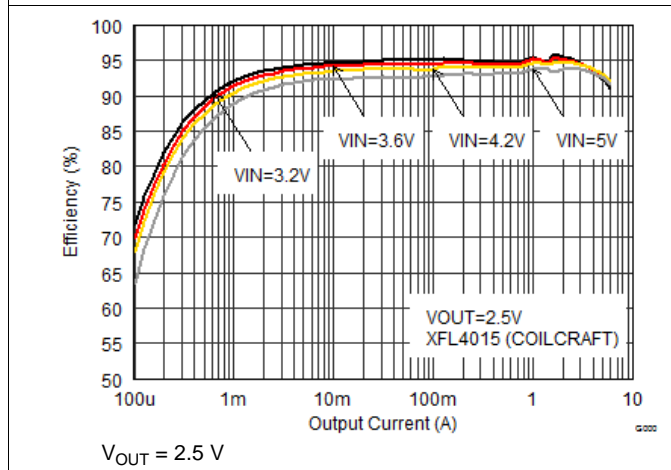

Figure 12. Efficiency vs Output Current

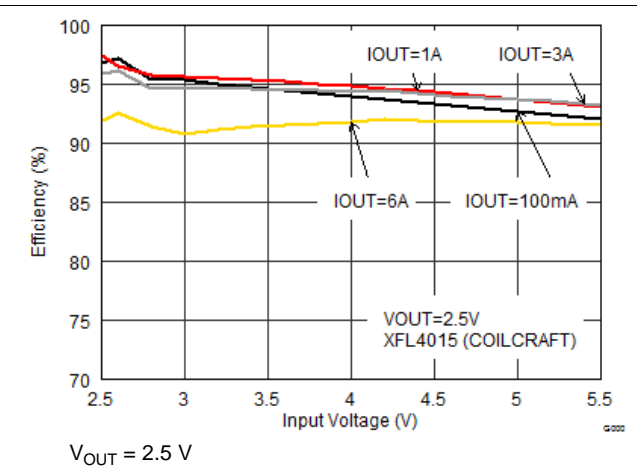

Figure 13. Efficiency vs Input Voltage

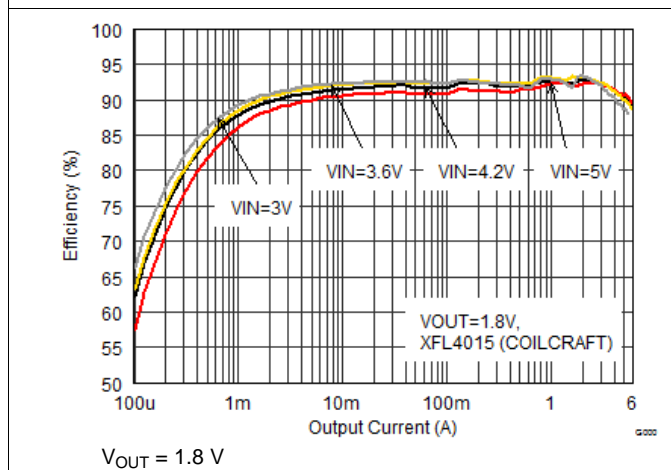

Figure 14. Efficiency vs Output Current

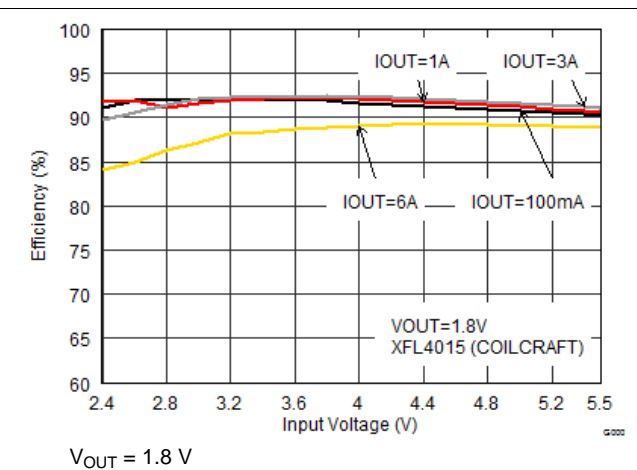

Figure 15. Efficiency vs Output Voltage

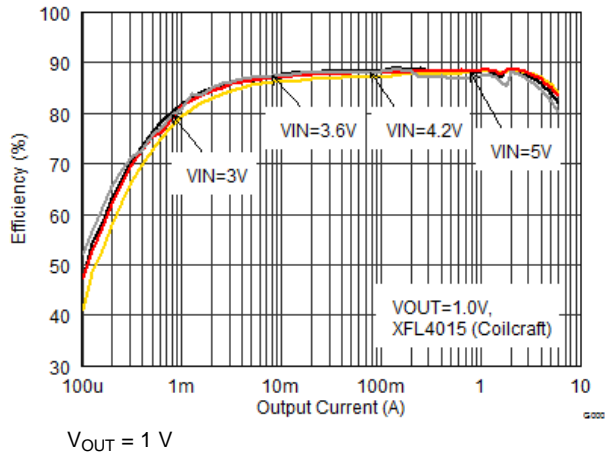

Figure 16. Efficiency vs Output Current

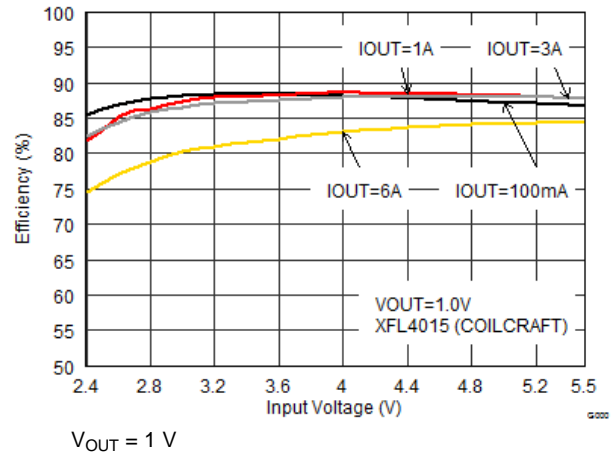

Figure 17. Efficiency vs Input Voltage

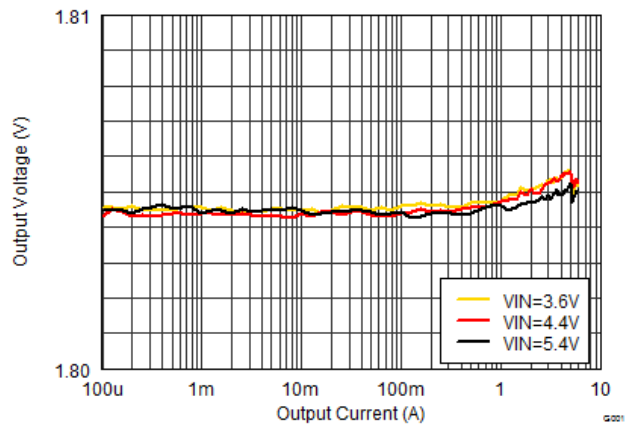

Figure 18. Output Voltage vs Output Current (Load Regulation)

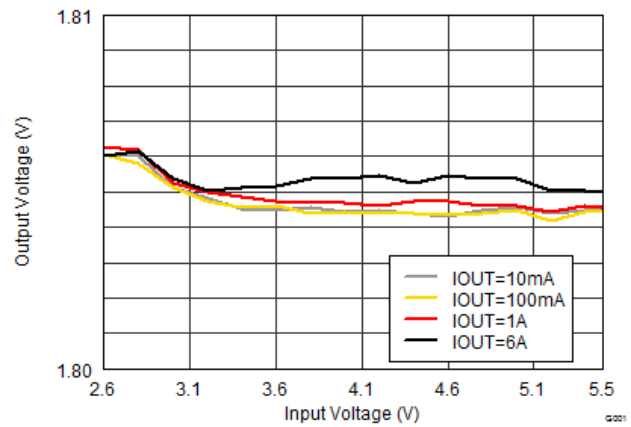

Figure 19. Output Voltage vs Input Voltage (Line Regulation)

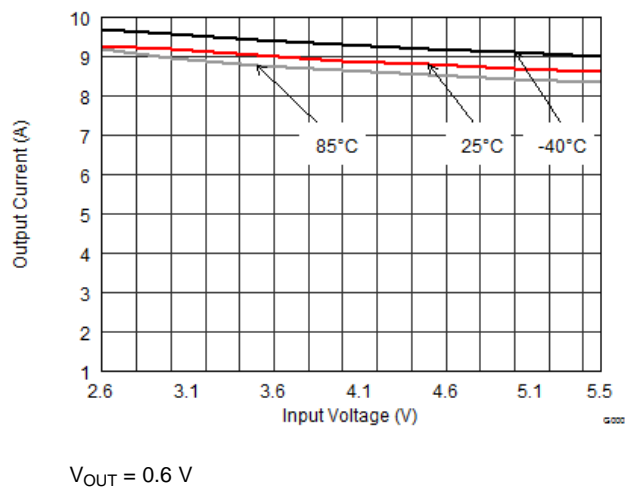

Figure 20. Maximum Output Current

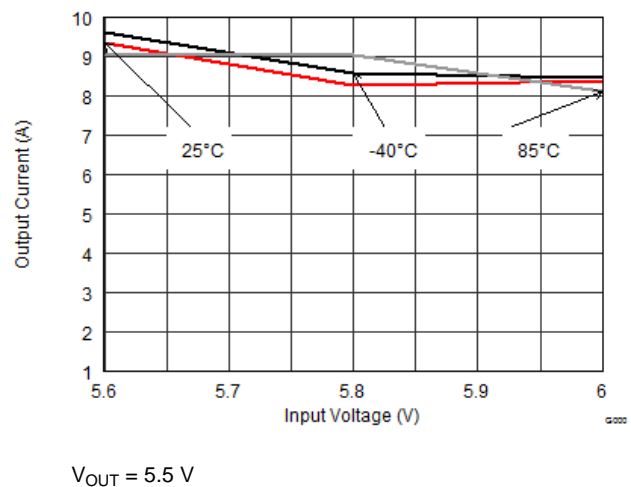
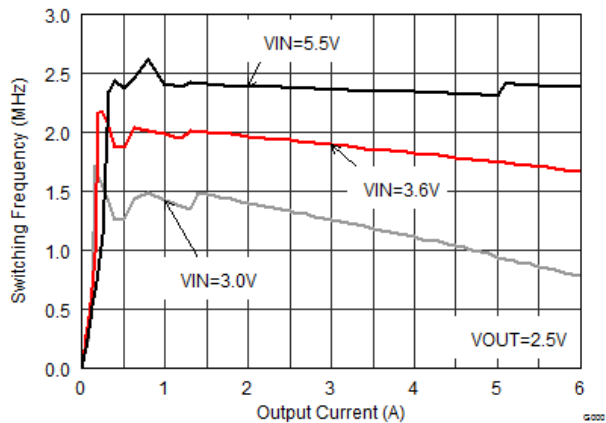
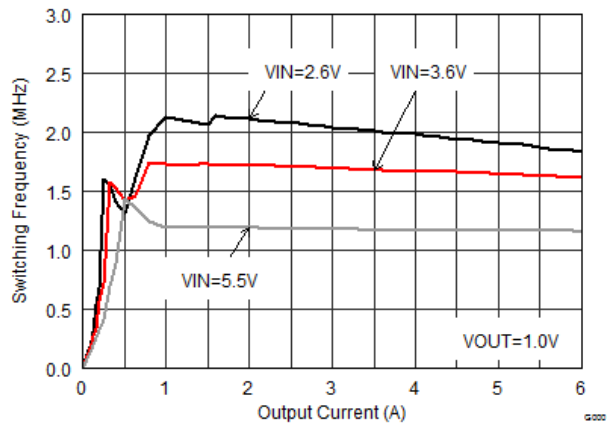

Figure 21. Maximum Output Current



$V_{OUT} = 2.5\text{ V}$

Figure 22. Switching Frequency vs Output Current



$V_{OUT} = 1\text{ V}$

Figure 23. Switching Frequency vs Output Current

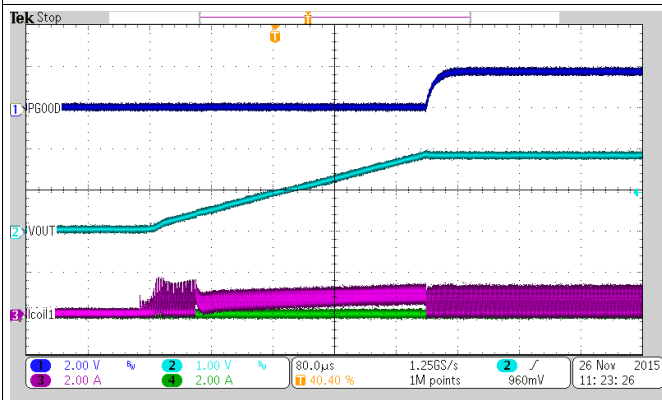

$V_{OUT} = 1.8\text{ V}$

Figure 24. Startup into 3.3 Ω

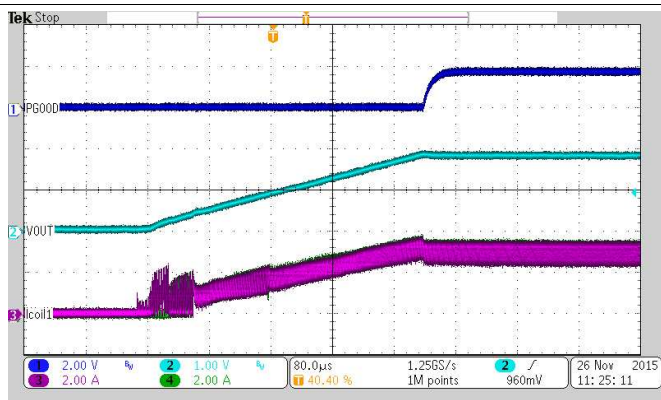

$V_{OUT} = 1.8\text{ V}$

Figure 25. Startup into 0.3 Ω

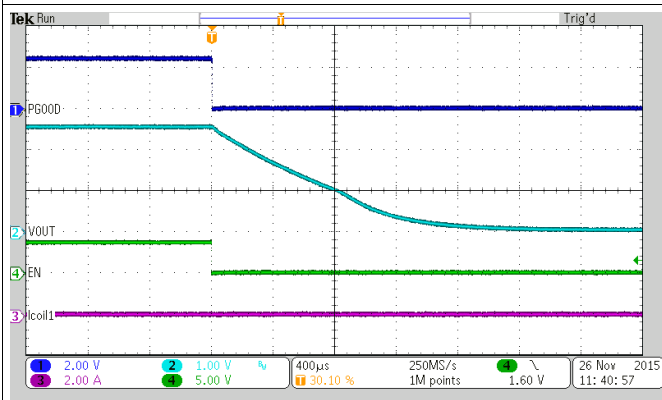

$V_{OUT} = 2.5\text{ V}$

Figure 26. Output Discharge

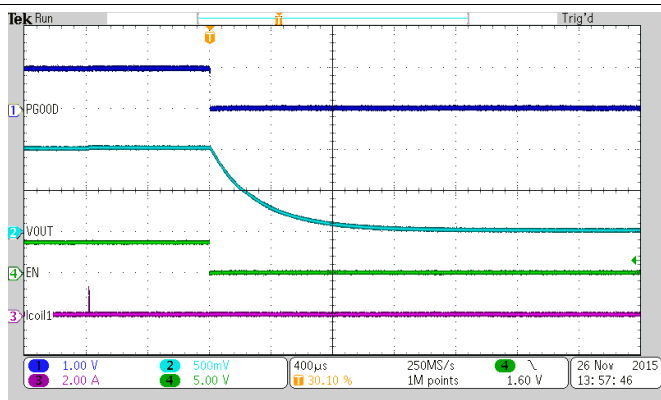

$V_{OUT} = 1\text{ V}$

Figure 27. Output Discharge

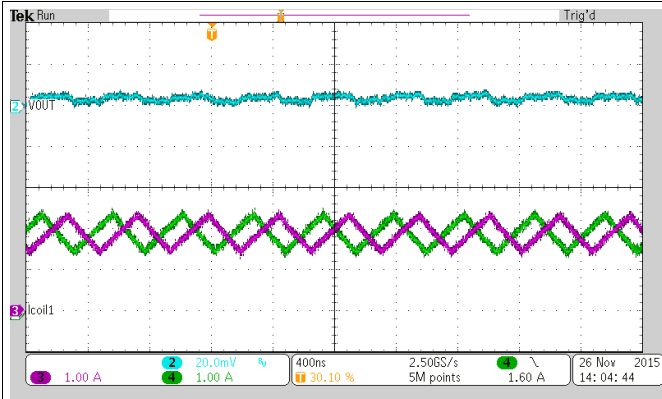
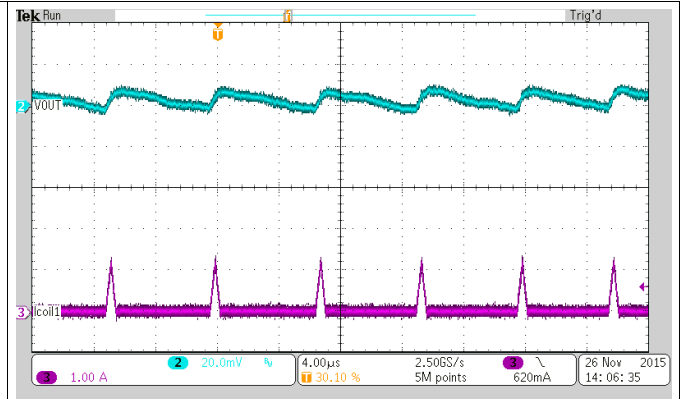

Figure 28. Typical Operation PWM



$I_{OUT} = 50 \text{ mA}$

Figure 29. Typical Operation PSM

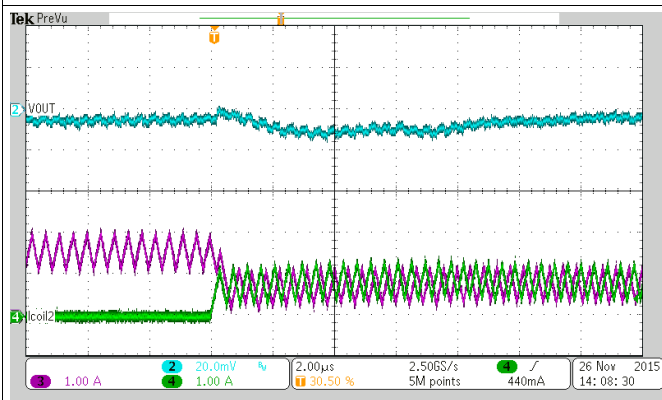

Figure 30. Adding 2nd Phase

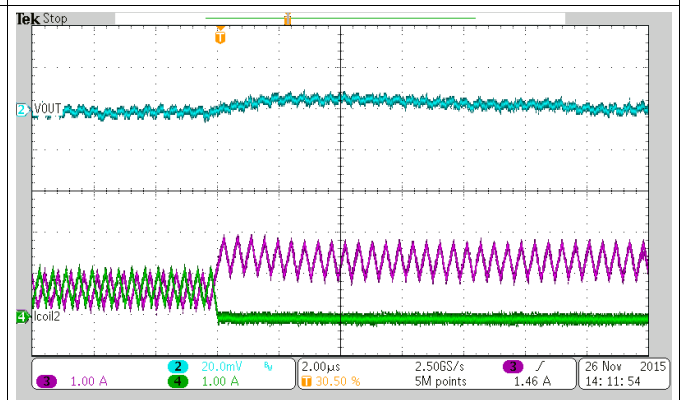

Figure 31. Shedding 2nd Phase

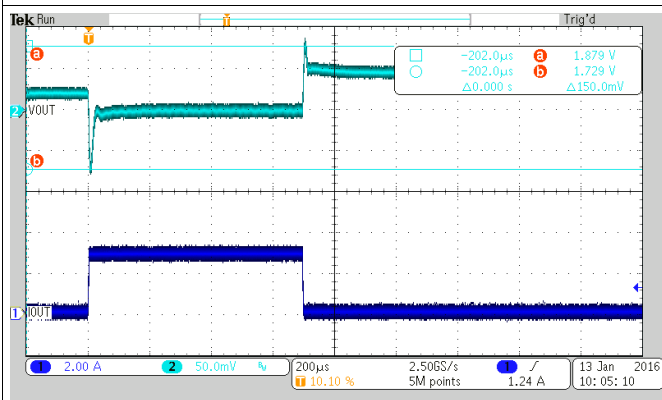
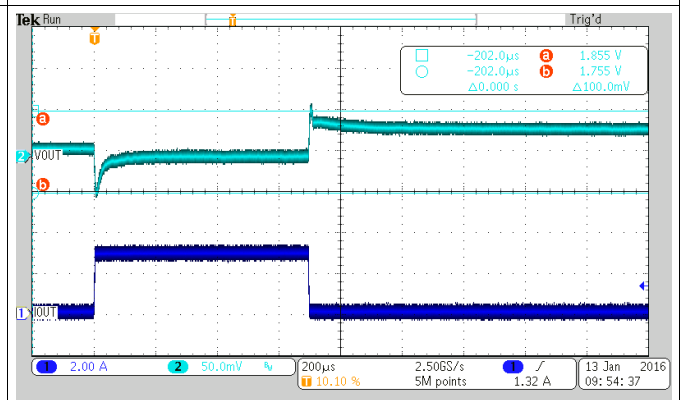

Figure 32. Load Transient Response (PSM-PWM), Load Step 0 to 3 A



$C_{ff} = 36 \text{ pF (nom)}$

Figure 33. Load Transient Response (PSM-PWM), Load Step 0 to 3 A

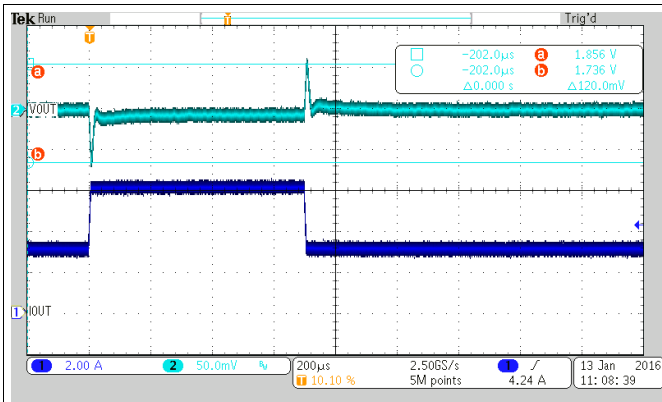
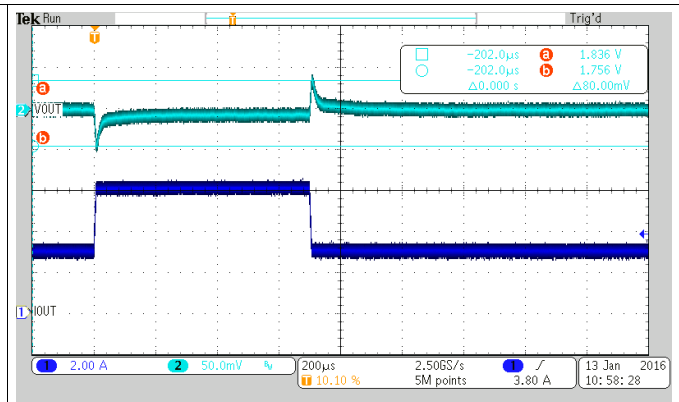
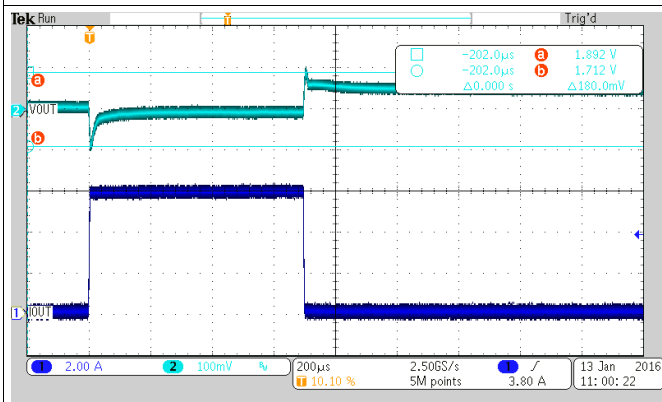

Figure 34. Load Transient Response (PWM-PWM), Load Step 3 to 6 A



$C_{ff} = 36 \text{ pF (nom)}$

Figure 35. Load Transient Response (PWM-PWM), Load Step 3 to 6 A



$C_{ff} = 36 \text{ pF (nom)}$

Figure 36. Load Transient Response (PWM-PWM), Load Step 0 to 6 A

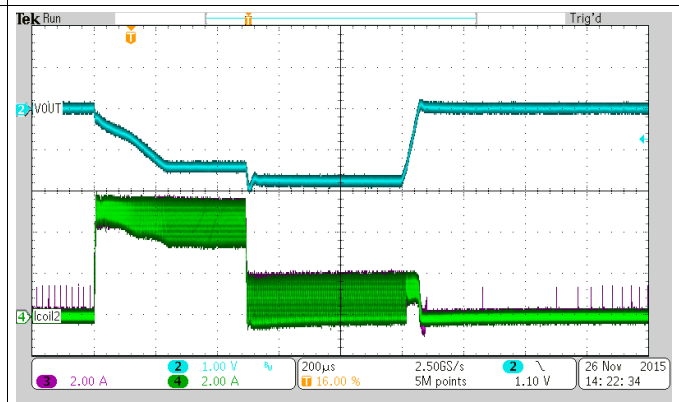

$I_{OUT} = 10 \text{ A}$

Figure 37. Current Limit Fold-Back at Overload

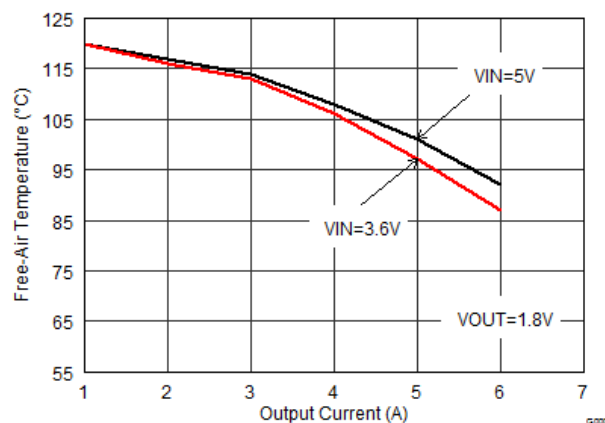

Figure 38. Maximum Ambient Temperature (TPS62480 EVM)

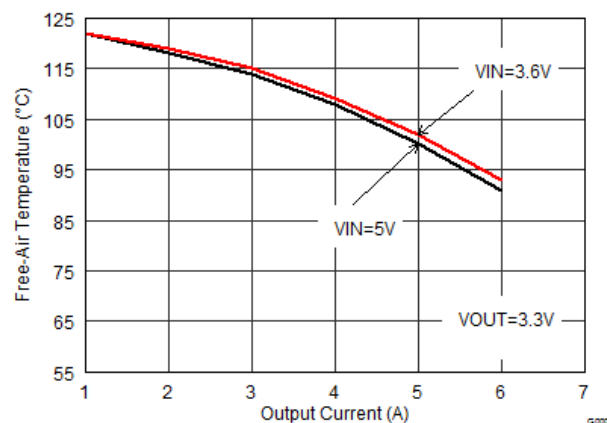
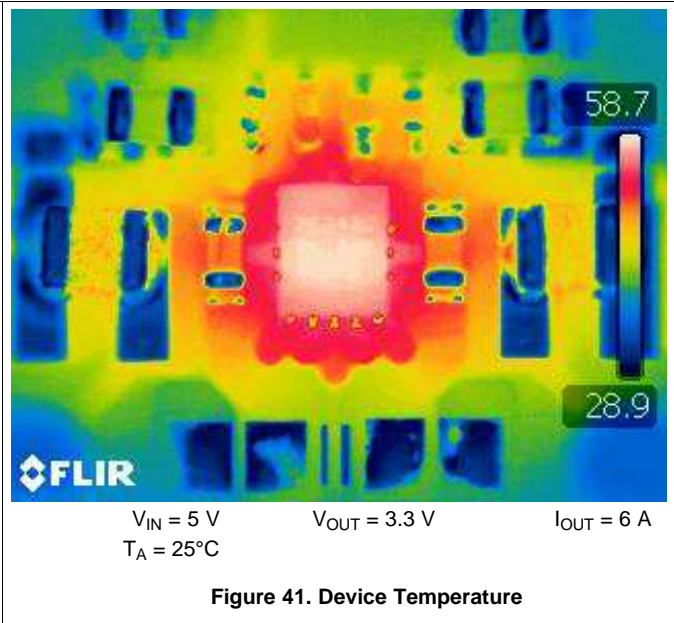
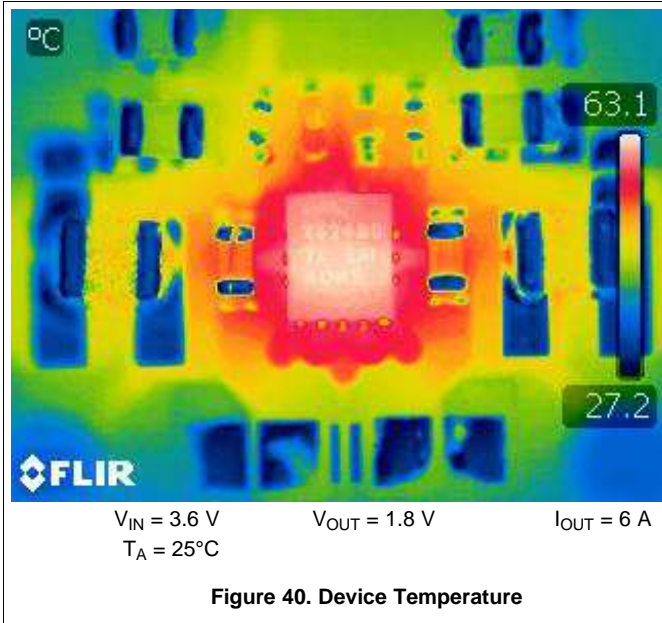

Figure 39. Maximum Ambient Temperature (TPS62480 EVM)



8.3 System Examples

This section provides typical schematics for commonly used output voltages values.

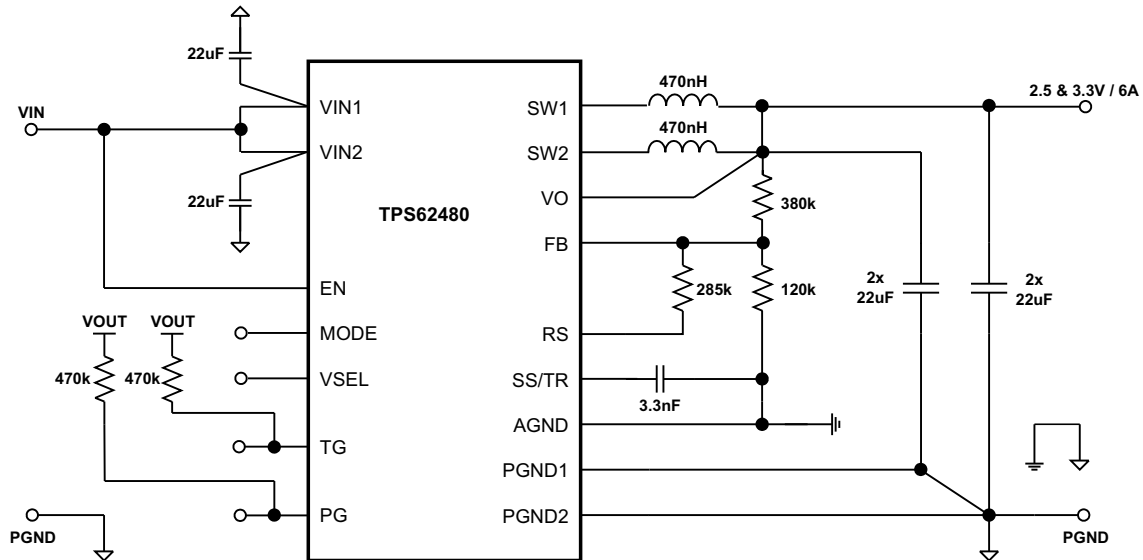

Figure 42. A typical 2.5 V & 3.3 V, 6 A Power Supply

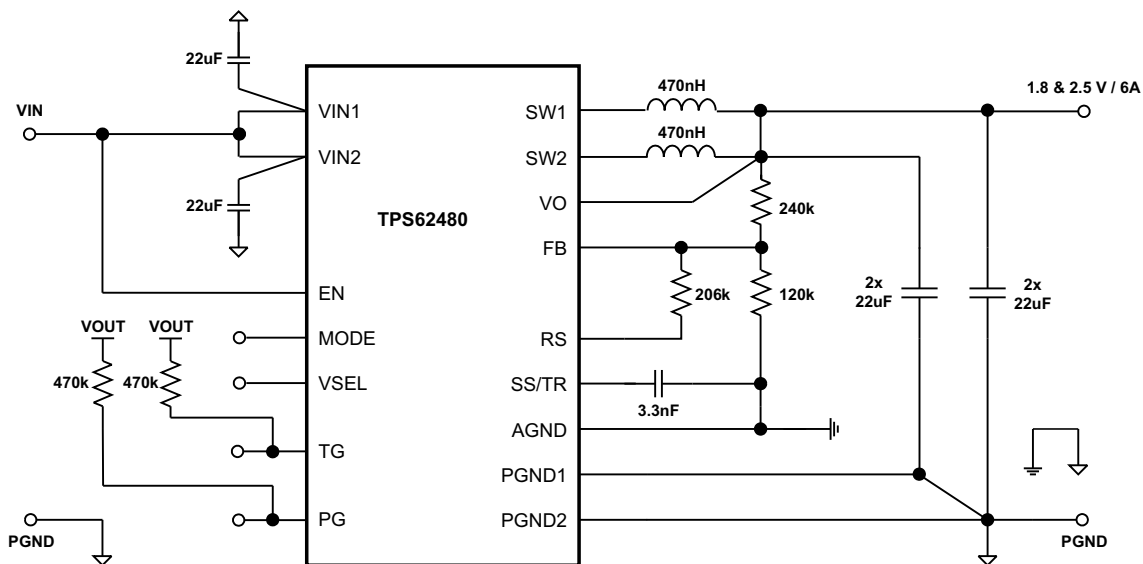
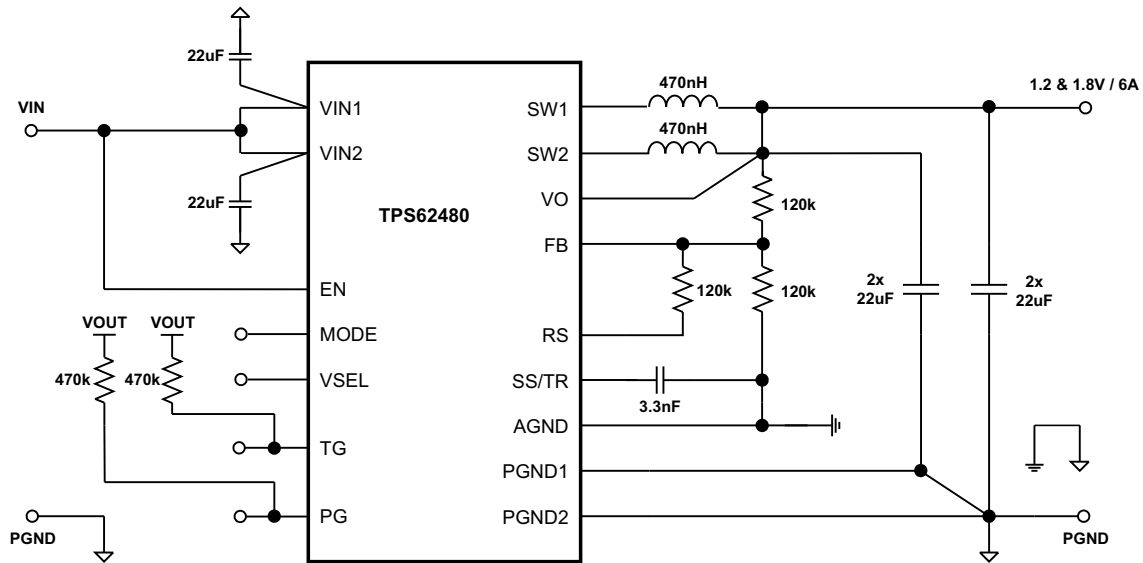
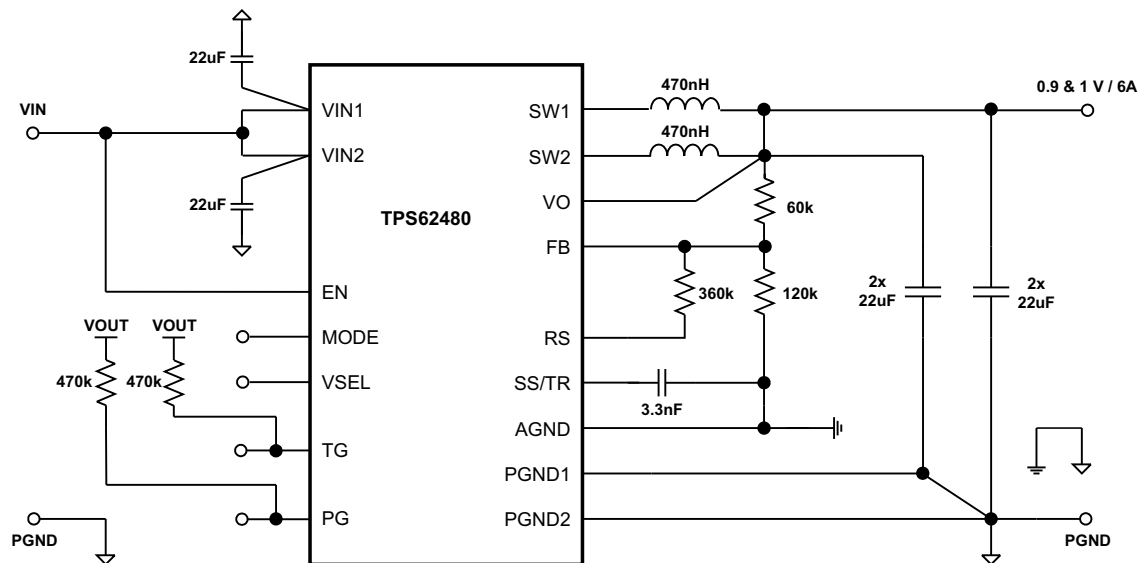

Figure 43. A typical 1.8 V & 2.5 V, 6 A Power Supply

System Examples (continued)

Figure 44. A typical 1.2 V & 1.8 V, 6 A Power Supply

Figure 45. A typical 0.9 V & 1 V, 6 A Power Supply

9 Power Supply Recommendations

The TPS62480 is designed to operate from a 2.4-V to 5.5-V input voltage supply. The input power supply's output current needs to be rated according to the output voltage and the output current of the power rail application.

10 Layout

10.1 Layout Guidelines

A recommended PCB layout for the TPS62480 dual phase solution is shown below. It ensures best electrical and optimized thermal performance considering the following important topics:

- The input capacitors must be placed as close as possible to the appropriate pins of the device. This provides low resistive and inductive paths for the high di/dt input current. The input capacitance is split, as is the V_{IN} connection, to avoid interference between the input lines.
- The SW node connection from the IC to the inductor conducts high currents. It should be kept short and can be designed in parallel with an internal or bottom layer plane, to provide low resistance and enhanced thermal behavior.
- The V_{OUT} regulation loop is closed with C_{OUT} and its ground connection. To avoid PGND noise crosstalk, PGND is kept split for the regulation loop. If a ground layer or plane is used, a direct connection by vias, as shown, is recommended. Otherwise the connection of C_{OUT} to GND must be short for good load regulation.
- The use of thermal (filled) vias underneath the device is recommended for improved thermal performance.
- The FB node is sensitive to dv/dt signals. Therefore the resistive divider should be placed close to the FB (and R_S pin in case of using R_3) pin, avoiding long trace distance.

For more detailed information about the actual 4 layer EVM solution, see [SLVUA16](#).

10.2 Layout Example

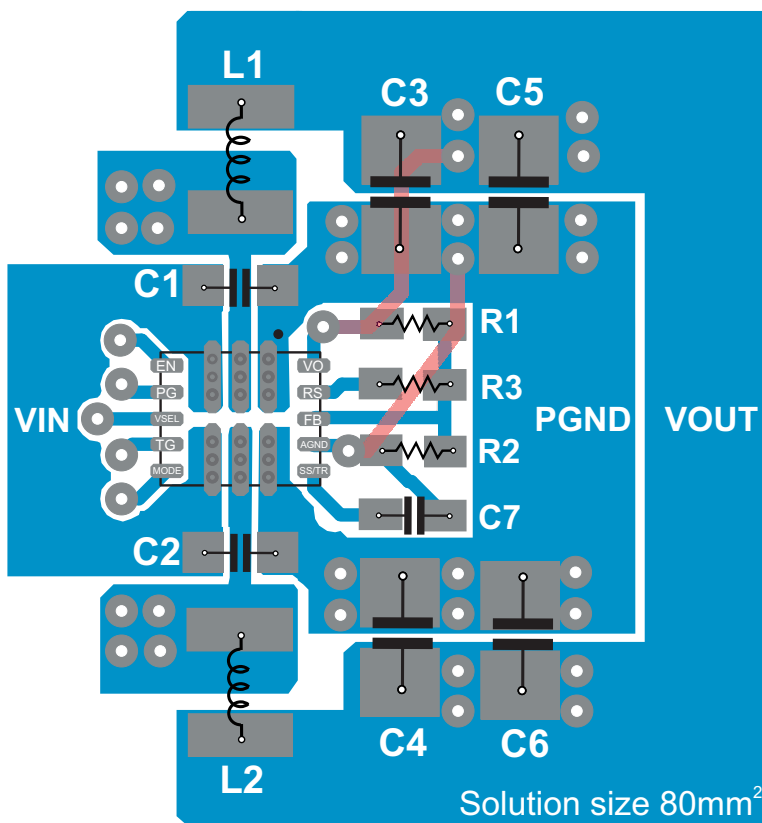

Figure 46. TPS62480 Board Layout

11 Device and Documentation Support

11.1 Third-Party Products Disclaimer

TI'S PUBLICATION OF INFORMATION REGARDING THIRD-PARTY PRODUCTS OR SERVICES DOES NOT CONSTITUTE AN ENDORSEMENT REGARDING THE SUITABILITY OF SUCH PRODUCTS OR SERVICES OR A WARRANTY, REPRESENTATION OR ENDORSEMENT OF SUCH PRODUCTS OR SERVICES, EITHER ALONE OR IN COMBINATION WITH ANY TI PRODUCT OR SERVICE.

11.2 Community Resources

The following links connect to TI community resources. Linked contents are provided "AS IS" by the respective contributors. They do not constitute TI specifications and do not necessarily reflect TI's views; see TI's [Terms of Use](#).

TI E2E™ Online Community *TI's Engineer-to-Engineer (E2E) Community*. Created to foster collaboration among engineers. At e2e.ti.com, you can ask questions, share knowledge, explore ideas and help solve problems with fellow engineers.

Design Support *TI's Design Support* Quickly find helpful E2E forums along with design support tools and contact information for technical support.

11.3 Trademarks

HotRod, E2E are trademarks of Texas Instruments.

11.4 Electrostatic Discharge Caution



These devices have limited built-in ESD protection. The leads should be shorted together or the device placed in conductive foam during storage or handling to prevent electrostatic damage to the MOS gates.

11.5 Glossary

[SLYZ022](#) — *TI Glossary*.

This glossary lists and explains terms, acronyms, and definitions.

12 Mechanical, Packaging, and Orderable Information

The following pages include mechanical, packaging, and orderable information. This information is the most current data available for the designated devices. This data is subject to change without notice and revision of this document. For browser-based versions of this data sheet, refer to the left-hand navigation.

PACKAGING INFORMATION

Orderable Device	Status (1)	Package Type	Package Drawing	Pins	Package Qty	Eco Plan (2)	Lead finish/ Ball material (6)	MSL Peak Temp (3)	Op Temp (°C)	Device Marking (4/5)	Samples
TPS62480RNCR	ACTIVE	VQFN-HR	RNC	16	3000	RoHS & Green	Call TI SN	Level-1-260C-UNLIM	-40 to 125	62480	Samples
TPS62480RNCT	ACTIVE	VQFN-HR	RNC	16	250	RoHS & Green	Call TI	Level-1-260C-UNLIM	-40 to 125	62480	Samples

(1) The marketing status values are defined as follows:

ACTIVE: Product device recommended for new designs.

LIFEBUY: TI has announced that the device will be discontinued, and a lifetime-buy period is in effect.

NRND: Not recommended for new designs. Device is in production to support existing customers, but TI does not recommend using this part in a new design.

PREVIEW: Device has been announced but is not in production. Samples may or may not be available.

OBSOLETE: TI has discontinued the production of the device.

(2) **RoHS:** TI defines "RoHS" to mean semiconductor products that are compliant with the current EU RoHS requirements for all 10 RoHS substances, including the requirement that RoHS substance do not exceed 0.1% by weight in homogeneous materials. Where designed to be soldered at high temperatures, "RoHS" products are suitable for use in specified lead-free processes. TI may reference these types of products as "Pb-Free".

RoHS Exempt: TI defines "RoHS Exempt" to mean products that contain lead but are compliant with EU RoHS pursuant to a specific EU RoHS exemption.

Green: TI defines "Green" to mean the content of Chlorine (Cl) and Bromine (Br) based flame retardants meet JS709B low halogen requirements of <=1000ppm threshold. Antimony trioxide based flame retardants must also meet the <=1000ppm threshold requirement.

(3) MSL, Peak Temp. - The Moisture Sensitivity Level rating according to the JEDEC industry standard classifications, and peak solder temperature.

(4) There may be additional marking, which relates to the logo, the lot trace code information, or the environmental category on the device.

(5) Multiple Device Markings will be inside parentheses. Only one Device Marking contained in parentheses and separated by a "~" will appear on a device. If a line is indented then it is a continuation of the previous line and the two combined represent the entire Device Marking for that device.

(6) Lead finish/Ball material - Orderable Devices may have multiple material finish options. Finish options are separated by a vertical ruled line. Lead finish/Ball material values may wrap to two lines if the finish value exceeds the maximum column width.

Important Information and Disclaimer:The information provided on this page represents TI's knowledge and belief as of the date that it is provided. TI bases its knowledge and belief on information provided by third parties, and makes no representation or warranty as to the accuracy of such information. Efforts are underway to better integrate information from third parties. TI has taken and continues to take reasonable steps to provide representative and accurate information but may not have conducted destructive testing or chemical analysis on incoming materials and chemicals. TI and TI suppliers consider certain information to be proprietary, and thus CAS numbers and other limited information may not be available for release.

In no event shall TI's liability arising out of such information exceed the total purchase price of the TI part(s) at issue in this document sold by TI to Customer on an annual basis.

TAPE AND REEL INFORMATION

QUADRANT ASSIGNMENTS FOR PIN 1 ORIENTATION IN TAPE



*All dimensions are nominal

Device	Package Type	Package Drawing	Pins	SPQ	Reel Diameter (mm)	Reel Width W1 (mm)	A0 (mm)	B0 (mm)	K0 (mm)	P1 (mm)	W (mm)	Pin1 Quadrant
TPS62480RNCR	VQFN-HR	RNC	16	3000	330.0	12.4	2.8	3.3	1.2	8.0	12.0	Q1

TAPE AND REEL BOX DIMENSIONS

*All dimensions are nominal

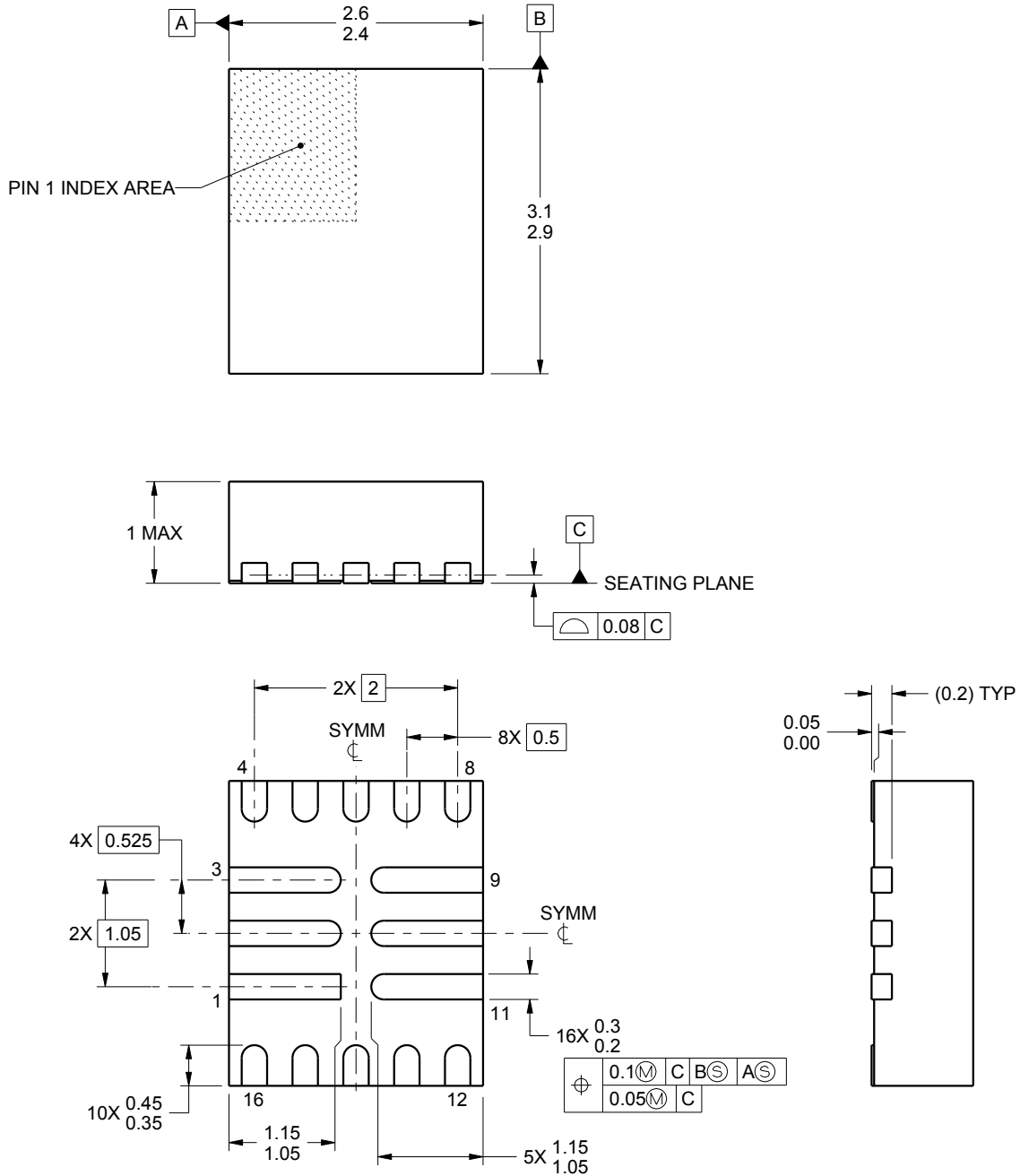
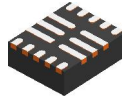
Device	Package Type	Package Drawing	Pins	SPQ	Length (mm)	Width (mm)	Height (mm)
TPS62480RNCR	VQFN-HR	RNC	16	3000	346.0	346.0	80.0



4221751/A 02/2015

NOTES:

1. All linear dimensions are in millimeters. Any dimensions in parenthesis are for reference only. Dimensioning and tolerancing per ASME Y14.5M.
2. This drawing is subject to change without notice.

EXAMPLE BOARD LAYOUT

RNC0016A

VQFN - 1 mm max height

PLASTIC QUAD FLATPACK - NO LEAD

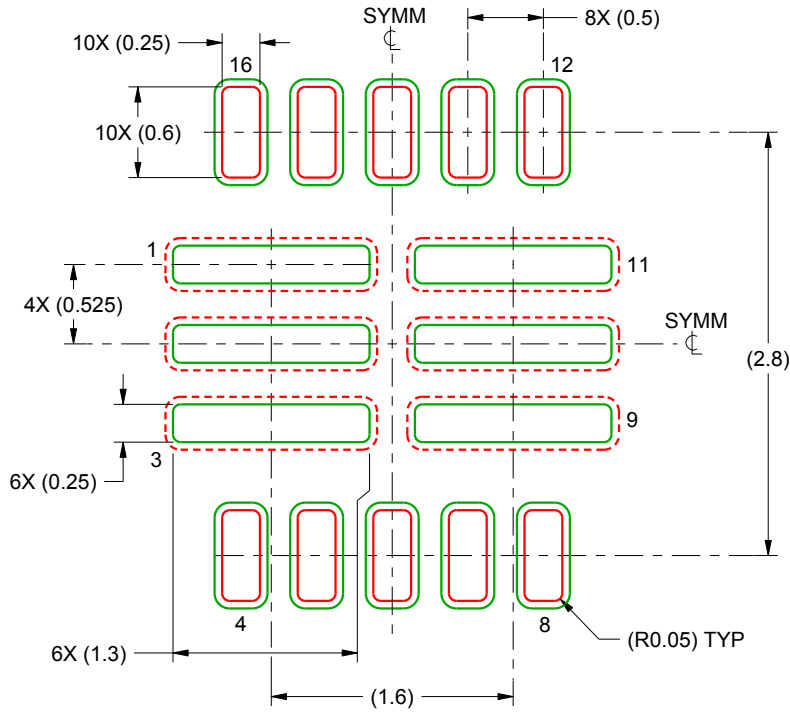

LAND PATTERN EXAMPLE
SCALE:20X

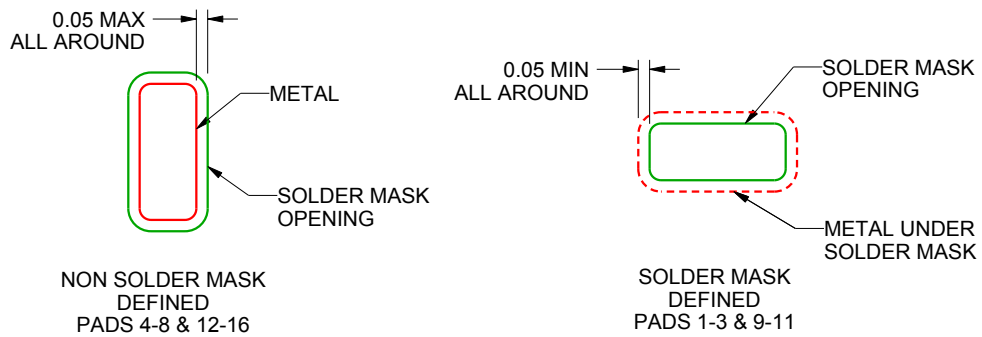

SOLDER MASK DETAILS

4221751/A 02/2015

NOTES: (continued)

3. For more information, see Texas Instruments literature number SLUA271 (www.ti.com/lit/slua271).
4. Solder mask tolerances between and around signal pads can vary based on board fabrication site.

EXAMPLE STENCIL DESIGN

RNC0016A

VQFN - 1 mm max height

PLASTIC QUAD FLATPACK - NO LEAD

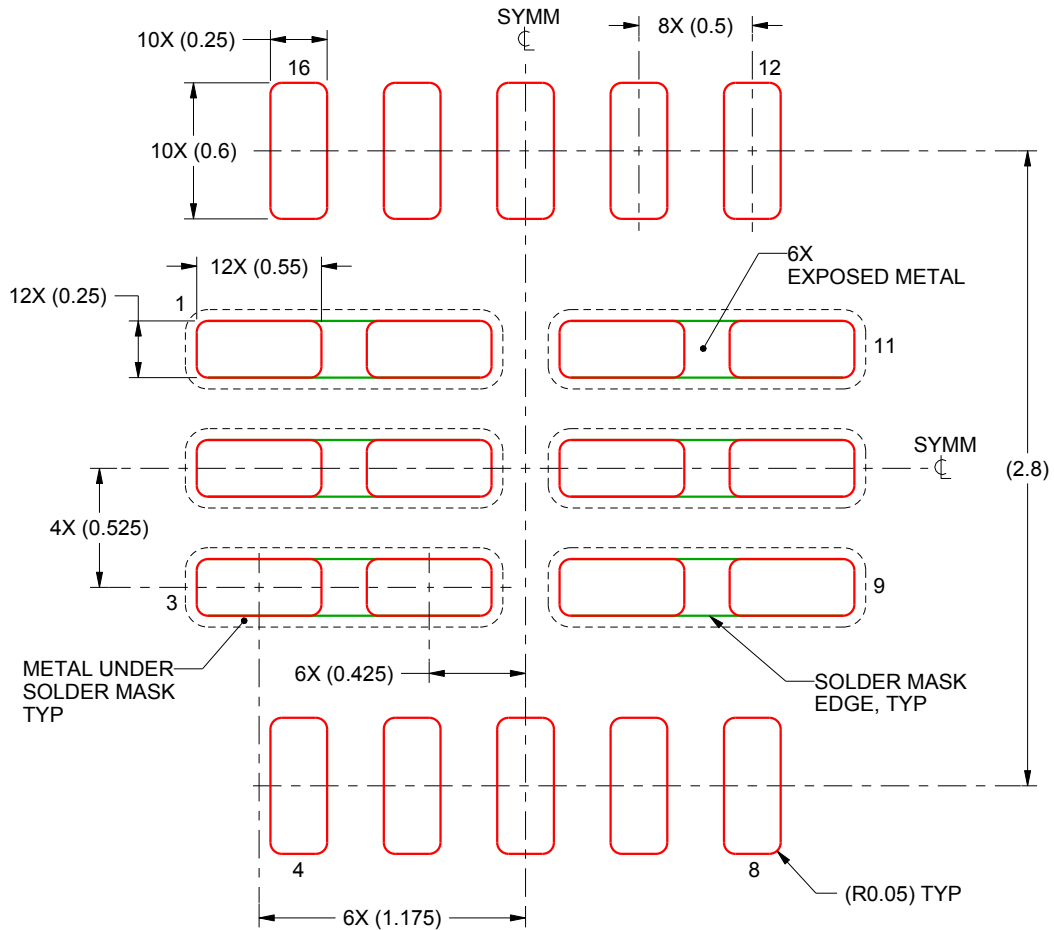

SOLDER PASTE EXAMPLE
 BASED ON 0.125 mm THICK STENCIL
 FOR PADS 1-3 & 9-11
 84.6% PRINTED SOLDER COVERAGE BY AREA
 SCALE:30X

4221751/A 02/2015

NOTES: (continued)

5. For alternate stencil design recommendations, see IPC-7525 or board assembly site preference.

IMPORTANT NOTICE AND DISCLAIMER

TI PROVIDES TECHNICAL AND RELIABILITY DATA (INCLUDING DATA SHEETS), DESIGN RESOURCES (INCLUDING REFERENCE DESIGNS), APPLICATION OR OTHER DESIGN ADVICE, WEB TOOLS, SAFETY INFORMATION, AND OTHER RESOURCES "AS IS" AND WITH ALL FAULTS, AND DISCLAIMS ALL WARRANTIES, EXPRESS AND IMPLIED, INCLUDING WITHOUT LIMITATION ANY IMPLIED WARRANTIES OF MERCHANTABILITY, FITNESS FOR A PARTICULAR PURPOSE OR NON-INFRINGEMENT OF THIRD PARTY INTELLECTUAL PROPERTY RIGHTS.

These resources are intended for skilled developers designing with TI products. You are solely responsible for (1) selecting the appropriate TI products for your application, (2) designing, validating and testing your application, and (3) ensuring your application meets applicable standards, and any other safety, security, regulatory or other requirements.

These resources are subject to change without notice. TI grants you permission to use these resources only for development of an application that uses the TI products described in the resource. Other reproduction and display of these resources is prohibited. No license is granted to any other TI intellectual property right or to any third party intellectual property right. TI disclaims responsibility for, and you will fully indemnify TI and its representatives against, any claims, damages, costs, losses, and liabilities arising out of your use of these resources.

TI's products are provided subject to [TI's Terms of Sale](#) or other applicable terms available either on [ti.com](https://www.ti.com) or provided in conjunction with such TI products. TI's provision of these resources does not expand or otherwise alter TI's applicable warranties or warranty disclaimers for TI products.

TI objects to and rejects any additional or different terms you may have proposed.

Mailing Address: Texas Instruments, Post Office Box 655303, Dallas, Texas 75265
Copyright © 2024, Texas Instruments Incorporated