

## TPS629203-Q1 300mA、3V~17V 車載用、低 I<sub>Q</sub> 降圧コンバータ

### 1 特長

- 車載アプリケーション用に AEC-Q100 認定済み:
  - 動作時の接合部温度範囲: -40°C~150°C
  - HBM ESD 分類レベル 2 デバイス
  - CDM ESD 分類レベル C4B
- 機能安全対応
  - 機能安全システムの設計に役立つ資料を利用可能
- 高効率 DCS-Control トポロジ
  - 内部補償
  - PWM/PFM のシームレスな切り替え
- 4μA (標準値) の低い静止電流
- 最大 0.3A の出力電流
- R<sub>DS(on)</sub>: 250mΩ ハイサイド、85mΩ ローサイド
- ±1% の出力電圧精度
- 構成可能な出力電圧:
  - V<sub>FB</sub> 外部分圧器: 0.6V~5.5V
  - VSET 内部分圧器:
    - 0.4V~5.5V の 18 通りの選択肢
- MODE/S-CONF ピンによる優れた柔軟性
  - 2.5MHz または 1.0MHz のスイッチング周波数
  - 強制 PWM または自動 (PFM) パワー・セーブ・モード (動的モード変更機能付き)
  - 出力放電のオン/オフ
- 外部ブートストラップ・コンデンサ不要
- 過電流および過熱保護
- 100% デューティ・サイクル・モード
- 高精度イネーブル入力
- パワー・グッド出力
- TPS629210-Q1、TPS629206-Q1 デバイスとピン互換
- 0.5mm ピッチの 8 ピン SOT-5X3 パッケージ

### 2 アプリケーション

- 先進運転支援システム (ADAS)
- 車載用インフォテインメントおよびクラスタ
- 自動車ボディ・エレクトロニクスおよびライティング

### 3 概要

車載用認定済みの TPS6292xx-Q1 デバイス・ファミリーは、高効率かつ小型で非常に柔軟性が高く、使いやすい同期整流降圧 DC/DC コンバータです。入力電圧範囲が 3V~17V と広いため、12V、5V、3.3V の電源レールまたはシングル・セル / マルチセル・リチウムイオン・バッテリーで動作する各種システムに対応できます。TPS629203-Q1 は、2.5MHz または 1MHz の強制 PWM モードまたは可変周波数 (自動 PFM) モードで動作するように構成できます。自動 PFM モードでは、軽負荷になると自動的にパワー・セーブ・モードに移行して高い効率を維持します。静止電流が 4μA (標準値) と小さいことも、最小の負荷まで高い効率が得られる理由です。TI の自動効率拡張 (AEE) モードを使うと、入力と出力の電圧に基づいてスイッチング周波数が自動的に調整されるため、同じインダクタを使っても動作範囲全域で高い変換効率を維持できます。MODE/S-CONF 入力ピンは、スイッチング周波数の挙動の選択に加えて、外部および内部帰還分圧器の各種組み合わせと出力電圧放電機能のイネーブル / ディセーブルの選択にも使えます。内部帰還構成では、FB/VSET ピンと GND の間に接続する抵抗の値によって 18 種類の出力電圧を選択できます (表 8-2 を参照)。

#### デバイス情報

| 部品番号         | パッケージ <sup>(1)</sup> | 本体サイズ (公称)                 |
|--------------|----------------------|----------------------------|
| TPS629203-Q1 | SOT-5X3 (8)          | 1.60mm × 2.10mm<br>(ピンを含む) |

(1) 利用可能なパッケージについては、このデータシートの末尾にある注文情報を参照してください。



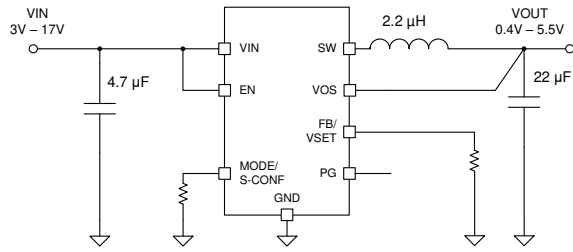

概略回路図

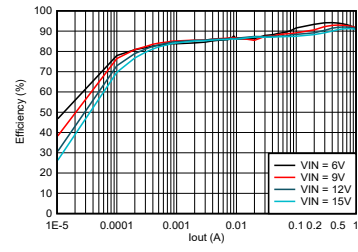

効率と出力電流との関係  
 $V_{OUT} = 3.3V$  (2.5MHz 自動 PFM/PWM)

## Table of Contents

|  |           |  |           |
|--|-----------|--|-----------|
| <b>1 特長</b> .....                              | <b>1</b>  | <b>9 Application and Implementation</b> .....          | <b>20</b> |
| <b>2 アプリケーション</b> .....                        | <b>1</b>  | 9.1 Application Information.....                       | 20        |
| <b>3 概要</b> .....                              | <b>1</b>  | 9.2 Typical Application.....                           | 20        |
| <b>4 Revision History</b> .....                | <b>3</b>  | 9.3 System Examples.....                               | 39        |
| <b>5 Device Comparison Table</b> .....         | <b>4</b>  | <b>10 Power Supply Recommendations</b> .....           | <b>40</b> |
| <b>6 Pin Configuration and Functions</b> ..... | <b>4</b>  | <b>11 Layout</b> .....                                 | <b>41</b> |
| <b>7 Specifications</b> .....                  | <b>5</b>  | 11.1 Layout Guidelines.....                            | 41        |
| 7.1 Absolute Maximum Ratings.....              | 5         | 11.2 Layout Example.....                               | 41        |
| 7.2 ESD Ratings.....                           | 5         | <b>12 Device and Documentation Support</b> .....       | <b>43</b> |
| 7.3 Recommended Operating Conditions.....      | 5         | 12.1 Device Support.....                               | 43        |
| 7.4 Thermal Information.....                   | 5         | 12.2 Documentation Support.....                        | 43        |
| 7.5 Electrical Characteristics.....            | 6         | 12.3 Receiving Notification of Documentation Updates.. | 43        |
| 7.6 Typical Characteristics.....               | 8         | 12.4 サポート・リソース.....                                    | 43        |
| <b>8 Detailed Description</b> .....            | <b>11</b> | 12.5 Trademarks.....                                   | 44        |
| 8.1 Overview.....                              | 11        | 12.6 Electrostatic Discharge Caution.....              | 44        |
| 8.2 Functional Block Diagram.....              | 11        | 12.7 Glossary.....                                     | 44        |
| 8.3 Feature Description.....                   | 12        | <b>13 Mechanical, Packaging, and Orderable</b>         |           |
| 8.4 Device Functional Modes.....               | 16        | <b>Information</b> .....                               | <b>44</b> |

## 4 Revision History

資料番号末尾の英字は改訂を表しています。その改訂履歴は英語版に準じています。

| DATE       | REVISION | NOTES           |
|------------|----------|-----------------|
| March 2022 | *        | Initial Release |

## 5 Device Comparison Table

| Device Number | Output Current | Input Voltage | Operating Temperature Range | Switching Frequency                 | PWM Mode                              | V <sub>O</sub> Adjust                          |
|---------------|----------------|---------------|-----------------------------|-------------------------------------|---------------------------------------|--|
| TPS629203-Q1  | 0 A–0.3 A      | 3 V–17 V      | –40°C to 150°C              | Selectable 1-MHz or 2.5-MHz options | Selectable auto PWM/PFM or forced PWM | Externally programmable or 18 internal options |
| TPS629206-Q1  | 0 A–0.6 A      |               |                             |                                     |                                       |  |
| TPS629210-Q1  | 0 A–1 A        |               |                             |                                     |                                       |  |

## 6 Pin Configuration and Functions



図 6-1. TPS629203-Q1 8-Pin DRL SOT-5X3 Pinout

表 6-1. Pin Functions

| Pin         |     | I/O | Description  |
|-------------|-----|-----|--|
| Name        | NO. |     |  |
| FB/VSET     | 1   | I   | Dependent upon device configuration (see <a href="#">セクション 8.3.1</a> ) <ul style="list-style-type: none"> <li>• FB: Voltage feedback input. Connect a resistive output voltage divider to this pin.</li> <li>• VSET: Output voltage setting pin. Connect a resistor to GND to choose the output voltage according to <a href="#">表 8-2</a>.</li> </ul> |
| PG          | 2   | O   | Open-drain power-good output   |
| VOS         | 3   | I   | Output voltage sense pin. Connect directly to the positive pin of the output capacitor.  |
| SW          | 4   |     | Switch pin of the converter. Connected to the internal power switches  |
| GND         | 5   |     | Ground pin   |
| VIN         | 6   | I   | Power supply input. Make sure the input capacitor is connected as close as possible between the VIN pin and GND.   |
| EN          | 7   | I   | Enable/disable pin including a threshold comparator. Connect to logic low to disable the device. Pull high to enable the device. Do not leave this pin unconnected.  |
| MODE/S-CONF | 8   | I   | Device mode selection (auto PFM/PWM or forced PWM operation) and Smart-CONFIG pin. Connect a resistor to configure the device according to <a href="#">表 8-1</a> .   |

## 7 Specifications

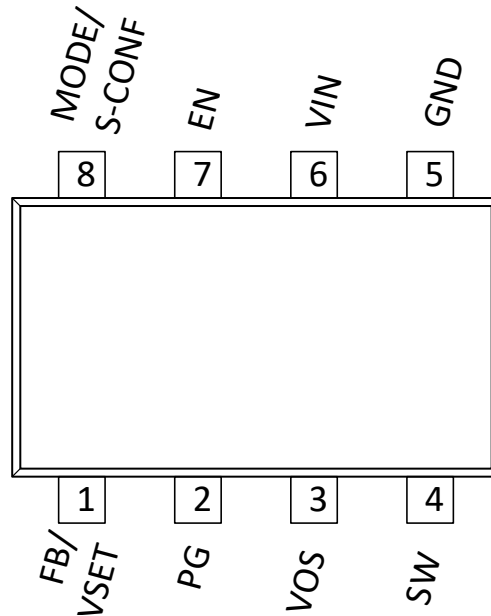
### 7.1 Absolute Maximum Ratings

over operating temperature range (unless otherwise noted)<sup>(1)</sup>

|                        |   | MIN  | MAX                   | UNIT |
|------------------------|---|------|-----------------------|------|
| Voltage <sup>(2)</sup> | VIN, EN, PG, MODE/S-CONF                | -0.3 | 18                    | V    |
| Voltage <sup>(2)</sup> | SW <sup>(3)</sup>                       | -0.3 | V <sub>IN</sub> + 0.3 | V    |
| Voltage <sup>(2)</sup> | SW (AC, less than 10 ns) <sup>(3)</sup> | -3.0 | 23                    | V    |
| Voltage <sup>(2)</sup> | FB/VSET, VOS                            | -0.3 | 6                     | V    |
| Current                | PG                                      |      | 10                    | mA   |
| T <sub>stg</sub>       | Storage temperature                     | -65  | 150                   | °C   |

- (1) Operation outside the *Absolute Maximum Ratings* may cause permanent device damage. *Absolute Maximum Ratings* do not imply functional operation of the device at these or any other conditions beyond those listed under *Recommended Operating Conditions*. If used outside the *Recommended Operating Conditions* but within the *Absolute Maximum Ratings*, the device may not be fully functional, and this may affect device reliability, functionality, performance, and shorten the device lifetime.
- (2) All voltage values are with respect to network ground terminal.
- (3) While switching

### 7.2 ESD Ratings

|                    |                         |  | VALUE | UNIT |
|--------------------|-------------------------|--|-------|------|
| V <sub>(ESD)</sub> | Electrostatic discharge | Human body model (HBM), per AEC Q100-002 <sup>(1)</sup> HBM ESD classification level 2 | ±2000 | V    |
|                    | Electrostatic discharge | Charged device model (CDM), per AEC Q100-011CDM ESD classification level C4B           | ±750  | V    |

- (1) AEC Q100-002 indicates that HBM stressing must be in accordance with the ANSI/ESDA/JEDEC JS-001 specification.

### 7.3 Recommended Operating Conditions

Over operating junction temperature range (unless otherwise noted)

|                      |   | MIN                | NOM | MAX                | UNIT |
|----------------------|---|--------------------|-----|--------------------|------|
| V <sub>I</sub>       | Input voltage range                         | 3.0                |     | 17                 | V    |
| V <sub>O</sub>       | Output voltage range                        | 0.4                |     | 5.5                | V    |
| C <sub>I</sub>       | Effective input capacitance                 | 3                  | 4.7 |                    | µF   |
| C <sub>O</sub>       | Effective output capacitance <sup>(1)</sup> | 10                 | 22  | 100                | µF   |
| L                    | Output inductance <sup>(2)</sup>            | 1.0 <sup>(3)</sup> | 2.2 | 4.7 <sup>(4)</sup> | µH   |
| I <sub>OUT</sub>     | Output current                              | 0                  |     | 0.3                | A    |
| I <sub>SINK_PG</sub> | Sink current at the PG pin                  |                    |     | 1                  | mA   |
| T <sub>J</sub>       | Junction temperature <sup>(5)</sup>         | -40                |     | 150                | °C   |

- (1) This is for capacitors directly at the output of the device. More capacitance is allowed if there is a series resistance associated to the capacitor.
- (2) Nominal inductance value
- (3) Not recommended for 1-MHz operation
- (4) Larger values of inductance can be used to reduce the ripple current, but they can have a negative impact on efficiency and the overall transient response.
- (5) Operating lifetime is derated at junction temperatures greater than 150°C.

### 7.4 Thermal Information

| THERMAL METRIC <sup>(1)</sup> |   | SOT-5X3 (8) |               | UNIT |
|-------------------------------|---|-------------|---------------|------|
|                               |   | JEDEC PCB   | TPS6292xx EVM |      |
| R <sub>θJA</sub>              | Junction-to-ambient thermal resistance    | 120         | 60            | °C/W |
| R <sub>θJC(top)</sub>         | Junction-to-case (top) thermal resistance | 45          | n/a           | °C/W |
| R <sub>θJB</sub>              | Junction-to-board thermal resistance      | 25          | n/a           | °C/W |

| THERMAL METRIC <sup>(1)</sup> |  | SOT-5X3 (8) |               | UNIT |
|-------------------------------|--|-------------|---------------|------|
|                               |  | JEDEC PCB   | TPS6292xx EVM |      |
| $\Psi_{JT}$                   | Junction-to-top characterization parameter   | 1           | n/a           | °C/W |
| $\Psi_{JB}$                   | Junction-to-board characterization parameter | 20          | n/a           | °C/W |

(1) For more information about traditional and new thermal metrics, see the [Semiconductor and IC Package Thermal Metrics](#) application report.

## 7.5 Electrical Characteristics

$V_{IN} = 3\text{ V to }17\text{ V}$ ,  $T_J = -40^\circ\text{C to }+150^\circ\text{C}$ , typical values at  $V_I = 12\text{ V}$  and  $T_A = 25^\circ\text{C}$ , unless otherwise noted

| PARAMETER                    |   | TEST CONDITIONS  | MIN  | TYP  | MAX  | UNIT          |
|------------------------------|---|--|------|------|------|---------------|
| <b>SUPPLY</b>                |   |  |      |      |      |               |
| $I_Q$                        | Operating quiescent current (power save mode)   | $I_{OUT} = 0\text{ mA}$ , device not switching   |      | 4    |      | $\mu\text{A}$ |
| $I_{Q;PWM}$                  | Operating quiescent current (PWM mode)          | $V_{IN} = 12\text{ V}$ , $V_{OUT} = 1.2\text{ V}$ ; $I_{OUT} = 0\text{ mA}$ , device switching |      | 5    |      | mA            |
| $I_{SD}$                     | Shutdown current into the VIN pin               | EN = 0 V   |      | 0.25 | 3    | $\mu\text{A}$ |
| $V_{UVLO}$                   | Undervoltage lockout                            | $V_{IN}$ rising  | 2.85 | 2.95 | 3.0  | V             |
|                              | Undervoltage lockout                            | $V_{IN}$ falling   | 2.65 | 2.75 | 2.85 | V             |
| $V_{UVLO}$                   | Undervoltage lockout hysteresis                 |  |      | 200  |      | mV            |
| <b>CONTROL AND INTERFACE</b> |   |  |      |      |      |               |
| $I_{LKG}$                    | EN input leakage current                        | EN = $V_{IN}$  |      | 3    | 300  | nA            |
| $V_{IH;MODE}$                | High-level input voltage at the MODE/S-CONF pin |  | 1.0  |      |      | V             |
| $V_{IL;MODE}$                | Low-level input voltage at the MODE/S-CONF pin  |  |      |      | 0.15 | V             |
| $V_{IH}$                     | High-level input voltage at the EN pin          |  | 0.97 | 1.0  | 1.03 | V             |
| $V_{IL}$                     | Low-level input voltage at the EN pin           |  | 0.87 | 0.9  | 0.93 | V             |
| $V_{PG}$                     | Power-good threshold                            | $V_{FB}$ rising, referenced to $V_{FB}$ nominal  | 93%  | 96%  | 99%  |               |
|                              |   | $V_{FB}$ falling, referenced to $V_{FB}$ nominal   | 89%  | 93%  | 96%  |               |
| $V_{PG\_HYS}$                | Power-good threshold hysteresis                 | Hysteresis   |      | 3%   |      |               |
| $t_{PG,DLY}$                 | Power-good delay time                           |  |      | 32   |      | $\mu\text{s}$ |
| $t_{PG,DLY}$                 | Power-good pulldown resistance                  |  |      | 10   |      | $\Omega$      |
| $V_{PG,OL}$                  | Low-level output voltage at the PG pin          | $I_{SINK} = 1\text{ mA}$   |      |      | 0.1  | V             |
| $I_{PG,LKG}$                 | Input leakage current into the PG pin           | $V_{PG} = 5\text{ V}$  |      | 0.01 | 1    | $\mu\text{A}$ |
| <b>POWER SWITCHES</b>        |   |  |      |      |      |               |
| $R_{DS,ON}$                  | High-side FET on resistance                     |  |      | 250  |      | m $\Omega$    |
|                              | Low-side FET on resistance                      |  |      | 85   |      |               |
| $I_{LIM}$                    | High-side FET current limit                     |  | 0.8  | 1.1  | 1.4  | A             |
|                              | Low-side FET current limit                      |  | 0.5  | 0.9  | 1.3  | A             |
| $I_{LIM;SINK}$               | Low-side FET sink current limit                 |  | 0.8  | 1    | 1.2  | A             |
| $T_{SD}$                     | Thermal shutdown threshold                      | $T_J$ rising   |      | 170  |      | °C            |
|                              | Thermal shutdown hysteresis                     | $T_J$ falling  |      | 20   |      |               |
| $f_{SW}$                     | Switching frequency                             | 2.5-MHz selection (FPWM mode)  |      | 2.5  |      | MHz           |
| $f_{SW}$                     | Switching frequency                             | 1.0-MHz selection (FPWM mode)  |      | 1.0  |      | MHz           |
| $T_{ON(MIN)}$                | Minimum on time                                 |  |      | 40   |      | ns            |
| $I_{LKG;SW}$                 | Leakage current into the SW pin                 | EN = 0 V, $V_{SW} = V_{OS} = 5.5\text{ V}$   |      | 0.1  | 5    | $\mu\text{A}$ |
| <b>OUTPUT</b>                |   |  |      |      |      |               |
| $V_O$                        | Output voltage regulation                       | VSET configuration selected, $0^\circ\text{C} \leq T_J \leq 85^\circ\text{C}$                  | -1%  |      | +1%  |               |

## 7.5 Electrical Characteristics (continued)

$V_{IN} = 3\text{ V to }17\text{ V}$ ,  $T_J = -40^\circ\text{C to }+150^\circ\text{C}$ , typical values at  $V_I = 12\text{ V}$  and  $T_A = 25^\circ\text{C}$ , unless otherwise noted

| PARAMETER          |                                       | TEST CONDITIONS  | MIN    | TYP  | MAX    | UNIT          |
|--------------------|---------------------------------------|--|--------|------|--------|---------------|
| $V_O$              | Output voltage regulation             | VSET configuration selected, $-40^\circ\text{C} \leq T_J \leq 150^\circ\text{C}$                         | -1.4%  |      | +1.1%  |               |
| $V_{FB}$           | Feedback regulation voltage           | Adjustable configuration selected  |        | 0.6  |        | V             |
| $V_{FB}$           | Feedback voltage regulation           | FB option selected, $0^\circ\text{C} \leq T_J \leq 85^\circ\text{C}$                                     | -0.75% |      | +0.75% |               |
| $V_{FB}$           | Feedback voltage regulation           | FB option selected, $-40^\circ\text{C} \leq T_J \leq 150^\circ\text{C}$                                  | -1.2%  |      | +0.75% |               |
| $I_{FB}$           | Input leakage current into the FB pin | Adjustable configuration, $V_{FB} = 0.6\text{ V}$  |        | 1    | 100    | nA            |
| $T_{\text{delay}}$ | Start-up delay time                   | $I_O = 0\text{ mA}$ , time from EN rising edge until start switching, external FB configuration selected |        | 700  | 1500   | $\mu\text{s}$ |
|                    | Start-up delay time                   | $I_O = 0\text{ mA}$ , time from EN rising edge until start switching, VSET configuration selected        |        | 1000 | 1800   | $\mu\text{s}$ |
| $T_{\text{SS}}$    | Soft-start time                       | $I_O = 0\text{ mA}$ after $T_{\text{delay}}$ , from first switching pulse until target $V_O$             |        | 600  | 700    | $\mu\text{s}$ |
| $R_{\text{DISCH}}$ | Active discharge resistance           | Discharge = ON - option selected, EN = LOW   |        | 7.5  | 20     | $\Omega$      |

## 7.6 Typical Characteristics

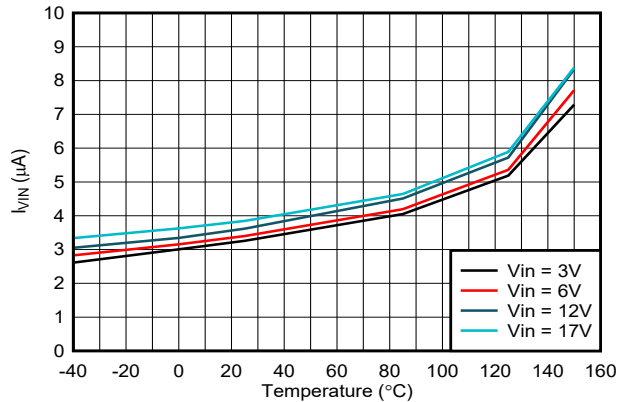

Measured with the device not switching

**7-1. Typical Quiescent Current vs Temperature**

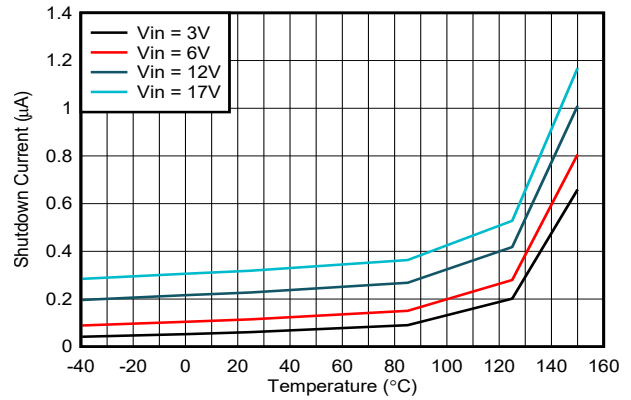

**7-2. Typical Shutdown Current vs Temperature**

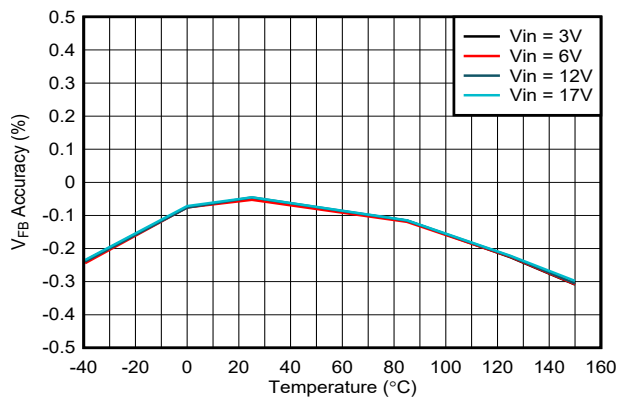

**7-3. Output Voltage Accuracy – External Feedback**

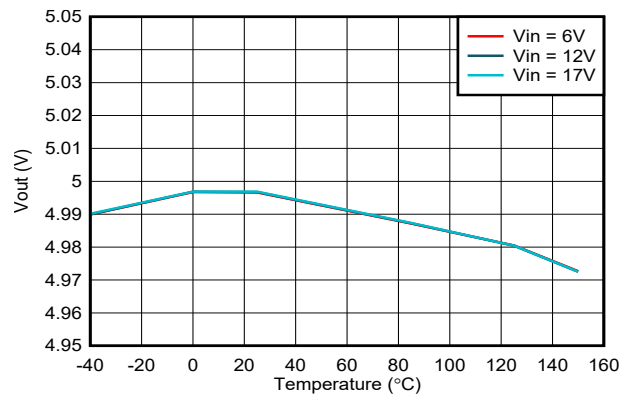

**7-4. Output Voltage Accuracy – VSET Selected**

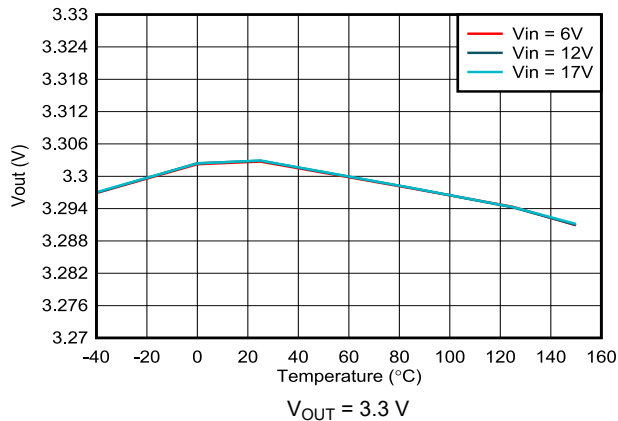

**7-5. Output Voltage Accuracy – VSET Selected**

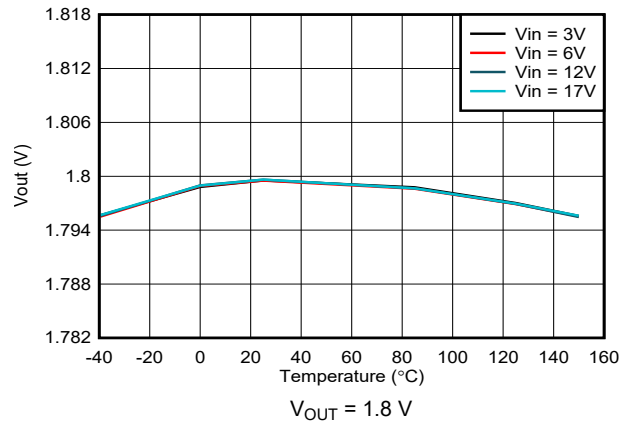

**7-6. Output Voltage Accuracy – VSET Selected**



## 7.6 Typical Characteristics (continued)

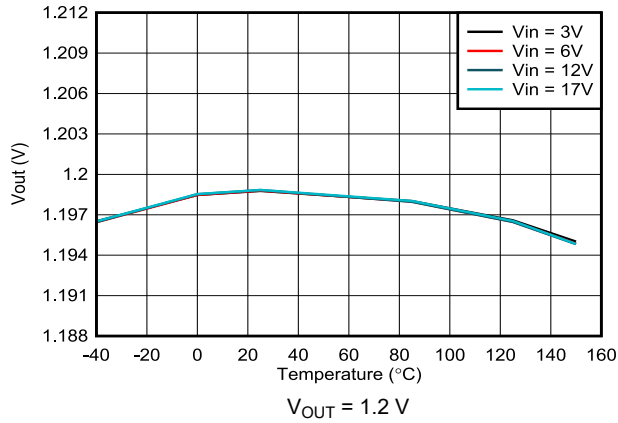

7-7. Output Voltage Accuracy – VSET Selected

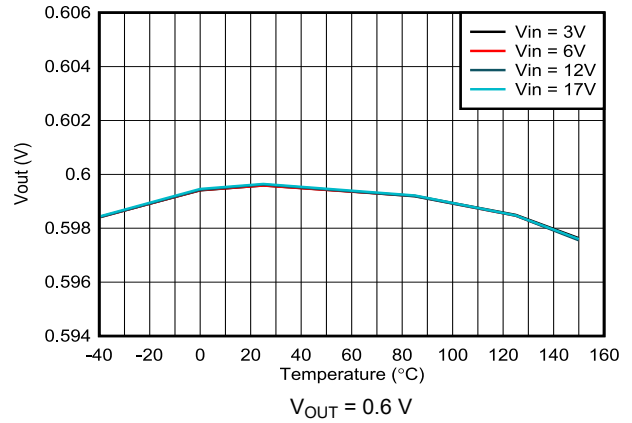

7-8. Output Voltage Accuracy – VSET Selected

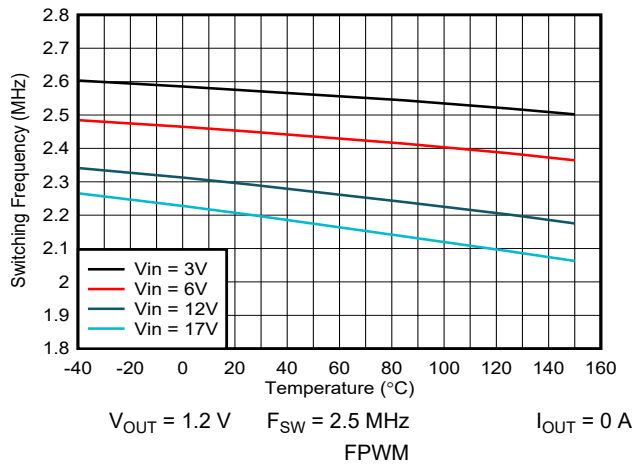

7-9. Switching Frequency vs Temperature

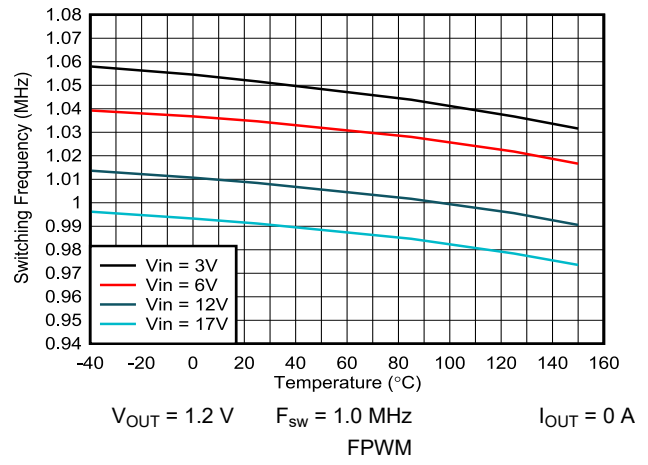

7-10. Switching Frequency vs Temperature

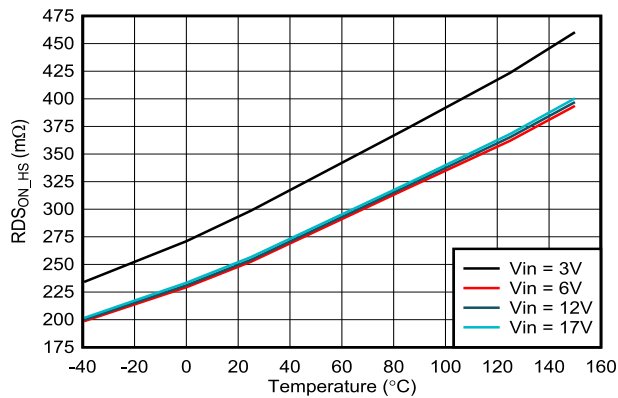

7-11. High-Side  $R_{DS(ON)}$  vs Temperature

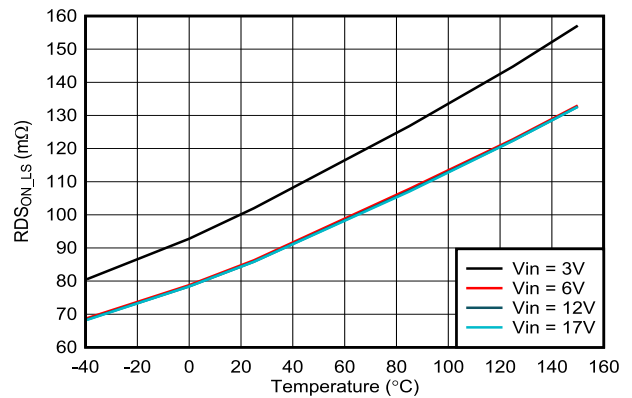

7-12. Low-Side  $R_{DS(ON)}$  vs Temperature

## 7.6 Typical Characteristics (continued)

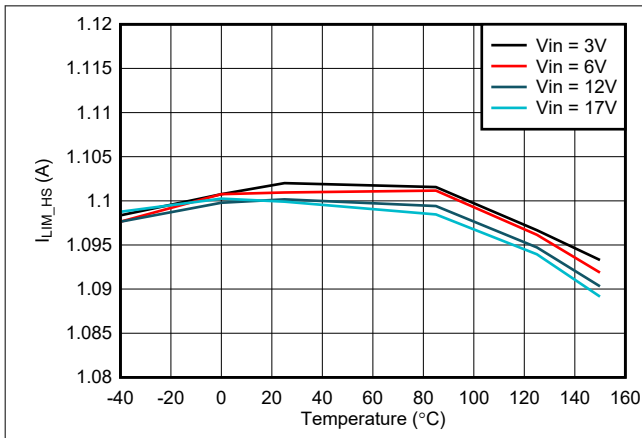

7-13. High-Side  $I_{LIM}$  vs Temperature

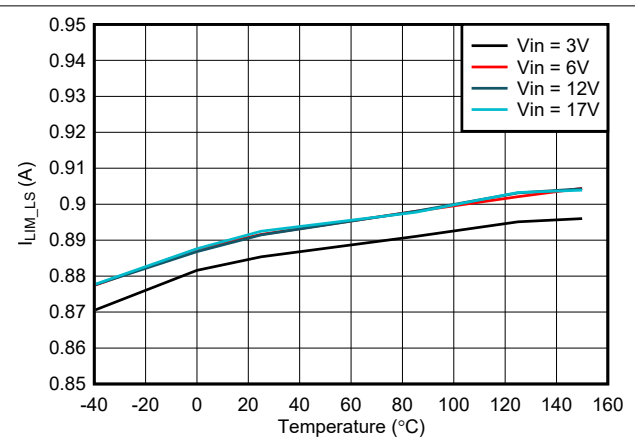

7-14. Low-Side  $I_{LIM}$  vs Temperature

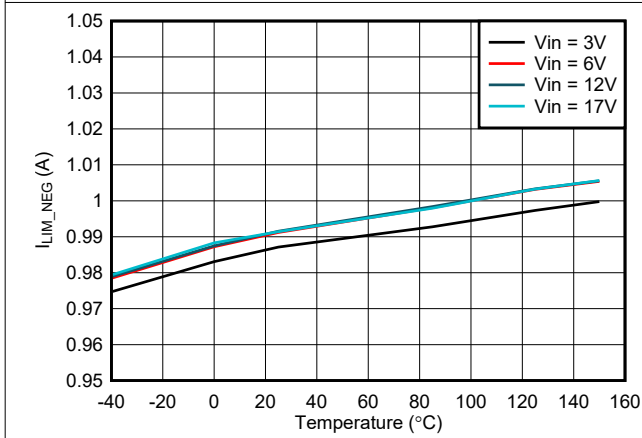

7-15. Low-Side  $I_{NEG}$  vs Temperature

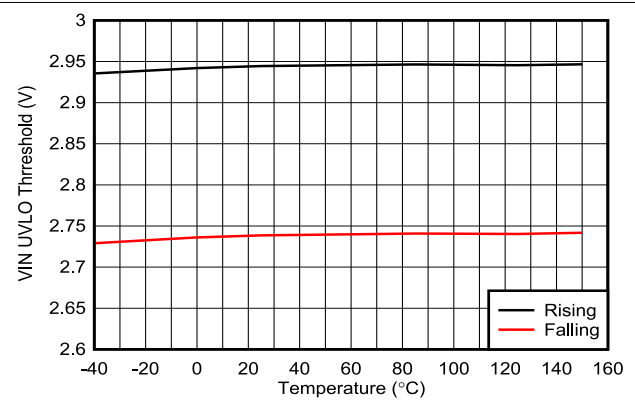

7-16.  $V_{IN}$  UVLO Thresholds vs Temperature

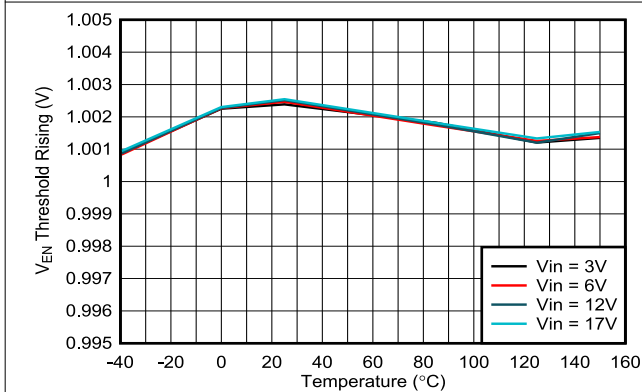

7-17. Precision Enable Threshold vs Temperature

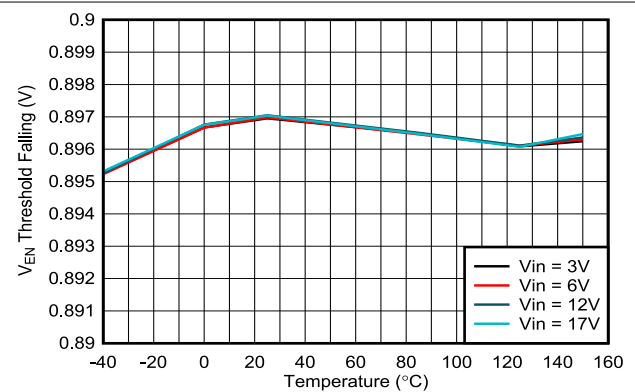

7-18. Precision Enable Threshold vs Temperature

## 8 Detailed Description

### 8.1 Overview

The TPS629203-Q1 synchronous switched mode power converter is based on DCS-Control (Direct Control with Seamless Transition into power save mode), an advanced regulation topology that combines the advantages of hysteretic, voltage mode, and current mode control. This control loop takes information about output voltage changes and feeds it directly to a fast comparator stage. It sets the switching frequency, which is constant for steady state operating conditions, and provides immediate response to dynamic load changes. To get accurate DC load regulation, a voltage feedback loop is used. The internally compensated regulation network achieves fast and stable operation with small external components and low-ESR capacitors.

### 8.2 Functional Block Diagram

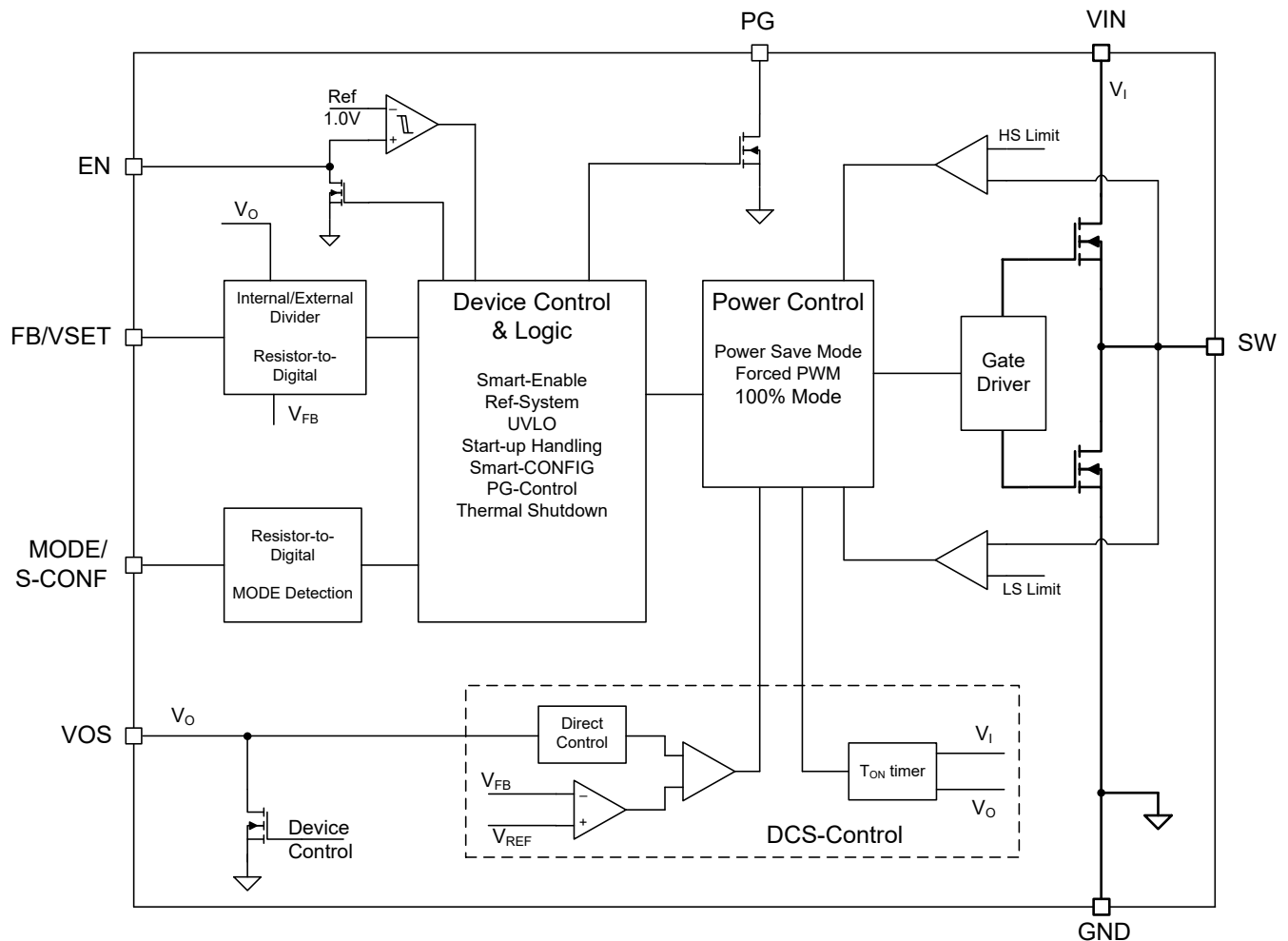

## 8.3 Feature Description

### 8.3.1 Mode Selection and Device Configuration (MODE/S-CONF Pin)

The MODE/S-CONF pin is an input with two functions. It can be used to customize the device behavior in two ways:

- Select the device mode (forced PWM or auto PFM/PWM operation) traditionally with a HIGH or LOW level.
- Select the device configuration (switching frequency, internal and external feedback, output discharge, and PFM/PWM mode) by connecting a single resistor to this pin.

The device interprets this pin during its start-up sequence after the internal OTP readout and before it starts switching in soft start. If the device reads a HIGH or LOW level, dynamic mode change is active and PFM/PWM mode can be changed during operation. If the device reads a resistor value, there is no further interpretation during operation and the device mode or other configurations cannot be changed afterward.



图 8-1. Interpretation of S-CONF and VSET Flow

表 8-1. Smart-CONFIG Setting Table

| #                                  | M ODE/S-CONF Level Or Resistor Value [ $\Omega$ ] <sup>(1)</sup> | FB/VSET Pin | F <sub>sw</sub> (MHz)    | Output Discharge | Mode (Auto Or Forced PWM) | Dynamic Mode Change |
|------------------------------------|--|-------------|--------------------------|------------------|---------------------------|---------------------|
| <b>Setting Options by Level</b>    |  |             |                          |                  |                           |                     |
| 1                                  | GND  | external FB | up to 2.5 <sup>(2)</sup> | yes              | Auto PFM/PWM with AEE     | Active              |
| 2                                  | HIGH (> 1.8 V)   | external FB | 2.5                      | yes              | Forced PWM                |                     |
| <b>Setting Options by Resistor</b> |  |             |                          |                  |                           |                     |
| 3                                  | 7.50 k   | external FB | up to 2.5 <sup>(2)</sup> | no               | Auto PFM/PWM with AEE     | not active          |
| 4                                  | 9.31 k   | external FB | 2.5                      | no               | Forced PWM                |                     |
| 5                                  | 11.50 k  | external FB | 1                        | yes              | Auto PFM/PWM              |                     |
| 6                                  | 14.30 k  | external FB | 1                        | yes              | Forced PWM                |                     |
| 7                                  | 17.80 k  | external FB | 1                        | no               | Auto PFM/PWM              |                     |
| 8                                  | 22.10 k  | external FB | 1                        | no               | Forced PWM                |                     |
| 9                                  | 27.40 k  | VSET        | up to 2.5 <sup>(2)</sup> | yes              | Auto PFM/PWM with AEE     |                     |
| 10                                 | 34.00 k  | VSET        | 2.5                      | yes              | Forced PWM                |                     |
| 11                                 | 42.20 k  | VSET        | up to 2.5 <sup>(2)</sup> | no               | Auto PFM/PWM with AEE     |                     |
| 12                                 | 52.30 k  | VSET        | 2.5                      | no               | Forced PWM                |                     |
| 13                                 | 64.90 k  | VSET        | 1                        | yes              | Auto PFM/PWM              |                     |
| 14                                 | 80.60 k  | VSET        | 1                        | yes              | Forced PWM                |                     |
| 15                                 | 100.00 k   | VSET        | 1                        | no               | Auto PFM/PWM              |                     |
| 16                                 | 124.00 k   | VSET        | 1                        | no               | Forced PWM                |                     |

(1) E96 Resistor Series, 1% accuracy, temperature coefficient better or equal than  $\pm 200$  ppm/ $^{\circ}$ C

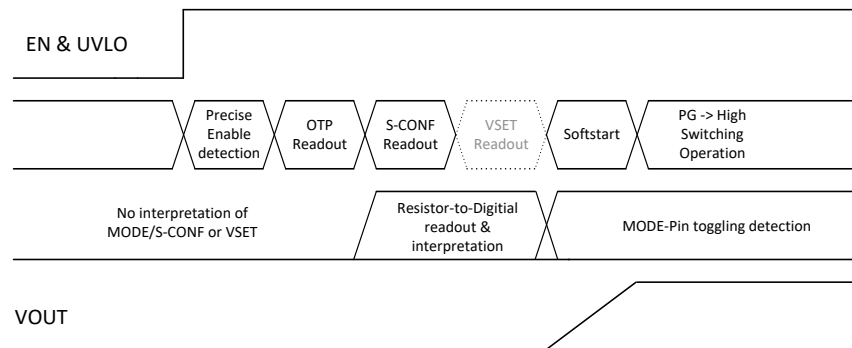
(2) F<sub>sw</sub> varies based on V<sub>IN</sub> and V<sub>OUT</sub>. See [セクション 8.4.3](#) for more details.

### 8.3.2 Adjustable $V_O$ Operation (External Voltage Divider)

If the device is configured to operate in classical adjustable  $V_O$  operation, the FB/VSET pin is used as the feedback pin and needs to sense  $V_O$  through an external divider network. [Figure 8-2](#) shows the typical schematic for this configuration.

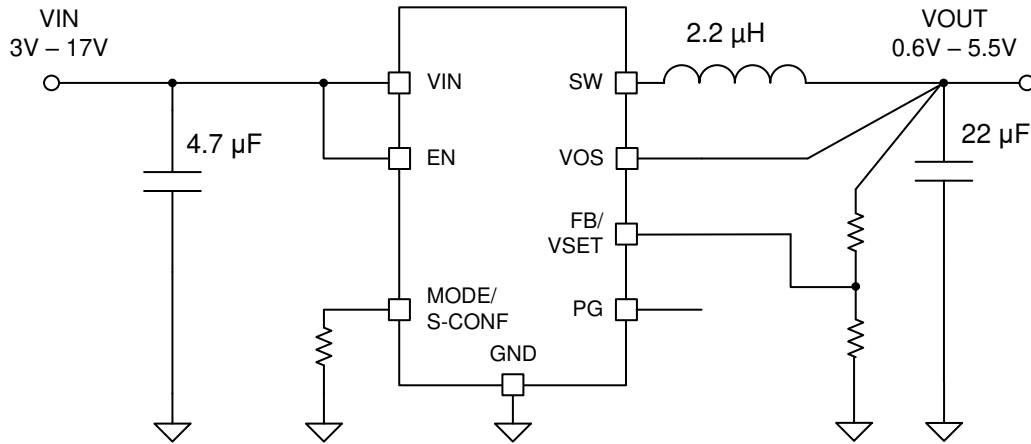
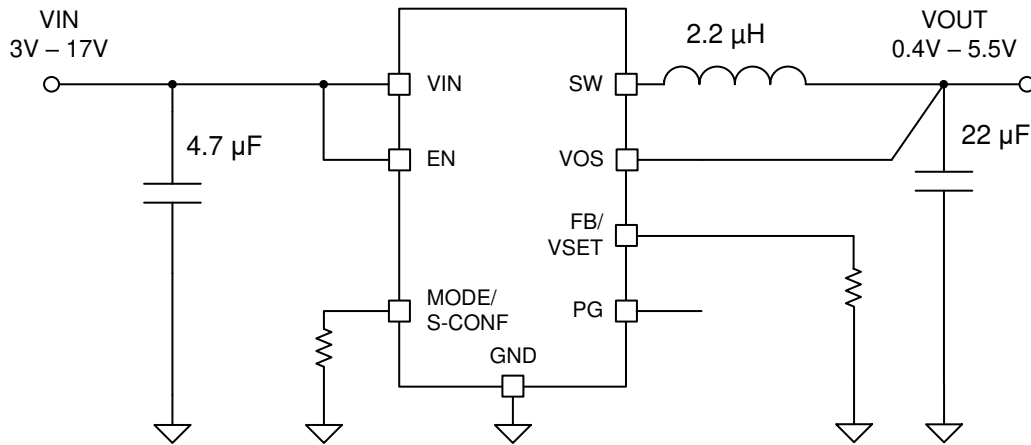

**Figure 8-2. Adjustable  $V_O$  Operation Schematic**

### 8.3.3 Selectable $V_O$ Operation (VSET and Internal Voltage Divider)

If the device is configured to VSET operation, the device interprets the VSET pin value following the MODE/S-CONF readout (see [Figure 8-3](#)). There is no further interpretation of the VSET pin during operation and the output voltage cannot be changed afterward without toggling the EN pin.

[Figure 8-3](#) shows the typical schematic for this configuration, where  $V_O$  is directly sensed at the VOS pin of the device.  $V_O$  is sensed only through the VOS pin by an internal resistor divider. The target  $V_O$  is programmed by an external resistor connected between VSET and GND (see [Table 8-2](#)).



**Figure 8-3. Selectable  $V_O$  Operation Schematic**

**表 8-2. VSET Selection Table**

| VSET # | Resistor Value [ $\Omega$ ] <sup>(1)</sup> | Target V <sub>O</sub> [V] |
|--------|--|---------------------------|
| 1      | GND  | 1.2                       |
| 2      | 4.87 k                                     | 0.4                       |
| 3      | 6.04 k                                     | 0.6                       |
| 4      | 7.50 k                                     | 0.8                       |
| 5      | 9.31 k                                     | 0.85                      |
| 6      | 11.50 k                                    | 1.0                       |
| 7      | 14.30 k                                    | 1.1                       |
| 8      | 17.80 k                                    | 1.25                      |
| 9      | 22.10 k                                    | 1.3                       |
| 10     | 27.40 k                                    | 1.35                      |
| 11     | 34.00 k                                    | 1.8                       |
| 12     | 42.20 k                                    | 1.9                       |
| 13     | 52.30 k                                    | 2.5                       |
| 14     | 64.90 k                                    | 3.8                       |
| 15     | 80.60 k                                    | 5.0                       |
| 16     | 100.00 k                                   | 5.1                       |
| 17     | 124.00 k                                   | 5.5                       |
| 18     | 249.00 k or larger/open                    | 3.3                       |

(1) E96 Resistor Series, 1% accuracy, temperature coefficient better or equal to  $\pm 200$  ppm/ $^{\circ}$ C

### 8.3.4 Smart Enable with Precise Threshold

The voltage applied at the EN pin of the TPS629203-Q1 is compared to a fixed threshold rising voltage. This allows the user to drive the pin by a slowly changing voltage and enables the use of an external RC network to achieve a power-up delay.

The precise enable input allows the use of a user-programmable undervoltage lockout by adding a resistor divider to the input of the EN pin.

The enable input threshold for a falling edge is lower than the rising edge threshold. The TPS629203-Q1 starts operation when the rising threshold is exceeded. For proper operation, the EN pin must be terminated and must not be left floating. Pulling the EN pin low forces the device into shutdown. In this mode, the internal high-side and low-side MOSFETs are turned off and the entire internal control circuitry is switched off.

An internal resistor pulls the EN pin to GND and avoids the pin to be floating. This prevents an uncontrolled start-up of the device in case the EN pin cannot be driven to a low level safely. With EN low, the device is in shutdown mode. The device is turned on with EN set to a high level. The pulldown control circuit disconnects the pulldown resistor on the EN pin once the internal control logic and the reference have been powered up. With EN set to a low level, the device enters shutdown mode and the pulldown resistor is activated again.

### 8.3.5 Power Good (PG)

The TPS629203-Q1 has a built-in power-good (PG) feature to indicate whether the output voltage has reached its target and the device is ready. The PG signal can be used for start-up sequencing of multiple rails. The PG pin is an open-drain output that requires a pullup resistor to any voltage up to the recommended input voltage level. PG is low when the device is turned off due to EN, UVLO (undervoltage lockout), or thermal shutdown.  $V_{IN}$  must remain present for the PG pin to stay low.

If the power-good output is not used, it is recommended to tie to GND or leave open.

**表 8-3. Power-Good Indicator Functional Table**

| Logic Signals            |        |                  |                 | PG Status             |
|--------------------------|--------|------------------|-----------------|-----------------------|
| $V_I$                    | EN Pin | Thermal Shutdown | $V_O$           |                       |
| $V_{VIN} > UVLO$         | HIGH   | No               | $V_O$ on target | <b>High Impedance</b> |
|                          |        |                  | $V_O < target$  | <b>LOW</b>            |
|                          |        | Yes              | x               | <b>LOW</b>            |
|                          | LOW    | x                | x               | <b>LOW</b>            |
| $1.8 V < V_{VIN} < UVLO$ | x      | x                | x               | <b>LOW</b>            |
| $V_I < 1.8 V$            | x      | x                | x               | <b>Undefined</b>      |

### 8.3.6 Output Discharge Function

The purpose of the discharge function is to make sure there is a defined down-ramp of the output voltage when the device is being disabled but also to keep the output voltage close to 0 V when the device is off. The output discharge feature is only active once the TPS629203-Q1 has been enabled at least once since the supply voltage was applied. The internal discharge resistor is connected to the VOS pin. The discharge function is enabled as soon as the device is disabled (EN pin = low), in thermal shutdown, or in undervoltage lockout. The minimum supply voltage required for the discharge function to remain active typically is 2 V.

### 8.3.7 Undervoltage Lockout (UVLO)

If the input voltage drops, the undervoltage lockout prevents mis-operation of the device by switching off both the power FETs. The device is fully operational for voltages above the rising UVLO threshold and turns off if the input voltage trips below the threshold for a falling supply voltage.

### 8.3.8 Current Limit and Short Circuit Protection

The TPS629203-Q1 is protected against overload and short circuit events. If the inductor current exceeds the current limit,  $I_{LIM\_HS}$ , the high-side switch is turned off and the low-side switch is turned on to ramp down the inductor current. The high-side FET turns on again only if the current in the low-side FET has decreased below the low-side current limit threshold,  $I_{LIM\_LS}$ .

Due to internal propagation delay, the actual current can exceed the static current limit during that time. The dynamic current limit is given in 式 1.

$$I_{peak(typ)} = I_{LIMH} + \frac{V_L}{L} \times t_{PD} \quad (1)$$

where:

- $I_{LIMH}$  is the static current limit as specified in the electrical characteristics.
- $L$  is the effective inductance at the peak current.
- $V_L$  is the voltage across the inductor ( $V_{IN} - V_{OUT}$ ).
- $t_{PD}$  is the internal propagation delay of typically 50 ns.

The current limit can exceed static values, especially if the input voltage is high and very small inductances are used. The dynamic high-side switch peak current can be calculated as follows:

$$I_{peak(typ)} = I_{LIMH} + \frac{V_{IN} - V_{OUT}}{L} \times 50 \text{ ns} \quad (2)$$

The TPS629203-Q1 also includes a low-side negative current limit ( $I_{LIM:SINK}$ ) to protect against excessive negative currents that can occur in forced PWM mode under heavy to light load transient conditions. If the negative current in the low-side switch exceeds the  $I_{LIM:SINK}$  threshold, the low-side switch is disabled. Both the low-side and high-side switches remain off until an internal timer re-enables the high-side switch based on the selected PWM switching frequency.

#### CAUTION

It is recommended that the inductor be sized such that the inductor ripple current,  $\Delta I_L$  (see [式 9](#)), does not exceed 1.6 A to avoid the potential for continuous operation of the negative current limit with no output load ( $I_O = 0 \text{ A}$ ).

### 8.3.9 Thermal Shutdown

The junction temperature of the device,  $T_J$ , is monitored by an internal temperature sensor. If  $T_J$  rises and exceeds the thermal shutdown threshold,  $T_{SD}$ , the device shuts down. Both the high-side and low-side power FETs are turned off and PG goes low. When  $T_J$  decreases below the hysteresis, the converter resumes normal operation, beginning with soft start. During a PFM skip pause, the thermal shutdown feature is not active. A shutdown or restart is only triggered during a switching cycle. See [セクション 8.4.2](#).

## 8.4 Device Functional Modes

### 8.4.1 Forced Pulse Width Modulation (PWM) Operation

The TPS629203-Q1 has two operating modes: forced PWM mode discussed in this section and auto PFM/PWM mode as discussed in [セクション 8.4.2](#).

With the MODE/S-CONF pin set to forced PWM mode, the device operates with pulse width modulation in continuous conduction mode (CCM) with a nominal switching frequency of either 1.0 MHz or 2.5 MHz. The frequency variation in PWM is controlled and depends on  $V_{IN}$ ,  $V_{OUT}$ , and the inductance. The on time in forced PWM mode is given by [式 3](#).

$$TON = \frac{V_{OUT}}{V_{IN}} \times \frac{1}{f_{sw}} \quad (3)$$

For very small output voltages, an absolute minimum on time of about 40 ns is kept to limit switching losses. The operating frequency is thereby reduced from its nominal value, which keeps efficiency high.



### 8.4.2 Power Save Mode Operation (Auto PFM/PWM)

When the MODE/S-CONF pin is configured for auto PFM/PWM mode, power save mode is allowed. The device operates in PWM mode as long the output current is higher than half the ripple current of the inductor. To maintain high efficiency at light loads, the device enters power save mode at the boundary to discontinuous conduction mode (DCM). This happens if the output current becomes smaller than half the ripple current of the inductor. Power save mode is entered seamlessly to make sure there is high efficiency in light-load operation. The device remains in power save mode as long as the inductor current is discontinuous.

In power save mode, the switching frequency decreases linearly with the load current maintaining high efficiency. The transition into and out of power save mode is seamless in both directions.

The TPS629203-Q1 adjusts the on time (TON) in power save mode, depending on the input voltage and the output voltage to maintain highest efficiency. The on time in steady-state operation can be estimated as:

With the MODE/S-CONF pin set to 1.0-MHz operation:

$$TON (\mu s) = \frac{V_{OUT}}{V_{IN}} \quad (4)$$

With the MODE/S-CONF pin set to 2.5-MHz operation:

$$TON = 100 \times \frac{V_{IN}}{V_{IN} - V_{OUT}} [ns] \quad (5)$$

Using TON, the typical peak inductor current in power save mode is approximated by:

$$ILPSM_{(peak)} = \frac{(V_{IN} - V_{OUT})}{L} \times TON \quad (6)$$

The output voltage ripple in power save mode is given by 式 7:

$$\Delta V = \frac{L \times V_{IN}^2}{200 \times C} \left( \frac{1}{V_{IN} - V_{OUT}} + \frac{1}{V_{OUT}} \right) \quad (7)$$

---

#### Note

When  $V_{IN}$  decreases to typically 15% above  $V_{OUT}$ , the device will not enter power save mode regardless of the load current. The device maintains output regulation in PWM mode.

---

### 8.4.3 AEE (Automatic Efficiency Enhancement)

When the MODE/S-CONF pin is configured for auto PFM/PWM with AEE mode, the TPS629203-Q1 provides the highest efficiency over the entire input voltage and output voltage range by automatically adjusting the switching frequency of the converter (see 式 8). To keep the efficiency high over the entire duty cycle range, the switching frequency is adjusted while maintaining the ripple current amplitudes. This feature compensates for the very small duty cycles of high  $V_{IN}$  to low  $V_{OUT}$  conversions, which can limit the control range in other topologies.

$$F_{sw} (MHz) = 10 \times V_{OUT} \times \frac{V_{IN} - V_{OUT}}{V_{IN}^2} \quad (8)$$

Traditionally, the efficiency of a switched mode converter decreases if  $V_{OUT}$  decreases,  $V_{IN}$  increases, or both. By decreasing the switching losses at lower  $V_{OUT}$  values or higher  $V_{IN}$  values, the AEE feature provides an efficiency enhancement across various duty cycles, especially for the lower  $V_{OUT}$  values, where fixed frequency converters suffer from a significant efficiency drop. Furthermore, when used with the recommended 2.2- $\mu$ H

inductor, the ripple current amplitudes remains low enough to deliver the full output current without reaching current limit across the entire range of input and output voltages (see [Figure 8-4](#)).

By using the same TON configuration (see [Equation 9](#)) across the entire load range in AEE mode, the inductor ripple current in AEE mode becomes effectively independent of the output voltage and can be approximated by [Equation 9](#):

$$\Delta I_L \text{ (mA)} = TON \times \frac{(VIN - VOUT)}{L} = 0.1 \times \frac{VIN \text{ (V)}}{L \text{ (\mu H)}} \quad (9)$$

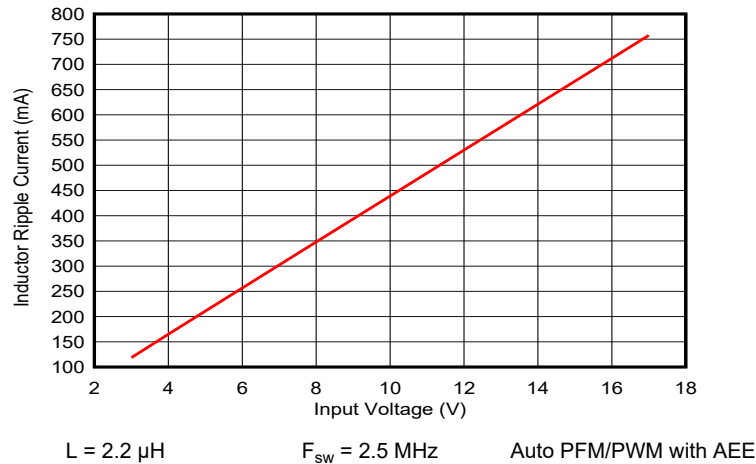

**Figure 8-4. Typical Inductor Ripple Current Versus Input Voltage in AEE Mode**

The TPS629203-Q1 operates in AEE mode as long as the output current is higher than half the ripple current of the inductor. To maintain high efficiency at light loads, the device enters power save mode at the boundary to discontinuous mode (DCM), which happens when the output current becomes smaller than half the inductor ripple current.

#### 8.4.4 100% Duty-Cycle Operation

The duty cycle of the buck converter operated in PWM mode is given in [Equation 10](#).

$$D = \frac{VOUT}{VIN} \quad (10)$$

The duty cycle increases as the input voltage comes close to the output voltage and the off time of the high-side switch gets smaller. When the minimum off time of typically 80 ns is reached, the TPS629203-Q1 scales down its switching frequency while it approaches 100% mode. In 100% mode, the device keeps the high-side switch on continuously as long as the output voltage is below the internal set point. This allows the conversion of small input to output voltage differences. For example, getting the longest operation time of battery-powered applications. In 100% duty cycle mode, the low-side FET is switched off.

The minimum input voltage to maintain output voltage regulation, depending on the load current and the output voltage level, can be calculated as:

$$VIN_{(min)} = VOUT + IOUT(R_{DS(on)} + RL) \quad (11)$$

where:

- I<sub>OUT</sub> is the output current.
- R<sub>DS(on)</sub> is the on-state resistance of the high-side FET.
- R<sub>L</sub> is the DC resistance of the inductor used.

#### 8.4.5 Starting into a Prebiased Load

The TPS629203-Q1 is capable of starting into a prebiased output. The device only starts switching when the internal soft-start ramp is equal or higher than the feedback voltage. If the voltage at the feedback pin is biased to a higher voltage than the nominal value, the TPS629203-Q1 does not start switching unless the voltage at the feedback pin drops to the target. Performance is the same for devices configured for VSET operation (internal feedback), however, the switching will be delayed until the soft-start ramp reaches the internal feedback voltage.

## 9 Application and Implementation

### Note

Information in the following applications sections is not part of the TI component specification, and TI does not warrant its accuracy or completeness. TI's customers are responsible for determining suitability of components for their purposes. Customers should validate and test their design implementation to confirm system functionality.

### 9.1 Application Information

The TPS629203-Q1 device is a highly efficient, small, and highly-flexible synchronous step-down DC-DC converter that is easy to use. A wide input voltage range of 3 V to 17 V supports a wide variety of inputs like 12-V supply rails, single-cell or multi-cell Li-Ion, and 5-V or 3.3-V rails.

### 9.2 Typical Application



图 9-1. Typical Application Setup

表 9-1. List of Components

| Reference | Description  | Manufacturer                    |
|-----------|--|---------------------------------|
| IC        | 17-V, 0.3-A Step-Down Converter                                | TPS629203-Q1; Texas Instruments |
| L1        | 2.2-µH inductor  | XGL3530-222; Coilcraft          |
| C1        | 4.7 µF, 25 V, Ceramic, 1206                                    | CGA5L1X7R1E475K160AC, TDK       |
| C2        | 22 µF, 6.3 V, Ceramic, 0805                                    | GCM21BD70J226ME36L, MuRata      |
| R1        | Depending on $V_{OUT}$ ; see <a href="#">セクション 9.2.2.2</a> .   | Standard 1% metal film          |
| R2        | Depending on $V_{OUT}$ ; see <a href="#">セクション 9.2.2.2</a> .   | Standard 1% metal film          |
| R3        | Depending on device setting, see <a href="#">セクション 8.3.1</a> . | Standard 1% metal film          |

## 9.2.1 Design Requirements

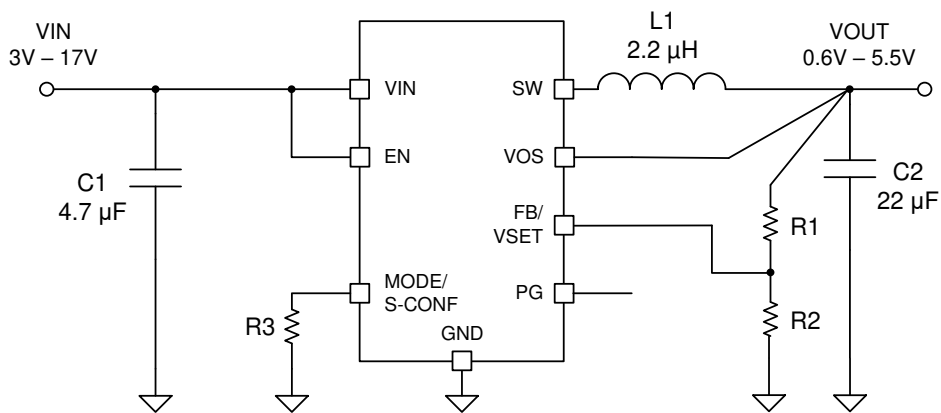
The design guidelines provide a component selection to operate the device within the recommended operating conditions.

## 9.2.2 Detailed Design Procedure

### 9.2.2.1 Custom Design With WEBENCH® Tools

[Click here](#) to create a custom design using the TPS629203-Q1 device with the WEBENCH® Power Designer.

1. Start by entering the input voltage ( $V_{IN}$ ), output voltage ( $V_{OUT}$ ), and output current ( $I_{OUT}$ ) requirements.
2. Optimize the design for key parameters such as efficiency, footprint, and cost using the optimizer dial.
3. Compare the generated design with other possible solutions from Texas Instruments.

The WEBENCH Power Designer provides a customized schematic along with a list of materials with real-time pricing and component availability.

In most cases, these actions are available:

- Run electrical simulations to see important waveforms and circuit performance
- Run thermal simulations to understand board thermal performance
- Export customized schematic and layout into popular CAD formats
- Print PDF reports for the design, and share the design with colleagues

Get more information about WEBENCH tools at [www.ti.com/WEBENCH](http://www.ti.com/WEBENCH).

### 9.2.2.2 Programming the Output Voltage

The output voltage of the TPS629203-Q1 is adjustable. It can be programmed for output voltages from 0.6 V to 5.5 V, using a resistor divider from  $V_{OUT}$  to GND. The voltage at the FB pin is regulated to 600 mV. The value of the output voltage is set by the selection of the resistor divider from [表 9-2](#). It is recommended to choose resistor values that allow a current of at least 2  $\mu$ A, meaning the value of R2 should not exceed 300 k $\Omega$ . Lower resistor values are recommended for highest accuracy and most robust design.

$$R_1 = R_2 \times \left( \frac{V_{OUT}}{V_{FB}} - 1 \right) \quad (12)$$

where

- $V_{FB}$  is 0.6 V.

**表 9-2. Setting the Output Voltage**

| Nominal Output Voltage | R1             | R2              | Exact Output Voltage |
|------------------------|----------------|-----------------|----------------------|
| 0.8 V                  | 51 k $\Omega$  | 150 k $\Omega$  | 0.804 V              |
| 1.2 V                  | 130 k $\Omega$ | 130 k $\Omega$  | 1.200 V              |
| 1.5 V                  | 150 k $\Omega$ | 100 k $\Omega$  | 1.500 V              |
| 1.8 V                  | 475 k $\Omega$ | 237 k $\Omega$  | 1.803 V              |
| 2.5 V                  | 523 k $\Omega$ | 165 k $\Omega$  | 2.502 V              |
| 3.3 V                  | 619 k $\Omega$ | 137 k $\Omega$  | 3.311 V              |
| 5 V                    | 619 k $\Omega$ | 84.5 k $\Omega$ | 4.995 V              |

### 9.2.2.3 External Component Selection

The external components have to fulfill the needs of the application, but also the stability criteria of the control loop of the device. The TPS629203-Q1 is optimized to work within a range of external components.

### 9.2.2.3.1 Output Filter and Loop Stability

The TPS629203-Q1 is internally compensated to be stable with a range of LC filter combinations. The LC output filters inductance and capacitance have to be considered together, creating a double pole, responsible for the corner frequency of the converter using 式 13.

$$f_{LC} = \frac{1}{2\pi\sqrt{L \cdot C}} \quad (13)$$

表 9-3 can be used to simplify the output filter component selection. The values in 表 9-3 are nominal values, and the effective capacitance was considered to be +20% and –50%. Different values can work, but care has to be taken on the loop stability which is affected. More information on the sizing of the LC filter of a DCS-Control regulator can be found in the [Optimizing the TPS62130/40/50/60 Output Filter Application Note](#).

**表 9-3. Recommended LC Output Filter Combinations**

|                         | 4.7 μF | 10 μF | 22 μF            | 47 μF            | 100 μF           | 200 μF           |
|-------------------------|--------|-------|------------------|------------------|------------------|------------------|
| 1 μH <sup>(3) (4)</sup> |        |       | √                | √                | √                | √ <sup>(2)</sup> |
| 1.5 μH                  |        | √     | √                | √                | √ <sup>(2)</sup> |                  |
| 2.2 μH                  |        | √     | √ <sup>(1)</sup> | √                | √ <sup>(2)</sup> |                  |
| 3.3 μH                  | √      | √     | √                | √                |                  |                  |
| 4.7 μH                  | √      | √     | √                | √ <sup>(2)</sup> |                  |                  |

- (1) This LC combination is the standard value and recommended for most applications.
- (2) Output capacitance needs to have an ESR of ≥ 10 mΩ for stable operation. See [セクション 9.3.1](#).
- (3) Not recommended for 1-MHz operation
- (4) At full load,  $I_{Lpeak}$  can exceed  $I_{LIM\_HS}$  at higher input or output voltages.

Although the TPS629203-Q1 is stable without the pole and zero being in a particular location, an external feedforward capacitor can also be added to adjust their location based on the specific needs of the application. This can provide better performance in power save mode, improved transient response, or both.

A more detailed discussion on the optimization for stability versus transient response can be found in the [Optimizing Transient Response of Internally Compensated DC-DC Converters Application Note](#) and [Feedforward Capacitor to Improve Stability and Bandwidth of TPS621/821-Family Application Note](#).

### 9.2.2.3.2 Inductor Selection

The TPS629203-Q1 is designed for a nominal 2.2-μH inductor. Larger values can be used to achieve a lower inductor current ripple but they can have a negative impact on efficiency and transient response. Smaller values than 2.2 μH cause larger inductor current ripple, which cause larger negative inductor currents in forced PWM mode and higher peak currents at full load. Therefore, they are not recommended at larger voltages across the inductor as it is the case for high input voltages and low output voltages. With low output current in forced PWM mode, this causes a larger negative inductor current peak that can exceed the negative current limit. At low or no output current and small inductor values, the output voltage can therefore not be regulated any more. More detailed information on further LC combinations can be found in the [Optimizing the TPS62130/40/50/60 Output Filter Application Note](#).

The inductor selection is affected by several effects like the following:

- Inductor ripple current
- Output ripple voltage
- PWM-to-PFM transition point
- Efficiency

In addition, the inductor selected has to be rated for appropriate saturation current and DC resistance (DCR). 式 14 calculates the maximum inductor current.

$$I_{L(\max)} = I_{OUT(\max)} + \frac{\Delta I_{L(\max)}}{2} \quad (14)$$

$$\Delta I_{L(\max)} = \frac{VIN(\max)}{L(\min)} \times 100ns \quad (15)$$

where:

- $I_L(\max)$  is the maximum inductor current.
- $\Delta I_L$  is the peak-to-peak inductor ripple current.
- $L(\min)$  is the minimum effective inductor value.

Calculating the maximum inductor current using the actual operating conditions gives the minimum saturation current of the inductor needed. It is recommended to add a margin of about 20%. A larger inductor value is also useful to get lower ripple current, but increases the transient response time and size as well. The following inductors have been used with the TPS629203-Q1 and are recommended for use:

**表 9-4. List of Inductors**

| Type                            | Inductance [ $\mu$ H]   | DCR [ $m\Omega$ ] | Current [A] <sup>(1)</sup> | Dimensions [L×W×H] mm | Manufacturer |
|---------------------------------|-------------------------|-------------------|----------------------------|-----------------------|--------------|
| DFE252012PD-2R2M <sup>(2)</sup> | 2.2 $\mu$ H, $\pm 20\%$ | 84                | 2.8                        | 2.5 × 2.0 × 1.2       | muRata       |
| XGL3530-222ME                   | 2.2 $\mu$ H, $\pm 20\%$ | 20                | 4.0                        | 3.5 × 3.2 × 3         | Coilcraft    |
| XGL4020-222ME                   | 2.2 $\mu$ H, $\pm 20\%$ | 19.5              | 6.2                        | 4 × 4 × 2.1           | Coilcraft    |
| XGL3530-332ME                   | 3.3 $\mu$ H, $\pm 20\%$ | 33                | 3.3                        | 3.5 × 3.2 × 3         | Coilcraft    |
| XGL4020-472ME                   | 4.7 $\mu$ H, $\pm 20\%$ | 43                | 4.1                        | 4 × 4 × 2.1           | Coilcraft    |

(1)  $I_{SAT}$  at 30% drop

(2) For smaller size solutions that do not require maximum efficiency at the full output current

The inductor value also determines the load current at which power save mode is entered:

$$I_{load(PSM)} = \frac{1}{2} \Delta I_L \quad (16)$$

### 9.2.2.3.3 Capacitor Selection

#### 9.2.2.3.3.1 Output Capacitor

The recommended value for the output capacitor is 22  $\mu$ F. The architecture of the TPS629203-Q1 allows the use of tiny ceramic output capacitors with low equivalent series resistance (ESR). These capacitors provide low output voltage ripple and are recommended. To keep its low resistance up to high frequencies and to get narrow capacitance variation with temperature, it is recommended to use X7R or X5R dielectric. Using a higher value has advantages like smaller voltage ripple and a tighter DC output accuracy in power save mode (see [Optimizing the TPS62130/40/50/60 Output Filter Application Note](#) for more information).

In power save mode, the output voltage ripple depends on the following:

- Output capacitance
- ESR
- ESL
- Peak inductor current

Using ceramic capacitors provides small ESR, ESL, and low ripple.

The output capacitor needs to be as close as possible to the device, and it is recommended to have the VOS signal and feedback resistors (if used) should be connected to the positive terminal of the output capacitor.

For large output voltages, the DC bias effect of ceramic capacitors is large and the effective capacitance has to be observed.

### 9.2.2.3.3.2 Input Capacitor

For most applications, 4.7- $\mu$ F nominal is sufficient and is recommended, though a larger value reduces input current ripple further. The input capacitor buffers the input voltage for transient events and also decouples the converter from the supply. A low-ESR multilayer ceramic capacitor (MLCC) is recommended for best filtering and should be placed between VIN and GND as close as possible to those pins.

**表 9-5. List of Capacitors**

| Type                 | Nominal Capacitance [ $\mu$ F] | Voltage Rating [V] | Size                | Manufacturer |
|----------------------|--------------------------------|--------------------|---------------------|--------------|
| CGA5L1X7R1E475K160AC | 4.7                            | 25                 | 1206 <sup>(1)</sup> | TDK          |
| CGA5L1X7R1E106K160AC | 10                             | 25                 | 1206 <sup>(1)</sup> | TDK          |

(1) Smaller (0805 or 0603) options may be used and are available from various manufacturers.



### 9.2.3 Application Curves

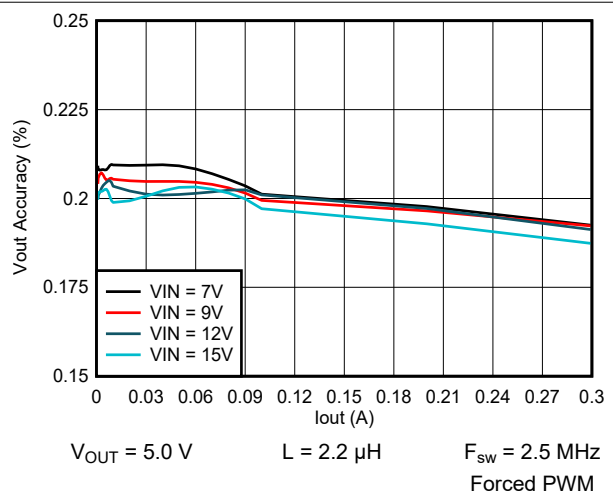
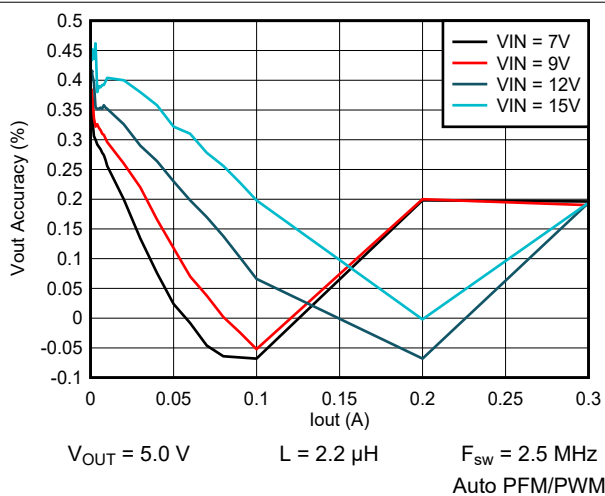
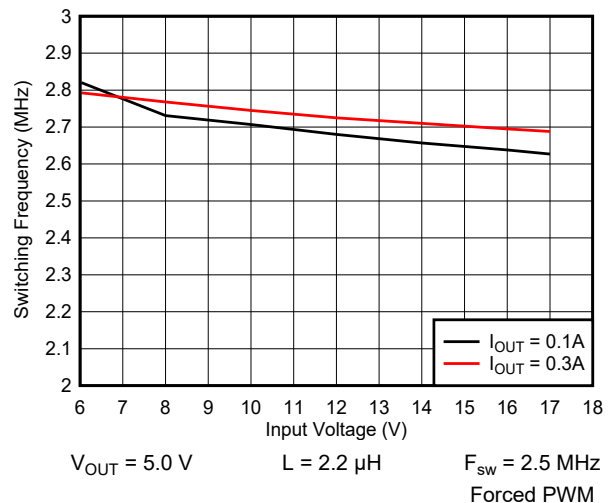
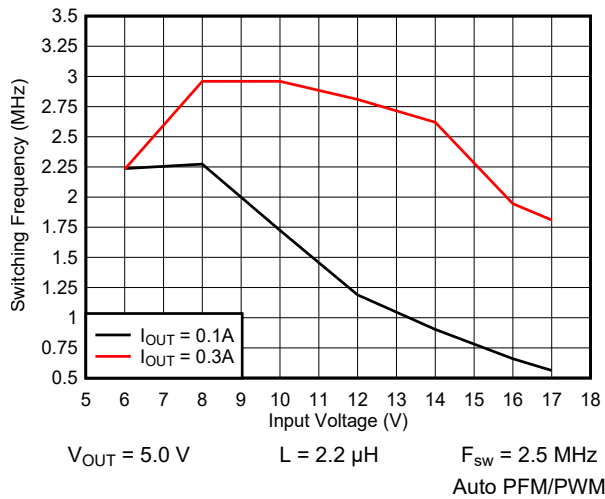
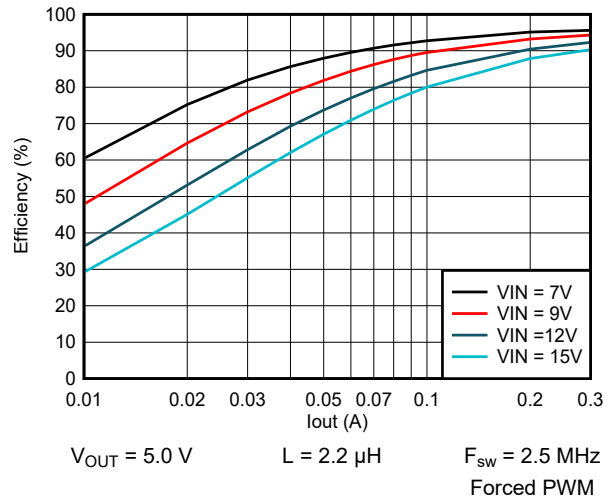
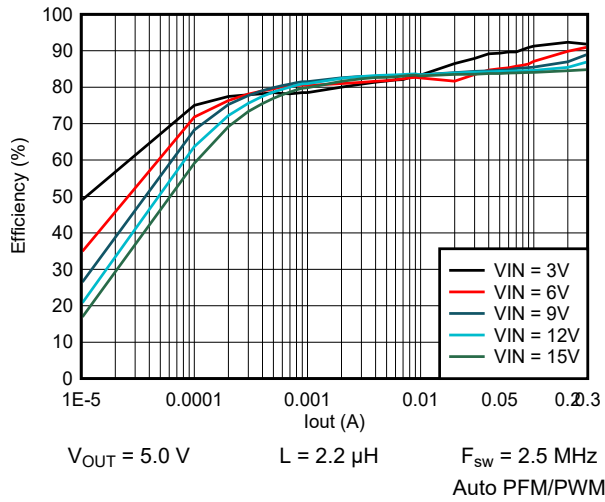

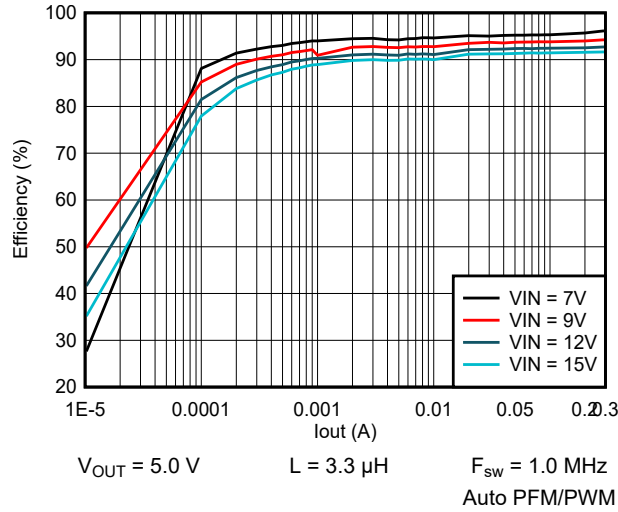

9-8. Efficiency vs Output Current

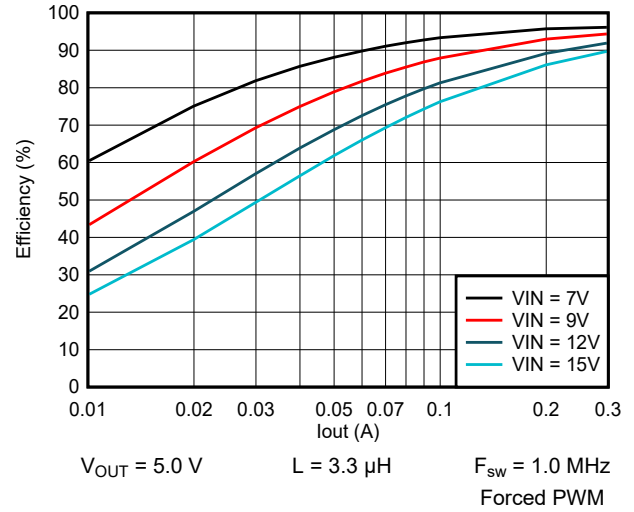

9-9. Efficiency vs Output Current

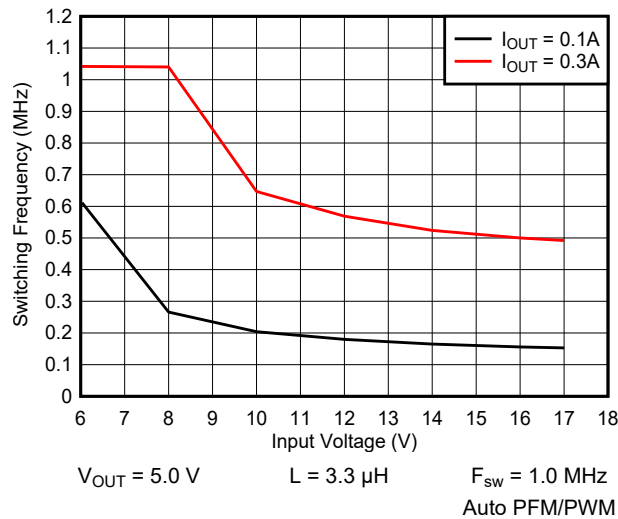

9-10. Switching Frequency vs Input Voltage

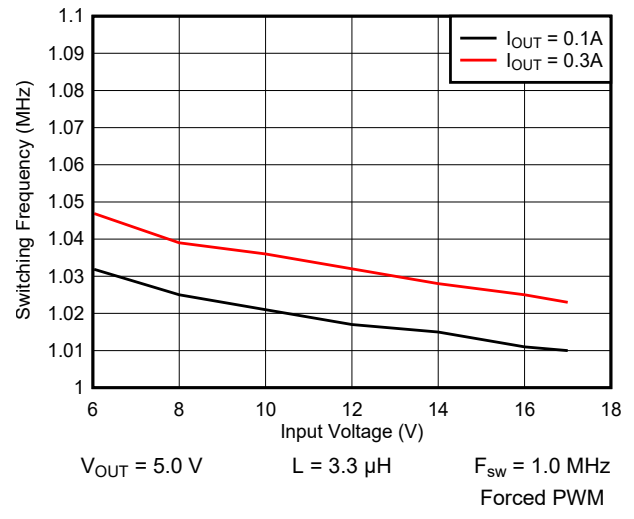

9-11. Switching Frequency vs Input Voltage

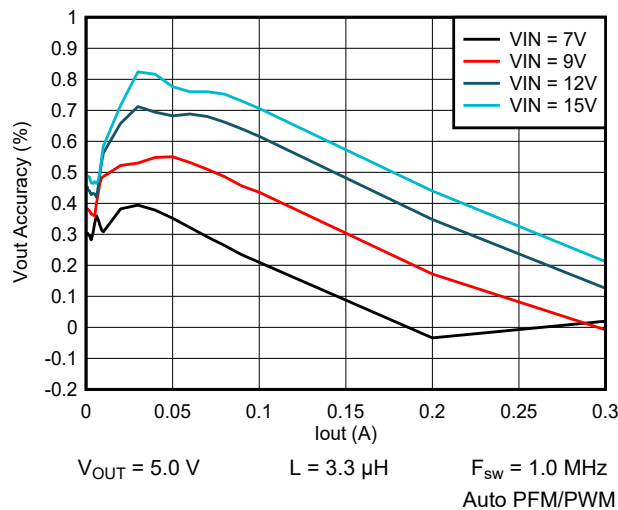

9-12. Output Voltage vs Output Current

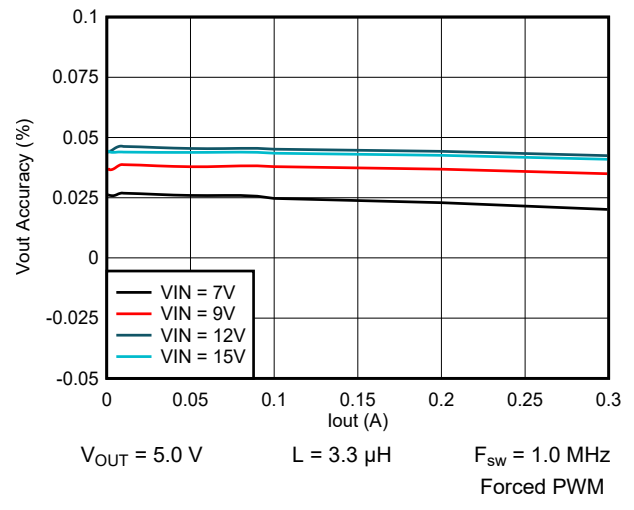

9-13. Output Voltage vs Output Current

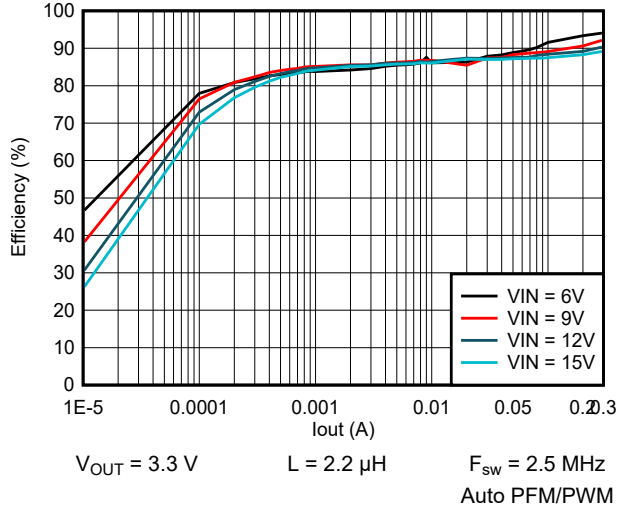

9-14. Efficiency vs Output Current

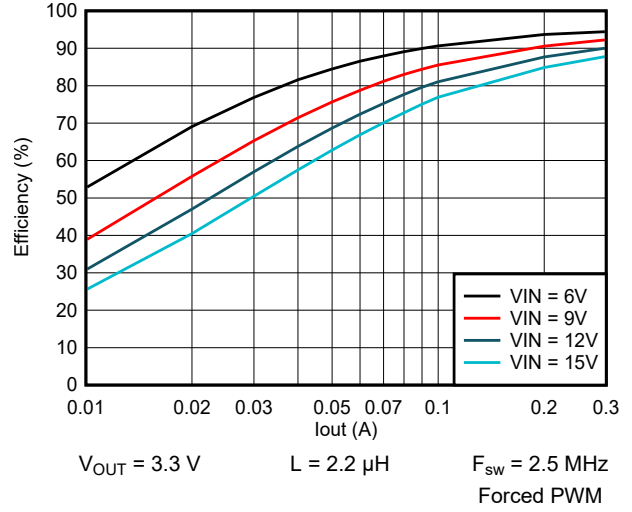

9-15. Efficiency vs Output Current

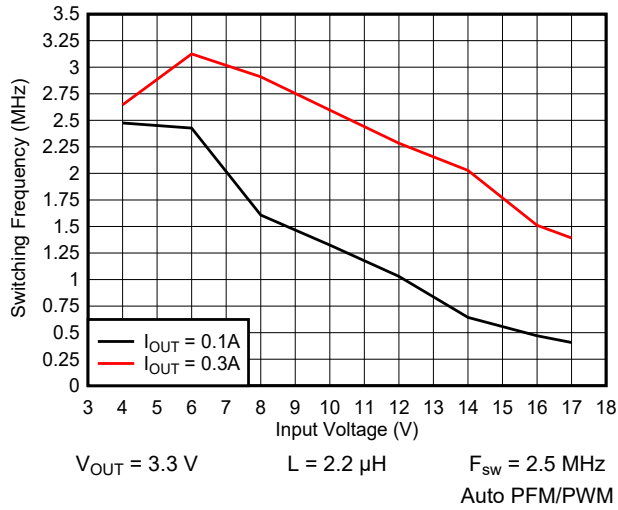

9-16. Switching Frequency vs Input Voltage

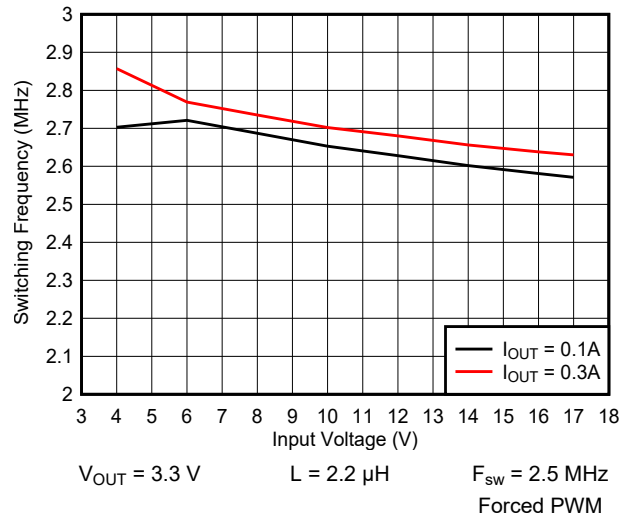

9-17. Switching Frequency vs Input Voltage

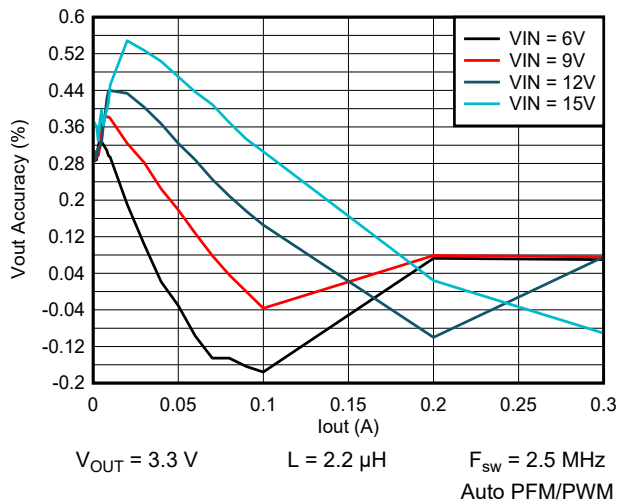

9-18. Output Voltage vs Output Current

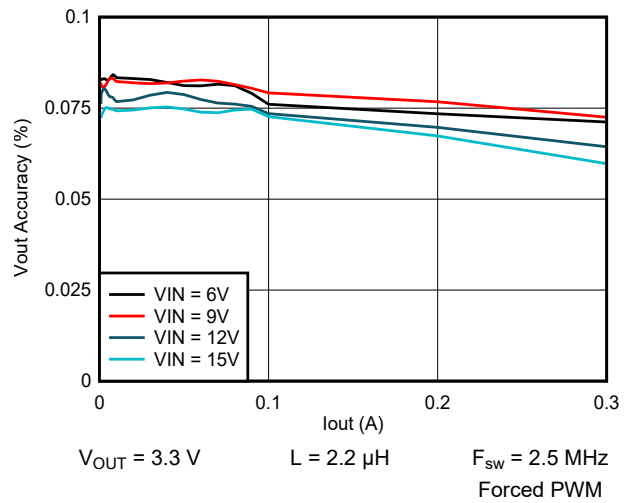

9-19. Output Voltage vs Output Current

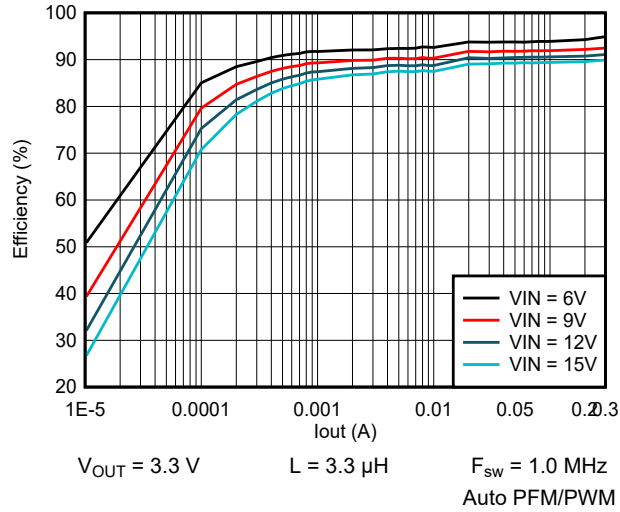

9-20. Efficiency vs Output Current

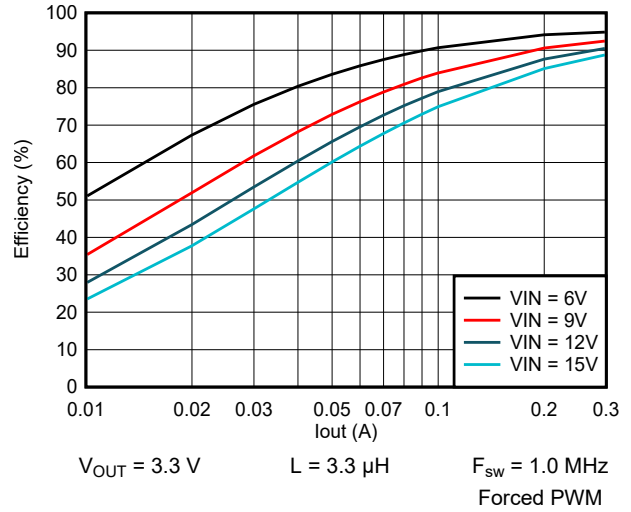

9-21. Efficiency vs Output Current

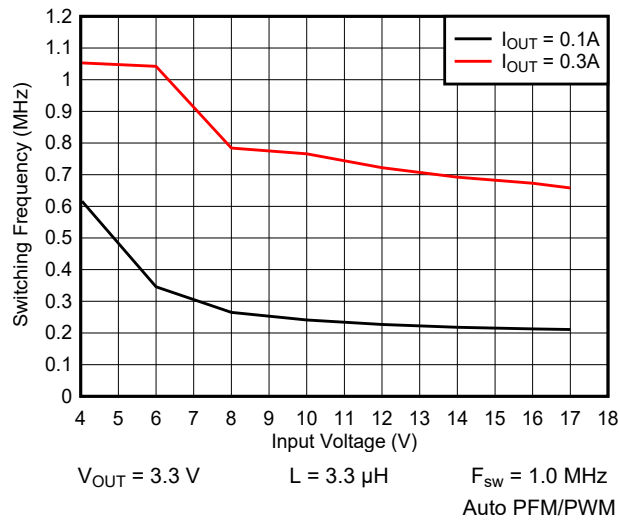

9-22. Switching Frequency vs Input Voltage

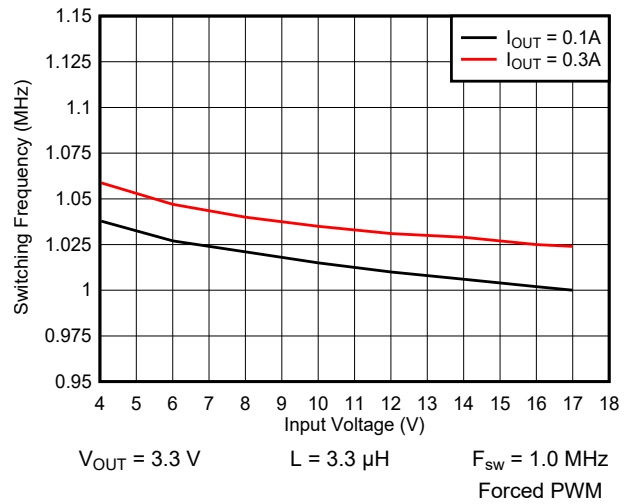

9-23. Switching Frequency vs Input Voltage

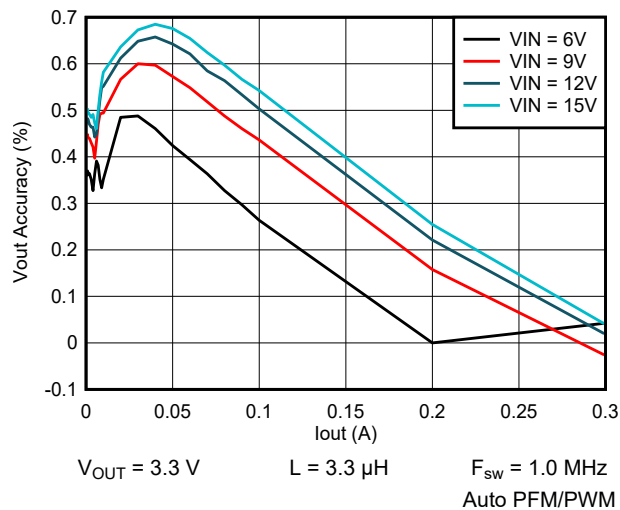

9-24. Output Voltage vs Output Current

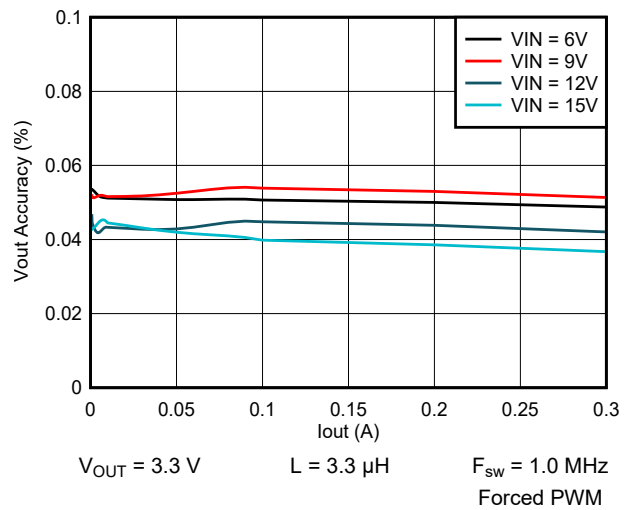

9-25. Output Voltage vs Output Current

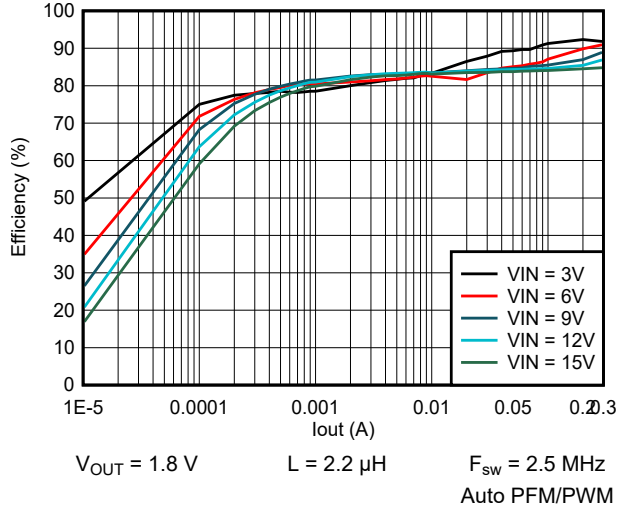

**9-26. Efficiency vs Output Current**

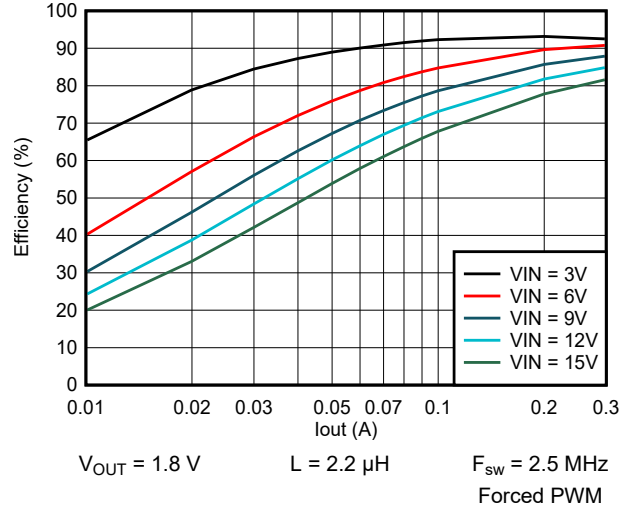

**9-27. Efficiency vs Output Current**

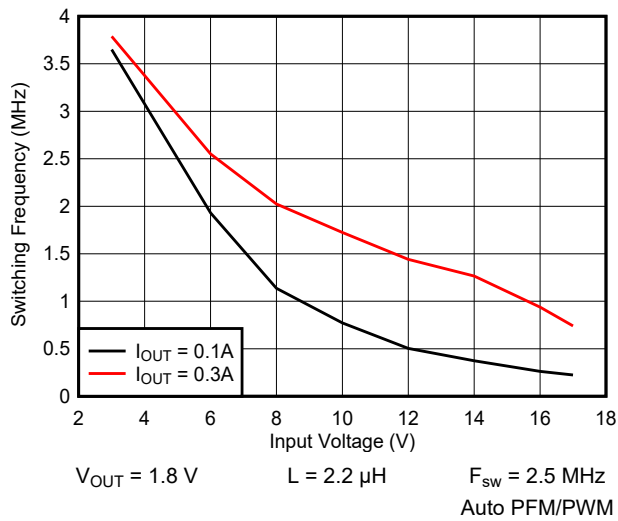

**9-28. Switching Frequency vs Input Voltage**

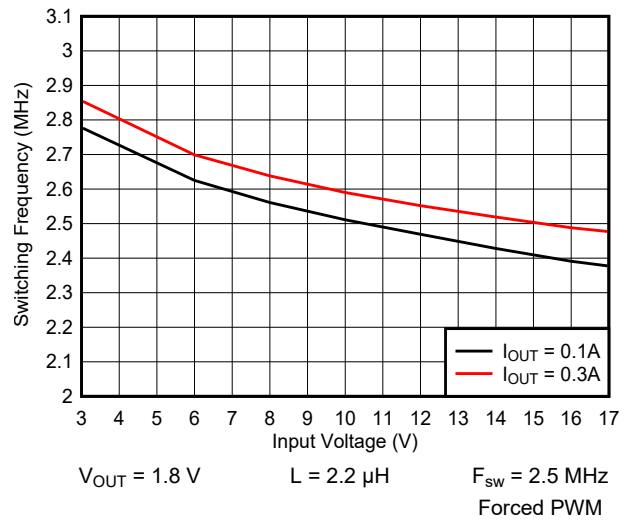

**9-29. Switching Frequency vs Input Voltage**

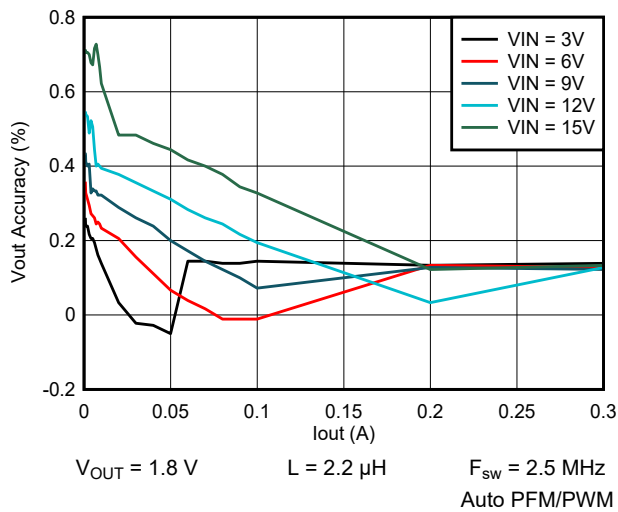

**9-30. Output Voltage vs Output Current**

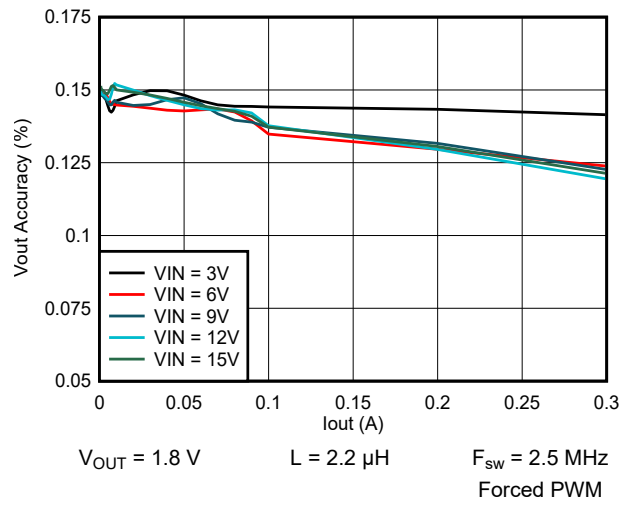

**9-31. Output Voltage vs Output Current**

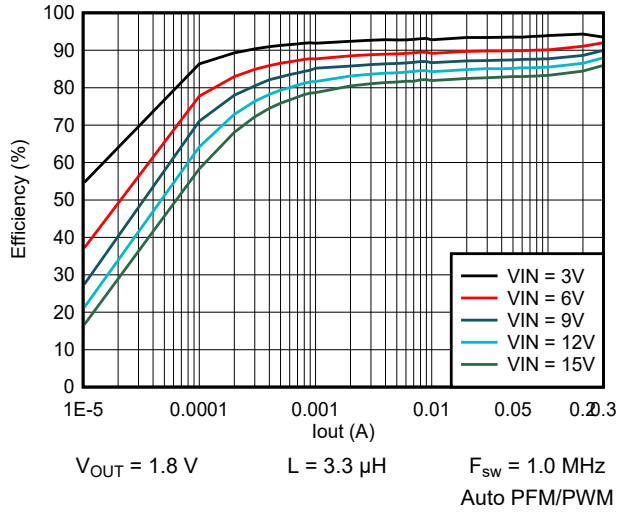

9-32. Efficiency vs Output Current

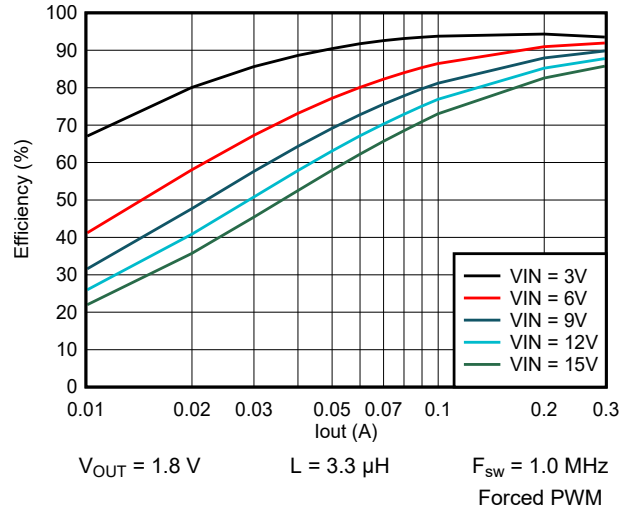

9-33. Efficiency vs Output Current

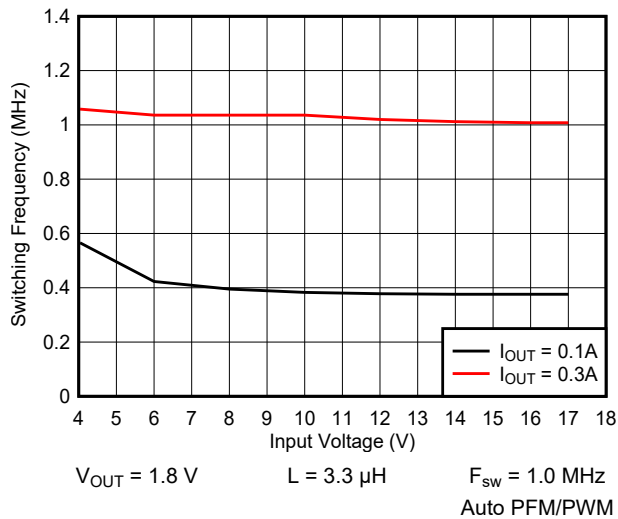

9-34. Switching Frequency vs Input Voltage

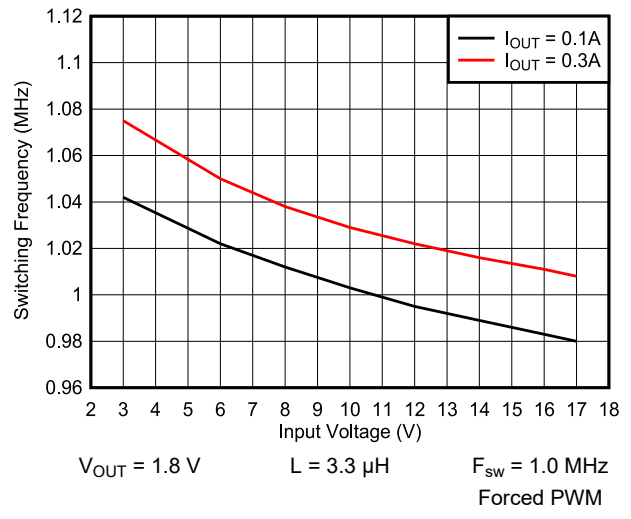

9-35. Switching Frequency vs Input Voltage

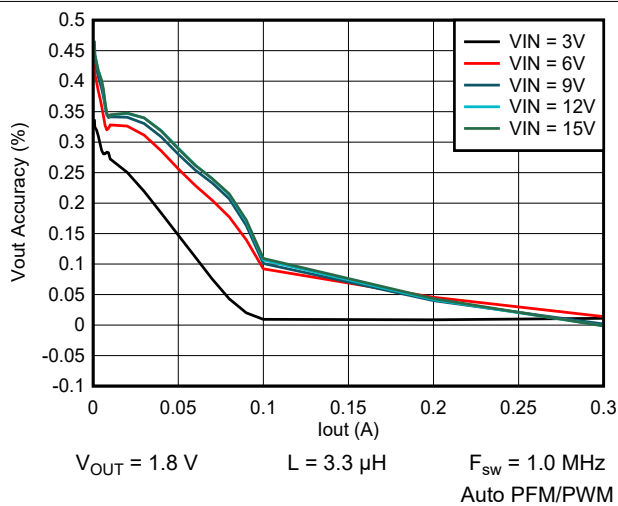

9-36. Output Voltage vs Output Current

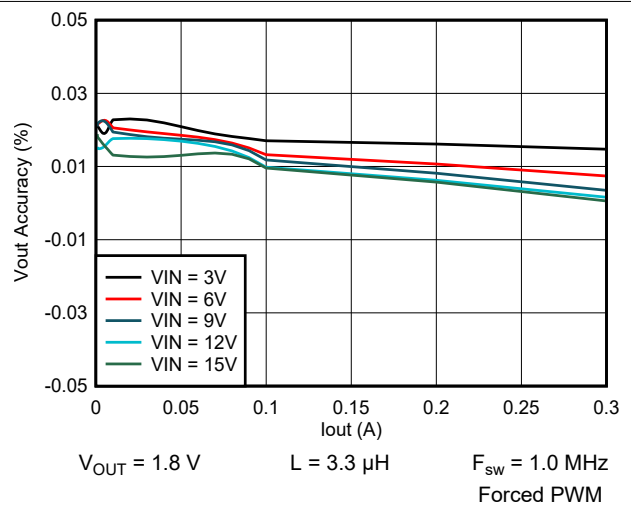

9-37. Output Voltage vs Output Current

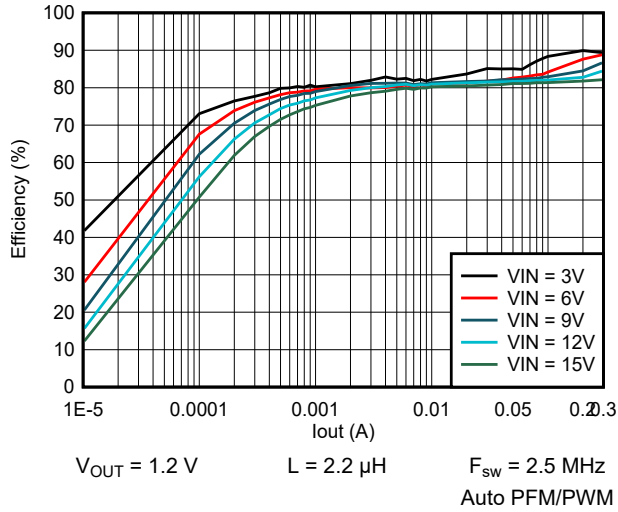

**9-38. Efficiency vs Output Current**

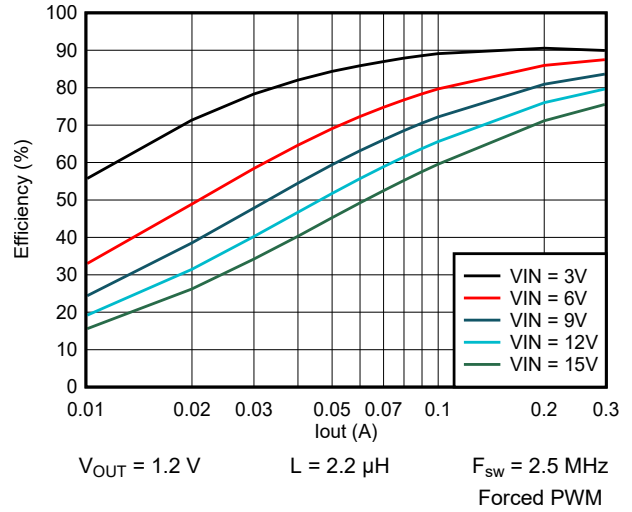

**9-39. Efficiency vs Output Current**

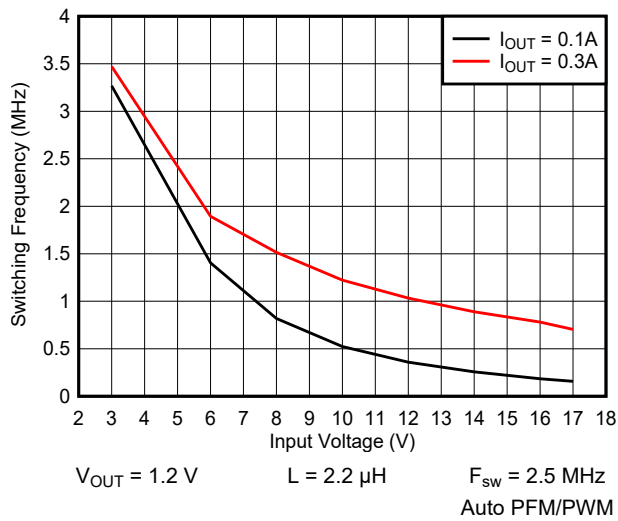

**9-40. Switching Frequency vs Input Voltage**

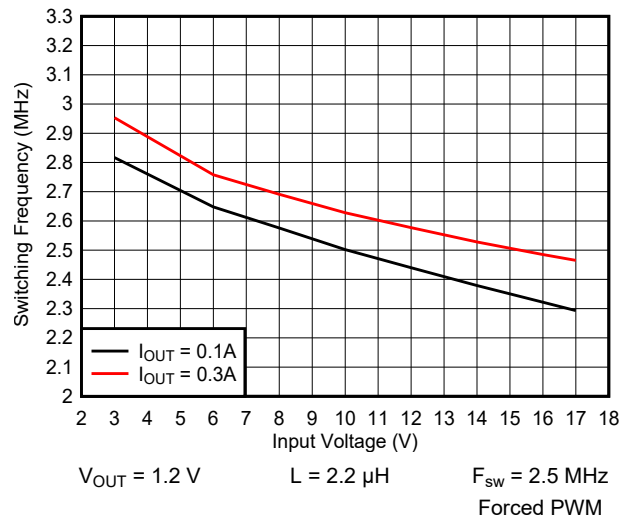

**9-41. Switching Frequency vs Input Voltage**

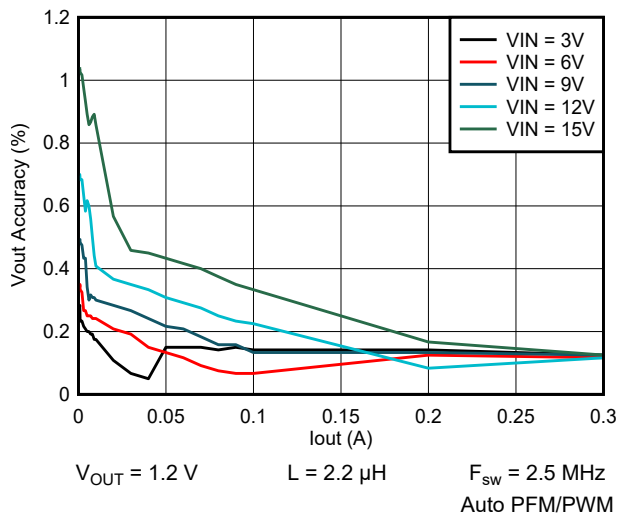

**9-42. Output Voltage vs Output Current**

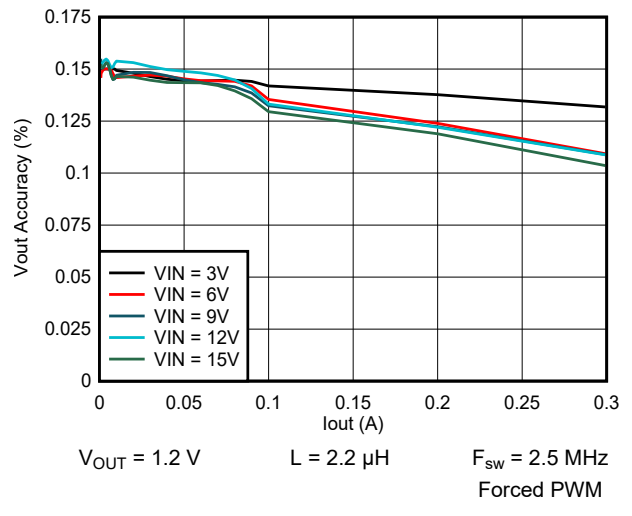

**9-43. Output Voltage vs Output Current**

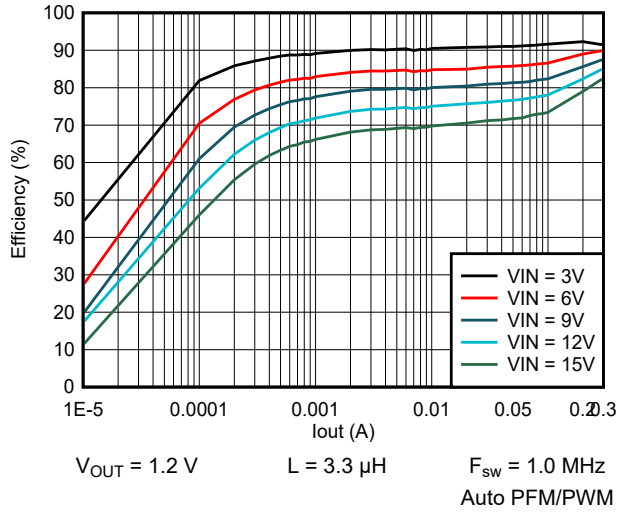

9-44. Efficiency vs Output Current

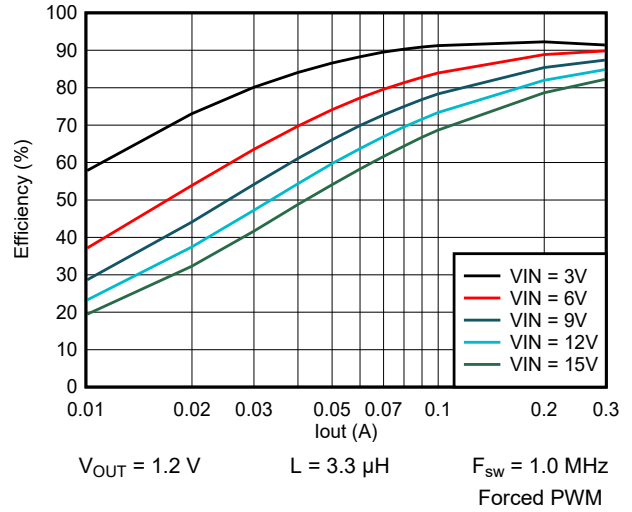

9-45. Efficiency vs Output Current

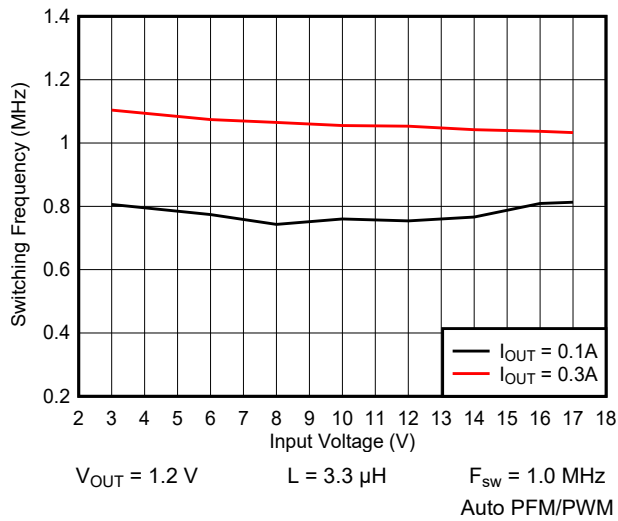

9-46. Switching Frequency vs Input Voltage

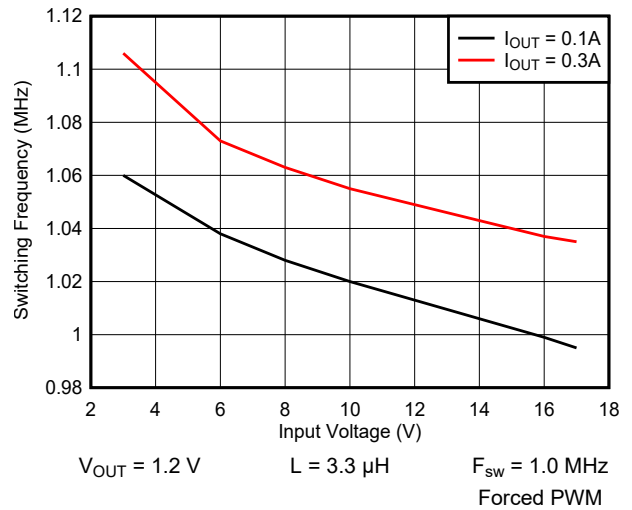

9-47. Switching Frequency vs Input Voltage

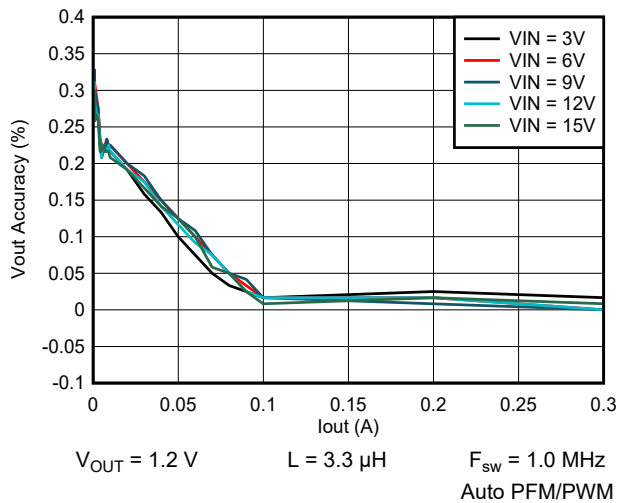

9-48. Output Voltage vs Output Current

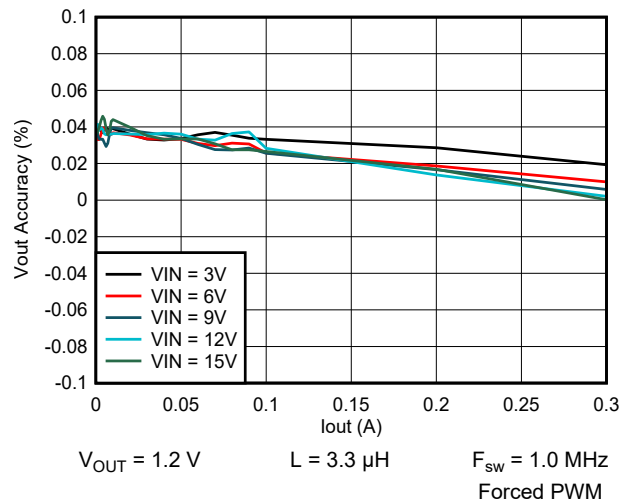

9-49. Output Voltage vs Output Current



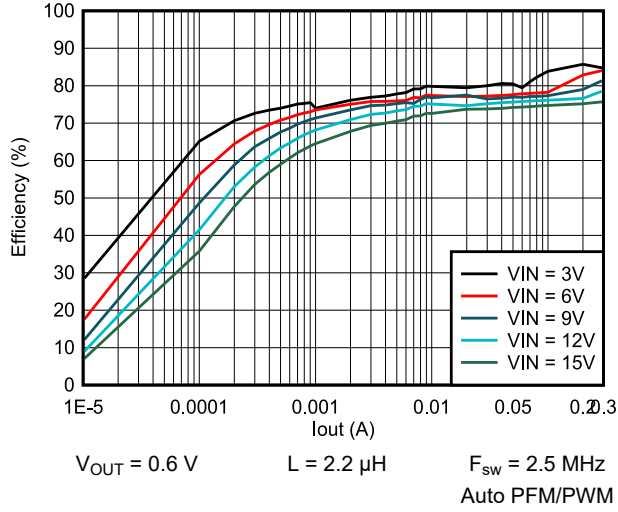

9-50. Efficiency vs Output Current

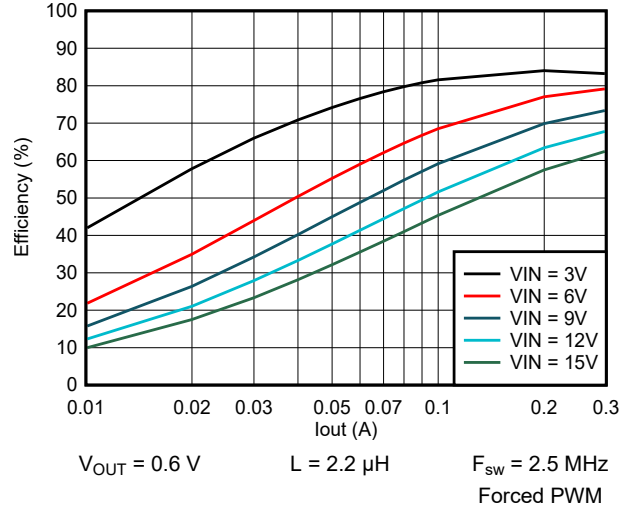

9-51. Efficiency vs Output Current

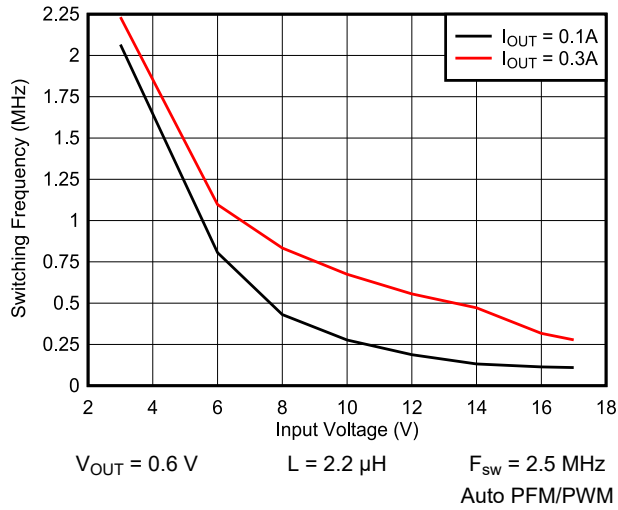

9-52. Switching Frequency vs Input Voltage

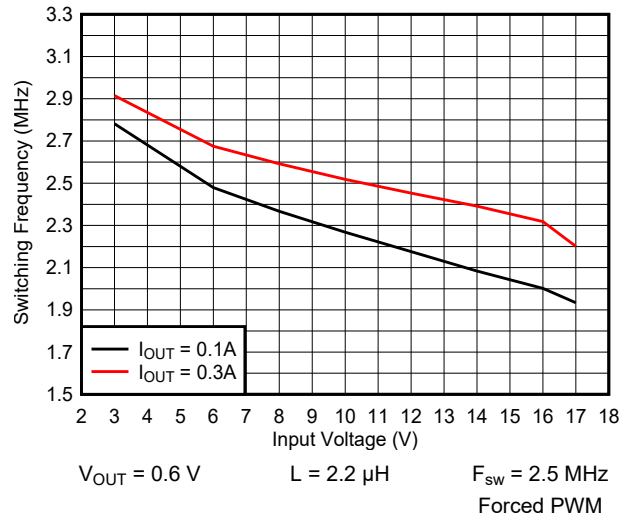

9-53. Switching Frequency vs Input Voltage

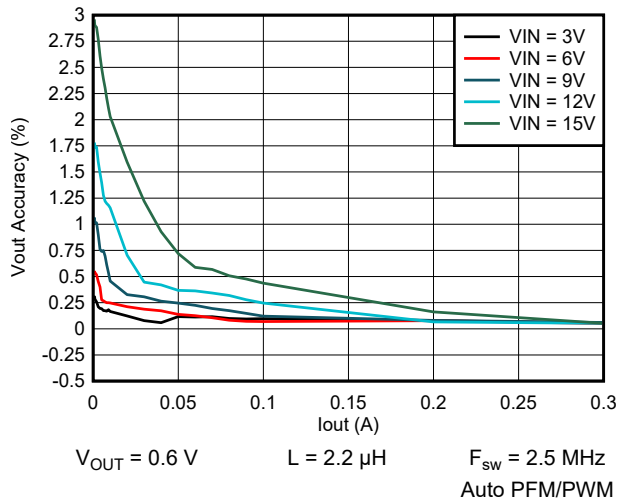

9-54. Output Voltage vs Output Current

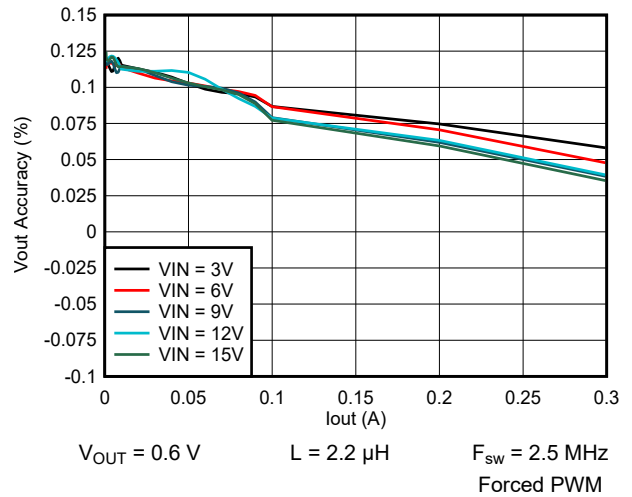

9-55. Output Voltage vs Output Current

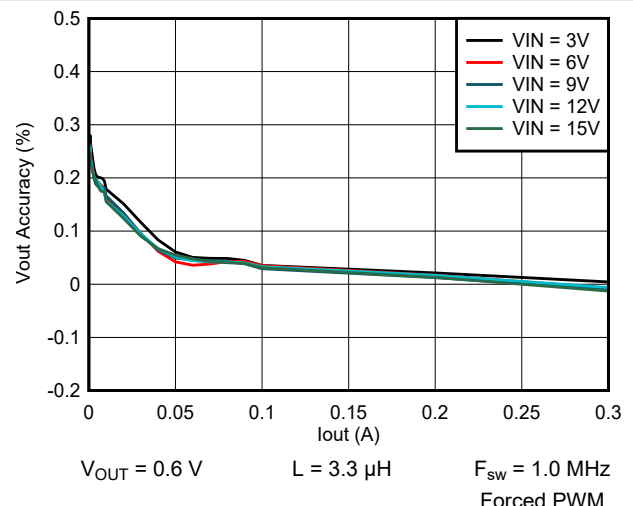
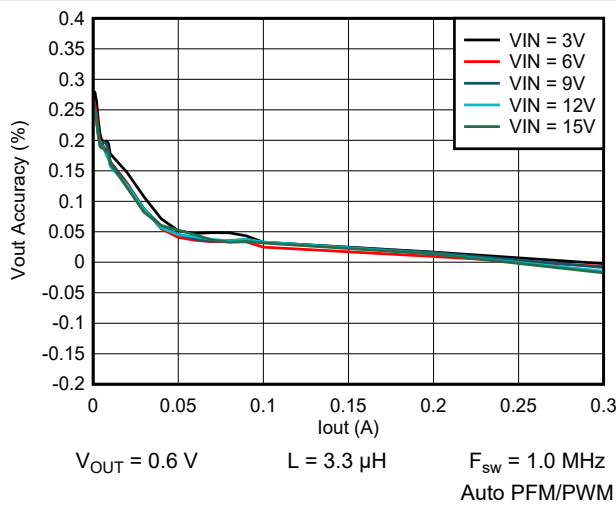
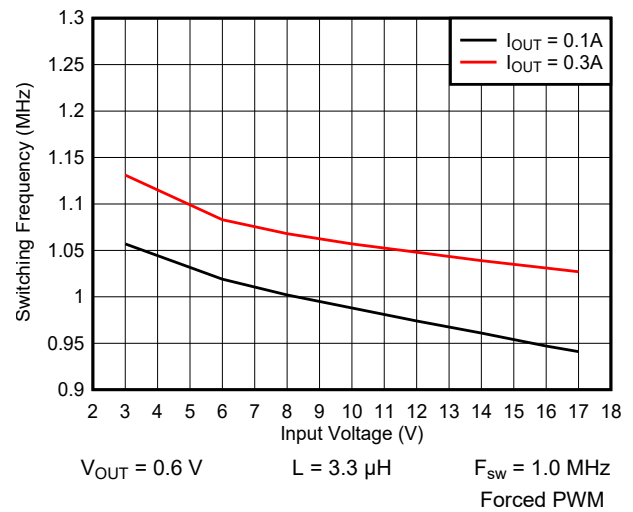
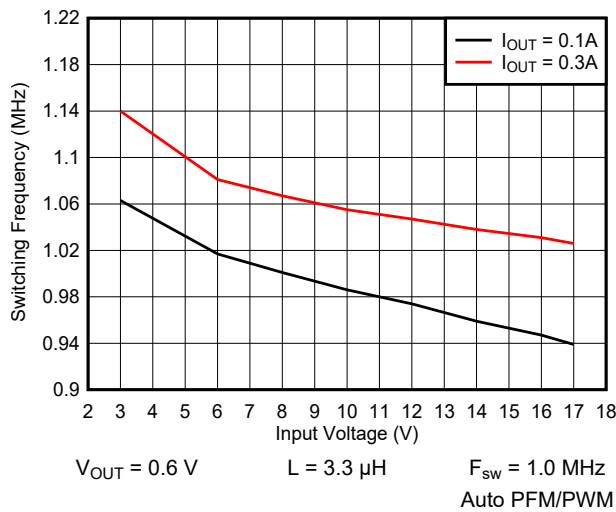
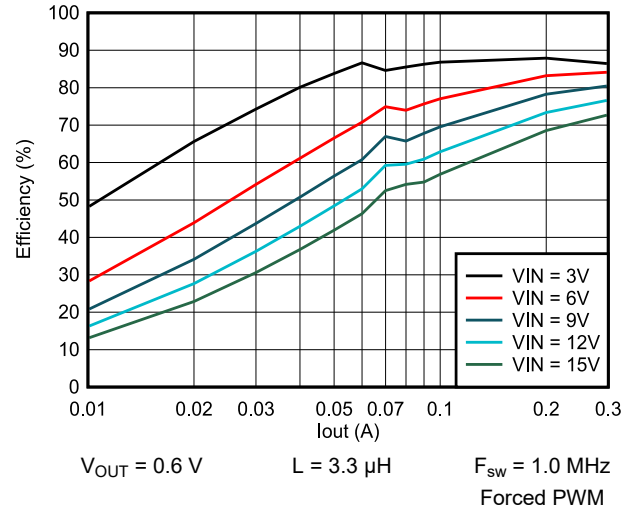
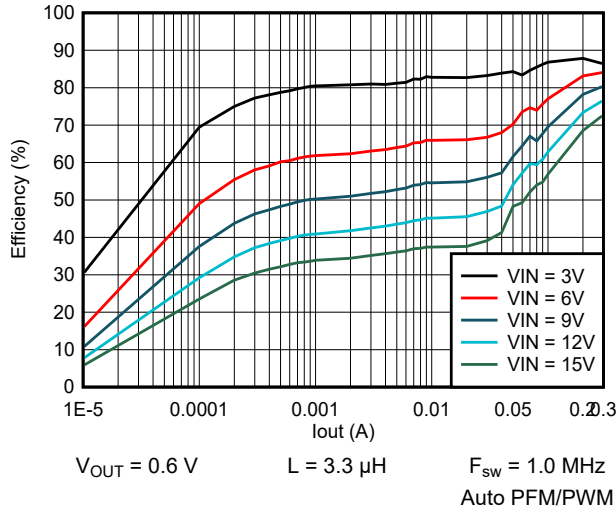

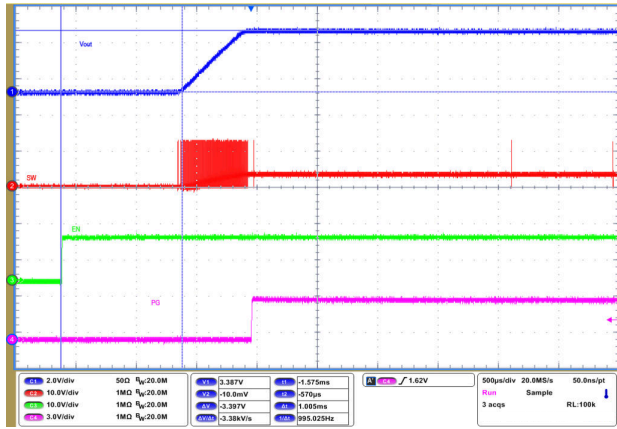

$V_{IN} = 12\text{ V}$        $L = 2.2\ \mu\text{H}$        $F_{SW} = 2.5\text{ MHz}$   
 $V_{OUT} = 3.3\text{ V}$        $I_O = 0\text{ A}$       Auto PFM/PWM

**图 9-62. Start-Up Timing**

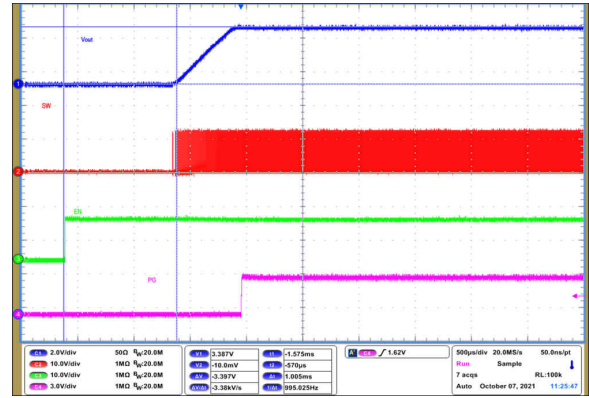

$V_{IN} = 12\text{ V}$        $L = 2.2\ \mu\text{H}$        $F_{SW} = 2.5\text{ MHz}$   
 $V_{OUT} = 3.3\text{ V}$        $I_O = 0.3\text{ A}$       Forced PWM

**图 9-63. Start-Up Timing**

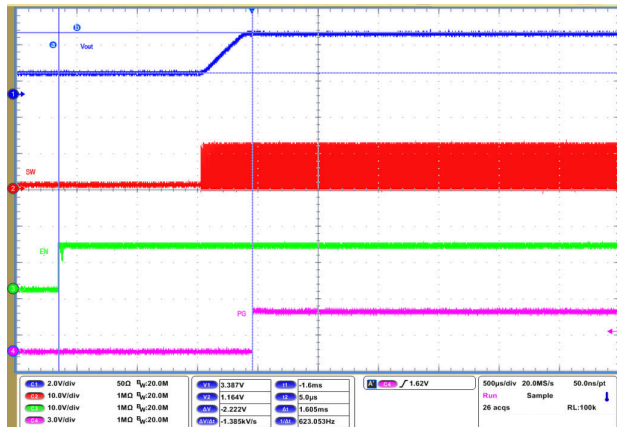

$V_{IN} = 12\text{ V}$        $L = 2.2\ \mu\text{H}$        $F_{SW} = 2.5\text{ MHz}$   
 $V_{OUT} = 3.3\text{ V}$        $I_O = 0\text{ A}$       Forced PWM

**图 9-64. Start-Up into Prebiased Output**

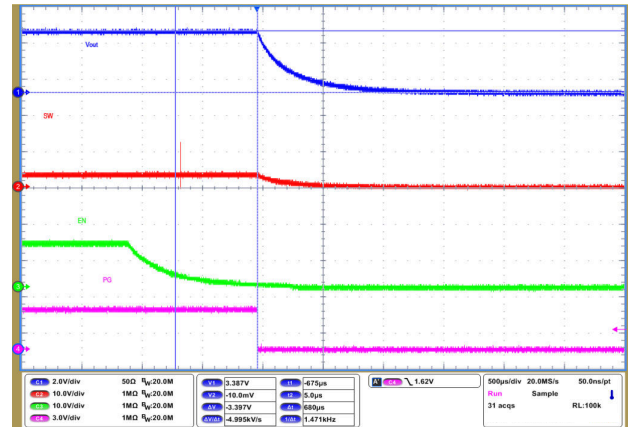

$V_{IN} = 12\text{ V}$        $L = 2.2\ \mu\text{H}$        $F_{SW} = 2.5\text{ MHz}$   
 $V_{OUT} = 3.3\text{ V}$        $I_O = 0\text{ A}$       Auto PFM/PWM

**图 9-65. Shutdown Timing with Output Discharge Enabled**

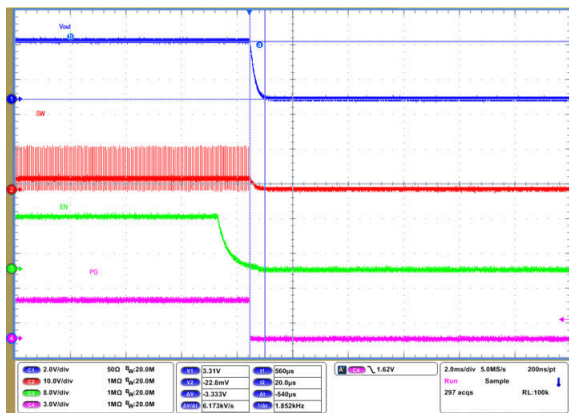

$V_{IN} = 12\text{ V}$        $L = 3.3\ \mu\text{H}$        $F_{SW} = 1.0\text{ MHz}$   
 $V_{OUT} = 3.3\text{ V}$        $I_O = 10\text{ mA}$       Auto PFM/PWM

**图 9-66. Shutdown Timing with Output Discharge Enabled**

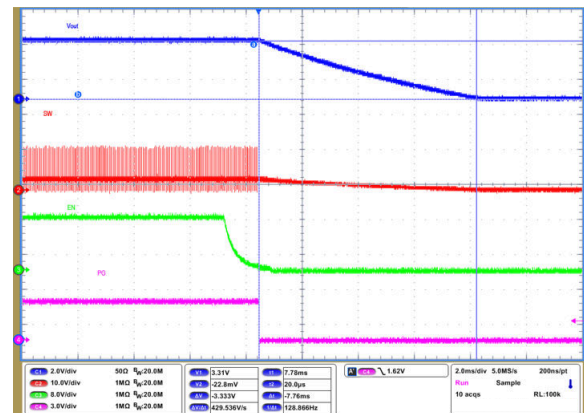

$V_{IN} = 12\text{ V}$        $L = 3.3\ \mu\text{H}$        $F_{SW} = 1.0\text{ MHz}$   
 $V_{OUT} = 3.3\text{ V}$        $I_O = 10\text{ mA}$       Auto PFM/PWM

**图 9-67. Shutdown Timing with Output Discharge Disabled**

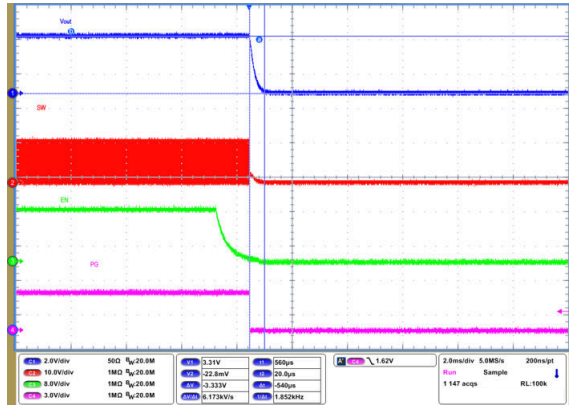

$V_{IN} = 12\text{ V}$        $L = 3.3\ \mu\text{H}$        $F_{SW} = 1.0\ \text{MHz}$   
 $V_{OUT} = 3.3\text{ V}$        $I_O = 10\ \text{mA}$       Forced PWM

**9-68. Shutdown Timing with Output Discharge Enabled**

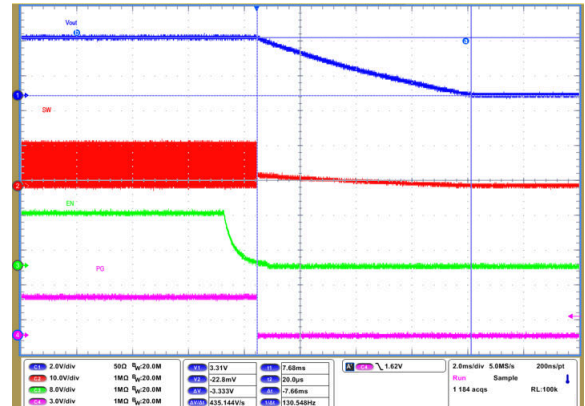

$V_{IN} = 12\text{ V}$        $L = 3.3\ \mu\text{H}$        $F_{SW} = 1.0\ \text{MHz}$   
 $V_{OUT} = 3.3\text{ V}$        $I_O = 10\ \text{mA}$       Forced PWM

**9-69. Shutdown Timing with Output Discharge Disabled**

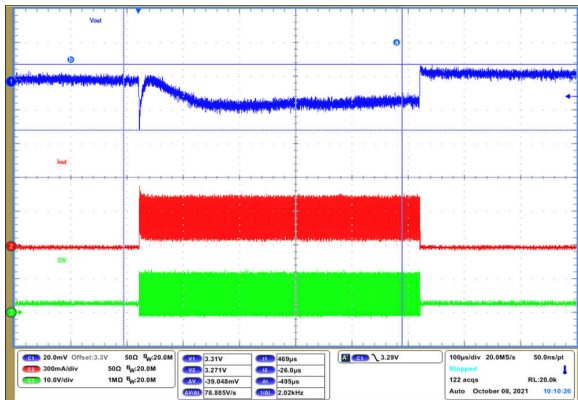

$V_{IN} = 12\text{ V}$        $L = 2.2\ \mu\text{H}$        $F_{SW} = 2.5\ \text{MHz}$   
 $V_{OUT} = 3.3\text{ V}$        $I_O = 0\ \text{A to } 0.3\ \text{A}$       Auto PFM/PWM

**9-70. Load Transient Response**

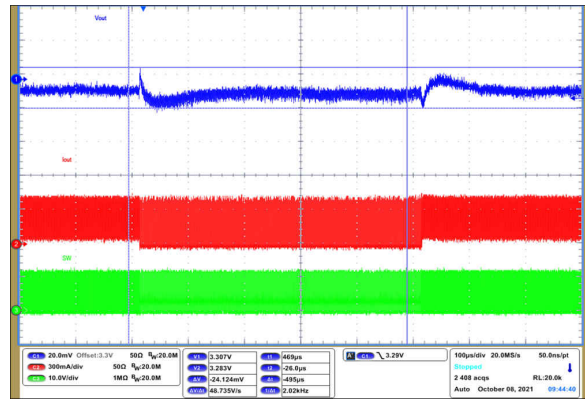

$V_{IN} = 12\text{ V}$        $L = 2.2\ \mu\text{H}$        $F_{SW} = 2.5\ \text{MHz}$   
 $V_{OUT} = 3.3\text{ V}$        $I_O = 0.1\ \text{A to } 0.3\ \text{A}$       Forced PWM

**9-71. Load Transient Response**

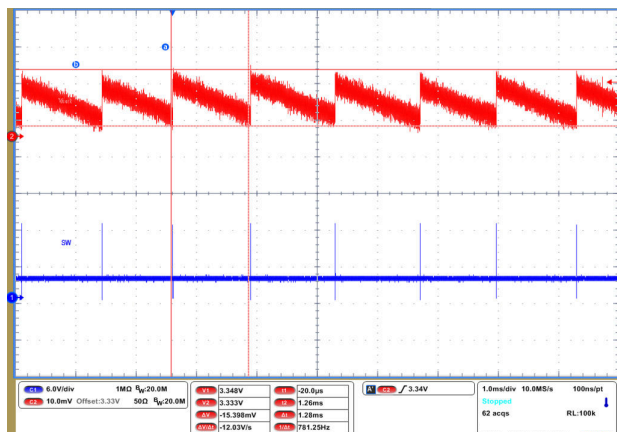

$V_{IN} = 12\text{ V}$        $L = 2.2\ \mu\text{H}$        $F_{SW} = 2.5\ \text{MHz}$   
 $V_{OUT} = 3.3\text{ V}$        $I_O = 0\ \text{A}$       Auto PFM/PWM

**9-72. Output Voltage Ripple**

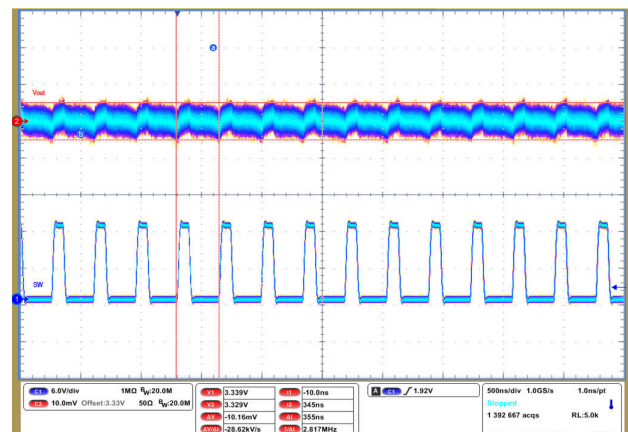

$V_{IN} = 12\text{ V}$        $L = 2.2\ \mu\text{H}$        $F_{SW} = 2.5\ \text{MHz}$   
 $V_{OUT} = 3.3\text{ V}$        $I_O = 0\ \text{A}$       Forced PWM

**9-73. Output Voltage Ripple**

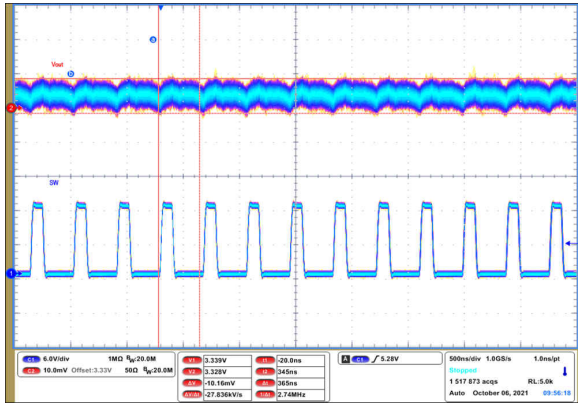

$V_{IN} = 12\text{ V}$        $L = 2.2\ \mu\text{H}$        $F_{SW} = 2.5\text{ MHz}$   
 $V_{OUT} = 3.3\text{ V}$        $I_O = 0.3\text{ A}$       Auto PFM/PWM

**9-74. Output Voltage Ripple**

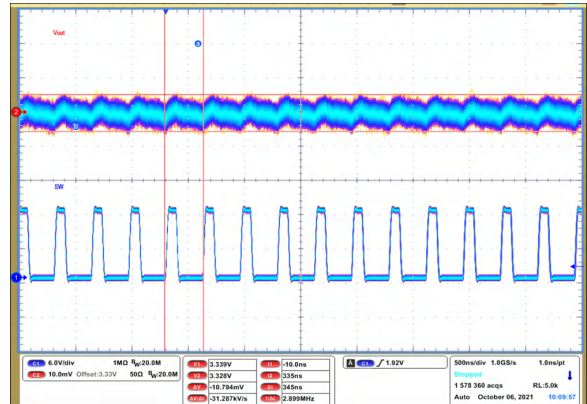

$V_{IN} = 12\text{ V}$        $L = 2.2\ \mu\text{H}$        $F_{SW} = 2.5\text{ MHz}$   
 $V_{OUT} = 3.3\text{ V}$        $I_O = 0.3\text{ A}$       Forced PWM

**9-75. Output Voltage Ripple**

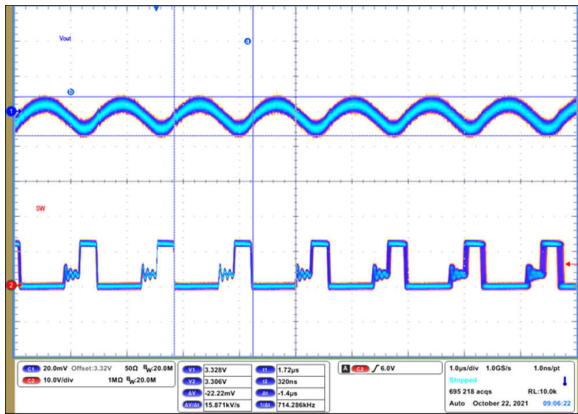

$V_{IN} = 12\text{ V}$        $L = 3.3\ \mu\text{H}$        $F_{SW} = 1.0\text{ MHz}$   
 $V_{OUT} = 3.3\text{ V}$        $I_O = 0.3\text{ A}$       Auto PFM/PWM

**9-76. Output Voltage Ripple**

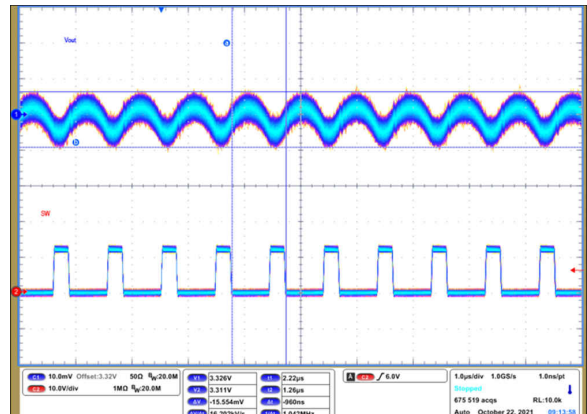

$V_{IN} = 12\text{ V}$        $L = 3.3\ \mu\text{H}$        $F_{SW} = 1.0\text{ MHz}$   
 $V_{OUT} = 3.3\text{ V}$        $I_O = 0.3\text{ A}$       Forced PWM

**9-77. Output Voltage Ripple**

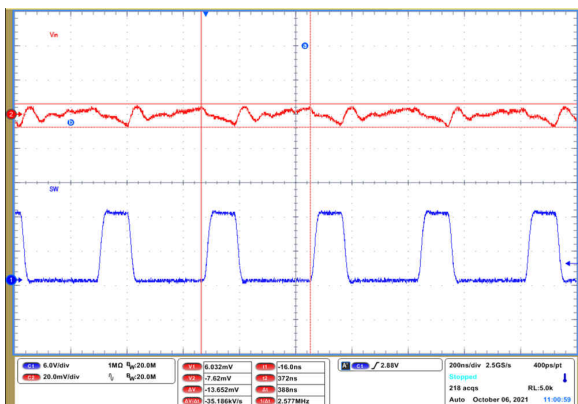

$V_{IN} = 12\text{ V}$        $L = 2.2\ \mu\text{H}$        $F_{SW} = 2.5\text{ MHz}$   
 $V_{OUT} = 3.3\text{ V}$        $I_O = 0.3\text{ A}$       Auto PFM/PWM

**9-78. Input Voltage Ripple**

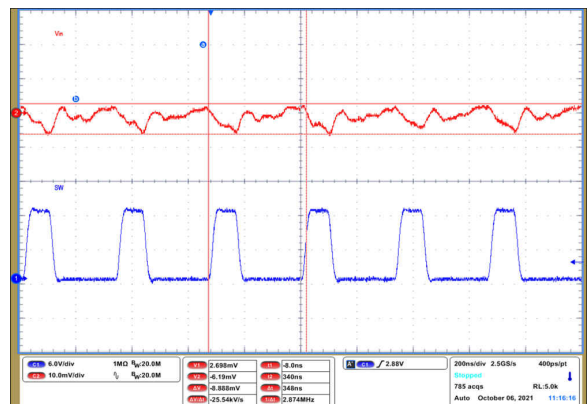

$V_{IN} = 12\text{ V}$        $L = 2.2\ \mu\text{H}$        $F_{SW} = 2.5\text{ MHz}$   
 $V_{OUT} = 3.3\text{ V}$        $I_O = 0.3\text{ A}$       Forced PWM

**9-79. Input Voltage Ripple**

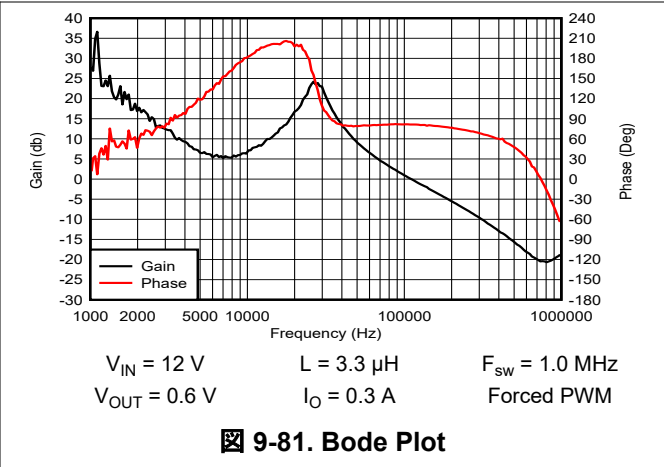
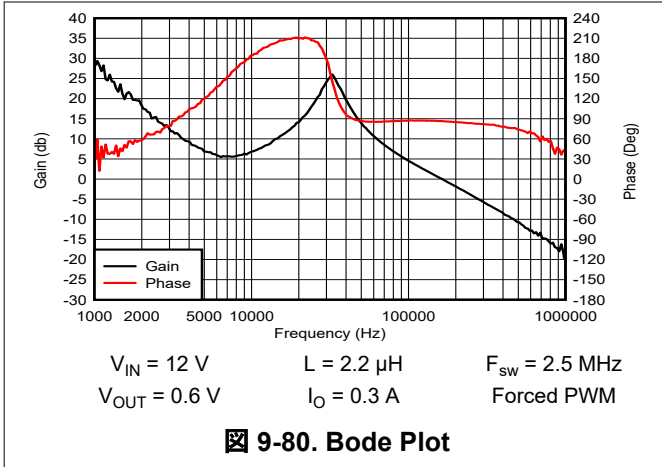

## 9.3 System Examples

### 9.3.1 Powering Multiple Loads

In applications where the TPS629203-Q1 is used to power multiple load circuits, it is possible that the total capacitance on the output is very large. In order to properly regulate the output voltage, there needs to be an appropriate AC signal level on the VOS pin. Tantalum capacitors have a large enough ESR to keep output voltage ripple sufficiently high on the VOS pin. With low-ESR ceramic capacitors, the output voltage ripple can get very low, so it is not recommended to use a large capacitance directly on the output of the device. If there are several load circuits with their associated input capacitor on a PCB, these loads are typically distributed across the board. This adds enough trace resistance ( $R_{\text{trace}}$ ) to keep a large enough AC signal on the VOS pin for proper regulation.

The minimum total trace resistance on the distributed load is 10 m $\Omega$ . The total capacitance  $n \times C_{\text{IN}}$  in [Figure 9-82](#) was  $32 \times 47 \mu\text{F}$  of ceramic X7R capacitors.

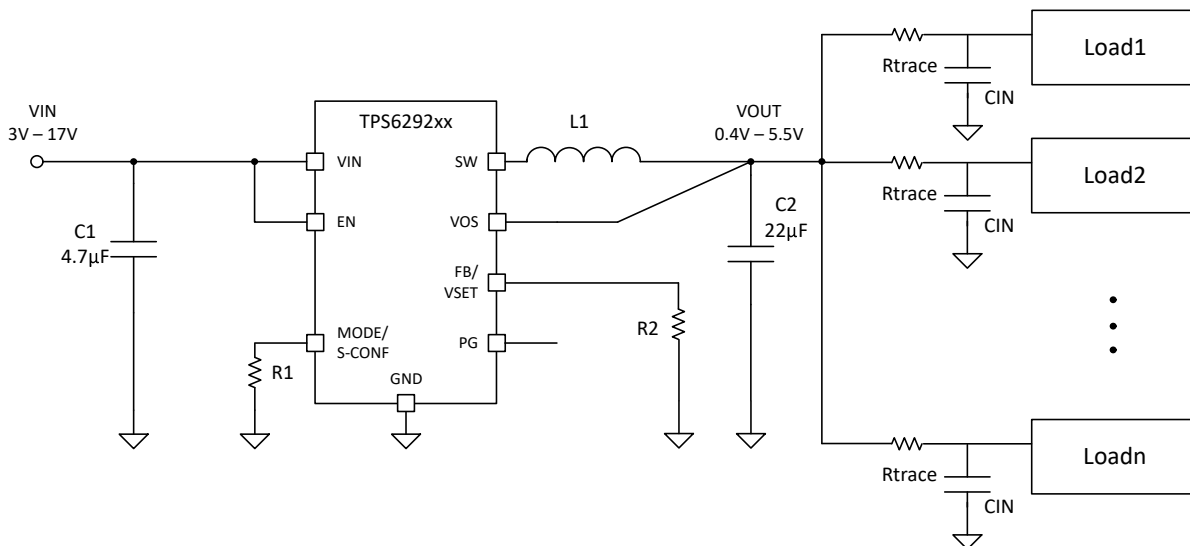

**Figure 9-82. Multiple Loads Example**

### 9.3.2 Inverting Buck-Boost (IBB)

The need to generate negative voltage rails for electronic designs is a common challenge. The wide 3-V to 17-V input voltage range of the TPS629203-Q1 makes it ideal for an inverting buck-boost (IBB) circuit, where the output voltage is inverted or negative with respect to ground.

The circuit operation in the IBB topology differs from that in the traditional buck topology. Though the components are connected the same as with a traditional buck converter, the output voltage terminals are reversed. See [Figure 9-83](#) and [Figure 9-84](#).

The maximum input voltage that can be applied to an IBB converter is less than the maximum voltage that can be applied to the TPS629203-Q1 in a typical buck configuration. This is because the ground pin of the IC is connected to the (negative) output voltage. Therefore, the input voltage across the device is  $V_{\text{IN}}$  to  $V_{\text{OUT}}$ , and not  $V_{\text{IN}}$  to ground. Thus, the input voltage range of the TPS629203-Q1 in an IBB configuration becomes 3 V to 17 V +  $V_{\text{OUT}}$ , where  $V_{\text{OUT}}$  is a negative value.

The output voltage range is the same as when configured as a buck converter, but only negative. Thus, the output voltage for a TPS629203-Q1 in an IBB configuration may be set between  $-0.4 \text{ V}$  and  $-5.5 \text{ V}$ .

The maximum output current for the TPS629203-Q1 in an IBB topology is normally lower than a traditional buck configuration due to the average inductor current being higher in an IBB configuration. Traditionally, lower input or (more negative) output voltages results in a lower maximum output current. However, using a larger inductor value or the higher 2.5-MHz frequency setting can be used to recover some or all of this lost maximum current capability.

When implementing an IBB design, it is important to understand that the IC ground is tied to the negative voltage rail, and in turn, the electrical characteristics of the TPS629203-Q1 device are referenced to this rail. During power up, as there is no charge in the output capacitor, the IC GND pin (and  $V_{OUT}$ ) are effectively 0 V, thus parameters such as the  $V_{IN}$  UVLO and EN thresholds are the same as in a typical buck configuration. However, after the output voltage is in regulation, due to the negative voltage on the IC GND pin, the device traditionally continues to operate below what could appear to be the normal UVLO/EN falling thresholds relative to the system ground. Thus, special care needs to be taken if the user is utilizing the dynamic mode change feature on the MODE pin of the TPS629203-Q1 or driving the EN pin from an upstream microcontroller as the high and low thresholds are relative to the negative rail and not the system ground.

More information on using a DCS regulator in an IBB configuration can be found in the [Description Compensating the Current Mode Boost Control Loop Application Note](#) and [Using the TPS6215x in an Inverting Buck-Boost Topology Application Note](#).

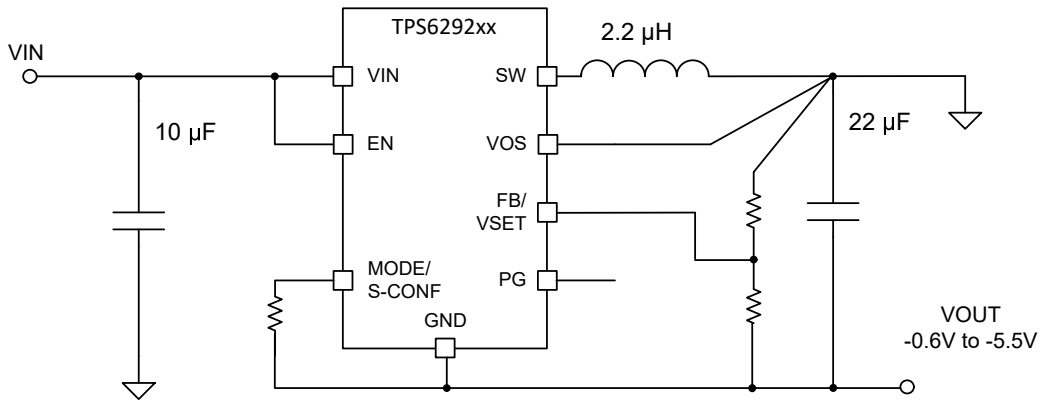

**Figure 9-83. IBB Example with Adjustable Feedback**

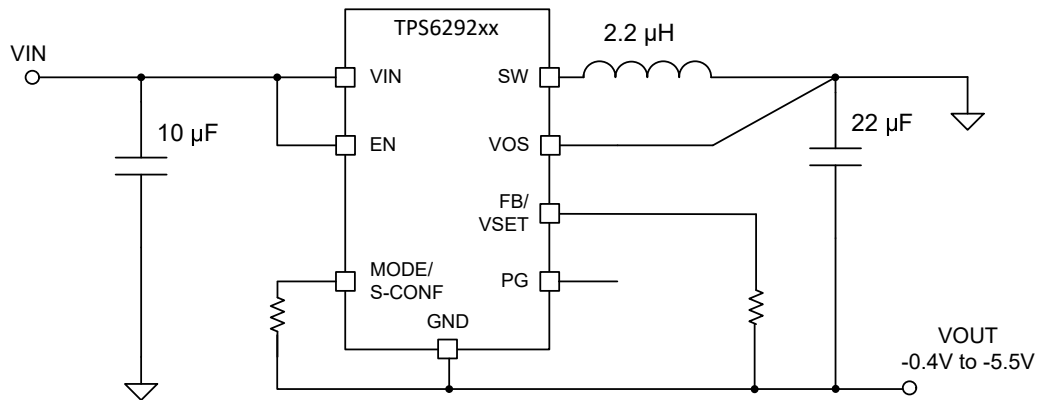

**Figure 9-84. IBB Example with Internal Feedback**

## 10 Power Supply Recommendations

The power supply to the TPS629203-Q1 needs to have a current rating according to the supply voltage, output voltage, and output current of the TPS629203-Q1.



## 11 Layout

### 11.1 Layout Guidelines

A proper layout is critical for the operation of a switched mode power supply, even more so at high switching frequencies. Therefore, the PCB layout of the TPS629203-Q1 demands careful attention to make sure proper operation and to get the performance specified. A poor layout can lead to issues like the following:

- Poor regulation (both line and load)
- Stability and accuracy weaknesses
- Increased EMI radiation
- Noise sensitivity

See [Figure 11-1](#) for the recommended layout of the TPS629203-Q1, which is designed for common external ground connections. The input capacitor should be placed as close as possible between the VIN and GND pin of the TPS629203-Q1.

Provide low inductive and resistive paths for loops with high  $di/dt$ . Therefore, paths conducting the switched load current should be as short and wide as possible. Provide low capacitive paths (with respect to all other nodes) for wires with high  $dv/dt$ . Therefore, the input and output capacitance should be placed as close as possible to the IC pins and parallel wiring over long distances as well as narrow traces should be avoided. Loops that conduct an alternating current should outline an area as small as possible, as this area is proportional to the energy radiated.

Sensitive nodes like FB and VOS need to be connected with short wires and not nearby high  $dv/dt$  signals (for example, SW). As they carry information about the output voltage, they should be connected as close as possible to the actual output voltage (at the output capacitor). The FB resistors, R1 and R2, should be kept close to the IC and connect directly to those pins and the system ground plane. The same applies for the S-CONFIG/MODE and VSET programming resistors.

The package uses the pins for power dissipation. Thermal vias on the VIN, GND, and SW pins help to spread the heat through the PCB.

In case any of the digital inputs (EN or S-CONF/MODE pins) need to be tied to the input supply voltage at VIN, the connection must be made directly at the input capacitor as indicated in the schematics.

The recommended layout is implemented on the EVM and shown in the [TPS629203-Q1 EVM User's Guide](#).

### 11.2 Layout Example

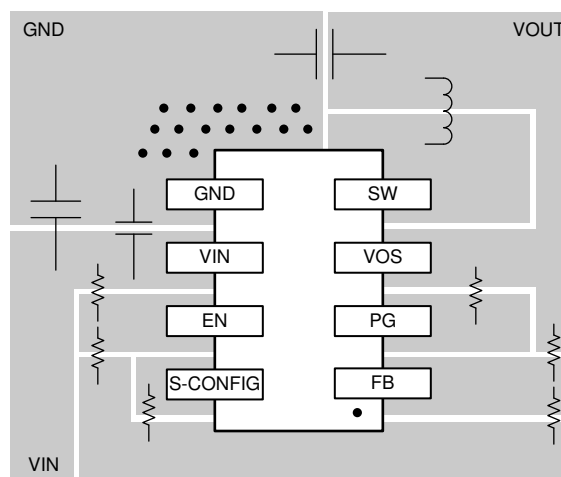

**Figure 11-1. TPS629203-Q1 Layout**

### 11.2.1 Thermal Considerations

Implementation of integrated circuits in low-profile and fine-pitch surface-mount packages typically requires special attention to power dissipation. Many system-dependent issues such as thermal coupling, airflow, added heat sinks and convection surfaces, and the presence of other heat-generating components affect the power-dissipation limits of a given component.

The following are basic approaches for enhancing thermal performance:

- Improving the power dissipation capability of the PCB design (for example, increasing copper thickness, thermal vias, number of layers)
- Introducing airflow in the system

For more details on how to use the thermal parameters, see the [Thermal Characteristics of Linear and Logic Packages Using JEDEC PCB Designs Application Note](#) and [Semiconductor and IC Package Thermal Metrics Application Note](#).

The TPS629203-Q1 is designed for a maximum operating junction temperature ( $T_J$ ) of 150°C. Therefore, the maximum output power is limited by the power losses that can be dissipated over the actual thermal resistance, given by the package and the surrounding PCB structures. If the thermal resistance of the package is given, the size of the surrounding copper area and a proper thermal connection of the IC can reduce the thermal resistance. To get an improved thermal behavior, it is recommended to use top layer metal to connect the device with wide and thick metal lines. Internal ground layers can connect to vias directly under the IC for improved thermal performance.

If short circuit or overload conditions are present, the device is protected by limiting internal power dissipation.

## 12 Device and Documentation Support

### 12.1 Device Support

#### 12.1.1 Third-Party Products Disclaimer

TI'S PUBLICATION OF INFORMATION REGARDING THIRD-PARTY PRODUCTS OR SERVICES DOES NOT CONSTITUTE AN ENDORSEMENT REGARDING THE SUITABILITY OF SUCH PRODUCTS OR SERVICES OR A WARRANTY, REPRESENTATION OR ENDORSEMENT OF SUCH PRODUCTS OR SERVICES, EITHER ALONE OR IN COMBINATION WITH ANY TI PRODUCT OR SERVICE.

#### 12.1.2 Development Support

##### 12.1.2.1 Custom Design With WEBENCH® Tools

[Click here](#) to create a custom design using the TPS629203-Q1 device with the WEBENCH® Power Designer.

1. Start by entering the input voltage ( $V_{IN}$ ), output voltage ( $V_{OUT}$ ), and output current ( $I_{OUT}$ ) requirements.
2. Optimize the design for key parameters such as efficiency, footprint, and cost using the optimizer dial.
3. Compare the generated design with other possible solutions from Texas Instruments.

The WEBENCH Power Designer provides a customized schematic along with a list of materials with real-time pricing and component availability.

In most cases, these actions are available:

- Run electrical simulations to see important waveforms and circuit performance
- Run thermal simulations to understand board thermal performance
- Export customized schematic and layout into popular CAD formats
- Print PDF reports for the design, and share the design with colleagues

Get more information about WEBENCH tools at [www.ti.com/WEBENCH](http://www.ti.com/WEBENCH).

### 12.2 Documentation Support

#### 12.2.1 Related Documentation

For related documentation see the following:

- Texas Instruments, [Thermal Characteristics of Linear and Logic Packages Using JEDEC PCB Designs Application Note](#)
- Texas Instruments, [Semiconductor and IC Package Thermal Metrics Application Note](#)
- Texas Instruments, [TPS629203-Q1EVM User's Guide](#)
- Texas Instruments, [Description Compensating the Current Mode Boost Control Loop Application Note](#)
- Texas Instruments, [Using the TPS6215x in an Inverting Buck-Boost Topology Application Note](#)
- Texas Instruments, [Optimizing the TPS62130/40/50/60 Output Filter Application Note](#)
- Texas Instruments, [Optimizing Transient Response of Internally Compensated DC-DC Converters Application Note](#)
- Texas Instruments, [Description Compensating the Current Mode Boost Control Loop Application Note](#)

#### 12.3 Receiving Notification of Documentation Updates

To receive notification of documentation updates, navigate to the device product folder on [ti.com](http://ti.com). Click on [Subscribe to updates](#) to register and receive a weekly digest of any product information that has changed. For change details, review the revision history included in any revised document.

#### 12.4 サポート・リソース

TI E2E™ サポート・フォーラムは、エンジニアが検証済みの回答と設計に関するヒントをエキスパートから迅速かつ直接得ることができる場所です。既存の回答を検索したり、独自の質問をしたりすることで、設計に必要な支援を迅速に得ることができます。

リンクされているコンテンツは、該当する貢献者により、現状のまま提供されるものです。これらは TI の仕様を構成するものではなく、必ずしも TI の見解を反映したものではありません。TI の [使用条件](#) を参照してください。

## 12.5 Trademarks

TI E2E™ is a trademark of Texas Instruments.

すべての商標は、それぞれの所有者に帰属します。

## 12.6 Electrostatic Discharge Caution



This integrated circuit can be damaged by ESD. Texas Instruments recommends that all integrated circuits be handled with appropriate precautions. Failure to observe proper handling and installation procedures can cause damage.

ESD damage can range from subtle performance degradation to complete device failure. Precision integrated circuits may be more susceptible to damage because very small parametric changes could cause the device not to meet its published specifications.

## 12.7 Glossary

[TI Glossary](#) This glossary lists and explains terms, acronyms, and definitions.

## 13 Mechanical, Packaging, and Orderable Information

The following pages include mechanical, packaging, and orderable information. This information is the most current data available for the designated devices. This data is subject to change without notice and revision of this document. For browser-based versions of this data sheet, refer to the left-hand navigation.

**PACKAGING INFORMATION**

| Orderable Device | Status<br>(1) | Package Type | Package Drawing | Pins | Package Qty | Eco Plan<br>(2) | Lead finish/<br>Ball material<br>(6) | MSL Peak Temp<br>(3) | Op Temp (°C) | Device Marking<br>(4/5) | Samples |
|------------------|---------------|--------------|-----------------|------|-------------|-----------------|--------------------------------------|----------------------|--------------|-------------------------|---------|
| TPS629203QDRLRQ1 | ACTIVE        | SOT-5X3      | DRL             | 8    | 4000        | RoHS & Green    | Call TI   SN                         | Level-1-260C-UNLIM   | -40 to 150   | T203                    | Samples |

(1) The marketing status values are defined as follows:

**ACTIVE:** Product device recommended for new designs.

**LIFEBUY:** TI has announced that the device will be discontinued, and a lifetime-buy period is in effect.

**NRND:** Not recommended for new designs. Device is in production to support existing customers, but TI does not recommend using this part in a new design.

**PREVIEW:** Device has been announced but is not in production. Samples may or may not be available.

**OBSELETE:** TI has discontinued the production of the device.

(2) **RoHS:** TI defines "RoHS" to mean semiconductor products that are compliant with the current EU RoHS requirements for all 10 RoHS substances, including the requirement that RoHS substance do not exceed 0.1% by weight in homogeneous materials. Where designed to be soldered at high temperatures, "RoHS" products are suitable for use in specified lead-free processes. TI may reference these types of products as "Pb-Free".

**RoHS Exempt:** TI defines "RoHS Exempt" to mean products that contain lead but are compliant with EU RoHS pursuant to a specific EU RoHS exemption.

**Green:** TI defines "Green" to mean the content of Chlorine (Cl) and Bromine (Br) based flame retardants meet JS709B low halogen requirements of <=1000ppm threshold. Antimony trioxide based flame retardants must also meet the <=1000ppm threshold requirement.

(3) MSL, Peak Temp. - The Moisture Sensitivity Level rating according to the JEDEC industry standard classifications, and peak solder temperature.

(4) There may be additional marking, which relates to the logo, the lot trace code information, or the environmental category on the device.

(5) Multiple Device Markings will be inside parentheses. Only one Device Marking contained in parentheses and separated by a "-" will appear on a device. If a line is indented then it is a continuation of the previous line and the two combined represent the entire Device Marking for that device.

(6) Lead finish/Ball material - Orderable Devices may have multiple material finish options. Finish options are separated by a vertical ruled line. Lead finish/Ball material values may wrap to two lines if the finish value exceeds the maximum column width.

**Important Information and Disclaimer:**The information provided on this page represents TI's knowledge and belief as of the date that it is provided. TI bases its knowledge and belief on information provided by third parties, and makes no representation or warranty as to the accuracy of such information. Efforts are underway to better integrate information from third parties. TI has taken and continues to take reasonable steps to provide representative and accurate information but may not have conducted destructive testing or chemical analysis on incoming materials and chemicals. TI and TI suppliers consider certain information to be proprietary, and thus CAS numbers and other limited information may not be available for release.

In no event shall TI's liability arising out of such information exceed the total purchase price of the TI part(s) at issue in this document sold by TI to Customer on an annual basis.

**OTHER QUALIFIED VERSIONS OF TPS629203-Q1 :**

- Catalog : [TPS629203](#)

NOTE: Qualified Version Definitions:

- Catalog - TI's standard catalog product



# EXAMPLE BOARD LAYOUT

DRL0008A

SOT-5X3 - 0.6 mm max height

PLASTIC SMALL OUTLINE

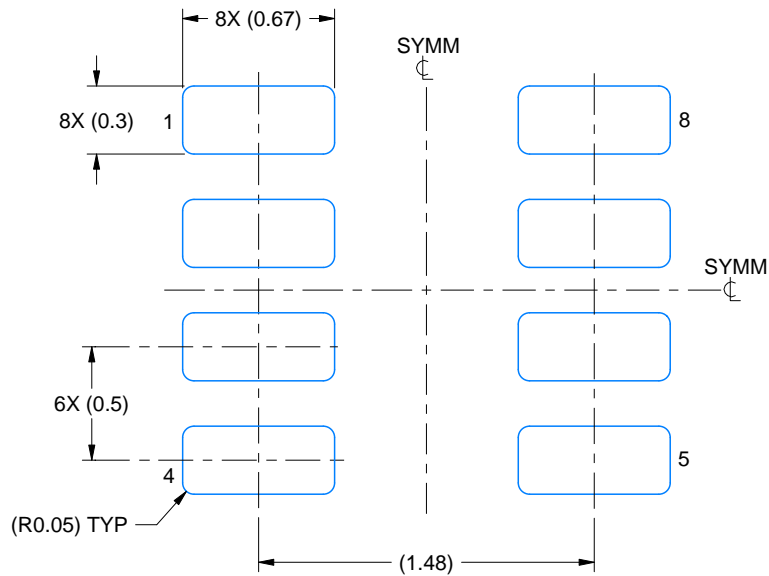

LAND PATTERN EXAMPLE  
EXPOSED METAL SHOWN  
SCALE:30X

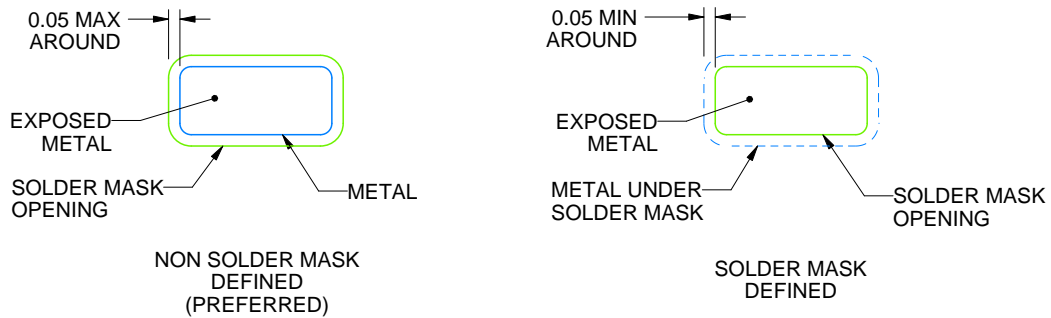

SOLDERMASK DETAILS

4224486/E 12/2021

NOTES: (continued)

5. Publication IPC-7351 may have alternate designs.
6. Solder mask tolerances between and around signal pads can vary based on board fabrication site.
7. Land pattern design aligns to IPC-610, Bottom Termination Component (BTC) solder joint inspection criteria.



# EXAMPLE STENCIL DESIGN

DRL0008A

SOT-5X3 - 0.6 mm max height

PLASTIC SMALL OUTLINE

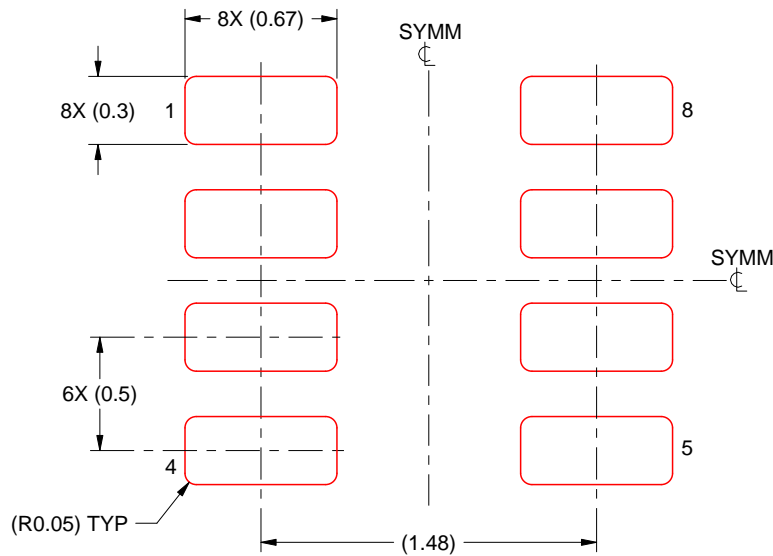

SOLDER PASTE EXAMPLE  
BASED ON 0.1 mm THICK STENCIL  
SCALE:30X

4224486/E 12/2021

NOTES: (continued)

8. Laser cutting apertures with trapezoidal walls and rounded corners may offer better paste release. IPC-7525 may have alternate design recommendations.
9. Board assembly site may have different recommendations for stencil design.

## 重要なお知らせと免責事項

TI は、技術データと信頼性データ (データシートを含みます)、設計リソース (リファレンス・デザインを含みます)、アプリケーションや設計に関する各種アドバイス、Web ツール、安全性情報、その他のリソースを、欠陥が存在する可能性のある「現状のまま」提供しており、商品性および特定目的に対する適合性の黙示保証、第三者の知的財産権の非侵害保証を含むいかなる保証も、明示的または黙示的にかかわらず拒否します。

これらのリソースは、TI 製品を使用する設計の経験を積んだ開発者への提供を意図したものです。(1) お客様のアプリケーションに適した TI 製品の選定、(2) お客様のアプリケーションの設計、検証、試験、(3) お客様のアプリケーションに該当する各種規格や、その他のあらゆる安全性、セキュリティ、規制、または他の要件への確実な適合に関する責任を、お客様のみが単独で負うものとし、

上記の各種リソースは、予告なく変更される可能性があります。これらのリソースは、リソースで説明されている TI 製品を使用するアプリケーションの開発の目的でのみ、TI はその使用をお客様に許諾します。これらのリソースに関して、他の目的で複製することや掲載することは禁止されています。TI や第三者の知的財産権のライセンスが付与されている訳ではありません。お客様は、これらのリソースを自身で使用した結果発生するあらゆる申し立て、損害、費用、損失、責任について、TI およびその代理人を完全に補償するものとし、TI は一切の責任を拒否します。

TI の製品は、[TI の販売条件](#)、または [ti.com](https://www.ti.com) やかかる TI 製品の関連資料などのいずれかを通じて提供する適用可能な条項の下で提供されています。TI がこれらのリソースを提供することは、適用される TI の保証または他の保証の放棄の拡大や変更を意味するものではありません。

お客様がいかなる追加条項または代替条項を提案した場合でも、TI はそれらに異議を唱え、拒否します。

郵送先住所 : Texas Instruments, Post Office Box 655303, Dallas, Texas 75265  
Copyright © 2023, Texas Instruments Incorporated