

TPS74801-Q1 車載対応、プログラマブル・ソフトスタート機能搭載、1.5A、低ドロップアウト・リニア・レギュレータ

1 特長

- 車載アプリケーション用に AEC-Q100 認定済み:
 - 温度グレード 1: $-40^{\circ}\text{C} \sim +125^{\circ}\text{C}$, T_A
- V_{OUT} 範囲: $0.8\text{V} \sim 3.6\text{V}$
- 非常に低い V_{IN} 範囲: $0.8\text{V} \sim 5.5\text{V}$
- V_{BIAS} 範囲: $2.7\text{V} \sim 5.5\text{V}$
- 低いドロップアウト: 60mV (標準値)、 1.5A , $V_{\text{BIAS}} = 5\text{V}$
- パワー・グッド (PG) 出力により、電源電圧を監視し、他の電源のシーケンシング信号を供給
- ライン、負荷、温度の各範囲にわたって 2% の精度
- プログラム可能なソフトスタートにより、直線的に電圧が立ち上がるようにスタートアップさせることが可能
- V_{BIAS} により、優れた過渡応答の低 V_{IN} 動作を実現
- 任意の出力コンデンサ ($\geq 2.2\mu\text{F}$) で安定動作
- 小型の $3\text{mm} \times 3\text{mm} \times 1\text{mm}$ VSON-10 および $5\text{mm} \times 5\text{mm}$ VQFN-20 パッケージで供給されます

2 アプリケーション

- テレマティクス制御ユニット
- インフォテインメントおよびクラスタ
- 車載ヘッド・ユニット
- 中距離 / 短距離レーダー

3 概要

TPS74801-Q1 低ドロップアウト (LDO) リニア・レギュレータは、広範なアプリケーション向けの使いやすく堅牢な電力管理ソリューションです。ソフトスタートをユーザーがプログラムできるので、スタートアップ時の容量性突入電流を低減して、入力電源のストレスを最小限に抑えることができます。ソフトスタートは単調性で、多くの種類のプロセッサや ASIC の電源供給向けに設計されています。イネーブル入力とパワー・グッド出力により、外部レギュレータとの間でシーケンシングを簡単に実行できます。この優れた柔軟性により、FPGA、DSP、および特殊なスタートアップ要件を持つ他のアプリケーションのシーケンス要件を満たすソリューションを構成できます。

高精度の基準電圧およびエラー・アンプは、負荷、ライン、温度、プロセスの全体にわたって 2% の精度を維持します。このデバイスは $2.2\mu\text{F}$ 以上の任意のタイプの出カコンデンサで安定して動作し、新しいチップでは $T_J = -40^{\circ}\text{C} \sim +150^{\circ}\text{C}$ 、DRC パッケージでは $T_J = -40^{\circ}\text{C} \sim +105^{\circ}\text{C}$ 、RGW パッケージでは $T_J = -40^{\circ}\text{C} \sim +125^{\circ}\text{C}$ で完全に動作が規定されています。TPS74801-Q1 は $3\text{mm} \times 3\text{mm}$ の小型 VSON-10 パッケージで供給され、ソリューションの総合的な小型化に役立ちます。このデバイスは、 $5\text{mm} \times 5\text{mm}$ の VQFN-20 パッケージで供給されます。

パッケージ情報

部品番号	パッケージ (1)	パッケージ サイズ (2)
TPS74801-Q1	DRC (VSON, 10)	$3\text{mm} \times 3\text{mm}$
	RGW (VQFN, 20)	$5\text{mm} \times 5\text{mm}$

- 詳細については、「[メカニカル、パッケージ、および注文情報](#)」を参照してください。
- パッケージ・サイズ (長さ×幅) は公称値であり、該当する場合はピンも含まれます。

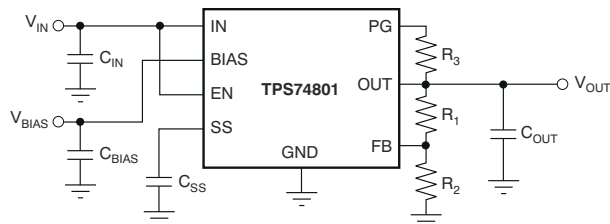

代表的なアプリケーション回路 (可変)

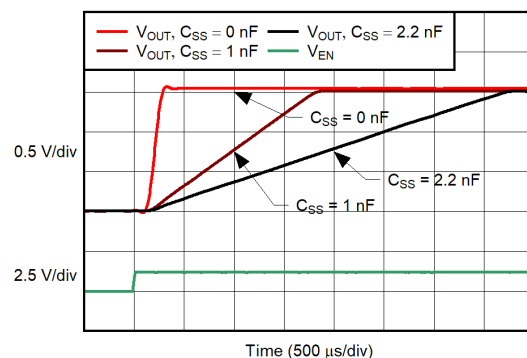

ターンオン応答



Table of Contents

1 特長	1	6.4 Device Functional Modes.....	19
2 アプリケーション	1	7 Application and Implementation	20
3 概要	1	7.1 Application Information.....	20
4 Pin Configuration and Functions	3	7.2 Typical Application.....	20
5 Specifications	4	7.3 Power Supply Recommendations.....	22
5.1 Absolute Maximum Ratings.....	4	7.4 Layout.....	22
5.2 ESD Ratings.....	4	8 Device and Documentation Support	26
5.3 Recommended Operating Conditions.....	4	8.1 Documentation Support.....	26
5.4 Thermal Information.....	5	8.2 ドキュメントの更新通知を受け取る方法.....	26
5.5 Electrical Characteristics.....	6	8.3 サポート・リソース.....	26
5.6 Typical Characteristics: $I_{OUT} = 50\text{ mA}$	8	8.4 Trademarks.....	26
5.7 Typical Characteristics: $I_{OUT} = 1\text{ A}$	13	8.5 静電気放電に関する注意事項.....	26
6 Detailed Description	15	8.6 用語集.....	26
6.1 Overview.....	15	9 Revision History	27
6.2 Functional Block Diagram.....	15	10 Mechanical, Packaging, and Orderable Information	27
6.3 Feature Description.....	15		

4 Pin Configuration and Functions



図 4-1. DRC Package, 10-Pin VSON With Exposed Thermal Pad (Top View)



図 4-2. RGW Package, 20-Pin VQFN With Exposed Thermal Pad (Top View)

表 4-1. Pin Functions

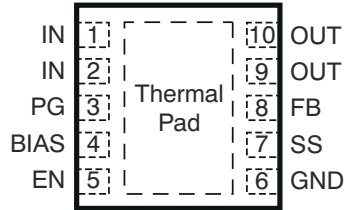
NAME	PIN NO.		TYPE	DESCRIPTION
	DRC (VSON)	RGW (VQFN)		
BIAS	4	10	I	Bias input voltage for error amplifier, reference, and internal control circuits.
EN	5	11	I	Enable pin. Driving this pin high enables the regulator. Driving this pin low puts the regulator into shutdown mode. This pin must not be left unconnected.
FB	8	16	I	Feedback pin. The feedback connection to the center tap of an external resistor divider network that sets the output voltage. This pin must not be left floating.
GND	6	12	—	Ground
IN	1, 2	5-8	I	Input to the device.
NC	N/A	2-4, 13, 14, 17	—	No connection. This pin can be left floating or connected to GND to allow better thermal contact to the top-side plane.
OUT	9, 10	1, 18-20	O	Regulated output voltage. A small capacitor (total typical capacitance $\geq 2.2 \mu\text{F}$, ceramic) is needed from this pin to ground to provide stability.
PG	3	9	O	Power-good pin. An open-drain, active-high output that indicates the status of V_{OUT} . When V_{OUT} exceeds the PG trip threshold, the PG pin goes into a high-impedance state. When V_{OUT} is below this threshold the pin is driven to a low-impedance state. Connect a pullup resistor from 10 k Ω to 1 M Ω from this pin to a supply of up to 5.5 V. The supply can be higher than the input voltage. Alternatively, the PG pin can be left unconnected if output monitoring is not necessary.
SS	7	15	—	Soft-start pin. A capacitor connected on this pin to ground sets the start-up time. If this pin is left unconnected, the regulator output soft-start ramp time is typically 200 μs .
Thermal Pad			—	Solder the thermal pad to the ground plane for increased thermal performance.

5 Specifications

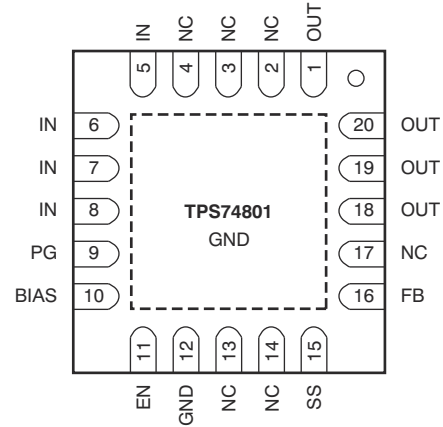
5.1 Absolute Maximum Ratings

over operating temperature range (unless otherwise noted)⁽¹⁾

		MIN	MAX	UNIT
V_{IN}, V_{BIAS}	Input voltage	-0.3	6	V
V_{EN}	Enable voltage	-0.3	6	V
V_{PG}	Power good voltage	-0.3	6	V
I_{PG}	PG sink current	0	1.5	mA
V_{SS}	Soft-start voltage	-0.3	6	V
V_{FB}	Feedback voltage	-0.3	6	V
V_{OUT}	Output voltage	-0.3	$V_{IN} + 0.3$	V
I_{OUT}	Output current	Internally limited		
I_{CL}	Output short-circuit duration	Indefinite		
P_{DISS}	Continuous total power dissipation	See Thermal Information		
T_{stg}	Junction temperature	-40	150	°C
	Storage temperature	-55	150	

- (1) Stresses beyond those listed under Absolute Maximum Ratings may cause permanent damage to the device. These are stress ratings only, which do not imply functional operation of the device at these or any other conditions beyond those indicated under Recommended Operating Conditions. Exposure to absolute-maximum-rated conditions for extended periods may affect device reliability.

5.2 ESD Ratings

		VALUE	UNIT
$V_{(ESD)}$	Electrostatic discharge	Human body model (HBM), per AEC Q100-002 ⁽¹⁾	±2000
		Charged device model (CDM), per AEC specification Q100-011	±500

- (1) AEC Q100-002 indicates that HBM stressing shall be in accordance with the ANSI/ESDA/JEDEC JS-001 specification.

5.3 Recommended Operating Conditions

over operating free-air temperature range (unless otherwise noted)

		MIN	NOM	MAX	UNIT
V_{IN}	Input supply voltage	$V_{OUT} + V_{DO}$ (V_{IN})	$V_{OUT} + 0.3$	5.5	V
V_{EN}	Enable supply voltage		V_{IN}	5.5	V
V_{BIAS} ⁽¹⁾	Bias supply voltage	$V_{OUT} + V_{DO}$ (V_{BIAS}) ⁽²⁾	$V_{OUT} + 1.6$ ⁽²⁾	5.5	V
V_{OUT}	Output voltage	0.8		3.6	V
I_{OUT}	Output current	0		1.5	A
C_{OUT}	Output capacitor	2.2			μF
C_{IN}	Input capacitor ⁽³⁾	1			μF
C_{BIAS}	Bias capacitor	0.1	1		μF
T_J	Operating junction temperature	-40		150	°C

- (1) BIAS supply is required when V_{IN} is below $V_{OUT} + 1.62$ V.
(2) V_{BIAS} has a minimum voltage of 2.7 V or $V_{OUT} + V_{DO}$ (V_{BIAS}), whichever is higher.
(3) If V_{IN} and V_{BIAS} are connected to the same supply, the recommended minimum capacitor for the supply is 4.7 μF.

5.4 Thermal Information

THERMAL METRIC ⁽¹⁾		TPS74801-Q1			UNIT
		RGW (VQFN)	DRC (VSON)	DRC (VSON) ⁽²⁾	
		20 PINS	10 PINS	10 PINS	
$R_{\theta JA}$	Junction-to-ambient thermal resistance	35.6	44.2	47.2	°C/W
$R_{\theta JC(top)}$	Junction-to-case (top) thermal resistance	33.3	50.3	63.7	°C/W
$R_{\theta JB}$	Junction-to-board thermal resistance	15	19.6	19.5	°C/W
ψ_{JT}	Junction-to-top characterization parameter	0.4	0.7	4.2	°C/W
ψ_{JB}	Junction-to-board characterization parameter	15.2	17.8	19.4	°C/W
$R_{\theta JC(bot)}$	Junction-to-case (bottom) thermal resistance	3.8	4.3	3.3	°C/W

- (1) For more information about traditional and new thermal metrics, see the [Semiconductor and IC package thermal metrics application report](#).
- (2) New Chip.

5.5 Electrical Characteristics

at $V_{EN} = 1.1\text{ V}$, $V_{IN} = V_{OUT} + 0.3\text{ V}$, $C_{BIAS} = 0.1\text{ }\mu\text{F}$, $C_{IN} = C_{OUT} = 10\text{ }\mu\text{F}$, $C_{NR} = 1\text{ nF}$, $I_{OUT} = 50\text{ mA}$, $V_{BIAS} = 5.0\text{ V}$, $T_A = -40^\circ\text{C}$ to 105°C (DRC), $T_A = -40^\circ\text{C}$ to 125°C (RGW) and $T_J = -40$ to 150°C (New Chip) (unless otherwise noted); typical values are at $T_J = 25^\circ\text{C}$

PARAMETER		TEST CONDITIONS	MIN	TYP	MAX	UNIT
V_{REF}	Internal reference (Adj.)	$T_A = 25^\circ\text{C}$	0.796	0.8	0.804	V
V_{OUT}	Output voltage range	$V_{IN} = 5\text{ V}$, $I_{OUT} = 1.5\text{ A}$	V_{REF}		3.6	V
	Accuracy ⁽¹⁾	$2.97\text{ V} \leq V_{BIAS} \leq 5.5\text{ V}$, $50\text{ mA} \leq I_{OUT} \leq 1.5\text{ A}$ (Legacy Chip)	-2	± 0.5	2	%
		$2.97\text{ V} \leq V_{BIAS} \leq 5.5\text{ V}$, $50\text{ mA} \leq I_{OUT} \leq 1.5\text{ A}$ (New Chip)	-1.35	± 0.3	1.35	
ΔV_{OUT} (ΔV_{IN})	Line regulation	$V_{OUT(nom)} + 0.3 \leq V_{IN} \leq 5.5\text{ V}$ (Legacy Chip)		0.03		%/ V
		$V_{OUT(nom)} + 0.3 \leq V_{IN} \leq 5.5\text{ V}$ (New Chip)		0.001		
ΔV_{OUT} (ΔI_{OUT})	Load regulation	$50\text{ mA} \leq I_{OUT} \leq 1.5\text{ A}$		0.09		%/ A
V_{DO}	V_{IN} dropout voltage ⁽²⁾	$I_{OUT} = 1.5\text{ A}$, $V_{BIAS} - V_{OUT(nom)} \geq 3.25\text{ V}$ (Legacy Chip) ⁽³⁾		60	165	mV
		$I_{OUT} = 1.5\text{ A}$, $V_{BIAS} - V_{OUT(nom)} \geq 3.25\text{ V}$ (New Chip) ⁽³⁾		50	100	
	V_{BIAS} dropout voltage ⁽²⁾	$I_{OUT} = 1.5\text{ A}$, $V_{IN} = V_{BIAS}$ (Legacy Chip)		1.31	1.6	V
	$I_{OUT} = 1.5\text{ A}$, $V_{IN} = V_{BIAS}$ (New Chip)		1.31	1.43		
I_{CL}	Output current limit	$V_{OUT} = 80\% \times V_{OUT(nom)}$	2		5.5	A
I_{BIAS}	BIAS pin current	(Legacy Chip)		1	2	mA
		(New Chip)		1	1.2	
I_{SHDN}	Shutdown supply current (I_{GND})	$V_{EN} \leq 0.4\text{ V}$ (Legacy Chip)		1	50	μA
		$V_{EN} \leq 0.4\text{ V}$ (New Chip)		0.85	10	
I_{FB}	Feedback pin current	(Legacy Chip)	-1	0.15	1	μA
		(New Chip)	-30	0.15	30	nA
PSRR	Power-supply rejection (V_{IN} to V_{OUT})	1 kHz, $I_{OUT} = 1.5\text{ A}$, $V_{IN} = 1.8\text{ V}$, $V_{OUT} = 1.5\text{ V}$ (Legacy Chip)		60		dB
		1 kHz, $I_{OUT} = 1.5\text{ A}$, $V_{IN} = 1.8\text{ V}$, $V_{OUT} = 1.5\text{ V}$ (New Chip)		69		
		300 kHz, $I_{OUT} = 1.5\text{ A}$, $V_{IN} = 1.8\text{ V}$, $V_{OUT} = 1.5\text{ V}$ (Legacy Chip)		30		
		300 kHz, $I_{OUT} = 1.5\text{ A}$, $V_{IN} = 1.8\text{ V}$, $V_{OUT} = 1.5\text{ V}$ (New Chip)		49		
	Power-supply rejection (V_{BIAS} to V_{OUT})	1 kHz, $I_{OUT} = 1.5\text{ A}$, $V_{IN} = 1.8\text{ V}$, $V_{OUT} = 1.5\text{ V}$ (Legacy Chip)		50		dB
		1 kHz, $I_{OUT} = 1.5\text{ A}$, $V_{IN} = 1.8\text{ V}$, $V_{OUT} = 1.5\text{ V}$ (New Chip)		59		
		300 kHz, $I_{OUT} = 1.5\text{ A}$, $V_{IN} = 1.8\text{ V}$, $V_{OUT} = 1.5\text{ V}$ (Legacy Chip)		30		
		300 kHz, $I_{OUT} = 1.5\text{ A}$, $V_{IN} = 1.8\text{ V}$, $V_{OUT} = 1.5\text{ V}$ (New Chip)		50		
V_n	Output noise voltage	BW = 100 Hz to 100 kHz, $I_{OUT} = 1.5\text{ A}$, $C_{SS} = 1\text{ nF}$ (Legacy Chip)		$25 \times V_{OUT}$		μVrms
		BW = 100 Hz to 100 kHz, $I_{OUT} = 1.5\text{ A}$, $C_{SS} = 1\text{ nF}$ (New Chip)		$20 \times V_{OUT}$		
t_{STR}	Minimum startup time	R_{LOAD} for $I_{OUT} = 1.0\text{ A}$, $C_{SS} = \text{open}$ (Legacy Chip)		200		μs
		R_{LOAD} for $I_{OUT} = 1.0\text{ A}$, $C_{SS} = \text{open}$ (New Chip)		250		
I_{SS}	Soft-start charging current	$V_{SS} = 0.4\text{ V}$ (Legacy Chip)		440		nA
		$V_{SS} = 0.4\text{ V}$ (New Chip)		530		

5.5 Electrical Characteristics (続き)

at $V_{EN} = 1.1\text{ V}$, $V_{IN} = V_{OUT} + 0.3\text{ V}$, $C_{BIAS} = 0.1\text{ }\mu\text{F}$, $C_{IN} = C_{OUT} = 10\text{ }\mu\text{F}$, $C_{NR} = 1\text{ nF}$, $I_{OUT} = 50\text{ mA}$, $V_{BIAS} = 5.0\text{ V}$, $T_A = -40^\circ\text{C}$ to 105°C (DRC), $T_A = -40^\circ\text{C}$ to 125°C (RGW) and $T_J = -40$ to 150°C (New Chip) (unless otherwise noted); typical values are at $T_J = 25^\circ\text{C}$

PARAMETER		TEST CONDITIONS	MIN	TYP	MAX	UNIT
$V_{EN(hi)}$	Enable input high level		1.1		5.5	V
$V_{EN(lo)}$	Enable input low level		0		0.4	V
$V_{EN(hys)}$	Enable pin hysteresis	(Legacy Chip)		50		mV
		(New Chip)		55		
$V_{EN(dg)}$	Enable pin deglitch time			20		μs
I_{EN}	Enable pin current	$V_{EN} = 5\text{ V}$ (Legacy Chip)		0.1	1	μA
		$V_{EN} = 5\text{ V}$ (New Chip)		0.1	0.3	
V_{IT}	PG trip threshold	V_{OUT} decreasing	85	90	94	$\%V_{OUT}$
V_{HYS}	PG trip hysteresis			3		$\%V_{OUT}$
$V_{PG(lo)}$	PG output low voltage	$I_{PG} = 1\text{ mA}$ (sinking), $V_{OUT} < V_{IT}$ (Legacy Chip)			0.3	V
		$I_{PG} = 1\text{ mA}$ (sinking), $V_{OUT} < V_{IT}$ (New Chip)			0.125	
$I_{PG(lkg)}$	PG leakage current	$V_{PG} = 5.25\text{ V}$, $V_{OUT} > V_{IT}$ (Legacy Chip)		0.1	1	μA
		$V_{PG} = 5.25\text{ V}$, $V_{OUT} > V_{IT}$ (New Chip)		0.001	0.05	
T_{SD}	Thermal shutdown temperature	Shutdown, temperature increasing		165		$^\circ\text{C}$
		Reset, temperature decreasing		140		

- (1) Adjustable devices tested at 0.8 V; resistor tolerance is not taken into account.
- (2) Dropout is defined as the voltage from V_{IN} to V_{OUT} when V_{OUT} is 3% below nominal.
- (3) 3.25 V is a test condition of this device and can be adjusted by referring to Figure 6-6.

5.6 Typical Characteristics: I_{OUT} = 50 mA

at T_J = 25°C, V_{IN} = V_{OUT(nom)} + 0.3 V, V_{BIAS} = 5 V, I_{OUT} = 50 mA, V_{EN} = V_{IN}, C_{IN} = 1 μF, C_{BIAS} = 4.7 μF, and C_{OUT} = 10 μF (unless otherwise noted)



图 5-1. V_{IN} Line Regulation



图 5-2. V_{IN} Line Regulation

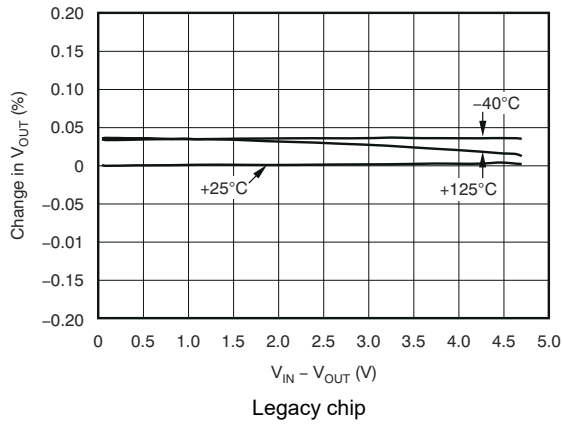

图 5-3. V_{BIAS} Line Regulation

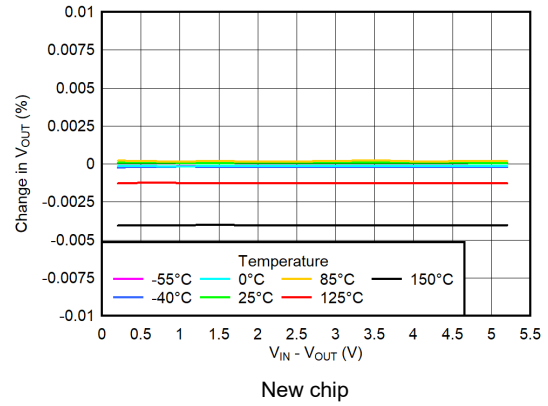

图 5-4. V_{BIAS} Line Regulation

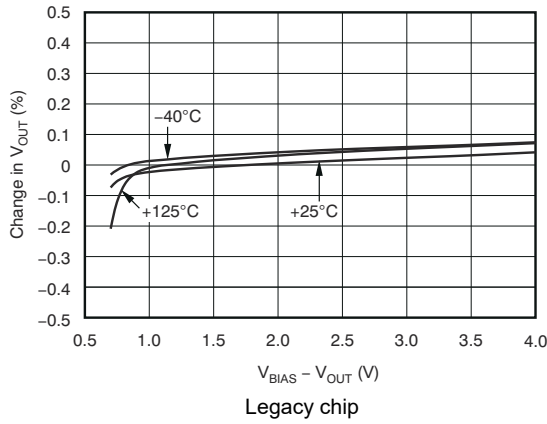

图 5-5. Load Regulation at Light Load

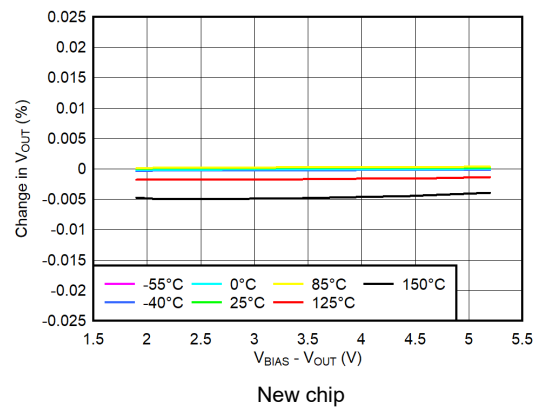

图 5-6. Load Regulation at Light Load

5.6 Typical Characteristics: $I_{OUT} = 50 \text{ mA}$ (continued)

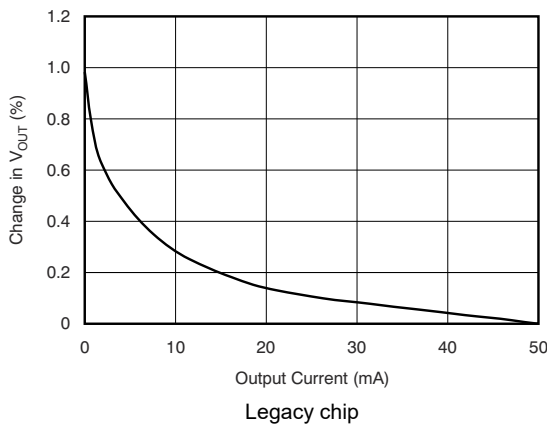
at $T_J = 25^\circ\text{C}$, $V_{IN} = V_{OUT(nom)} + 0.3 \text{ V}$, $V_{BIAS} = 5 \text{ V}$, $I_{OUT} = 50 \text{ mA}$, $V_{EN} = V_{IN}$, $C_{IN} = 1 \mu\text{F}$, $C_{BIAS} = 4.7 \mu\text{F}$, and $C_{OUT} = 10 \mu\text{F}$ (unless otherwise noted)

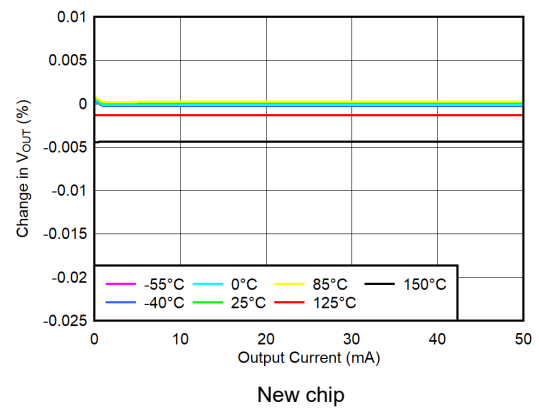
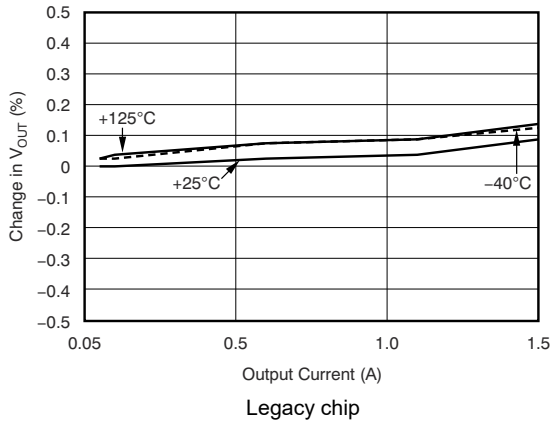

5-7. Load Regulation

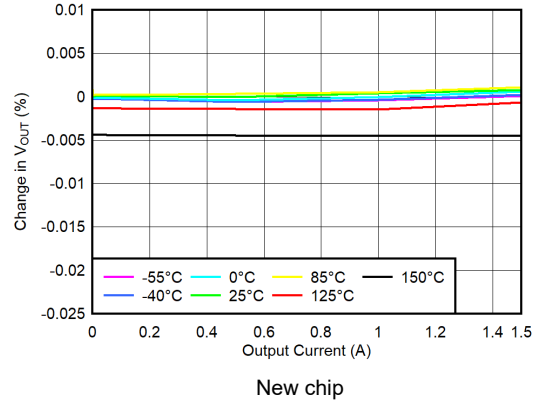

5-8. Load Regulation

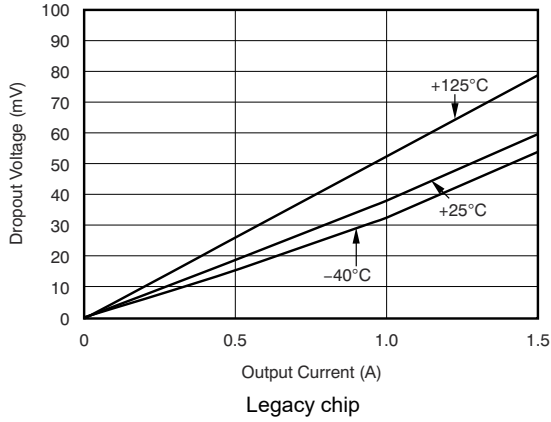

5-9. V_{IN} Dropout Voltage vs I_{OUT} and Temperature (T_J)

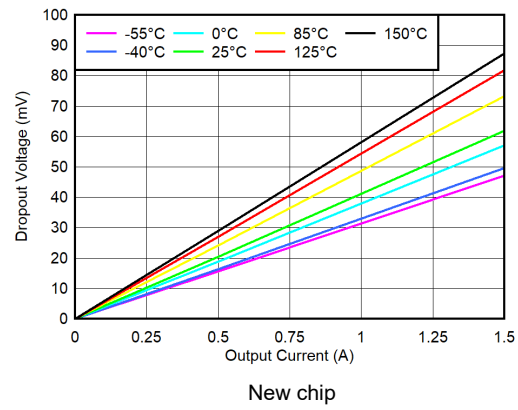

5-10. V_{IN} Dropout Voltage vs I_{OUT} and Temperature (T_J)

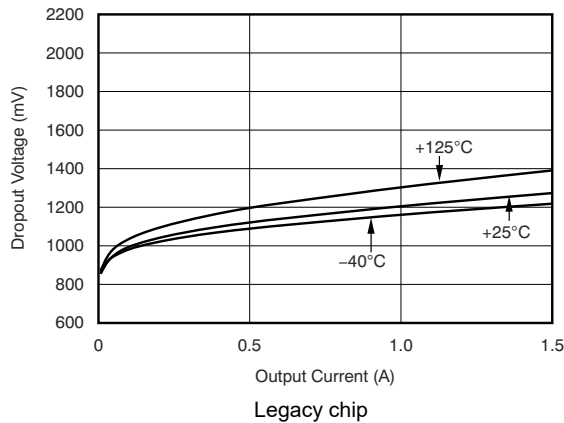

5-11. V_{BIAS} Dropout Voltage vs I_{OUT} and Temperature (T_J)

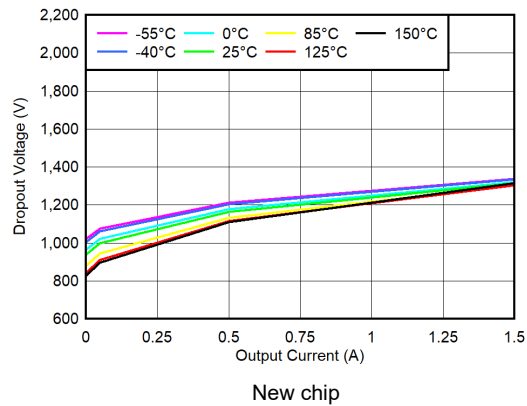

5-12. V_{BIAS} Dropout Voltage vs I_{OUT} and Temperature (T_J)

5.6 Typical Characteristics: $I_{OUT} = 50\text{ mA}$ (continued)

at $T_J = 25^\circ\text{C}$, $V_{IN} = V_{OUT(nom)} + 0.3\text{ V}$, $V_{BIAS} = 5\text{ V}$, $I_{OUT} = 50\text{ mA}$, $V_{EN} = V_{IN}$, $C_{IN} = 1\text{ }\mu\text{F}$, $C_{BIAS} = 4.7\text{ }\mu\text{F}$, and $C_{OUT} = 10\text{ }\mu\text{F}$ (unless otherwise noted)

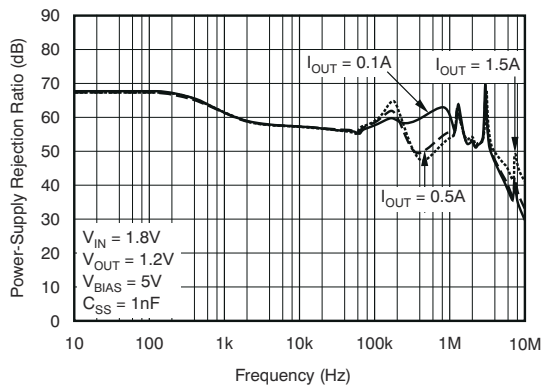

Figure 5-13. V_{BIAS} PSRR vs Frequency

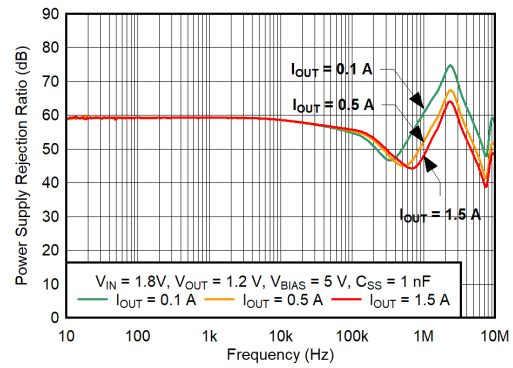

Figure 5-14. V_{BIAS} PSRR vs Frequency

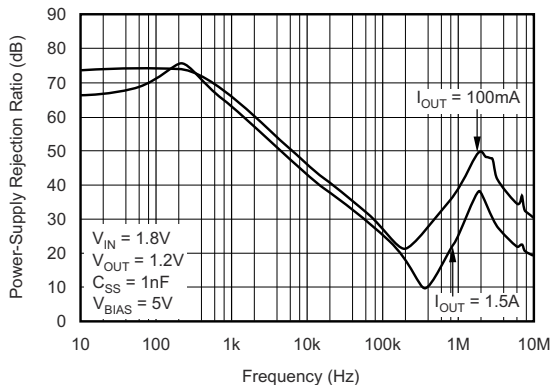

Figure 5-15. V_{IN} PSRR vs Frequency

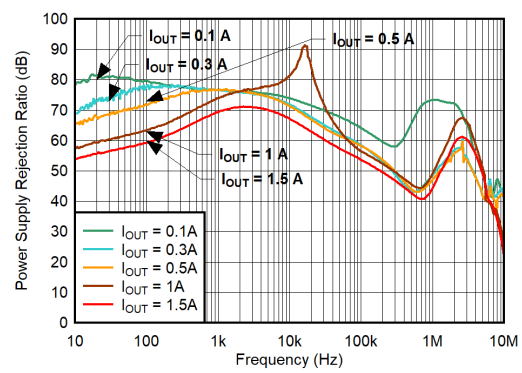

Figure 5-16. V_{IN} PSRR vs Frequency

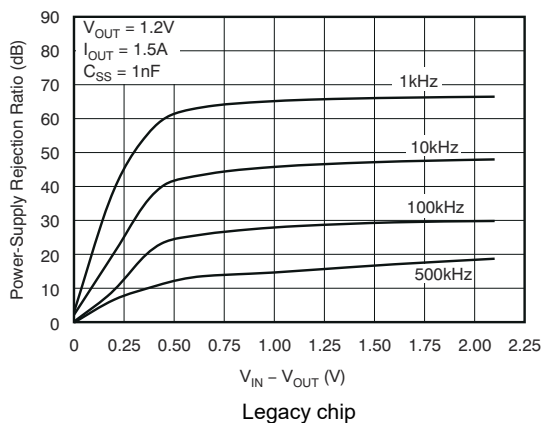

Figure 5-17. V_{IN} PSRR vs $(V_{IN} - V_{OUT})$

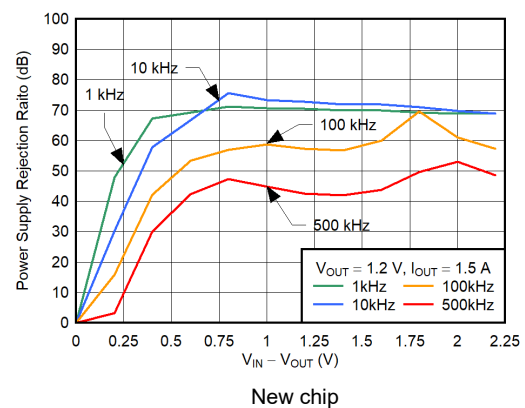
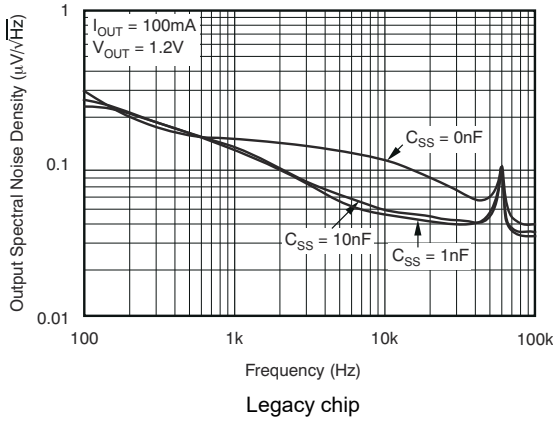

Figure 5-18. V_{IN} PSRR vs $(V_{IN} - V_{OUT})$

5.6 Typical Characteristics: I_{OUT} = 50 mA (continued)

at T_J = 25°C, V_{IN} = V_{OUT(nom)} + 0.3 V, V_{BIAS} = 5 V, I_{OUT} = 50 mA, V_{EN} = V_{IN}, C_{IN} = 1 μF, C_{BIAS} = 4.7 μF, and C_{OUT} = 10 μF (unless otherwise noted)



5-19. Noise Spectral Density

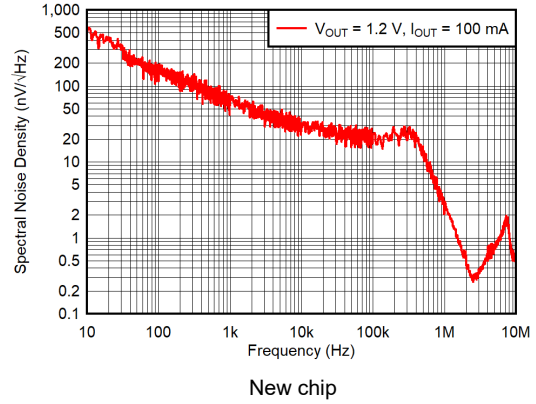

5-20. Noise Spectral Density

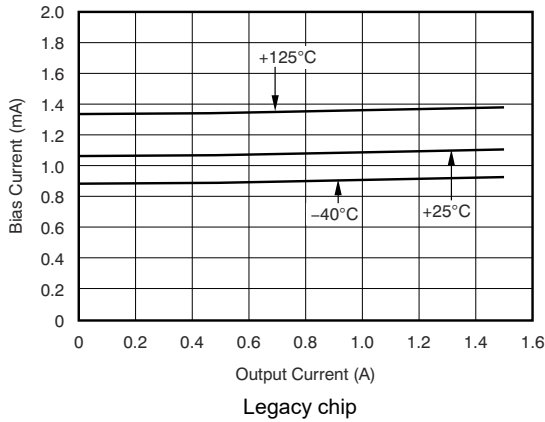

5-21. BIAS Pin Current vs Output Current and Temperature (T_J)

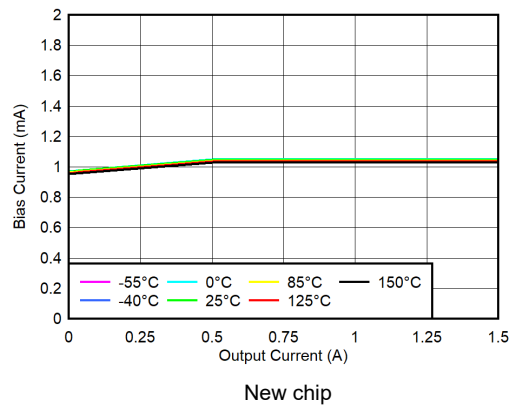

5-22. BIAS Pin Current vs Output Current and Temperature (T_J)

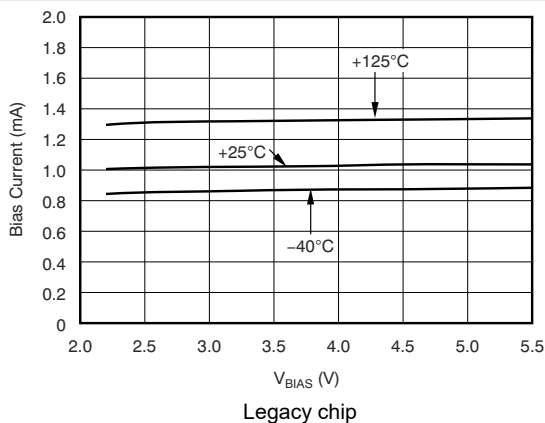

5-23. BIAS Pin Current vs V_{BIAS} and Temperature (T_J)

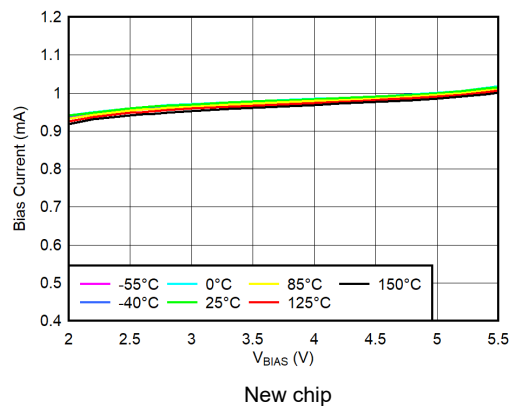

5-24. BIAS Pin Current vs V_{BIAS} and Temperature (T_J)

5.6 Typical Characteristics: I_{OUT} = 50 mA (continued)

at T_J = 25°C, V_{IN} = V_{OUT(nom)} + 0.3 V, V_{BIAS} = 5 V, I_{OUT} = 50 mA, V_{EN} = V_{IN}, C_{IN} = 1 μF, C_{BIAS} = 4.7 μF, and C_{OUT} = 10 μF (unless otherwise noted)

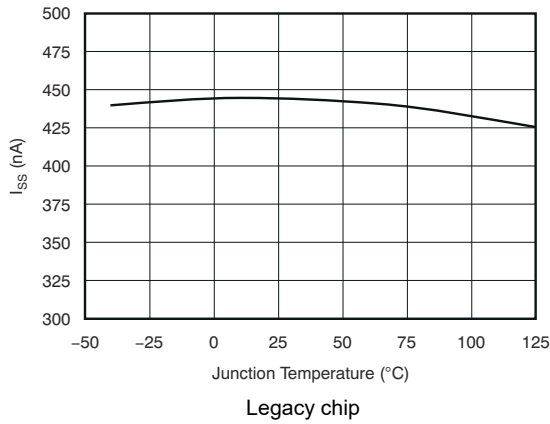

Figure 5-25. Soft-Start Charging Current (I_{SS}) vs Temperature (T_J)

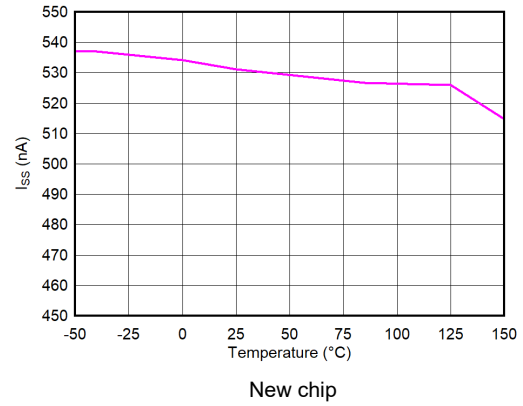

Figure 5-26. Soft-Start Charging Current (I_{SS}) vs Temperature (T_J)

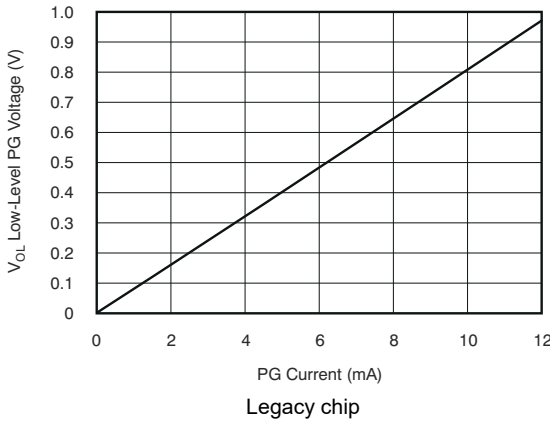

Figure 5-27. Low-Level PG Voltage vs Current

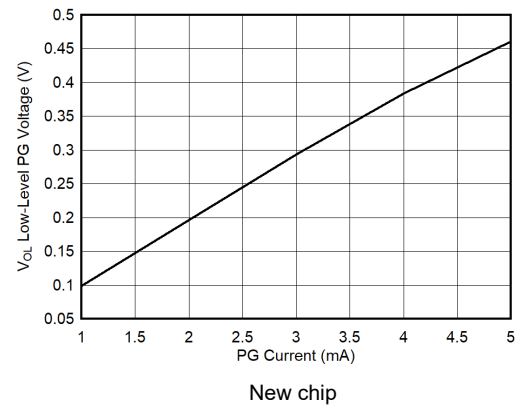

Figure 5-28. Low-Level PG Voltage vs Current

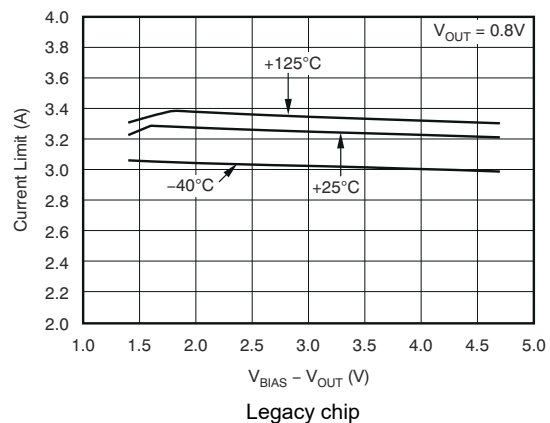

Figure 5-29. Current Limit vs (V_{BIAS} - V_{OUT})

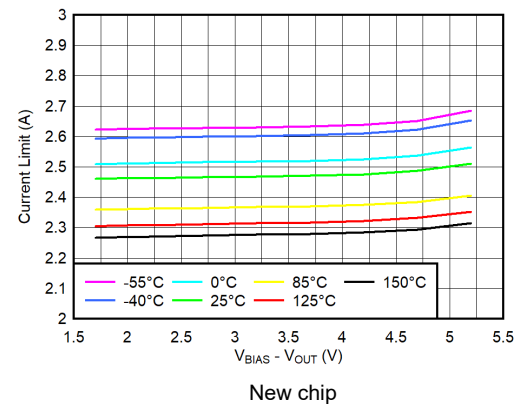

Figure 5-30. Current Limit vs (V_{BIAS} - V_{OUT})

5.7 Typical Characteristics: $I_{OUT} = 1\text{ A}$

at $T_J = 25^\circ\text{C}$, $V_{IN} = V_{OUT(nom)} + 0.3\text{ V}$, $V_{BIAS} = 5\text{ V}$, $I_{OUT} = 1\text{ A}$, $V_{EN} = V_{IN} = 1.8\text{ V}$, $V_{OUT} = 1.5\text{ V}$, $C_{IN} = 1\text{ }\mu\text{F}$, $C_{BIAS} = 4.7\text{ }\mu\text{F}$, and $C_{OUT} = 10\text{ }\mu\text{F}$ (unless otherwise noted)

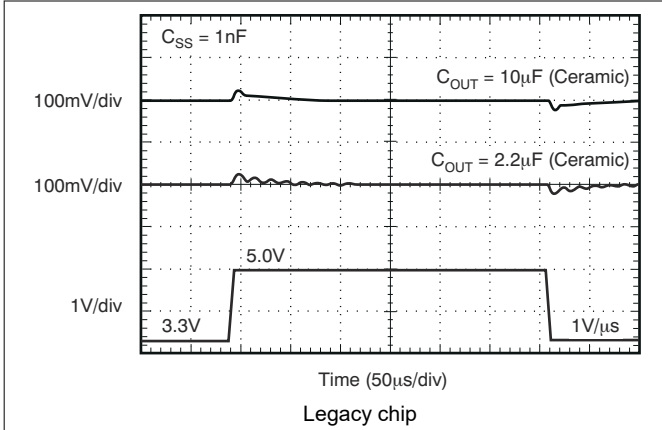

Figure 5-31. V_{BIAS} Line Transient

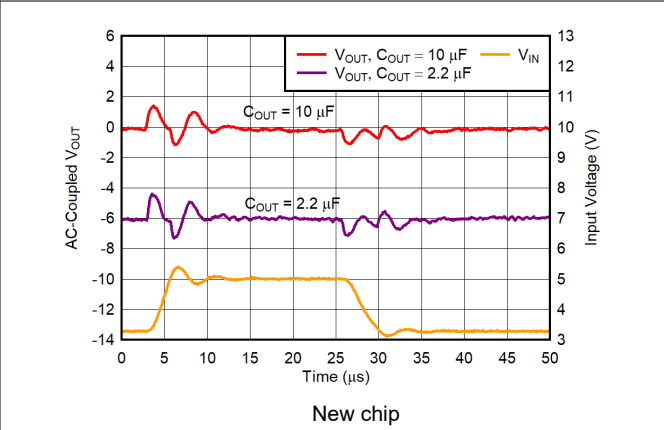

Figure 5-32. V_{BIAS} Line Transient

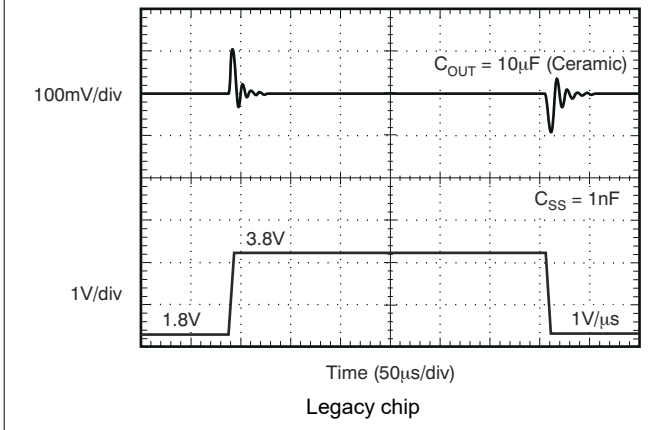

Figure 5-33. V_{IN} Line Transient

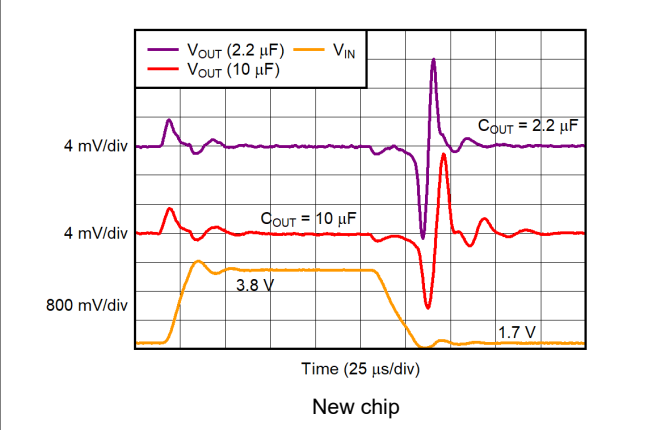

Figure 5-34. V_{IN} Line Transient

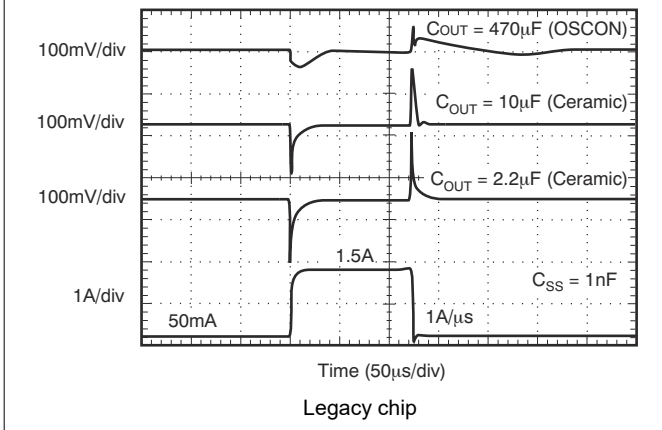

Figure 5-35. Output Load Transient Response

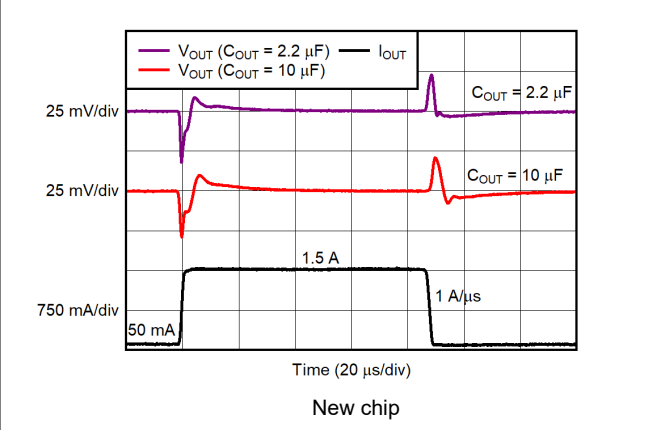
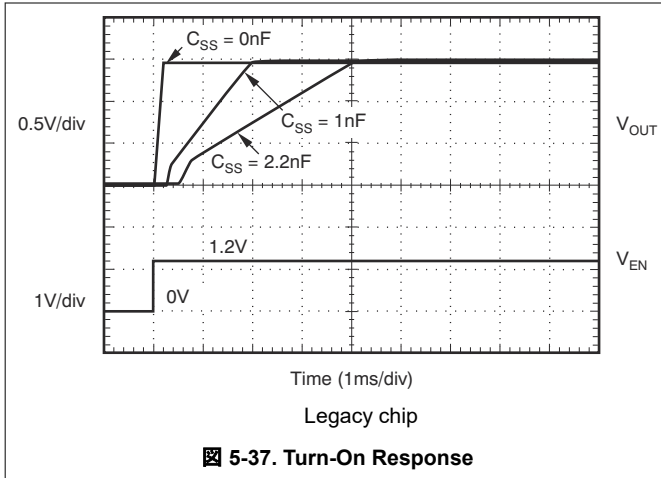

Figure 5-36. Output Load Transient Response

5.7 Typical Characteristics: I_{OUT} = 1 A (continued)

at T_J = 25°C, V_{IN} = V_{OUT(nom)} + 0.3 V, V_{BIAS} = 5 V, I_{OUT} = 1 A, V_{EN} = V_{IN} = 1.8 V, V_{OUT} = 1.5 V, C_{IN} = 1 μF, C_{BIAS} = 4.7 μF, and C_{OUT} = 10 μF (unless otherwise noted)



5-37. Turn-On Response

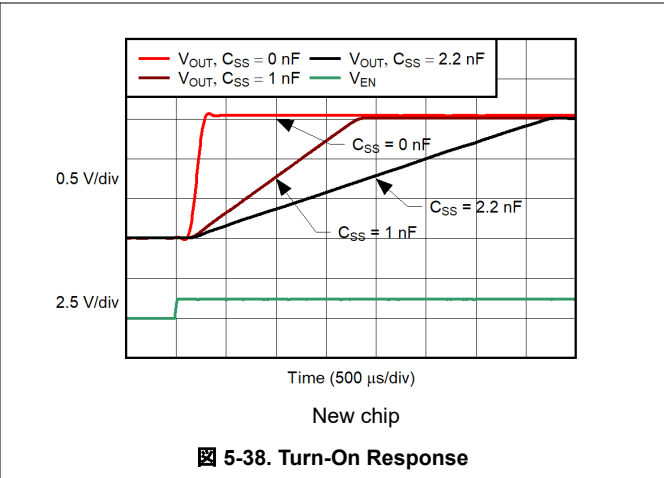

5-38. Turn-On Response

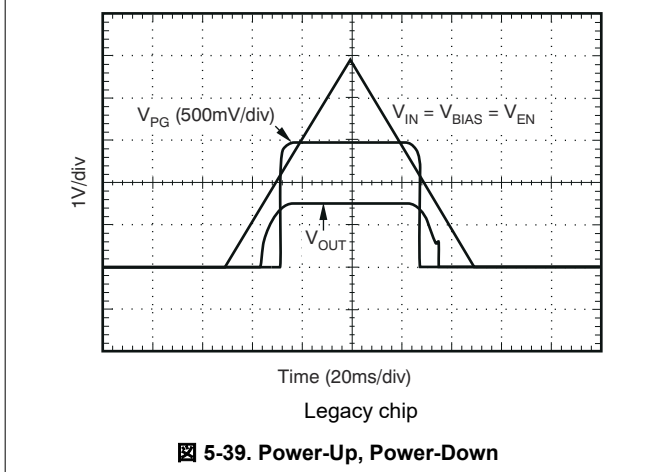

5-39. Power-Up, Power-Down

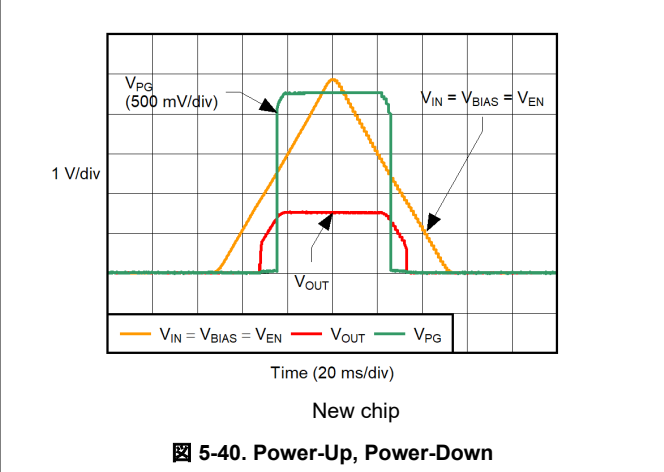

5-40. Power-Up, Power-Down

6 Detailed Description

6.1 Overview

The TPS748 is a low-dropout regulator that features soft-start capability. This regulator uses a low current bias input to power all internal control circuitry, allowing the NMOS-pass transistor to regulate very low input and output voltages. Using an NMOS-pass transistor offers several critical advantages for many applications. Unlike a PMOS topology device, the output capacitor has little effect on loop stability. This architecture allows the TPS74801-Q1 to be stable with any capacitor type of value 2.2 μF or greater. Transient response is also superior to PMOS topologies, particularly for low V_{IN} applications. The TPS74801-Q1 features a programmable voltage-controlled soft-start circuit that provides a smooth, monotonic start-up and limits start-up inrush currents that can be caused by large capacitive loads. A power-good (PG) output is available to allow supply monitoring and sequencing of other supplies. An enable (EN) pin with hysteresis and deglitch allows slow-ramping signals to be used for sequencing the device. The low V_{IN} and V_{OUT} capability allows for inexpensive, easy-to-design, and efficient linear regulation between the multiple supply voltages often required by processor-intensive systems.

6.2 Functional Block Diagram

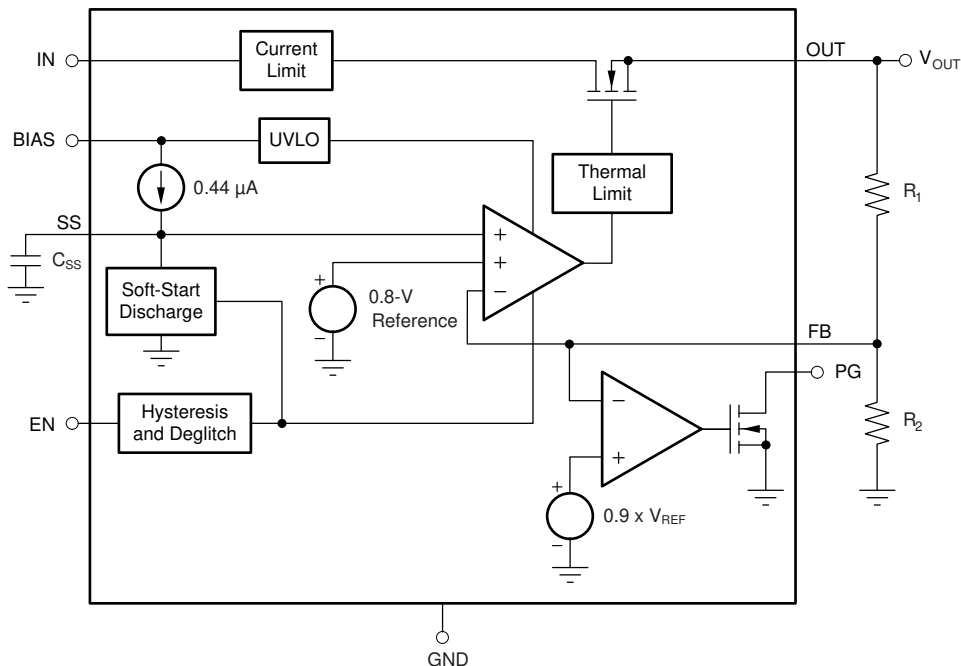

6.3 Feature Description

6.3.1 Programmable Soft-Start

The TPS74801-Q1 features a programmable, monotonic, voltage-controlled soft-start that is set with an external capacitor (C_{SS}). This feature is important for many applications because soft-start eliminates power-up initialization problems when powering FPGAs, DSPs, or other processors. The controlled voltage ramp of the output also reduces peak inrush current during start-up, minimizing start-up transient events to the input power bus.

To achieve a linear and monotonic soft-start, the TPS74801-Q1 error amplifier tracks the voltage ramp of the external soft-start capacitor until the voltage exceeds the internal reference. The soft-start ramp time depends on the soft-start charging current (I_{SS}), soft-start capacitance (C_{SS}), and the internal reference voltage (V_{REF}), and can be calculated using 式 1:

$$t_{\text{SS}} = \frac{(V_{\text{REF}} \times C_{\text{SS}})}{I_{\text{SS}}} \quad (1)$$

If large output capacitors are used, the device current limit (I_{CL}) and the output capacitor can set the start-up time. In this case, the start-up time is given by 式 2:

$$t_{SSCL} = \frac{V_{OUT(NOM)} \times C_{OUT}}{I_{CL(MIN)}} \quad (2)$$

where:

- $V_{OUT(NOM)}$ is the nominal output voltage
- C_{OUT} is the output capacitance
- $I_{CL(MIN)}$ is the minimum current limit for the device

In applications where monotonic start-up is required, the soft-start time given by 式 1 must be set greater than 式 2.

The maximum recommended soft-start capacitor is 0.015 μF . Larger soft-start capacitors can be used and do not damage the device; however, the soft-start capacitor discharge circuit can possibly be unable to fully discharge the soft-start capacitor when enabled. Soft-start capacitors larger than 0.015 μF can be a problem in applications where the enable pin must be rapidly pulsed while still requiring the device to soft-start from ground. C_{SS} must be low-leakage; X7R, X5R, or C0G dielectric materials are preferred. See 表 7-3 for suggested soft-start capacitor values.

6.3.2 Sequencing Requirements

V_{IN} , V_{BIAS} , and V_{EN} can be sequenced in any order without causing damage to the device. However, for the soft-start function to work as intended, certain sequencing rules must be applied. Connecting EN to IN is acceptable for most applications, as long as V_{IN} is greater than 1.1 V and the ramp rate of V_{IN} and V_{BIAS} is faster than the set soft-start ramp rate. If the ramp rate of the input sources is slower than the set soft-start time, the output tracks the slower supply minus the dropout voltage until the set output voltage is reached. If EN is connected to BIAS, the device soft-starts as programmed, provided that V_{IN} is present before V_{BIAS} . If V_{BIAS} and V_{EN} are present before V_{IN} is applied and the set soft-start time has expired, then V_{OUT} tracks V_{IN} . If the soft-start time has not expired, the output tracks V_{IN} until V_{OUT} reaches the value set by the charging soft-start capacitor. 図 6-1 shows the use of an RC-delay circuit to hold off V_{EN} until V_{BIAS} has ramped. This technique can also be used to drive EN from V_{IN} . An external control signal can also be used to enable the device after V_{IN} and V_{BIAS} are present.

注

When V_{BIAS} and V_{EN} are present and V_{IN} is not supplied, this device outputs approximately 50 μA of current from OUT. Although this condition does not cause any damage to the device, the output current can charge up the OUT node if total resistance between OUT and GND (including external feedback resistors) is greater than 10 k Ω .



図 6-1. Soft-Start Delay Using an RC Circuit to Enable the Device

6.3.3 Output Noise

The TPS74801-Q1 provides low output noise when a soft-start capacitor is used. When the device reaches the end of the soft-start cycle, the soft-start capacitor serves as a filter for the internal reference. By using a 0.001- μ F soft-start capacitor, the output noise is reduced by half and is typically 30- μ V_{RMS} for a 1.2-V output (10 Hz to 100 kHz). Further increasing C_{SS} has little effect on noise. Because most of the output noise is generated by the internal reference, the noise is a function of the set output voltage. The following equations calculate the RMS noise with a 0.001- μ F soft-start capacitor for the legacy and new chip, respectively:

$$V_N = 25 \left(\frac{\mu V_{RMS}}{V} \right) \times V_{OUT} (V) \text{ (Legacy Chip)} \quad (3)$$

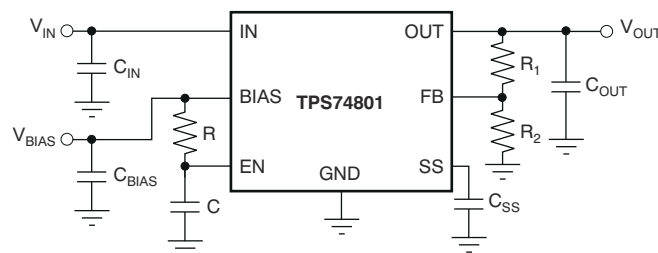
$$V_N = 20 \left(\frac{\mu V_{RMS}}{V} \right) \times V_{OUT} (V) \text{ (New Chip)} \quad (4)$$

The low output noise of the TPS74801-Q1 makes the device a good choice for powering transceivers, PLLs, or other noise-sensitive circuitry.

6.3.4 Enable and Shutdown

The enable (EN) pin is active high and is compatible with standard digital signaling levels. V_{EN} below 0.4 V turns the regulator off, while V_{EN} above 1.1 V turns the regulator on. Unlike many regulators, the enable circuitry has hysteresis and deglitching for use with relatively slowly ramping analog signals. This configuration allows the TPS74801-Q1 to be enabled by connecting the output of another supply to the EN pin. The enable circuitry typically has 50 mV of hysteresis and a deglitch circuit to help avoid on-off cycling as a result of small glitches in the V_{EN} signal.

The enable threshold is typically 0.8 V and varies with temperature and process variations. Temperature variation is approximately –1 mV/°C; process variation accounts for most of the rest of the variation to the 0.4-V and 1.1-V limits. If precise turn-on timing is required, a fast rise-time signal must be used to enable the TPS74801-Q1.

If not used, EN can be connected to either IN or BIAS. If EN is connected to IN, connect the EN pin as close as possible to the largest capacitance on the input to prevent voltage droops on that line from triggering the enable circuit.

6.3.5 Power Good

The power-good (PG) pin is an open-drain output and can be connected to any 5.5-V or lower rail through an external pullup resistor. This pin requires at least 1.1 V on V_{BIAS} in order to have a valid output. The PG output is high-impedance when V_{OUT} is greater than V_{IT} + V_{HYS}. If V_{OUT} drops below V_{IT} or if V_{BIAS} drops below 1.9 V, the open-drain output turns on and pulls the PG output low. The PG pin also asserts when the device is disabled. The recommended operating condition of the PG pin sink current is up to 1 mA, so the pullup resistor for PG must be in the range of 10 k Ω to 1 M Ω . If output voltage monitoring is not needed, the PG pin can be left floating.

6.3.6 Internal Current Limit

The TPS74801-Q1 features a factory-trimmed, accurate current limit that is flat over temperature and supply voltage. The current limit allows the device to supply surges of up to 2 A and maintain regulation. The current limit responds in approximately 10 μ s to reduce the current during a short-circuit fault.

The internal current limit protection circuitry of the TPS74801-Q1 is designed to protect against overload conditions. This circuitry is not intended to allow operation above the rated current of the device. Continuously running the TPS74801-Q1 above the rated current degrades device reliability.

6.3.7 Thermal Protection

Thermal protection disables the output when the junction temperature rises to approximately 160°C, allowing the device to cool. When the junction temperature cools to approximately 140°C, the output circuitry is enabled. Depending on power dissipation, thermal resistance, and ambient temperature the thermal protection circuit can cycle on and off. This cycling limits the dissipation of the regulator, protecting the regulator from damage as a result of overheating.

Activation of the thermal protection circuit indicates excessive power dissipation or inadequate heat sinking. For reliable operation, junction temperature must be limited to 150°C maximum. To estimate the margin of safety in a complete design (including heat sink), increase the ambient temperature until thermal protection is triggered; use worst-case loads and signal conditions. For good reliability, thermal protection must trigger at least 40°C above the maximum expected ambient condition of the application. This condition produces a worst-case junction temperature of 150°C at the highest expected ambient temperature and worst-case load.

The internal protection circuitry of the TPS74801-Q1 is designed to protect against overload conditions. This circuitry is not intended to replace proper heat sinking. Continuously running the TPS74801-Q1 into thermal shutdown degrades device reliability.

6.4 Device Functional Modes

表 6-1 shows the conditions that lead to the different modes of operation. See the [Electrical Characteristics](#) table for parameter values.

表 6-1. Device Functional Mode Comparison

OPERATING MODE	PARAMETER				
	V_{IN}	V_{BIAS}	V_{EN}	I_{OUT}	T_J
Normal mode	$V_{IN} \geq V_{OUT(nom)} + V_{DO(IN)}$ and $V_{IN} \geq V_{IN(min)}$	$V_{BIAS} \geq V_{OUT} + V_{DO(BIAS)}$	$V_{EN} \geq V_{HI(EN)}$	$I_{OUT} < I_{CL}$	$T_J < T_{SD}$ for shutdown
Dropout mode	$V_{IN(min)} < V_{IN} < V_{OUT(nom)} + V_{DO(IN)}$	$V_{BIAS} < V_{OUT} + V_{DO(BIAS)}$	$V_{EN} > V_{HI(EN)}$	$I_{OUT} < I_{CL}$	$T_J < T_{SD}$ for shutdown
Disabled mode (any true condition disables the device)	$V_{IN} < V_{UVLO(IN)}$	$V_{BIAS} < V_{BIAS(UVLO)}$	$V_{EN} < V_{LO(EN)}$	—	$T_J \geq T_{SD}$ for shutdown

6.4.1 Normal Operation

The device regulates to the nominal output voltage when the following conditions are met:

- The input voltage is greater than the nominal output voltage plus the dropout voltage ($V_{OUT(nom)} + V_{DO(IN)}$)
- The bias voltage is greater than the nominal output voltage plus the dropout voltage ($V_{OUT(nom)} + V_{DO(BIAS)}$)
- The output current is less than the current limit ($I_{OUT} < I_{CL}$)
- The device junction temperature is less than the thermal shutdown temperature ($T_J < T_{SD(shutdown)}$)
- The enable voltage has previously exceeded the enable rising threshold voltage and has not yet decreased to less than the enable falling threshold

6.4.2 Dropout Operation

If the input voltage is lower than the nominal output voltage plus the specified dropout voltage, but all other conditions are met for normal operation, the device operates in dropout mode. Similarly, if the bias voltage is lower than the nominal output voltage plus the specified dropout voltage, but all other conditions are met for normal operation, the device operates in dropout mode as well. In this mode, the output voltage tracks the input voltage. During this mode, the transient performance of the device becomes significantly degraded because the pass transistor is in the ohmic or triode region, and functions as a switch. Line or load transients in dropout can result in large output voltage deviations.

When the device is in a steady dropout state, defined as when the device is in dropout ($V_{IN} < V_{OUT} + V_{DO(IN)}$ or $V_{BIAS} < V_{OUT} + V_{DO(BIAS)}$ directly after being in normal regulation state, but not during start up), the pass transistor is driven into the ohmic or triode region. When the input voltage returns to a value greater than or equal to the nominal output voltage plus the dropout voltage ($V_{OUT(NOM)} + V_{DO(IN)}$), the output voltage can overshoot for a short time when the device pulls the pass transistor back into the linear region.

6.4.3 Disabled

The output of the device can be shutdown by forcing the voltage of the enable pin to less than $V_{IL(EN)}$ (see the [Electrical Characteristics](#) table). When disabled, the pass transistor is turned off, internal circuits are shutdown, and the output voltage is actively discharged to ground by an internal discharge circuit from the output to ground.

The device is disabled under the following conditions:

- The input or bias voltages are below the respective minimum specifications
- The enable voltage is less than the enable falling threshold voltage or has not yet exceeded the enable rising threshold
- The device junction temperature is greater than the thermal shutdown temperature

7 Application and Implementation

注

以下のアプリケーション情報は、TI の製品仕様に含まれるものではなく、TI ではその正確性または完全性を保証いたしません。個々の目的に対する製品の適合性については、お客様の責任で判断していただくこととなります。お客様は自身の設計実装を検証しテストすることで、システムの機能を確認する必要があります。

7.1 Application Information

The TPS74801-Q1 belongs to a family of low dropout regulators that feature soft-start capability. This regulator uses a low current bias input to power all internal control circuitry, allowing the NMOS pass transistor to regulate very low input and output voltages.

Using an NMOS pass transistor offers several critical advantages for many applications. Unlike a PMOS topology device, the output capacitor has little effect on loop stability. This architecture allows the TPS74801-Q1 to be stable with any capacitor type of value 2.2 μF or greater. Transient response is also superior to PMOS topologies, particularly for low V_{IN} applications.

The TPS74801-Q1 features a programmable voltage-controlled soft-start circuit that provides a smooth, monotonic start-up and limits start-up inrush currents that can be caused by large capacitive loads. A power-good (PG) output is available to allow supply monitoring and sequencing of other supplies. An enable (EN) pin with hysteresis and deglitch allows slow-ramping signals to be used for sequencing the device. The low V_{IN} and V_{OUT} capability allows for inexpensive, easy-to-design, and efficient linear regulation between the multiple supply voltages often present in processor-intensive systems.

7.2 Typical Application

図 7-1 shows the typical application circuit for the TPS74801-Q1 adjustable output device.

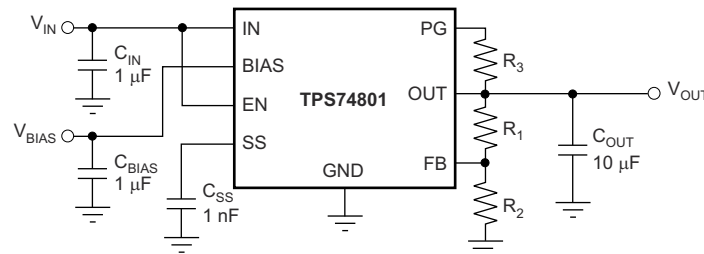

$$V_{\text{OUT}} = 0.8 \times \left(1 + \frac{R_1}{R_2} \right)$$

図 7-1. Typical Application Circuit for the TPS74801-Q1 (Adjustable)

7.2.1 Design Requirements

For this design example, use the parameters listed in 表 7-1 as the input parameters.

表 7-1. Design Parameters

PARAMETER	DESIGN REQUIREMENT
Input voltage	2.1 V, $\pm 3\%$
Bias voltage	5.0 V
Output voltage	1.8 V, $\pm 1\%$
Output current	1.5 A (maximum), 10 mA (minimum)
Start-up time	< 25 ms

7.2.2 Detailed Design Procedure

R_1 and R_2 can be calculated for any output voltage using the formula shown in 図 7-1. See 表 7-2 for sample resistor values of common output voltages. To achieve the maximum accuracy specifications, R_2 must be ≤ 4.99 k Ω .

表 7-2. Standard 1% Resistor Values for Programming the Output Voltage⁽¹⁾

R_1 (k Ω)	R_2 (k Ω)	V_{OUT} (V)
Short	Open	0.8
0.619	4.99	0.9
1.13	4.53	1
1.37	4.42	1.05
1.87	4.99	1.1
2.49	4.99	1.2
4.12	4.75	1.5
3.57	2.87	1.8
3.57	1.69	2.5
3.57	1.15	3.3

(1) $V_{OUT} = 0.8 \times (1 + R_1 / R_2)$.

表 7-3. Standard Capacitor Values for Programming the Soft-Start Time⁽¹⁾

C_{SS}	SOFT-START TIME (Legacy Chip)	SOFT-START TIME (New Chip)
Open	0.1 ms	0.25 ms
270 pF	0.5 ms	0.4 ms
560 pF	1 ms	0.8 ms
2.7 nF	5 ms	4.1 ms
5.6 nF	10 ms	8.5 ms
0.01 μ F	18 ms	15 ms

(1) $t_{SS}(s) = 0.8 \times C_{SS}(F) / I_{SS}$.

7.2.2.1 Input, Output, and Bias Capacitor Requirements

The device is designed to be stable for all available types and values of output capacitors ≥ 2.2 μ F. The device is also stable with multiple capacitors in parallel, which can be of any type or value.

The capacitance required on the IN and BIAS pins strongly depends on the input supply source impedance. To counteract any inductance in the input, the minimum recommended capacitor for V_{IN} and V_{BIAS} is 1 μ F. If V_{IN} and V_{BIAS} are connected to the same supply, the recommended minimum capacitor for V_{BIAS} is 4.7 μ F. Use good-quality, low-ESR capacitors on the input; ceramic X5R and X7R capacitors are preferred. Place these capacitors as close to the pins as possible for optimum performance.

7.2.2.2 Transient Response

The TPS74801-Q1 is designed to have excellent transient response for most applications with a small amount of output capacitance. In some cases, the transient response can be limited by the transient response of the input supply. This limitation is especially true in applications where the difference between the input and output is less than 300 mV. In this case, adding additional input capacitance improves the transient response much more than just adding additional output capacitance does. With a solid input supply, adding additional output capacitance reduces undershoot and overshoot during a transient event; see the *Output Load Transient Response* curves in the *Typical Characteristics* section. Because the TPS74801-Q1 is stable with output capacitors as low as 2.2 μ F, many applications can then need very little capacitance at the LDO output. For these applications, local bypass capacitance for the powered device can be sufficient to meet the transient requirements of the application. This

design reduces the total solution cost by avoiding the need to use expensive, high-value capacitors at the LDO output.

7.2.3 Application Curves

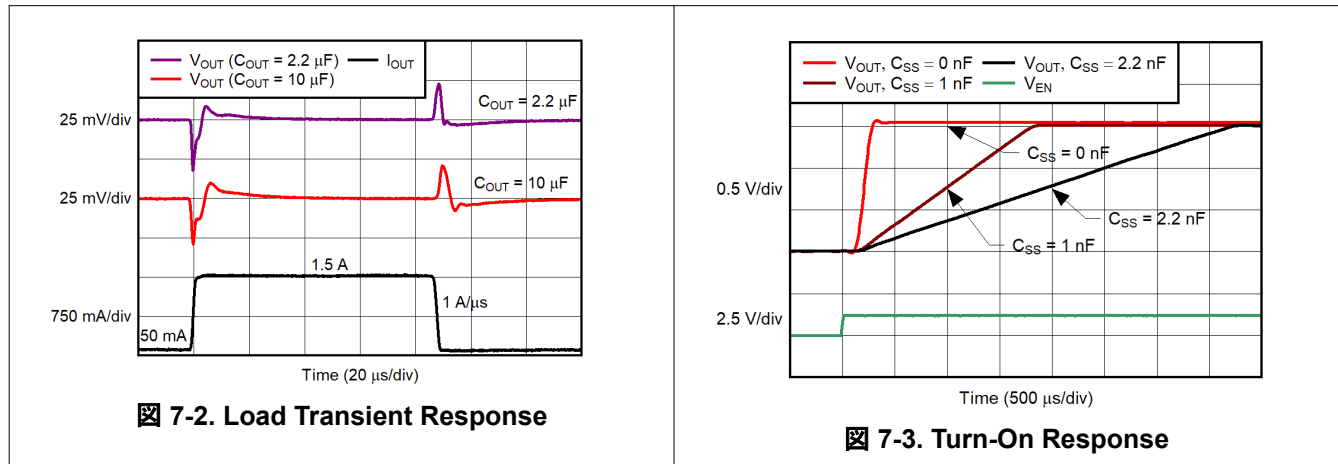

7.3 Power Supply Recommendations

The TPS74801-Q1 is designed to operate from an input voltage up to 5.5 V, provided the bias rail is at least 1.3 V higher than the input supply and dropout requirements are met. The bias rail and the input supply must both provide adequate headroom and current for the device to operate normally. Connect a low output impedance power supply directly to the IN pin. This supply must have at least 1 μF of capacitance near the IN pin for optimal performance. A supply with similar requirements must also be connected directly to the BIAS rail with a separate 0.1 μF or larger capacitor. If the IN pin is tied to the BIAS pin, a minimum 4.7-μF capacitor is required for performance. To increase the overall PSRR of the solution at higher frequencies, use a pi-filter or ferrite bead before the input capacitor.

7.4 Layout

7.4.1 Layout Guidelines

7.4.1.1 Layout Recommendations and Power Dissipation

An optimal layout can greatly improve transient performance, PSRR, and noise. To minimize the voltage drop on the input of the device during load transients, the capacitance on IN and BIAS must be connected as close as possible to the device. This capacitance also minimizes the effects of parasitic inductance and resistance of the input source and can, therefore, improve stability. To achieve optimal transient performance and accuracy, the top side of R₁ in [7-1](#) must be connected as close as possible to the load. If BIAS is connected to IN, connect BIAS as close to the sense point of the input supply as possible. This connection minimizes the voltage drop on BIAS during transient conditions and can improve the turn-on response.

Knowing the device power dissipation and proper sizing of the thermal plane that is connected to the thermal pad is critical to avoiding thermal shutdown and to provide reliable operation. Power dissipation of the device depends on input voltage and load conditions and can be calculated using [式 5](#):

$$P_D = (V_{IN} - V_{OUT}) \times I_{OUT} \quad (5)$$

Power dissipation can be minimized and greater efficiency can be achieved by using the lowest possible input voltage necessary to achieve the required output voltage regulation.

The primary conduction path for heat is through the exposed pad to the printed circuit board (PCB). The pad can be connected to ground or be left floating; however, the pad must be attached to an appropriate amount of copper PCB area to make sure the device does not overheat. The maximum junction-to-ambient thermal

resistance depends on the maximum ambient temperature, maximum device junction temperature, and power dissipation of the device and can be calculated using 式 6:

$$R_{\theta JA} = \frac{(150^{\circ}\text{C} - T_A)}{P_D} \quad (6)$$

Knowing the maximum $R_{\theta JA}$, the minimum amount of PCB copper area needed for appropriate heat sinking can be estimated using 図 7-4.

図 7-4 shows the variation of $R_{\theta JA}$ as a function of ground plane copper area in the board. This figure is intended only as a guideline to demonstrate the effects of heat spreading in the ground plane and is not intended to be used to estimate actual thermal performance in real application environments.

注

When the device is mounted on an application PCB, use Ψ_{JT} and Ψ_{JB} , as explained in the [Estimating Junction Temperature](#) section.

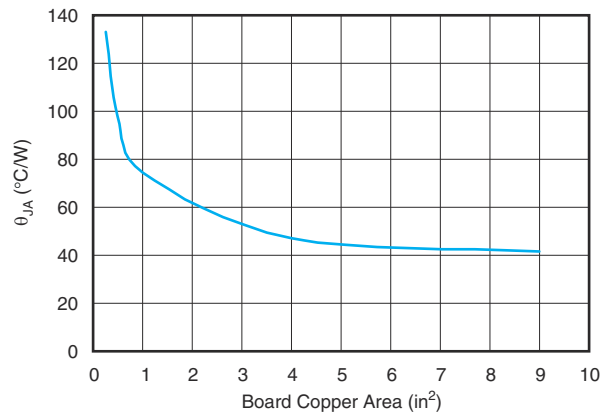

$R_{\theta JA}$ value at board size of 9 in² (that is, 3-in × 3-in) is a JEDEC standard.

図 7-4. $R_{\theta JA}$ vs Board Size

7.4.1.2 Estimating Junction Temperature

Using the thermal metrics Ψ_{JT} and Ψ_{JB} , as shown in the [Thermal Information](#) table, the junction temperature can be estimated with corresponding formulas (given in 式 7). For backwards compatibility, an older $R_{\theta JC, Top}$ parameter is listed as well.

$$\begin{aligned} \Psi_{JT}: T_J &= T_T + \Psi_{JT} \cdot P_D \\ \Psi_{JB}: T_J &= T_B + \Psi_{JB} \cdot P_D \end{aligned} \quad (7)$$

Where P_D is the power dissipation shown by 式 7, T_T is the temperature at the center-top of the device package, and T_B is the PCB temperature measured 1mm away from the device package *on the PCB surface* (see 図 7-6).

注

Both T_T and T_B can be measured on actual application boards using a thermo-gun (an infrared thermometer).

For more information about measuring T_T and T_B , see the [Using New Thermal Metrics](#) application note, available for download at www.ti.com.

In reference to [Figure 7-5](#), the new thermal metrics (Ψ_{JT} and Ψ_{JB}) have very little dependency on board size. That is, using Ψ_{JT} or Ψ_{JB} with [Equation 7](#) is a good way to estimate T_J by simply measuring T_T or T_B , regardless of the application board size.

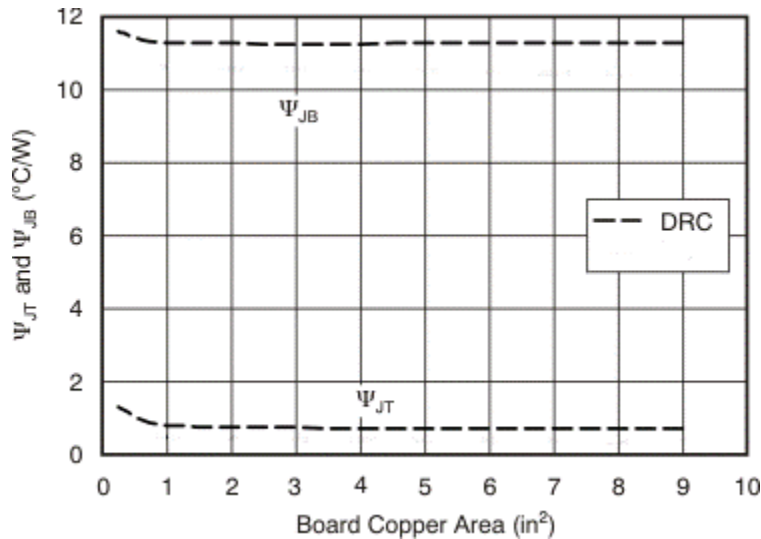
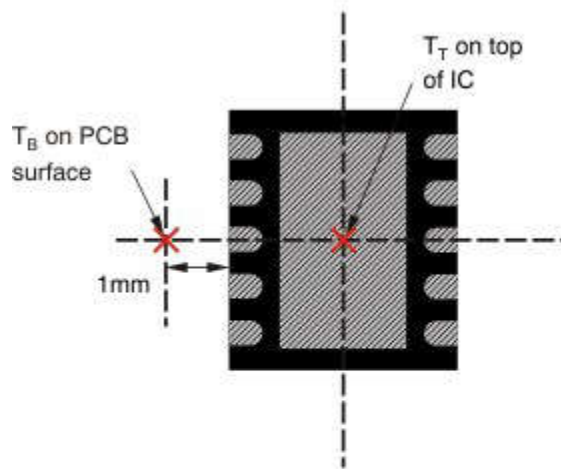

Figure 7-5. Ψ_{JT} and Ψ_{JB} vs Board Size

For a more detailed discussion of why TI does not recommend using $R_{\theta JC(top)}$ to determine thermal characteristics, see the [Using New Thermal Metrics application note](#), available for download at www.ti.com. For further information, see the [Semiconductor and IC Package Thermal Metrics application note](#), also available on the TI website.



(a) Example DRC (SON) Package Measurement

- A. T_T is measured at the center of both the X- and Y-dimensional axes.

B. T_B is measured *below* the package lead on the PCB surface.

7-6. Measuring Points for T_T and T_B

7.4.2 Layout Example

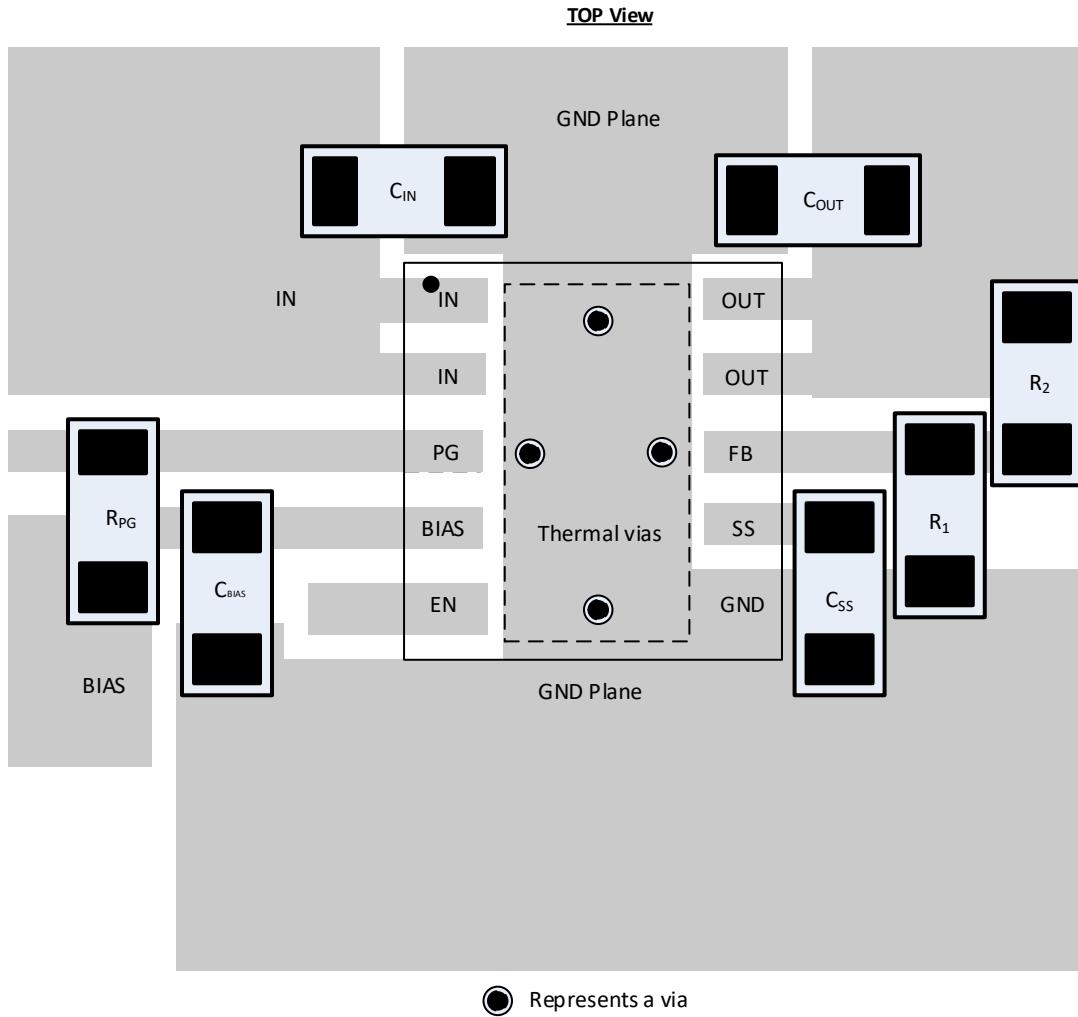

7-7. Layout Example: DRC Package

8 Device and Documentation Support

8.1 Documentation Support

8.1.1 Related Documentation

For related documentation see the following:

Texas Instruments, [Using New Thermal Metrics application note](#)

8.1.2 Device Nomenclature

表 8-1. Device Nomenclature

PRODUCT ⁽¹⁾	V _{OUT}
TPS74801Q(W)yyyzM3Q1	<p>Q indicates that this device is a grade-1 device in accordance with the AEC-Q100 standard.</p> <p>W indicates that the package has wettable flanks (new chip only).</p> <p>yyy is the package designator.</p> <p>z is the package quantity.</p> <p>M3 is a suffix designator for devices that only use the latest manufacturing flow (CSO: RFB). Devices without this suffix can ship with the legacy chip (CSO: DLN) or the new chip (CSO: RFB). The reel packaging label provides CSO information to distinguish which chip is being used. Device performance for new and legacy chips is denoted throughout the document.</p> <p>Q1 indicates that this device is an automotive grade (AEC-Q100) device.</p>

(1) For the most current package and ordering information see the Package Option Addendum at the end of this document, or visit the device product folder on www.ti.com.

8.2 ドキュメントの更新通知を受け取る方法

ドキュメントの更新についての通知を受け取るには、www.tij.co.jp のデバイス製品フォルダを開いてください。[通知] をクリックして登録すると、変更されたすべての製品情報に関するダイジェストを毎週受け取ることができます。変更の詳細については、改訂されたドキュメントに含まれている改訂履歴をご覧ください。

8.3 サポート・リソース

テキサス・インスツルメンツ E2E™ サポート・フォーラムは、エンジニアが検証済みの回答と設計に関するヒントをエキスパートから迅速かつ直接得ることができる場所です。既存の回答を検索したり、独自の質問をしたりすることで、設計に必要な支援を迅速に得ることができます。

リンクされているコンテンツは、各寄稿者により「現状のまま」提供されるものです。これらはテキサス・インスツルメンツの仕様を構成するものではなく、必ずしもテキサス・インスツルメンツの見解を反映したものではありません。テキサス・インスツルメンツの[使用条件](#)を参照してください。

8.4 Trademarks

テキサス・インスツルメンツ E2E™ is a trademark of Texas Instruments.

すべての商標は、それぞれの所有者に帰属します。

8.5 静電気放電に関する注意事項



この IC は、ESD によって破損する可能性があります。テキサス・インスツルメンツは、IC を取り扱う際には常に適切な注意を払うことを推奨します。正しい取り扱いおよび設置手順に従わない場合、デバイスを破損するおそれがあります。

ESD による破損は、わずかな性能低下からデバイスの完全な故障まで多岐にわたります。精密な IC の場合、パラメータがわずかに変化するだけで公表されている仕様から外れる可能性があるため、破損が発生しやすくなっています。

8.6 用語集

[テキサス・インスツルメンツ用語集](#)

この用語集には、用語や略語の一覧および定義が記載されています。

9 Revision History

資料番号末尾の英字は改訂を表しています。その改訂履歴は英語版に準じています。

Changes from Revision C (July 2023) to Revision D (December 2023)	Page
• 従来のチップと新しいチップの情報を区別するために、ドキュメント全体にデバイスに関する文言を追加.....	1
• 「概要」セクションを変更: 「ターンオン応答」の図を変更し、新しいチップの温度範囲を追加	1
• Changed <i>Typical Characteristics</i> sections to show legacy chip and new chip data side by side and deleted V_{IN} Dropout Voltage vs V_{BIAS} - V_{OUT} curves.....	8
• Changed images in <i>Estimating Junction Temperature</i> section.....	23
• Deleted RGW Example figure from <i>Layout Example</i> section.....	25
• Added <i>Device Nomenclature</i> section.....	26

Changes from Revision B (July 2013) to Revision C (July 2023)	Page
• 「製品情報」表、「ピン構成および機能」セクション、「ESD 定格」表、「機能説明」セクション、「デバイスの機能モード」、「アプリケーションと実装」セクション、「デバイスおよびドキュメントのサポート」セクション、「メカニカル、パッケージ、および注文情報」セクションを追加	1
• ドキュメントに M3 デバイスを追加.....	1
• 「特長」の車載特有の箇条書き項目を変更	1
• ドキュメント全体を通して QFN を VQFN に変更.....	1
• 「アプリケーション」セクションにリンクを追加	1
• 「概要」セクションから TPS74401 への参照を削除	1
• Added <i>Design Requirements</i> section.....	20
• Changed footnote 1 on <i>Standard Capacitor Values for Programming the Soft-Start Time</i> table.....	21
• Added <i>Application Curves</i> section.....	22

10 Mechanical, Packaging, and Orderable Information

The following pages include mechanical, packaging, and orderable information. This information is the most current data available for the designated devices. This data is subject to change without notice and revision of this document. For browser-based versions of this data sheet, refer to the left-hand navigation.

PACKAGING INFORMATION

Orderable Device	Status (1)	Package Type	Package Drawing	Pins	Package Qty	Eco Plan (2)	Lead finish/ Ball material (6)	MSL Peak Temp (3)	Op Temp (°C)	Device Marking (4/5)	Samples
TPS74801QDRCRM3Q1	ACTIVE	VSON	DRC	10	3000	RoHS & Green	NIPDAU	Level-1-260C-UNLIM	-40 to 150	QVK	Samples
TPS74801QRGWRQ1	ACTIVE	VQFN	RGW	20	3000	RoHS & Green	NIPDAU	Level-3-260C-168 HR	-40 to 125	TPS 74801Q	Samples
TPS74801QWDRCRQ1	ACTIVE	VSON	DRC	10	3000	RoHS & Green	NIPDAU	Level-1-260C-UNLIM	-40 to 105	SMF	Samples
TPS74801TDRCRQ1	ACTIVE	VSON	DRC	10	3000	RoHS & Green	NIPDAU	Level-3-260C-168 HR	-40 to 105	QVK	Samples

(1) The marketing status values are defined as follows:

ACTIVE: Product device recommended for new designs.

LIFEBUY: TI has announced that the device will be discontinued, and a lifetime-buy period is in effect.

NRND: Not recommended for new designs. Device is in production to support existing customers, but TI does not recommend using this part in a new design.

PREVIEW: Device has been announced but is not in production. Samples may or may not be available.

OBSOLETE: TI has discontinued the production of the device.

(2) **RoHS:** TI defines "RoHS" to mean semiconductor products that are compliant with the current EU RoHS requirements for all 10 RoHS substances, including the requirement that RoHS substance do not exceed 0.1% by weight in homogeneous materials. Where designed to be soldered at high temperatures, "RoHS" products are suitable for use in specified lead-free processes. TI may reference these types of products as "Pb-Free".

RoHS Exempt: TI defines "RoHS Exempt" to mean products that contain lead but are compliant with EU RoHS pursuant to a specific EU RoHS exemption.

Green: TI defines "Green" to mean the content of Chlorine (Cl) and Bromine (Br) based flame retardants meet JS709B low halogen requirements of <=1000ppm threshold. Antimony trioxide based flame retardants must also meet the <=1000ppm threshold requirement.

(3) MSL, Peak Temp. - The Moisture Sensitivity Level rating according to the JEDEC industry standard classifications, and peak solder temperature.

(4) There may be additional marking, which relates to the logo, the lot trace code information, or the environmental category on the device.

(5) Multiple Device Markings will be inside parentheses. Only one Device Marking contained in parentheses and separated by a "~" will appear on a device. If a line is indented then it is a continuation of the previous line and the two combined represent the entire Device Marking for that device.

(6) Lead finish/Ball material - Orderable Devices may have multiple material finish options. Finish options are separated by a vertical ruled line. Lead finish/Ball material values may wrap to two lines if the finish value exceeds the maximum column width.

Important Information and Disclaimer:The information provided on this page represents TI's knowledge and belief as of the date that it is provided. TI bases its knowledge and belief on information provided by third parties, and makes no representation or warranty as to the accuracy of such information. Efforts are underway to better integrate information from third parties. TI has taken and

continues to take reasonable steps to provide representative and accurate information but may not have conducted destructive testing or chemical analysis on incoming materials and chemicals. TI and TI suppliers consider certain information to be proprietary, and thus CAS numbers and other limited information may not be available for release.

In no event shall TI's liability arising out of such information exceed the total purchase price of the TI part(s) at issue in this document sold by TI to Customer on an annual basis.

OTHER QUALIFIED VERSIONS OF TPS74801-Q1 :

- Catalog : [TPS74801](#)

NOTE: Qualified Version Definitions:

- Catalog - TI's standard catalog product

TAPE AND REEL INFORMATION

QUADRANT ASSIGNMENTS FOR PIN 1 ORIENTATION IN TAPE

*All dimensions are nominal

Device	Package Type	Package Drawing	Pins	SPQ	Reel Diameter (mm)	Reel Width W1 (mm)	A0 (mm)	B0 (mm)	K0 (mm)	P1 (mm)	W (mm)	Pin1 Quadrant
TPS74801QDRCRM3Q1	VSON	DRC	10	3000	330.0	12.4	3.3	3.3	1.1	8.0	12.0	Q2
TPS74801QRGWRQ1	VQFN	RGW	20	3000	330.0	12.4	5.3	5.3	1.5	8.0	12.0	Q2
TPS74801QWDRCRQ1	VSON	DRC	10	3000	330.0	12.4	3.3	3.3	1.1	8.0	12.0	Q2
TPS74801TDRCRQ1	VSON	DRC	10	3000	330.0	12.4	3.3	3.3	1.1	8.0	12.0	Q2

TAPE AND REEL BOX DIMENSIONS

*All dimensions are nominal

Device	Package Type	Package Drawing	Pins	SPQ	Length (mm)	Width (mm)	Height (mm)
TPS74801QDRCRM3Q1	VSON	DRC	10	3000	367.0	367.0	35.0
TPS74801QRGWRQ1	VQFN	RGW	20	3000	367.0	367.0	35.0
TPS74801QWDRCRQ1	VSON	DRC	10	3000	360.0	360.0	36.0
TPS74801TDRCRQ1	VSON	DRC	10	3000	367.0	367.0	35.0

GENERIC PACKAGE VIEW

RGW 20

VQFN - 1 mm max height

5 x 5, 0.65 mm pitch

PLASTIC QUAD FLATPACK - NO LEAD

This image is a representation of the package family, actual package may vary.
Refer to the product data sheet for package details.

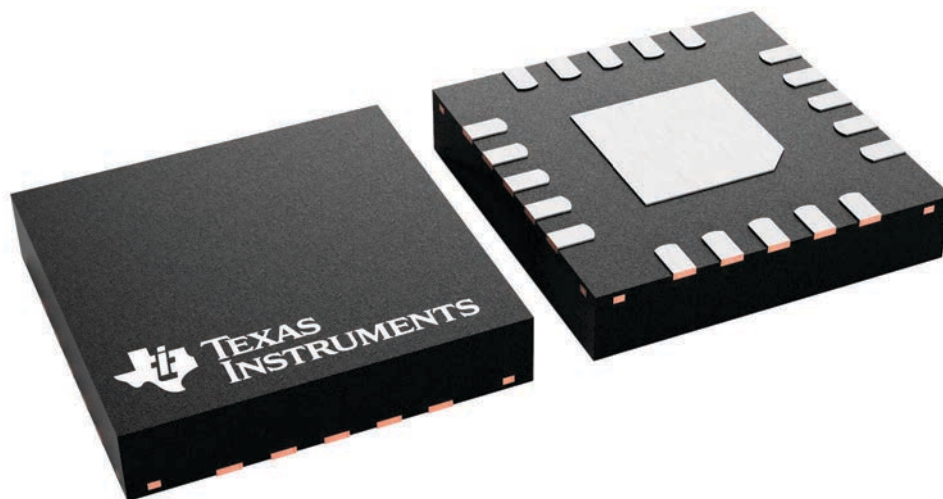

4227157/A

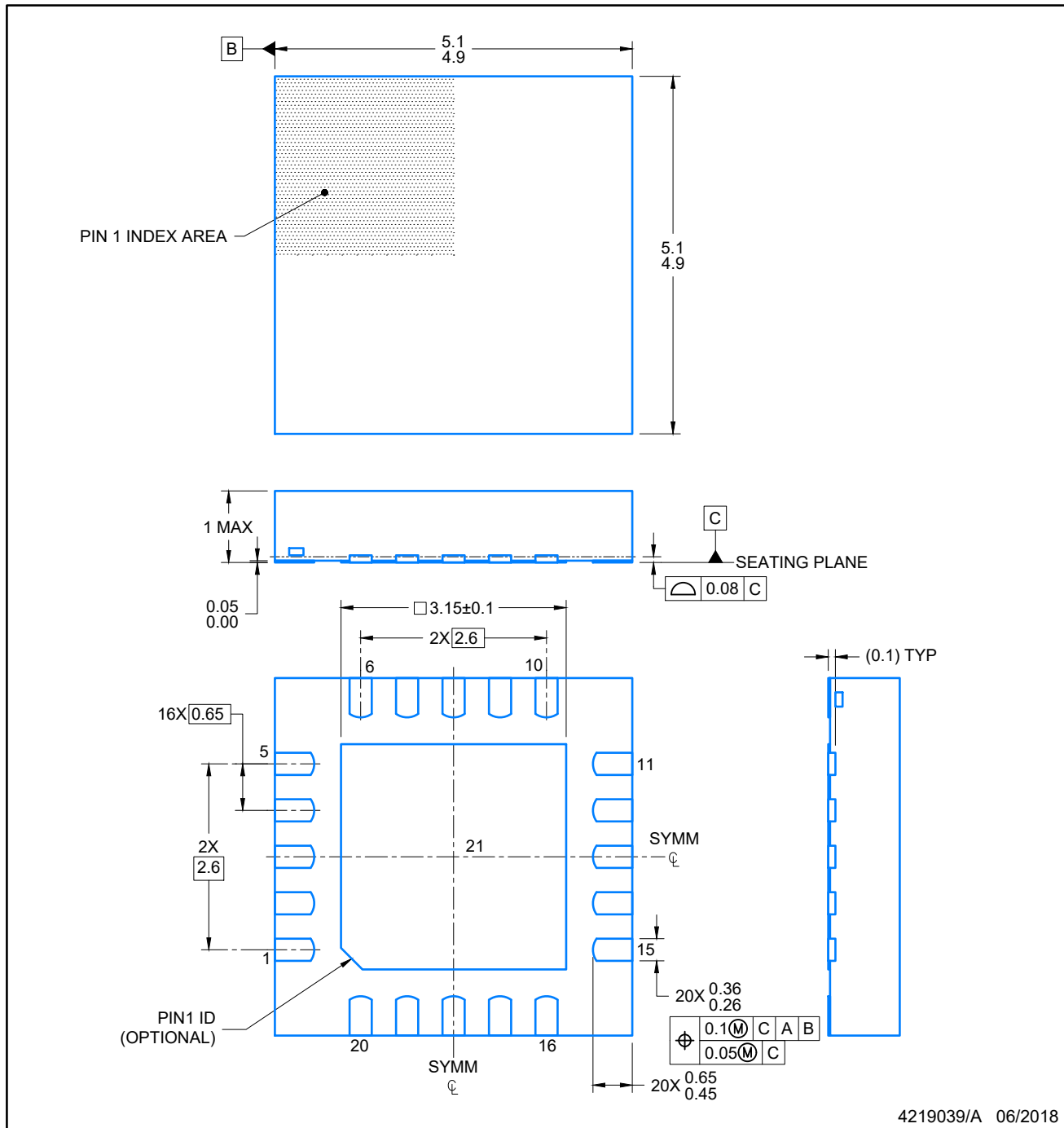

NOTES:

1. All linear dimensions are in millimeters. Any dimensions in parenthesis are for reference only. Dimensioning and tolerancing per ASME Y14.5M.
2. This drawing is subject to change without notice.
3. The package thermal pad must be soldered to the printed circuit board for optimal thermal and mechanical performance.

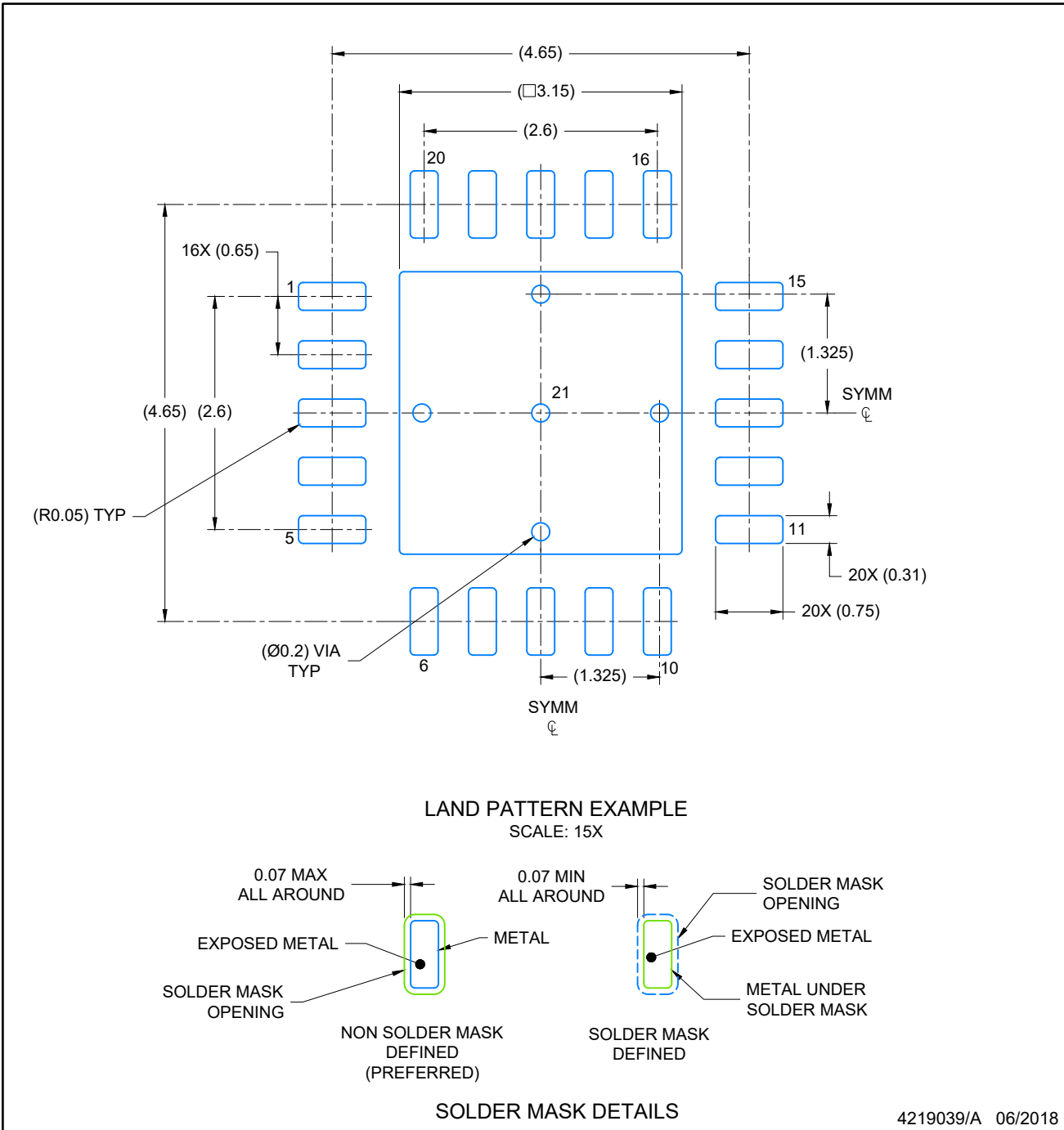

NOTES: (continued)

4. This package is designed to be soldered to a thermal pad on the board. For more information, see Texas Instruments literature number SLUA271 (www.ti.com/lit/sluea271).
5. Vias are optional depending on application, refer to device data sheet. If any vias are implemented, refer to their locations shown on this view. It is recommended that vias under paste be filled, plugged or tented.

EXAMPLE STENCIL DESIGN

VQFN - 1 mm max height

RGW0020A

PLASTIC QUAD FLATPACK-NO LEAD

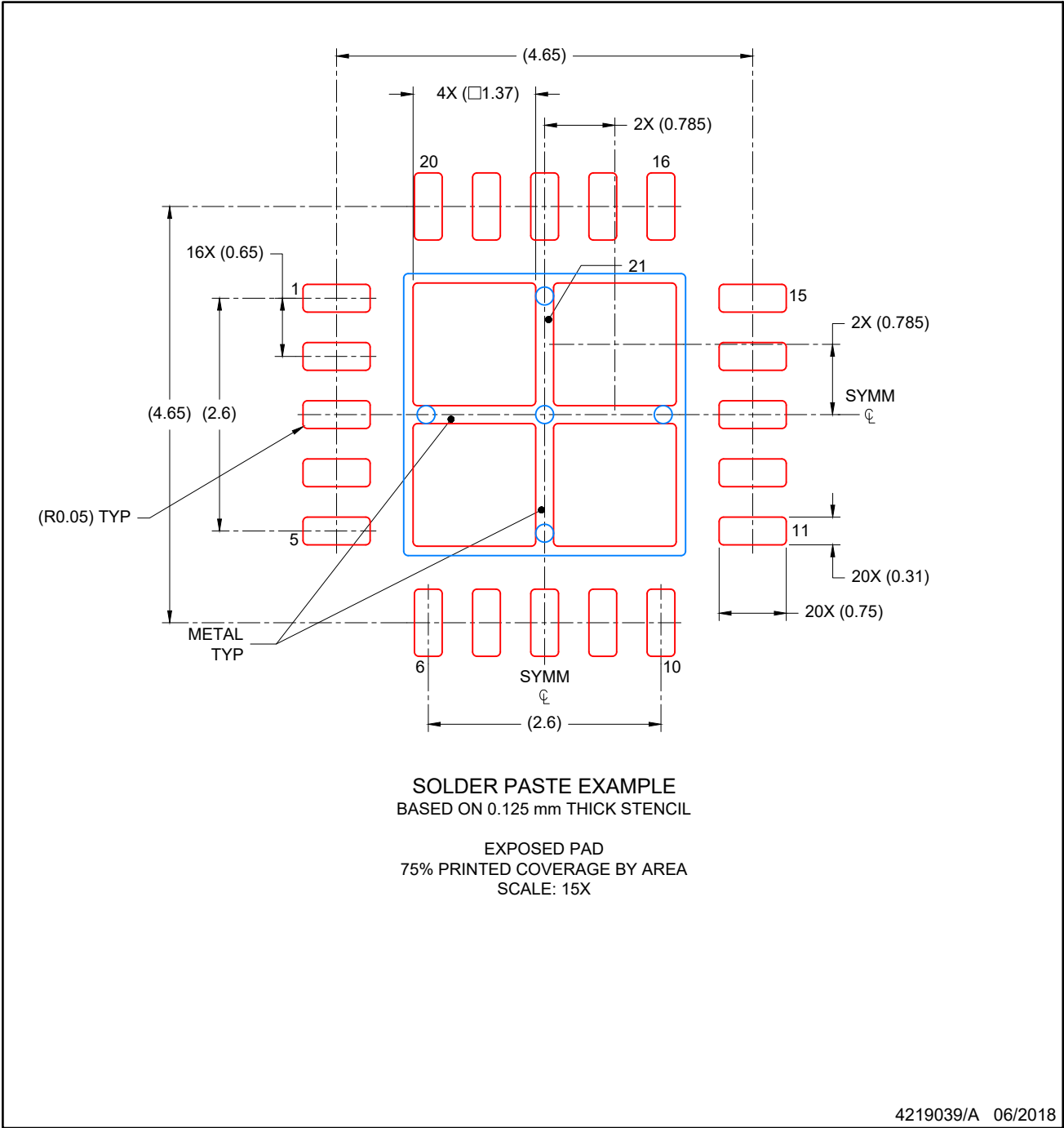

NOTES: (continued)

- 6. Laser cutting apertures with trapezoidal walls and rounded corners may offer better paste release. IPC-7525 may have alternate design recommendations.

GENERIC PACKAGE VIEW

DRC 10

VSON - 1 mm max height

3 x 3, 0.5 mm pitch

PLASTIC SMALL OUTLINE - NO LEAD

This image is a representation of the package family, actual package may vary.
Refer to the product data sheet for package details.

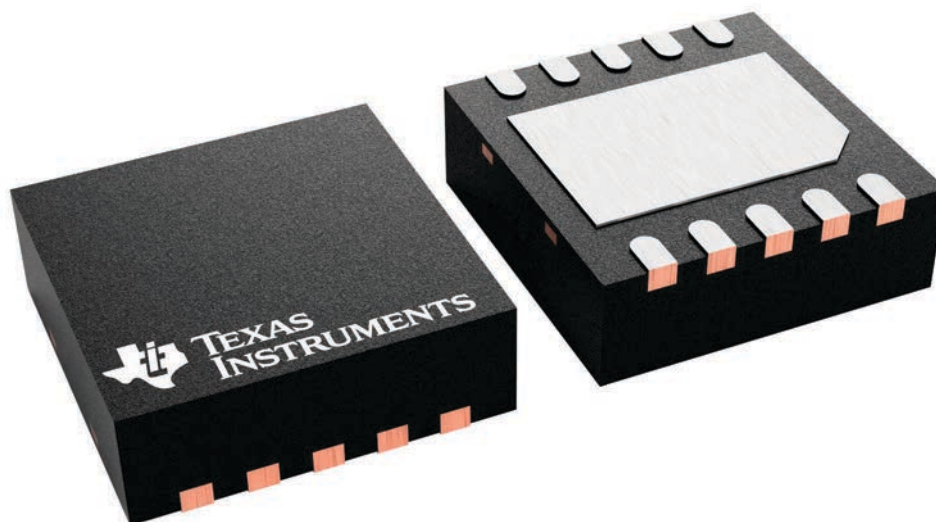

4226193/A

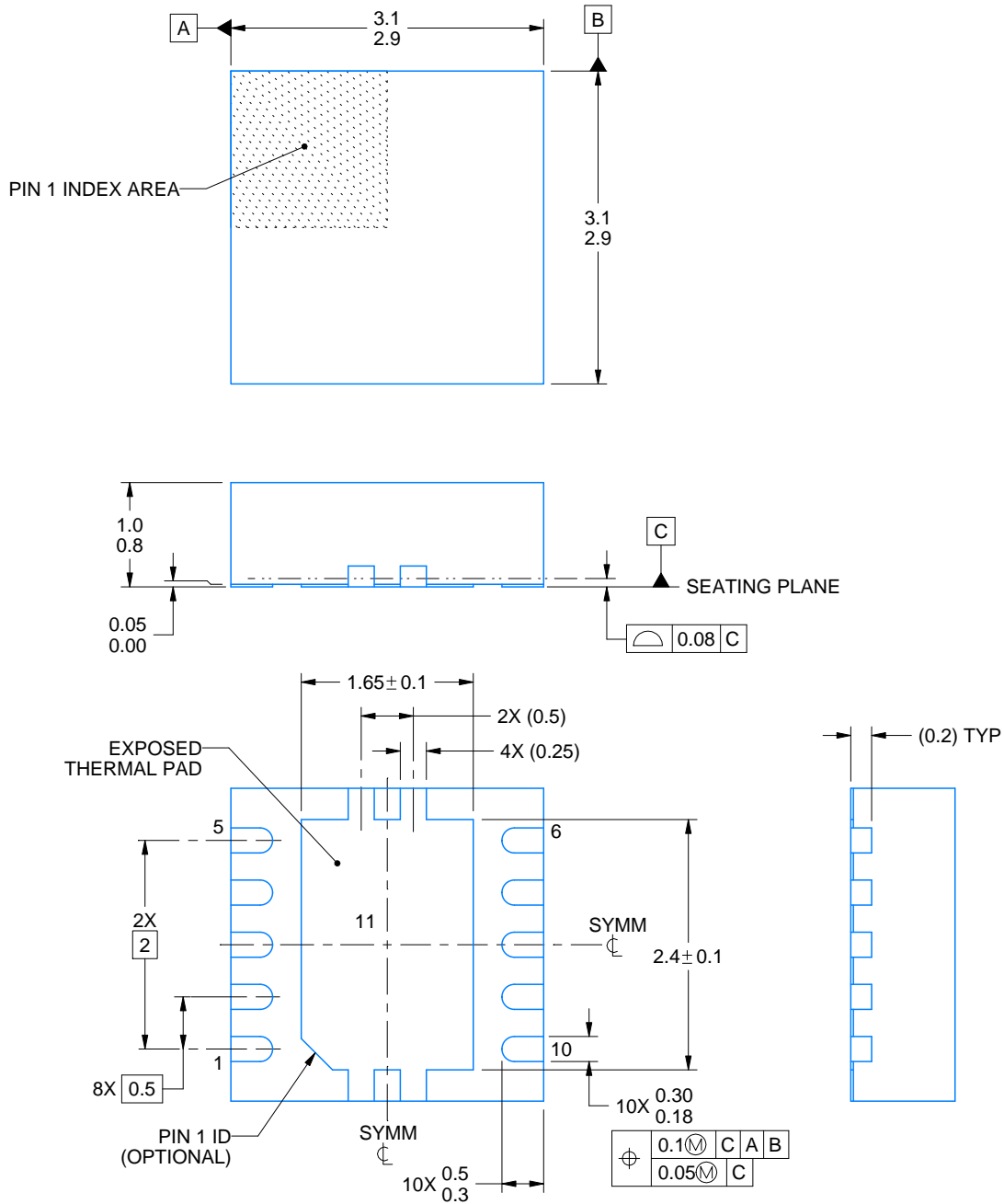

4218878/B 07/2018

NOTES:

1. All linear dimensions are in millimeters. Any dimensions in parenthesis are for reference only. Dimensioning and tolerancing per ASME Y14.5M.
2. This drawing is subject to change without notice.
3. The package thermal pad must be soldered to the printed circuit board for optimal thermal and mechanical performance.

EXAMPLE BOARD LAYOUT

DRC0010J

VSON - 1 mm max height

PLASTIC SMALL OUTLINE - NO LEAD



LAND PATTERN EXAMPLE
EXPOSED METAL SHOWN
SCALE:20X



SOLDER MASK DETAILS

4218878/B 07/2018

NOTES: (continued)

4. This package is designed to be soldered to a thermal pad on the board. For more information, see Texas Instruments literature number SLUA271 (www.ti.com/lit/sluea271).
5. Vias are optional depending on application, refer to device data sheet. If any vias are implemented, refer to their locations shown on this view. It is recommended that vias under paste be filled, plugged or tented.

EXAMPLE STENCIL DESIGN

DRC0010J

VSON - 1 mm max height

PLASTIC SMALL OUTLINE - NO LEAD

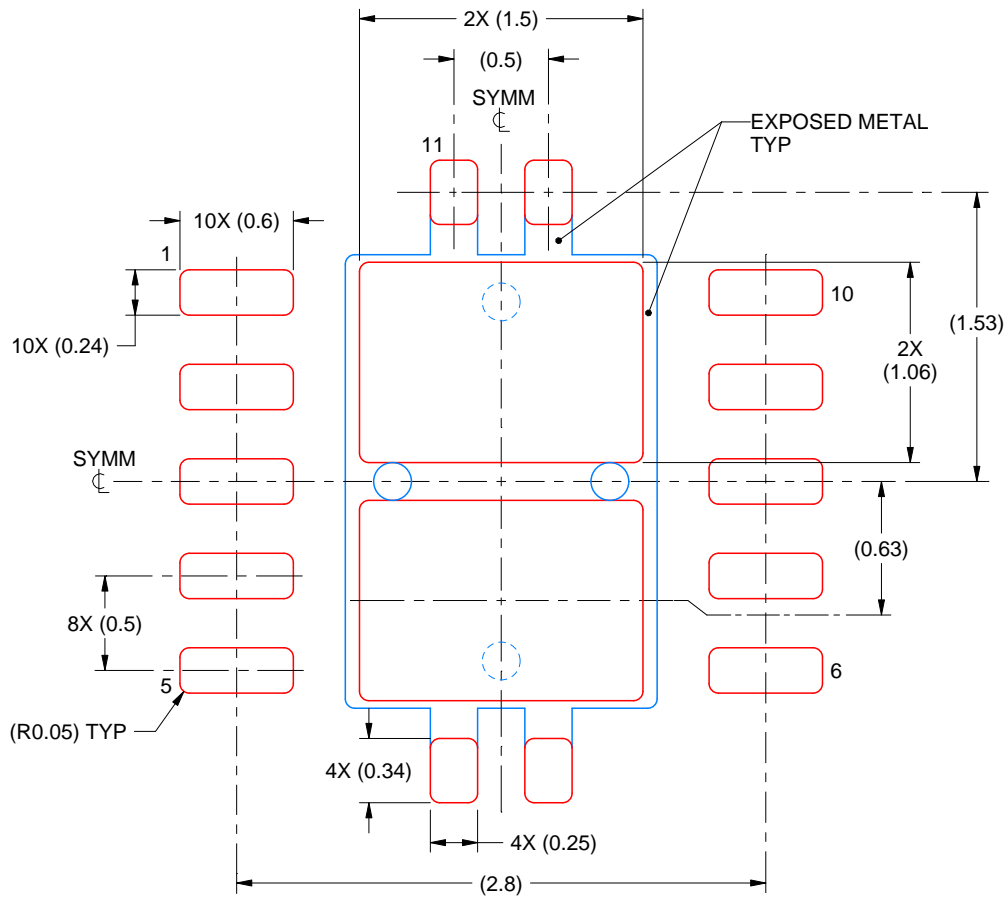

SOLDER PASTE EXAMPLE
BASED ON 0.125 mm THICK STENCIL

EXPOSED PAD 11:
80% PRINTED SOLDER COVERAGE BY AREA
SCALE:25X

4218878/B 07/2018

NOTES: (continued)

6. Laser cutting apertures with trapezoidal walls and rounded corners may offer better paste release. IPC-7525 may have alternate design recommendations.

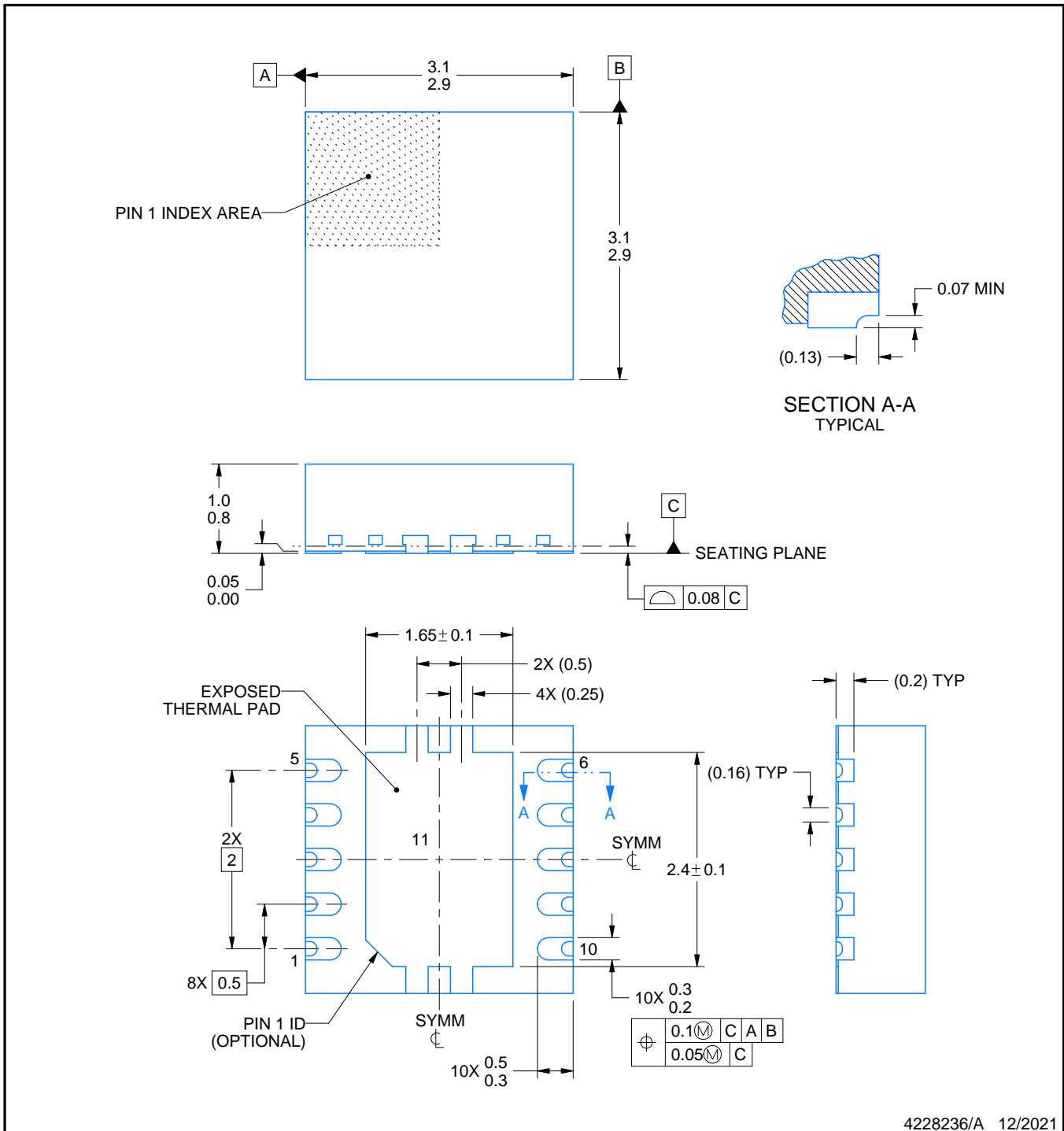
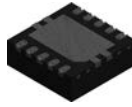

4228236/A 12/2021

NOTES:

1. All linear dimensions are in millimeters. Any dimensions in parenthesis are for reference only. Dimensioning and tolerancing per ASME Y14.5M.
2. This drawing is subject to change without notice.
3. The package thermal pad must be soldered to the printed circuit board for optimal thermal and mechanical performance.

EXAMPLE BOARD LAYOUT

DRC0010W

VSON - 1 mm max height

PLASTIC SMALL OUTLINE - NO LEAD

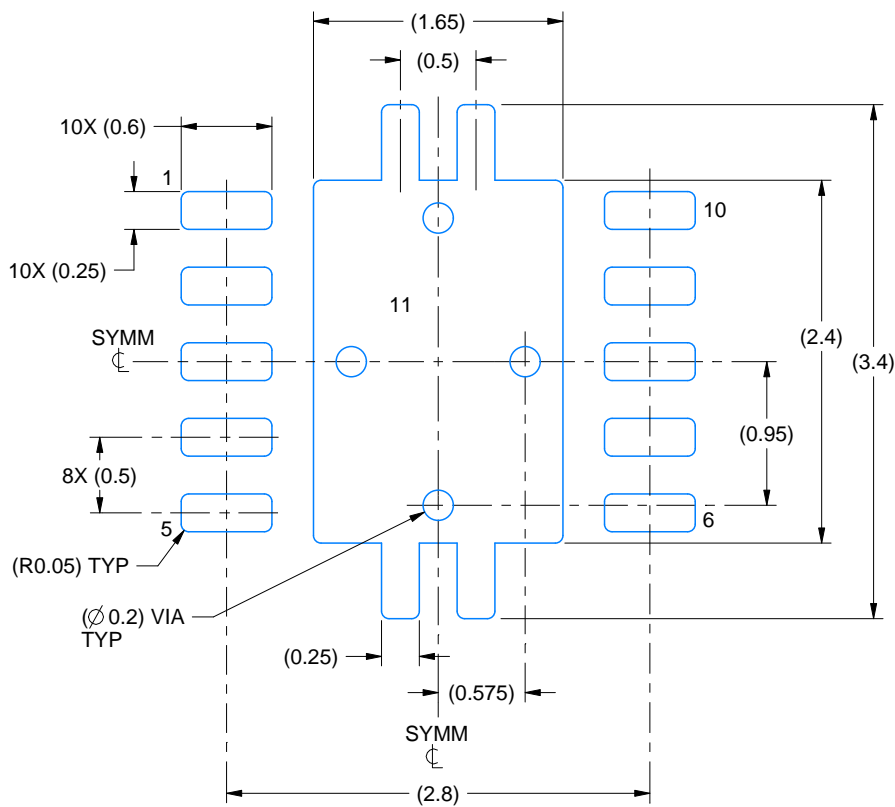

LAND PATTERN EXAMPLE
EXPOSED METAL SHOWN
SCALE:20X

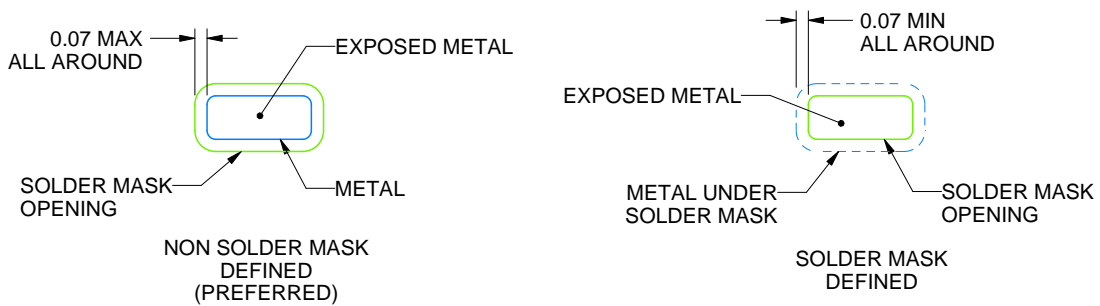

SOLDER MASK DETAILS

4228236/A 12/2021

NOTES: (continued)

4. This package is designed to be soldered to a thermal pad on the board. For more information, see Texas Instruments literature number SLUA271 (www.ti.com/lit/slua271).
5. Vias are optional depending on application, refer to device data sheet. If any vias are implemented, refer to their locations shown on this view. It is recommended that vias under paste be filled, plugged or tented.

EXAMPLE STENCIL DESIGN

DRC0010W

VSON - 1 mm max height

PLASTIC SMALL OUTLINE - NO LEAD

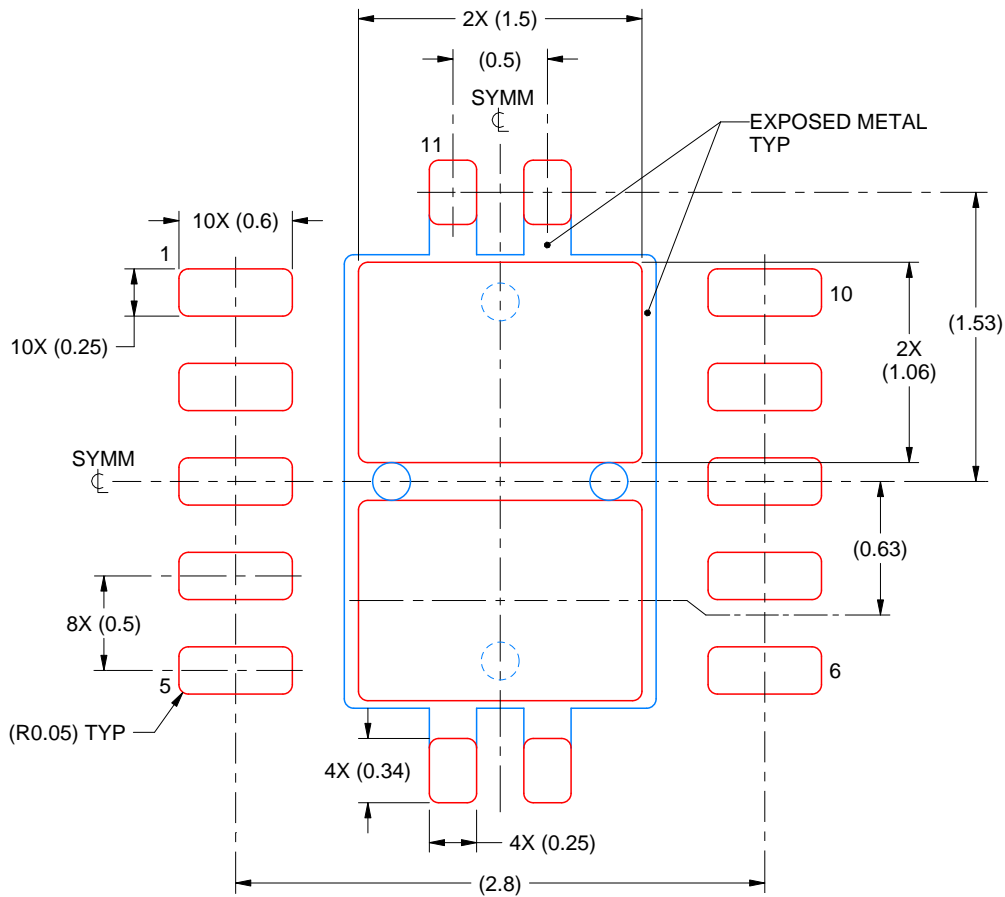

SOLDER PASTE EXAMPLE
BASED ON 0.125 mm THICK STENCIL

EXPOSED PAD 11:
80% PRINTED SOLDER COVERAGE BY AREA
SCALE:25X

4228236/A 12/2021

NOTES: (continued)

6. Laser cutting apertures with trapezoidal walls and rounded corners may offer better paste release. IPC-7525 may have alternate design recommendations.

重要なお知らせと免責事項

TI は、技術データと信頼性データ(データシートを含みます)、設計リソース(リファレンス・デザインを含みます)、アプリケーションや設計に関する各種アドバイス、Web ツール、安全性情報、その他のリソースを、欠陥が存在する可能性のある「現状のまま」提供しており、商品性および特定目的に対する適合性の黙示保証、第三者の知的財産権の非侵害保証を含むいかなる保証も、明示的または黙示的にかかわらず拒否します。

これらのリソースは、TI 製品を使用する設計の経験を積んだ開発者への提供を意図したものです。(1) お客様のアプリケーションに適した TI 製品の選定、(2) お客様のアプリケーションの設計、検証、試験、(3) お客様のアプリケーションに該当する各種規格や、その他のあらゆる安全性、セキュリティ、規制、または他の要件への確実な適合に関する責任を、お客様のみが単独で負うものとし、

上記の各種リソースは、予告なく変更される可能性があります。これらのリソースは、リソースで説明されている TI 製品を使用するアプリケーションの開発の目的でのみ、TI はその使用をお客様に許諾します。これらのリソースに関して、他の目的で複製することや掲載することは禁止されています。TI や第三者の知的財産権のライセンスが付与されている訳ではありません。お客様は、これらのリソースを自身で使用した結果発生するあらゆる申し立て、損害、費用、損失、責任について、TI およびその代理人を完全に補償するものとし、TI は一切の責任を拒否します。

TI の製品は、[TI の販売条件](#)、または [ti.com](#) やかかる TI 製品の関連資料などのいずれかを通じて提供する適用可能な条項の下で提供されています。TI がこれらのリソースを提供することは、適用される TI の保証または他の保証の放棄の拡大や変更を意味するものではありません。

お客様がいかなる追加条項または代替条項を提案した場合でも、TI はそれらに異議を唱え、拒否します。

郵送先住所 : Texas Instruments, Post Office Box 655303, Dallas, Texas 75265
Copyright © 2024, Texas Instruments Incorporated