

TSDxxC 双方向 TVS (過渡電圧サプレッサ) ダイオード、SOD-323 パッケージ

1 特長

- IEC 61000-4-2 ESD 保護:
 - ±30kV 接触放電
 - ±30kV エアギャップ放電
- IEC 61000-4-5 サージ保護:
 - 6.5-30A (8/20μs)
- 低い IO 容量 < 7pF (標準値)
- 超低リーク電流: 10nA (最大値)
- 産業用温度範囲: -55°C ~ +150°C
- 業界標準の SOD-323 リード付きパッケージ (2.65mm × 1.3mm)

2 アプリケーション

- I/O 保護
- 電源ライン保護
- [USB VBUS](#)
- [電化製品](#)
- [医療/ヘルスケア](#)
- [リテールオートメーション](#)

3 概要

TSDxxC は双方向 TVS 保護ダイオードであり、ESD やサージなどの有害な過渡電圧をクランプするよう設計されています。TSDxxC は、最大 ±30kV の ESD 衝撃 (接触放電および気中放電) を吸収する定格を備えており、IEC 61000-4-2 国際規格 (レベル 4) で規定されている最大レベルをクリアしています。

このデバイスの堅牢なクランプ性能と低容量を組み合わせることで TSDxxC は、優れた TVS ダイオードとなり、さまざまなアプリケーションでデータラインおよび電源ラインを保護します。

TSDxxC は、業界標準のリード付き SOD-323 パッケージで供給され、半田付けが容易です。

パッケージ情報

部品番号	パッケージ ⁽¹⁾	パッケージサイズ ⁽²⁾
TSDxxC	DYF (SOD-323, 2)	2.65mm × 1.3mm

- 詳細については、[セクション 9](#) を参照してください。
- パッケージサイズ (長さ × 幅) は公称値であり、該当する場合はピンも含まれます。

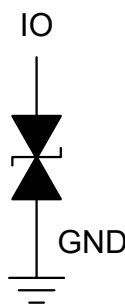

機能ブロック図



Table of Contents

1 特長	1	5.10 Electrical Characteristics - TSD24C.....	9
2 アプリケーション	1	5.11 Electrical Characteristics - TSD36C.....	10
3 概要	1	5.12 Typical Characteristics.....	11
4 Pin Configuration and Functions	3	6 Application and Implementation	13
5 Specifications	3	6.1 Application Information.....	13
5.1 Absolute Maximum Ratings.....	3	7 Device and Documentation Support	13
5.2 ESD Ratings—JEDEC Specification.....	4	7.1 Documentation Support.....	13
5.3 ESD Ratings—IEC Specification.....	4	7.2 ドキュメントの更新通知を受け取る方法.....	13
5.4 Recommended Operating Conditions.....	4	7.3 サポート・リソース.....	13
5.5 Thermal Information.....	4	7.4 Trademarks.....	13
5.6 Electrical Characteristics - TSD05C.....	5	7.5 静電気放電に関する注意事項.....	13
5.7 Electrical Characteristics - TSD12C.....	6	7.6 用語集.....	13
5.8 Electrical Characteristics - TSD15C.....	7	8 Revision History	14
5.9 Electrical Characteristics - TSD18C.....	8	9 Mechanical, Packaging, and Orderable Information ..	14

4 Pin Configuration and Functions



図 4-1. DYF Package, 2-Pin SOD-323 (Top View)

表 4-1. Pin Functions

PIN		TYPE ⁽¹⁾	DESCRIPTION
NO.	NAME		
1	IO	I/O	Protected Channel. If used as IO, connect pin 2 to ground
2	IO	I/O	Protected Channel. If used as IO, connect pin 1 to ground

(1) I = input, O = output

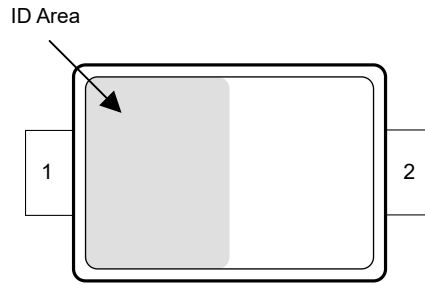
5 Specifications

5.1 Absolute Maximum Ratings

over operating free-air temperature range (unless otherwise noted) ⁽¹⁾

Parameter		DEVICE	MIN	MAX	UNIT
P _{PP}	IEC 61000-4-5 (t _p 8/20μs) Peak Pulse Power at 25°C	TSD05C		400	W
P _{PP}	IEC 61000-4-5 (t _p 8/20μs) Peak Pulse Power at 25°C	TSD12C		390	W
		TSD15C			
		TSD18C			
		TSD24C		400	W
		TSD36C			
I _{PP}	IEC 61000-4-5 (t _p 8/20μs) Peak Pulse Current at 25°C	TSD05C		30	A
I _{PP}	IEC 61000-4-5 (t _p 8/20μs) Peak Pulse Current at 25°C	TSD12C		15	A
		TSD15C		12	A
		TSD18C			
		TSD24C			
		TSD36C		6.5	A
T _A	Ambient Operating Temperature		-55	150	°C
T _{stg}	Storage Temperature		-65	155	°C

(1) Operation outside the Absolute Maximum Ratings may cause permanent device damage. Absolute maximum ratings do not imply functional operation of the device at these or any other conditions beyond those listed under Recommended Operating Conditions. If briefly operating outside the Recommended Operating Conditions but within the Absolute Maximum Ratings, the device may not sustain damage, but it may not be fully functional. Operating the device in this manner may affect device reliability, functionality, performance, and shorten the device lifetime.

5.2 ESD Ratings—JEDEC Specification

			VALUE	UNIT
V _(ESD)	Electrostatic discharge	Human body model (HBM), per ANSI/ESDA/ JEDEC JS-001 ⁽¹⁾	±2500	V
		Charged device model (CDM), per JEDEC specification JS-002 ⁽²⁾	±1000	V

- (1) JEDEC document JEP155 states that 500-V HBM allows safe manufacturing with a standard ESD control process
 (2) JEDEC document JEP157 states that 250-V CDM allows safe manufacturing with a standard ESD control process.

5.3 ESD Ratings—IEC Specification

			VALUE	UNIT
V _(ESD)	Electrostatic discharge	IEC 61000-4-2 contact discharge	±30000	V
		IEC 61000-4-2 air-gap discharge	±30000	

5.4 Recommended Operating Conditions

over operating free-air temperature range (unless otherwise noted)

		MIN	NOM	MAX	UNIT
T _A	Operating free-air temperature	-55		150	°C

5.5 Thermal Information

THERMAL METRIC ⁽¹⁾		TSD05C	TSD12C / TSD15C / TSD18C	TSD24C / TSD36C	UNIT
		DYF (SOD-323)	DYF (SOD-323)	DYF (SOD-323)	
		2 PINS	2 PINS	2 PINS	
R _{θJA}	Junction-to-ambient thermal resistance	672.0	683.8	686.1	°C/W
R _{θJC(top)}	Junction-to-case (top) thermal resistance	230.5	264.2	267.0	°C/W
R _{θJB}	Junction-to-board thermal resistance	541.4	559.0	560.5	°C/W
Ψ _{JT}	Junction-to-top characterization parameter	64.4	89.9	91.4	°C/W
Ψ _{JB}	Junction-to-board characterization parameter	527.5	544.8	546.2	°C/W
R _{θJC(bot)}	Junction-to-case (bottom) thermal resistance	N/A	N/A	N/A	°C/W

- (1) For more information about traditional and new thermal metrics, see the [Semiconductor and IC Package Thermal Metrics](#) application report.

5.6 Electrical Characteristics - TSD05C

At TA=25°C (unless otherwise noted) ⁽¹⁾

PARAMETER		TEST CONDITION	MIN	TYP	MAX	UNIT
V _{RWM}	Reverse stand-off voltage	I _{IO} < 50 nA, across operating temperature range	-5.5		5.5	V
V _{BR}	Break-down voltage	I _{IO} = 1 mA, IO to GND and GND to IO	7	8	9	V
I _{LEAK}	Reverse leakage current	V _{IO} = 5.5 V, IO to GND or GND to IO		5	10	nA
V _{CLAMP}	Surge clamping voltage, t _p = 8/20 μs ⁽²⁾	I _{PP} = 24 A, IO to GND or GND to IO		10.7	13.8	V
		I _{PP} = 30 A, IO to GND or GND to IO		11.5	15	V
	TLP clamping voltage, t _p = 100 ns	I _{PP} = 16 A, IO to GND or GND to IO		9.3		V
R _{DYN}	Dynamic resistance ⁽³⁾	IO to GND		0.15		Ω
		GND to IO				
C _L	Line capacitance	V _{IO} = 0 V; f = 1 MHz, IO to GND		4	7	pF

(1) Typical parameters are measured at 25°C

(2) Nonrepetitive current pulse 8 to 20 μs exponentially decaying waveform according to IEC 61000-4-5

(3) Extraction of R_{DYN} using least squares fit of TLP characteristics between I = 10 A and I = 20 A

5.7 Electrical Characteristics - TSD12C

At TA=25°C (unless otherwise noted) ⁽¹⁾

PARAMETER		TEST CONDITION	MIN	TYP	MAX	UNIT
V _{RWM}	Reverse stand-off voltage	I _{IO} < 10 nA, across operating temperature range			12	V
V _{BRR}	Breakdown voltage	I _{IO} = 10 mA, IO to GND and GND to IO	13.2	15.6	19	V
I _{LEAK}	Reverse leakage current	V _{IO} = 12 V, IO to GND or GND to IO		5	10	nA
V _{CLAMP}	Surge clamping voltage, t _p = 8/20 μs ⁽²⁾	I _{PP} = 1 A, IO to GND or GND to IO			18.5	V
		I _{PP} = 5 A, IO to GND or GND to IO			21	V
		I _{PP} = 15 A, IO to GND or GND to IO			26	V
	TLP clamping voltage, t _p = 100 ns	I _{PP} = 16 A, IO to GND or GND to IO		19.4		V
R _{DYN}	Dynamic resistance ⁽³⁾	IO to GND		0.15		Ω
		GND to IO				
C _L	Line capacitance	V _{IO} = 0 V; f = 1 MHz, IO to GND		6.5	8	pF

(1) Typical parameters are measured at 25°C

(2) Nonrepetitive current pulse 8 to 20 μs exponentially decaying waveform according to IEC 61000-4-5

(3) Extraction of R_{DYN} using least squares fit of TLP characteristics between I = 10 A and I = 20 A

5.8 Electrical Characteristics - TSD15C

At TA=25°C (unless otherwise noted) ⁽¹⁾

PARAMETER		TEST CONDITION	MIN	TYP	MAX	UNIT
V _{RWM}	Reverse stand-off voltage	I _{IO} < 10 nA, across operating temperature range			15	V
V _{BRR}	Breakdown voltage	I _{IO} = 10 mA, IO to GND and GND to IO	19	22	25	V
I _{LEAK}	Reverse leakage current	V _{IO} = 15 V, IO to GND or GND to IO		5	10	nA
V _{CLAMP}	Surge clamping voltage, t _p = 8/20 μs ⁽²⁾	I _{PP} = 1 A, IO to GND or GND to IO			25.6	V
		I _{PP} = 5 A, IO to GND or GND to IO			28	V
		I _{PP} = 12 A, IO to GND or GND to IO			33	V
	TLP clamping voltage, t _p = 100 ns	I _{PP} = 16 A, IO to GND or GND to IO		25		V
R _{DYN}	Dynamic resistance ⁽³⁾	IO to GND		0.2		Ω
		GND to IO				
C _L	Line capacitance	V _{IO} = 0 V; f = 1 MHz, IO to GND		6.7	9	pF

(1) Typical parameters are measured at 25°C

(2) Nonrepetitive current pulse 8 to 20 μs exponentially decaying waveform according to IEC 61000-4-5

(3) Extraction of R_{DYN} using least squares fit of TLP characteristics between I = 10 A and I = 20 A

5.9 Electrical Characteristics - TSD18C

At TA=25°C (unless otherwise noted) ⁽¹⁾

PARAMETER		TEST CONDITION	MIN	TYP	MAX	UNIT
V _{RWM}	Reverse stand-off voltage	I _{IO} < 10 nA, across operating temperature range			18	V
V _{BRR}	Breakdown voltage	I _{IO} = 10 mA, IO to GND and GND to IO	19	22	25	V
I _{LEAK}	Reverse leakage current	V _{IO} = 18 V, IO to GND or GND to IO		5	10	nA
V _{CLAMP}	Surge clamping voltage, t _p = 8/20 μs ⁽²⁾	I _{PP} = 1 A, IO to GND or GND to IO			25.6	V
		I _{PP} = 5 A, IO to GND or GND to IO			28	V
		I _{PP} = 12 A, IO to GND or GND to IO			33	V
	TLP clamping voltage, t _p = 100 ns	I _{PP} = 16 A, IO to GND or GND to IO		25		V
R _{DYN}	Dynamic resistance ⁽³⁾	IO to GND		0.2		Ω
		GND to IO				
C _L	Line capacitance	V _{IO} = 0 V; f = 1 MHz, IO to GND		6.7	9	pF

(1) Typical parameters are measured at 25°C

(2) Nonrepetitive current pulse 8 to 20 μs exponentially decaying waveform according to IEC 61000-4-5

(3) Extraction of R_{DYN} using least squares fit of TLP characteristics between I = 10 A and I = 20 A

5.10 Electrical Characteristics - TSD24C

At TA=25°C (unless otherwise noted) ⁽¹⁾

PARAMETER		TEST CONDITION	MIN	TYP	MAX	UNIT
V _{RWM}	Reverse stand-off voltage	I _{IO} < 10 nA, across operating temperature range			24	V
V _{BR}	Breakdown voltage	I _{IO} = 10 mA, IO to GND and GND to IO	25.5	30.5	35.5	V
I _{LEAK}	Reverse leakage current	V _{IO} = 24 V, IO to GND or GND to IO		5	10	nA
V _{CLAMP}	Surge clamping voltage, t _p = 8/20 μs ⁽²⁾	I _{PP} = 1 A, IO to GND or GND to IO			34	V
		I _{PP} = 5 A, IO to GND or GND to IO			43	V
		I _{PP} = 9 A, IO to GND or GND to IO			50	V
	TLP clamping voltage, t _p = 100 ns	I _{PP} = 16 A, IO to GND or GND to IO		36		V
R _{DYN}	Dynamic resistance ⁽³⁾	IO to GND		0.35		Ω
		GND to IO				
C _L	Line capacitance	V _{IO} = 0 V; f = 1 MHz, IO to GND		4.3	6	pF

(1) Typical parameters are measured at 25°C

(2) Nonrepetitive current pulse 8 to 20 μs exponentially decaying waveform according to IEC 61000-4-5

(3) Extraction of R_{DYN} using least squares fit of TLP characteristics between I = 10 A and I = 20 A

5.11 Electrical Characteristics - TSD36C

At TA=25°C (unless otherwise noted) ⁽¹⁾

PARAMETER		TEST CONDITION	MIN	TYP	MAX	UNIT
V _{RWM}	Reverse stand-off voltage	I _{IO} < 50 nA, across operating temperature range			36	V
V _{BR}	Breakdown voltage	I _{IO} = 10 mA, I/O to GND and GND to I/O	37.8	41.2	44.2	V
I _{LEAK}	Reverse leakage current	V _{IO} = 36 V, IO to GND or GND to IO		5	10	nA
V _{CLAMP}	Surge clamping voltage, t _p = 8/20 μs ⁽²⁾	I _{PP} = 1 A, IO to GND or GND to IO			47	V
		I _{PP} = 5 A, IO to GND or GND to IO			64	V
		I _{PP} = 6.5 A, IO to GND or GND to IO			71	V
	TLP clamping voltage, t _p = 100 ns	I _{PP} = 16 A, IO to GND or GND to IO		56		V
R _{DYN}	Dynamic resistance ⁽³⁾	IO to GND		0.6		Ω
		GND to IO				
C _L	Line capacitance	V _{IO} = 0 V; f = 1 MHz, IO to GND		4.3	6	pF

(1) Typical parameters are measured at 25°C

(2) Nonrepetitive current pulse 8 to 20 μs exponentially decaying waveform according to IEC 61000-4-5

(3) Extraction of RDYN using least squares fit of TLP characteristics between I = 10 A and I = 20 A

5.12 Typical Characteristics



図 5-1. Positive TLP Curve - TSD05C



図 5-2. Negative TLP Curve - TSD05C

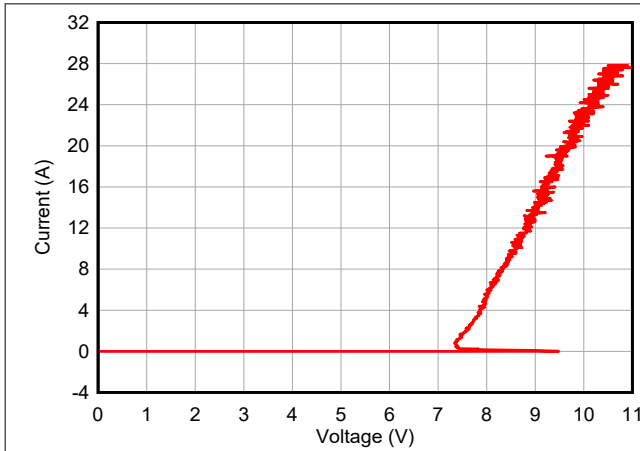

図 5-3. Positive TLP Curve - TSD12C

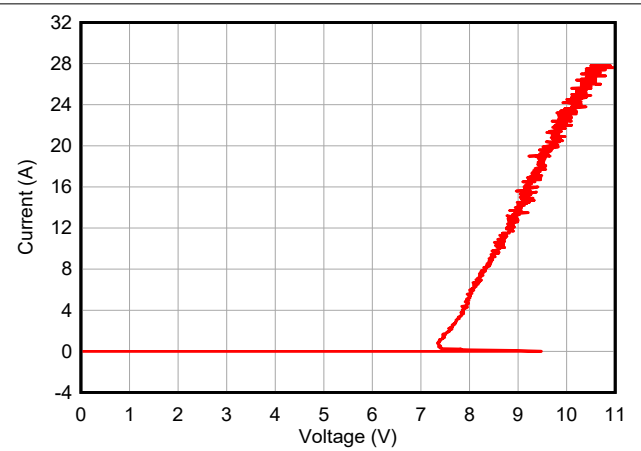

図 5-4. Positive TLP Curve - TSD15C

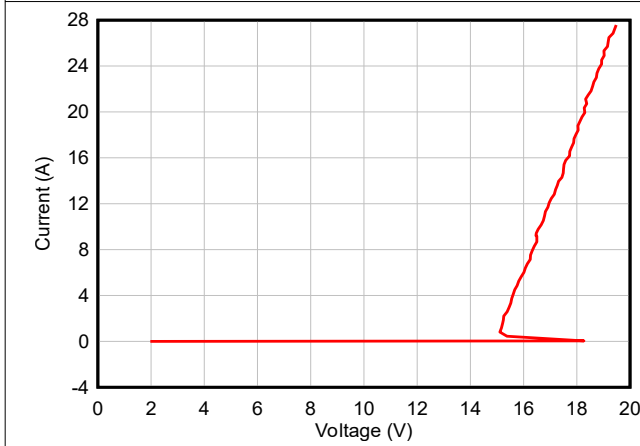

図 5-5. Positive TLP Curve - TSD18C

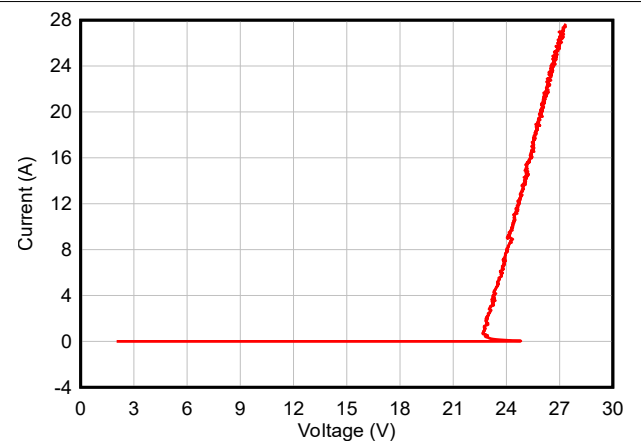

図 5-6. Positive TLP Curve - TSD24C

5.12 Typical Characteristics (continued)

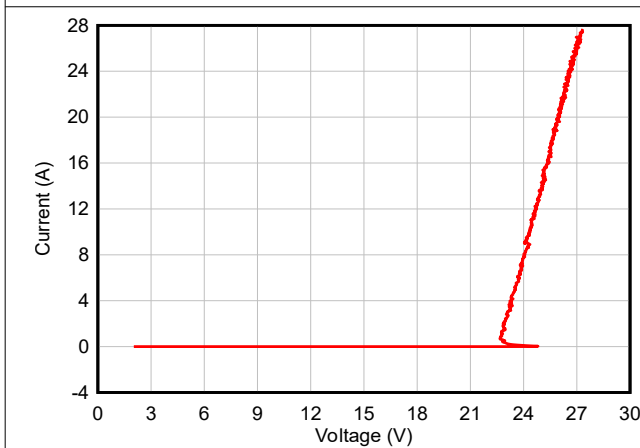

6 Application and Implementation

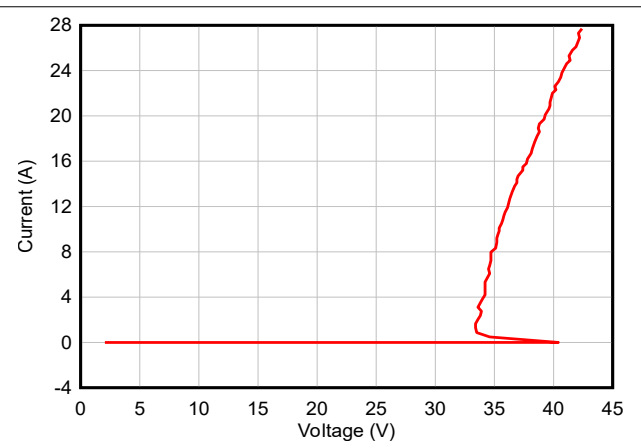
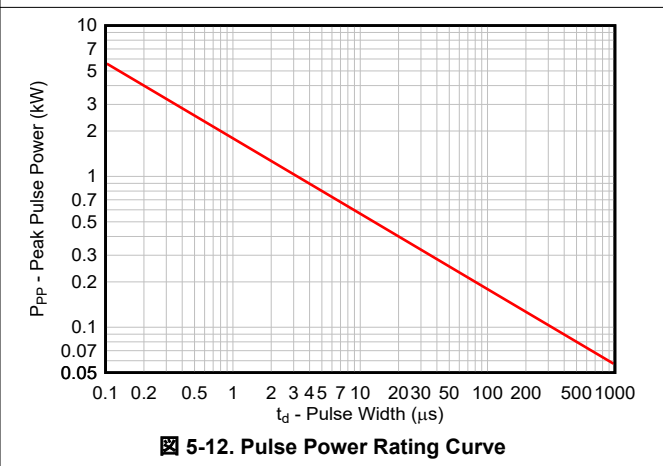
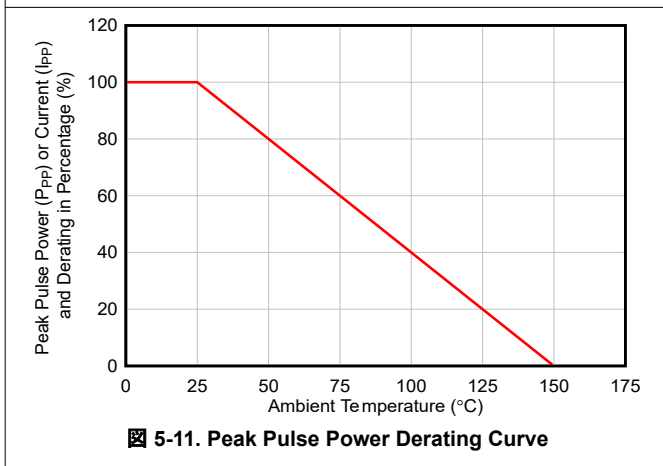
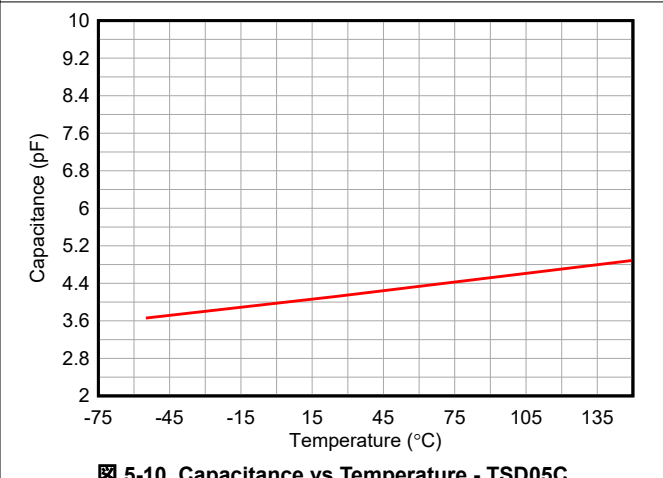
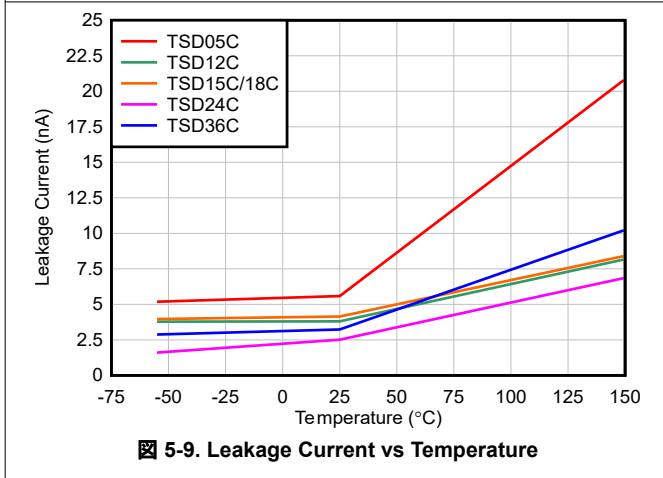
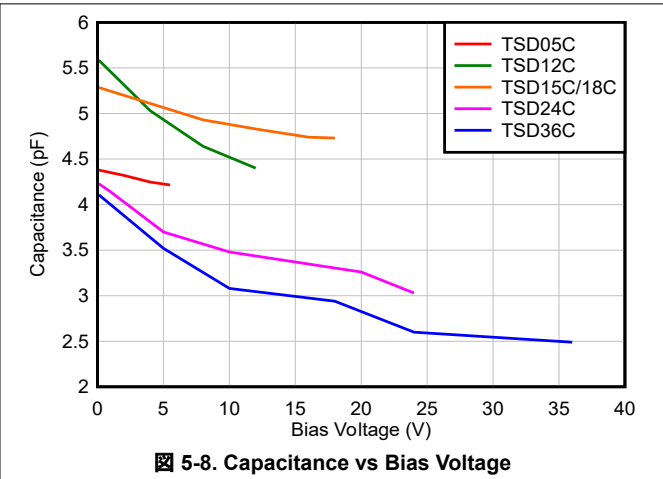
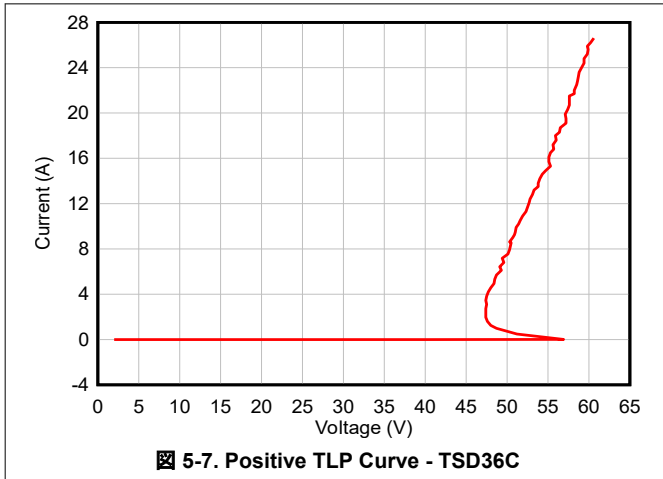
注

Information in the following applications sections is not part of the TI component specification, and TI does not warrant its accuracy or completeness. TI's customers are responsible for determining suitability of components for their purposes, as well as validating and testing their design implementation to confirm system functionality.

6.1 Application Information

The TSDxxC are TVS diodes that provide a path to ground for dissipating transient voltage spikes (such as ESD or surge) on signal lines and power lines. Connect the device in parallel to the down stream circuitry for protection. As the current from the transient passes through the TVS, only a small voltage drop is present across the diode. The small voltage drop is presented to the protected IC. The low R_{DYN} of the triggered TVS holds this voltage (V_{CLAMP}) to a safe level for the protected IC. For more information on how to properly use this device, refer to the [ESD Packaging and Layout Guide](#).

7 Device and Documentation Support

7.1 Documentation Support

7.1.1 Related Documentation

For related documentation, see the following:

- Texas Instruments, [ESD Packaging and Layout Guide application reports](#)
- Texas Instruments, [ESD Layout Guide application reports](#)
- Texas Instruments, [Generic ESD Evaluation Module user's guide](#)
- Texas Instruments, [Reading and Understanding an ESD Protection data sheet](#)

7.2 ドキュメントの更新通知を受け取る方法

ドキュメントの更新についての通知を受け取るには、www.tij.co.jp のデバイス製品フォルダを開いてください。[通知] をクリックして登録すると、変更されたすべての製品情報に関するダイジェストを毎週受け取ることができます。変更の詳細については、改訂されたドキュメントに含まれている改訂履歴をご覧ください。

7.3 サポート・リソース

テキサス・インスツルメンツ E2E™ サポート・フォーラムは、エンジニアが検証済みの回答と設計に関するヒントをエキスパートから迅速かつ直接得ることができる場所です。既存の回答を検索したり、独自の質問をしたりすることで、設計に必要な支援を迅速に得ることができます。

リンクされているコンテンツは、各寄稿者により「現状のまま」提供されるものです。これらはテキサス・インスツルメンツの仕様を構成するものではなく、必ずしもテキサス・インスツルメンツの見解を反映したものではありません。テキサス・インスツルメンツの[使用条件](#)を参照してください。

7.4 Trademarks

テキサス・インスツルメンツ E2E™ is a trademark of Texas Instruments.

すべての商標は、それぞれの所有者に帰属します。

7.5 静電気放電に関する注意事項



この IC は、ESD によって破損する可能性があります。テキサス・インスツルメンツは、IC を取り扱う際には常に適切な注意を払うことを推奨します。正しい取り扱いおよび設置手順に従わない場合、デバイスを破損するおそれがあります。

ESD による破損は、わずかな性能低下からデバイスの完全な故障まで多岐にわたります。精密な IC の場合、パラメータがわずかに変化するだけで公表されている仕様から外れる可能性があるため、破損が発生しやすくなっています。

7.6 用語集

[テキサス・インスツルメンツ用語集](#)

この用語集には、用語や略語の一覧および定義が記載されています。

8 Revision History

資料番号末尾の英字は改訂を表しています。その改訂履歴は英語版に準じています。

Changes from Revision B (July 2024) to Revision C (October 2024)	Page
• TSD12C、TSD15C、TSD18C、TSD24C をデータシートに追加.....	1

Changes from Revision A (July 2023) to Revision B (July 2024)	Page
• TSD36C をデータシートに追加.....	1
• データシートのステータスを以下のように変更:「事前情報」から「量産データ」に変更	1

9 Mechanical, Packaging, and Orderable Information

The following pages include mechanical, packaging, and orderable information. This information is the most current data available for the designated devices. This data is subject to change without notice and revision of this document. For browser-based versions of this data sheet, refer to the left-hand navigation

重要なお知らせと免責事項

テキサス・インスツルメンツは、技術データと信頼性データ (データシートを含みます)、設計リソース (リファレンス デザインを含みます)、アプリケーションや設計に関する各種アドバイス、Web ツール、安全性情報、その他のリソースを、欠陥が存在する可能性のある「現状のまま」提供しており、商品性および特定目的に対する適合性の黙示保証、第三者の知的財産権の非侵害保証を含むいかなる保証も、明示的または黙示的にかかわらず拒否します。

これらのリソースは、テキサス・インスツルメンツ製品を使用する設計の経験を積んだ開発者への提供を意図したものです。(1) お客様のアプリケーションに適した テキサス・インスツルメンツ製品の選定、(2) お客様のアプリケーションの設計、検証、試験、(3) お客様のアプリケーションに該当する各種規格や、その他のあらゆる安全性、セキュリティ、規制、または他の要件への確実な適合に関する責任を、お客様のみが単独で負うものとします。

上記の各種リソースは、予告なく変更される可能性があります。これらのリソースは、リソースで説明されている テキサス・インスツルメンツ製品を使用するアプリケーションの開発の目的でのみ、テキサス・インスツルメンツはその使用をお客様に許諾します。これらのリソースに関して、他の目的で複製することや掲載することは禁止されています。テキサス・インスツルメンツや第三者の知的財産権のライセンスが付与されている訳ではありません。お客様は、これらのリソースを自身で使用した結果発生するあらゆる申し立て、損害、費用、損失、責任について、テキサス・インスツルメンツおよびその代理人を完全に補償するものとし、テキサス・インスツルメンツは一切の責任を拒否します。

テキサス・インスツルメンツの製品は、[テキサス・インスツルメンツの販売条件](#)、または [ti.com](https://www.ti.com) やかかる テキサス・インスツルメンツ製品の関連資料などのいずれかを通じて提供する適用可能な条項の下で提供されています。テキサス・インスツルメンツがこれらのリソースを提供することは、適用されるテキサス・インスツルメンツの保証または他の保証の放棄の拡大や変更を意味するものではありません。

お客様がいかなる追加条項または代替条項を提案した場合でも、テキサス・インスツルメンツはそれらに異議を唱え、拒否します。

郵送先住所: Texas Instruments, Post Office Box 655303, Dallas, Texas 75265

Copyright © 2024, Texas Instruments Incorporated

PACKAGING INFORMATION

Orderable Device	Status (1)	Package Type	Package Drawing	Pins	Package Qty	Eco Plan (2)	Lead finish/ Ball material (6)	MSL Peak Temp (3)	Op Temp (°C)	Device Marking (4/5)	Samples
TSD05CDYFR	ACTIVE	SOT	DYF	2	3000	RoHS & Green	SN	Level-3-260C-168 HR	-40 to 125	33KF	Samples
TSD12CDYFR	ACTIVE	SOT	DYF	2	3000	RoHS & Green	SN	Level-3-260C-168 HR	-55 to 150	3JMF	Samples
TSD15CDYFR	ACTIVE	SOT	DYF	2	3000	RoHS & Green	SN	Level-3-260C-168 HR	-55 to 150	3MLF	Samples
TSD18CDYFR	ACTIVE	SOT	DYF	2	3000	RoHS & Green	SN	Level-3-260C-168 HR	-55 to 150	3JQF	Samples
TSD24CDYFR	ACTIVE	SOT	DYF	2	3000	RoHS & Green	SN	Level-3-260C-168 HR	-55 to 150	3GWF	Samples
TSD36CDYFR	ACTIVE	SOT	DYF	2	3000	RoHS & Green	SN	Level-3-260C-168 HR	-55 to 150	3GNF	Samples

(1) The marketing status values are defined as follows:

ACTIVE: Product device recommended for new designs.

LIFEBUY: TI has announced that the device will be discontinued, and a lifetime-buy period is in effect.

NRND: Not recommended for new designs. Device is in production to support existing customers, but TI does not recommend using this part in a new design.

PREVIEW: Device has been announced but is not in production. Samples may or may not be available.

OBSELETE: TI has discontinued the production of the device.

(2) **RoHS:** TI defines "RoHS" to mean semiconductor products that are compliant with the current EU RoHS requirements for all 10 RoHS substances, including the requirement that RoHS substance do not exceed 0.1% by weight in homogeneous materials. Where designed to be soldered at high temperatures, "RoHS" products are suitable for use in specified lead-free processes. TI may reference these types of products as "Pb-Free".

RoHS Exempt: TI defines "RoHS Exempt" to mean products that contain lead but are compliant with EU RoHS pursuant to a specific EU RoHS exemption.

Green: TI defines "Green" to mean the content of Chlorine (Cl) and Bromine (Br) based flame retardants meet JS709B low halogen requirements of <=1000ppm threshold. Antimony trioxide based flame retardants must also meet the <=1000ppm threshold requirement.

(3) MSL, Peak Temp. - The Moisture Sensitivity Level rating according to the JEDEC industry standard classifications, and peak solder temperature.

(4) There may be additional marking, which relates to the logo, the lot trace code information, or the environmental category on the device.

(5) Multiple Device Markings will be inside parentheses. Only one Device Marking contained in parentheses and separated by a "-" will appear on a device. If a line is indented then it is a continuation of the previous line and the two combined represent the entire Device Marking for that device.

(6) Lead finish/Ball material - Orderable Devices may have multiple material finish options. Finish options are separated by a vertical ruled line. Lead finish/Ball material values may wrap to two lines if the finish value exceeds the maximum column width.

Important Information and Disclaimer: The information provided on this page represents TI's knowledge and belief as of the date that it is provided. TI bases its knowledge and belief on information provided by third parties, and makes no representation or warranty as to the accuracy of such information. Efforts are underway to better integrate information from third parties. TI has taken and continues to take reasonable steps to provide representative and accurate information but may not have conducted destructive testing or chemical analysis on incoming materials and chemicals. TI and TI suppliers consider certain information to be proprietary, and thus CAS numbers and other limited information may not be available for release.

In no event shall TI's liability arising out of such information exceed the total purchase price of the TI part(s) at issue in this document sold by TI to Customer on an annual basis.

OTHER QUALIFIED VERSIONS OF TSD12C, TSD15C, TSD18C, TSD24C :

- Automotive : [TSD12C-Q1](#), [TSD15C-Q1](#), [TSD18C-Q1](#), [TSD24C-Q1](#)

NOTE: Qualified Version Definitions:

- Automotive - Q100 devices qualified for high-reliability automotive applications targeting zero defects

TAPE AND REEL INFORMATION

QUADRANT ASSIGNMENTS FOR PIN 1 ORIENTATION IN TAPE

*All dimensions are nominal

Device	Package Type	Package Drawing	Pins	SPQ	Reel Diameter (mm)	Reel Width W1 (mm)	A0 (mm)	B0 (mm)	K0 (mm)	P1 (mm)	W (mm)	Pin1 Quadrant
TSD05CDYFR	SOT	DYF	2	3000	178.0	9.5	1.48	3.3	1.25	4.0	8.0	Q1
TSD12CDYFR	SOT	DYF	2	3000	178.0	9.5	1.48	3.3	1.25	4.0	8.0	Q1
TSD15CDYFR	SOT	DYF	2	3000	178.0	9.5	1.48	3.3	1.25	4.0	8.0	Q1
TSD18CDYFR	SOT	DYF	2	3000	178.0	9.5	1.48	3.3	1.25	4.0	8.0	Q1
TSD24CDYFR	SOT	DYF	2	3000	178.0	9.5	1.48	3.3	1.25	4.0	8.0	Q1
TSD36CDYFR	SOT	DYF	2	3000	178.0	9.5	1.48	3.3	1.25	4.0	8.0	Q1

TAPE AND REEL BOX DIMENSIONS

*All dimensions are nominal

Device	Package Type	Package Drawing	Pins	SPQ	Length (mm)	Width (mm)	Height (mm)
TSD05CDYFR	SOT	DYF	2	3000	210.0	200.0	42.0
TSD12CDYFR	SOT	DYF	2	3000	210.0	200.0	42.0
TSD15CDYFR	SOT	DYF	2	3000	210.0	200.0	42.0
TSD18CDYFR	SOT	DYF	2	3000	210.0	200.0	42.0
TSD24CDYFR	SOT	DYF	2	3000	210.0	200.0	42.0
TSD36CDYFR	SOT	DYF	2	3000	210.0	200.0	42.0

DYF0002A



PACKAGE OUTLINE

SOT(SOD-323) - 1 mm max height

SMALL OUTLINE TRANSISTOR

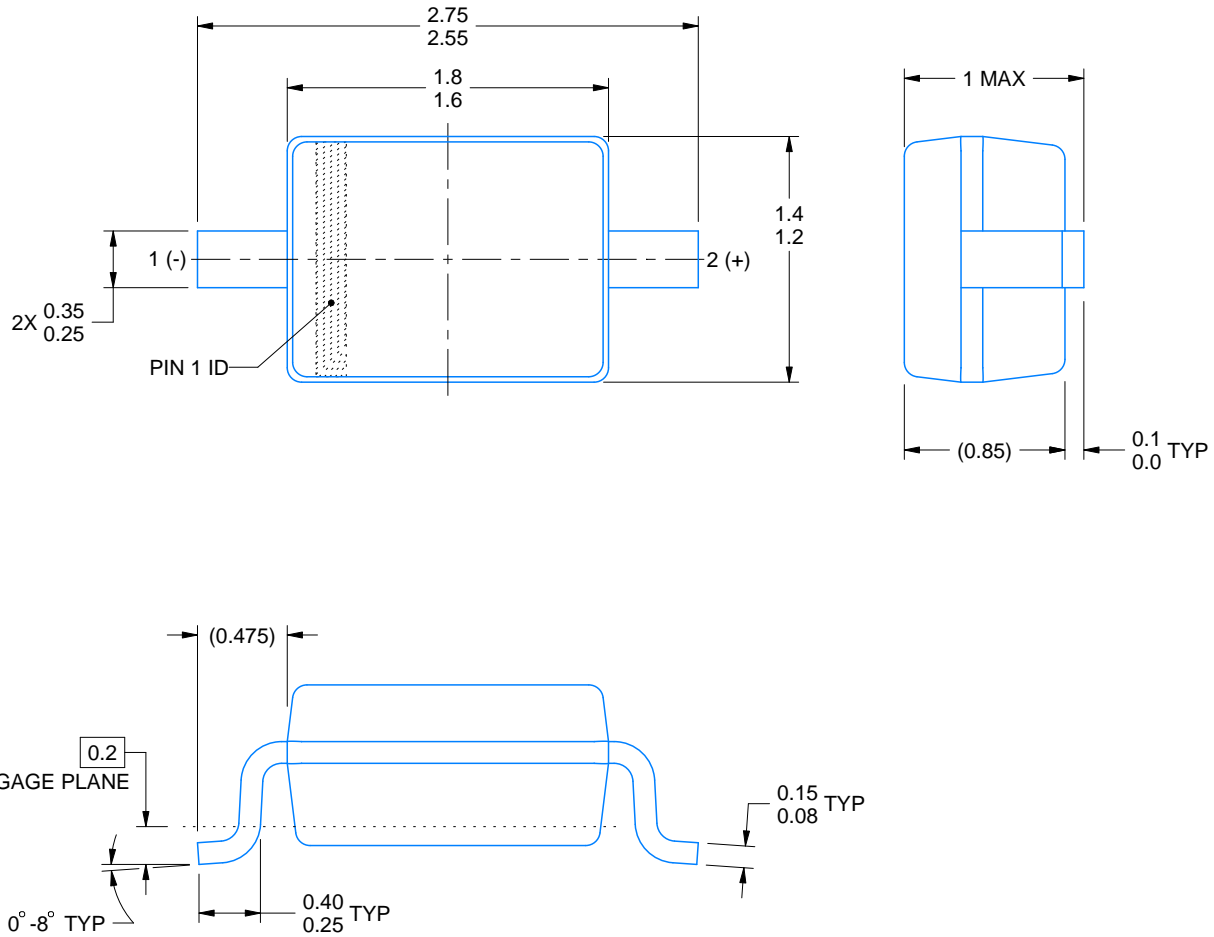

4228484/A 02/2022

NOTES:

1. All linear dimensions are in millimeters. Any dimensions in parenthesis are for reference only. Dimensioning and tolerancing per ASME Y14.5M.
2. This drawing is subject to change without notice.

EXAMPLE BOARD LAYOUT

DYF0002A

SOT(SOD-323) - 1 mm max height

SMALL OUTLINE TRANSISTOR

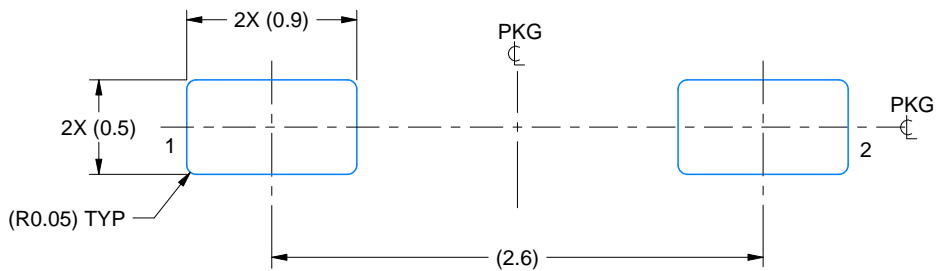

LAND PATTERN EXAMPLE
EXPOSED METAL SHOWN
SCALE:25X

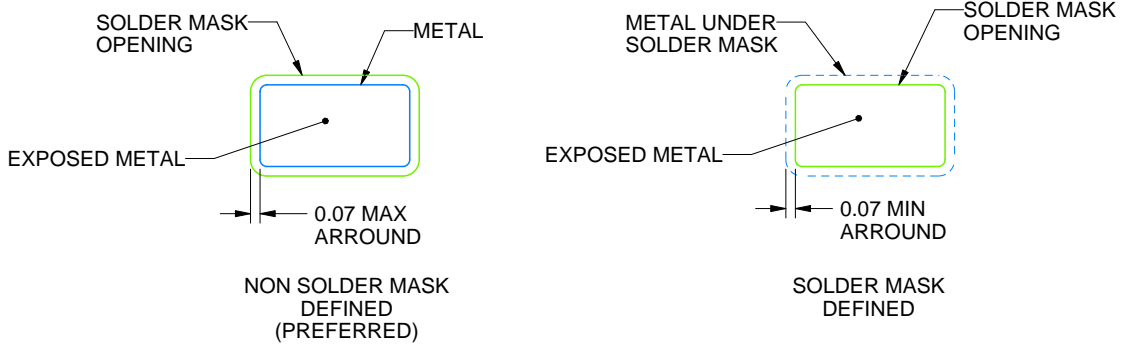

SOLDER MASK DETAILS

4228484/A 02/2022

NOTES: (continued)

- 3. Publication IPC-7351 may have alternate designs.
- 4. Solder mask tolerances between and around signal pads can vary based on board fabrication site.

EXAMPLE STENCIL DESIGN

DYF0002A

SOT(SOD-323) - 1 mm max height

SMALL OUTLINE TRANSISTOR

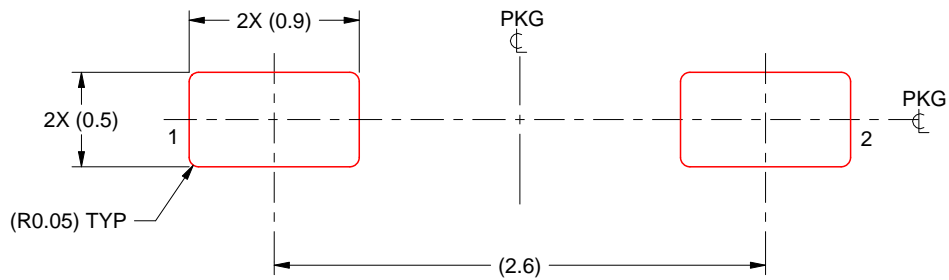

SOLDER PASTE EXAMPLE
BASED ON 0.125 mm THICK STENCIL
SCALE:25X

4228484/A 02/2022

NOTES: (continued)

5. Laser cutting apertures with trapezoidal walls and rounded corners may offer better paste release. IPC-7525 may have alternate design recommendations.
6. Board assembly site may have different recommendations for stencil design.

重要なお知らせと免責事項

TI は、技術データと信頼性データ (データシートを含みます)、設計リソース (リファレンス・デザインを含みます)、アプリケーションや設計に関する各種アドバイス、Web ツール、安全性情報、その他のリソースを、欠陥が存在する可能性のある「現状のまま」提供しており、商品性および特定目的に対する適合性の黙示保証、第三者の知的財産権の非侵害保証を含むいかなる保証も、明示的または黙示的にかかわらず拒否します。

これらのリソースは、TI 製品を使用する設計の経験を積んだ開発者への提供を意図したものです。(1) お客様のアプリケーションに適した TI 製品の選定、(2) お客様のアプリケーションの設計、検証、試験、(3) お客様のアプリケーションに該当する各種規格や、その他のあらゆる安全性、セキュリティ、規制、または他の要件への確実な適合に関する責任を、お客様のみが単独で負うものとします。

上記の各種リソースは、予告なく変更される可能性があります。これらのリソースは、リソースで説明されている TI 製品を使用するアプリケーションの開発の目的でのみ、TI はその使用をお客様に許諾します。これらのリソースに関して、他の目的で複製することや掲載することは禁止されています。TI や第三者の知的財産権のライセンスが付与されている訳ではありません。お客様は、これらのリソースを自身で使用した結果発生するあらゆる申し立て、損害、費用、損失、責任について、TI およびその代理人を完全に補償するものとし、TI は一切の責任を拒否します。

TI の製品は、[TI の販売条件](#)、または [ti.com](#) やかかる TI 製品の関連資料などのいずれかを通じて提供する適用可能な条項の下で提供されています。TI がこれらのリソースを提供することは、適用される TI の保証または他の保証の放棄の拡大や変更を意味するものではありません。

お客様がいかなる追加条項または代替条項を提案した場合でも、TI はそれらに異議を唱え、拒否します。

郵送先住所 : Texas Instruments, Post Office Box 655303, Dallas, Texas 75265
Copyright © 2024, Texas Instruments Incorporated