

# TSDxxC-Q1 Bidirectional TVS Diodes in SOD-323 Package for Automotive Applications

## 1 Features

- ISO 10605 (330pF, 330 Ohm) ESD protection:
  - ±30kV contact discharge (±27kV for TSD36C-Q1)
  - ±30kV air gap discharge
- IEC 61000-4-5 surge protection:
  - 6.5-15A (8/20 μs)
- Low IO capacitance < 7pF (typical)
- Ultra low leakage current: 10nA (maximum)
- Industrial temperature range: –55°C to +150°C
- Industry standard SOD-323 leaded package (2.65mm × 1.3mm)

## 2 Applications

- I/O Protection
- Power Line Protection
- [USB VBUS](#)
- [Body Electronics & Lighting](#)
- [Hybrid, Electric, & Powertrain Systems](#)

## 3 Description

The TSDxxC-Q1 are a family of bidirectional TVS protection diodes designed for clamping harmful transients such as ESD and surge in automotive applications. The TSDxxC-Q1 devices are rated to dissipate ESD strikes up to ±30kV (contact and air gap discharge) which exceeds the maximum level specified in the IEC 61000-4-2 international standard (Level 4).

Combining the robust clamping performance and low capacitance of these devices, TSDxxC-Q1 are excellent TVS diodes to protect both data lines and power lines in many different applications.

The TSDxxC-Q1 family is offered in the industry standard, leaded SOD-323 package to enable easy solderability.

### Package Information

PART NUMBER	PACKAGE <sup>(1)</sup>	PACKAGE SIZE <sup>(2)</sup>
TSDxxC-Q1	DYF (SOD-323, 2)	2.65mm × 1.3mm

(1) For more information, see [Section 10](#).

(2) The package size (length × width) is a nominal value and includes pins, where applicable.

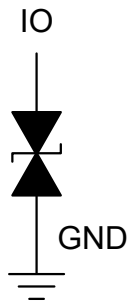

**Functional Block Diagram**



## Table of Contents

<b>1 Features</b> .....	1	5.11 Electrical Characteristics - TSD36C-Q1 .....	10
<b>2 Applications</b> .....	1	5.12 Typical Characteristics.....	11
<b>3 Description</b> .....	1	<b>6 Application and Implementation</b> .....	13
<b>4 Pin Configuration and Functions</b> .....	3	<b>7 Application Information</b> .....	14
<b>5 Specifications</b> .....	4	<b>8 Device and Documentation Support</b> .....	15
5.1 Absolute Maximum Ratings.....	4	8.1 Documentation Support.....	15
5.2 ESD Ratings - AEC Specifications.....	4	8.2 Receiving Notification of Documentation Updates...	15
5.3 ESD Ratings—IEC Specification.....	4	8.3 Support Resources.....	15
5.4 ESD Ratings - ISO Specifications.....	5	8.4 Trademarks.....	15
5.5 Recommended Operating Conditions.....	5	8.5 Electrostatic Discharge Caution.....	15
5.6 Thermal Information.....	5	8.6 Glossary.....	15
5.7 Electrical Characteristics - TSD12C-Q1 .....	6	<b>9 Revision History</b> .....	15
5.8 Electrical Characteristics - TSD15C-Q1 .....	7	<b>10 Mechanical, Packaging, and Orderable Information</b> .....	15
5.9 Electrical Characteristics - TSD18C-Q1 .....	8		
5.10 Electrical Characteristics - TSD24C-Q1 .....	9		

## 4 Pin Configuration and Functions

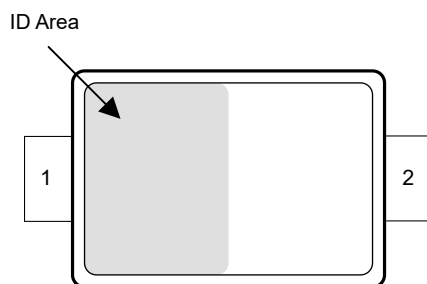

**Figure 4-1. DYF Package, 2-Pin SOD-323 (Top View)**

**Table 4-1. Pin Functions**

PIN		TYPE <sup>(1)</sup>	DESCRIPTION
NO.	NAME		
1	IO	I/O	Protected Channel. If used as IO, connect pin 2 to ground
2	IO	I/O	Protected Channel. If used as IO, connect pin 1 to ground

(1) I = input, O = output

## 5 Specifications

### 5.1 Absolute Maximum Ratings

over operating free-air temperature range (unless otherwise noted) <sup>(1)</sup>

Parameter		DEVICE	MIN	MAX	UNIT
P <sub>PP</sub>	IEC 61000-4-5 (t <sub>p</sub> 8/20μs) Peak Pulse Power at 25°C	TSD12C-Q1		390	W
		TSD15C-Q1			
		TSD18C-Q1			
		TSD24C-Q1			
		TSD36C-Q1			
I <sub>PP</sub>	IEC 61000-4-5 (t <sub>p</sub> 8/20μs) Peak Pulse Current at 25°C	TSD12C-Q1		15	A
		TSD15C-Q1		12	A
		TSD18C-Q1			
		TSD24C-Q1		9	A
		TSD36C-Q1		6.5	A
T <sub>A</sub>	Ambient Operating Temperature		-55	150	°C
T <sub>stg</sub>	Storage Temperature		-65	155	°C

- (1) Operation outside the Absolute Maximum Ratings may cause permanent device damage. Absolute maximum ratings do not imply functional operation of the device at these or any other conditions beyond those listed under Recommended Operating Conditions. If briefly operating outside the Recommended Operating Conditions but within the Absolute Maximum Ratings, the device may not sustain damage, but it may not be fully functional. Operating the device in this manner may affect device reliability, functionality, performance, and shorten the device lifetime.

### 5.2 ESD Ratings - AEC Specifications

Parameter		Test Conditions	VALUE	UNIT
V <sub>(ESD)</sub>	Electrostatic discharge	Human body model (HBM), per AEC Q101-001 <sup>(1)</sup>	±2500	V
		Charged device model (CDM), per AEC Q101-005 <sup>(2)</sup>	±1000	

- (1) JEDEC document JEP155 states that 500-V HBM allows safe manufacturing with a standard ESD control process.  
 (2) JEDEC document JEP157 states that 250-V CDM allows safe manufacturing with a standard ESD control process.

### 5.3 ESD Ratings—IEC Specification

			VALUE	UNIT
V <sub>(ESD)</sub>	Electrostatic discharge	IEC 61000-4-2 contact discharge	±30000	V
		IEC 61000-4-2 air-gap discharge	±30000	

### 5.4 ESD Ratings - ISO Specifications

Parameter		Test Conditions	Device	VALUE	UNIT	
V <sub>(ESD)</sub>	ISO 10605 Electrostatic Discharge	Contact discharge, all pins	C = 150 pF; R = 330 Ω	TSD12C-Q1	±30000	V
				TSD15C-Q1		
				TSD18C-Q1		
				TSD24C-Q1		
				TSD36C-Q1		
			C = 330 pF; R = 330 Ω	TSD12C-Q1	±30000	V
				TSD15C-Q1		
				TSD18C-Q1		
				TSD24C-Q1		
				TSD36C-Q1		
		Air-gap discharge, all pins	C = 150 pF; R = 330 Ω	TSD12C-Q1	±30000	V
				TSD15C-Q1		
TSD18C-Q1						
TSD24C-Q1						
TSD36C-Q1						
C = 330 pF; R = 330 Ω	TSD12C-Q1		±30000	V		
	TSD15C-Q1					
	TSD18C-Q1					
	TSD24C-Q1					
	TSD36C-Q1					

### 5.5 Recommended Operating Conditions

over operating free-air temperature range (unless otherwise noted)

		MIN	NOM	MAX	UNIT
T <sub>A</sub>	Operating free-air temperature	-55		150	°C

### 5.6 Thermal Information

THERMAL METRIC		TSD12C-Q1 / TSD15C-Q1 / TSD18C-Q1	TSD24C-Q1 / TSD36C-Q1	UNIT
		DYF (SOD-323)	DYF (SOD-323)	
		2 PINS	2 PINS	
R <sub>θJA</sub>	Junction-to-ambient thermal resistance	683.8	686.1	°C/W
R <sub>θJC(top)</sub>	Junction-to-case (top) thermal resistance	264.2	267.0	°C/W
R <sub>θJB</sub>	Junction-to-board thermal resistance	559.0	560.5	°C/W
Ψ <sub>JT</sub>	Junction-to-top characterization parameter	89.9	91.4	°C/W
Ψ <sub>JB</sub>	Junction-to-board characterization parameter	544.8	546.2	°C/W
R <sub>θJC(bot)</sub>	Junction-to-case (bottom) thermal resistance	N/A	N/A	°C/W

## 5.7 Electrical Characteristics - TSD12C-Q1

At TA=25°C (unless otherwise noted) <sup>(1)</sup>

PARAMETER		TEST CONDITION	MIN	TYP	MAX	UNIT
V <sub>RWM</sub>	Reverse stand-off voltage	I <sub>IO</sub> < 10 nA, across operating temperature range			12	V
V <sub>BRR</sub>	Breakdown voltage	I <sub>IO</sub> = 10 mA, IO to GND and GND to IO	13.2	15.6	19	V
I <sub>LEAK</sub>	Reverse leakage current	V <sub>IO</sub> = 12 V, IO to GND or GND to IO		5	10	nA
V <sub>CLAMP</sub>	Surge clamping voltage, t <sub>p</sub> = 8/20 μs <sup>(2)</sup>	I <sub>PP</sub> = 1 A, IO to GND or GND to IO			18.5	V
		I <sub>PP</sub> = 5 A, IO to GND or GND to IO			21	V
		I <sub>PP</sub> = 15 A, IO to GND or GND to IO			26	V
	TLP clamping voltage, t <sub>p</sub> = 100 ns	I <sub>PP</sub> = 16 A, IO to GND or GND to IO		19.4		V
R <sub>DYN</sub>	Dynamic resistance <sup>(3)</sup>	IO to GND		0.15		Ω
		GND to IO				
C <sub>L</sub>	Line capacitance	V <sub>IO</sub> = 0 V; f = 1 MHz, IO to GND		6.5	8	pF

(1) Typical parameters are measured at 25°C

(2) Nonrepetitive current pulse 8 to 20 μs exponentially decaying waveform according to IEC 61000-4-5

(3) Extraction of R<sub>DYN</sub> using least squares fit of TLP characteristics between I = 10 A and I = 20 A

## 5.8 Electrical Characteristics - TSD15C-Q1

At TA=25°C (unless otherwise noted) <sup>(1)</sup>

PARAMETER		TEST CONDITION	MIN	TYP	MAX	UNIT
V <sub>RWM</sub>	Reverse stand-off voltage	I <sub>IO</sub> < 10 nA, across operating temperature range			15	V
V <sub>BRR</sub>	Breakdown voltage	I <sub>IO</sub> = 10 mA, IO to GND and GND to IO	19	22	25	V
I <sub>LEAK</sub>	Reverse leakage current	V <sub>IO</sub> = 15 V, IO to GND or GND to IO		5	10	nA
V <sub>CLAMP</sub>	Surge clamping voltage, t <sub>p</sub> = 8/20 μs <sup>(2)</sup>	I <sub>PP</sub> = 1 A, IO to GND or GND to IO			25.6	V
		I <sub>PP</sub> = 5 A, IO to GND or GND to IO			28	V
		I <sub>PP</sub> = 12 A, IO to GND or GND to IO			33	V
	TLP clamping voltage, t <sub>p</sub> = 100 ns	I <sub>PP</sub> = 16 A, IO to GND or GND to IO		25		V
R <sub>DYN</sub>	Dynamic resistance <sup>(3)</sup>	IO to GND		0.2		Ω
		GND to IO				
C <sub>L</sub>	Line capacitance	V <sub>IO</sub> = 0 V; f = 1 MHz, IO to GND		6.7	9	pF

(1) Typical parameters are measured at 25°C

(2) Nonrepetitive current pulse 8 to 20 μs exponentially decaying waveform according to IEC 61000-4-5

(3) Extraction of R<sub>DYN</sub> using least squares fit of TLP characteristics between I = 10 A and I = 20 A

## 5.9 Electrical Characteristics - TSD18C-Q1

At TA=25°C (unless otherwise noted) <sup>(1)</sup>

PARAMETER		TEST CONDITION	MIN	TYP	MAX	UNIT
V <sub>RWM</sub>	Reverse stand-off voltage	I <sub>IO</sub> < 10 nA, across operating temperature range			18	V
V <sub>BRR</sub>	Breakdown voltage	I <sub>IO</sub> = 10 mA, IO to GND and GND to IO	19	22	25	V
I <sub>LEAK</sub>	Reverse leakage current	V <sub>IO</sub> = 18 V, IO to GND or GND to IO		5	10	nA
V <sub>CLAMP</sub>	Surge clamping voltage, t <sub>p</sub> = 8/20 μs <sup>(2)</sup>	I <sub>PP</sub> = 1 A, IO to GND or GND to IO			25.6	V
		I <sub>PP</sub> = 5 A, IO to GND or GND to IO			28	V
		I <sub>PP</sub> = 12 A, IO to GND or GND to IO			33	V
	TLP clamping voltage, t <sub>p</sub> = 100 ns	I <sub>PP</sub> = 16 A, IO to GND or GND to IO		25		V
R <sub>DYN</sub>	Dynamic resistance <sup>(3)</sup>	IO to GND		0.2		Ω
		GND to IO				
C <sub>L</sub>	Line capacitance	V <sub>IO</sub> = 0 V; f = 1 MHz, IO to GND		6.7	9	pF

(1) Typical parameters are measured at 25°C

(2) Nonrepetitive current pulse 8 to 20 μs exponentially decaying waveform according to IEC 61000-4-5

(3) Extraction of R<sub>DYN</sub> using least squares fit of TLP characteristics between I = 10 A and I = 20 A



## 5.10 Electrical Characteristics - TSD24C-Q1

At TA=25°C (unless otherwise noted) <sup>(1)</sup>

PARAMETER		TEST CONDITION	MIN	TYP	MAX	UNIT
V <sub>RWM</sub>	Reverse stand-off voltage	I <sub>IO</sub> < 10 nA, across operating temperature range			24	V
V <sub>BR</sub>	Breakdown voltage	I <sub>IO</sub> = 10 mA, IO to GND and GND to IO	25.5	30.5	35.5	V
I <sub>LEAK</sub>	Reverse leakage current	V <sub>IO</sub> = 24 V, IO to GND or GND to IO		5	10	nA
V <sub>CLAMP</sub>	Surge clamping voltage, t <sub>p</sub> = 8/20 μs <sup>(2)</sup>	I <sub>PP</sub> = 1 A, IO to GND or GND to IO			34	V
		I <sub>PP</sub> = 5 A, IO to GND or GND to IO			43	V
		I <sub>PP</sub> = 9 A, IO to GND or GND to IO			50	V
	TLP clamping voltage, t <sub>p</sub> = 100 ns	I <sub>PP</sub> = 16 A, IO to GND or GND to IO		36		V
R <sub>DYN</sub>	Dynamic resistance <sup>(3)</sup>	IO to GND		0.35		Ω
		GND to IO				
C <sub>L</sub>	Line capacitance	V <sub>IO</sub> = 0 V; f = 1 MHz, IO to GND		4.3	6	pF

(1) Typical parameters are measured at 25°C

(2) Nonrepetitive current pulse 8 to 20 μs exponentially decaying waveform according to IEC 61000-4-5

(3) Extraction of R<sub>DYN</sub> using least squares fit of TLP characteristics between I = 10 A and I = 20 A

## 5.11 Electrical Characteristics - TSD36C-Q1

At TA=25°C (unless otherwise noted) <sup>(1)</sup>

PARAMETER		TEST CONDITION	MIN	TYP	MAX	UNIT
V <sub>RWM</sub>	Reverse stand-off voltage	I <sub>IO</sub> < 50 nA, across operating temperature range			36	V
V <sub>BR</sub>	Breakdown voltage	I <sub>IO</sub> = 10 mA, I/O to GND and GND to I/O	37.8	41.2	44.2	V
I <sub>LEAK</sub>	Reverse leakage current	V <sub>IO</sub> = 36 V, IO to GND or GND to IO		5	10	nA
V <sub>CLAMP</sub>	Surge clamping voltage, t <sub>p</sub> = 8/20 μs <sup>(2)</sup>	I <sub>PP</sub> = 1 A, IO to GND or GND to IO			47	V
		I <sub>PP</sub> = 5 A, IO to GND or GND to IO			64	V
		I <sub>PP</sub> = 6.5 A, IO to GND or GND to IO			71	V
	TLP clamping voltage, t <sub>p</sub> = 100 ns	I <sub>PP</sub> = 16 A, IO to GND or GND to IO		56		V
R <sub>DYN</sub>	Dynamic resistance <sup>(3)</sup>	IO to GND		0.6		Ω
		GND to IO				
C <sub>L</sub>	Line capacitance	V <sub>IO</sub> = 0 V; f = 1 MHz, IO to GND		4.3	6	pF

(1) Typical parameters are measured at 25°C

(2) Nonrepetitive current pulse 8 to 20 μs exponentially decaying waveform according to IEC 61000-4-5

(3) Extraction of RDYN using least squares fit of TLP characteristics between I = 10 A and I = 20 A

## 5.12 Typical Characteristics

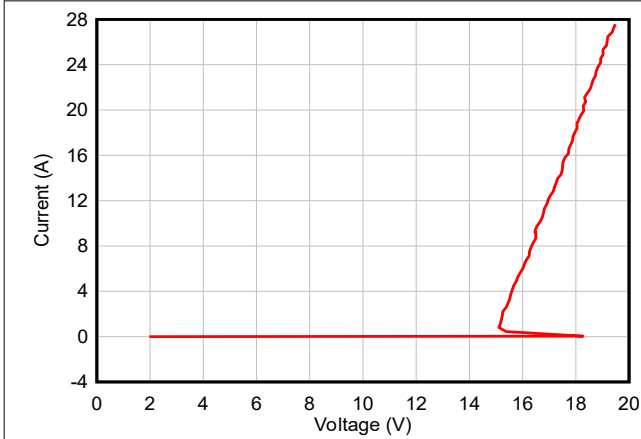

Figure 5-1. Positive TLP Curve - TSD12C-Q1

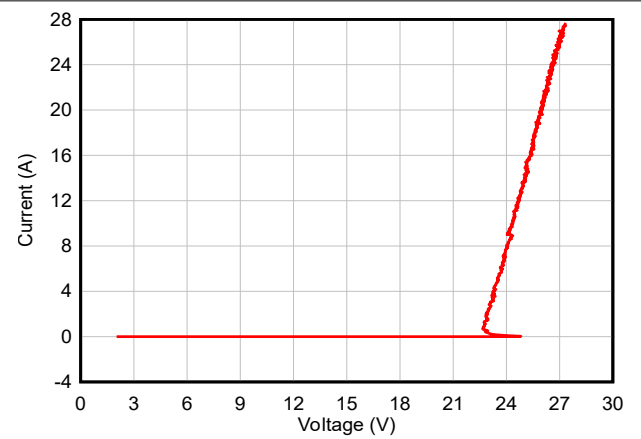

Figure 5-2. Positive TLP Curve - TSD15C-Q1

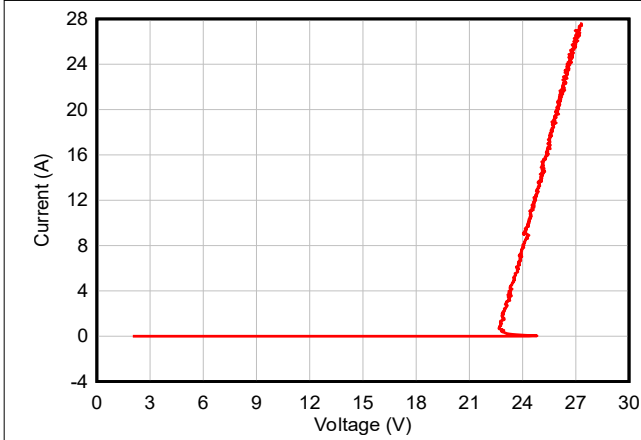

Figure 5-3. Positive TLP Curve - TSD18C-Q1

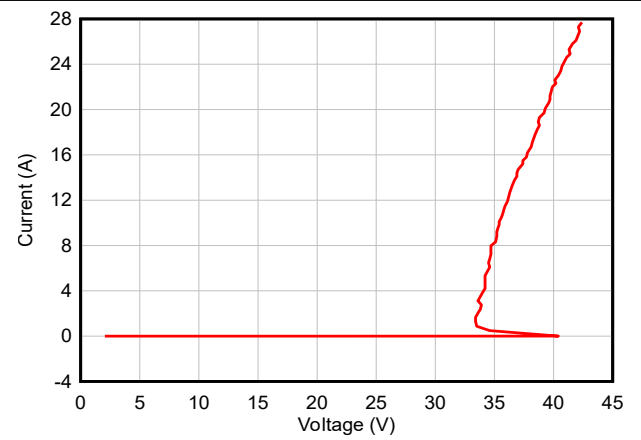

Figure 5-4. Positive TLP Curve - TSD24C-Q1

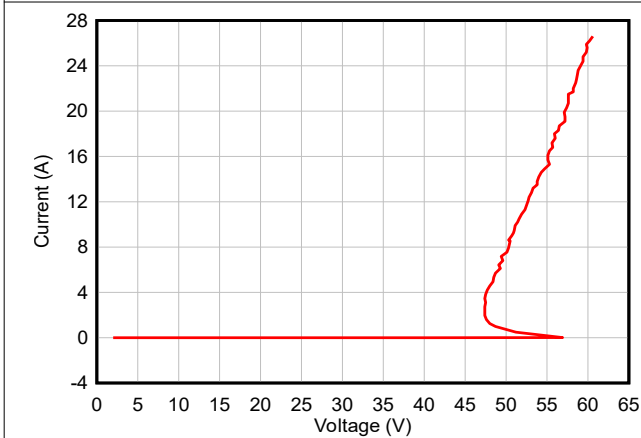

Figure 5-5. Positive TLP Curve - TSD36C-Q1

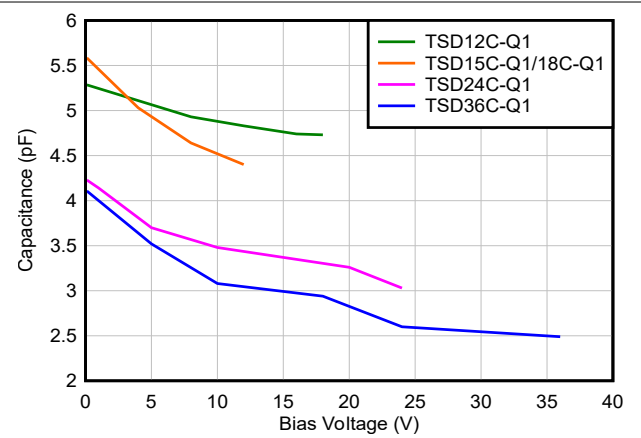
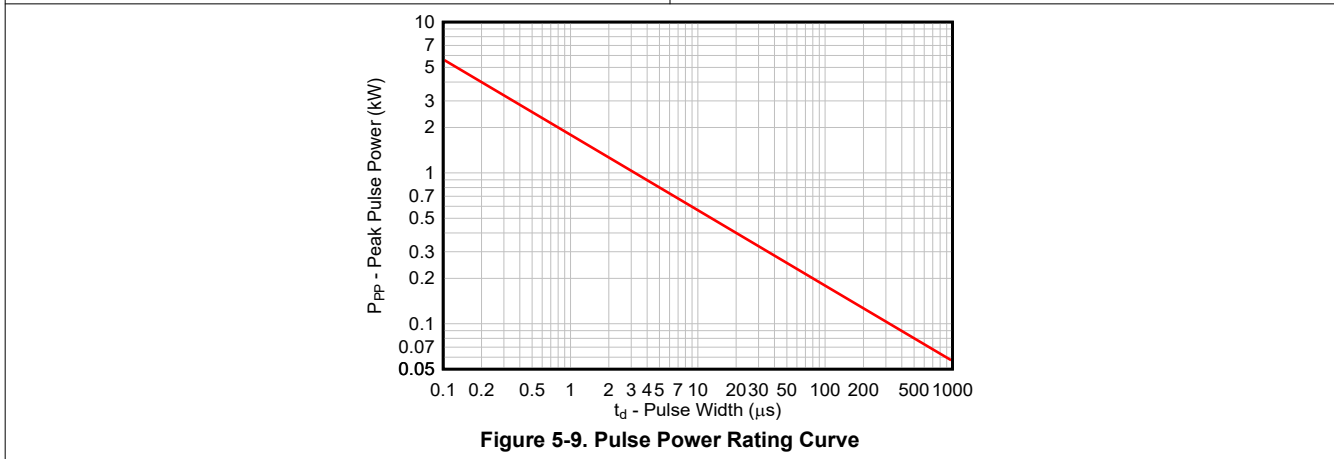
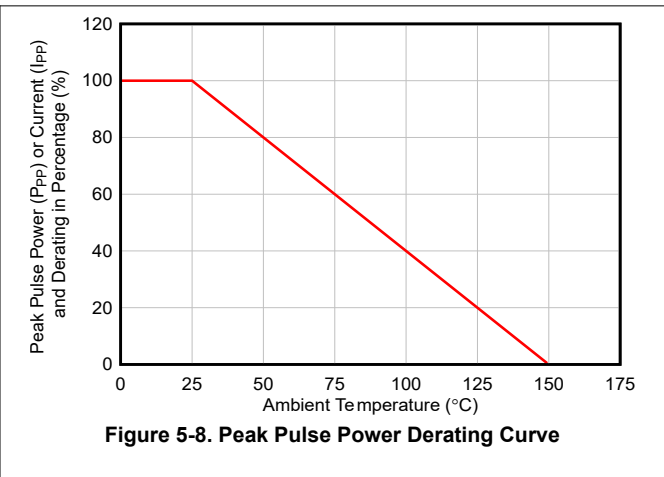
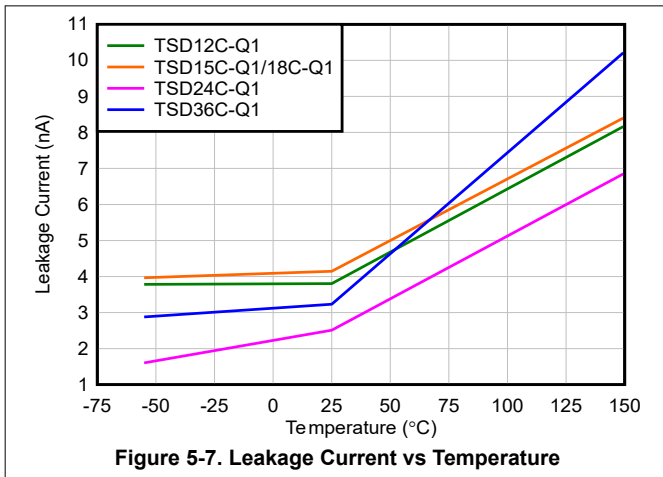

Figure 5-6. Capacitance vs Bias Voltage

## 5.12 Typical Characteristics (continued)



## 6 Application and Implementation

---

### Note

Information in the following applications sections is not part of the TI component specification, and TI does not warrant its accuracy or completeness. TI's customers are responsible for determining suitability of components for their purposes, as well as validating and testing their design implementation to confirm system functionality.

---

## 7 Application Information

The TSDxxC-Q1 are TVS diodes that provide a path to ground for dissipating transient voltage spikes (such as ESD or surge) on signal lines and power lines. Connect the device in parallel to the down stream circuitry for protection. As the current from the transient passes through the TVS, only a small voltage drop is present across the diode. The small voltage drop is presented to the protected IC. The low  $R_{DYN}$  of the triggered TVS holds this voltage ( $V_{CLAMP}$ ) to a safe level for the protected IC. For more information on how to properly use this device, refer to the [ESD Packaging and Layout Guide](#).

## 8 Device and Documentation Support

### 8.1 Documentation Support

#### 8.1.1 Related Documentation

For related documentation, see the following:

- Texas Instruments, [ESD Packaging and Layout Guide application report](#)
- Texas Instruments, [ESD Layout Guide application report](#)
- Texas Instruments, [Generic ESD Evaluation Module user's guide](#)
- Texas Instruments, [Reading and Understanding an ESD Protection Data Sheet user's guide](#)

### 8.2 Receiving Notification of Documentation Updates

To receive notification of documentation updates, navigate to the device product folder on [ti.com](#). Click on *Notifications* to register and receive a weekly digest of any product information that has changed. For change details, review the revision history included in any revised document.

### 8.3 Support Resources

[TI E2E™ support forums](#) are an engineer's go-to source for fast, verified answers and design help — straight from the experts. Search existing answers or ask your own question to get the quick design help you need.

Linked content is provided "AS IS" by the respective contributors. They do not constitute TI specifications and do not necessarily reflect TI's views; see TI's [Terms of Use](#).

### 8.4 Trademarks

TI E2E™ is a trademark of Texas Instruments.  
All trademarks are the property of their respective owners.

### 8.5 Electrostatic Discharge Caution



This integrated circuit can be damaged by ESD. Texas Instruments recommends that all integrated circuits be handled with appropriate precautions. Failure to observe proper handling and installation procedures can cause damage.

ESD damage can range from subtle performance degradation to complete device failure. Precision integrated circuits may be more susceptible to damage because very small parametric changes could cause the device not to meet its published specifications.

### 8.6 Glossary

[TI Glossary](#) This glossary lists and explains terms, acronyms, and definitions.

## 9 Revision History

DATE	REVISION	NOTES
October 2024	*	Initial Release

## 10 Mechanical, Packaging, and Orderable Information

The following pages include mechanical, packaging, and orderable information. This information is the most current data available for the designated devices. This data is subject to change without notice and revision of this document. For browser-based versions of this data sheet, refer to the left-hand navigation

**PACKAGING INFORMATION**

Orderable Device	Status (1)	Package Type	Package Drawing	Pins	Package Qty	Eco Plan (2)	Lead finish/ Ball material (6)	MSL Peak Temp (3)	Op Temp (°C)	Device Marking (4/5)	Samples
TSD12CDYFRQ1	ACTIVE	SOT	DYF	2	3000	RoHS & Green	SN	Level-3-260C-168 HR	-55 to 150	3JNF	<a href="#">Samples</a>
TSD15CDYFRQ1	ACTIVE	SOT	DYF	2	3000	RoHS & Green	SN	Level-3-260C-168 HR	-55 to 150	3MMF	<a href="#">Samples</a>
TSD18CDYFRQ1	ACTIVE	SOT	DYF	2	3000	RoHS & Green	SN	Level-3-260C-168 HR	-55 to 150	3JPF	<a href="#">Samples</a>
TSD24CDYFRQ1	ACTIVE	SOT	DYF	2	3000	RoHS & Green	SN	Level-3-260C-168 HR	-55 to 150	3GZF	<a href="#">Samples</a>

(1) The marketing status values are defined as follows:

**ACTIVE:** Product device recommended for new designs.

**LIFEBUY:** TI has announced that the device will be discontinued, and a lifetime-buy period is in effect.

**NRND:** Not recommended for new designs. Device is in production to support existing customers, but TI does not recommend using this part in a new design.

**PREVIEW:** Device has been announced but is not in production. Samples may or may not be available.

**OBSOLETE:** TI has discontinued the production of the device.

(2) **RoHS:** TI defines "RoHS" to mean semiconductor products that are compliant with the current EU RoHS requirements for all 10 RoHS substances, including the requirement that RoHS substance do not exceed 0.1% by weight in homogeneous materials. Where designed to be soldered at high temperatures, "RoHS" products are suitable for use in specified lead-free processes. TI may reference these types of products as "Pb-Free".

**RoHS Exempt:** TI defines "RoHS Exempt" to mean products that contain lead but are compliant with EU RoHS pursuant to a specific EU RoHS exemption.

**Green:** TI defines "Green" to mean the content of Chlorine (Cl) and Bromine (Br) based flame retardants meet JS709B low halogen requirements of <=1000ppm threshold. Antimony trioxide based flame retardants must also meet the <=1000ppm threshold requirement.

(3) MSL, Peak Temp. - The Moisture Sensitivity Level rating according to the JEDEC industry standard classifications, and peak solder temperature.

(4) There may be additional marking, which relates to the logo, the lot trace code information, or the environmental category on the device.

(5) Multiple Device Markings will be inside parentheses. Only one Device Marking contained in parentheses and separated by a "-" will appear on a device. If a line is indented then it is a continuation of the previous line and the two combined represent the entire Device Marking for that device.

(6) Lead finish/Ball material - Orderable Devices may have multiple material finish options. Finish options are separated by a vertical ruled line. Lead finish/Ball material values may wrap to two lines if the finish value exceeds the maximum column width.

**Important Information and Disclaimer:**The information provided on this page represents TI's knowledge and belief as of the date that it is provided. TI bases its knowledge and belief on information provided by third parties, and makes no representation or warranty as to the accuracy of such information. Efforts are underway to better integrate information from third parties. TI has taken and



continues to take reasonable steps to provide representative and accurate information but may not have conducted destructive testing or chemical analysis on incoming materials and chemicals. TI and TI suppliers consider certain information to be proprietary, and thus CAS numbers and other limited information may not be available for release.

In no event shall TI's liability arising out of such information exceed the total purchase price of the TI part(s) at issue in this document sold by TI to Customer on an annual basis.

**OTHER QUALIFIED VERSIONS OF TSD12C-Q1, TSD15C-Q1, TSD18C-Q1, TSD24C-Q1 :**

- Catalog : [TSD12C](#), [TSD15C](#), [TSD18C](#), [TSD24C](#)

NOTE: Qualified Version Definitions:

- Catalog - TI's standard catalog product

**TAPE AND REEL INFORMATION**

**QUADRANT ASSIGNMENTS FOR PIN 1 ORIENTATION IN TAPE**

\*All dimensions are nominal

Device	Package Type	Package Drawing	Pins	SPQ	Reel Diameter (mm)	Reel Width W1 (mm)	A0 (mm)	B0 (mm)	K0 (mm)	P1 (mm)	W (mm)	Pin1 Quadrant
TSD12CDYFRQ1	SOT	DYF	2	3000	178.0	9.5	1.48	3.3	1.25	4.0	8.0	Q1
TSD15CDYFRQ1	SOT	DYF	2	3000	178.0	9.5	1.48	3.3	1.25	4.0	8.0	Q1
TSD18CDYFRQ1	SOT	DYF	2	3000	178.0	9.5	1.48	3.3	1.25	4.0	8.0	Q1
TSD24CDYFRQ1	SOT	DYF	2	3000	178.0	9.5	1.48	3.3	1.25	4.0	8.0	Q1

**TAPE AND REEL BOX DIMENSIONS**

\*All dimensions are nominal

Device	Package Type	Package Drawing	Pins	SPQ	Length (mm)	Width (mm)	Height (mm)
TSD12CDYFRQ1	SOT	DYF	2	3000	210.0	200.0	42.0
TSD15CDYFRQ1	SOT	DYF	2	3000	210.0	200.0	42.0
TSD18CDYFRQ1	SOT	DYF	2	3000	210.0	200.0	42.0
TSD24CDYFRQ1	SOT	DYF	2	3000	210.0	200.0	42.0

DYF0002A



# PACKAGE OUTLINE

SOT(SOD-323) - 1 mm max height

SMALL OUTLINE TRANSISTOR

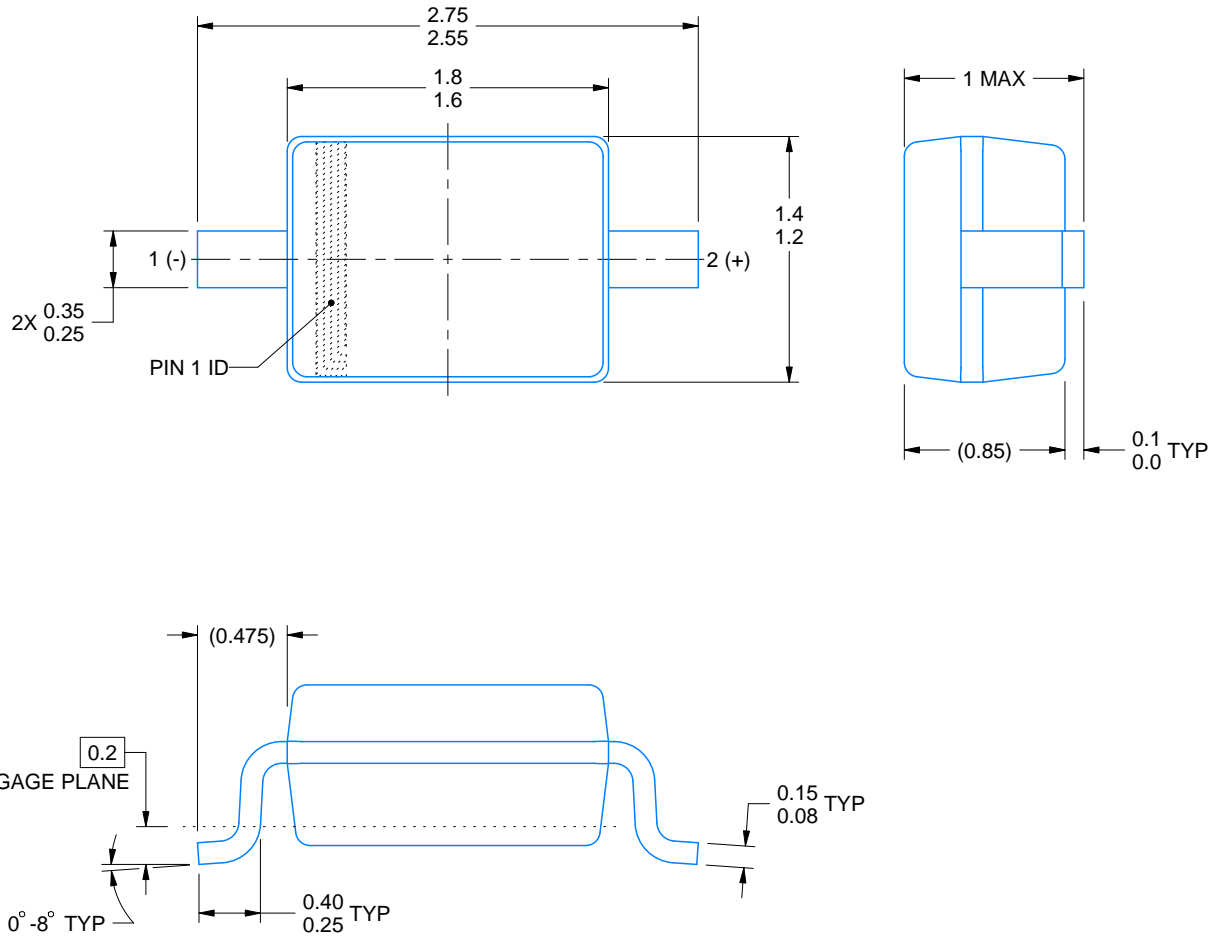

4228484/A 02/2022

NOTES:

1. All linear dimensions are in millimeters. Any dimensions in parenthesis are for reference only. Dimensioning and tolerancing per ASME Y14.5M.
2. This drawing is subject to change without notice.

# EXAMPLE BOARD LAYOUT

DYF0002A

SOT(SOD-323) - 1 mm max height

SMALL OUTLINE TRANSISTOR

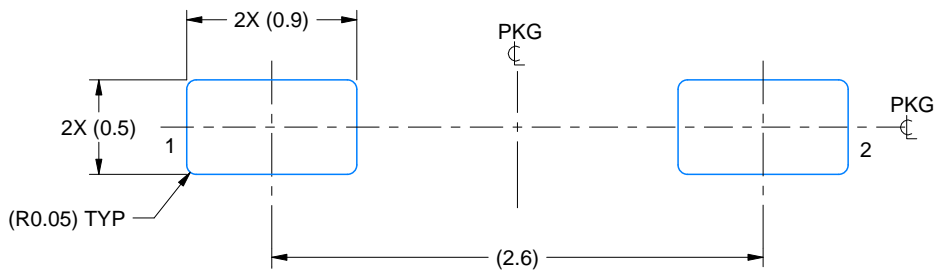

LAND PATTERN EXAMPLE  
EXPOSED METAL SHOWN  
SCALE:25X

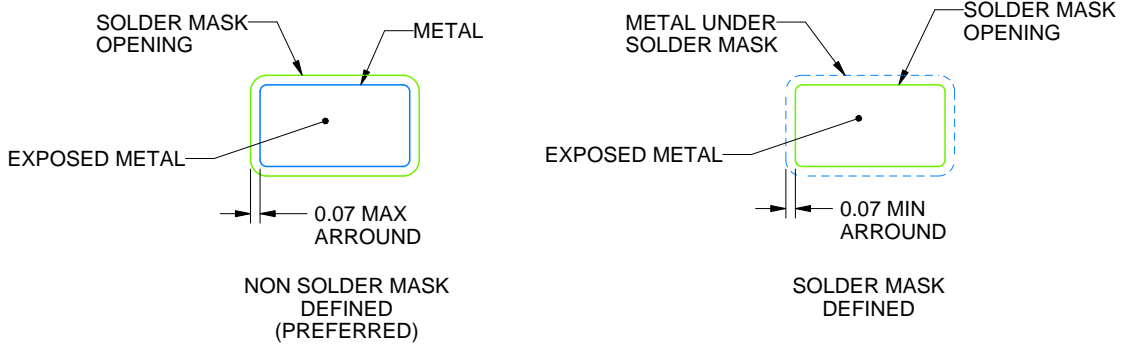

SOLDER MASK DETAILS

4228484/A 02/2022

NOTES: (continued)

- 3. Publication IPC-7351 may have alternate designs.
- 4. Solder mask tolerances between and around signal pads can vary based on board fabrication site.

# EXAMPLE STENCIL DESIGN

DYF0002A

SOT(SOD-323) - 1 mm max height

SMALL OUTLINE TRANSISTOR

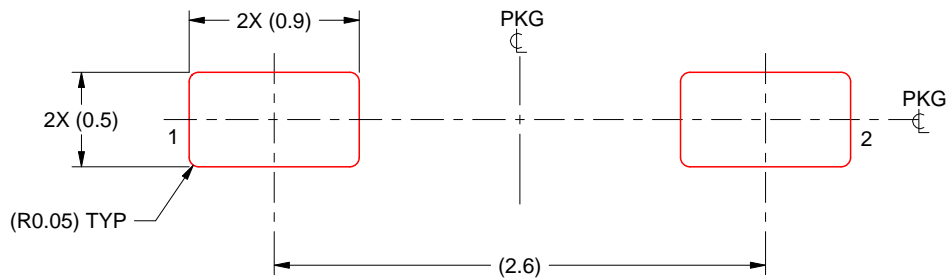

SOLDER PASTE EXAMPLE  
BASED ON 0.125 mm THICK STENCIL  
SCALE:25X

4228484/A 02/2022

NOTES: (continued)

5. Laser cutting apertures with trapezoidal walls and rounded corners may offer better paste release. IPC-7525 may have alternate design recommendations.
6. Board assembly site may have different recommendations for stencil design.

## IMPORTANT NOTICE AND DISCLAIMER

TI PROVIDES TECHNICAL AND RELIABILITY DATA (INCLUDING DATA SHEETS), DESIGN RESOURCES (INCLUDING REFERENCE DESIGNS), APPLICATION OR OTHER DESIGN ADVICE, WEB TOOLS, SAFETY INFORMATION, AND OTHER RESOURCES "AS IS" AND WITH ALL FAULTS, AND DISCLAIMS ALL WARRANTIES, EXPRESS AND IMPLIED, INCLUDING WITHOUT LIMITATION ANY IMPLIED WARRANTIES OF MERCHANTABILITY, FITNESS FOR A PARTICULAR PURPOSE OR NON-INFRINGEMENT OF THIRD PARTY INTELLECTUAL PROPERTY RIGHTS.

These resources are intended for skilled developers designing with TI products. You are solely responsible for (1) selecting the appropriate TI products for your application, (2) designing, validating and testing your application, and (3) ensuring your application meets applicable standards, and any other safety, security, regulatory or other requirements.

These resources are subject to change without notice. TI grants you permission to use these resources only for development of an application that uses the TI products described in the resource. Other reproduction and display of these resources is prohibited. No license is granted to any other TI intellectual property right or to any third party intellectual property right. TI disclaims responsibility for, and you will fully indemnify TI and its representatives against, any claims, damages, costs, losses, and liabilities arising out of your use of these resources.

TI's products are provided subject to [TI's Terms of Sale](#) or other applicable terms available either on [ti.com](https://www.ti.com) or provided in conjunction with such TI products. TI's provision of these resources does not expand or otherwise alter TI's applicable warranties or warranty disclaimers for TI products.

TI objects to and rejects any additional or different terms you may have proposed.

Mailing Address: Texas Instruments, Post Office Box 655303, Dallas, Texas 75265  
Copyright © 2024, Texas Instruments Incorporated