

# TUSB217A USB 2.0 High-Speed シグナル・コンディショナ、DCP および CDP コントローラ付き

## 1 特長

- 広い電源電圧範囲: 2.3~6.5V
- USB 切断時およびシャットダウン時の非常に低い消費電力
- USB 2.0 High Speed 信号のコンディショニング
- USB 2.0、OTG 2.0、BC 1.2 に対応
- Low-Speed、Full-Speed、High-Speed 信号処理のサポート
- BC 1.2 充電ダウンストリーム・ポート (CDP) および専用充電ポート (DCP) コントローラを内蔵、DCP/CDP ピンにより動的に変更可能
- 特定のホストやデバイスに非依存
- 最大 5m のケーブルをサポート
  - 外付けのプルダウン抵抗により 4 つの信号ブースト (エッジ・ブーストと DC ブースト) 設定を選択可能
  - プルアップまたはプルダウンで選択可能な 3 つの RX イコライズ設定により、損失が大きいアプリケーションの ISI ジッタを補償
- 2 つの TUSB217A デバイスを使って最大 10m のケーブル長に対応
- スケーラブルなソリューション - 損失が大きいアプリケーションに対応するため、デバイスをデジタイズ・チェーン接続可能
- RWB は TUSB211/212/214/216 とピン互換

## 2 アプリケーション

- ラップトップ、デスクトップまたはドッキング・ステーション
- ポータブル・エレクトロニクス
- タブレット
- 携帯電話
- テレビ
- アクティブ・ケーブル、延長ケーブル、バックプレーン

## 3 概要

TUSB217A は第 3 世代 USB 2.0 High Speed 信号コンディショナーで、伝送チャネルでの AC 損失 (容量性負荷による) および DC 損失 (抵抗損失による) を補償するように設計されています。

TUSB217A には、エッジ・ブースタにより USB 2.0 High Speed 信号の遷移エッジを高速化し、DC ブースト機能により静的電圧レベルを上げる特許取得済みの設計が採用されています。また、TUSB217A はプリイコライゼーション機能を備えているため、レシーバ感度を高め、長いケーブルを使用するアプリケーションで ISI (符号間干渉) ジッタを補償できます。USB Low Speed および Full Speed 信号特性は、TUSB217A による影響を受けません。

TUSB217A は、パケット・タイミングを変更せず、また、伝搬遅延やレイテンシを追加せずに、信号品質を向上させることができます。

TUSB217A により、最長 5 メートルのケーブルを使用したシステムで、USB 2.0 High Speed 近端アイ・コンプライアンスに合格することが可能になります。

TUSB217A は USB On-The-Go (OTG) および Battery Charging (BC 1.2) プロトコルにも対応しています。内蔵の BC 1.2 バッテリ充電コントローラは、制御ピンを使って有効化できます。

### 製品情報<sup>(1)</sup>

部品番号	パッケージ	動作温度 (T <sub>A</sub> ) °C	本体サイズ (公称)
TUSB217A	X2QFN (12RWB)	0~70	1.60mm × 1.60mm
TUSB217AI	X2QFN (12RWB)	-40~85	1.60mm × 1.60mm

(1) 利用可能なすべてのパッケージについては、このデータシートの末尾にある注文情報を参照してください。

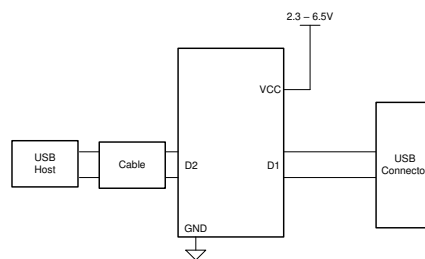

概略回路図



## Table of Contents

<b>1 特長</b> .....	1	8.4 Device Functional Modes.....	10
<b>2 アプリケーション</b> .....	1	8.5 TUSB217A Registers.....	12
<b>3 概要</b> .....	1	<b>9 Application and Implementation</b> .....	15
<b>4 Revision History</b> .....	2	9.1 Application Information.....	15
<b>5 Device Comparison</b> .....	3	9.2 Typical Application.....	15
<b>6 Pin Configuration and Functions</b> .....	4	<b>10 Power Supply Recommendations</b> .....	24
<b>7 Specifications</b> .....	6	<b>11 Layout</b> .....	24
7.1 Absolute Maximum Ratings .....	6	11.1 Layout Guidelines.....	24
7.2 ESD Ratings .....	6	11.2 Layout Example.....	24
7.3 Recommended Operating Conditions .....	6	<b>12 Device and Documentation Support</b> .....	25
7.4 Thermal Information .....	6	12.1 Receiving Notification of Documentation Updates..	25
7.5 Electrical Characteristics .....	7	12.2 サポート・リソース.....	25
7.6 Switching Characteristics .....	8	12.3 Trademarks.....	25
7.7 Timing Requirements .....	9	12.4 Electrostatic Discharge Caution.....	25
<b>8 Detailed Description</b> .....	10	12.5 Glossary.....	25
8.1 Overview.....	10	<b>13 Mechanical, Packaging, and Orderable Information</b> .....	25
8.2 Functional Block Diagram.....	10		
8.3 Feature Description.....	10		

## 4 Revision History

DATE	REVISION	NOTES
June 2021	*	Initial Release

## 5 Device Comparison

	TUSB211	TUSB212	TUSB214	TUSB216I	TUSB217A
Supply (V)	3.3	3.3	3.3	2.3 to 6.5	2.3 to 6.5
DC Boost		3 levels	3 levels	Tandem with AC Boost	Tandem with AC Boost
RX pre-equalization for ISI compensation				3 levels	3 levels
Charging Downstream Port (CDP) controller			Always ON	Pin Controlled	Always ON. Dynamically selected by DCP/CDP pin
Dedicated Charging Port (DCP) controller					Always ON. Dynamically selected by DCP/CDP pin
Cable length compensation for near-end high-speed eye mask Compliance (pre-channel before redriver/post-channel after redriver) (meter - gauge)	2/1 - 28AWG	4/2 - 28AWG	4/2 - 28AWG	6/3 - 28AWG (10 - 24AWG with one redriver on each end)	6/3 - 28AWG (10 - 24AWG with one redriver on each end)
Cable length compensation for far-end high-speed eye mask Compliance (pre-channel before redriver/post-channel after redriver) (meter - gauge)	5/3 - 28AWG	8/6 - 28AWG	8/6 - 28AWG	10/8 - 26AWG (10 - 28AWG with one redriver on each end)	10/8 - 26AWG (10 - 28AWG with one redriver on each end)

## 6 Pin Configuration and Functions



图 6-1. TUSB217A RWB 12-Pin X2QFN Top View

表 6-1. Pin Functions

PIN (RWB)		I/O	INTERNAL PULLUP/PULLDOWN	DESCRIPTION
NAME	NO. (RWB)			
BOOST	6	I	N/A	USB High-speed boost select through the external pull down resistor. Both edge boost and DC boost are controlled by a single pin in non-I2C mode. In I2C mode edge boost and DC boost can be individually controlled. Sampled upon power up. Does not recognize real time adjustments. Auto selects BOOST LEVEL = 3 when left floating.
DCP/CDP	11	I	500 kΩ PU	DCP or CDP mode selection. Low=DCP and High=CDP TUSB217ARWB BC1.2 controller is always enabled.
RX_SEN <sup>(2)</sup> /ENA_HS	9	I/O	N/A	In I2C mode: Reserved for TI test purpose. In non-I2C mode: At reset: 3-level input signal RX_SEN. USB High-speed RX Equalization Setting to Compensate ISI Jitter H (pin is pulled high) – high RX equalization (high loss channel) M (pin is left floating) – medium RX equalization (medium loss channel) L (pin is pulled low) – low RX equalization (low loss channel) After reset: Output signal ENA_HS. Flag indicating that channel is in High-speed mode. Asserted upon: 1. Detection of USB-IF High-speed test fixture from an unconnected state followed by transmission of USB TEST_PACKET pattern. 2. Squelch detection following USB reset with a successful HS handshake [HS handshake is declared to be successful after single chirp J chirp K pair where each chirp is within 18 μs – 128 μs].
D2P	7	I/O	N/A	USB High-speed positive port.
D2M	8	I/O	N/A	USB High-speed negative port.
GND	10	P	N/A	Ground
D1M	1	I/O	N/A	USB High-speed negative port..
D1P	2	I/O	N/A	USB High-speed positive port.
SDA <sup>(1)</sup>	3	I/O	500 kΩ PU 1.8 MΩ PD	I2C Mode: Bidirectional I2C data pin [7-bit I2C slave address = 0x2C]. In non I2C mode: Reserved for TI test purpose.
VCC	12	P	N/A	Supply power

**表 6-1. Pin Functions (continued)**

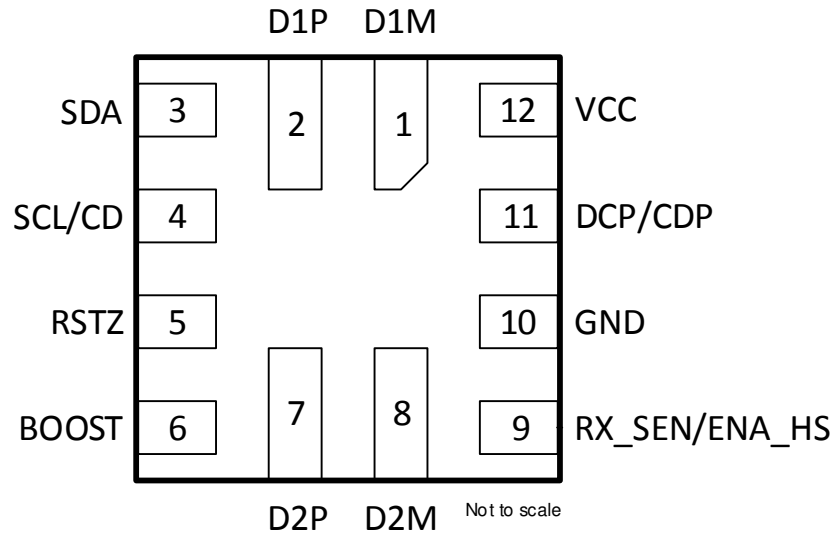
PIN (RWB)		I/O	INTERNAL PULLUP/PULLDOWN	DESCRIPTION
NAME	NO. (RWB)			
RSTN	5	I	500 kΩ PU 1.8 MΩ PD	Device disable/enable. Low – Device is at reset and in shutdown, and High - Normal operation. Recommend 0.1-μF external capacitor to GND to ensure clean power on reset if not driven. If the pin is driven, it must be held low until the supply voltage for the device reaches within specifications.
SCL <sup>(1)</sup> /CD	4	I/O	When RSTN asserted there is a 500 kΩ PD	In I2C mode: I2C clock pin [I2C address = 0x2C]. Non I2C mode: After reset: Output CD. Flag indicating that a USB device is attached (connection detected). Asserted from an unconnected state upon detection of DP or DM pull-up resistor. De-asserted upon detection of disconnect.

- (1) Pull-up resistors for SDA and SCL pins in I<sup>2</sup>C mode should be R<sub>Pull-up</sub> (depending on I2C bus voltage). If both SDA and SCL are pulled up at power-up the device enters into I<sup>2</sup>C mode.
- (2) Pull-down and pull-up resistors for RX\_SEN pin must follow R<sub>RXSEN1</sub> and R<sub>RXSEN2</sub> resistor recommendations in non I<sup>2</sup>C mode.

## 7 Specifications

### 7.1 Absolute Maximum Ratings

Over operating free-air temperature range (unless otherwise noted) <sup>(1)</sup>

		MIN	MAX	UNIT
Supply voltage range	VCC	-0.3	7	V
Voltage range USB data	DxP, DxM	-0.3	5.5	V
Voltage range on BOOST pin	BOOST	-0.3	1.98	V
Voltage range other pins	RX_SEN, DCP/CDP, SDA, SCL, RSTN	-0.3	5.5	V
Storage temperature, T <sub>stg</sub>		-65	150	°C
Maximum junction temperature, T <sub>J(max)</sub>			125	°C

- (1) Operation outside the Absolute Maximum Ratings may cause permanent device damage. Absolute Maximum Ratings do not imply functional operation of the device at these or any other conditions beyond those listed under Recommended Operating Conditions. If used outside the Recommended Operating Conditions but within the Absolute Maximum Ratings, the device may not be fully functional, and this may affect device reliability, functionality, performance, and shorten the device lifetime.

### 7.2 ESD Ratings

		VALUE	UNIT
V <sub>(ESD)</sub>	Electrostatic discharge	Human-body model (HBM), per ANSI/ESDA/JEDEC JS-001 <sup>(1)</sup>	V
		Charged-device model (CDM), per ANSI/ESDA/JEDEC JS-002 <sup>(2)</sup>	

- (1) JEDEC document JEP155 states that 500-V HBM allows safe manufacturing with a standard ESD control process.  
 (2) JEDEC document JEP157 states that 250-V CDM allows safe manufacturing with a standard ESD control process.

### 7.3 Recommended Operating Conditions

over operating free-air temperature range (unless otherwise noted)

		MIN	NOM	MAX	UNIT
V <sub>CC</sub>	Supply voltage	2.3	5	6.5	V
T <sub>A</sub>	Operating free-air temperature (Standard)	0		70	°C
T <sub>A</sub>	Operating free-air temperature (Industrial)	-40		85	°C
T <sub>J</sub>	Junction temperature (Standard)			85	°C
T <sub>J</sub>	Junction temperature (Industrial)			105	°C
V <sub>I2C_BUS</sub>	I2C Bus Voltage	1.62		3.6	V
DxP, DxM	Voltage range USB data	0		3.6	V
BOOST	Voltage range BOOST pin	0		1.98	V
DIGITAL	Voltage range other pins (SCL, SDA, RSTN, DCP/CDP)	0		3.6	V
RX_SEN	Voltage range RX_SEN pin	0		5.0	V

### 7.4 Thermal Information

THERMAL METRIC <sup>(1)</sup>		RWB (X2QFN)	UNIT
		12 PINS	
R <sub>θJA</sub>	Junction-to-ambient thermal resistance	137.4	°C/W
R <sub>θJC(top)</sub>	Junction-to-case (top) thermal resistance	62	°C/W
R <sub>θJB</sub>	Junction-to-board thermal resistance	67.2	°C/W
ψ <sub>JT</sub>	Junction-to-top characterization parameter	1.9	°C/W
ψ <sub>JB</sub>	Junction-to-board characterization parameter	67.3	°C/W
R <sub>θJC(bot)</sub>	Junction-to-case (bottom) thermal resistance	N/A	°C/W

- (1) For more information about traditional and new thermal metrics, see the *Semiconductor and IC Package Thermal Metrics* application report, [SPRA953](#).

## 7.5 Electrical Characteristics

Over operating free-air temperature range (unless otherwise noted)

PARAMETER		TEST CONDITIONS	MIN	TYP <sup>(1)</sup>	MAX	UNIT
<b>POWER</b>						
$I_{ACTIVE\_HS}$	High Speed Active Current	USB channel = HS mode. 480 Mbps traffic. $V_{CC}$ supply stable, with Boost = Max		22	36	mA
$I_{IDLE\_HS}$	High Speed Idle Current	USB channel = HS mode, no traffic. $V_{CC}$ supply stable, Boost = Max		22	36	mA
$I_{HS\_SUSPEND}$	High Speed Suspend Current	USB channel = HS Suspend mode. $V_{CC}$ supply stable		0.75	1.4	mA
$I_{FS}$	Full-Speed Current	USB channel = FS mode, 12 Mbps traffic, $V_{CC}$ supply stable		0.75	1.4	mA
$I_{DISCONN}$	Disconnect Power	Host side application. No device attachment.		0.80	1.4	mA
$I_{SHUTDOWN}$	Shutdown Power	RSTN driven low, $V_{CC}$ supply stable		60	115	$\mu$ A
<b>CONTROL PIN LEAKAGE</b>						
$I_{LKG\_FS}$	Pin failsafe leakage current for SDA, RSTN	$V_{CC} = 0$ V, pin at $V_{IH, max}$		10	15	$\mu$ A
$I_{LKG\_FS}$	Pin failsafe leakage current for RX_SEN	$V_{CC} = 0$ V, pin at $V_{IH, max}$		6	15	$\mu$ A
$I_{LKG\_FS}$	Pin failsafe leakage current for SCL	$V_{CC} = 0$ V, pin at $V_{IH, max}$			70	nA
<b>INPUT RSTN</b>						
$V_{IH}$	High level input voltage		1.5		3.6	V
$V_{IL}$	Low-level input voltage		0		0.5	V
$I_{IH}$	High level input current	$V_{IH} = 3.6$ V, $R_{PU}$ enabled			$\pm 15$	$\mu$ A
$I_{IL}$	Low level input current	$V_{IL} = 0$ V, $R_{PU}$ enabled			$\pm 20$	$\mu$ A
<b>INPUT DIGITAL</b>						
$V_{IH}$	High level input voltage (DCP/CDP)		1.5		3.6	V
$V_{IL}$	Low-level input voltage (DCP/CDP)		0		0.5	V
$I_{IL}$	Low level input current	$V_{IL} = 0$ V			$\pm 20$	$\mu$ A
$I_{IH}$	High level input current	$V_{IH} = 3.6$ V			$\pm 15$	$\mu$ A
<b>INPUT RX_SEN (3-level input, for mid level leave pin floating)</b>						
$V_{IH(Max)}$	Maximum High level input voltage	$V_{CC} = 2.3$ V to 6.5 V			5.0	V
$V_{IH(Min)}$	Minimum High level input voltage	$V_{CC} > 4.5$ V	3.3			V
		$V_{CC} = 2.3$ V to 4.5 V (% of $V_{CC}$ )	75			%
$V_{IL}$	Low level input voltage	$V_{CC} > 4.5$ V			0.75	V
		$V_{CC} = 2.3$ V to 4.5 V (% of $V_{CC}$ )			15	%
<b>INPUT BOOST</b>						
$R_{BOOST\_LVL0}$	External pulldown resistor for BOOST Level 0				160	$\Omega$
$R_{BOOST\_LVL1}$	External pulldown resistor for BOOST Level 1		1.5	1.8	2	k $\Omega$
$R_{BOOST\_LVL2}$	External pulldown resistor for BOOST Level 2		3.4	3.6	3.96	k $\Omega$
$R_{BOOST\_LVL3}$	External pulldown resistor for BOOST Level 3 to remove upper limit for resistor value, can be left open		7.5			k $\Omega$
<b>OUTPUTS CD, ENA_HS</b>						
$V_{OH}$	High level output voltage for CD and ENA_HS	$I_O = -50$ $\mu$ A, $V_{CC} \geq 3.0$ V	2.5			V
$V_{OH}$	High level output voltage for CD	$I_O = -25$ $\mu$ A, $V_{CC} = 2.3$ V	1.7			V

## 7.5 Electrical Characteristics (continued)

Over operating free-air temperature range (unless otherwise noted)

PARAMETER		TEST CONDITIONS	MIN	TYP <sup>(1)</sup>	MAX	UNIT
V <sub>OH</sub>	High level output voltage for ENA_HS	I <sub>O</sub> = -25 μA, V <sub>CC</sub> = 2.3V	1.8			V
V <sub>OL</sub>	Low level output voltage for CD and ENA_HS	I <sub>O</sub> = 50 μA			0.3	V
<b>I<sup>2</sup>C</b>						
C <sub>I2C_BUS</sub>	I <sup>2</sup> C Bus Capacitance		4		150	pF
I <sub>OL</sub>	I <sup>2</sup> C open drain output current	V <sub>OL</sub> = 0.4V	1.5			mA
V <sub>IL</sub>	2.3V ≤ V <sub>CC</sub> ≤ 4.3V, V <sub>I2C_BUS</sub> = 1.8V +/-10%	R <sub>Pull-up</sub> = 1.6kΩ to 2.5kΩ, % of V <sub>I2C_BUS</sub>			25	%
V <sub>IL</sub>	V <sub>I2C_BUS</sub> = 3.3V +/-10%	R <sub>Pull-up</sub> = 2.8kΩ to 7kΩ, % of V <sub>I2C_BUS</sub>			25	%
V <sub>IH</sub>	2.3V ≤ V <sub>CC</sub> ≤ 4.3V, V <sub>I2C_BUS</sub> = 1.8V +/-10%	R <sub>Pull-up</sub> = 1.6kΩ to 2.5kΩ, % of V <sub>I2C_BUS</sub>	80			%
V <sub>IH</sub>	V <sub>I2C_BUS</sub> = 3.3V +/-10%	R <sub>Pull-up</sub> = 2.8kΩ to 7kΩ, % of V <sub>I2C_BUS</sub>	75			%
R <sub>Pull-up</sub>	V <sub>I2C_BUS</sub> = 1.8V +/-10%		1.6	2	2.5	kΩ
R <sub>Pull-up</sub>	V <sub>I2C_BUS</sub> = 3.3V +/-10%		2.8	4.7	7	kΩ
SCL Frequency					100	kHz
<b>DxP, DxM</b>						
C <sub>IO_DXX</sub>	Capacitance to GND	Measured with VNA at 240 MHz, V <sub>CC</sub> supply stable, Redriver off		2.5		pF

(1) All typical values are at V<sub>CC</sub> = 5 V, and T<sub>A</sub> = 25°C.

## 7.6 Switching Characteristics

Over operating free-air temperature range (unless otherwise noted)

PARAMETER		TEST CONDITIONS	MIN	TYP <sup>(1)</sup>	MAX	UNIT
<b>DxP, DxM USB Signals</b>						
F <sub>BR_DXX</sub>	Bit Rate	USB channel = HS mode. 480 Mbps traffic. V <sub>CC</sub> supply stable			480	Mbps
t <sub>R/F_DXX</sub>	Rise/Fall time		100			ps

(1) All typical values are at V<sub>CC</sub> = 5 V, and T<sub>A</sub> = 25°C.



## 7.7 Timing Requirements

		MIN	NOM	MAX	UNIT
<b>POWER UP TIMING</b>					
T <sub>RSTN_PW</sub>	Minimum width to detect a valid RSTN signal assert when the pin is actively driven low	100			μs
T <sub>STABLE</sub>	V <sub>CC</sub> must be stable before RSTN de-assertion	300			μs
T <sub>READY</sub>	Maximum time needed for the device to be ready after RSTN is de-asserted.			500	μs
T <sub>RAMP</sub>	V <sub>CC</sub> ramp time			100	ms
T <sub>RAMP</sub>	V <sub>CC</sub> ramp time	0.2			ms
<b>I2C (STD)</b>					
t <sub>SUSTO</sub>	Stop setup time, SCL (T <sub>r</sub> =600ns-1000ns), SDA (T <sub>r</sub> =6.5ns-106.5ns), 100kHz STD	4			μs
t <sub>HDSTA</sub>	Start hold time, SCL (T <sub>r</sub> =600ns-1000ns), SDA (T <sub>f</sub> =6.5ns-106.5ns), 100kHz STD	4			μs
t <sub>SUSTA</sub>	Start setup time, SCL (T <sub>r</sub> =600ns-1000ns), SDA (T <sub>r</sub> =6.5ns-106.5ns), 100kHz STD	4.7			μs
t <sub>SUDAT</sub>	Data input or False start/stop, setup time, SCL (T <sub>r</sub> =600ns-1000ns), SDA (T <sub>r</sub> =6.5ns-106.5ns), 100kHz STD	250			ns
t <sub>HDDAT</sub>	Data input or False start/stop, hold time, SCL (T <sub>r</sub> =600ns-1000ns), SDA (T <sub>r</sub> =6.5ns-106.5ns), 100kHz STD	5			μs
t <sub>BUF</sub>	Bus free time between START and STOP conditions	4.7			μs
t <sub>LOW</sub>	Low period of the I <sub>2C</sub> clock	4.7			μs
t <sub>HIGH</sub>	High period of the I <sub>2C</sub> clock	4			μs
t <sub>F</sub>	Fall time of both SDA and SCL signals			300	ns
t <sub>R</sub>	Rise time of both SDA and SCL signals			1000	ns

## 8 Detailed Description

### 8.1 Overview

The TUSB217A is a USB High-Speed (HS) signal conditioner designed to compensate for ISI signal loss in a transmission channel. TUSB217A has a patented design for USB Low Speed (LS) and Full Speed (FS) signals. It does not alter the signal characteristics. HS signals are compensated. The design is compatible with USB On-The-Go (OTG) and Battery Charging (BC) specifications.

Programmable signal gain through an external resistor permits fine tuning device performance to optimize signals. This helps pass USB HS electrical compliance tests at the connector. Additional RX sensitivity, tuned by external pull-up resistor and pull-down resistor, allows to overcome attenuation in cables. The TUSB217A allows application in series to cover longer distances, or high loss transmission paths. A maximum of 4 devices can be daisy-chained.

### 8.2 Functional Block Diagram

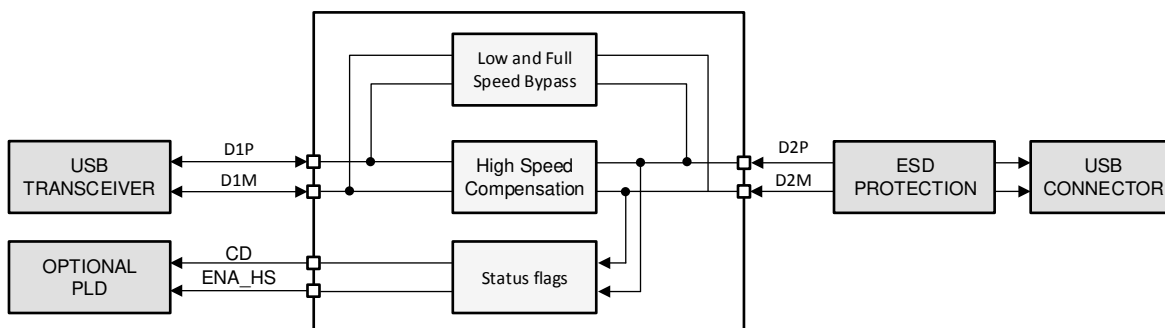

Copyright © 2018, Texas Instruments Incorporated

### 8.3 Feature Description

#### 8.3.1 High-Speed Boost

The high-speed booster (combination of edge boost and DC boost) improves the eye width for USB2.0 high-speed signals. It is direction independent and by that is compatible to OTG systems. The BOOST pin is configuring the booster strength with different values of pull down resistors to set 4 levels of boosts, alternatively the boost level can be set through the I2C register according to [セクション 8.4.6](#). Internal circuitry of the signal conditioner reduces possible overshoot.

#### 8.3.2 RX Sensitivity

The RX\_SEN pin is a tri-level pin. It is used to set the equalization gain of the device according to system channel inter-symbol interference (ISI) loss. RX equalization can be increased to compensate for the higher ISI loss of the channel for example due to a long cable.

### 8.4 Device Functional Modes

#### 8.4.1 Low-Speed (LS) Mode

TUSB217A automatically detects a LS connection and does not enable signal compensation. CD pin is asserted high but ENA\_HS will be low.

#### 8.4.2 Full-Speed (FS) Mode

TUSB217A automatically detects a FS connection and does not enable signal compensation. CD pin is asserted high but ENA\_HS will be low.

#### 8.4.3 High-Speed (HS) Mode

TUSB217A automatically detects a HS connection and will enable signal compensation as determined by the configuration of the RX\_SEN pin and the external pull down resistance on its BOOST pin.

CD pin and ENA\_HS pin are asserted high when high-speed boost is active.

#### 8.4.4 High-Speed Downstream Port Electrical Compliance Test Mode

TUSB217A will detect HS compliance test fixture and enter downstream port high-speed eye diagram test mode. CD pin will be low and ENA\_HS pin is asserted high when TUSB217A is in HS eye compliance test mode.

If RSTN pin is asserted low and de-asserted high while TUSB217A is operating in HS functional mode, TUSB217A may transition to HS eye compliance test mode and CD asserts low and ENA\_HS remains high. When this occurs signal compensation is enabled.

#### 8.4.5 Shutdown Mode

TUSB217A can be disabled when its RSTN pin is asserted low. DP, DM traces are continuous through the device in shutdown mode. The USB channel is still fully operational, but there is neither signal compensation, nor any indication from the CD pin as to the status of the channel.

**表 8-1. CD and ENA\_HS Pins in Different Modes**

MODE	CD	ENA_HS
Low-speed	HIGH	LOW
Full-speed	HIGH	LOW
High-speed	HIGH	HIGH
High-speed downstream port electrical test	LOW	HIGH
Shutdown	LOW	LOW

#### 8.4.6 I<sup>2</sup>C Mode

TUSB217A supports 100 KHz I2C for device configuration, status read back and test purposes. For detail electrical and functional specifications refer to I2C Bus Specification 2.1, 2001 – STANDARD MODE. This controller is enabled after SCL and SDA pins are sampled high shortly after return from shutdown. In this mode, the CSR can be accessed by I2C read/write transaction to 7-bit slave address 0x2C. It is advised to set CFG\_ACTIVE bit before changing values. This halts the FSM, and reset it after all changes are made. This ensure proper startup into high-speed mode.

#### 8.4.7 BC 1.2 Battery Charging Controller

Battery charging controller feature is always enabled in TUSB217A RWB and supports both CDP charging downstream port functionality and DCP dedicated charging port functionality depending on DCP/CDP pin. When DCP/CDP pin is high the BC 1.2 controller supports CDP mode and when DCP/CDP pin is low BC 1.2 controller supports DCP mode. DCP/CDP pin can be dynamically controlled. When host or hub is disabled DCP/CDP pin can be set low to support DCP mode and when host or hub is enabled DCP/CDP pin can be set to high to support CDP. Downstream VBUS should be toggled after the DCP/CDP pin change so BC 1.2 handshake starts over to indicate charging mode change.

DCP/CDP pin has an internal pull up resistor. When DCP/CDP pin is left unconnected the BC 1.2 controller will be in CDP mode.

**表 8-2. TUSB217A RWB Battery Charging Controller Modes**

Pin 11 (DCP/CDP)	CDP	DCP
Low	NO	YES
High	YES	NO

## 8.5 TUSB217A Registers

表 8-3 lists the memory-mapped registers for the TUSB217A registers. All register offset addresses not listed in 表 8-3 should be considered as reserved locations and the register contents should not be modified.

**表 8-3. TUSB217A Registers**

Offset	Acronym	Register Name	Section
0x1	EDGE_BOOST	This register is setting EDGE BOOST level.	<a href="#">Go</a>
0x3	CONFIGURATION	This register is selecting device mode.	<a href="#">Go</a>
0xE	DC_BOOST	This register is setting DC BOOST level.	<a href="#">Go</a>
0x25	RX_SEN	This register is setting RX Sensitivity level.	<a href="#">Go</a>

Complex bit access types are encoded to fit into small table cells. 表 8-4 shows the codes that are used for access types in this section.

**表 8-4. TUSB217A Access Type Codes**

Access Type	Code	Description
Read Type		
RH	H R	Set or cleared by hardware Read
Write Type		
W	W	Write
Reset or Default Value		
-n		Value after reset or the default value

### 8.5.1 EDGE\_BOOST Register (Offset = 0x1) [reset = X]

EDGE\_BOOST is shown in 图 8-1 and described in 表 8-5.

Return to [Summary Table](#).

This register is setting EDGE BOOST level.

**图 8-1. EDGE\_BOOST Register**

7	6	5	4	3	2	1	0
ACB_LVL				RESERVED			
RH/W-X				RH/W-X			

**表 8-5. EDGE\_BOOST Register Field Descriptions**

Bit	Field	Type	Reset	Description
7-4	ACB_LVL	RH/W	X	XXXXb (sampled at startup from BOOST pin) 0000b to 1111b range 0x0 = BOOST PIN LEVEL 0 (lowest edge boost setting) 0x3 = BOOST PIN LEVEL 1 0x6 = BOOST PIN LEVEL 2 0xA = BOOST PIN LEVEL 3 0xF = (highest edge boost setting)

表 8-5. EDGE\_BOOST Register Field Descriptions (continued)

Bit	Field	Type	Reset	Description
3-0	RESERVED	RH/W	X	These bits are reserved bits and set by hardware at reset. When this register is modified the software should first read these reserved bits and rewrite with the same values

### 8.5.2 CONFIGURATION Register (Offset = 0x3) [reset = X]

CONFIGURATION is shown in 图 8-2 and described in 表 8-6.

Return to [Summary Table](#).

This register is selecting device mode.

图 8-2. CONFIGURATION Register

7	6	5	4	3	2	1	0
RESERVED							CFG_ACTIVE
RH/W-X							RH/W-0x1

表 8-6. CONFIGURATION Register Field Descriptions

Bit	Field	Type	Reset	Description
7-1	RESERVED	RH/W	X	These bits are reserved bits and set by hardware at reset. When this register is modified the software should first read these reserved bits and rewrite with the same values
0	CFG_ACTIVE	RH/W	0x1	Configuration mode After reset, if I2C mode is true (SCL and SDA are both pulled high) set the bit to get into configuration mode and clear to return to normal mode.  0x0 = NORMAL MODE 0x1 = CONFIGURATION MODE

### 8.5.3 DC\_BOOST Register (Offset = 0xE) [reset = X]

DC\_BOOST is shown in 图 8-3 and described in 表 8-7.

Return to [Summary Table](#).

This register is setting DC BOOST level.

图 8-3. DC\_BOOST Register

7	6	5	4	3	2	1	0
RESERVED				DCB_LVL			
RH/W-X				RH/W-X			

表 8-7. DC\_BOOST Register Field Descriptions

Bit	Field	Type	Reset	Description
7-4	RESERVED	RH/W	X	These bits are reserved bits and set by hardware at reset. When this register is modified the software should first read these reserved bits and rewrite with the same values

**表 8-7. DC\_BOOST Register Field Descriptions (continued)**

Bit	Field	Type	Reset	Description
3-0	DCB_LVL	RH/W	X	XXXXb (sampled at startup from BOOST pin) 0000b to 1111b range  0x0 = BOOST PIN LEVEL 0 (lowest dc boost setting)  0x2 = BOOST PIN LEVEL 1 and 2  0x6 = BOOST PIN LEVEL 3  0xF = (highest dc boost setting)

**8.5.4 RX\_SEN Register (Offset = 0x25) [reset = X]**

RX\_SEN is shown in [図 8-4](#) and described in [表 8-8](#).

Return to [Summary Table](#).

This register is setting RX Sensitivity level.

**図 8-4. RX\_SEN Register**

7	6	5	4	3	2	1	0
RX_SEN							
RH/W-X							

**表 8-8. RX\_SEN Register Field Descriptions**

Bit	Field	Type	Reset	Description
7-0	RX_SEN	RH/W	X	XXXXb (sampled at startup from RX_SEN pin) 00000000b to 11111111b range  0x0 = RX_SEN LEVEL LOW  0x33 = RX_SEN LEVEL MID  0x66 = RX_SEN LEVEL HIGH  0xFF = (highest setting)

## 9 Application and Implementation

---

### Note

以下のアプリケーション情報は、TI の製品仕様に含まれるものではなく、TI ではその正確性または完全性を保証いたしません。個々の目的に対する製品の適合性については、お客様の責任で判断していただくこととなります。お客様は自身の設計実装を検証しテストすることで、システムの機能を確認する必要があります。

---

### 9.1 Application Information

The purpose of the TUSB217A is to re-store the signal integrity of a USB High-speed channel up to the USB connector. The loss in signal quality stems from reduced channel bandwidth due to high loss PCB trace and other components that contribute a capacitive load. This can cause the channel to fail the USB near end eye mask. Proper use of the TUSB217A can help to pass this eye mask.

A secondary purpose is to use the CD pin of the TUSB217A to control other blocks on the customer platform, if so desired.

### 9.2 Typical Application

A typical application for TUSB217A with dynamic mode change between DCP and CDP is shown in [Figure 9-1](#). BC 1.2 controller mode will be based on host/hub active state in this application. When host/hub is not active the controller will be in DCP mode and when the host/hub is active the controller will be in CDP mode. Downstream VBUS needs to be toggled by the power controller to change advertisement and for portable device to re-detect the BC 1.2 controller charging mode. In this setup, D2P and D2M face the USB connector while D1P and D1M face the USB host. The orientation may be reversed (that is, D2 faces transceiver and D1 faces connector).

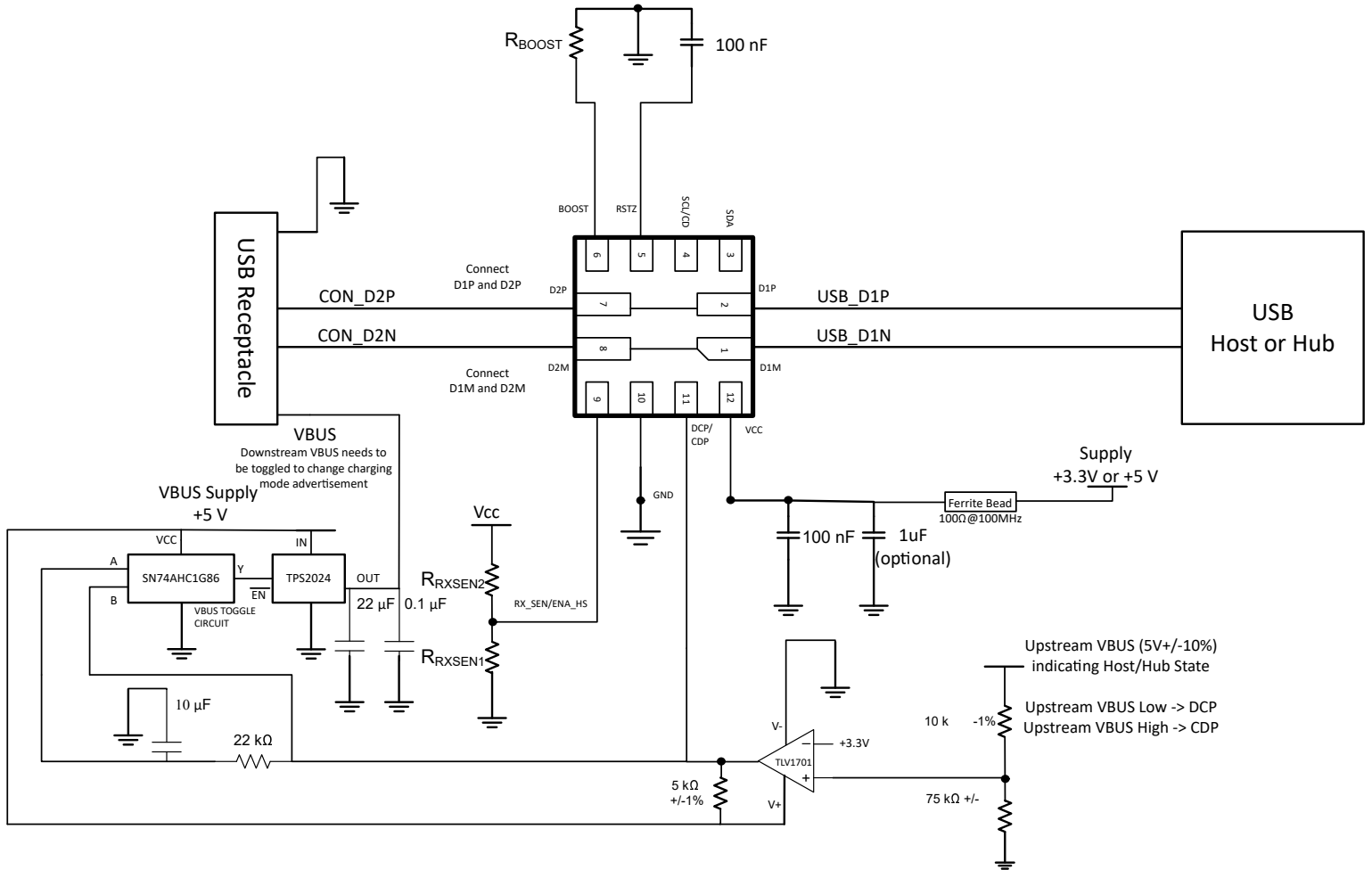

Copyright © 2021, Texas Instruments Incorporated

**9-1. TUSB217A: A Reference Schematic (Design Example with DCP/CDP Dynamic Switching). Downstream VBUS Needs to be Toggled if Upstream VBUS State Changes for BC 1.2 Controller to Change DCP/CDP Advertisement.**



### 9.2.1 Design Requirements

TUSB217A requires a valid reset signal as described in the *Power Supply Recommendations* section. The capacitor at RSTN pin is not required if a micro controller drives the RSTN pin according to recommendations.

For this design example, use the parameters shown in [表 9-1](#), [表 9-2](#) and [表 9-3](#).

**表 9-1. Design Parameters for 5-V Supply With High Loss System**

PARAMETER				VALUE <sup>(1)</sup>
V <sub>CC</sub>				5 V ±10%
I <sup>2</sup> C support required in system (Yes/No)				No
Edge and DC Boost		<b>R<sub>BOOST</sub></b>	<b>BOOST Level</b>	Boost Level 1: R <sub>BOOST</sub> = 1.8 kΩ
		0-Ω	0	
		1.8 kΩ ±1%	1	
		3.6 kΩ ± 1%	2	
		Do Not Install (DNI)	3	
RX Sensitivity	<b>R<sub>RXSEN1</sub></b>	<b>R<sub>RXSEN2</sub></b>	<b>RX_SEN Level</b>	High RX Sensitivity Level: R <sub>RXSEN1</sub> = 37.5 kΩ R <sub>RXSEN2</sub> = 12.5 kΩ
	22 kΩ - 40 kΩ (27 kΩ typical)	Do Not Install (DNI)	Low	
	Do Not Install (DNI)	Do Not Install (DNI)	Medium	
	37.5 kΩ <sup>(2)</sup>	12.5 kΩ	High	

- (1) These parameters are starting values for a high loss system. Further tuning might be required based on specific host or device as well as cable length and loss profile. These settings are not specific to a 5 V supply system could be applicable to 3.3 V supply system as well.
- (2) This resistor is needed for a 5 V supply to divide the voltage down so the RX\_SEN pin voltage does not exceed 5.0 V.

**表 9-2. Design Parameters for 3.3-V Supply With Low to Medium Loss System**

PARAMETER				VALUE <sup>(1)</sup>
V <sub>CC</sub>				3.3 V ±10%
I <sup>2</sup> C support required in system (Yes/No)				No
Edge and DC Boost		<b>R<sub>BOOST</sub></b>	<b>BOOST Level</b>	Boost Level 0: R <sub>BOOST</sub> = 0-Ω
		0-Ω	0	
		1.8 kΩ ±1%	1	
		3.6 kΩ ±1%	2	
		Do Not Install (DNI)	3	
RX Sensitivity	<b>R<sub>RXSEN1</sub></b>	<b>R<sub>RXSEN2</sub></b>	<b>RX_SEN Level</b>	Medium RX Sensitivity Level: R <sub>RXSEN1</sub> = DNI R <sub>RXSEN2</sub> = DNI
	22 kΩ – 40 kΩ (27 kΩ typical)	Do Not Install (DNI)	Low	
	Do Not Install (DNI)	Do Not Install (DNI)	Medium	
	Do Not Install (DNI)	22 kΩ – 40 kΩ (27 kΩ typical)	High	

- (1) These parameters are starting values for a low to medium loss system. Further tuning might be required based on specific host or device as well as cable length and loss profile. These settings are not specific to a 3.3 V supply system could be applicable to 5 V supply system as well.

**表 9-3. Design Parameters for 2.3-V to 4.3-V VBAT Supply With Low to Medium Loss System**

PARAMETER			VALUE <sup>(1)</sup>
V <sub>CC</sub>			2.3 V to 4.3V
I <sup>2</sup> C support required in system (Yes/No)			No
Edge and DC Boost	<b>R<sub>BOOST</sub></b>	<b>BOOST Level</b>	Boost Level 0: R <sub>BOOST</sub> = 0-Ω
	0-Ω	0	
	1.8 kΩ ±1%	1	
	3.6 kΩ ±1%	2	
	Do Not Install (DNI)	3	
RX Sensitivity	<b>R<sub>RXSEN1</sub></b>	<b>R<sub>RXSEN2</sub></b>	<b>RX_SEN Level</b>
	22 kΩ – 40 kΩ (27 kΩ typical)	Do Not Install (DNI)	Low
	Do Not Install (DNI)	Do Not Install (DNI)	Medium
	37.5 kΩ <sup>(2)</sup>	12.5 kΩ	High

- (1) These parameters are starting values for a low to medium loss system. Further tuning might be required based on specific host or device as well as cable length and loss profile. These settings are not specific to a 2.3 V – 4.3 V supply system could be applicable to 5 V supply system as well.
- (2) This resistor is needed for a VBAT supply (2.3 V – 4.3 V) to divide the voltage down so the RX\_SEN pin voltage does not exceed 5.0 V.

### 9.2.2 Detailed Design Procedure

The ideal BOOST setting is dependent upon the signal chain loss characteristics of the target platform. The recommendation is to start with BOOST level 0, and then increment to BOOST level 1, and so on. Same applies to the RX sensitivity setting where it is recommended to plan for the required pads or connections to change boost settings, but to start with RX sensitivity level Low.

In order for the TUSB217A to recognize any change to the BOOST setting, the RSTN pin must be toggled. This is because the BOOST pin is latched on power up and the pin is ignored thereafter.

#### Note

The TUSB217A compensates for extra attenuation in the signal path according to the configuration of the RX\_SEN pin. This maximum recommended voltage for this pin is 5 V when selecting the highest RX sensitivity level.

Placement of the device is also dependent on the application goal. 表 9-4 summarizes our recommendations.

**表 9-4. Platform Placement Guideline**

PLATFORM GOAL	SUGGESTED TUSB217A PLACEMENT
Pass USB Near End Mask at the receptacle	Close to measurement point (connector)
Pass USB Far End Eye Mask at the plug	Close to USB PHY
Cascade multiple TUSB217As to improve device enumeration	Midway between each USB interconnect

**表 9-5. Table of Recommended Settings**

BOOST and RX_SEN settings <sup>(1)</sup> for channel loss		
Pre-channel cable length (Between USB PHY and TUSB217A)	BOOST	RX_SEN
0-3 meter	Level 0	Medium or High
2-5 meter	Level 1	Medium or High
Post-channel cable length (Between TUSB217A and inter-connect)	BOOST	RX_SEN
0-2 meter	Level 0	Medium or High
1-4 meter	Level 1	Medium or High

(1) These parameters are starting values for different cable lengths. Further tuning might be required based on specific host or device as well as cable length and loss profile.

### 9.2.2.1 Test Procedure to Construct USB High-speed Eye Diagram

#### Note

USB-IF certification tests for High-speed eye masks require the *mandated use* of the USB-IF developed test fixtures. These test fixtures do not require the use of oscilloscope probes. Instead they use SMA cables. More information can be found at the USB-IF Compliance Updates Page. It is located under the *Electrical Specifications* section, ID 86 dated March 2013.

The following procedure must be followed before using any oscilloscope compliance software to construct a USB High-speed Eye Mask:

#### 9.2.2.1.1 For a Host Side Application

1. Configure the TUSB217A to the desired BOOST setting.
2. Power on (or toggle the RSTN pin if already powered on) the TUSB217A.
3. Using SMA cables, connect the oscilloscope and the USB-IF host-side test fixture to the TUSB217A.
4. Enable the host to transmit USB TEST\_PACKET.
5. Execute the oscilloscope USB compliance software.
6. Repeat the above steps in order to retest TUSB217A with a different BOOST setting (must reset to change).

#### 9.2.2.1.2 For a Device Side Application

1. Configure the TUSB217A to the desired BOOST setting.
2. Power on (or toggle the RSTN pin if already powered on) the TUSB217A.
3. Connect a USB host, the USB-IF device-side test fixture, and USB device to the TUSB217A. Ensure that the USB-IF device test fixture is configured to the 'INIT' position.
4. Allow the host to enumerate the device.
5. Enable the device to transmit USB TEST\_PACKET.
6. Using SMA cables, connect the oscilloscope to the USB-IF device-side test fixture and ensure that the device-side test fixture is configured to the 'TEST' position.
7. Execute the oscilloscope USB compliance software.
8. Repeat the above steps in order to re-test TUSB217A with a different BOOST setting (must reset to change).

### 9.2.3 Application Curves

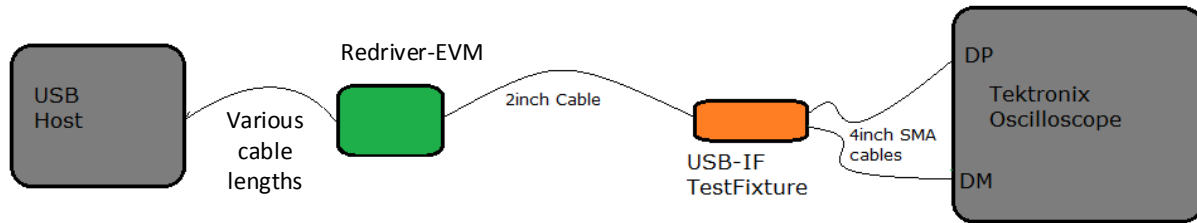

**9-2. Near End Eye Measurement Set-Up With Pre-Channel Cable**

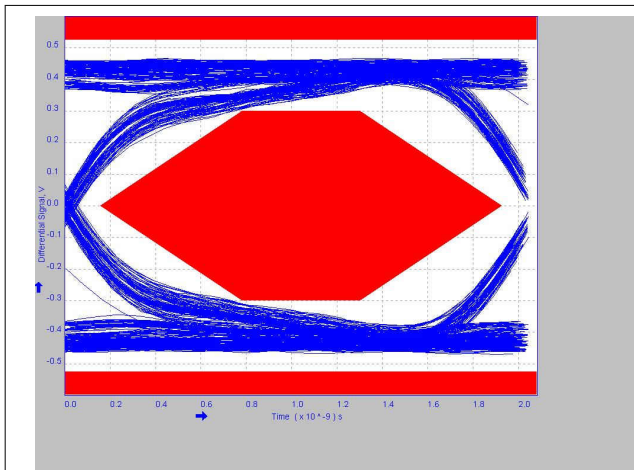

**9-3. 2 Meter Pre-Channel Without TUSB217A**

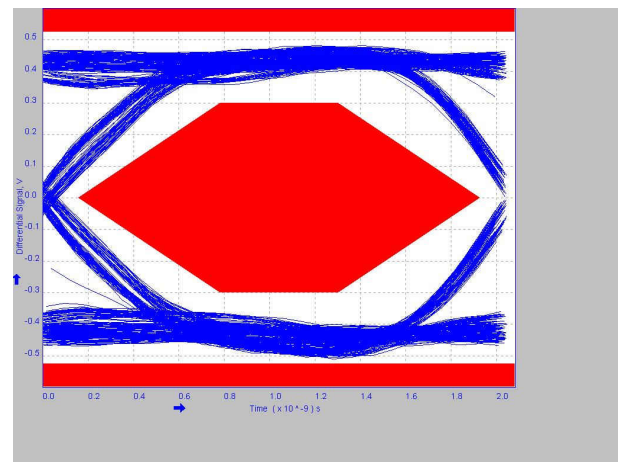

**9-4. 2 Meter Pre-Channel With TUSB217A BOOST=1  
 RX\_SEN=MED**

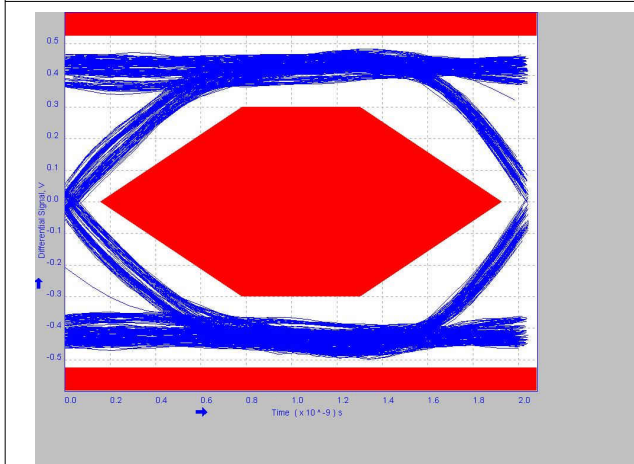

**9-5. 2 Meter Pre-Channel With TUSB217A BOOST=0  
 RX\_SEN=HIGH**

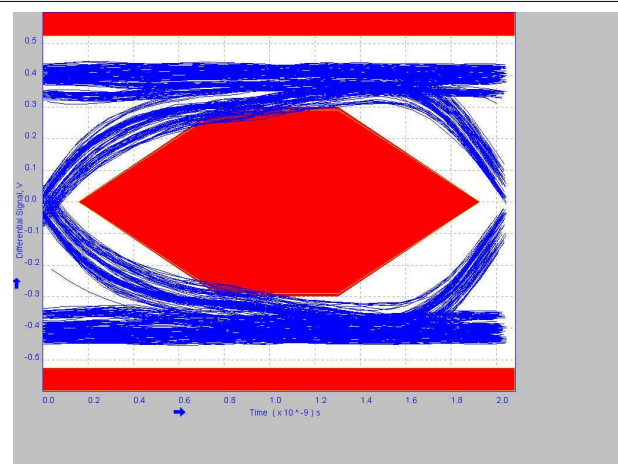

**9-6. 3 Meter Pre-Channel Without TUSB217A**

### 9.2.3 Application Curves (continued)

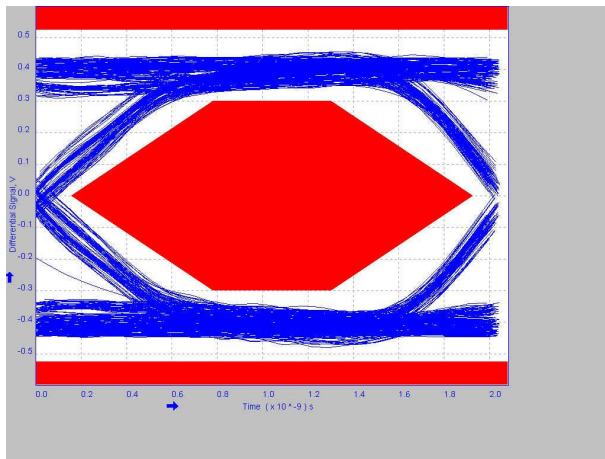

**9-7. 3 Meter Pre-Channel With TUSB217A BOOST=0  
RX\_SEN=HIGH**

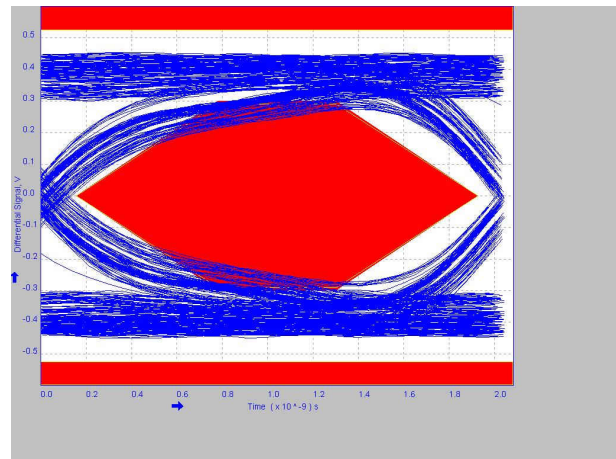

**9-8. 5 Meter Without TUSB217A**

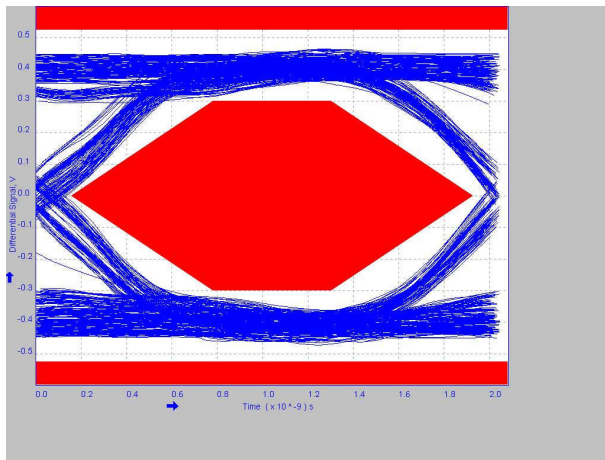

**9-9. 5 Meter Pre-Channel With TUSB217A BOOST=1  
RX\_SEN=MED**

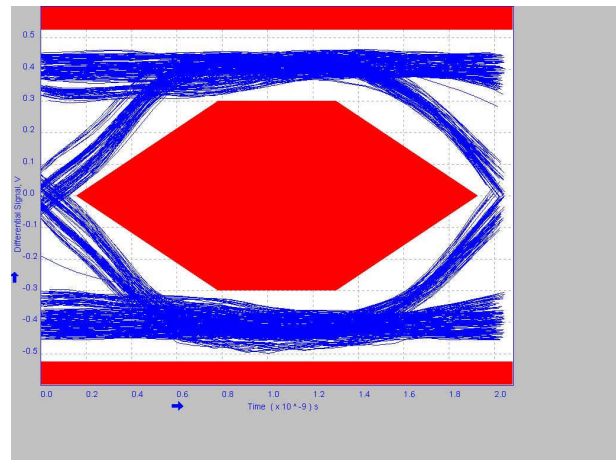

**9-10. 5 Meter Pre-Channel With TUSB217A BOOST=2  
RX\_SEN=MED**

### 9.2.3 Application Curves

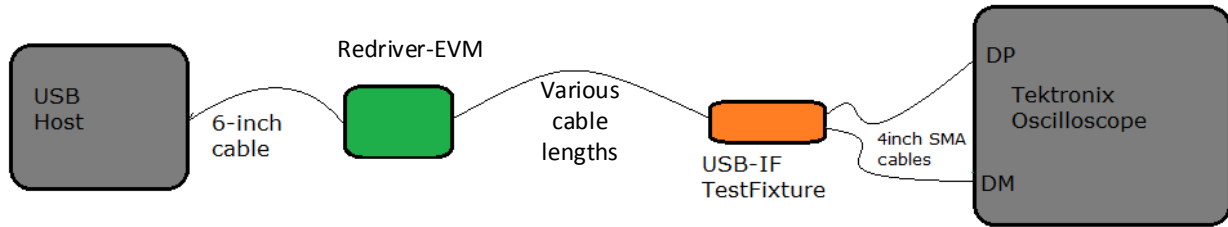

**9-11. Near End Eye Measurement Set-Up With Post-Channel Cable**

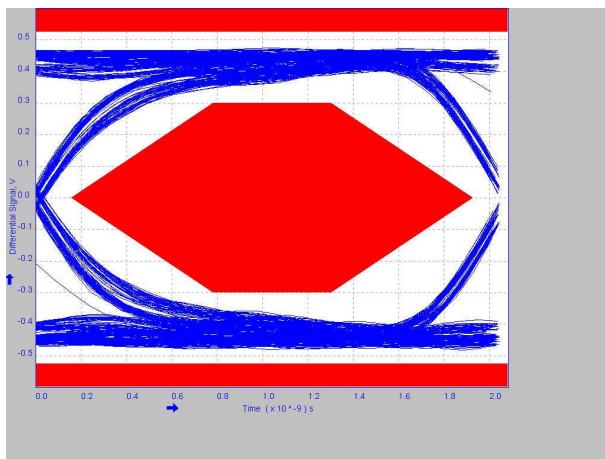

**9-12. 6 Inches Post Channel Without TUSB217A**

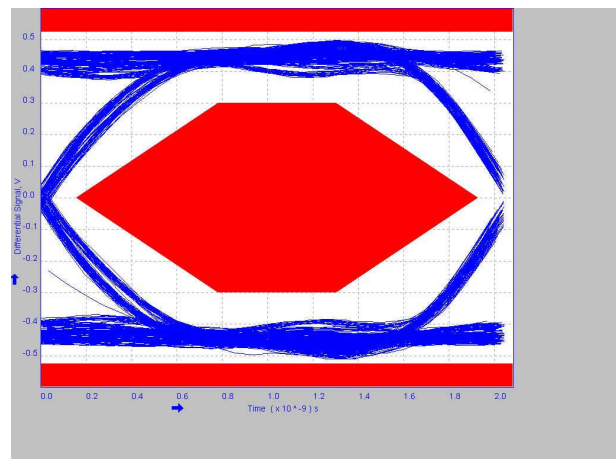

**9-13. 6 Inches Post-Channel With TUSB217A BOOST=0  
 RX\_SEN=HIGH**

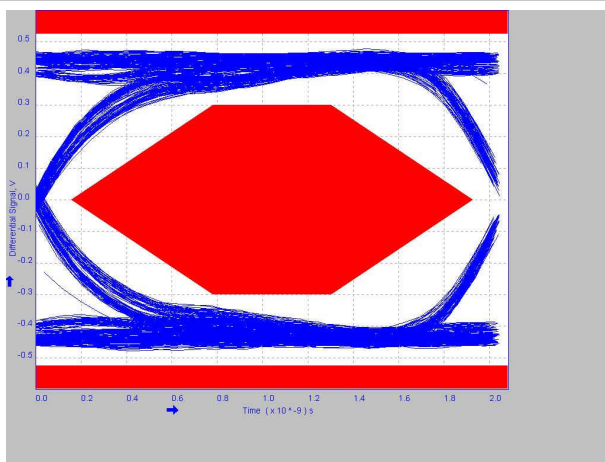

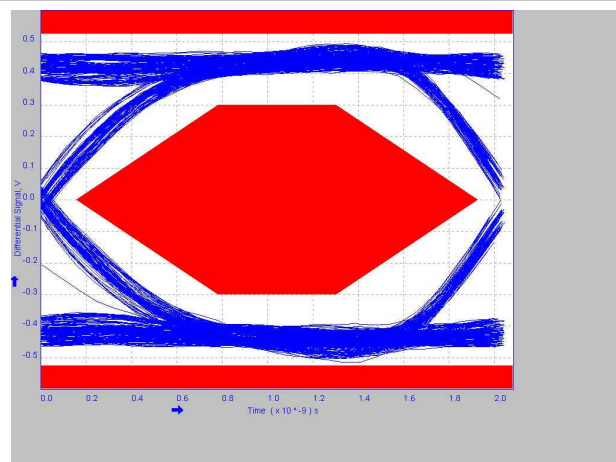

**9-14. 1 Meter Post-Channel Without TUSB217A**

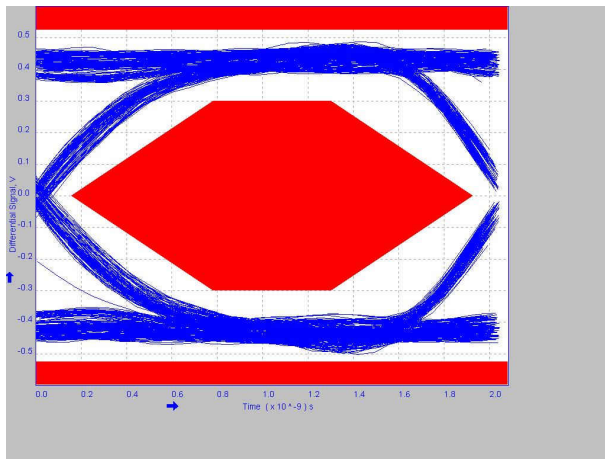

**9-15. 1 Meter Post-Channel With TUSB217A BOOST=0  
 RX\_SEN=MED**

### 9.2.3 Application Curves (continued)



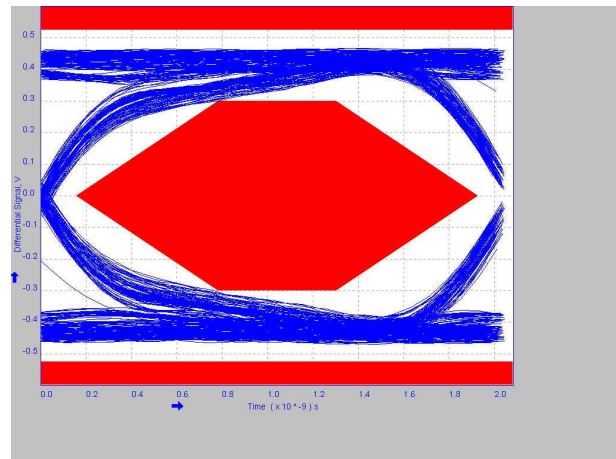

**9-16. 1 Meter Post-Channel With TUSB217A BOOST=0  
RX\_SEN=HIGH**



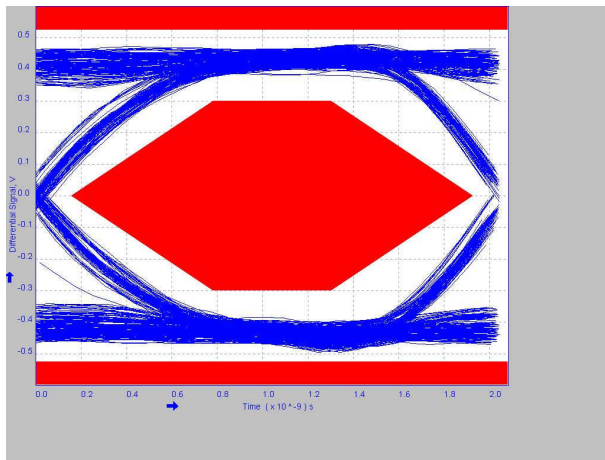

**9-17. 2 Meter Post-Channel Without TUSB217A**

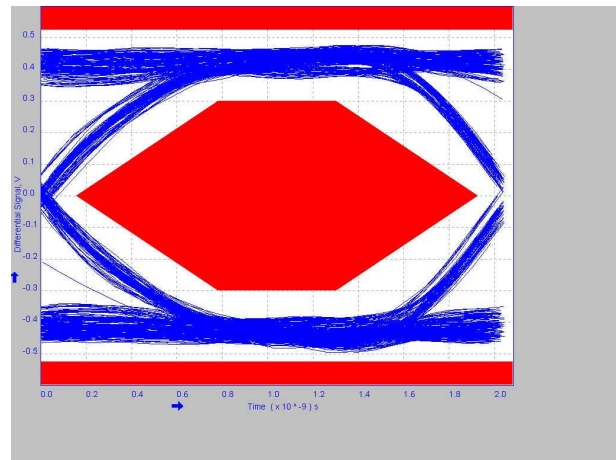



**9-18. 2 Meter Post-Channel With TUSB217A BOOST=1  
RX\_SEN=MED**

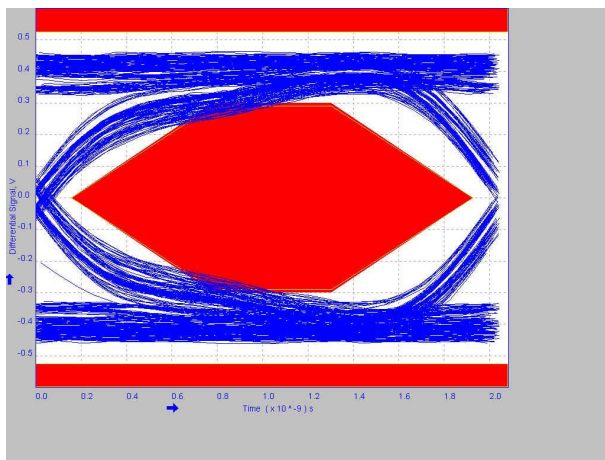



**9-19. 2 Meter Post-Channel With TUSB217A BOOST=1  
RX\_SEN=HIGH**

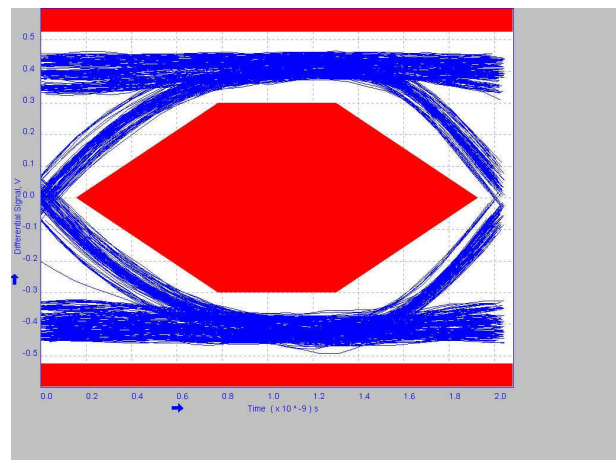

**9-20. 4 Meter Post-Channel Without TUSB217A**



**9-21. 4 Meter Post-Channel With TUSB217A BOOST=2  
RX\_SEN=MED**





## 12 Device and Documentation Support

### 12.1 Receiving Notification of Documentation Updates

To receive notification of documentation updates, navigate to the device product folder on [ti.com](https://www.ti.com). Click on *Subscribe to updates* to register and receive a weekly digest of any product information that has changed. For change details, review the revision history included in any revised document.

### 12.2 サポート・リソース

[TI E2E™ サポート・フォーラム](#)は、エンジニアが検証済みの回答と設計に関するヒントをエキスパートから迅速かつ直接得ることができる場所です。既存の回答を検索したり、独自の質問をしたりすることで、設計に必要な支援を迅速に得ることができます。

リンクされているコンテンツは、該当する貢献者により、現状のまま提供されるものです。これらは TI の仕様を構成するものではなく、必ずしも TI の見解を反映したものではありません。TI の[使用条件](#)を参照してください。

### 12.3 Trademarks

TI E2E™ is a trademark of Texas Instruments.

すべての商標は、それぞれの所有者に帰属します。

### 12.4 Electrostatic Discharge Caution



This integrated circuit can be damaged by ESD. Texas Instruments recommends that all integrated circuits be handled with appropriate precautions. Failure to observe proper handling and installation procedures can cause damage.

ESD damage can range from subtle performance degradation to complete device failure. Precision integrated circuits may be more susceptible to damage because very small parametric changes could cause the device not to meet its published specifications.

### 12.5 Glossary

[TI Glossary](#) This glossary lists and explains terms, acronyms, and definitions.

## 13 Mechanical, Packaging, and Orderable Information

The following pages include mechanical, packaging, and orderable information. This information is the most current data available for the designated devices. This data is subject to change without notice and revision of this document. For browser-based versions of this data sheet, refer to the left-hand navigation.

## PACKAGING INFORMATION

Orderable Device	Status (1)	Package Type	Package Drawing	Pins	Package Qty	Eco Plan (2)	Lead finish/ Ball material (6)	MSL Peak Temp (3)	Op Temp (°C)	Device Marking (4/5)	Samples
TUSB217AIRWBR	ACTIVE	X2QFN	RWB	12	3000	RoHS & Green	NIPDAU	Level-2-260C-1 YEAR	-40 to 85	7A	<a href="#">Samples</a>
TUSB217AIRWBT	ACTIVE	X2QFN	RWB	12	250	RoHS & Green	NIPDAU	Level-2-260C-1 YEAR	-40 to 85	7A	<a href="#">Samples</a>
TUSB217ARWBR	ACTIVE	X2QFN	RWB	12	3000	RoHS & Green	NIPDAU	Level-2-260C-1 YEAR	0 to 70	7A	<a href="#">Samples</a>
TUSB217ARWBT	ACTIVE	X2QFN	RWB	12	250	RoHS & Green	NIPDAU	Level-2-260C-1 YEAR	0 to 70	7A	<a href="#">Samples</a>

(1) The marketing status values are defined as follows:

**ACTIVE:** Product device recommended for new designs.

**LIFEBUY:** TI has announced that the device will be discontinued, and a lifetime-buy period is in effect.

**NRND:** Not recommended for new designs. Device is in production to support existing customers, but TI does not recommend using this part in a new design.

**PREVIEW:** Device has been announced but is not in production. Samples may or may not be available.

**OBSOLETE:** TI has discontinued the production of the device.

(2) **RoHS:** TI defines "RoHS" to mean semiconductor products that are compliant with the current EU RoHS requirements for all 10 RoHS substances, including the requirement that RoHS substance do not exceed 0.1% by weight in homogeneous materials. Where designed to be soldered at high temperatures, "RoHS" products are suitable for use in specified lead-free processes. TI may reference these types of products as "Pb-Free".

**RoHS Exempt:** TI defines "RoHS Exempt" to mean products that contain lead but are compliant with EU RoHS pursuant to a specific EU RoHS exemption.

**Green:** TI defines "Green" to mean the content of Chlorine (Cl) and Bromine (Br) based flame retardants meet JS709B low halogen requirements of <=1000ppm threshold. Antimony trioxide based flame retardants must also meet the <=1000ppm threshold requirement.

(3) MSL, Peak Temp. - The Moisture Sensitivity Level rating according to the JEDEC industry standard classifications, and peak solder temperature.

(4) There may be additional marking, which relates to the logo, the lot trace code information, or the environmental category on the device.

(5) Multiple Device Markings will be inside parentheses. Only one Device Marking contained in parentheses and separated by a "-" will appear on a device. If a line is indented then it is a continuation of the previous line and the two combined represent the entire Device Marking for that device.

(6) Lead finish/Ball material - Orderable Devices may have multiple material finish options. Finish options are separated by a vertical ruled line. Lead finish/Ball material values may wrap to two lines if the finish value exceeds the maximum column width.

**Important Information and Disclaimer:** The information provided on this page represents TI's knowledge and belief as of the date that it is provided. TI bases its knowledge and belief on information provided by third parties, and makes no representation or warranty as to the accuracy of such information. Efforts are underway to better integrate information from third parties. TI has taken and

continues to take reasonable steps to provide representative and accurate information but may not have conducted destructive testing or chemical analysis on incoming materials and chemicals. TI and TI suppliers consider certain information to be proprietary, and thus CAS numbers and other limited information may not be available for release.

In no event shall TI's liability arising out of such information exceed the total purchase price of the TI part(s) at issue in this document sold by TI to Customer on an annual basis.

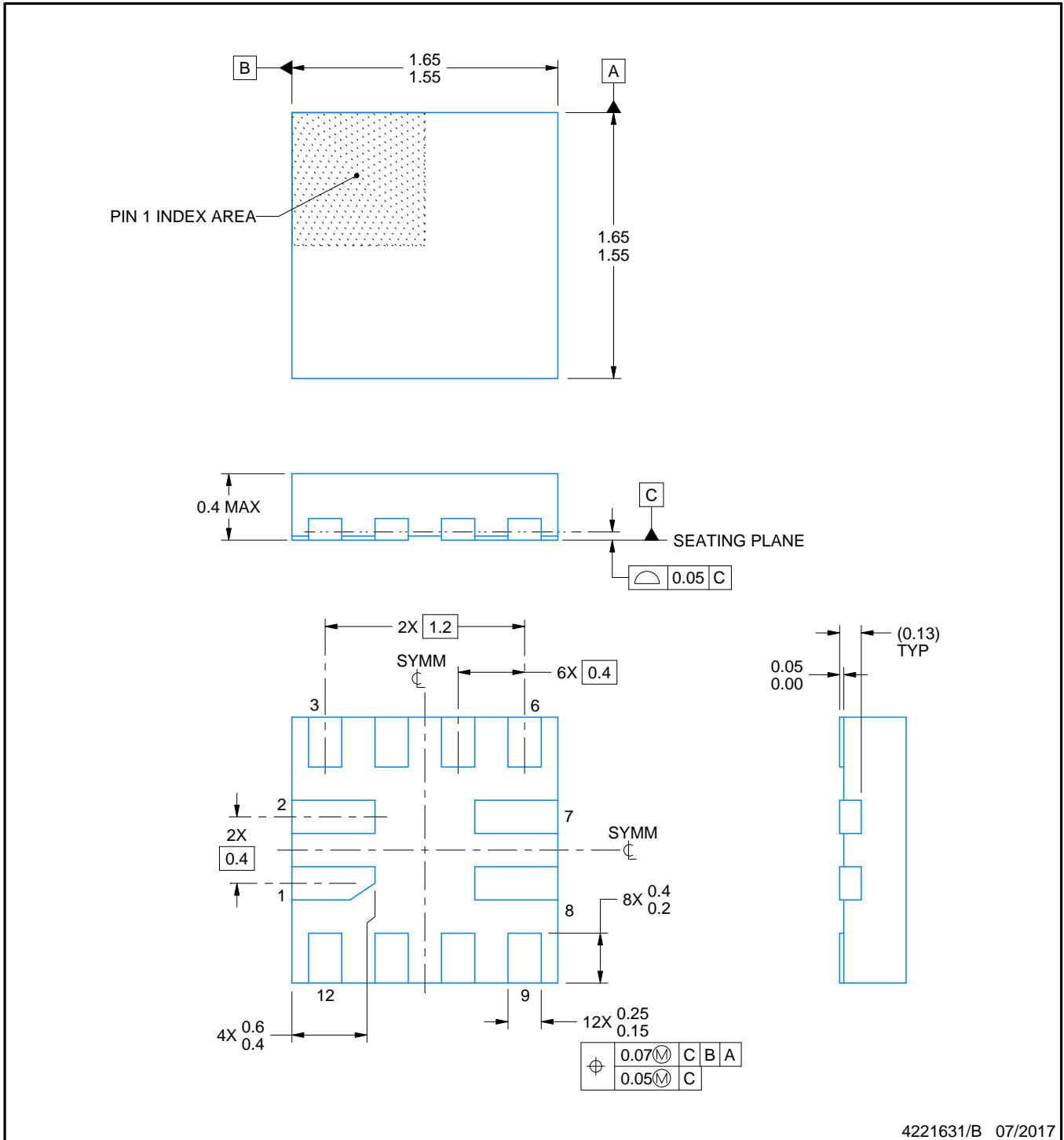
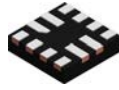

4221631/B 07/2017

NOTES:

1. All linear dimensions are in millimeters. Any dimensions in parenthesis are for reference only. Dimensioning and tolerancing per ASME Y14.5M.
2. This drawing is subject to change without notice.

# EXAMPLE BOARD LAYOUT

RWB0012A

X2QFN - 0.4 mm max height

PLASTIC QUAD FLATPACK - NO LEAD

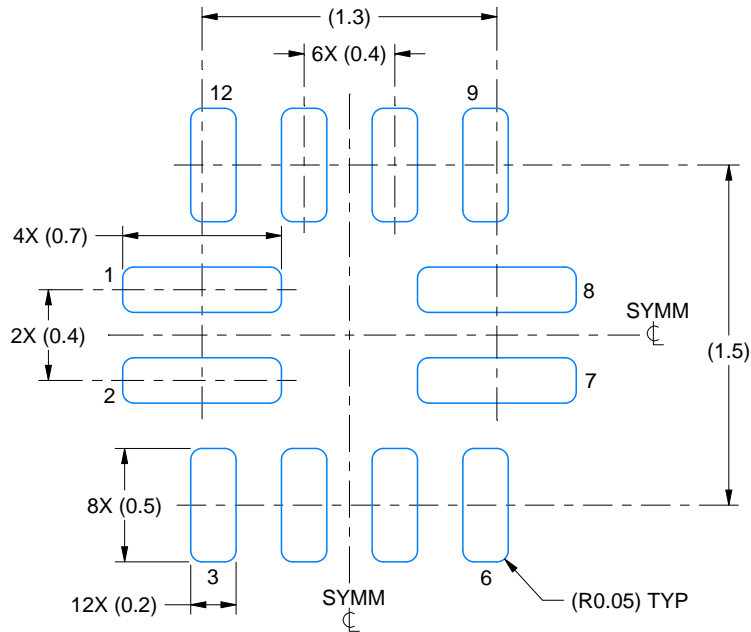

LAND PATTERN EXAMPLE  
EXPOSED METAL SHOWN  
SCALE:30X

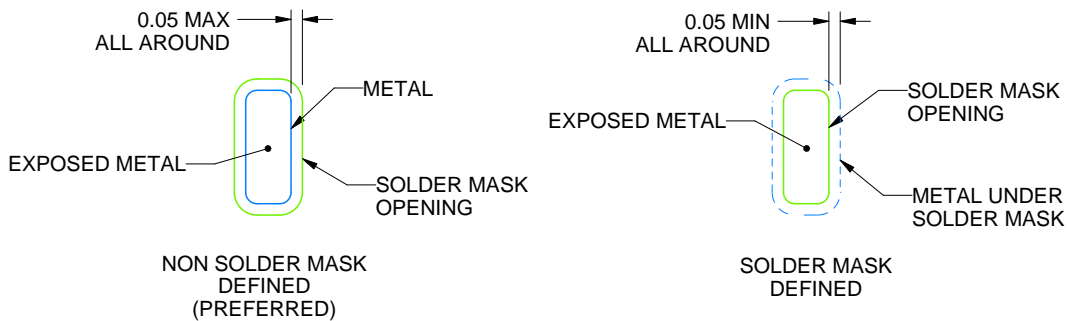

SOLDER MASK DETAILS

4221631/B 07/2017

NOTES: (continued)

3. For more information, see Texas Instruments literature number SLUA271 ([www.ti.com/lit/slua271](http://www.ti.com/lit/slua271)).

# EXAMPLE STENCIL DESIGN

RWB0012A

X2QFN - 0.4 mm max height

PLASTIC QUAD FLATPACK - NO LEAD

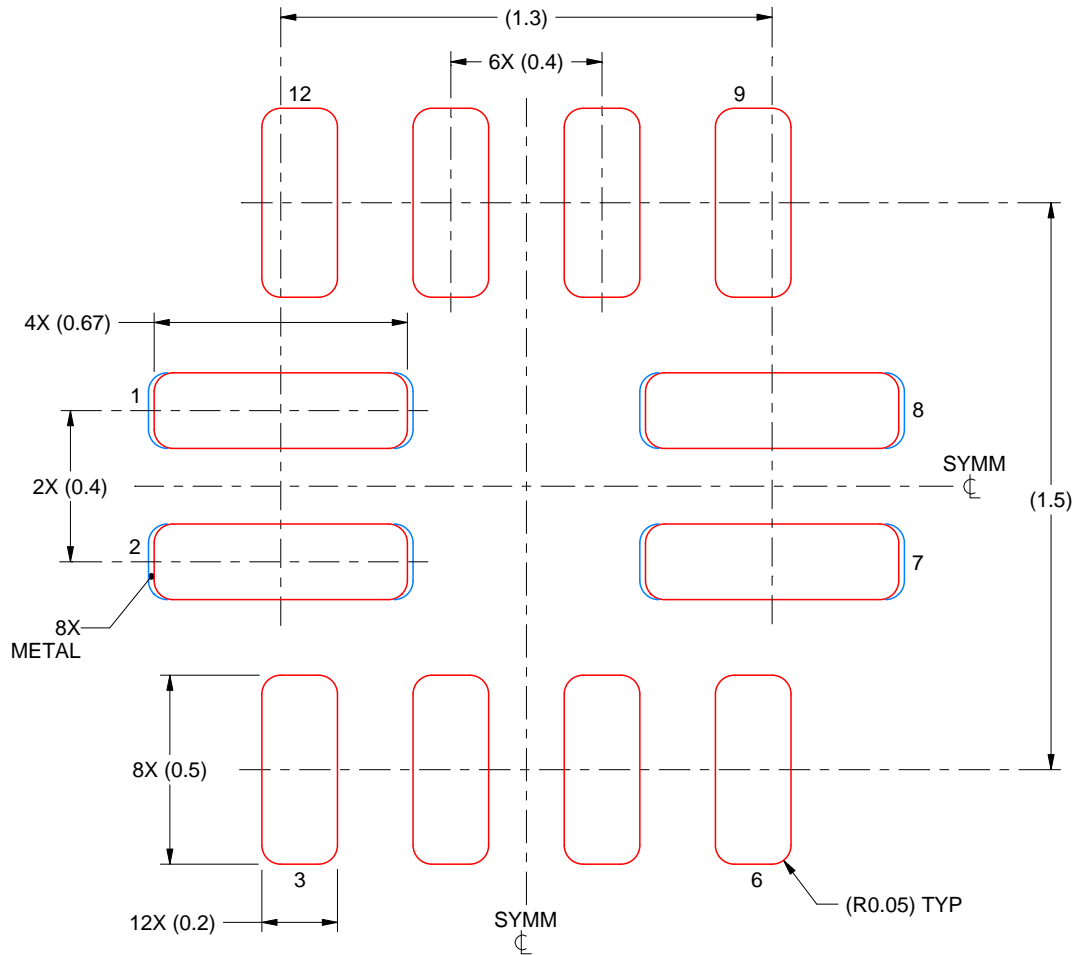

**SOLDER PASTE EXAMPLE**  
BASED ON 0.1 mm THICK STENCIL  
PADS 1,2,7 & 8  
96% PRINTED SOLDER COVERAGE BY AREA  
SCALE:50X

4221631/B 07/2017

NOTES: (continued)

4. Laser cutting apertures with trapezoidal walls and rounded corners may offer better paste release. IPC-7525 may have alternate design recommendations.

## 重要なお知らせと免責事項

TI は、技術データと信頼性データ(データシートを含みます)、設計リソース(リファレンス・デザインを含みます)、アプリケーションや設計に関する各種アドバイス、Web ツール、安全性情報、その他のリソースを、欠陥が存在する可能性のある「現状のまま」提供しており、商品性および特定目的に対する適合性の黙示保証、第三者の知的財産権の非侵害保証を含むいかなる保証も、明示的または黙示的にかかわらず拒否します。

これらのリソースは、TI 製品を使用する設計の経験を積んだ開発者への提供を意図したものです。(1) お客様のアプリケーションに適した TI 製品の選定、(2) お客様のアプリケーションの設計、検証、試験、(3) お客様のアプリケーションに該当する各種規格や、その他のあらゆる安全性、セキュリティ、規制、または他の要件への確実な適合に関する責任を、お客様のみが単独で負うものとします。

上記の各種リソースは、予告なく変更される可能性があります。これらのリソースは、リソースで説明されている TI 製品を使用するアプリケーションの開発の目的でのみ、TI はその使用をお客様に許諾します。これらのリソースに関して、他の目的で複製することや掲載することは禁止されています。TI や第三者の知的財産権のライセンスが付与されている訳ではありません。お客様は、これらのリソースを自身で使用した結果発生するあらゆる申し立て、損害、費用、損失、責任について、TI およびその代理人を完全に補償するものとし、TI は一切の責任を拒否します。

TI の製品は、[TI の販売条件](#)、または [ti.com](https://www.ti.com) やかかる TI 製品の関連資料などのいずれかを通じて提供する適用可能な条項の下で提供されています。TI がこれらのリソースを提供することは、適用される TI の保証または他の保証の放棄の拡大や変更を意味するものではありません。

お客様がいかなる追加条項または代替条項を提案した場合でも、TI はそれらに異議を唱え、拒否します。

郵送先住所 : Texas Instruments, Post Office Box 655303, Dallas, Texas 75265

Copyright © 2022, Texas Instruments Incorporated