



Joel Hernandez

ABSTRACT

This user's guide provides detailed testing instructions for the BQ25611D and BQ25619 evaluation module (EVM). Also included are descriptions of the necessary equipment, equipment setup, procedures, the printed-circuit board layouts, schematics, and the bill of materials (BOM).

Throughout this user's guide, the abbreviations *EVM*, *BQ25611DEV*M, *BQ25619EVM*, *BMS025*, and the term *evaluation module* are synonymous with the BMS025 evaluation module, unless otherwise noted.

Table of Contents

1 Introduction	3
1.1 EVM Features.....	3
1.2 I/O Descriptions.....	3
2 Test Summary	5
2.1 Equipment.....	5
2.2 Equipment Setup.....	5
2.3 Software Setup.....	6
2.4 Test Procedure.....	8
3 PCB Layout Guideline	12
4 Board Layout, Schematic, and Bill of Materials	13
4.1 Board Layout.....	13
4.2 Schematics.....	21
4.3 Bill of Materials.....	23
5 Revision History	31

List of Figures

Figure 2-1. Original Test Setup for BMS025A.....	6
Figure 2-2. BQStudio Device Type Selection Window.....	6
Figure 2-3. BQStudio Charger Selection Window.....	6
Figure 2-4. Main Window of BQ2561x EVM Software.....	7
Figure 2-5. BQ25619EVM Charge Mode Efficiency.....	10
Figure 2-6. BQ25619EVM Boost Mode Efficiency.....	10
Figure 4-1. BMS025 Rev. A Top Overlay.....	13
Figure 4-2. BMS025 Rev. A Top Solder Mask.....	14
Figure 4-3. BMS025 Rev. A Top Layer.....	15
Figure 4-4. BMS025 Rev. A MidLayer 1.....	16
Figure 4-5. BMS025 Rev. A MidLayer 2.....	17
Figure 4-6. BMS025 Rev. A Bottom Layer.....	18
Figure 4-7. BMS025 Rev. A Bottom Solder Mask.....	19
Figure 4-8. BMS025 Rev. A Bottom Overlay.....	20
Figure 4-9. BQ25619EVM Schematic.....	21
Figure 4-10. BQ25611DEV	22

List of Tables

Table 1-1. Device Data Sheets.....	3
Table 1-2. EVM I/O Connections.....	3
Table 1-3. EVM Shunt and Switch Installation.....	3
Table 1-4. Recommended Operating Conditions.....	4
Table 4-1. BQ25619EVM Bill of Materials.....	23

Table 4-2. BQ25611DEVM Bill of Materials.....	27
---	----

Trademarks

Microsoft® and Windows® are registered trademarks of Microsoft Corporation.
All trademarks are the property of their respective owners.

1 Introduction

1.1 EVM Features

For detailed features and operation, refer to [Table 1-1](#) for a list of devices and their data sheets.

Table 1-1. Device Data Sheets

Device	Data Sheet	EVM Label	Variant
BQ25611D	SLUSDF6	BQ25611DEVM	002
BQ25619	SLUSDF8	BQ25619EVM	005

The BMS025 evaluation module (EVM) is a complete charger module for evaluating an I²C-controlled, single-cell NVDC charge using any of the devices listed above.

This EVM does not include an EV2300/EV2400 interface board. To evaluate the EVM, an EV2300/EV2400 interface board must be ordered separately.

1.2 I/O Descriptions

[Table 1-2](#) lists the input and output connections available on this EVM and their respective descriptions.

Table 1-2. EVM I/O Connections

Jack	Description
J1(2) –VIN	Positive rail of the charger input voltage
J1(1) –GND	Ground
J2(1) – SYSTEM	Positive rail of the charger system output voltage, typically connected to the system load
J2(2) –GND	Ground
J3(1) –PMID	Positive rail of the charger output voltage for power bank applications in reverse boost mode (OTG). This output also shares the rail with the VIN input rail in forward buck mode
J3(2) –GND	Ground
J4(3) –BATTERY	Positive rail of the charger battery input, connected to the positive terminal of the external battery
J4(2) – BATSNS	Input connected to the positive node of the battery for remote cell voltage measurement
J4(1) - GND	Ground
J5	I ² C 4-pin connector for the EV2300/2400 interface board
J6	Input source Micro B USB port

[Table 1-3](#) lists the jumper and shunt installations available on this EVM and their respective descriptions.

Table 1-3. EVM Shunt and Switch Installation

Jack	Description	BQ25611D Setting	BQ25619 Setting
JP1	I/O Pullup rail selection. Selection will have either BAT or SYS as the pullup rail for SDA, SCL, CE, PG, STAT, and INT pins	PULLUP to SYS	Short PULLUP to SYS
JP2	Remote BATSNS pin connection to Battery input terminal. Disconnect if sensing battery voltage remotely through J4(2). If disconnected with no input on J4(2), charger BATSNS will default connect to BAT pin internally.	Installed	Installed
JP3	PMID_GOOD pin connection to control N-Ch. MOSFET for a power bank application	Not Installed	Installed
JP4	Thermistor COOL temperature setting. Connect jumper to simulate charger entering TCOOL (T1-T2) temperature region.	Not Installed	Not Installed
JP5	Thermistor COLD temperature setting. Connect jumper to simulate charger entering TCOLD (<T1) temperature region.	Not Installed	Not Installed
JP6	Micro B USB input D- connection to charger D- pin	Installed	Not Installed
JP7	Thermistor NORMAL temperature setting. Connect jumper to simulate charger entering TNORMAL (T2-T3) temperature region.	Installed	Installed

Table 1-3. EVM Shunt and Switch Installation (continued)

Jack	Description	BQ25611D Setting	BQ25619 Setting
JP8	Thermistor WARM temperature setting. Connect jumper to simulate charger entering TWARM (T3-T5) temperature region.	Not Installed	Not Installed
JP9	Thermistor HOT temperature setting. Connect jumper to simulate charger entering THOT (>T5) temperature region.	Not Installed	Not Installed
JP10	Micro B USB input D+ connection to charger D+ pin	Installed	Not Installed
JP11	\overline{PG} pin LED indicator connection. On \overline{PG} enabled chargers, this indicates the Power Good status	Not Installed	Not Installed
JP12	STAT pin LED indicator connection. This indicates the current charger Status	Installed	Installed
JP13	Charger D+ pin and charger D- pin short connection. Connect this on D+/D- detection enabled chargers to simulate the connection of a DCP-type USB port as defined by USB BC1.2	Not Installed	Not Installed
JP14	\overline{CE} pin connection to ground to enable charging. When removed, \overline{CE} pin will pull up to disable charge	Installed	Installed
JP15	PSEL pin input current selection. Connect this to HIGH on PSEL enabled chargers to select 500mA default input current limit. Connect this to LOW on PSEL enabled chargers to select 2.4-A default input current limit	Not Installed	Short PSEL to LOW
JP16	VPB status LED indicator connection. On power bank PMID_GOOD enabled chargers, this indicates VPB rail is active	Not Installed	Not Installed
S1	\overline{QON} control switch. Press either for exiting Shipping Mode or System Reset.	Default Off	Default Off

Table 1-4 lists the recommended operating conditions for this EVM.

Table 1-4. Recommended Operating Conditions

Symbol	Description	MIN	TYP	MAX	Unit
V_{VBUS}, V_{VAC}	Input voltage applied to VAC and VBUS pins	3.9		14.0	V
V_{BAT}	Battery voltage applied to BAT pin	0	4.208	4.52	V
I_{VBUS}	Input current into VBUS	0		3.2	A
I_{SW}	Output current (SW)			3.2	A
I_{BAT}	Fast charging current	0		3.0 ⁽¹⁾	A
	Discharging current through internal BATFET			6	A

(1) BQ25619EVM maximum I_{BAT} is 1.5A.

2 Test Summary

2.1 Equipment

This section includes a list of supplies required to perform tests on this EVM.

1. **Power Supplies:** Power Supply #1 (PS1): A power supply capable of supplying 5 V at 3 A is required. While this part can handle larger voltage and current, it is not necessary for this procedure.
2. **Loads:** Load #1 (4-Quadrant Supply, Constant Voltage < 4.5 V): A "Kepco" Load, BOP, 20-5M, DC 0 to ± 20 V, 0 to ± 5 A (or higher)
Alternative Option: A 0–20V/0–5 A, > 30-W DC electronic load set in a constant voltage loading mode
Load #2(Electronic or Resistive Load): 10 Ω , 5 W (or higher)
3. **Meters:** (6x) "Fluke 75" multimeters, (equivalent or better).
Alternative Option: (4x) equivalent voltage meters and (2x) equivalent current meters. The current meters must be capable of measuring at least 5-A.
4. **Computer:** A computer with at least one USB port and a USB cable. Must have the latest version of Battery Management Studio installed.
5. **USB-TO-GPIO Communication Kit:** EV2300/EV2400 USB-based PC interface board.
6. **Software:** Download the latest version of [BQSTUDIOTEST](http://www.ti.com) from www.ti.com.
Double click the *Battery Management Studio* installation file and follow the installation steps. The software supports the Microsoft® Windows® XP, 7, and 10 operating systems.

2.2 Equipment Setup

Use the following list to set up the EVM testing equipment:

1. Review EVM connections in [Table 1-2](#).
2. Set PS1 for 5-V DC, 2-A current limit and then turn off the supply.
3. Connect the output of PS1 in series with a current meter to J1 (VBUS and PGND).
4. Connect a voltage meter across TP12 (VBUS) and TP31 (PGND), or across J1.
5. Turn on Load #1, set to constant voltage mode, and output to 2.5-V. Disable Load. Connect Load in series with a current meter (multimeter), ground side, to J4 (BAT and PGND) as shown in [Figure 2-1](#).
6. Connect one voltage meter across TP16 (BAT) and TP30 (PGND), or across J4-3 and J4-1 as shown in [Figure 2-1](#).
7. Connect one voltage meter across TP17 (SYS) and TP30 (PGND), or across J2-1 and J2-2 as shown in [Figure 2-1](#).
8. Connect one voltage meter across TP14 (VPB) and TP32 (PGND), or across J3-1 and J3-2 as shown in [Figure 2-1](#).
9. Connect the EV2300/2400 USB interface board to the computer with a USB cable and from I2C port to J5 with the 4-pin cable. The connections are shown in [Figure 2-1](#).
10. Install shunts as shown in [Table 1-3](#).

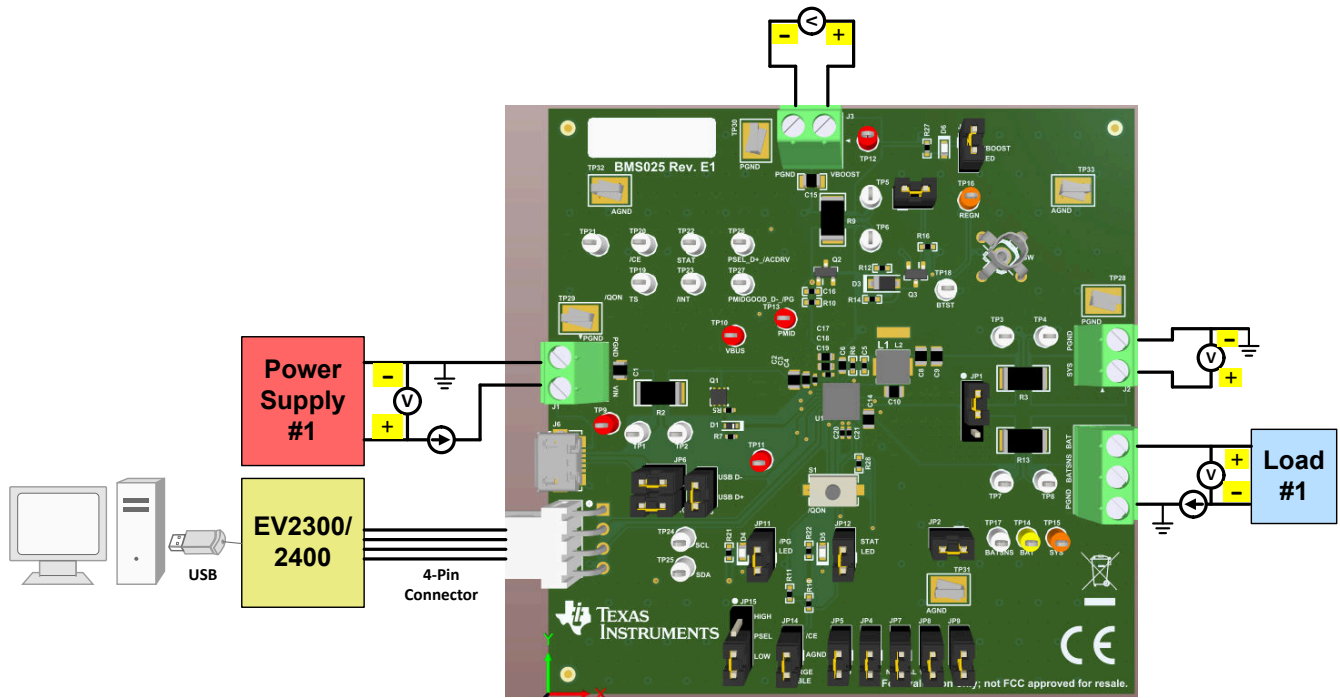

Figure 2-1. Original Test Setup for BMS025A

2.3 Software Setup

Use the following to set up the EVM testing software:

1. On the computer connected to the EV2300/2400 interface board, launch Battery Management Studio (BQStudio). Select Charger as seen in Figure 2-2.
2. Select the appropriate configuration file based on the device from the window shown in Figure 2-3.

3. Choose **Field View**, on the window that appears, and the main window of the BQ2561X EVM software will appear, as shown in Figure 2-4.

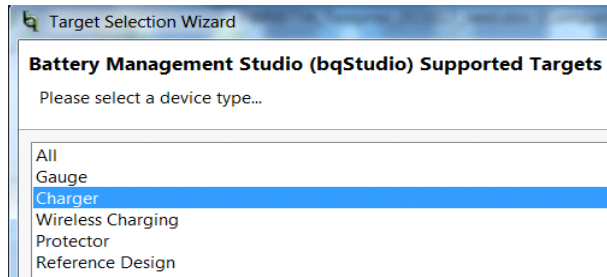

Figure 2-2. BQStudio Device Type Selection Window

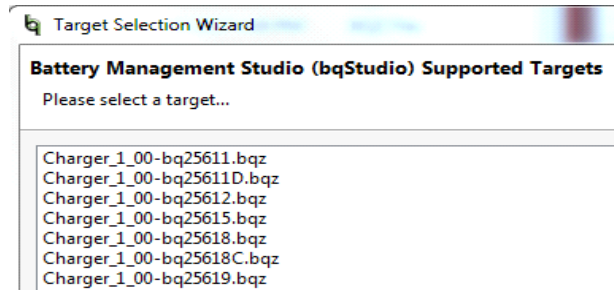

Figure 2-3. BQStudio Charger Selection Window

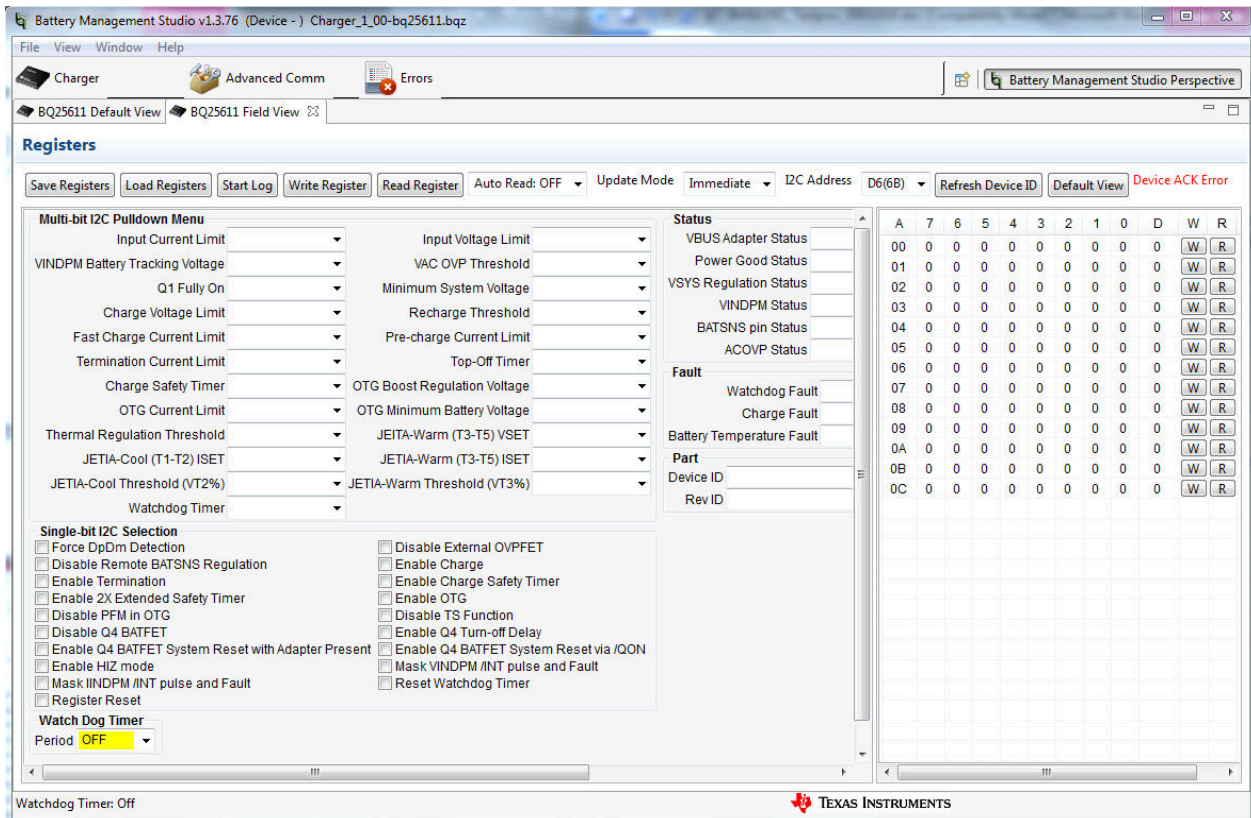

Figure 2-4. Main Window of BQ2561x EVM Software

2.4 Test Procedure

2.4.1 Initial Settings

Use the following steps for enable the EVM test setup:

1. Make sure [Equipment Setup](#) steps have been followed.
2. Launch the **BQ2561X** EVM GUI software, if not already done.
3. Turn on PS1:
 - **Measure** → V_{sys} (SYS-TP17 and PGND-TP30) = 4.20V ±0.3V

Note

Completely dsconnect Load #1 from BATTERY connections if different value is seen.

2.4.2 Communication Verification



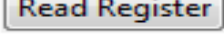



Use the following steps for communication verification:

1. In the EVM software, click the  button
 - Verify that the GUI reads **Device ACK OK** in the top right corner.

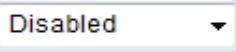
Note

If the device reads **Device ACK Error** verify [Section 2.2](#) and [Section 2.4.1](#) steps have been followed.

2. In the Field View (see [Figure 2-4](#)), make the following changes as necessary:

- Set **Watchdog Timer** 
- Set **Input Voltage Limit** 
- Set **Input Current Limit** 
- Set **Charge Voltage Limit** 
- Set **Fast Charge Current Limit** 
- Set **Pre-charge Current Limit** 
- Set **Minimum System Voltage** 
- Check **Enable Charge**
- Uncheck **Enable Termination**

2.4.3 Charger Mode Verification

Use the following steps for charger mode verification:

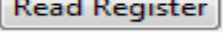
1. PS1 should be on from [Section 2.4.1](#). In the EVM software, click  **twice**.
 - Verify that all Fault statuses read "Normal"

Fault	
Watchdog Fault	Normal
Charge Fault	Normal
Battery Temperature Fault	Normal
Boost Fault	Normal
Battery Fault	Normal

- **Verify** → STAT LED (D5) is **ON**
2. Enable Load #1 (see [Section 2.2](#)) and take measurements as follows:

- **Measure** → V_{SYS} (SYS-TP17 and PGND-TP30) = $3.65\text{V} \pm 0.3\text{V}$
 - **Measure** → V_{BAT} (BATTERY-TP16 and PGND-TP30) = $2.5\text{V} \pm 0.2\text{V}$
 - **Measure** → $I_{\text{BAT}} = 240\text{mA} \pm 50\text{mA}$
3. Change Load #1 to 3.7V and take measurements as follows:
- **Measure** → V_{SYS} (SYS-TP17 and PGND-TP30) = $3.8\text{V} \pm 0.3\text{V}$
 - **Measure** → V_{BAT} (BATTERY-TP16 and PGND-TP30) = $3.7\text{V} \pm 0.2\text{V}$
 - **Measure** → $I_{\text{BAT}} = 480\text{mA} \pm 200\text{mA}$
4. In the EVM software, set
- **Measure** → $I_{\text{IN}} = 500\text{mA} \pm 200\text{mA}$

2.4.4 Boost Mode Verification

Use the following steps for boost mode verification:

1. Turn off and disconnect PS1.
2. Set Load #1 to 3.7V and 2A current limit.

Note

If Load #1 connected from BATTERY-J4(3) to PGND-J4(1) is not a four quadrant supply, remove Load #1 and use PS1 (disconnected in 8.4.1), set to 3.7V, 2A current limit and connect to BATTERY-J4(3) to PGND-J4(1).

3. In the EVM software, check Enable OTG .
4. Connect Load #2
 - For BQ25619 (BMS025-005): across VPB-J3(1) and PGND-J3(2).
 - For all others: across VIN-J1(2) and PGND-J1(1).
 - For BQ25619, measure VPB (VPB-TP14 and PGND-TP32) = 5.0V \pm 0.2V.
 - For all others, measure VBUS (VBUS-TP12 and PGND-TP31) = 5.0V \pm 0.2V.
5. Turn off and disconnect power supply.
6. Remove Load #2 from connection.

2.4.5 Evaluation Results

This section contains efficiency data for both Charger Mode and Boost Mode, specifically on the BQ25619EVM.

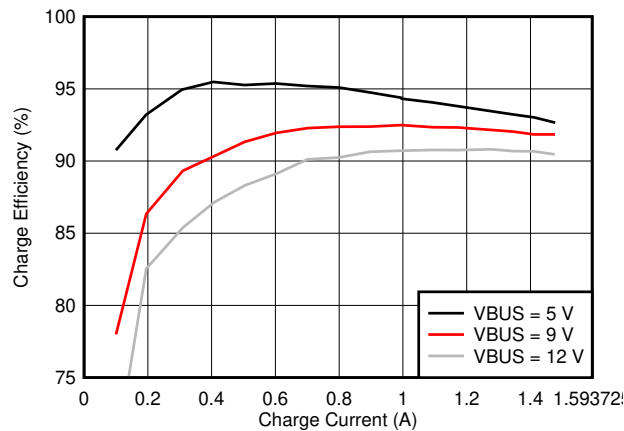

Figure 2-5. BQ25619EVM Charge Mode Efficiency

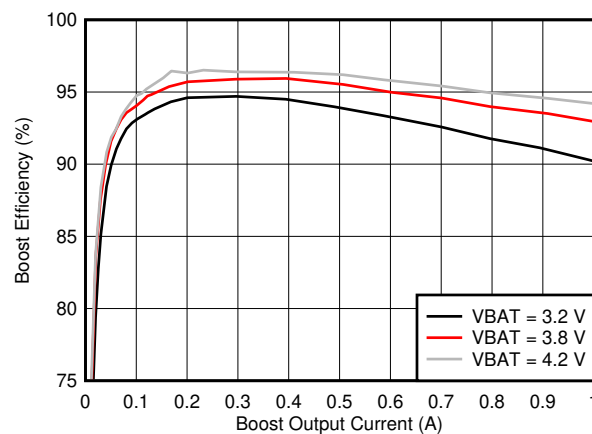

Figure 2-6. BQ25619EVM Boost Mode Efficiency

2.4.6 Helpful Tips

1. The leads and cables to the various power supplies, batteries and loads have resistance. The current meters also have series resistance. The charger dynamically reduces charge current depending on the voltage sensed at its VAC/VBUS pin (using the VINDPM feature), BAT pin (as part of normal termination), and TS pin (through its battery temperature monitoring feature via battery thermistor). Therefore, voltmeters must be used to measure the voltage as close to the IC pins as possible instead of relying on the digital readouts of the power supply. If a battery thermistor is not available, make sure shuntJP7 is in place.
2. When using a source meter that can source and sink current as your battery simulator, TI highly recommends adding a large (1000+ μF) capacitor at the EVM BATTERY and GND connectors in order to prevent oscillations at the BAT pin due to mismatched impedances of the charger output and source meter input within their respective regulation loop bandwidths. Configuring the source meter for 4-wire sensing eliminates the need for a separate voltmeter to measure the voltage at the BAT pin.
When using 4-wire sensing, always ensure that the sensing leads are connected in order to prevent accidental overvoltage by the power leads.
3. For precise measurements of input and output currents, especially battery charging current regulation near termination, the current meter in series with the battery or battery simulator should not be set to auto-range and may need be removed entirely. An alternate method for measuring charge current is to either use an oscilloscope with hall effect current probe or by a differential voltage measurement across the relevant sensing resistors populated on the BMS025 EVM.

3 PCB Layout Guideline

Minimize the switching node rise and fall times for minimum switching loss. Proper layout of the components minimizing high-frequency current path loop is important to prevent electrical and magnetic field radiation and high-frequency resonant problems. This PCB layout priority list must be followed in the order presented for proper layout:

1. Place the input capacitor as close as possible to the PMID pin and GND pin connections and use the shortest copper trace connection or GND plane.
2. Place the inductor input terminal as close to the SW pin as possible. Minimize the copper area of this trace to lower electrical and magnetic field radiation but make the trace wide enough to carry the charging current. Do not use multiple layers in parallel for this connection. Minimize parasitic capacitance from this area to any other trace or plane.
3. Put an output capacitor near to the inductor and the IC. Tie ground connections to the IC ground with a short copper trace connection or GND plane.
4. Route analog ground separately from power ground. Connect analog ground and connect power ground separately. Connect analog ground and power ground together using power pad as the single ground connection point or use a 0- Ω resistor to tie analog ground to power ground.
5. Use a single ground connection to tie the charger power ground to the charger analog ground just beneath the IC. Use ground copper pour but avoid power pins to reduce inductive and capacitive noise coupling.
6. Place decoupling capacitors next to the IC pins and make the trace connection as short as possible.
7. It is critical that the exposed power pad on the backside of the IC package be soldered to the PCB ground. Ensure that there are sufficient thermal vias directly under the IC connecting to the ground plane on the other layers.
8. The via size and number should be enough for a given current path.

See the EVM design for the recommended component placement with trace and via locations. For the QFN information, refer to [Quad Flatpack No-Lead Logic Packages Application Report](#) and [QFN and SON PCB Attachment Application Report](#).

4 Board Layout, Schematic, and Bill of Materials

4.1 Board Layout

Figure 4-1 through Figure 4-8 illustrate the PCB board layouts.

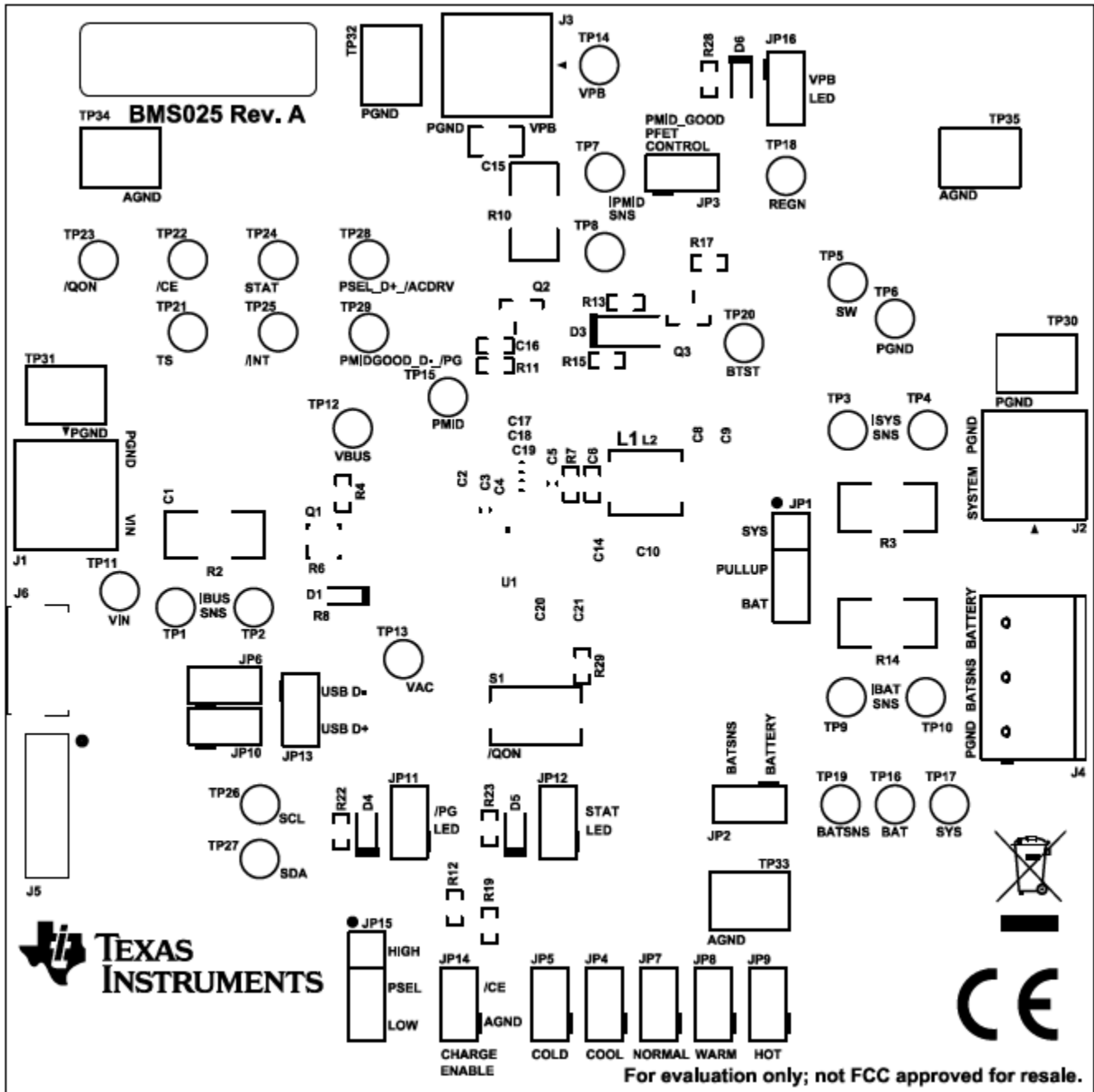

Figure 4-1. BMS025 Rev. A Top Overlay

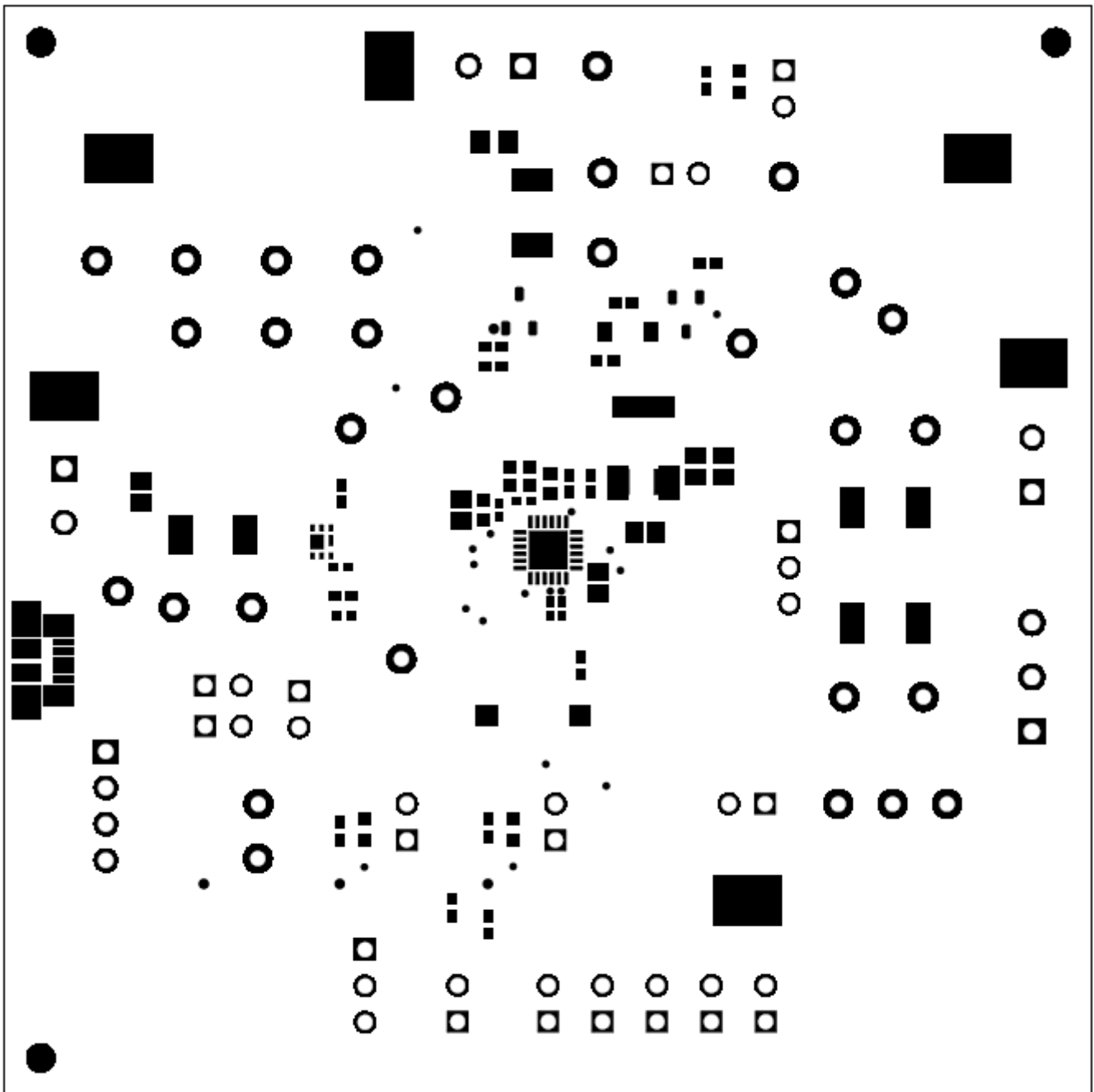

Figure 4-2. BMS025 Rev. A Top Solder Mask

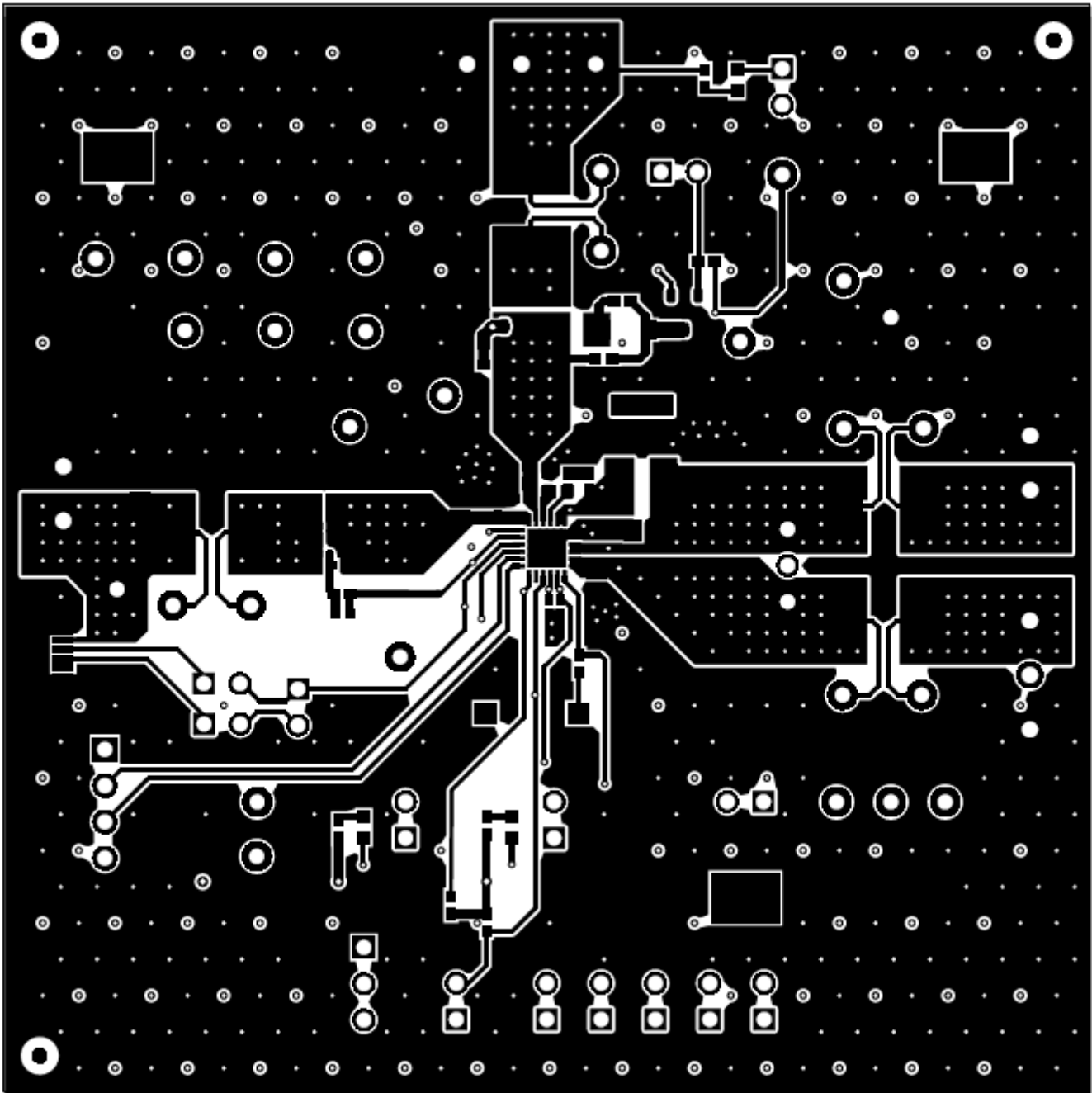

Figure 4-3. BMS025 Rev. A Top Layer

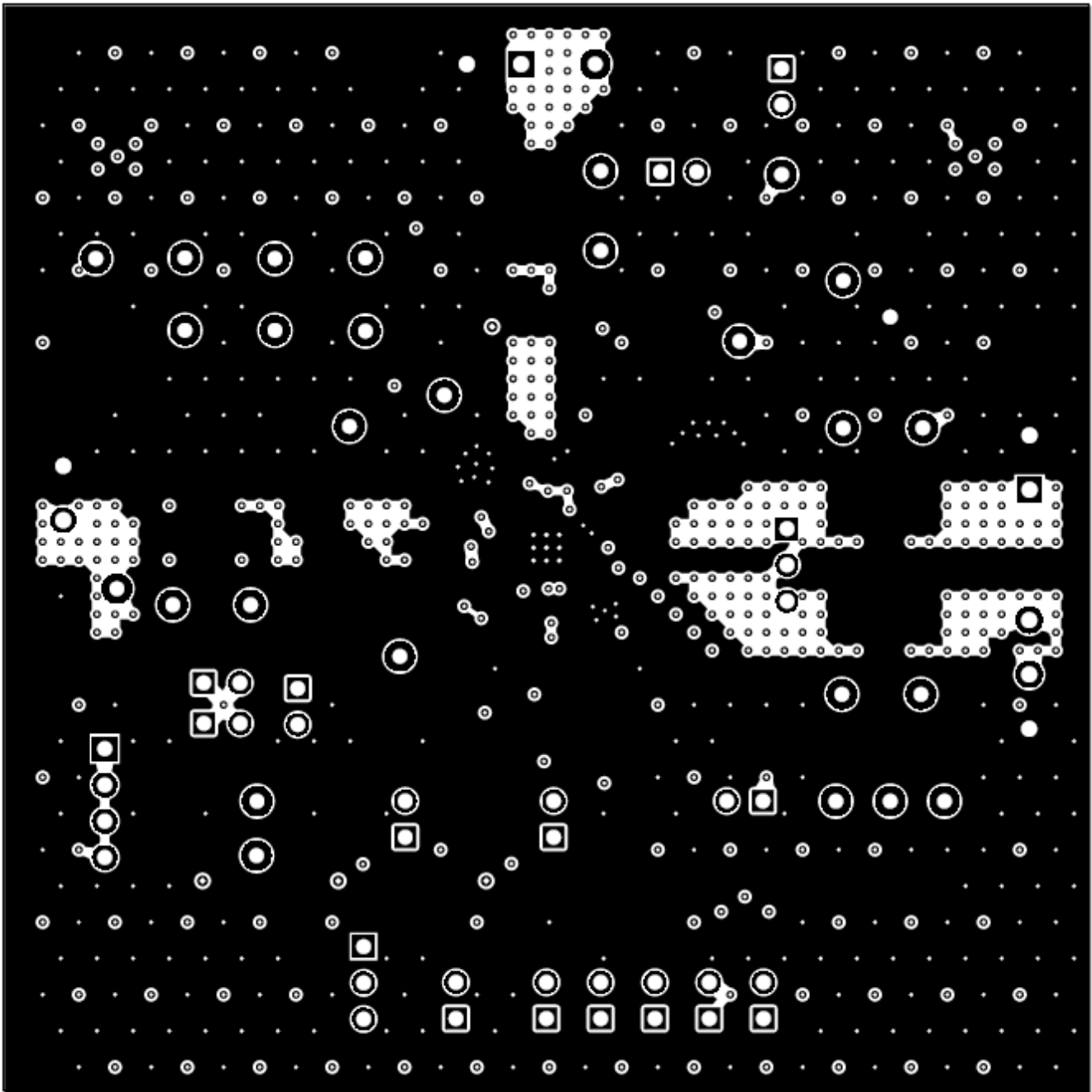

Figure 4-4. BMS025 Rev. A MidLayer 1

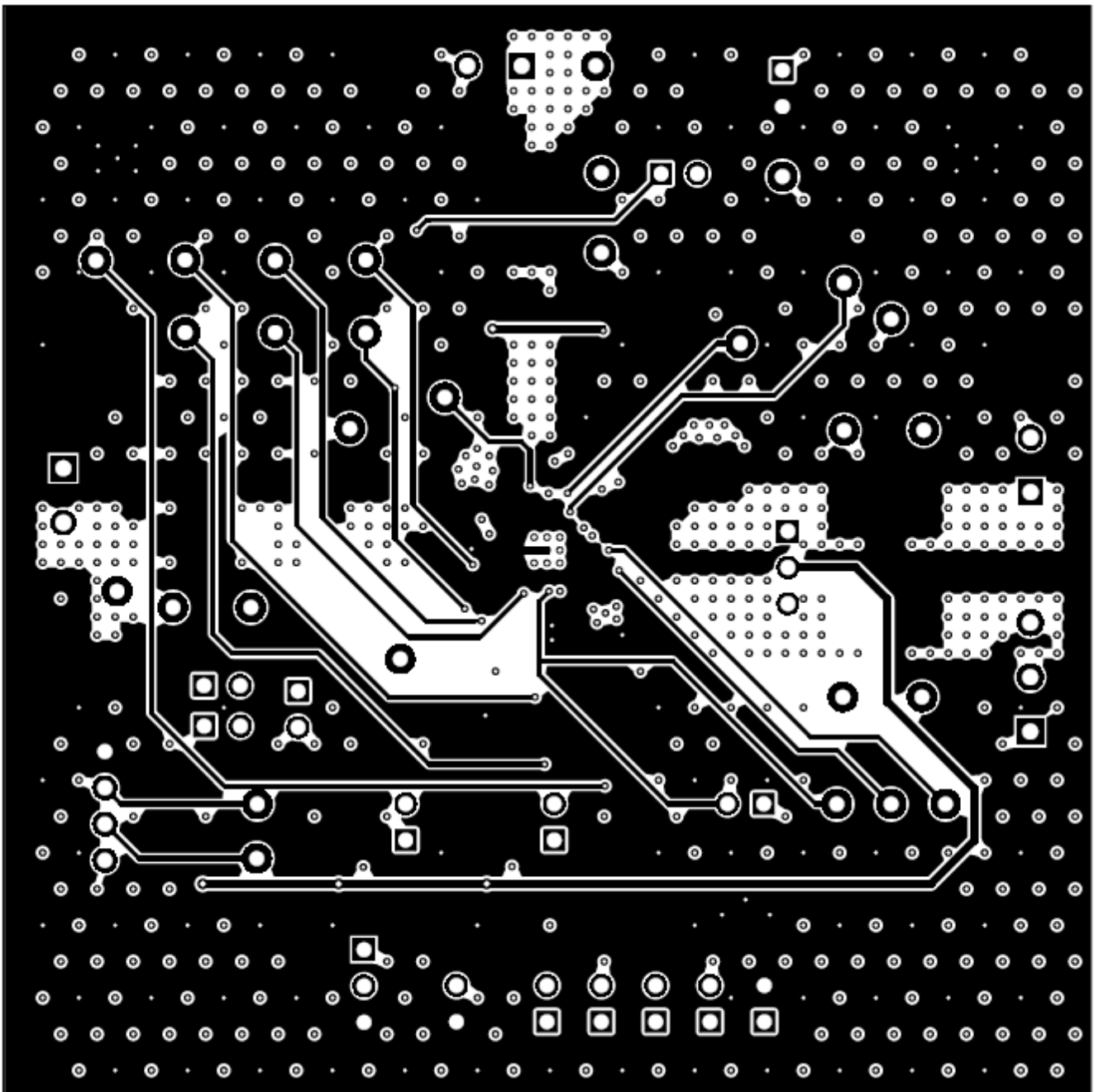

Figure 4-5. BMS025 Rev. A MidLayer 2

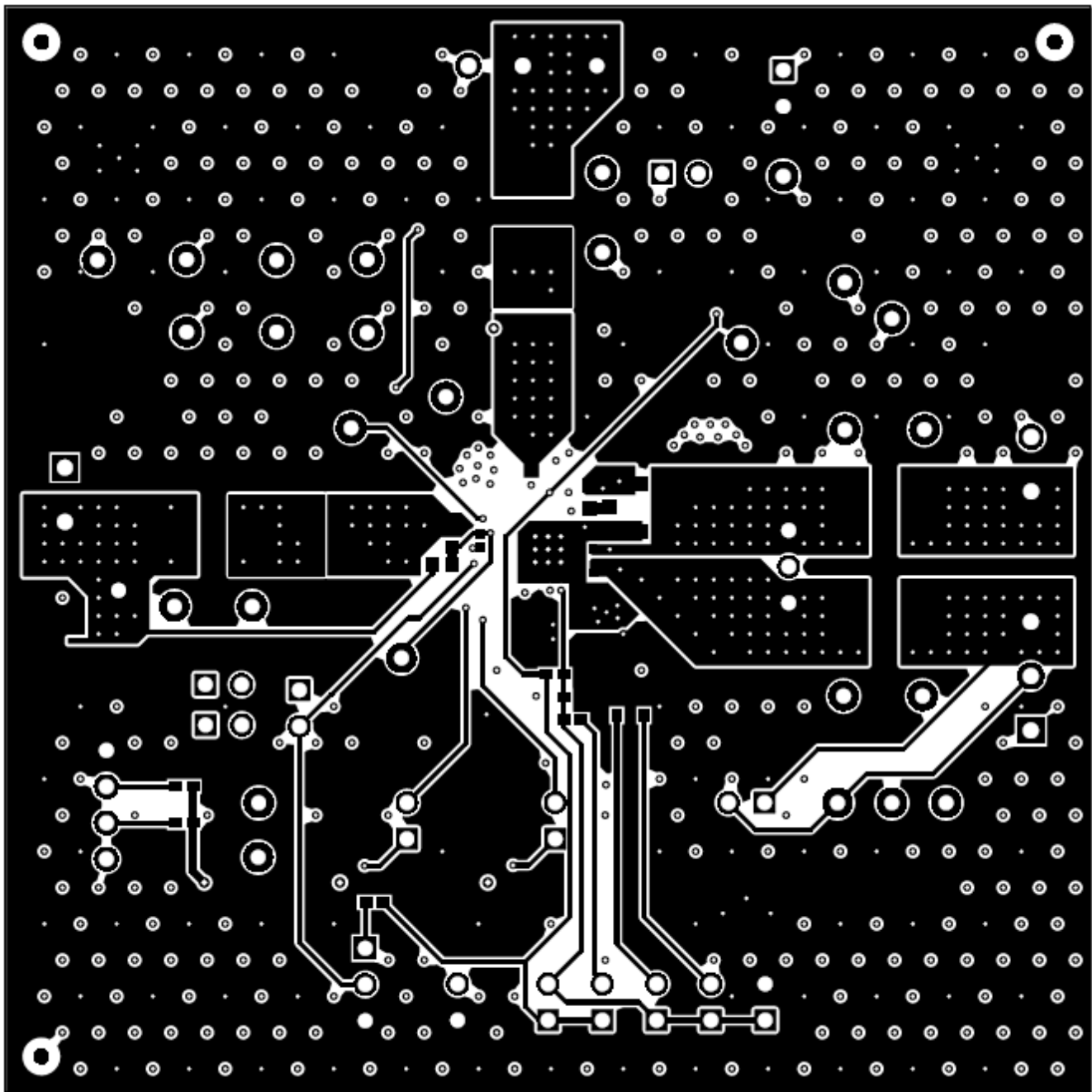

Figure 4-6. BMS025 Rev. A Bottom Layer

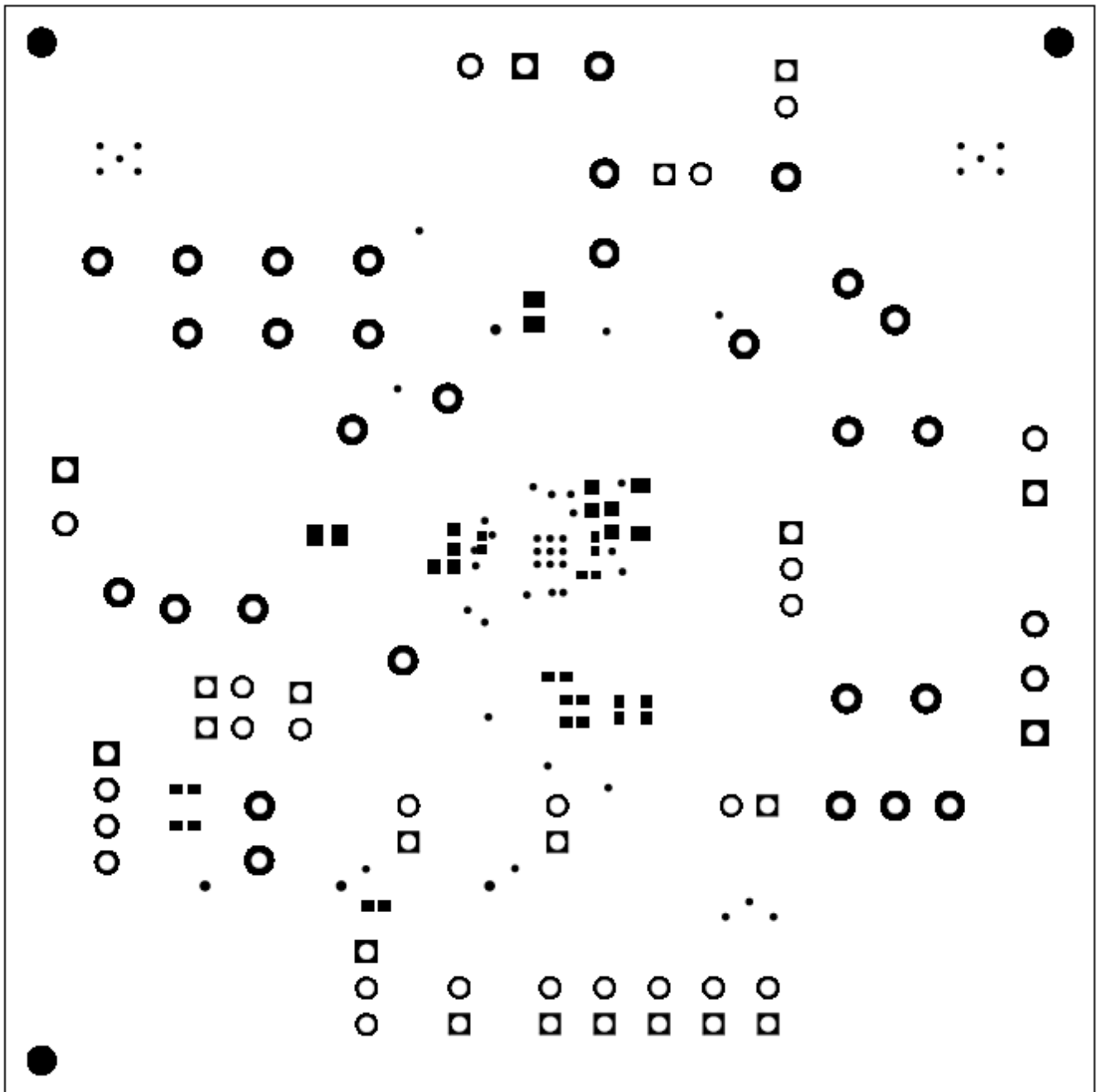

Figure 4-7. BMS025 Rev. A Bottom Solder Mask

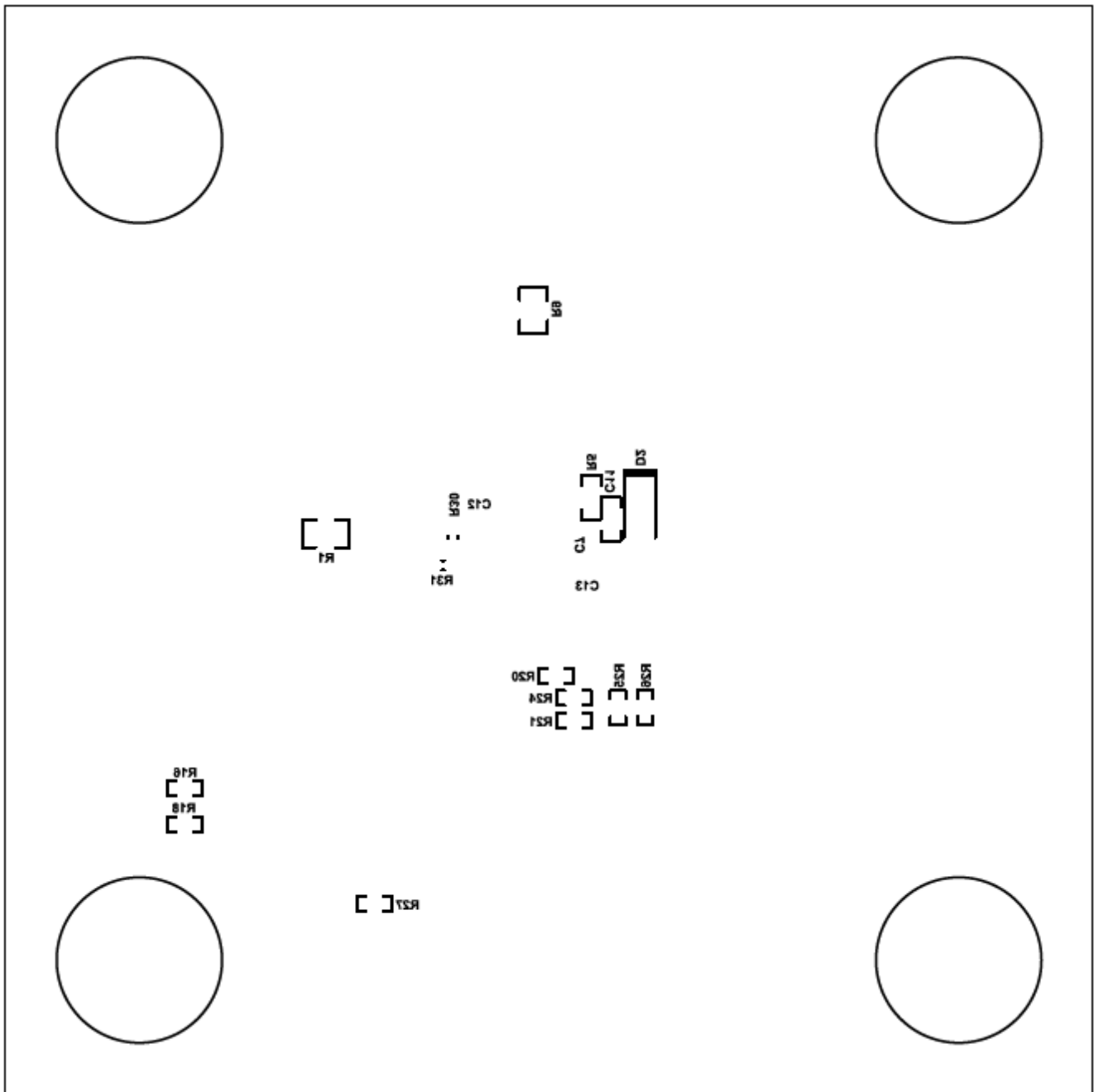

Figure 4-8. BMS025 Rev. A Bottom Overlay

4.2 Schematics

Figure 4-9 illustrates the schematic for this BQ25619EVM.

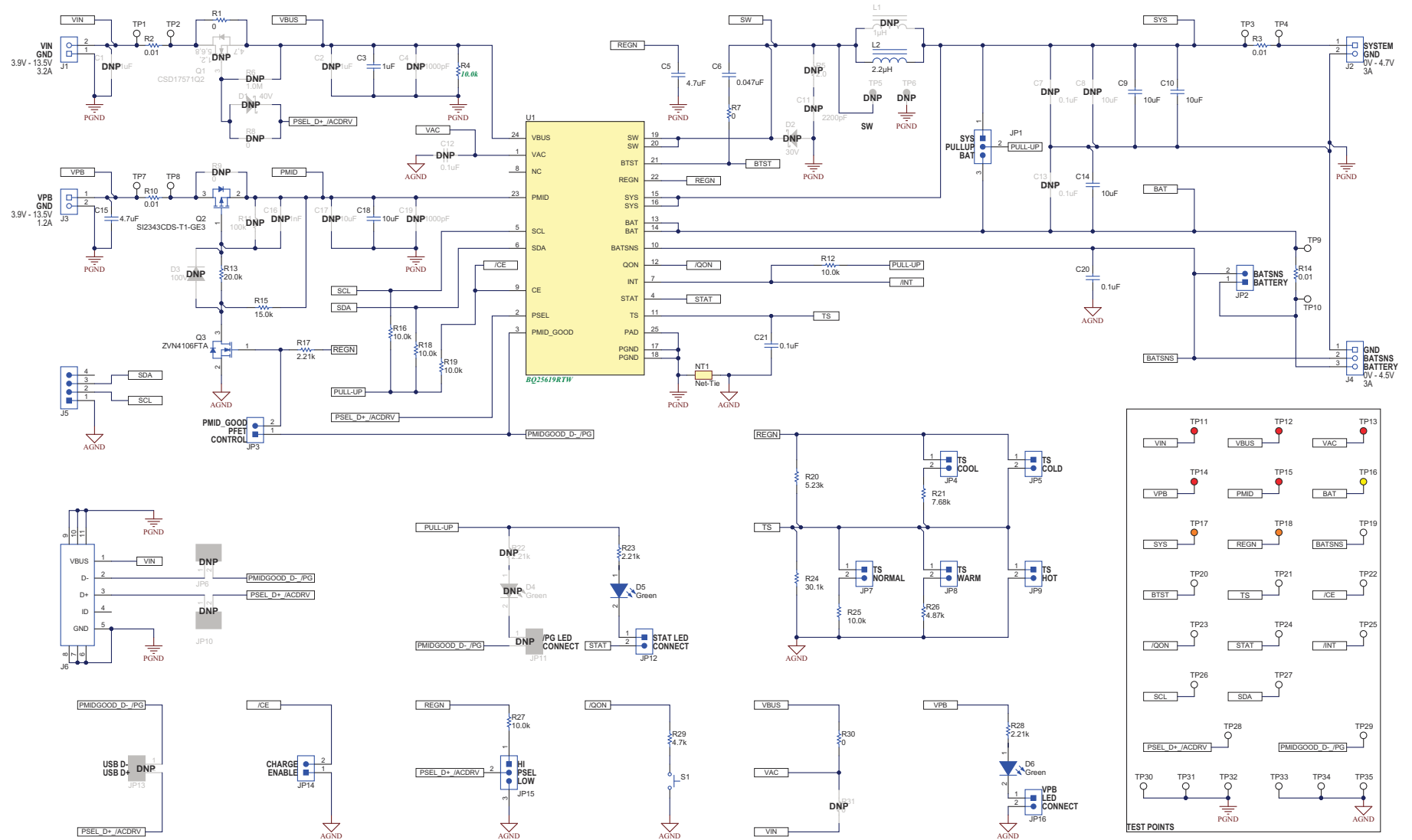

Figure 4-9. BQ25619EVM Schematic

Figure 4-10 illustrates the schematic for this BQ25611DEVM.

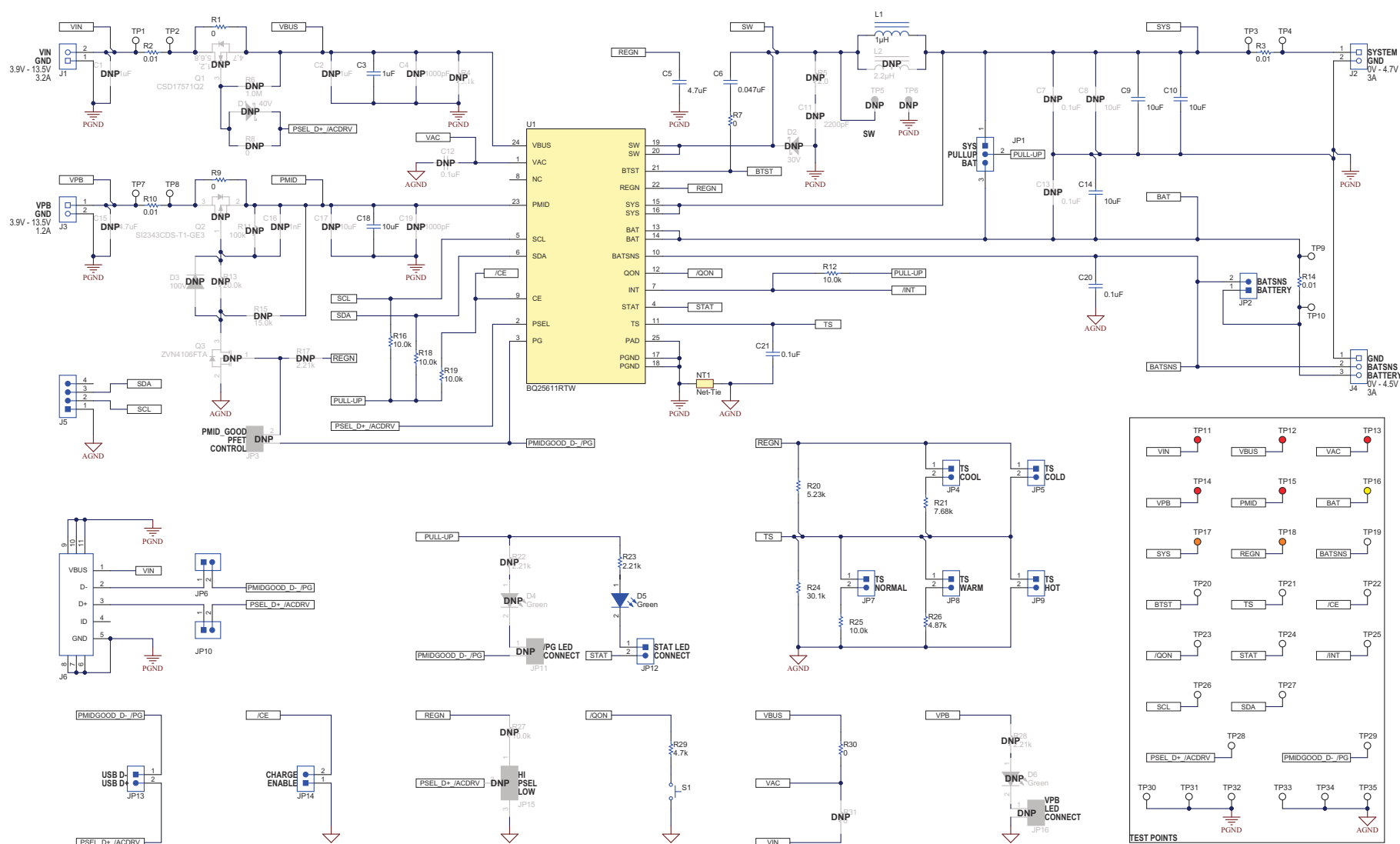

Figure 4-10. BQ25611DEVM Schematic

4.3 Bill of Materials

Table 4-1 lists the BQ25619EVM BOM.

Table 4-1. BQ25619EVM Bill of Materials

Designator	Quantity	Value	Description	PackageReference	PartNumber	Manufacturer	Alternate PartNumber ⁽¹⁾	Alternate Manufacturer ⁽¹⁾
IPCB1	1		Printed Circuit Board		BMS025	Any		
C3	1	1 μ F	CAP, CERM, 1 μ F, 35 V, \pm 10%, X5R, 0603	603	GMK107BJ105KA-T	Taiyo Yuden		
C5	1	4.7 μ F	CAP, CERM, 4.7 μ F, 16 V, \pm 10%, X5R, 0603	603	GRM188R61C475KAAJ	MuRata		
C6	1	0.047 μ F	CAP, CERM, 0.047 μ F, 25 V, \pm 10%, X7R, 0402	402	GRM155R71E473KA88D	MuRata		
C9, C10, C14	3	10 μ F	CAP, CERM, 10 μ F, 10 V, \pm 10%, X7R, 0805	805	GRM21BR71A106KE51L	MuRata		
C15	1	4.7 μ F	CAP, CERM, 4.7 μ F, 25 V, \pm 10%, X5R, 0805	805	C0805C475K3PACTU	Kemet		
C18	1	10 μ F	CAP, CERM, 10 μ F, 25 V, \pm 20%, X5R, 0603	603	GRT188R61E106ME13D	MuRata		
C20, C21	2	0.1 μ F	CAP, CERM, 0.1 μ F, 25 V, \pm 10%, X5R, 0402	402	GRM155R61E104KA87D	MuRata		
D5, D6	2	Green	LED, Green, SMD	1.6x0.8x0.8mm	LTST-C190GKT	Lite-On		
H1, H2, H3, H4	4		Bumpon, Hemisphere, 0.44 X 0.20, Clear	Transparent Bumpon	SJ-5303 (CLEAR)	3M		
J1, J2, J3	3		Conn Term Block, 2POS, 3.81mm, TH	2POS Terminal Block	1727010	Phoenix Contact		
J4	1		Terminal Block Receptacle, 3x1, 3.81mm, R/A, TH	Term Block, 3 pos	1727023	Phoenix Contact		
J5	1		Header (friction lock), 100mil, 4x1, R/A, TH	4x1 R/A Header	22/05/3041	Molex		
J6	1		Connector, Receptacle, Micro-USB Type B, R/A, Bottom Mount SMT	7.5x2.45x5mm	473460001	Molex		
JP1, JP15	2		Header, 100mil, 3x1, Tin, TH	Header, 3 PIN, 100mil, Tin	PEC03SAAN	Sullins Connector Solutions		
JP2, JP3, JP4, JP5, JP7, JP8, JP9, JP12, JP14, JP16	10		Header, 100mil, 2x1, Tin, TH	Header, 2 PIN, 100mil, Tin	PEC02SAAN	Sullins Connector Solutions		
L2	1	2.2 μ H	Inductor, 2.2 μ H, 3 A, 0.04 Ω , SMD	3.5x3.2mm	MAPM0320F-2R2M10-LF	Microgate		

Table 4-1. BQ25619EVM Bill of Materials (continued)

Designator	Quantity	Value	Description	PackageReference	PartNumber	Manufacturer	Alternate PartNumber ⁽¹⁾	Alternate Manufacturer ⁽¹⁾
LBL1	1		Thermal Transfer Printable Labels, 0.650" W x 0.200" H - 10,000 per roll	PCB Label 0.650 x 0.200 inch	THT-14-423-10	Brady		
Q2	1	-30V	MOSFET, P-CH, -30 V, -5.9 A, SOT-23	SOT-23	SI2343CDS-T1-GE3	Vishay-Siliconix		None
Q3	1	60V	MOSFET, N-CH, 60 V, 0.2 A, AEC-Q101, SOT-23	SOT-23	ZVN4106FTA	Diodes Inc.		None
R1	1	0	RES, 0, 1%, 0.5 W, 0805	805	5106	Keystone		
R2, R3, R10, R14	4	0.01	RES, 0.01, 1%, 1 W, 2010	2010	WSL2010R0100FEA18	Vishay-Dale		
R4	1	10.0k	RES, 10.0 k, .1%, .0625 W, 0402	402	RT0402BRD0710KL	Yageo America		
R7	1	0	RES, 0, 5%, 0.063 W, AEC-Q200 Grade 0, 0402	402	CRCW04020000Z0ED	Vishay-Dale		
R12, R16, R18, R19, R25, R27	6	10.0k	RES, 10.0 k, 1%, 0.063 W, AEC-Q200 Grade 0, 0402	402	CRCW040210K0FKED	Vishay-Dale		
R13	1	20.0k	RES, 20.0 k, 1%, 0.063 W, AEC-Q200 Grade 0, 0402	402	CRCW040220K0FKED	Vishay-Dale		
R15	1	15.0k	RES, 15.0 k, 1%, 0.063 W, AEC-Q200 Grade 0, 0402	402	CRCW040215K0FKED	Vishay-Dale		
R17, R23, R28	3	2.21k	RES, 2.21 k, 1%, 0.063 W, AEC-Q200 Grade 0, 0402	402	CRCW04022K21FKED	Vishay-Dale		
R20	1	5.23k	RES, 5.23 k, 1%, 0.063 W, AEC-Q200 Grade 0, 0402	402	CRCW04025K23FKED	Vishay-Dale		
R21	1	7.68k	RES, 7.68 k, 1%, 0.063 W, AEC-Q200 Grade 0, 0402	402	CRCW04027K68FKED	Vishay-Dale		
R24	1	30.1k	RES, 30.1 k, 1%, 0.063 W, AEC-Q200 Grade 0, 0402	402	CRCW040230K1FKED	Vishay-Dale		
R26	1	4.87k	RES, 4.87 k, 1%, 0.063 W, AEC-Q200 Grade 0, 0402	402	CRCW04024K87FKED	Vishay-Dale		
R29	1	4.7k	RES, 4.7 k, 5%, 0.063 W, AEC-Q200 Grade 0, 0402	402	CRCW04024K70JNED	Vishay-Dale		
R30	1	0	RES, 0, 5%, 0.1 W, AEC-Q200 Grade 0, 0603	603	CRCW06030000Z0EA	Vishay-Dale		
S1	1		Switch, Normally open, 2.3N force, 200k operations, SMD	KSR	KSR221GLFS	C&K Components		

Table 4-1. BQ25619EVM Bill of Materials (continued)

Designator	Quantity	Value	Description	PackageReference	PartNumber	Manufacturer	Alternate PartNumber ⁽¹⁾	Alternate Manufacturer ⁽¹⁾
SH-JP1, SH-JP2, SH-JP3, SH-JP7, SH-JP12, SH-JP14, SH-JP15, SH-JP16	8	1x2	Shunt, 100mil, Gold plated, Black	Shunt	SNT-100-BK-G	Samtec	969102-0000-DA	3M
TP1, TP2, TP3, TP4, TP7, TP8, TP9, TP10, TP19, TP20, TP21, TP22, TP23, TP24, TP25, TP26, TP27, TP28, TP29	19		Test Point, Miniature, White, TH	White Miniature Testpoint	5002	Keystone		
TP11, TP12, TP13, TP14, TP15	5		Test Point, Miniature, Red, TH	Red Miniature Testpoint	5000	Keystone		
TP16	1		Test Point, Miniature, Yellow, TH	Yellow Miniature Testpoint	5004	Keystone		
TP17, TP18	2		Test Point, Miniature, Orange, TH	Orange Miniature Testpoint	5003	Keystone		
TP30, TP31, TP32, TP33, TP34, TP35	6		Test Point, Compact, SMT	Testpoint_Keystone_Compact	5016	Keystone		
U1	1		BQ25619RTW, RTW0024P (PVQFN-24)	RTW0024P	BQ25619RTW	Texas Instruments		Texas Instruments
C1, C2	0	1 μ F	CAP, CERM, 1 μ F, 25 V, \pm 10%, X7R, 0805	805	GRM219R71E105KA88D	MuRata		
C4, C19	0	1000pF	CAP, CERM, 1000 pF, 50 V, \pm 5%, C0G/NP0, 0402	402	GRM1555C1H102JA01D	MuRata		
C7, C12, C13	0	0.1 μ F	CAP, CERM, 0.1 μ F, 25 V, \pm 10%, X5R, 0402	402	GRM155R61E104KA87D	MuRata		
C8	0	10 μ F	CAP, CERM, 10 μ F, 10 V, \pm 10%, X7R, 0805	805	GRM21BR71A106KE51L	MuRata		
C11	0	2200pF	CAP, CERM, 2200 pF, 50 V, \pm 5%, C0G/NP0, 0603	603	GRM1885C1H222JA01D	MuRata		
C16	0	1000pF	CAP, CERM, 1000 pF, 50 V, \pm 1%, C0G/NP0, 0402	402	GRM1555C1H102FA01D	MuRata		

Table 4-1. BQ25619EVM Bill of Materials (continued)

Designator	Quantity	Value	Description	PackageReference	PartNumber	Manufacturer	Alternate PartNumber ⁽¹⁾	Alternate Manufacturer ⁽¹⁾
C17	0	10 μ F	CAP, CERM, 10 μ F, 25 V, \pm 20%, X5R, 0603	603	GRT188R61E106ME13D	MuRata		
D1	0	40V	Diode, Schottky, 40 V, 0.38 A, SOD-523	SOD-523	ZLLS350TA	Diodes Inc.		
D2	0	30V	Diode, Schottky, 30 V, 1 A, SOD-123	SOD-123	B130LAW-7-F	Diodes Inc.		
D3	0	100V	Diode, Ultrafast, 100 V, 0.15 A, SOD-123	SOD-123	1N4148W-7-F	Diodes Inc.		
D4	0	Green	LED, Green, SMD	1.6x0.8x0.8mm	LTST-C190GKT	Lite-On		
FID1, FID2, FID3, FID4, FID5, FID6	0		Fiducial mark. There is nothing to buy or mount.	N/A	N/A	N/A		
JP6, JP10, JP11, JP13	0		Header, 100mil, 2x1, Tin, TH	Header, 2 PIN, 100mil, Tin	PEC02SAAN	Sullins Connector Solutions		
L1	0	1 μ H	Inductor, 1 μ H, 3.2 A, 0.025 Ω , SMD	4.9x4.4mm	MAPM0410F-1R0M-LF	Microgate		
Q1	0	30V	MOSFET, N-CH, 30 V, 22 A, DQK0006C (WSON-6)	DQK0006C	CSD17571Q2	Texas Instruments		None
R5	0	2	RES, 2.0, 5%, 0.1 W, AEC-Q200 Grade 0, 0603	603	CRCW06032R00JNEA	Vishay-Dale		
R6	0	1.0Meg	RES, 1.0 M, 5%, 0.063 W, AEC-Q200 Grade 0, 0402	402	CRCW04021M00JNED	Vishay-Dale		
R8	0	0	RES, 0, 5%, 0.063 W, AEC-Q200 Grade 0, 0402	402	CRCW04020000Z0ED	Vishay-Dale		
R9	0	0	RES, 0, 1%, 0.5 W, 0805	805	5106	Keystone		
R11	0	100k	RES, 100 k, 1%, 0.0625 W, 0402	402	RC0402FR-07100KL	Yageo America		
R22	0	2.21k	RES, 2.21 k, 1%, 0.063 W, AEC-Q200 Grade 0, 0402	402	CRCW04022K21FKED	Vishay-Dale		
R31	0	0	RES, 0, 5%, 0.1 W, AEC-Q200 Grade 0, 0603	603	CRCW06030000Z0EA	Vishay-Dale		
SH-JP4, SH-JP5, SH-JP6, SH-JP8, SH-JP9, SH-JP10, SH-JP11, SH-JP13	0	1x2	Shunt, 100mil, Gold plated, Black	Shunt	SNT-100-BK-G	Samtec	969102-0000-DA	3M
TP5, TP6	0		Test Point, Miniature, White, TH	White Miniature Testpoint	5002	Keystone		

(1) Unless otherwise noted in the Alternate PartNumber and/or Alternate Manufacturer columns, all parts may be substituted with equivalents.

Table 4-2 lists the BQ25611DEVM BOM.

Table 4-2. BQ25611DEVM Bill of Materials

Designator	Quantity	Value	Description	PackageReference	PartNumber	Manufacturer	Alternate PartNumber ⁽¹⁾	Alternate Manufacturer ⁽¹⁾
IPCB1	1		Printed Circuit Board		BMS025	Any		
C3	1	1 μ F	CAP, CERM, 1 μ F, 35 V, \pm 10%, X5R, 0603	0603	GMK107BJ105KA-T	Taiyo Yuden		
C5	1	4.7 μ F	CAP, CERM, 4.7 μ F, 16 V, \pm 10%, X5R, 0603	0603	GRM188R61C475KAAJD	MuRata		
C6	1	0.047 μ F	CAP, CERM, 0.047 μ F, 25 V, \pm 10%, X7R, 0402	0402	GRM155R71E473KA88D	MuRata		
C9, C10, C14	3	10 μ F	CAP, CERM, 10 μ F, 10 V, \pm 10%, X7R, 0805	0805	GRM21BR71A106KE51L	MuRata		
C18	1	10 μ F	CAP, CERM, 10 μ F, 25 V, \pm 20%, X5R, 0603	0603	GRT188R61E106ME13D	MuRata		
C20, C21	2	0.1 μ F	CAP, CERM, 0.1 μ F, 25 V, \pm 10%, X5R, 0402	0402	GRM155R61E104KA87D	MuRata		
D5	1	Green	LED, Green, SMD	1.6x0.8x0.8mm	LTST-C190GKT	Lite-On		
H1, H2, H3, H4	4		Bumpon, Hemisphere, 0.44 X 0.20, Clear	Transparent Bumpon	SJ-5303 (CLEAR)	3M		
J1, J2, J3	3		Conn Term Block, 2POS, 3.81mm, TH	2POS Terminal Block	1727010	Phoenix Contact		
J4	1		Terminal Block Receptacle, 3x1, 3.81mm, R/A, TH	Term Block, 3 pos	1727023	Phoenix Contact		
J5	1		Header (friction lock), 100mil, 4x1, R/A, TH	4x1 R/A Header	0022053041	Molex		
J6	1		Connector, Receptacle, Micro-USB Type B, R/A, Bottom Mount SMT	7.5x2.45x5mm	0473460001	Molex		
JP1	1		Header, 100mil, 3x1, Tin, TH	Header, 3 PIN, 100mil, Tin	PEC03SAAN	Sullins Connector Solutions		
JP2, JP4, JP5, JP6, JP7, JP8, JP9, JP10, JP12, JP13, JP14	11		Header, 100mil, 2x1, Tin, TH	Header, 2 PIN, 100mil, Tin	PEC02SAAN	Sullins Connector Solutions		
L1	1	1 μ H	Inductor, 1 μ H, 6.5 A, 0.024 Ω , SMD	4.95x4.20mm	MPIA4020V2-1R0-R	Eaton		
LBL1	1		Thermal Transfer Printable Labels, 0.650" W x 0.200" H - 10,000 per roll	PCB Label 0.650 x 0.200 inch	THT-14-423-10	Brady		
R1, R9	2	0	RES, 0, 1%, 0.5 W, 0805	0805	5106	Keystone		
R2, R3, R10, R14	4	0.01	RES, 0.01, 1%, 1 W, 2010	2010	WSL2010R0100FEA18	Vishay-Dale		

Table 4-2. BQ25611DEVM Bill of Materials (continued)

Designator	Quantity	Value	Description	PackageReference	PartNumber	Manufacturer	Alternate PartNumber ⁽¹⁾	Alternate Manufacturer ⁽¹⁾
R7	1	0	RES, 0, 5%, 0.063 W, AEC-Q200 Grade 0, 0402	0402	CRCW04020000Z0ED	Vishay-Dale		
R12, R16, R18, R19, R25	5	10.0k	RES, 10.0 k, 1%, 0.063 W, AEC-Q200 Grade 0, 0402	0402	CRCW040210K0FKED	Vishay-Dale		
R20	1	5.23k	RES, 5.23 k, 1%, 0.063 W, AEC-Q200 Grade 0, 0402	0402	CRCW04025K23FKED	Vishay-Dale		
R21	1	7.68k	RES, 7.68 k, 1%, 0.063 W, AEC-Q200 Grade 0, 0402	0402	CRCW04027K68FKED	Vishay-Dale		
R23	1	2.21k	RES, 2.21 k, 1%, 0.063 W, AEC-Q200 Grade 0, 0402	0402	CRCW04022K21FKED	Vishay-Dale		
R24	1	30.1k	RES, 30.1 k, 1%, 0.063 W, AEC-Q200 Grade 0, 0402	0402	CRCW040230K1FKED	Vishay-Dale		
R26	1	4.87k	RES, 4.87 k, 1%, 0.063 W, AEC-Q200 Grade 0, 0402	0402	CRCW04024K87FKED	Vishay-Dale		
R29	1	4.7k	RES, 4.7 k, 5%, 0.063 W, AEC-Q200 Grade 0, 0402	0402	CRCW04024K70JNED	Vishay-Dale		
R30	1	0	RES, 0, 5%, 0.1 W, AEC-Q200 Grade 0, 0603	0603	CRCW06030000Z0EA	Vishay-Dale		
S1	1		Switch, Normally open, 2.3N force, 200k operations, SMD	KSR	KSR221GLFS	C&K Components		
SH-JP1, SH-JP2, SH-JP6, SH-JP7, SH-JP10, SH-JP12, SH-JP14	7	1x2	Shunt, 100mil, Gold plated, Black	Shunt	SNT-100-BK-G	Samtec	969102-0000-DA	3M
TP1, TP2, TP3, TP4, TP7, TP8, TP9, TP10, TP19, TP20, TP21, TP22, TP23, TP24, TP25, TP26, TP27, TP28, TP29	19		Test Point, Miniature, White, TH	White Miniature Testpoint	5002	Keystone		
TP11, TP12, TP13, TP14, TP15	5		Test Point, Miniature, Red, TH	Red Miniature Testpoint	5000	Keystone		
TP16	1		Test Point, Miniature, Yellow, TH	Yellow Miniature Testpoint	5004	Keystone		

Table 4-2. BQ25611DEVM Bill of Materials (continued)

Designator	Quantity	Value	Description	PackageReference	PartNumber	Manufacturer	Alternate PartNumber ⁽¹⁾	Alternate Manufacturer ⁽¹⁾
TP17, TP18	2		Test Point, Miniature, Orange, TH	Orange Miniature Testpoint	5003	Keystone		
TP30, TP31, TP32, TP33, TP34, TP35	6		Test Point, Compact, SMT	Testpoint_Keystone_Compact	5016	Keystone		
U1	1		BQ25611DRTW, RTW0024P (PVQFN-24)	RTW0024P	BQ25611DRTW	Texas Instruments		Texas Instruments
C1, C2	0	1 μ F	CAP, CERM, 1 μ F, 25 V, \pm 10%, X7R, 0805	0805	GRM219R71E105KA88D	MuRata		
C4, C19	0	1000pF	CAP, CERM, 1000 pF, 50 V, \pm 5%, C0G/NP0, 0402	0402	GRM1555C1H102JA01D	MuRata		
C7, C12, C13	0	0.1 μ F	CAP, CERM, 0.1 μ F, 25 V, \pm 10%, X5R, 0402	0402	GRM155R61E104KA87D	MuRata		
C8	0	10 μ F	CAP, CERM, 10 μ F, 10 V, \pm 10%, X7R, 0805	0805	GRM21BR71A106KE51L	MuRata		
C11	0	2200pF	CAP, CERM, 2200 pF, 50 V, \pm 5%, C0G/NP0, 0603	0603	GRM1885C1H222JA01D	MuRata		
C15	0	4.7 μ F	CAP, CERM, 4.7 μ F, 25 V, \pm 10%, X5R, 0805	0805	C0805C475K3PACTU	Kemet		
C16	0	1000pF	CAP, CERM, 1000 pF, 50 V, \pm 1%, C0G/NP0, 0402	0402	GRM1555C1H102FA01D	MuRata		
C17	0	10 μ F	CAP, CERM, 10 μ F, 25 V, \pm 20%, X5R, 0603	0603	GRT188R61E106ME13D	MuRata		
D1	0	40V	Diode, Schottky, 40 V, 0.38 A, SOD-523	SOD-523	ZLLS350TA	Diodes Inc.		
D2	0	30V	Diode, Schottky, 30 V, 1 A, SOD-123	SOD-123	B130LAW-7-F	Diodes Inc.		
D3	0	100V	Diode, Ultrafast, 100 V, 0.15 A, SOD-123	SOD-123	1N4148W-7-F	Diodes Inc.		
D4, D6	0	Green	LED, Green, SMD	1.6x0.8x0.8mm	LTST-C190GKT	Lite-On		
FID1, FID2, FID3, FID4, FID5, FID6	0		Fiducial mark. There is nothing to buy or mount.	N/A	N/A	N/A		
JP3, JP11, JP16	0		Header, 100mil, 2x1, Tin, TH	Header, 2 PIN, 100mil, Tin	PEC02SAAN	Sullins Connector Solutions		
JP15	0		Header, 100mil, 3x1, Tin, TH	Header, 3 PIN, 100mil, Tin	PEC03SAAN	Sullins Connector Solutions		
L2	0	2.2 μ H	Inductor, 2.2 μ H, 3 A, 0.04 Ω , SMD	3.5x3.2mm	MAPM0320F-2R2M10-LF	Microgate		
Q1	0	30V	MOSFET, N-CH, 30 V, 22 A, DQK0006C (WSON-6)	DQK0006C	CSD17571Q2	Texas Instruments		None

Table 4-2. BQ25611DEVM Bill of Materials (continued)

Designator	Quantity	Value	Description	PackageReference	PartNumber	Manufacturer	Alternate PartNumber ⁽¹⁾	Alternate Manufacturer ⁽¹⁾
Q2	0	-30V	MOSFET, P-CH, -30 V, -5.9 A, SOT-23	SOT-23	SI2343CDS-T1-GE3	Vishay-Siliconix		None
Q3	0	60V	MOSFET, N-CH, 60 V, 0.2 A, AEC-Q101, SOT-23	SOT-23	ZVN4106FTA	Diodes Inc.		None
R4	0	5.1k	RES, 5.1 k, 5%, 0.063 W, AEC-Q200 Grade 0, 0402	0402	CRCW04025K10JNED	Vishay-Dale		
R5	0	2.0	RES, 2.0, 5%, 0.1 W, AEC-Q200 Grade 0, 0603	0603	CRCW06032R00JNEA	Vishay-Dale		
R6	0	1.0Meg	RES, 1.0 M, 5%, 0.063 W, AEC-Q200 Grade 0, 0402	0402	CRCW04021M00JNED	Vishay-Dale		
R8	0	0	RES, 0, 5%, 0.063 W, AEC-Q200 Grade 0, 0402	0402	CRCW04020000Z0ED	Vishay-Dale		
R11	0	100k	RES, 100 k, 1%, 0.0625 W, 0402	0402	RC0402FR-07100KL	Yageo America		
R13	0	20.0k	RES, 20.0 k, 1%, 0.063 W, AEC-Q200 Grade 0, 0402	0402	CRCW040220K0FKED	Vishay-Dale		
R15	0	15.0k	RES, 15.0 k, 1%, 0.063 W, AEC-Q200 Grade 0, 0402	0402	CRCW040215K0FKED	Vishay-Dale		
R17, R22, R28	0	2.21k	RES, 2.21 k, 1%, 0.063 W, AEC-Q200 Grade 0, 0402	0402	CRCW04022K21FKED	Vishay-Dale		
R27	0	10.0k	RES, 10.0 k, 1%, 0.063 W, AEC-Q200 Grade 0, 0402	0402	CRCW040210K0FKED	Vishay-Dale		
R31	0	0	RES, 0, 5%, 0.1 W, AEC-Q200 Grade 0, 0603	0603	CRCW06030000Z0EA	Vishay-Dale		
SH-JP3, SH-JP4, SH-JP5, SH-JP8, SH-JP9, SH-JP11, SH-JP13, SH-JP15, SH-JP16	0	1x2	Shunt, 100mil, Gold plated, Black	Shunt	SNT-100-BK-G	Samtec	969102-0000-DA	3M
TP5, TP6	0		Test Point, Miniature, White, TH	White Miniature Testpoint	5002	Keystone		

(1) Unless otherwise noted in the Alternate PartNumber and/or Alternate Manufacturer columns, all parts may be substituted with equivalents.

5 Revision History

NOTE: Page numbers for previous revisions may differ from page numbers in the current version.

Changes from Revision B (January 2020) to Revision C (July 2022)	Page
• Changed polarity for Power Supply #1 in Figure 2-1	5

STANDARD TERMS FOR EVALUATION MODULES

1. *Delivery:* TI delivers TI evaluation boards, kits, or modules, including any accompanying demonstration software, components, and/or documentation which may be provided together or separately (collectively, an "EVM" or "EVMs") to the User ("User") in accordance with the terms set forth herein. User's acceptance of the EVM is expressly subject to the following terms.
 - 1.1 EVMs are intended solely for product or software developers for use in a research and development setting to facilitate feasibility evaluation, experimentation, or scientific analysis of TI semiconductors products. EVMs have no direct function and are not finished products. EVMs shall not be directly or indirectly assembled as a part or subassembly in any finished product. For clarification, any software or software tools provided with the EVM ("Software") shall not be subject to the terms and conditions set forth herein but rather shall be subject to the applicable terms that accompany such Software
 - 1.2 EVMs are not intended for consumer or household use. EVMs may not be sold, sublicensed, leased, rented, loaned, assigned, or otherwise distributed for commercial purposes by Users, in whole or in part, or used in any finished product or production system.
2. *Limited Warranty and Related Remedies/Disclaimers:*
 - 2.1 These terms do not apply to Software. The warranty, if any, for Software is covered in the applicable Software License Agreement.
 - 2.2 TI warrants that the TI EVM will conform to TI's published specifications for ninety (90) days after the date TI delivers such EVM to User. Notwithstanding the foregoing, TI shall not be liable for a nonconforming EVM if (a) the nonconformity was caused by neglect, misuse or mistreatment by an entity other than TI, including improper installation or testing, or for any EVMs that have been altered or modified in any way by an entity other than TI, (b) the nonconformity resulted from User's design, specifications or instructions for such EVMs or improper system design, or (c) User has not paid on time. Testing and other quality control techniques are used to the extent TI deems necessary. TI does not test all parameters of each EVM. User's claims against TI under this Section 2 are void if User fails to notify TI of any apparent defects in the EVMs within ten (10) business days after delivery, or of any hidden defects with ten (10) business days after the defect has been detected.
 - 2.3 TI's sole liability shall be at its option to repair or replace EVMs that fail to conform to the warranty set forth above, or credit User's account for such EVM. TI's liability under this warranty shall be limited to EVMs that are returned during the warranty period to the address designated by TI and that are determined by TI not to conform to such warranty. If TI elects to repair or replace such EVM, TI shall have a reasonable time to repair such EVM or provide replacements. Repaired EVMs shall be warranted for the remainder of the original warranty period. Replaced EVMs shall be warranted for a new full ninety (90) day warranty period.

WARNING

Evaluation Kits are intended solely for use by technically qualified, professional electronics experts who are familiar with the dangers and application risks associated with handling electrical mechanical components, systems, and subsystems.

User shall operate the Evaluation Kit within TI's recommended guidelines and any applicable legal or environmental requirements as well as reasonable and customary safeguards. Failure to set up and/or operate the Evaluation Kit within TI's recommended guidelines may result in personal injury or death or property damage. Proper set up entails following TI's instructions for electrical ratings of interface circuits such as input, output and electrical loads.

NOTE:

EXPOSURE TO ELECTROSTATIC DISCHARGE (ESD) MAY CAUSE DEGRADATION OR FAILURE OF THE EVALUATION KIT; TI RECOMMENDS STORAGE OF THE EVALUATION KIT IN A PROTECTIVE ESD BAG.

3 Regulatory Notices:

3.1 United States

3.1.1 Notice applicable to EVMs not FCC-Approved:

FCC NOTICE: This kit is designed to allow product developers to evaluate electronic components, circuitry, or software associated with the kit to determine whether to incorporate such items in a finished product and software developers to write software applications for use with the end product. This kit is not a finished product and when assembled may not be resold or otherwise marketed unless all required FCC equipment authorizations are first obtained. Operation is subject to the condition that this product not cause harmful interference to licensed radio stations and that this product accept harmful interference. Unless the assembled kit is designed to operate under part 15, part 18 or part 95 of this chapter, the operator of the kit must operate under the authority of an FCC license holder or must secure an experimental authorization under part 5 of this chapter.

3.1.2 For EVMs annotated as FCC – FEDERAL COMMUNICATIONS COMMISSION Part 15 Compliant:

CAUTION

This device complies with part 15 of the FCC Rules. Operation is subject to the following two conditions: (1) This device may not cause harmful interference, and (2) this device must accept any interference received, including interference that may cause undesired operation.

Changes or modifications not expressly approved by the party responsible for compliance could void the user's authority to operate the equipment.

FCC Interference Statement for Class A EVM devices

NOTE: This equipment has been tested and found to comply with the limits for a Class A digital device, pursuant to part 15 of the FCC Rules. These limits are designed to provide reasonable protection against harmful interference when the equipment is operated in a commercial environment. This equipment generates, uses, and can radiate radio frequency energy and, if not installed and used in accordance with the instruction manual, may cause harmful interference to radio communications. Operation of this equipment in a residential area is likely to cause harmful interference in which case the user will be required to correct the interference at his own expense.

FCC Interference Statement for Class B EVM devices

NOTE: This equipment has been tested and found to comply with the limits for a Class B digital device, pursuant to part 15 of the FCC Rules. These limits are designed to provide reasonable protection against harmful interference in a residential installation. This equipment generates, uses and can radiate radio frequency energy and, if not installed and used in accordance with the instructions, may cause harmful interference to radio communications. However, there is no guarantee that interference will not occur in a particular installation. If this equipment does cause harmful interference to radio or television reception, which can be determined by turning the equipment off and on, the user is encouraged to try to correct the interference by one or more of the following measures:

- Reorient or relocate the receiving antenna.
- Increase the separation between the equipment and receiver.
- Connect the equipment into an outlet on a circuit different from that to which the receiver is connected.
- Consult the dealer or an experienced radio/TV technician for help.

3.2 Canada

3.2.1 For EVMs issued with an Industry Canada Certificate of Conformance to RSS-210 or RSS-247

Concerning EVMs Including Radio Transmitters:

This device complies with Industry Canada license-exempt RSSs. Operation is subject to the following two conditions:

(1) this device may not cause interference, and (2) this device must accept any interference, including interference that may cause undesired operation of the device.

Concernant les EVMs avec appareils radio:

Le présent appareil est conforme aux CNR d'Industrie Canada applicables aux appareils radio exempts de licence. L'exploitation est autorisée aux deux conditions suivantes: (1) l'appareil ne doit pas produire de brouillage, et (2) l'utilisateur de l'appareil doit accepter tout brouillage radioélectrique subi, même si le brouillage est susceptible d'en compromettre le fonctionnement.

Concerning EVMs Including Detachable Antennas:

Under Industry Canada regulations, this radio transmitter may only operate using an antenna of a type and maximum (or lesser) gain approved for the transmitter by Industry Canada. To reduce potential radio interference to other users, the antenna type and its gain should be so chosen that the equivalent isotropically radiated power (e.i.r.p.) is not more than that necessary for successful communication. This radio transmitter has been approved by Industry Canada to operate with the antenna types listed in the user guide with the maximum permissible gain and required antenna impedance for each antenna type indicated. Antenna types not included in this list, having a gain greater than the maximum gain indicated for that type, are strictly prohibited for use with this device.

Concernant les EVMs avec antennes détachables

Conformément à la réglementation d'Industrie Canada, le présent émetteur radio peut fonctionner avec une antenne d'un type et d'un gain maximal (ou inférieur) approuvé pour l'émetteur par Industrie Canada. Dans le but de réduire les risques de brouillage radioélectrique à l'intention des autres utilisateurs, il faut choisir le type d'antenne et son gain de sorte que la puissance isotrope rayonnée équivalente (p.i.r.e.) ne dépasse pas l'intensité nécessaire à l'établissement d'une communication satisfaisante. Le présent émetteur radio a été approuvé par Industrie Canada pour fonctionner avec les types d'antenne énumérés dans le manuel d'usage et ayant un gain admissible maximal et l'impédance requise pour chaque type d'antenne. Les types d'antenne non inclus dans cette liste, ou dont le gain est supérieur au gain maximal indiqué, sont strictement interdits pour l'exploitation de l'émetteur.

3.3 Japan

3.3.1 *Notice for EVMs delivered in Japan:* Please see http://www.tij.co.jp/lstds/ti_ja/general/eStore/notice_01.page 日本国内に輸入される評価用キット、ボードについては、次のところをご覧ください。
http://www.tij.co.jp/lstds/ti_ja/general/eStore/notice_01.page

3.3.2 *Notice for Users of EVMs Considered "Radio Frequency Products" in Japan:* EVMs entering Japan may not be certified by TI as conforming to Technical Regulations of Radio Law of Japan.

If User uses EVMs in Japan, not certified to Technical Regulations of Radio Law of Japan, User is required to follow the instructions set forth by Radio Law of Japan, which includes, but is not limited to, the instructions below with respect to EVMs (which for the avoidance of doubt are stated strictly for convenience and should be verified by User):

1. Use EVMs in a shielded room or any other test facility as defined in the notification #173 issued by Ministry of Internal Affairs and Communications on March 28, 2006, based on Sub-section 1.1 of Article 6 of the Ministry's Rule for Enforcement of Radio Law of Japan,
2. Use EVMs only after User obtains the license of Test Radio Station as provided in Radio Law of Japan with respect to EVMs, or
3. Use of EVMs only after User obtains the Technical Regulations Conformity Certification as provided in Radio Law of Japan with respect to EVMs. Also, do not transfer EVMs, unless User gives the same notice above to the transferee. Please note that if User does not follow the instructions above, User will be subject to penalties of Radio Law of Japan.

【無線電波を送信する製品の開発キットをお使いになる際の注意事項】 開発キットの中には技術基準適合証明を受けていないものがあります。技術適合証明を受けていないものご使用に際しては、電波法遵守のため、以下のいずれかの措置を取っていただく必要がありますのでご注意ください。

1. 電波法施行規則第6条第1項第1号に基づく平成18年3月28日総務省告示第173号で定められた電波暗室等の試験設備でご使用いただく。
2. 実験局の免許を取得後ご使用いただく。
3. 技術基準適合証明を取得後ご使用いただく。

なお、本製品は、上記の「ご使用にあたっての注意」を譲渡先、移転先に通知しない限り、譲渡、移転できないものとします。

上記を遵守頂けない場合は、電波法の罰則が適用される可能性があることをご留意ください。日本テキサス・インスツルメンツ株式会社
東京都新宿区西新宿 6 丁目 2 4 番 1 号
西新宿三井ビル

3.3.3 *Notice for EVMs for Power Line Communication:* Please see http://www.tij.co.jp/lstds/ti_ja/general/eStore/notice_02.page
電力線搬送波通信についての開発キットをお使いになる際の注意事項については、次のところをご覧ください。http://www.tij.co.jp/lstds/ti_ja/general/eStore/notice_02.page

3.4 European Union

3.4.1 *For EVMs subject to EU Directive 2014/30/EU (Electromagnetic Compatibility Directive):*

This is a class A product intended for use in environments other than domestic environments that are connected to a low-voltage power-supply network that supplies buildings used for domestic purposes. In a domestic environment this product may cause radio interference in which case the user may be required to take adequate measures.

-
- 4 *EVM Use Restrictions and Warnings:*
 - 4.1 EVMS ARE NOT FOR USE IN FUNCTIONAL SAFETY AND/OR SAFETY CRITICAL EVALUATIONS, INCLUDING BUT NOT LIMITED TO EVALUATIONS OF LIFE SUPPORT APPLICATIONS.
 - 4.2 User must read and apply the user guide and other available documentation provided by TI regarding the EVM prior to handling or using the EVM, including without limitation any warning or restriction notices. The notices contain important safety information related to, for example, temperatures and voltages.
 - 4.3 *Safety-Related Warnings and Restrictions:*
 - 4.3.1 User shall operate the EVM within TI's recommended specifications and environmental considerations stated in the user guide, other available documentation provided by TI, and any other applicable requirements and employ reasonable and customary safeguards. Exceeding the specified performance ratings and specifications (including but not limited to input and output voltage, current, power, and environmental ranges) for the EVM may cause personal injury or death, or property damage. If there are questions concerning performance ratings and specifications, User should contact a TI field representative prior to connecting interface electronics including input power and intended loads. Any loads applied outside of the specified output range may also result in unintended and/or inaccurate operation and/or possible permanent damage to the EVM and/or interface electronics. Please consult the EVM user guide prior to connecting any load to the EVM output. If there is uncertainty as to the load specification, please contact a TI field representative. During normal operation, even with the inputs and outputs kept within the specified allowable ranges, some circuit components may have elevated case temperatures. These components include but are not limited to linear regulators, switching transistors, pass transistors, current sense resistors, and heat sinks, which can be identified using the information in the associated documentation. When working with the EVM, please be aware that the EVM may become very warm.
 - 4.3.2 EVMs are intended solely for use by technically qualified, professional electronics experts who are familiar with the dangers and application risks associated with handling electrical mechanical components, systems, and subsystems. User assumes all responsibility and liability for proper and safe handling and use of the EVM by User or its employees, affiliates, contractors or designees. User assumes all responsibility and liability to ensure that any interfaces (electronic and/or mechanical) between the EVM and any human body are designed with suitable isolation and means to safely limit accessible leakage currents to minimize the risk of electrical shock hazard. User assumes all responsibility and liability for any improper or unsafe handling or use of the EVM by User or its employees, affiliates, contractors or designees.
 - 4.4 User assumes all responsibility and liability to determine whether the EVM is subject to any applicable international, federal, state, or local laws and regulations related to User's handling and use of the EVM and, if applicable, User assumes all responsibility and liability for compliance in all respects with such laws and regulations. User assumes all responsibility and liability for proper disposal and recycling of the EVM consistent with all applicable international, federal, state, and local requirements.
 5. *Accuracy of Information:* To the extent TI provides information on the availability and function of EVMs, TI attempts to be as accurate as possible. However, TI does not warrant the accuracy of EVM descriptions, EVM availability or other information on its websites as accurate, complete, reliable, current, or error-free.
 6. *Disclaimers:*
 - 6.1 EXCEPT AS SET FORTH ABOVE, EVMS AND ANY MATERIALS PROVIDED WITH THE EVM (INCLUDING, BUT NOT LIMITED TO, REFERENCE DESIGNS AND THE DESIGN OF THE EVM ITSELF) ARE PROVIDED "AS IS" AND "WITH ALL FAULTS." TI DISCLAIMS ALL OTHER WARRANTIES, EXPRESS OR IMPLIED, REGARDING SUCH ITEMS, INCLUDING BUT NOT LIMITED TO ANY EPIDEMIC FAILURE WARRANTY OR IMPLIED WARRANTIES OF MERCHANTABILITY OR FITNESS FOR A PARTICULAR PURPOSE OR NON-INFRINGEMENT OF ANY THIRD PARTY PATENTS, COPYRIGHTS, TRADE SECRETS OR OTHER INTELLECTUAL PROPERTY RIGHTS.
 - 6.2 EXCEPT FOR THE LIMITED RIGHT TO USE THE EVM SET FORTH HEREIN, NOTHING IN THESE TERMS SHALL BE CONSTRUED AS GRANTING OR CONFERRING ANY RIGHTS BY LICENSE, PATENT, OR ANY OTHER INDUSTRIAL OR INTELLECTUAL PROPERTY RIGHT OF TI, ITS SUPPLIERS/LICENSORS OR ANY OTHER THIRD PARTY, TO USE THE EVM IN ANY FINISHED END-USER OR READY-TO-USE FINAL PRODUCT, OR FOR ANY INVENTION, DISCOVERY OR IMPROVEMENT, REGARDLESS OF WHEN MADE, CONCEIVED OR ACQUIRED.
 7. *USER'S INDEMNITY OBLIGATIONS AND REPRESENTATIONS.* USER WILL DEFEND, INDEMNIFY AND HOLD TI, ITS LICENSORS AND THEIR REPRESENTATIVES HARMLESS FROM AND AGAINST ANY AND ALL CLAIMS, DAMAGES, LOSSES, EXPENSES, COSTS AND LIABILITIES (COLLECTIVELY, "CLAIMS") ARISING OUT OF OR IN CONNECTION WITH ANY HANDLING OR USE OF THE EVM THAT IS NOT IN ACCORDANCE WITH THESE TERMS. THIS OBLIGATION SHALL APPLY WHETHER CLAIMS ARISE UNDER STATUTE, REGULATION, OR THE LAW OF TORT, CONTRACT OR ANY OTHER LEGAL THEORY, AND EVEN IF THE EVM FAILS TO PERFORM AS DESCRIBED OR EXPECTED.

8. *Limitations on Damages and Liability:*

8.1 *General Limitations.* IN NO EVENT SHALL TI BE LIABLE FOR ANY SPECIAL, COLLATERAL, INDIRECT, PUNITIVE, INCIDENTAL, CONSEQUENTIAL, OR EXEMPLARY DAMAGES IN CONNECTION WITH OR ARISING OUT OF THESE TERMS OR THE USE OF THE EVMS , REGARDLESS OF WHETHER TI HAS BEEN ADVISED OF THE POSSIBILITY OF SUCH DAMAGES. EXCLUDED DAMAGES INCLUDE, BUT ARE NOT LIMITED TO, COST OF REMOVAL OR REINSTALLATION, ANCILLARY COSTS TO THE PROCUREMENT OF SUBSTITUTE GOODS OR SERVICES, RETESTING, OUTSIDE COMPUTER TIME, LABOR COSTS, LOSS OF GOODWILL, LOSS OF PROFITS, LOSS OF SAVINGS, LOSS OF USE, LOSS OF DATA, OR BUSINESS INTERRUPTION. NO CLAIM, SUIT OR ACTION SHALL BE BROUGHT AGAINST TI MORE THAN TWELVE (12) MONTHS AFTER THE EVENT THAT GAVE RISE TO THE CAUSE OF ACTION HAS OCCURRED.

8.2 *Specific Limitations.* IN NO EVENT SHALL TI'S AGGREGATE LIABILITY FROM ANY USE OF AN EVM PROVIDED HEREUNDER, INCLUDING FROM ANY WARRANTY, INDEMNITY OR OTHER OBLIGATION ARISING OUT OF OR IN CONNECTION WITH THESE TERMS, , EXCEED THE TOTAL AMOUNT PAID TO TI BY USER FOR THE PARTICULAR EVM(S) AT ISSUE DURING THE PRIOR TWELVE (12) MONTHS WITH RESPECT TO WHICH LOSSES OR DAMAGES ARE CLAIMED. THE EXISTENCE OF MORE THAN ONE CLAIM SHALL NOT ENLARGE OR EXTEND THIS LIMIT.

9. *Return Policy.* Except as otherwise provided, TI does not offer any refunds, returns, or exchanges. Furthermore, no return of EVM(s) will be accepted if the package has been opened and no return of the EVM(s) will be accepted if they are damaged or otherwise not in a resalable condition. If User feels it has been incorrectly charged for the EVM(s) it ordered or that delivery violates the applicable order, User should contact TI. All refunds will be made in full within thirty (30) working days from the return of the components(s), excluding any postage or packaging costs.

10. *Governing Law:* These terms and conditions shall be governed by and interpreted in accordance with the laws of the State of Texas, without reference to conflict-of-laws principles. User agrees that non-exclusive jurisdiction for any dispute arising out of or relating to these terms and conditions lies within courts located in the State of Texas and consents to venue in Dallas County, Texas. Notwithstanding the foregoing, any judgment may be enforced in any United States or foreign court, and TI may seek injunctive relief in any United States or foreign court.

Mailing Address: Texas Instruments, Post Office Box 655303, Dallas, Texas 75265
Copyright © 2019, Texas Instruments Incorporated

IMPORTANT NOTICE AND DISCLAIMER

TI PROVIDES TECHNICAL AND RELIABILITY DATA (INCLUDING DATA SHEETS), DESIGN RESOURCES (INCLUDING REFERENCE DESIGNS), APPLICATION OR OTHER DESIGN ADVICE, WEB TOOLS, SAFETY INFORMATION, AND OTHER RESOURCES "AS IS" AND WITH ALL FAULTS, AND DISCLAIMS ALL WARRANTIES, EXPRESS AND IMPLIED, INCLUDING WITHOUT LIMITATION ANY IMPLIED WARRANTIES OF MERCHANTABILITY, FITNESS FOR A PARTICULAR PURPOSE OR NON-INFRINGEMENT OF THIRD PARTY INTELLECTUAL PROPERTY RIGHTS.

These resources are intended for skilled developers designing with TI products. You are solely responsible for (1) selecting the appropriate TI products for your application, (2) designing, validating and testing your application, and (3) ensuring your application meets applicable standards, and any other safety, security, regulatory or other requirements.

These resources are subject to change without notice. TI grants you permission to use these resources only for development of an application that uses the TI products described in the resource. Other reproduction and display of these resources is prohibited. No license is granted to any other TI intellectual property right or to any third party intellectual property right. TI disclaims responsibility for, and you will fully indemnify TI and its representatives against, any claims, damages, costs, losses, and liabilities arising out of your use of these resources.

TI's products are provided subject to [TI's Terms of Sale](#) or other applicable terms available either on ti.com or provided in conjunction with such TI products. TI's provision of these resources does not expand or otherwise alter TI's applicable warranties or warranty disclaimers for TI products.

TI objects to and rejects any additional or different terms you may have proposed.

Mailing Address: Texas Instruments, Post Office Box 655303, Dallas, Texas 75265
Copyright © 2022, Texas Instruments Incorporated