

DLP® Display DLPC7540 4K UHD Evaluation Module



Description

The DLPC7540 controller EVM board, [DLPC7540EVM](#), when combined with the [DLP472TEEVm](#), [DLP650TEEVm](#), or [DLP471TEEVm](#), can accelerate the prototyping time of a DLP 4K UHD system. The DLPC7540EVM provides a design for driving either the 0.47-inch 4K UHD or 0.65-inch 4K UHD standard digital micromirror devices (DMDs), while allowing for testing with included Vx1 interface front-end system. The combination of the DLPC7540EVM with either the DLP472TEEVm, DLP650TEEVm, or DLP471TEEVm can display SPLASH, test patterns or video from the HDMI source on the DMD.

Features

- DLP472TEEVm
 - 4K UHD (3840 × 2160) display resolution
 - 5.4µm micromirror pitch
 - ±14.5° micromirror tilt (relative to flat surface)
 - Corner illumination
 - High speed serial interface (HSSI) input data bus
- DLP650TEEVm
 - 4K UHD (3840 × 2160) display resolution
 - 7.6µm micromirror pitch
 - ±12° micromirror tilt (relative to flat surface)
 - Corner illumination
 - High speed serial interface (HSSI) input data bus
- DLP471TEEVm
 - 4K UHD (3840 × 2160) display resolution
 - 5.4µm micromirror pitch
 - ±17° micromirror tilt (relative to flat surface)
 - Bottom illumination
 - High speed serial interface (HSSI) input data bus
- DLPC7540EVM
 - Supports up to 4K UHD at 60Hz
 - Supports up to 1080p at 240Hz (2D) and 120Hz (3D)
 - Supports LED, RGB laser and laser phosphor illuminations

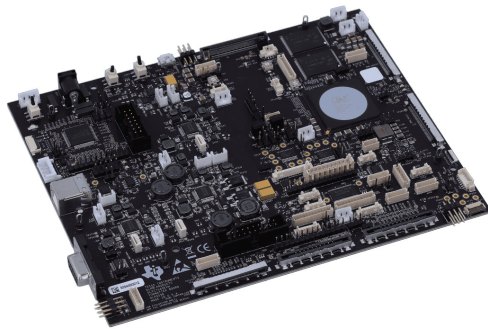

DLPC7540EVM

1 DLPC7540EVM, DLP471TEEV, DLP472TEEV, and DLP650TEEV Overview

1.1 Introduction

This guide explains the hardware and software features of the DLP® Products DLP472TEEV, DLP471TEEV, DLP650TEEV, and DLPC7540EVM evaluation modules (EVMs). The EVM architecture and connectors are described along with a quick start guide on how to operate the DLP472TEEV, DLP471TEEV, DLP650TEEV, and DLPC7540EVM EVMs using the DLPDLC-GUI. Specific DLP chip details and operation can be found in related component documentation.

The DLPC7540EVM was also designed to be paired with the available .47-inch 1080p EVM (DLP472NEEV) or the .65-inch 4K UHD EVM (DLP651TEEV) to help evaluate 1080p functionality. Please see **Section 3.1.1** for more details.

Note

Power supply, optics, illumination source, and cables are not included. See [Section 1.4](#) .

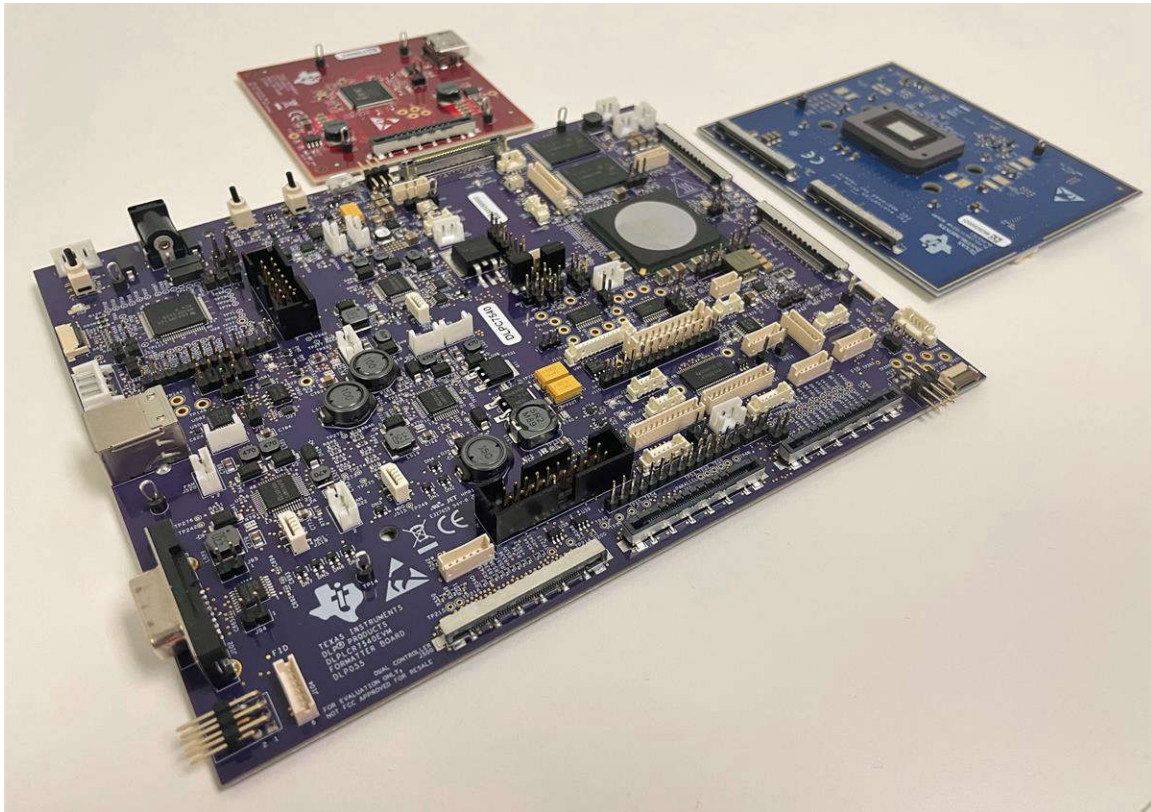

Figure 1-1. DLP Products DLPC7540EVM and DLP471TEEV Evaluation Modules

The DLP Products DLPC7540EVM, DLP471TEEV, DLP472TEEV, and DLP650TEEV evaluation modules (EVMs) offer a reference design to enable faster development cycles for users of the DLPC7540 chips and allow evaluation of TI's DLP471TE and DLP650TE UHD chipsets. These consist of one controller EVM (DLPC7540EVM) and three DMD EVMs (DLP471TEEV, DLP472TEEV, and DLP650TEEV).

These evaluation kits bring together a set of components providing a great starting point to evaluate a UHD DLP system for:

- Laser TV
- Enterprise Projectors
- Digital Signage
- Gaming Machines
- Smart Projectors

- Stage Lighting Systems

1.2 What is in the DLP471TEEVM, DLP472TEEVM, DLP650TEEVM, and DLPC7540EVM Evaluation Modules?

The DLP471TEEVM, DLP472TEEVM, DLP650TEEVM, and DLPC7540EVM are designed to be used in pairs. The DMD EVMs cannot be operated without the Controller EVM, DLPC7540EVM.

The DLP471TEEVM, which includes the DLP471TE display chip, the DLP472TEEVM, which includes the DLP472TE display chip, and the DLP650TEEVM, which includes the DLP650TE display chip, include the two flex cables required to connect to the DLPC7540EVM. DLPC7540EVM includes all circuitry required to drive the DLP471TE, DLP472TE, and DLP650TE display chips.

The DLPC7540EVM which consists of a formatter board ([Figure 1-2](#)) and an HDMI input processing front-end board ([Figure 1-3](#)), includes a DLPC7540 controller, three DLPA100s which serve as the power management and motor drivers, and other system circuitry such as the Vx1 interface front-end and system fan control.

The DLPC7540EVM can be programmed with either the DLP471TE, DLP472TE, or DLP650TE firmware which is available on the DLPC7540 product page. This firmware allows the DLPC7540EVM to drive either display chip. [Figure 1-2](#), [Figure 1-3](#), and [Figure 1-4](#) show the top side of all boards making up the EVMs.

Note

The DLPC7540EVM only supports two color wheels and has limited support for three color wheels system.

Note

[Figure 1-2](#), [Figure 1-3](#), and [Figure 1-4](#) do not show the necessary flex cables (JF08R0R051020UA) needed to pair to DLPC7540EVM.

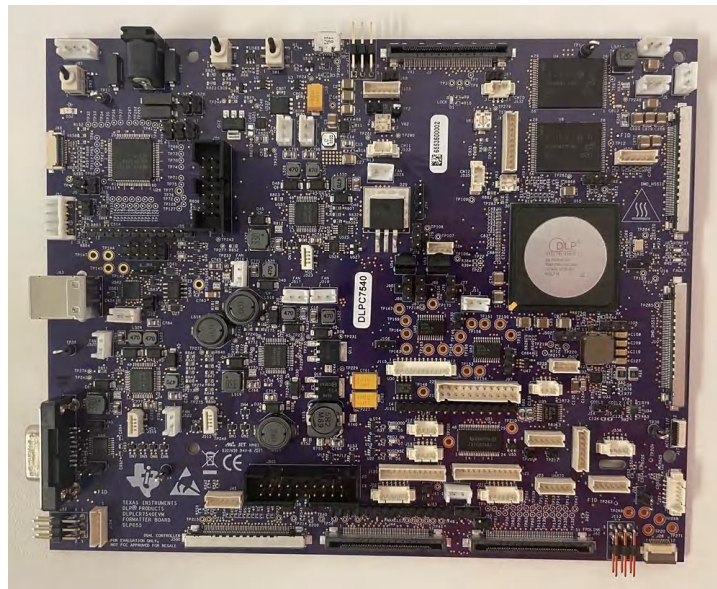

Figure 1-2. DLPC7540EVM Formatter Board

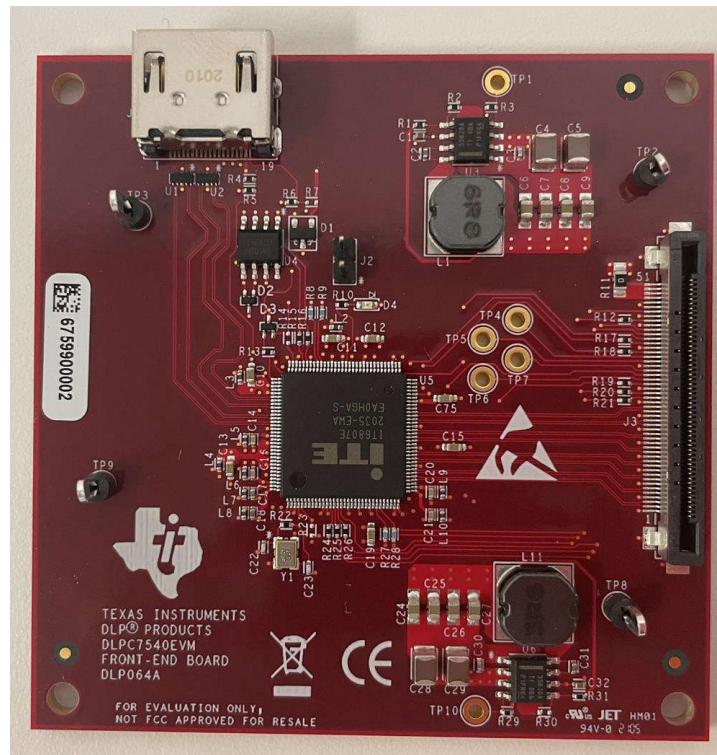

Figure 1-3. DLPC7540EVM Front-end Board

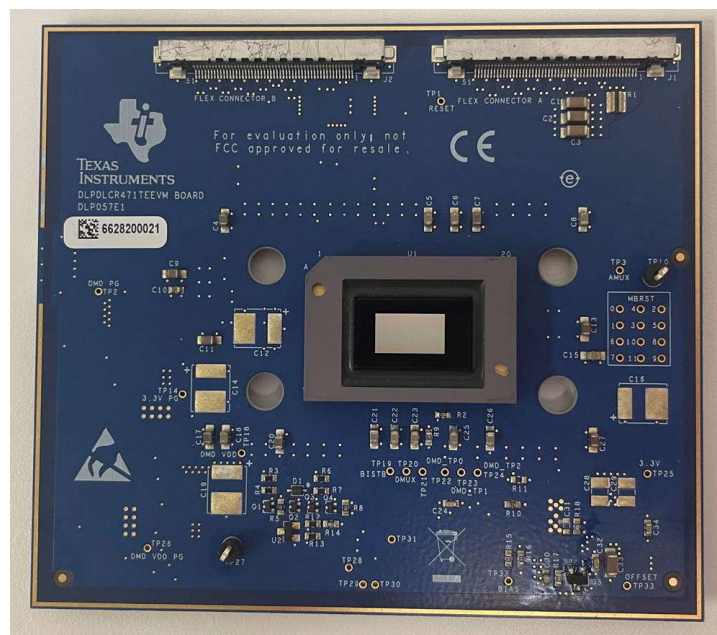

Figure 1-4. DLP471TEEVM

1.3 EVM Boards

The DLP471TEEV, DLP472TEEV, DLP650TEEV, and DLPC7540EVM EVMs contain the electronics required to drive either DLP471TE, DLP472TE, or DLP650TE DMD. The DLPC7540EVM offers several interface options for USB, I2C, and trigger inputs and outputs.

The system block diagram details the functionality and control when using the DLP471TEEV and DLPC7540EVM, as shown in [Figure 1-5](#).

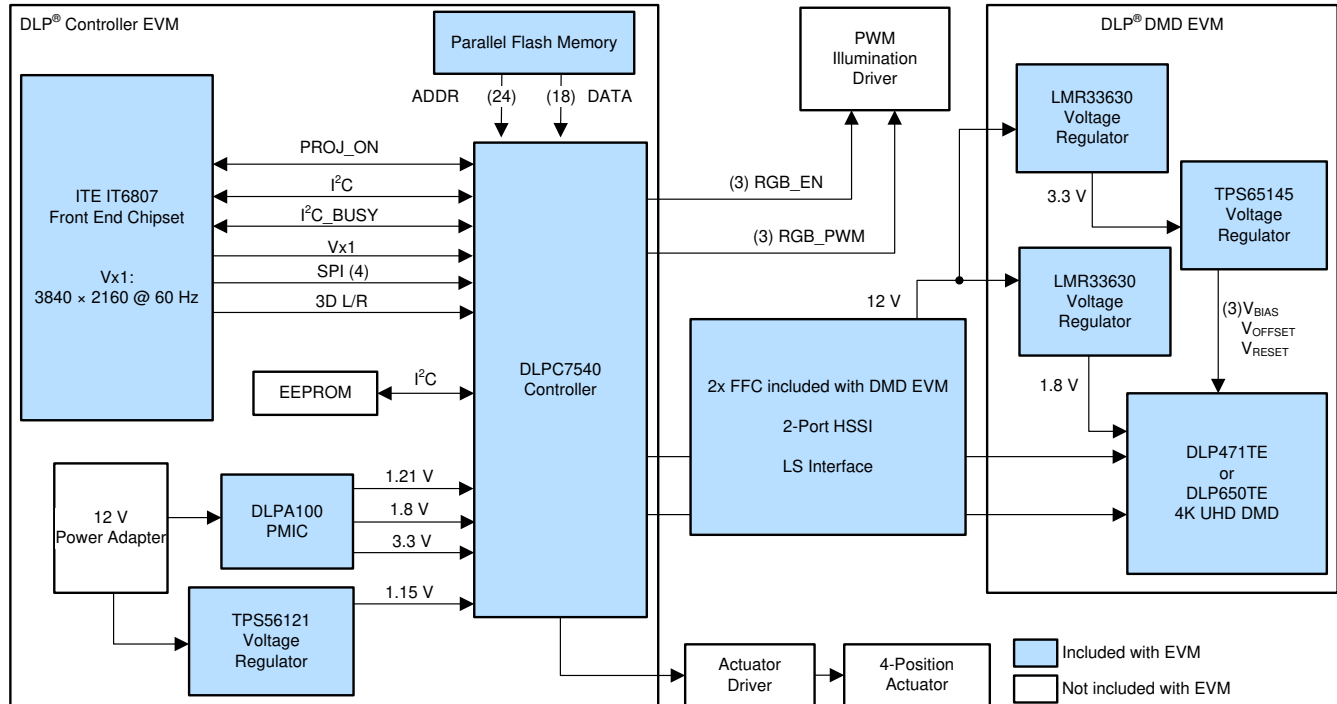

Figure 1-5. EVM System Block Diagram

The major components of the DLPC7540EVM are:

- One DLPC7540 controller
- Three DLPA100 power management and motor driver chips
- One Vx1 front-end capable of processing inputs up to 4K at 60Hz at 600MHz pixel clock

The major components of the DLP471TEEV are:

- DLP471TE 0.47-inch 4K UHD DMD
- Two flex cables designed to connect the DLP471TEEV to the DLPC7540EVM
- TPS65145 used to generate the DMD's offset, reset and bias voltages

The major components of the DLP472TEEV are:

- DLP472TE 0.47-inch 4K UHD DMD
- Two flex cables designed to connect the DLP472TEEV to the DLPC7540EVM
- TPS65145 used to generate the DMD's offset, reset and bias voltages

The major components of the DLP650TEEV are:

- DLP650TE 0.65-inch 4K UHD DMD
- Two flex cables designed to connect the DLP650TEEV to the DLPC7540EVM
- TPS65145 used to generate the DMD's offset, reset and bias voltages

1.4 Other Items Needed for Operation

The DLP471TEEV, DLP472TEEV, DLP650TEEV, and the DLPC7540EVM are evaluation modules (EVM) that are capable of displaying images on to the DMD. However, these EVMs do not ship with optics, illumination source, cables, power supplies, or additional hardware components. These are system parameters that are left for the user to design, the EVMs are meant to accelerate initial system design.

- Power supply - required for EVM operation (see [Section 2.3.1](#))
- Micro-USB cable: A to micro-B USB cable - required for GUI interface
- Optics
- Illumination module and source
- XPR actuator

The firmware provided on ti.com is for the sole purpose of operating the electronic components that make up the DLP471TEEV, DLP472TEEV, DLP650TEEV, and the DLPC7540EVM evaluation modules. Any additions made to the EVMs such as illumination, optics, actuator, and so on require contacting Texas Instruments for additional support in including these elements specific to customer application.

1.5 DLPC7540EVM, DLP471TEEV, DLP472TEEV, and DLP650TEEV EVM Flex Cable

Electrical malfunctions can occur by stressing the flex cables connecting the DMD circuit board to the DLPC7540EVM formatter board. Stressing the flex cable can be caused by:

- Bending the flex cables sharply.
- Repeatedly bending the flex cables.
- Excessive insertion and extraction of flex cables to or from board connectors.

Note

Minimize any handling or movement on the flex cables during operation.

2 Hardware

2.1 Additional Images

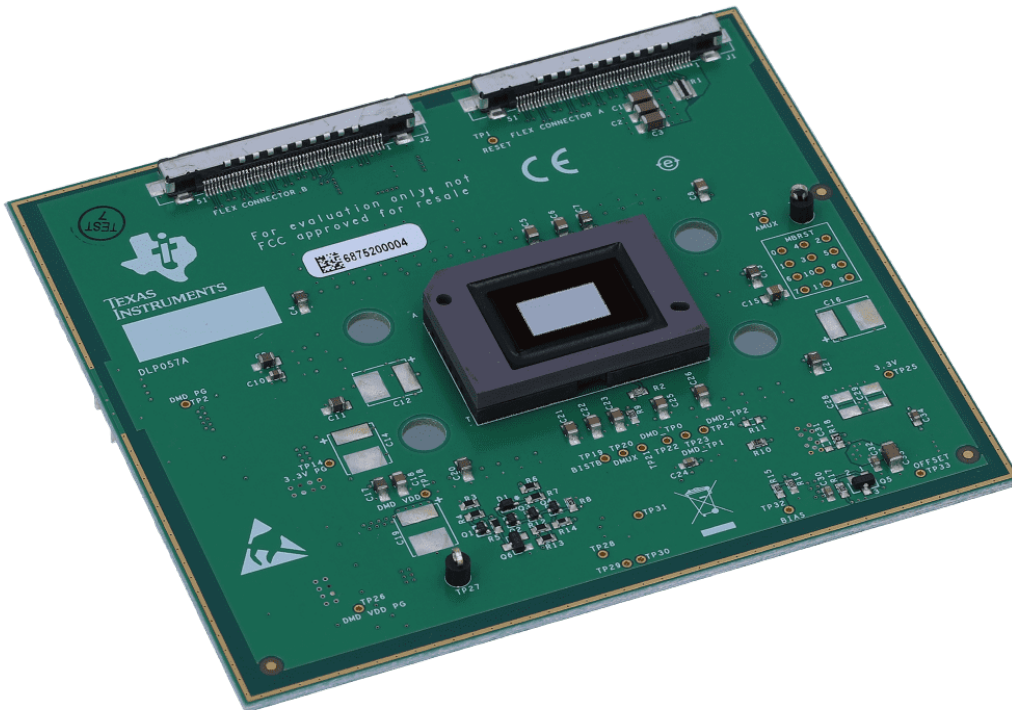

DLP472TEEVM

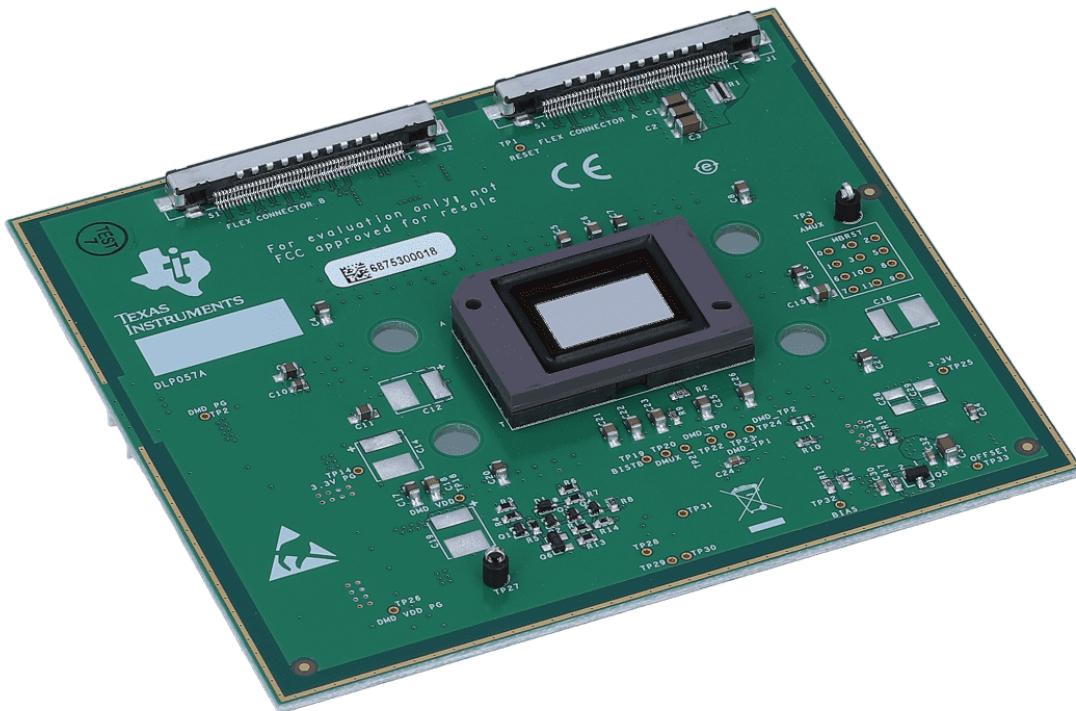

DLP650TEEVM

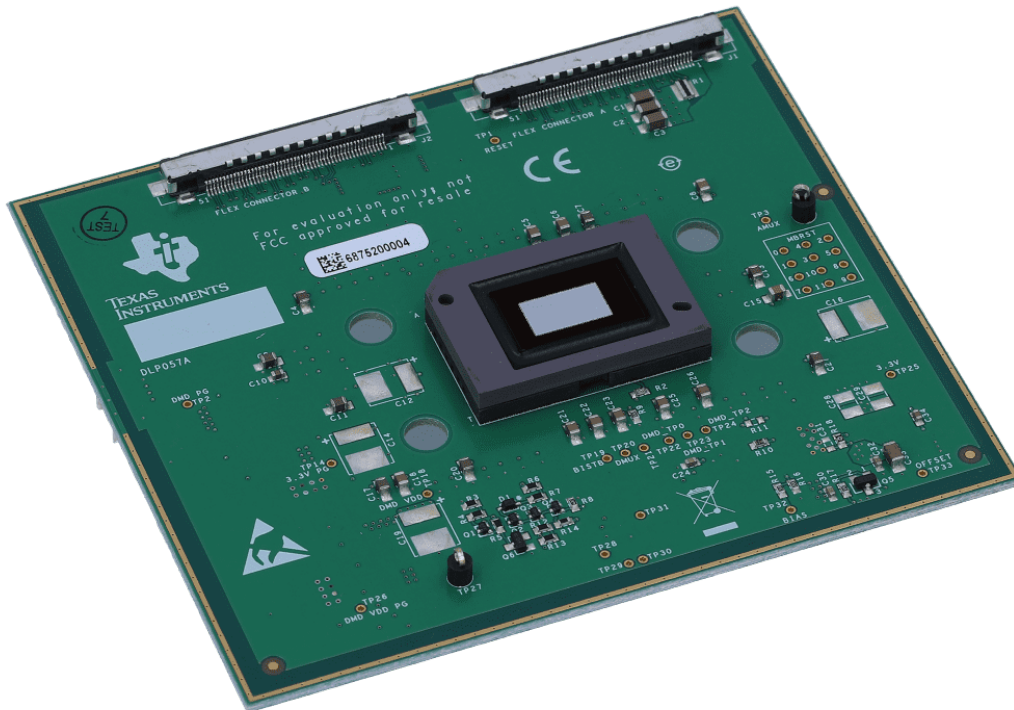

DLP471TEEV

2.2 Connections

This chapter introduces all the connections and test points available on the DLPC7540EVM and DLP471TEEV/DLP472TEEV/DLP650TEEV.

2.2.1 DLPC7540EVM Connections

The switches and connectors with the respective locations are shown in [Figure 2-1](#). Note that neither cables nor the power supply are included with the module.

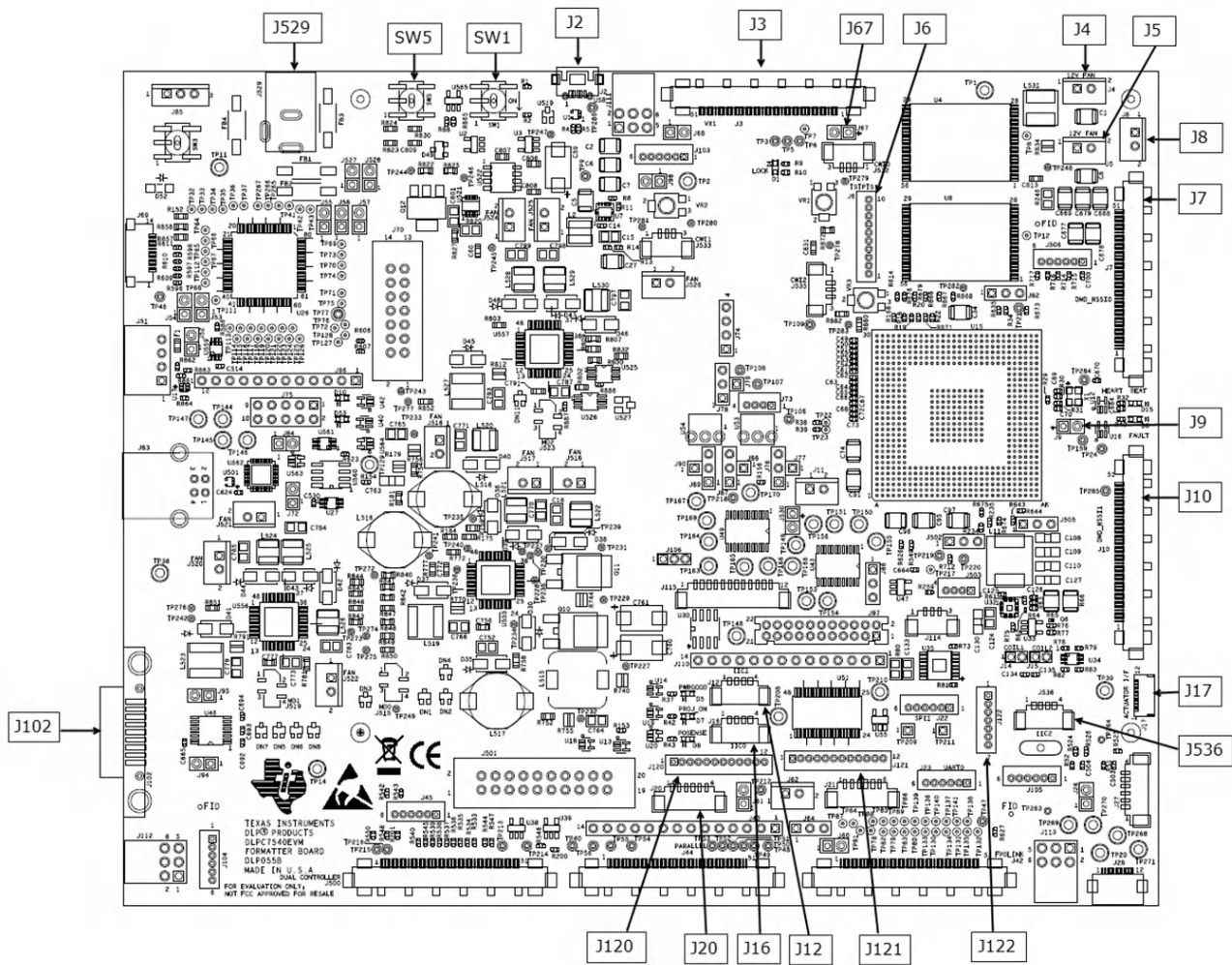

Figure 2-1. DLPC7540EVM Formatter Board Connectors

Formatter Board Connectors

1. **J2** – Micro-USB
2. **J3** – V-By-One Input
3. **J4** – 12V Fan
4. **J5** – 12V Fan
5. **J6** – Test Points Header
6. **J7** – DMD HSS10 Flex Cable Connector
7. **J8** – 12V Fan (Heatsink)
8. **J9** – Hold Bootloader
9. **J10** – DMD HSS11 Flex Cable Connector
10. **J12** – I2C1 Bus
11. **J16** – I2C0 Bus
12. **J17** – Actuator PWM Interface
13. **J20** – JTAG Boundary Scan
14. **J67** - 5V Enable for V-By-One Front-end Board
15. **J102** - RS232
16. **J120** - Actuator DAC Driver A/B
17. **J121** - Actuator DAC Driver C/D
18. **J122** - Actuator DAC Driver Enable
19. **J529** - 12V Input
20. **J536** - I2C2 Bus

- 21. **SW1** – Projector On Switch
- 22. **SW5** - Main Power Switch

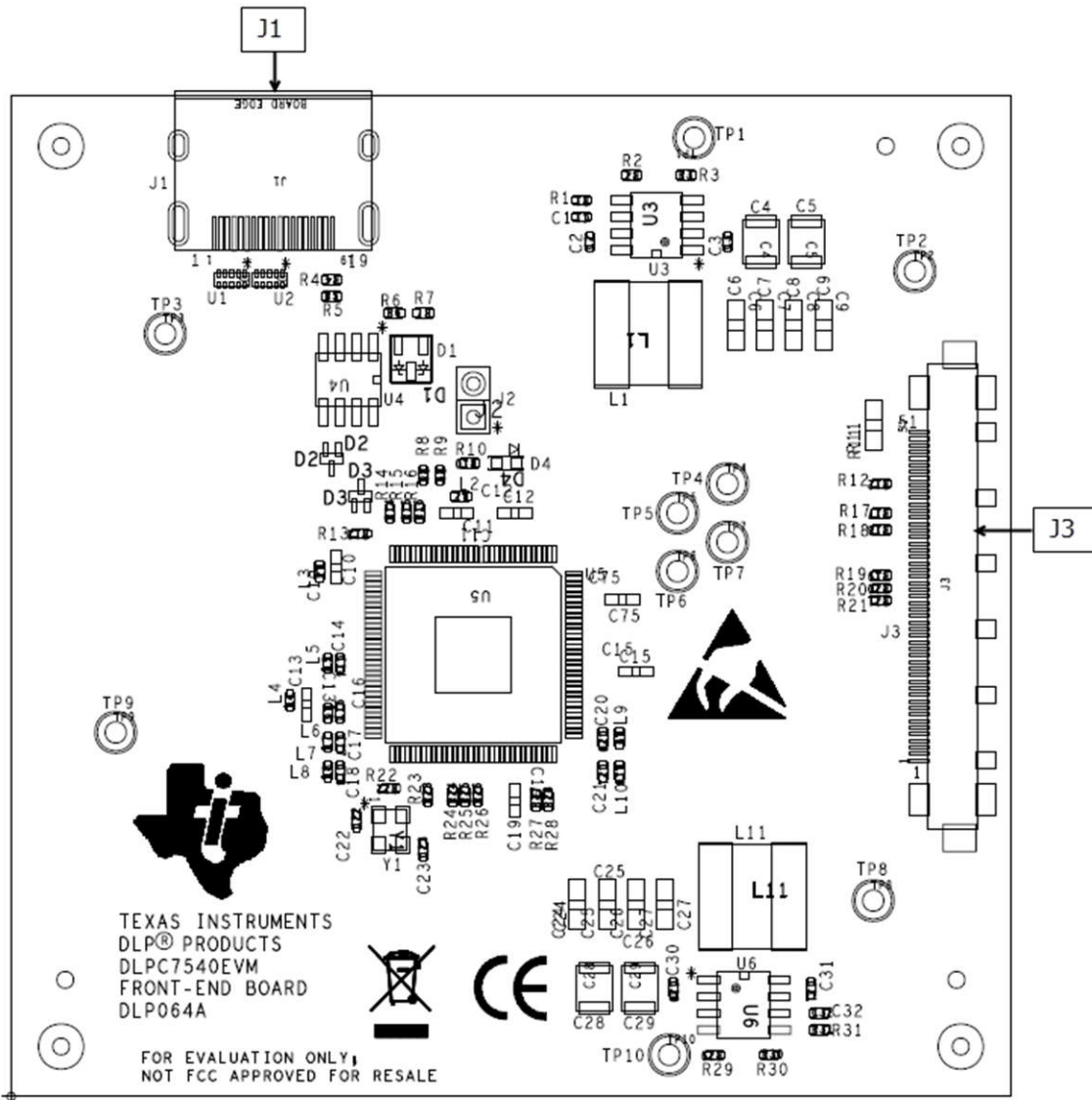

Figure 2-2. DLPC7540EVM Front-end Board Connectors

Front-end Board Connectors

- 1. **J1** - HDMI Input
- 2. **J3** - V-By-One Input

2.2.2 DLP471TEEVM, DLP472TEEVM, and DLP650TEEVM Connections

The switches and connectors with the respective locations are shown in [Figure 2-3](#).

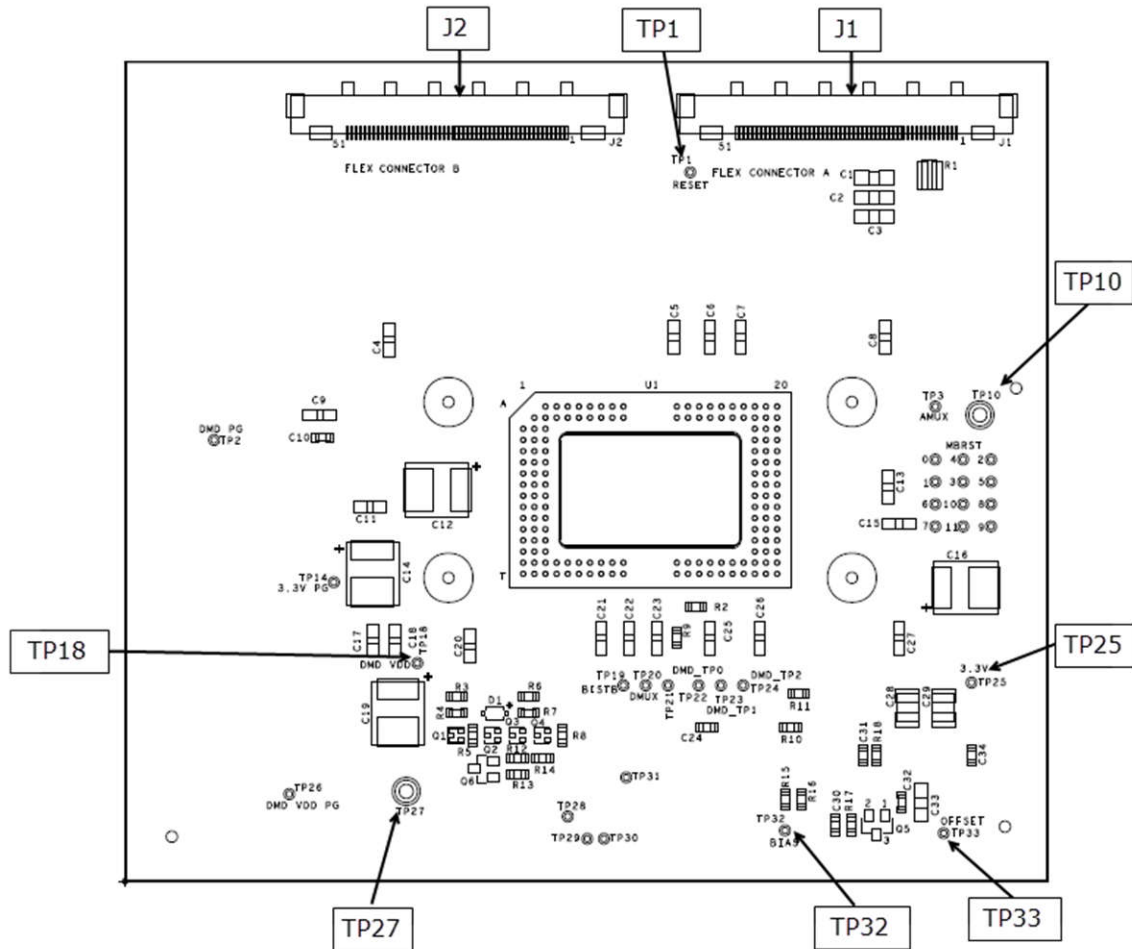

Figure 2-3. DLP471TEEVM, DLP472TEEVM, and DLP650TEEVM Test Points and Connectors

2.2.2.1 Test Points

1. **TP1** - VRESET
2. **TP10** - GND
3. **TP18** - DMD_VDD (1.8V)
4. **TP25** - 3.3V
5. **TP27** - GND
6. **TP32** - VBIAS
7. **TP33** - VOFFSET

2.2.2.2 Connectors

1. **J1** - DMD HSSI0 Flex Cable Connector
2. **J2** - DMD HSSI1 Flex Cable Connector

2.3 Power Supply Requirements

2.3.1 External Power Supply Requirements

The DLPC7540EVM does not include a power supply. The external power supply requirements are:

- Nominal voltage: 12V DC -5%/+10%
- Maximum output current: 7A
- DC connector size:

- Inner diameter: 2.5mm
- Outer diameter: 5.5mm
- Shaft: 9.5mm, center positive
- Efficiency level: V
- A recommended power supply is [Digi-Key part number 993-1009-ND](#), or equivalent

Note

External Power Supply Regulatory Compliance Certifications: recommend selection and use of an external power supply, which meets TI's required minimum electrical ratings in addition to complying with applicable regional product regulatory and safety certification requirements such as (by example) UL, CSA, VDE, CCC, PSE, and so forth.

3 Software

3.1 Quick Start

This chapter offers a quick start guide on how to connect the DLP471TEEVM, DLP472TEEVM, or DLP650TEEVM to the DLPC7540EVM, how to power up the DLPC7540EVM, and how to program the DLPC7540EVM to display a SPLASH image on the DMD.

3.1.1 Downloading the Software

Before programming the DLPC7540EVM, make sure the DLPDLC-GUI and DMD firmware are both downloaded on the PC. The DLPDLC-GUI allows for operation of the EVM. The DMD firmware is required so the DLPC7540EVM knows which DMD is being controlled. The DLP471TEEVM comes with a DLP471TE DMD which is for 4K display applications. The EVM when installed with DLP471TE DMD can operate using DLP471TE (4K) or DLP471NE (1080p) based firmware. Similarly, the DLP472TEEVM and DLP650TEEVM comes with a DLP472TE and DLP650TE DMD for 4K display applications and can operate with DLP472TE (4K), DLP650TE (4K), DLP471NE (1080p), or DLP472NE (1080p) based firmware. Any of the three types of DMD EVMs can also be retrofitted with the corresponding 1080p DMDs (DLP471NE/DLP472NE/DLP651NE) but does not have XPR operation enabled. For a summary of firmware compatibility, see [Table 3-1](#).

Table 3-1. Flash Image Compatibility Summary

Flash Image ⁽¹⁾	DLP471TEEVM		DLP472TEEVM		DLP650TEEVM	
	DLP471TE DMD	DLP471NE DMD	DLP472TE DMD	DLP472NE DMD	DLP650TE DMD	DLP651NE DMD
Flash_DLPC7540_DLP471TE_LED.img	✓	✓ ⁽²⁾				
Flash_DLPC7540_DLP471TE_LPCW.img	✓	✓ ⁽²⁾				
Flash_DLPC7540_DLP471NE_LED.img	✓ ⁽²⁾	✓				
Flash_DLPC7540_DLP471NE_LPCW.img	✓ ⁽²⁾	✓				
Flash_DLPC7540_DLP472TE_LED.img			✓	✓ ⁽²⁾		
Flash_DLPC7540_DLP472TE_LPCW.img			✓	✓ ⁽²⁾		
Flash_DLPC7540_DLP472NE_LED.img			✓ ⁽²⁾	✓		
Flash_DLPC7540_DLP472NE_LPCW.img			✓ ⁽²⁾	✓		
Flash_DLPC7540_DLP650TE_LED.img					✓	✓ ⁽²⁾
Flash_DLPC7540_DLP650TE_LPCW.img					✓	✓ ⁽²⁾
Flash_DLPC7540_DLP651NE_LED.img					✓ ⁽²⁾	✓
Flash_DLPC7540_DLP651NE_LPCW.img					✓ ⁽²⁾	✓

(1) The DMD supporting firmware and DLPDLC-GUI can be found in the EVM tool folder and in the product pages on TI.com. These are the product pages for the [DLP471TE](#), [DLP471NE](#), [DLP472TE](#), [DLP472NE](#), [DLP650TE](#), [DLP651NE](#), and the [DLPC7540](#).

(2) XPR operation which is required for 4K resolution is disabled.

3.1.2 Connecting the DLP471TEEVM, DLP472TEEVM, or DLP650TEEVM, to the DLPC7540EVM

Before connecting the DLP471TEEVM/DLP472TEEVM/DLP650TEEVM to the DLPC7540EVM, locate the two flex cables that are packaged with the DLP471TEEVM/DLP472TEEVM/DLP650TEEVM. Make sure the flex cables are not torn or damaged before connecting the DMD EVMs or the DLPC7540EVM.

The flex cables are exactly the same, meaning there is not a *right* or *left* cable. The cables are interchangeable.

Connect the DLP471TEEVM, DLP472TEEVM, or DLP650TEEVM to the DLPC7540EVM formatter board by connecting the two flex cables matching the board connectors as listed in [Table 3-2](#).

Table 3-2. Flex Cables Connection Assignment

DLPC7540EVM (Formatter Board)	DLP471TEEVM/DLP650TEEVM
J7	J1
J10	J2

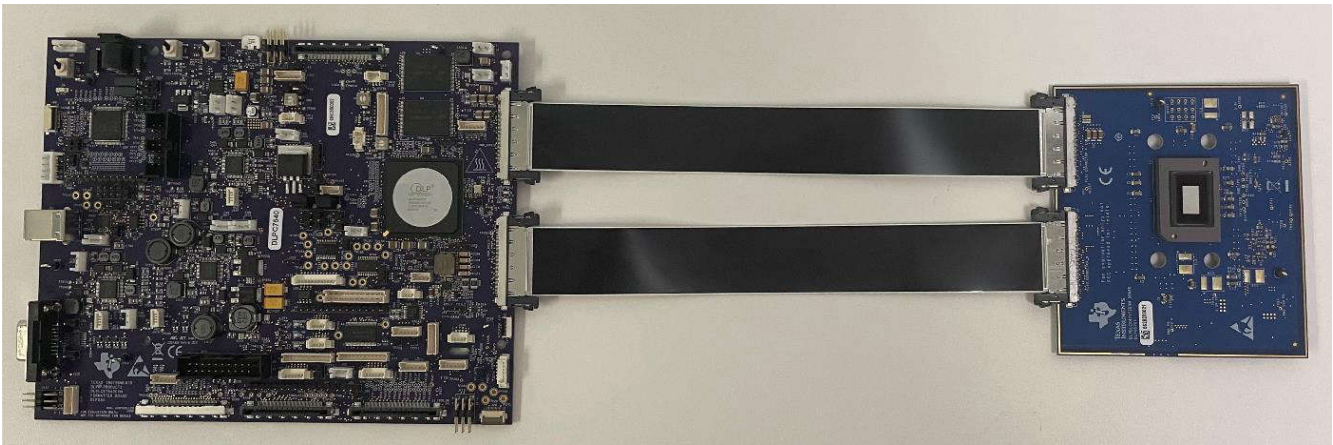

Figure 3-1. Formatter Board and DMD EVM Connected

3.1.3 Powering-up the DLPC7540EVM and Preparing to Program the DLPC7540EVM

There is only one jumper that is included with the DLPC7540EVM. This jumper is installed on J67 during normal operation between formatter and front-end boards. Before powering up the EVM for programming, make sure the included jumper is installed on J9 instead. The jumper locations are listed in [Section 2.2.1](#).

Table 3-3. Reference Designators

Jumper	Description (Bold Indicates Default Position)
J67 - Front End 5V	Uninstalled - 5V not supplied to J3 Installed - Formatter board provides 5V to Front-end board over J3 connection
J9 - Hold in Boot Loader	Uninstalled - Normal Operation Installed - Hold in Boot Loader

Jumper J9 is the *Hold BL* jumper. This jumper is used to put the DLPC7540EVM into boot loader mode, which allows the DLPC7540 controller to be programmed. Connect this jumper to prepare the DLPC7540EVM to be programmed.

To power up the DLPC7540EVM, a 12V, 5A power supply is needed. Make sure the power supply is functional and the switch SW5 and SW1 on the formatter board are set to off before connecting the power supply to the EVM. Connecting the power supply when the switch is in the off position can prevent damage to the DLPC7540EVM from poor power connections. The image below shows SW5 and SW1 and the operating positions.

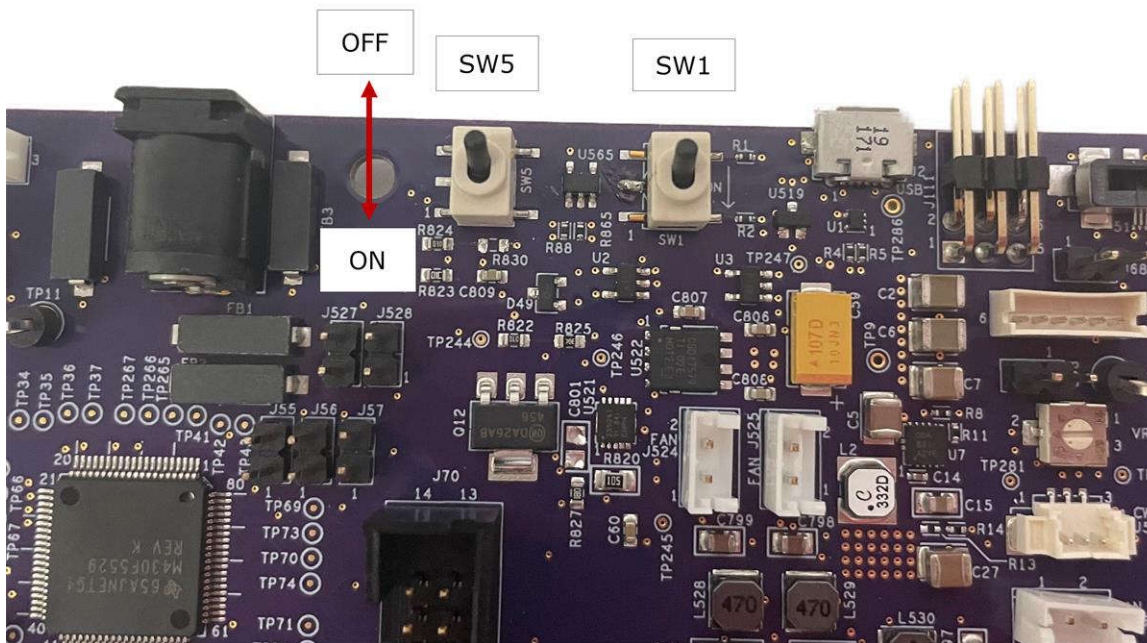

Figure 3-2. ON/OFF Switches

Once the power supply has been connected to the DLPC7540EVM, the switches SW5 and SW1 in that order can be flipped to the *on* position. Users can then plug in the USB cable to J2 of the board to prepare for programming the board. Verify that D5, D6, D7 and D15 LEDs are on.

3.1.4 Programming the DLPC7540EVM and Displaying a SPLASH Image

Follow these steps to download and configure the DLPDLC-GUI for DLPC7540 operation:

1. Download the DLPDLC-GUI and the Firmware SW package that includes the Firmware binary (.img) files for DLP471TE, DLP472TE, and DLP650TE.
2. Install and open the DLPDLC-GUI
3. Setting up communication preferences:
 - a. DLPDLC-GUI supports USB and I2C communication. To change these settings in GUI, please go to Debug screen and select Connection tab.
 - b. For USB, select the USB interface and click *Connect*; see [Figure 3-3](#).

Note

USB is the preferred interface to download the firmware flash image to the EVM as USB is much faster than I2C and does not require any additional hardware.

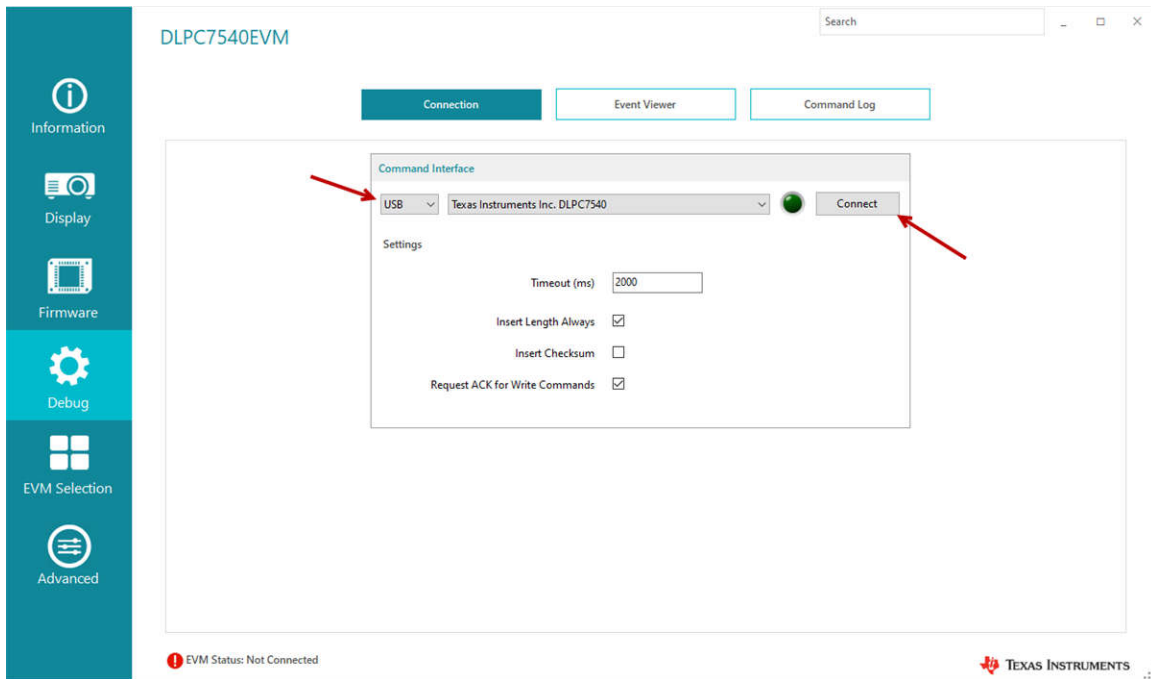

Figure 3-3. Command Interface Settings

- c. Verify that EVM Status shown at bottom left of GUI says *Connected, Bootloader Mode* indicating you are ready to load image file into EVM.
4. Flash Loader Configuration:
 - a. Go to Firmware screen, select Update Firmware tab. Click on the folder icon to browse for the applicable firmware depending on the actual DMD that is connected to DLPC7540EVM. Once firmware image file is selected, click on *Start Update*; see [Figure 3-4](#).
 - b. Wait for the programming progress to indicate that firmware update is complete.
 - c. Turn off the EVM by toggling the SW1 and SW5 switches in that order to *off* position. Remove the jumper from J9 and install back to J67.
 - d. Turn on the EVM by toggling the SW5 and SW1 switches in that order to *on* position. After about 3 seconds, users see D5, D6, and D7 LEDs steadily on and D15 LED flashing. The DLP Texas Instruments logo is visible on the DMD; see [Figure 3-5](#).

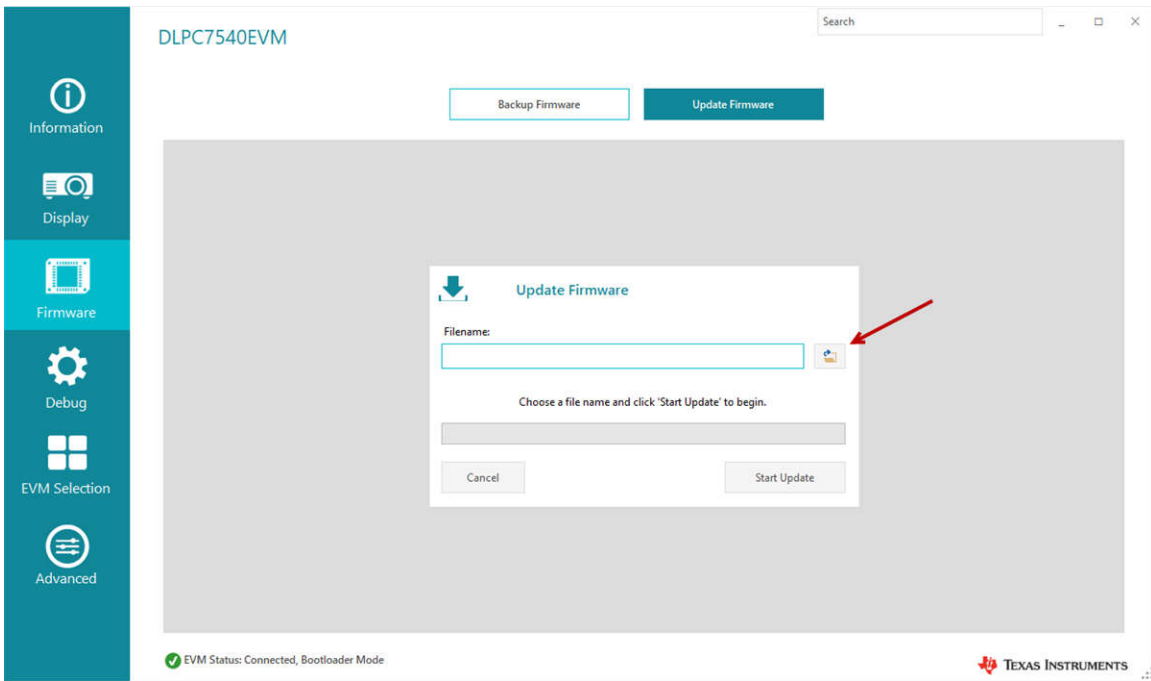

Figure 3-4. Loading the Flash Image

Note

If there is an issue with USB communication, then turn off DLPC7540EVM and disconnect then reconnect USB cable and power on board.

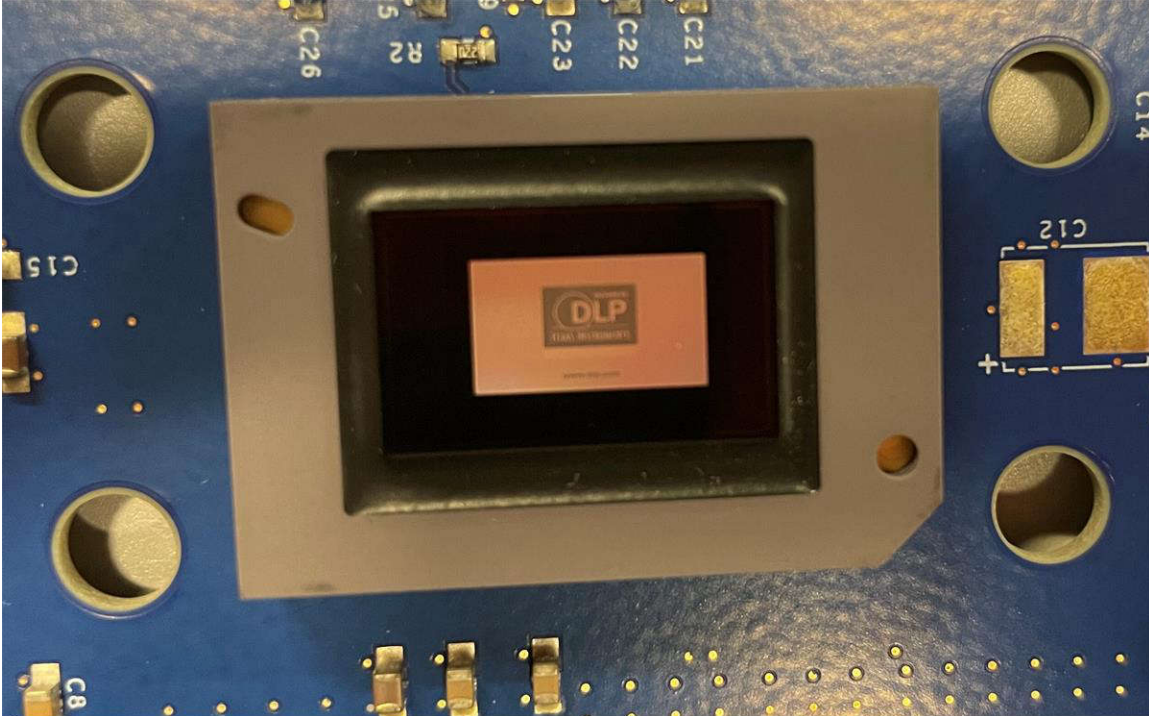

Figure 3-5. Splash Image Displayed on DMD

3.1.5 Troubleshooting

Table 3-4. Troubleshooting the Problem and the Possible Resolutions

Problem	Possible Resolutions
EVM Status: Not Connected	<ol style="list-style-type: none"> 1. USB cable not connected. 2. Command interface not set to USB. Go to Debug screen, Connection tab and select USB as the Command Interface, click Connect. 3. If the user has gone from using Advanced mode back to the DLPDLC-GUI, then user needs to click on EVM Status message on bottom left of DLPDLC-GUI screen to reestablish connection with GUI.

4 Hardware Design Files

The design files for DLP471TEEVMM are available on the EVM tool page: [DLP471TEEVMM](#).

The design files for DLP472TEEVMM are available on the EVM tool page: [DLP472TEEVMM](#).

The design files for DLP650TEEVMM are available on the EVM tool page: [DLP650TEEVMM](#).

The design files for DLPC7540EVM are available on the EVM tool page: [DLPC7540EVM](#).

5 Additional Information

5.1 Safety

5.1.1 Caution Labels



CAUTION

The kit contains ESD-sensitive components.
Handle with care to prevent permanent damage.

5.1.2 If You Need Assistance

Refer to the [DLP E2E Community support forums](#).

5.2 Trademarks

DLP® is a registered trademark of Texas Instruments.

All trademarks are the property of their respective owners.

6 Related Documentation

1. Texas Instruments, [DLP471TE Digital Micromirror Device \(DMD\)](#) data sheet.
2. Texas Instruments, [DLP472TE Digital Micromirror Device \(DMD\)](#) data sheet.
3. Texas Instruments, [DLP650TE Digital Micromirror Device \(DMD\)](#) data sheet.
4. Texas Instruments, [DLPC7540 DLP Display Controller](#) data sheet.
5. Texas Instruments, [DLPA100 Power Management and Motor Driver](#) data sheet.

7 Revision History

NOTE: Page numbers for previous revisions may differ from page numbers in the current version.

Changes from Revision * (May 2021) to Revision A (September 2024)	Page
• Added DLP472NE and DLP472TE DMDs throughout document.....	1
• Added note.....	3

STANDARD TERMS FOR EVALUATION MODULES

1. *Delivery:* TI delivers TI evaluation boards, kits, or modules, including any accompanying demonstration software, components, and/or documentation which may be provided together or separately (collectively, an "EVM" or "EVMs") to the User ("User") in accordance with the terms set forth herein. User's acceptance of the EVM is expressly subject to the following terms.
 - 1.1 EVMs are intended solely for product or software developers for use in a research and development setting to facilitate feasibility evaluation, experimentation, or scientific analysis of TI semiconductors products. EVMs have no direct function and are not finished products. EVMs shall not be directly or indirectly assembled as a part or subassembly in any finished product. For clarification, any software or software tools provided with the EVM ("Software") shall not be subject to the terms and conditions set forth herein but rather shall be subject to the applicable terms that accompany such Software
 - 1.2 EVMs are not intended for consumer or household use. EVMs may not be sold, sublicensed, leased, rented, loaned, assigned, or otherwise distributed for commercial purposes by Users, in whole or in part, or used in any finished product or production system.
2. *Limited Warranty and Related Remedies/Disclaimers:*
 - 2.1 These terms do not apply to Software. The warranty, if any, for Software is covered in the applicable Software License Agreement.
 - 2.2 TI warrants that the TI EVM will conform to TI's published specifications for ninety (90) days after the date TI delivers such EVM to User. Notwithstanding the foregoing, TI shall not be liable for a nonconforming EVM if (a) the nonconformity was caused by neglect, misuse or mistreatment by an entity other than TI, including improper installation or testing, or for any EVMs that have been altered or modified in any way by an entity other than TI, (b) the nonconformity resulted from User's design, specifications or instructions for such EVMs or improper system design, or (c) User has not paid on time. Testing and other quality control techniques are used to the extent TI deems necessary. TI does not test all parameters of each EVM. User's claims against TI under this Section 2 are void if User fails to notify TI of any apparent defects in the EVMs within ten (10) business days after delivery, or of any hidden defects with ten (10) business days after the defect has been detected.
 - 2.3 TI's sole liability shall be at its option to repair or replace EVMs that fail to conform to the warranty set forth above, or credit User's account for such EVM. TI's liability under this warranty shall be limited to EVMs that are returned during the warranty period to the address designated by TI and that are determined by TI not to conform to such warranty. If TI elects to repair or replace such EVM, TI shall have a reasonable time to repair such EVM or provide replacements. Repaired EVMs shall be warranted for the remainder of the original warranty period. Replaced EVMs shall be warranted for a new full ninety (90) day warranty period.

WARNING

Evaluation Kits are intended solely for use by technically qualified, professional electronics experts who are familiar with the dangers and application risks associated with handling electrical mechanical components, systems, and subsystems.

User shall operate the Evaluation Kit within TI's recommended guidelines and any applicable legal or environmental requirements as well as reasonable and customary safeguards. Failure to set up and/or operate the Evaluation Kit within TI's recommended guidelines may result in personal injury or death or property damage. Proper set up entails following TI's instructions for electrical ratings of interface circuits such as input, output and electrical loads.

NOTE:

EXPOSURE TO ELECTROSTATIC DISCHARGE (ESD) MAY CAUSE DEGRADATION OR FAILURE OF THE EVALUATION KIT; TI RECOMMENDS STORAGE OF THE EVALUATION KIT IN A PROTECTIVE ESD BAG.

3 Regulatory Notices:

3.1 United States

3.1.1 Notice applicable to EVMs not FCC-Approved:

FCC NOTICE: This kit is designed to allow product developers to evaluate electronic components, circuitry, or software associated with the kit to determine whether to incorporate such items in a finished product and software developers to write software applications for use with the end product. This kit is not a finished product and when assembled may not be resold or otherwise marketed unless all required FCC equipment authorizations are first obtained. Operation is subject to the condition that this product not cause harmful interference to licensed radio stations and that this product accept harmful interference. Unless the assembled kit is designed to operate under part 15, part 18 or part 95 of this chapter, the operator of the kit must operate under the authority of an FCC license holder or must secure an experimental authorization under part 5 of this chapter.

3.1.2 For EVMs annotated as FCC – FEDERAL COMMUNICATIONS COMMISSION Part 15 Compliant:

CAUTION

This device complies with part 15 of the FCC Rules. Operation is subject to the following two conditions: (1) This device may not cause harmful interference, and (2) this device must accept any interference received, including interference that may cause undesired operation.

Changes or modifications not expressly approved by the party responsible for compliance could void the user's authority to operate the equipment.

FCC Interference Statement for Class A EVM devices

NOTE: This equipment has been tested and found to comply with the limits for a Class A digital device, pursuant to part 15 of the FCC Rules. These limits are designed to provide reasonable protection against harmful interference when the equipment is operated in a commercial environment. This equipment generates, uses, and can radiate radio frequency energy and, if not installed and used in accordance with the instruction manual, may cause harmful interference to radio communications. Operation of this equipment in a residential area is likely to cause harmful interference in which case the user will be required to correct the interference at his own expense.

FCC Interference Statement for Class B EVM devices

NOTE: This equipment has been tested and found to comply with the limits for a Class B digital device, pursuant to part 15 of the FCC Rules. These limits are designed to provide reasonable protection against harmful interference in a residential installation. This equipment generates, uses and can radiate radio frequency energy and, if not installed and used in accordance with the instructions, may cause harmful interference to radio communications. However, there is no guarantee that interference will not occur in a particular installation. If this equipment does cause harmful interference to radio or television reception, which can be determined by turning the equipment off and on, the user is encouraged to try to correct the interference by one or more of the following measures:

- Reorient or relocate the receiving antenna.
- Increase the separation between the equipment and receiver.
- Connect the equipment into an outlet on a circuit different from that to which the receiver is connected.
- Consult the dealer or an experienced radio/TV technician for help.

3.2 Canada

3.2.1 For EVMs issued with an Industry Canada Certificate of Conformance to RSS-210 or RSS-247

Concerning EVMs Including Radio Transmitters:

This device complies with Industry Canada license-exempt RSSs. Operation is subject to the following two conditions:

(1) this device may not cause interference, and (2) this device must accept any interference, including interference that may cause undesired operation of the device.

Concernant les EVMs avec appareils radio:

Le présent appareil est conforme aux CNR d'Industrie Canada applicables aux appareils radio exempts de licence. L'exploitation est autorisée aux deux conditions suivantes: (1) l'appareil ne doit pas produire de brouillage, et (2) l'utilisateur de l'appareil doit accepter tout brouillage radioélectrique subi, même si le brouillage est susceptible d'en compromettre le fonctionnement.

Concerning EVMs Including Detachable Antennas:

Under Industry Canada regulations, this radio transmitter may only operate using an antenna of a type and maximum (or lesser) gain approved for the transmitter by Industry Canada. To reduce potential radio interference to other users, the antenna type and its gain should be so chosen that the equivalent isotropically radiated power (e.i.r.p.) is not more than that necessary for successful communication. This radio transmitter has been approved by Industry Canada to operate with the antenna types listed in the user guide with the maximum permissible gain and required antenna impedance for each antenna type indicated. Antenna types not included in this list, having a gain greater than the maximum gain indicated for that type, are strictly prohibited for use with this device.

Concernant les EVMs avec antennes détachables

Conformément à la réglementation d'Industrie Canada, le présent émetteur radio peut fonctionner avec une antenne d'un type et d'un gain maximal (ou inférieur) approuvé pour l'émetteur par Industrie Canada. Dans le but de réduire les risques de brouillage radioélectrique à l'intention des autres utilisateurs, il faut choisir le type d'antenne et son gain de sorte que la puissance isotrope rayonnée équivalente (p.i.r.e.) ne dépasse pas l'intensité nécessaire à l'établissement d'une communication satisfaisante. Le présent émetteur radio a été approuvé par Industrie Canada pour fonctionner avec les types d'antenne énumérés dans le manuel d'usage et ayant un gain admissible maximal et l'impédance requise pour chaque type d'antenne. Les types d'antenne non inclus dans cette liste, ou dont le gain est supérieur au gain maximal indiqué, sont strictement interdits pour l'exploitation de l'émetteur.

3.3 Japan

3.3.1 *Notice for EVMs delivered in Japan:* Please see http://www.tij.co.jp/lstds/ti_ja/general/eStore/notice_01.page 日本国内に輸入される評価用キット、ボードについては、次のところをご覧ください。

<https://www.ti.com/ja-jp/legal/notice-for-evaluation-kits-delivered-in-japan.html>

3.3.2 *Notice for Users of EVMs Considered "Radio Frequency Products" in Japan:* EVMs entering Japan may not be certified by TI as conforming to Technical Regulations of Radio Law of Japan.

If User uses EVMs in Japan, not certified to Technical Regulations of Radio Law of Japan, User is required to follow the instructions set forth by Radio Law of Japan, which includes, but is not limited to, the instructions below with respect to EVMs (which for the avoidance of doubt are stated strictly for convenience and should be verified by User):

1. Use EVMs in a shielded room or any other test facility as defined in the notification #173 issued by Ministry of Internal Affairs and Communications on March 28, 2006, based on Sub-section 1.1 of Article 6 of the Ministry's Rule for Enforcement of Radio Law of Japan,
2. Use EVMs only after User obtains the license of Test Radio Station as provided in Radio Law of Japan with respect to EVMs, or
3. Use of EVMs only after User obtains the Technical Regulations Conformity Certification as provided in Radio Law of Japan with respect to EVMs. Also, do not transfer EVMs, unless User gives the same notice above to the transferee. Please note that if User does not follow the instructions above, User will be subject to penalties of Radio Law of Japan.

【無線電波を送信する製品の開発キットをお使いになる際の注意事項】 開発キットの中には技術基準適合証明を受けていないものがあります。技術適合証明を受けていないものご使用に際しては、電波法遵守のため、以下のいずれかの措置を取っていただく必要がありますのでご注意ください。

1. 電波法施行規則第6条第1項第1号に基づく平成18年3月28日総務省告示第173号で定められた電波暗室等の試験設備でご使用いただく。
2. 実験局の免許を取得後ご使用いただく。
3. 技術基準適合証明を取得後ご使用いただく。

なお、本製品は、上記の「ご使用にあたっての注意」を譲渡先、移転先に通知しない限り、譲渡、移転できないものとします。

上記を遵守頂けない場合は、電波法の罰則が適用される可能性があることをご留意ください。日本テキサス・イ

ンスツルメンツ株式会社

東京都新宿区西新宿 6 丁目 2 4 番 1 号

西新宿三井ビル

3.3.3 *Notice for EVMs for Power Line Communication:* Please see http://www.tij.co.jp/lstds/ti_ja/general/eStore/notice_02.page

電力線搬送波通信についての開発キットをお使いになる際の注意事項については、次のところをご覧ください。 <https://www.ti.com/ja-jp/legal/notice-for-evaluation-kits-for-power-line-communication.html>

3.4 European Union

3.4.1 *For EVMs subject to EU Directive 2014/30/EU (Electromagnetic Compatibility Directive):*

This is a class A product intended for use in environments other than domestic environments that are connected to a low-voltage power-supply network that supplies buildings used for domestic purposes. In a domestic environment this product may cause radio interference in which case the user may be required to take adequate measures.

-
4. *EVM Use Restrictions and Warnings:*
 - 4.1 EVMS ARE NOT FOR USE IN FUNCTIONAL SAFETY AND/OR SAFETY CRITICAL EVALUATIONS, INCLUDING BUT NOT LIMITED TO EVALUATIONS OF LIFE SUPPORT APPLICATIONS.
 - 4.2 User must read and apply the user guide and other available documentation provided by TI regarding the EVM prior to handling or using the EVM, including without limitation any warning or restriction notices. The notices contain important safety information related to, for example, temperatures and voltages.
 - 4.3 *Safety-Related Warnings and Restrictions:*
 - 4.3.1 User shall operate the EVM within TI's recommended specifications and environmental considerations stated in the user guide, other available documentation provided by TI, and any other applicable requirements and employ reasonable and customary safeguards. Exceeding the specified performance ratings and specifications (including but not limited to input and output voltage, current, power, and environmental ranges) for the EVM may cause personal injury or death, or property damage. If there are questions concerning performance ratings and specifications, User should contact a TI field representative prior to connecting interface electronics including input power and intended loads. Any loads applied outside of the specified output range may also result in unintended and/or inaccurate operation and/or possible permanent damage to the EVM and/or interface electronics. Please consult the EVM user guide prior to connecting any load to the EVM output. If there is uncertainty as to the load specification, please contact a TI field representative. During normal operation, even with the inputs and outputs kept within the specified allowable ranges, some circuit components may have elevated case temperatures. These components include but are not limited to linear regulators, switching transistors, pass transistors, current sense resistors, and heat sinks, which can be identified using the information in the associated documentation. When working with the EVM, please be aware that the EVM may become very warm.
 - 4.3.2 EVMs are intended solely for use by technically qualified, professional electronics experts who are familiar with the dangers and application risks associated with handling electrical mechanical components, systems, and subsystems. User assumes all responsibility and liability for proper and safe handling and use of the EVM by User or its employees, affiliates, contractors or designees. User assumes all responsibility and liability to ensure that any interfaces (electronic and/or mechanical) between the EVM and any human body are designed with suitable isolation and means to safely limit accessible leakage currents to minimize the risk of electrical shock hazard. User assumes all responsibility and liability for any improper or unsafe handling or use of the EVM by User or its employees, affiliates, contractors or designees.
 - 4.4 User assumes all responsibility and liability to determine whether the EVM is subject to any applicable international, federal, state, or local laws and regulations related to User's handling and use of the EVM and, if applicable, User assumes all responsibility and liability for compliance in all respects with such laws and regulations. User assumes all responsibility and liability for proper disposal and recycling of the EVM consistent with all applicable international, federal, state, and local requirements.
 5. *Accuracy of Information:* To the extent TI provides information on the availability and function of EVMs, TI attempts to be as accurate as possible. However, TI does not warrant the accuracy of EVM descriptions, EVM availability or other information on its websites as accurate, complete, reliable, current, or error-free.
 6. *Disclaimers:*
 - 6.1 EXCEPT AS SET FORTH ABOVE, EVMS AND ANY MATERIALS PROVIDED WITH THE EVM (INCLUDING, BUT NOT LIMITED TO, REFERENCE DESIGNS AND THE DESIGN OF THE EVM ITSELF) ARE PROVIDED "AS IS" AND "WITH ALL FAULTS." TI DISCLAIMS ALL OTHER WARRANTIES, EXPRESS OR IMPLIED, REGARDING SUCH ITEMS, INCLUDING BUT NOT LIMITED TO ANY EPIDEMIC FAILURE WARRANTY OR IMPLIED WARRANTIES OF MERCHANTABILITY OR FITNESS FOR A PARTICULAR PURPOSE OR NON-INFRINGEMENT OF ANY THIRD PARTY PATENTS, COPYRIGHTS, TRADE SECRETS OR OTHER INTELLECTUAL PROPERTY RIGHTS.
 - 6.2 EXCEPT FOR THE LIMITED RIGHT TO USE THE EVM SET FORTH HEREIN, NOTHING IN THESE TERMS SHALL BE CONSTRUED AS GRANTING OR CONFERRING ANY RIGHTS BY LICENSE, PATENT, OR ANY OTHER INDUSTRIAL OR INTELLECTUAL PROPERTY RIGHT OF TI, ITS SUPPLIERS/LICENSORS OR ANY OTHER THIRD PARTY, TO USE THE EVM IN ANY FINISHED END-USER OR READY-TO-USE FINAL PRODUCT, OR FOR ANY INVENTION, DISCOVERY OR IMPROVEMENT, REGARDLESS OF WHEN MADE, CONCEIVED OR ACQUIRED.
 7. *USER'S INDEMNITY OBLIGATIONS AND REPRESENTATIONS.* USER WILL DEFEND, INDEMNIFY AND HOLD TI, ITS LICENSORS AND THEIR REPRESENTATIVES HARMLESS FROM AND AGAINST ANY AND ALL CLAIMS, DAMAGES, LOSSES, EXPENSES, COSTS AND LIABILITIES (COLLECTIVELY, "CLAIMS") ARISING OUT OF OR IN CONNECTION WITH ANY HANDLING OR USE OF THE EVM THAT IS NOT IN ACCORDANCE WITH THESE TERMS. THIS OBLIGATION SHALL APPLY WHETHER CLAIMS ARISE UNDER STATUTE, REGULATION, OR THE LAW OF TORT, CONTRACT OR ANY OTHER LEGAL THEORY, AND EVEN IF THE EVM FAILS TO PERFORM AS DESCRIBED OR EXPECTED.

8. *Limitations on Damages and Liability:*

8.1 *General Limitations.* IN NO EVENT SHALL TI BE LIABLE FOR ANY SPECIAL, COLLATERAL, INDIRECT, PUNITIVE, INCIDENTAL, CONSEQUENTIAL, OR EXEMPLARY DAMAGES IN CONNECTION WITH OR ARISING OUT OF THESE TERMS OR THE USE OF THE EVMS , REGARDLESS OF WHETHER TI HAS BEEN ADVISED OF THE POSSIBILITY OF SUCH DAMAGES. EXCLUDED DAMAGES INCLUDE, BUT ARE NOT LIMITED TO, COST OF REMOVAL OR REINSTALLATION, ANCILLARY COSTS TO THE PROCUREMENT OF SUBSTITUTE GOODS OR SERVICES, RETESTING, OUTSIDE COMPUTER TIME, LABOR COSTS, LOSS OF GOODWILL, LOSS OF PROFITS, LOSS OF SAVINGS, LOSS OF USE, LOSS OF DATA, OR BUSINESS INTERRUPTION. NO CLAIM, SUIT OR ACTION SHALL BE BROUGHT AGAINST TI MORE THAN TWELVE (12) MONTHS AFTER THE EVENT THAT GAVE RISE TO THE CAUSE OF ACTION HAS OCCURRED.

8.2 *Specific Limitations.* IN NO EVENT SHALL TI'S AGGREGATE LIABILITY FROM ANY USE OF AN EVM PROVIDED HEREUNDER, INCLUDING FROM ANY WARRANTY, INDEMNITY OR OTHER OBLIGATION ARISING OUT OF OR IN CONNECTION WITH THESE TERMS, , EXCEED THE TOTAL AMOUNT PAID TO TI BY USER FOR THE PARTICULAR EVM(S) AT ISSUE DURING THE PRIOR TWELVE (12) MONTHS WITH RESPECT TO WHICH LOSSES OR DAMAGES ARE CLAIMED. THE EXISTENCE OF MORE THAN ONE CLAIM SHALL NOT ENLARGE OR EXTEND THIS LIMIT.

9. *Return Policy.* Except as otherwise provided, TI does not offer any refunds, returns, or exchanges. Furthermore, no return of EVM(s) will be accepted if the package has been opened and no return of the EVM(s) will be accepted if they are damaged or otherwise not in a resalable condition. If User feels it has been incorrectly charged for the EVM(s) it ordered or that delivery violates the applicable order, User should contact TI. All refunds will be made in full within thirty (30) working days from the return of the components(s), excluding any postage or packaging costs.

10. *Governing Law:* These terms and conditions shall be governed by and interpreted in accordance with the laws of the State of Texas, without reference to conflict-of-laws principles. User agrees that non-exclusive jurisdiction for any dispute arising out of or relating to these terms and conditions lies within courts located in the State of Texas and consents to venue in Dallas County, Texas. Notwithstanding the foregoing, any judgment may be enforced in any United States or foreign court, and TI may seek injunctive relief in any United States or foreign court.

Mailing Address: Texas Instruments, Post Office Box 655303, Dallas, Texas 75265
Copyright © 2023, Texas Instruments Incorporated

IMPORTANT NOTICE AND DISCLAIMER

TI PROVIDES TECHNICAL AND RELIABILITY DATA (INCLUDING DATA SHEETS), DESIGN RESOURCES (INCLUDING REFERENCE DESIGNS), APPLICATION OR OTHER DESIGN ADVICE, WEB TOOLS, SAFETY INFORMATION, AND OTHER RESOURCES "AS IS" AND WITH ALL FAULTS, AND DISCLAIMS ALL WARRANTIES, EXPRESS AND IMPLIED, INCLUDING WITHOUT LIMITATION ANY IMPLIED WARRANTIES OF MERCHANTABILITY, FITNESS FOR A PARTICULAR PURPOSE OR NON-INFRINGEMENT OF THIRD PARTY INTELLECTUAL PROPERTY RIGHTS.

These resources are intended for skilled developers designing with TI products. You are solely responsible for (1) selecting the appropriate TI products for your application, (2) designing, validating and testing your application, and (3) ensuring your application meets applicable standards, and any other safety, security, regulatory or other requirements.

These resources are subject to change without notice. TI grants you permission to use these resources only for development of an application that uses the TI products described in the resource. Other reproduction and display of these resources is prohibited. No license is granted to any other TI intellectual property right or to any third party intellectual property right. TI disclaims responsibility for, and you will fully indemnify TI and its representatives against, any claims, damages, costs, losses, and liabilities arising out of your use of these resources.

TI's products are provided subject to [TI's Terms of Sale](#) or other applicable terms available either on [ti.com](https://www.ti.com) or provided in conjunction with such TI products. TI's provision of these resources does not expand or otherwise alter TI's applicable warranties or warranty disclaimers for TI products.

TI objects to and rejects any additional or different terms you may have proposed.

Mailing Address: Texas Instruments, Post Office Box 655303, Dallas, Texas 75265
Copyright © 2024, Texas Instruments Incorporated