

TPS7A43 パワー・グッド、精度イネーブルおよび選択可能な中間出力レールを備えた 50mA、85V、超低 I_Q 、低ドロップアウトのリニア電圧レギュレータ

1 特長

- 入力電圧: 4V~85V
- 広い出力 (OUT) 電圧範囲:
 - 可変: 1.24V~14.5V
 - 固定: 1.25V~5.0V
- 選択可能な中間出力 (MID_OUT):
 - 10V、12V、15V
- 最大出力電流:
 - 50mA (OUT と MID_OUT の合計)
- 温度範囲全体で 1% の精度
- きわめて低い I_Q : 5.5 μ A
- 高精度のイネーブル
- パワー・グッド (PG) 出力 (オープン・ドレイン)
- サーマル・シャットダウン機能と過電流保護機能
- 動作時接合部温度: -40°C~+125°C
- パッケージ: HVSSOP-10 ($R_{\theta JA} = 53.7^\circ\text{C/W}$)

2 アプリケーション

- コードレス電動工具
- DC モータおよびファン
- プログラマブル・ロジック・コントローラ (PLC)
- フィールド・トランスミッタとプロセス・センサ
- 煙感知器と熱感知器
- EV 充電インフラ
- バッテリー・パック

3 概要

TPS7A43 低ドロップアウト (LDO) リニア電圧レギュレータは、4V~85V の入力電圧と、非常に低い静止電流が特長です。

このデバイスは幅広い入力電圧 (例: 15s バッテリー、24V~48V ライン電源) に対応しており、最大 85V のライン過渡電圧に耐えます。

これらの特長は、ますます厳しくなるエネルギー要件を最新のアプリケーションが満たし、携帯型電源ソリューションのバッテリー駆動時間を伸ばすのに役立ちます。

TPS7A43 は、出力 (OUT) が固定と可変の両方のバージョンで提供しており、1.24V~14.5V の電圧を 1% の精度でレギュレートできます。本デバイスは、MVSEL ピンを使って 10V、12V、15V に設定でき、ディスクリート・レギュレータの代わりにゲート・ドライバにバイアスを印加する目的で使える第 2 の中間出力 (MID_OUT) も備えています。

TPS7A43 は、入力に接続した抵抗分圧器を使って、固定の正確なスレッショルド電圧で LDO を有効または無効にするのに便利な高精度イネーブル入力を備えています。

パワー・グッド出力 (PG) を使うと、フィードバック・ピンの電圧を監視して出力電圧のステータスを表示できます。EN 入力および PG 出力を使用して、システムの複数の電源をシーケンシングできます。

パッケージ情報 (1)

部品番号	パッケージ	本体サイズ (公称)
TPS7A43	DGQ (HVSSOP, 10)	3.00mm × 3.00mm

- (1) 利用可能なパッケージについては、データシートの末尾にあるパッケージ・オプションについての付録を参照してください。

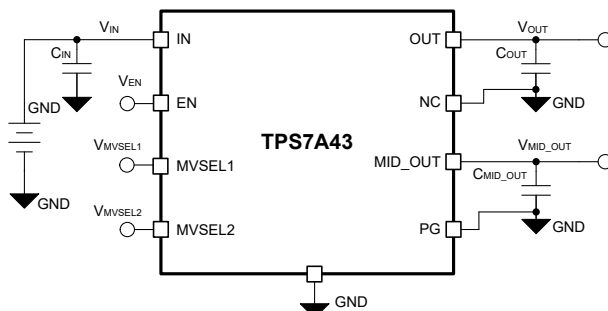

代表的なアプリケーション回路

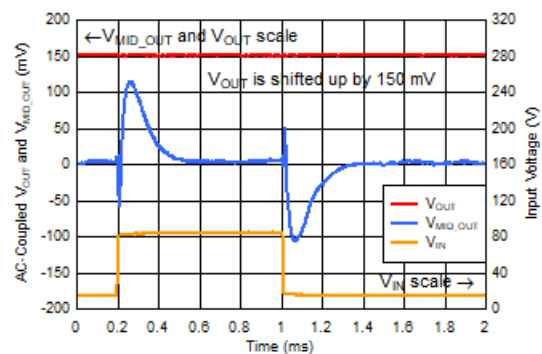

ライン過渡 ($V_{MID_OUT} = 12V$ 、 $V_{OUT} = 3.3V$ 、 $I_{OUT} = 50mA$)



Table of Contents

1 特長	1	7.4 Device Functional Modes.....	20
2 アプリケーション	1	8 Application and Implementation	21
3 概要	1	8.1 Application Information.....	21
4 Revision History	2	8.2 Typical Application.....	23
5 Pin Configuration and Functions	3	8.3 Power Supply Recommendations.....	25
6 Specifications	4	8.4 Layout.....	25
6.1 Absolute Maximum Ratings.....	4	9 Device and Documentation Support	27
6.2 ESD Ratings.....	4	9.1 Device Support.....	27
6.3 Recommended Operating Conditions.....	5	9.2 Documentation Support.....	27
6.4 Thermal Information.....	5	9.3 Receiving Notification of Documentation Updates....	27
6.5 Electrical Characteristics.....	6	9.4 サポート・リソース.....	27
6.6 Typical Characteristics.....	8	9.5 Trademarks.....	27
7 Detailed Description	15	9.6 Electrostatic Discharge Caution.....	27
7.1 Overview.....	15	9.7 Glossary.....	28
7.2 Functional Block Diagrams.....	15	10 Mechanical, Packaging, and Orderable Information	28
7.3 Feature Description.....	16		

4 Revision History

資料番号末尾の英字は改訂を表しています。その改訂履歴は英語版に準じています。

Changes from Revision A (September 2022) to Revision B (November 2022) Page

• ドキュメントのタイトルを変更.....	1
-----------------------	---

Changes from Revision * (December 2020) to Revision A (September 2022) Page

• ドキュメントのステータスを「事前情報」から「量産データ」に変更	1
---	---

5 Pin Configuration and Functions



图 5-1. DGQ Package (Adjustable), 10-Pin HVSSOP (Top View)



图 5-2. DGQ Package (Fixed), 10-Pin HVSSOP (Top View)

表 5-1. Pin Functions

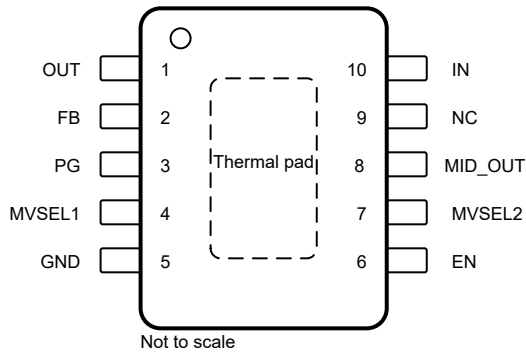
NAME	PIN		TYPE	DESCRIPTION
	DGQ (Adjustable)	DGQ (Fixed)		
EN	6	6	Input	Precision enable pin. Driving this pin higher than $V_{EN(HI)}$ enables the device. Driving this pin lower than $V_{EN(LOW)}$ disables the device. This pin can be left floating to enable the device because the device features an internal pullup current source. If this pin is tied to the IN pin then the input voltage must not exceed 18 V; see the Recommended Operating Conditions table.
FB	2	—	Input	Feedback pin. Input to the control-loop error amplifier for the (OUT) output. This pin is used to set the output voltage of the device with the use of external resistors. For adjustable-voltage version devices only. This pin must not be left floating.
GND	5	5	—	Ground pin.
IN	10	10	Input	Input pin. For best transient response and to minimize input impedance, use the recommended value or larger ceramic capacitor from IN to ground; see the Recommended Operating Conditions table. Place the input capacitor as close to the IN and GND pins of the device as possible.
MID_OUT	8	8	Output	MID output pin. A capacitor is required from MID_OUT to ground for stability. For best transient response, use the nominal recommended value or larger capacitor from MID_OUT to ground. Follow the recommended capacitor value as listed in the Recommended Operating Conditions table. Place the MID output capacitor as close to the MID_OUT and GND pins of the device as possible.
MVSEL1	4	4	Input	MID_OUT voltage-select pin. The MVSEL1 pin and MVSEL2 pin are used to set the MID_OUT voltage; see the MID_OUT Voltage Setting section for details on how to set the MID_OUT voltage using these pins. Do not float this pin, instead tie this pin to GND if not used to set V_{MID_OUT} .
MVSEL2	7	7	Input	MID_OUT voltage-select pin. The MVSEL2 pin and MVSEL1 pin are used to set the MID_OUT voltage; see the MID_OUT Voltage Setting section for details on how to set the MID_OUT voltage using these pins. Do not float this pin, instead tie this pin to GND if not used to set V_{MID_OUT} .
NC	9	9	—	No internal connection. This pin must be left floating to observe high voltage clearance between the IN and MID_OUT pins.
NC	—	2	—	No internal connection. This pin can be left floating or tied to the GND plane to improve thermal performance.
OUT	1	1	Output	Output pin. A capacitor is required from OUT to ground for stability. For best transient response, use the nominal recommended value or larger capacitor from OUT to ground. Follow the recommended capacitor value as listed in the Recommended Operating Conditions table. Place the output capacitor as close to the OUT and GND pins of the device as possible.

表 5-1. Pin Functions (continued)

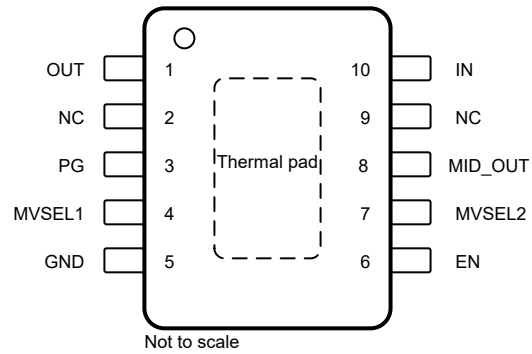
PIN			TYPE	DESCRIPTION
NAME	DGQ (Adjustable)	DGQ (Fixed)		
PG	3	3	Output	Power-good pin. An open-drain output indicates when the output voltage reaches $V_{IT(PG, RISING)}$; see the Electrical Characteristics table. If not used, this pin can be left floating or tied to the GND plane to improve thermal performance.
Thermal pad	Pad	Pad	—	Exposed pad of the package. Connect this pad to ground or leave floating. Connect the thermal pad to a large-area GND plane for improved thermal performance.

6 Specifications

6.1 Absolute Maximum Ratings

over operating free-air temperature range (unless otherwise noted)⁽¹⁾

		MIN	MAX	UNIT
Voltage ⁽²⁾	V_{IN}	-0.3	90 ⁽³⁾	V
	V_{OUT} (adjustable version)	-0.3	$V_{MID} + 0.3$ ⁽⁴⁾	
	V_{OUT} (fixed version)	-0.3	5.5	
	V_{MID_OUT}	-0.3	$V_{IN} + 0.3$ ⁽⁵⁾	
	V_{FB}	-0.3	5.5	
	V_{EN}	-0.3	20	
	V_{MVSEL1}	-0.3	20	
	V_{MVSEL2}	-0.3	20	
Current	Maximum output	Internally limited		A
	Maximum MID output	Internally limited		
Temperature	Operating junction, T_J	-50	150	°C
	Storage, T_{stg}	-65	150	

- (1) Operation outside the Absolute Maximum Ratings may cause permanent device damage. Absolute Maximum Ratings do not imply functional operation of the device at these or any other conditions beyond those listed under Recommended Operating Conditions. If briefly operating outside the Recommended Operating Conditions but within the Absolute Maximum Ratings, the device may not sustain damage, but it may not be fully functional – this may affect device reliability, functionality, performance, and shorten the device lifetime.
- (2) All voltages with respect to GND.
- (3) Absolute maximum voltage, withstand 90 V for 200 ms.
- (4) $V_{MID_OUT} + 0.3$ V or 20 V (whichever is smaller).
- (5) $V_{IN} + 0.3$ V or 20 V (whichever is smaller).

6.2 ESD Ratings

			VALUE	UNIT
$V_{(ESD)}$	Electrostatic discharge	Human body model (HBM), per ANSI/ESDA/JEDEC JS-001 ⁽¹⁾	±2000	V
		Charged device model (CDM), per JEDEC specification JESD22-C101 ⁽²⁾	±750	

- (1) JEDEC document JEP155 states that 2-kV HBM allows safe manufacturing with a standard ESD control process.
- (2) JEDEC document JEP157 states that 500-V CDM allows safe manufacturing with a standard ESD control process.

6.3 Recommended Operating Conditions

		MIN	NOM	MAX	UNIT
V _{IN}	Input voltage	4		85	V
V _{MID_OUT}	MID output voltage	10		15	V
V _{OUT}	Output voltage (adjustable version)	1.24		V _{MID_OUT} – V _{DO(OUT)}	V
V _{OUT}	Output voltage (fixed version)	1.25		5.5	V
I _{OUT}	Output current	0		50 – I _{MID_OUT}	mA
I _{MID_OUT}	MID rail output current	0		50	mA
V _{MVSEL1}	MID voltage select input voltage 1	0		18	V
V _{MVSEL2}	MID voltage select input voltage 2	0		18	V
V _{EN}	Enable voltage	0		18	V
V _{PG} ⁽¹⁾	Power-good voltage	0		18	V
C _{IN} ⁽²⁾	Input capacitor		0.1		μF
C _{OUT} ⁽²⁾	Output capacitor	1	2.2	100	μF
C _{MID_OUT} ^{(2) (3)}	MID output capacitor	3 × C _{OUT}			μF
T _J	Operating junction temperature	–40		125	°C

- (1) Select pullup resistor to limit PG pin sink current when PG output is driven low. See the *Power Good* section for details.
 (2) All capacitor values are assumed to derate to 50% of the nominal capacitor value.
 (3) Maintain a 3:1 ratio between C_{MID_OUT} vs C_{OUT} for stability.

6.4 Thermal Information

THERMAL METRIC ⁽¹⁾		TPS7A43	UNIT
		HVSSOP (DGQ)	
		8 PINS	
R _{θJA}	Junction-to-ambient thermal resistance	53.7	°C/W
R _{θJC(top)}	Junction-to-case (top) thermal resistance	76.6	°C/W
R _{θJB}	Junction-to-board thermal resistance	26.8	°C/W
Ψ _{JT}	Junction-to-top characterization parameter	3.6	°C/W
Ψ _{JB}	Junction-to-board characterization parameter	26.7	°C/W
R _{θJC(bot)}	Junction-to-case (bottom) thermal resistance	9.6	°C/W

- (1) For more information about traditional and new thermal metrics, see the [Semiconductor and IC Package Thermal Metrics](#) application report.

6.5 Electrical Characteristics

specified at $T_J = -40^\circ\text{C}$ to $+125^\circ\text{C}$, $V_{IN} = V_{OUT(nom)} + 1.5\text{V}$ or 4V , whichever is greater, FB tied to OUT (adjustable version only), $I_{OUT} = 1\text{ mA}$, $I_{MID_OUT} = 0\text{ mA}$, $V_{EN} = 2\text{ V}$, $V_{MVSEL1} = 0.9\text{ V}$, $V_{MVSEL2} = 0.9\text{ V}$, $C_{IN} = 1\text{ }\mu\text{F}$, $C_{MID_OUT} = 4.7\text{ }\mu\text{F}$, and $C_{OUT} = 1\text{ }\mu\text{F}$ (unless otherwise noted); typical values are at $T_J = 25^\circ\text{C}$

PARAMETER		TEST CONDITIONS		MIN	TYP	MAX	UNIT
ΔV_{OUT}	Output voltage accuracy	Adjustable version, $V_{OUT} = V_{FB}$		1.23	1.24	1.25	V
ΔV_{OUT}		Fixed output version, $T_J = 25^\circ\text{C}$		-0.5		0.5	%
ΔV_{OUT}		Fixed output version		-0.75		0.75	
V_{FB}	Feedback voltage	Adjustable version only			1.24		V
$\Delta V_{OUT(\Delta V_{IN})}$	Line regulation ⁽¹⁾	$(V_{OUT(nom)} + 1\text{ V or }4\text{ V}) \leq V_{IN} \leq 85\text{ V}$		-0.05		0.05	%
$\Delta V_{OUT(\Delta V_{IN})}$		$V_{MID_OUT(nom)} + 1.5\text{ V} \leq V_{IN} \leq 85\text{ V}$		-0.05		0.05	
$\Delta V_{OUT(\Delta I_{OUT})}$	Load regulation	$1\text{ mA} \leq I_{OUT} \leq 50\text{ mA}$, $I_{MID_OUT} = 0\text{ mA}$		-0.15		0.10	%
ΔV_{MID_OUT}	MID output voltage accuracy	$V_{IN} = V_{MID_OUT} + 1.5\text{ V}$	$V_{MVSEL1} \leq V_{MVSEL1(LOW)}$, $V_{MVSEL2} \leq V_{MVSEL2(LOW)}$	14.4	15	15.6	V
			$V_{MVSEL1} \leq V_{MVSEL1(LOW)}$ or $V_{MVSEL1} \geq V_{MVSEL1(HIGH)}$, $V_{MVSEL2} \geq V_{MVSEL2(HIGH)}$	11.5	12	12.5	
			$V_{MVSEL1} \geq V_{MVSEL1(HIGH)}$, $V_{MVSEL2} \leq V_{MVSEL2(LOW)}$	9.6	10	10.4	
$\Delta V_{MID_OUT(\Delta V_{IN})}$	Line regulation of MID output ⁽¹⁾	$(V_{MID_OUT(nom)} + 1.5\text{ V} \leq V_{IN} \leq 85\text{ V}$, $I_{MID_OUT} = 1\text{ mA}$, $I_{OUT} = 0\text{ mA}$		-0.1		0.1	%
$\Delta V_{MID_OUT(\Delta I_{OUT})}$	Load regulation of MID output	$1\text{ mA} \leq I_{MID_OUT} \leq 50\text{ mA}$, $V_{IN} = V_{MID_OUT} + 1.5\text{ V}$, $I_{OUT} = 0\text{ mA}$		-0.2		0.1	%
$V_{DO(OUT)}$	Dropout voltage of V_{IN} to V_{OUT} ⁽²⁾	$I_{OUT} = 50\text{ mA}$				800	mV
$V_{DO(OUT)}$	Dropout voltage of V_{MID_OUT} to V_{OUT} ⁽²⁾	$I_{OUT} = 50\text{ mA}$				200	mV
$V_{DO(MID_OUT)}$	Dropout voltage of V_{IN} to V_{MID_OUT} ⁽³⁾	$I_{MID_OUT} = 50\text{ mA}$				600	mV
$I_{CL(OUT)}$	Output current limit	$V_{OUT} = 0.9 \times V_{OUT(nom)}$		100	125	145	mA
$I_{CL(MID_OUT)}$	MID output current limit	$V_{OUT} = 0.9 \times V_{MID_OUT(nom)}$, $V_{IN} = V_{MID_OUT} + 1.5\text{ V}$		118	145	165	mA
I_{GND}	Ground pin current	$I_{OUT} = I_{MID_OUT} = 0\text{ mA}$, $V_{IN} = V_{MID_OUT} + 1.5\text{ V}$	$T_J = 25^\circ\text{C}$		5.5	7	μA
			$T_J = -40^\circ\text{C}$ to $+125^\circ\text{C}$			9	
$I_{SHUTDOWN}$	Shutdown current	$V_{EN} \leq V_{EN(LOW)}$, $V_{IN} = V_{MID_OUT(nom)} + 1.5\text{ V}$, $I_{OUT} = I_{MID_OUT} = 0\text{ mA}$	$T_J = -40^\circ\text{C}$ to $+85^\circ\text{C}$		710	1600	nA
			$T_J = -40^\circ\text{C}$ to $+125^\circ\text{C}$			2100	nA
$I_{SHUTDOWN}$	Shutdown current	$V_{EN} \leq V_{EN(LOW)}$, $V_{IN} = 85\text{ V}$, $I_{OUT} = I_{MID_OUT} = 0\text{ mA}$	$T_J = -40^\circ\text{C}$ to $+85^\circ\text{C}$		710	1900	nA
			$T_J = -40^\circ\text{C}$ to $+125^\circ\text{C}$			2500	
I_{FB}	FB pin current				10		nA
I_{MVSEL1}	MVSEL1 pin current	$V_{MVSEL1} = 18\text{ V}$			10		nA
I_{MVSEL2}	MVSEL2 pin current	$V_{MVSEL2} = 18\text{ V}$			10		nA
I_{EN}	EN pin current	$V_{EN} = 18\text{ V}$			10		nA
$V_{MVSEL1(HIGH)}$	MVSEL1 pin high-level input voltage			0.9			V
$V_{MVSEL1(LOW)}$	MVSEL1 pin low-level input voltage					0.3	V

6.5 Electrical Characteristics (continued)

specified at $T_J = -40^\circ\text{C}$ to $+125^\circ\text{C}$, $V_{IN} = V_{OUT(nom)} + 1.5\text{V}$ or 4V , whichever is greater, FB tied to OUT (adjustable version only), $I_{OUT} = 1\text{ mA}$, $I_{MID_OUT} = 0\text{ mA}$, $V_{EN} = 2\text{ V}$, $V_{MVSEL1} = 0.9\text{ V}$, $V_{MVSEL2} = 0.9\text{ V}$, $C_{IN} = 1\ \mu\text{F}$, $C_{MID_OUT} = 4.7\ \mu\text{F}$, and $C_{OUT} = 1\ \mu\text{F}$ (unless otherwise noted); typical values are at $T_J = 25^\circ\text{C}$

PARAMETER		TEST CONDITIONS		MIN	TYP	MAX	UNIT
$V_{MVSEL2(HIGH)}$	MVSEL2 pin high-level input voltage			0.9			V
$V_{MVSEL2(LOW)}$	MVSEL2 pin low-level input voltage					0.3	V
$V_{EN(HI)}$	Enable rising threshold	Device enabled		1.15	1.24	1.35	V
$V_{EN(LOW)}$	Enable falling threshold	Device disabled		1.11	1.19	1.28	V
$V_{EN(HYST)}$	Enable pin hysteresis				50		mV
$V_{IT(PG,RISING)}$	PG pin threshold rising	$R_{PULLUP} = 10\text{ k}\Omega$, V_{OUT} rising, $V_{IN} \geq V_{UVLO(RISING)}$		88	93	96.5	% V_{OUT}
$V_{HYS(PG)}$	PG pin hysteresis	$R_{PULLUP} = 10\text{ k}\Omega$, V_{OUT} falling, $V_{IN} \geq V_{UVLO(RISING)}$			3		
$V_{IT(PG,FALLING)}$	PG pin threshold falling	$R_{PULLUP} = 10\text{ k}\Omega$, V_{OUT} falling, $V_{IN} \geq V_{UVLO(RISING)}$		84	90	94.5	
$V_{OL(PG)}$	PG pin low level output voltage	$V_{OUT} < V_{IT(PG,FALLING)}$, $I_{PG-SINK} = 500\ \mu\text{A}$				0.4	V
$I_{LKG(PG)}$	PG pin leakage current	$V_{OUT} > V_{IT(PG,RISING)}$, $V_{PG} = 18\text{ V}$			5	130	nA
$PSRR_{(OUT)}$	Power-supply rejection ratio of OUT rail	$I_{OUT} = 20\text{ mA}$	$f = 10\text{ Hz}$		76		dB
			$f = 100\text{ Hz}$		67		
			$f = 1\text{ kHz}$		82		
			$f = 100\text{ kHz}$		73		
$PSRR_{(MID_OUT)}$	Power-supply rejection ratio of MID_OUT rail	$I_{MID_OUT} = 20\text{ mA}$	$f = 10\text{ Hz}$		61		
			$f = 100\text{ Hz}$		64		
			$f = 1\text{ kHz}$		55		
			$f = 100\text{ kHz}$		47		
V_n	Output noise voltage	$BW = 10\text{ Hz to }100\text{ kHz}$, $V_{OUT} = 1.24\text{ V}$			124		μV_{RMS}
$T_{SD(shutdown)}$	Thermal shutdown temperature	Shutdown, temperature increasing			170		$^\circ\text{C}$

- Line regulation from Input of the LDO to the final output of the LDO.
- V_{DO} is measured with $V_{IN} = 0.95 \times V_{OUT(nom)}$ for fixed output voltage versions. V_{DO} is not measured for fixed output voltage versions when $V_{OUT} \leq 3.1\text{ V}$. For the adjustable output device, V_{DO} is measured with $V_{FB} = 0.95 \times V_{FB(nom)}$.
- $V_{DO(MID_OUT)}$ is measured with $V_{IN} = 0.95 \times V_{MID_OUT(nom)}$ for Mid output voltages.

6.6 Typical Characteristics

at operating temperature $T_J = 25^\circ\text{C}$, $I_{OUT} = 1\text{ mA}$, $I_{MID_OUT} = 0\text{ mA}$, $V_{EN} = 2\text{ V}$, $V_{MVSEL1} = 0.9\text{ V}$, $V_{MVSEL2} = 0.9\text{ V}$, $C_{IN} = 1\text{ }\mu\text{F}$, $C_{MID_OUT} = 4.7\text{ }\mu\text{F}$, $C_{OUT} = 1\text{ }\mu\text{F}$, and $V_{IN} = V_{MID_OUT} + 1.5\text{ V}$ (unless otherwise noted); typical values are at $T_J = 25^\circ\text{C}$

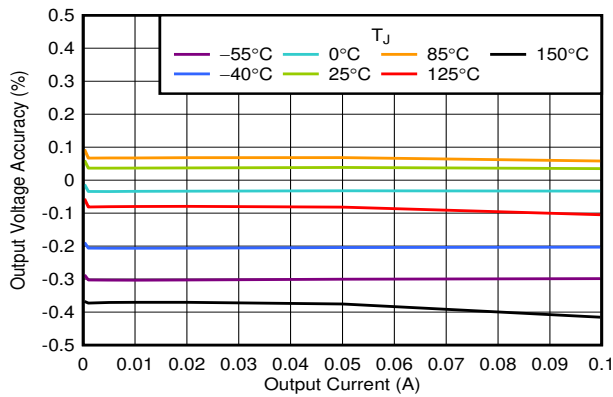

$V_{OUT} = 1.24\text{ V}$ (adjustable)

图 6-1. V_{OUT} Accuracy vs I_{OUT}

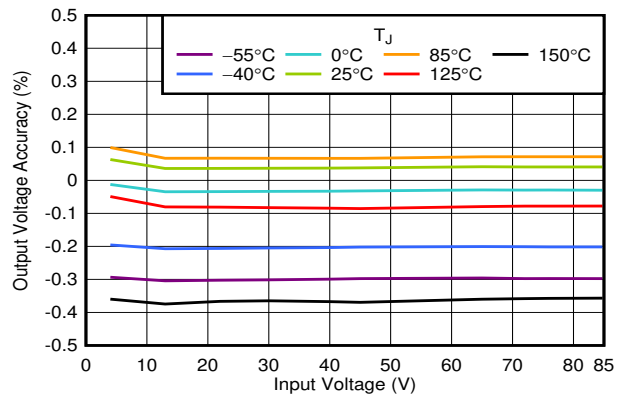

$V_{OUT} = 1.24\text{ V}$ (adjustable)

图 6-2. V_{OUT} Accuracy vs V_{IN}

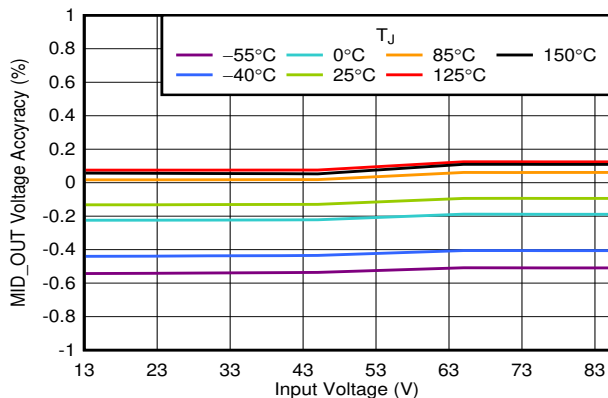

$V_{MID_OUT} = 12\text{ V}$

图 6-3. V_{MID_OUT} Accuracy vs V_{IN}

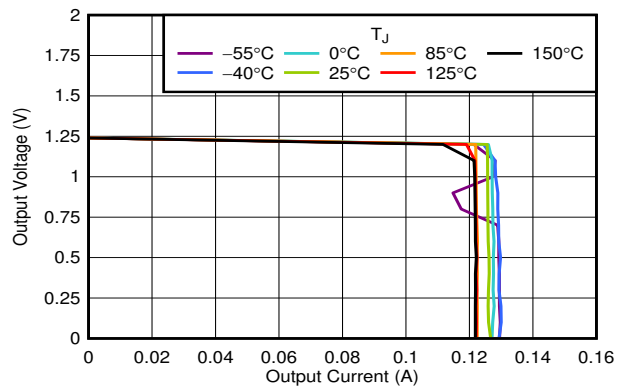

$V_{OUT} = 1.24\text{ V}$ (adjustable)

图 6-4. V_{OUT} vs $I_{CL(OUT)}$

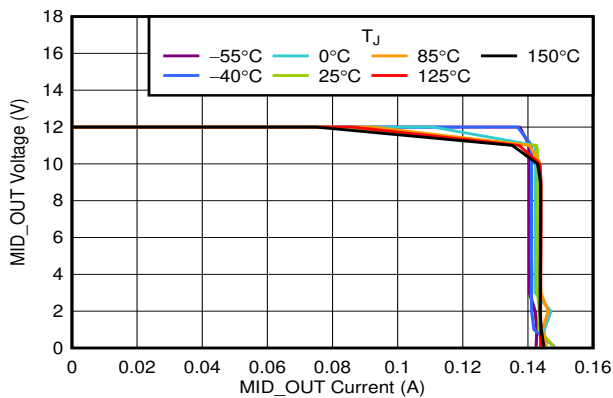

$V_{MID_OUT} = 12\text{ V}$

图 6-5. V_{MID_OUT} vs I_{MID_OUT}

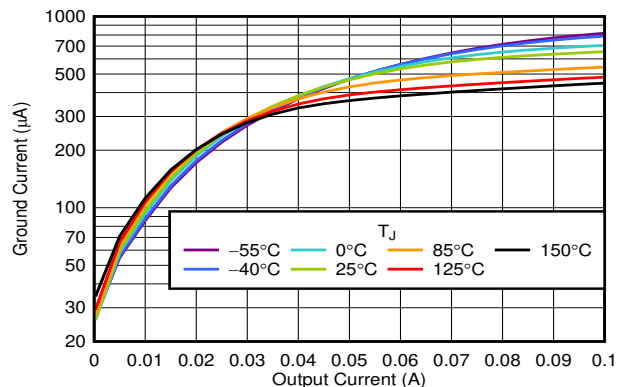

$V_{IN} = 11\text{ V}$, $V_{OUT} = 1.24\text{ V}$ (adjustable)

图 6-6. I_{GND} vs I_{OUT} (MID_OUT in Dropout)

6.6 Typical Characteristics (continued)

at operating temperature $T_J = 25^\circ\text{C}$, $I_{\text{OUT}} = 1\text{ mA}$, $I_{\text{MID_OUT}} = 0\text{ mA}$, $V_{\text{EN}} = 2\text{ V}$, $V_{\text{MVSEL1}} = 0.9\text{ V}$, $V_{\text{MVSEL2}} = 0.9\text{ V}$, $C_{\text{IN}} = 1\text{ }\mu\text{F}$, $C_{\text{MID_OUT}} = 4.7\text{ }\mu\text{F}$, $C_{\text{OUT}} = 1\text{ }\mu\text{F}$, and $V_{\text{IN}} = V_{\text{MID_OUT}} + 1.5\text{ V}$ (unless otherwise noted); typical values are at $T_J = 25^\circ\text{C}$

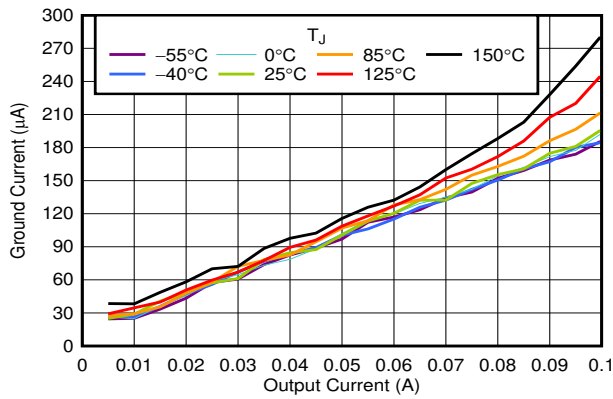

$V_{\text{IN}} = 16.5\text{ V}$, $V_{\text{MID_OUT}} = 15\text{ V}$, $V_{\text{MVSEL1}} = V_{\text{MVSEL2}} = 0\text{ V}$,
 $V_{\text{OUT}} = 1.24\text{ V}$ (adjustable)

6-7. I_{GND} vs I_{OUT}

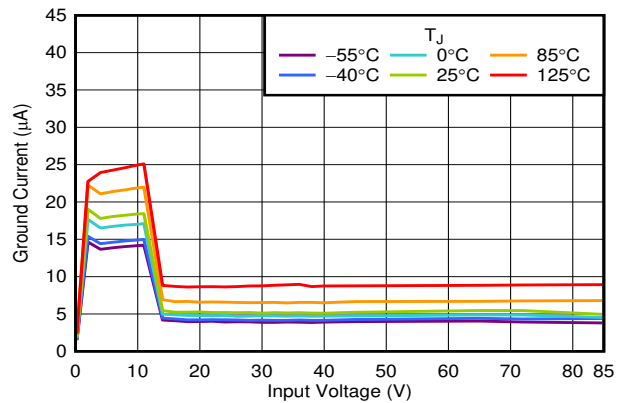

$I_{\text{OUT}} = 0\text{ mA}$

6-8. I_{GND} vs V_{IN}

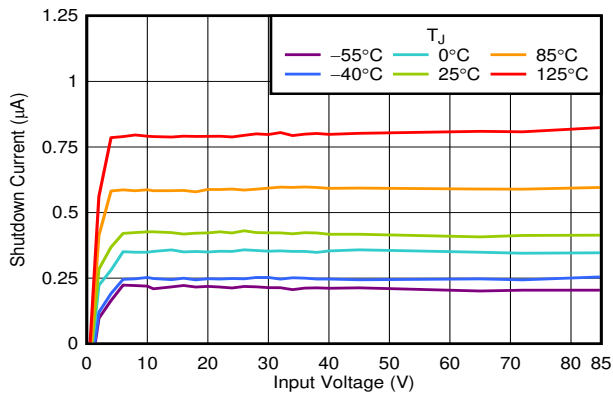

$V_{\text{EN}} = 1\text{ V}$

6-9. I_{SHUTDOWN} vs V_{IN}

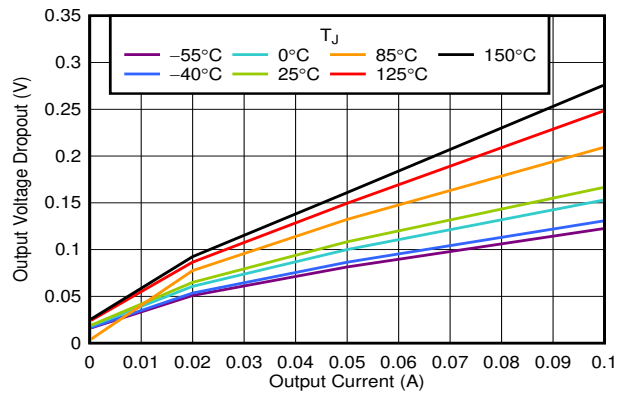

$V_{\text{OUT}} = 1.24\text{ V}$ (adjustable)

6-10. $V_{\text{DO(OUT)}}$ vs I_{OUT}

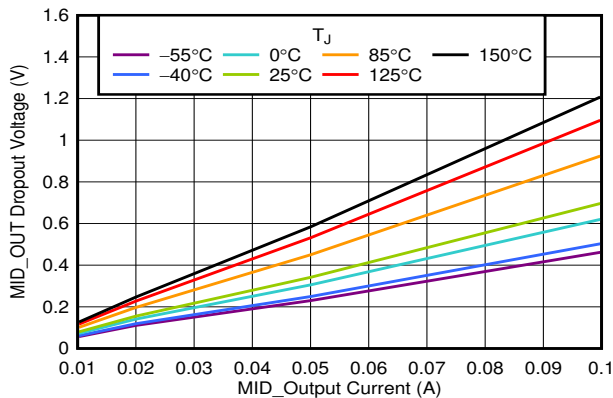

$V_{\text{MID_OUT}} = 15\text{ V}$, $V_{\text{MVSEL1}} = V_{\text{MVSEL2}} = 0\text{ V}$, $I_{\text{OUT}} = 0\text{ mA}$

6-11. $V_{\text{DO(MID_OUT)}}$ vs $I_{\text{MID_OUT}}$

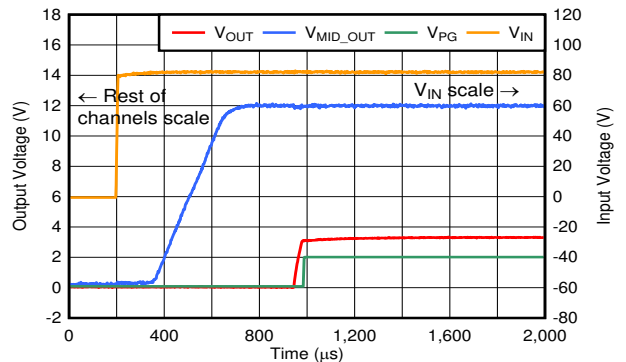

$C_{\text{IN}} = 0\text{ }\mu\text{F}$, V_{IN} ramp rate = $10\text{ V}/\mu\text{s}$, $V_{\text{OUT}} = 3.3\text{ V}$,
 $I_{\text{OUT}} = 10\text{ mA}$

6-12. Fast Start-Up

6.6 Typical Characteristics (continued)

at operating temperature $T_J = 25^\circ\text{C}$, $I_{OUT} = 1\text{ mA}$, $I_{MID_OUT} = 0\text{ mA}$, $V_{EN} = 2\text{ V}$, $V_{MVSEL1} = 0.9\text{ V}$, $V_{MVSEL2} = 0.9\text{ V}$, $C_{IN} = 1\text{ }\mu\text{F}$, $C_{MID_OUT} = 4.7\text{ }\mu\text{F}$, $C_{OUT} = 1\text{ }\mu\text{F}$, and $V_{IN} = V_{MID_OUT} + 1.5\text{ V}$ (unless otherwise noted); typical values are at $T_J = 25^\circ\text{C}$

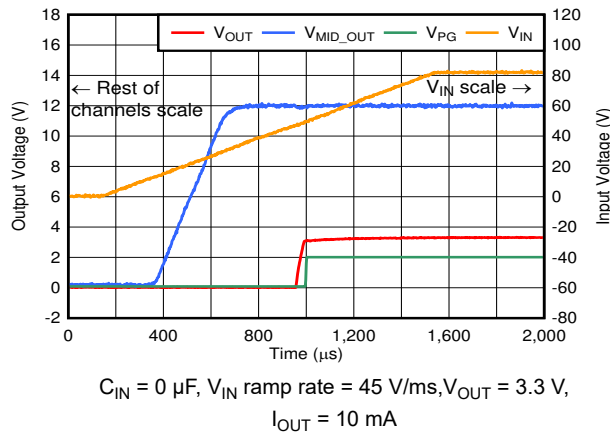

Figure 6-13. Slow Start-Up

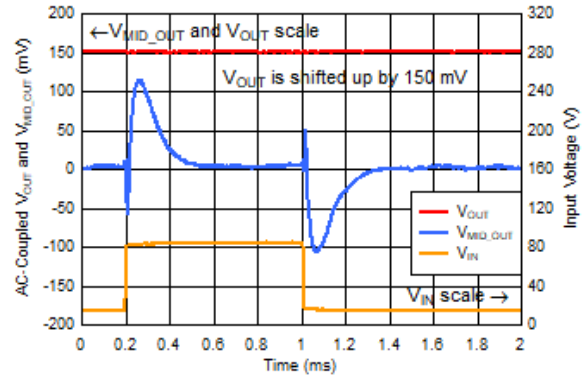

Figure 6-14. Line Transient

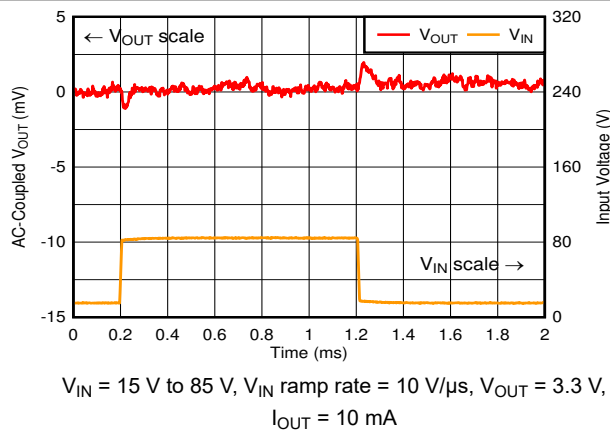

Figure 6-15. Line Transient

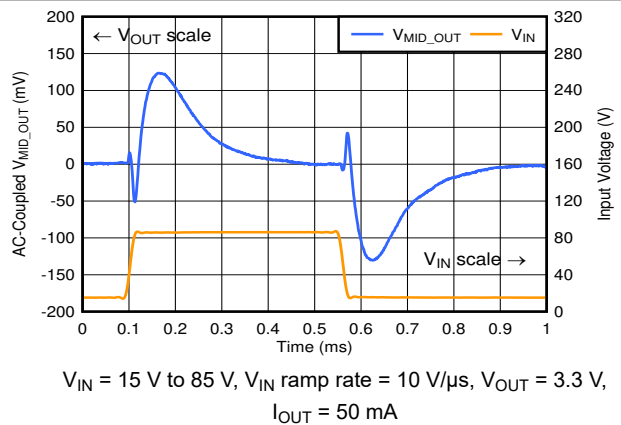

Figure 6-16. Line Transient

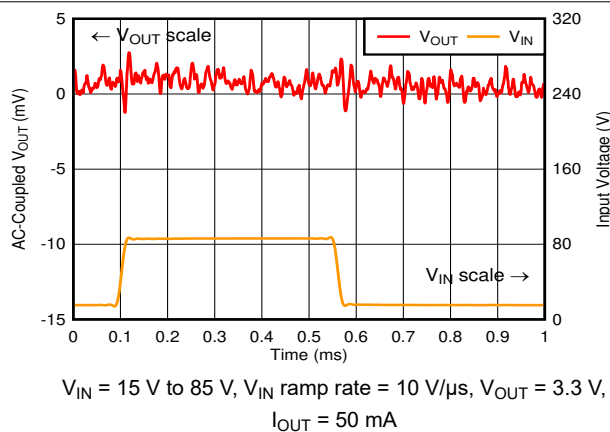

Figure 6-17. Line Transient

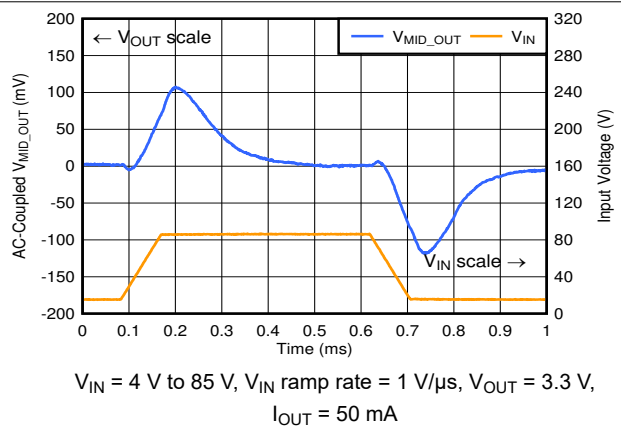
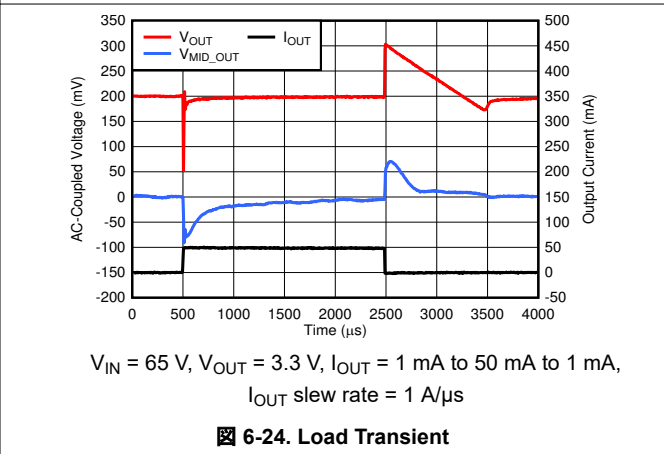
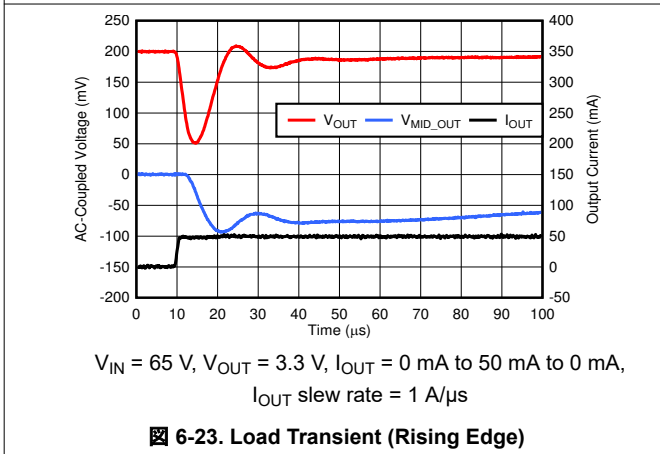
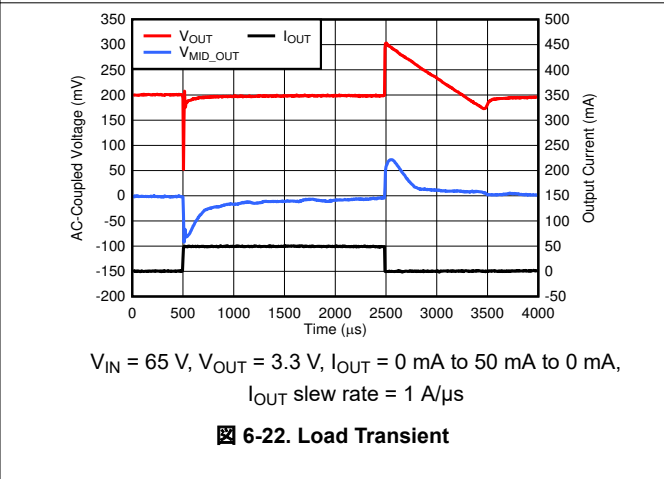
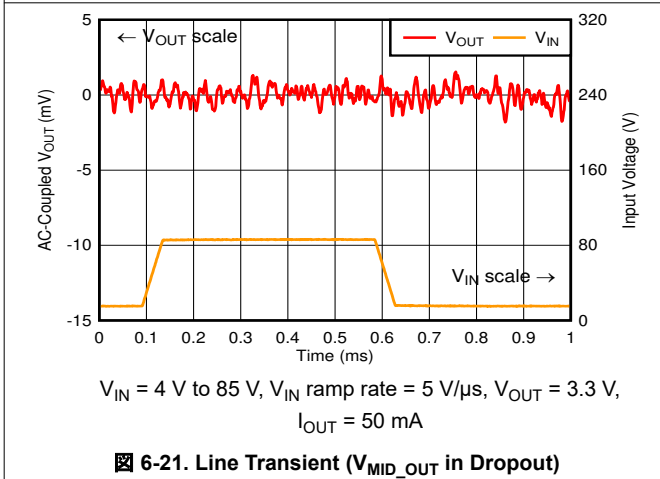
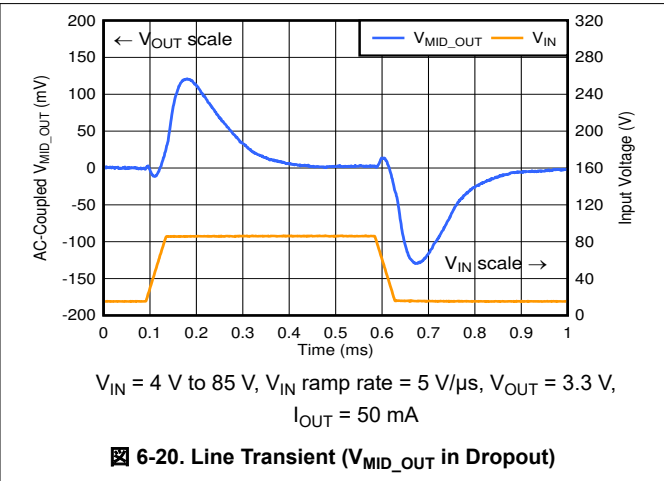
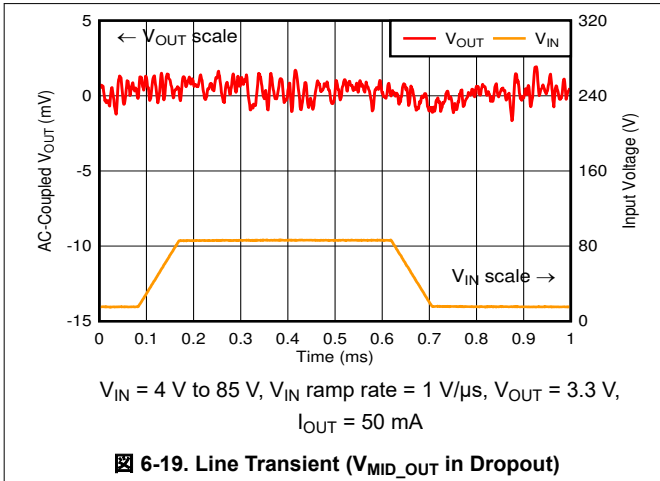

Figure 6-18. Line Transient (V_{MID_OUT} in Dropout)

6.6 Typical Characteristics (continued)

at operating temperature $T_J = 25^\circ\text{C}$, $I_{OUT} = 1\text{ mA}$, $I_{MID_OUT} = 0\text{ mA}$, $V_{EN} = 2\text{ V}$, $V_{MVSEL1} = 0.9\text{ V}$, $V_{MVSEL2} = 0.9\text{ V}$, $C_{IN} = 1\text{ }\mu\text{F}$, $C_{MID_OUT} = 4.7\text{ }\mu\text{F}$, $C_{OUT} = 1\text{ }\mu\text{F}$, and $V_{IN} = V_{MID_OUT} + 1.5\text{ V}$ (unless otherwise noted); typical values are at $T_J = 25^\circ\text{C}$



6.6 Typical Characteristics (continued)

at operating temperature $T_J = 25^\circ\text{C}$, $I_{OUT} = 1\text{ mA}$, $I_{MID_OUT} = 0\text{ mA}$, $V_{EN} = 2\text{ V}$, $V_{MVSEL1} = 0.9\text{ V}$, $V_{MVSEL2} = 0.9\text{ V}$, $C_{IN} = 1\text{ }\mu\text{F}$, $C_{MID_OUT} = 4.7\text{ }\mu\text{F}$, $C_{OUT} = 1\text{ }\mu\text{F}$, and $V_{IN} = V_{MID_OUT} + 1.5\text{ V}$ (unless otherwise noted); typical values are at $T_J = 25^\circ\text{C}$

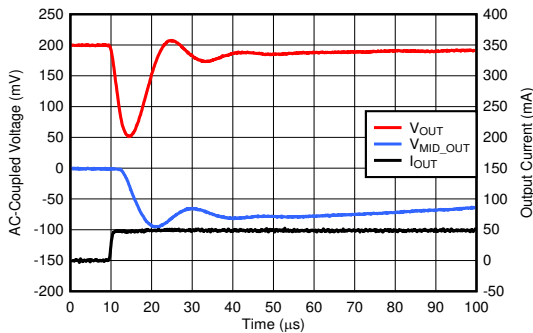

$V_{IN} = 65\text{ V}$, $V_{OUT} = 3.3\text{ V}$, $I_{OUT} = 1\text{ mA to } 50\text{ mA to } 1\text{ mA}$,
 I_{OUT} slew rate = $1\text{ A}/\mu\text{s}$

6-25. Load Transient (Rising Edge)

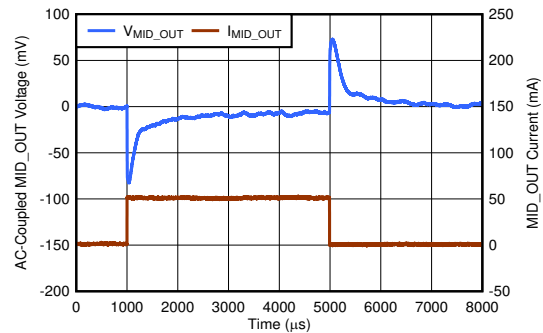

$V_{IN} = 65\text{ V}$, $V_{MID_OUT} = 12\text{ V}$, $I_{MID_OUT} = 0\text{ mA to } 50\text{ mA to } 0\text{ mA}$,
 I_{MID_OUT} slew rate = $1\text{ A}/\mu\text{s}$, $I_{OUT} = 0\text{ mA}$

6-26. Load Transient (MID_OUT)

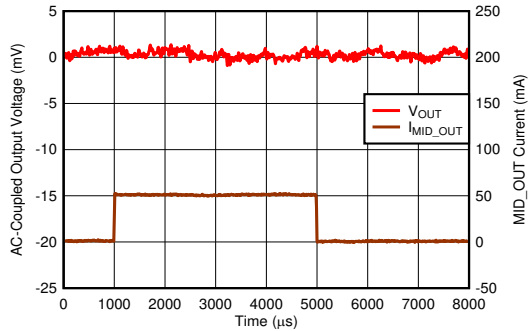

$V_{IN} = 65\text{ V}$, $V_{OUT} = 3.3\text{ V}$, $I_{MID_OUT} = 0\text{ mA to } 50\text{ mA to } 0\text{ mA}$,
 I_{MID_OUT} slew rate = $1\text{ A}/\mu\text{s}$, $I_{OUT} = 0\text{ mA}$

6-27. Load Transient (MID_OUT)

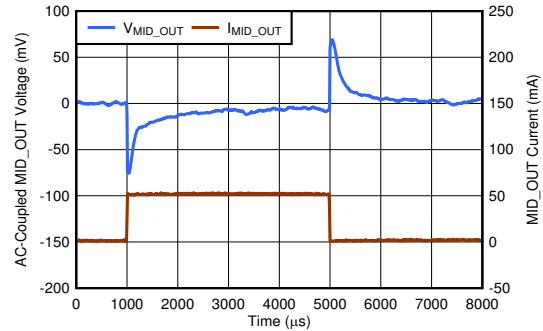

$V_{IN} = 65\text{ V}$, $V_{MID_OUT} = 12\text{ V}$, $I_{MID_OUT} = 1\text{ mA to } 50\text{ mA to } 1\text{ mA}$,
 I_{MID_OUT} slew rate = $1\text{ A}/\mu\text{s}$, $I_{OUT} = 0\text{ mA}$

6-28. Load Transient (MID_OUT)

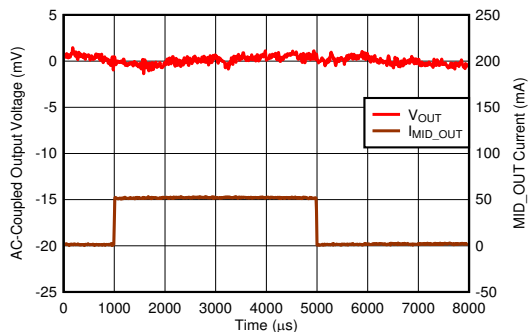

$V_{IN} = 65\text{ V}$, $V_{OUT} = 3.3\text{ V}$, $I_{MID_OUT} = 1\text{ mA to } 50\text{ mA to } 1\text{ mA}$,
 I_{MID_OUT} slew rate = $1\text{ A}/\mu\text{s}$, $I_{OUT} = 0\text{ mA}$

6-29. Load Transient (MID_OUT)

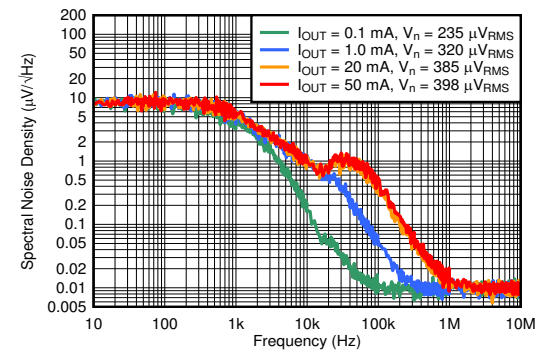

$V_{IN} = 13\text{ V}$, $V_{OUT} = 3.3\text{ V}$, V_{RMS} bandwidth = $10\text{ Hz to } 100\text{ kHz}$

6-30. Spectral Noise Density vs Frequency and I_{OUT}

6.6 Typical Characteristics (continued)

at operating temperature $T_J = 25^\circ\text{C}$, $I_{\text{OUT}} = 1\text{ mA}$, $I_{\text{MID_OUT}} = 0\text{ mA}$, $V_{\text{EN}} = 2\text{ V}$, $V_{\text{MVSEL1}} = 0.9\text{ V}$, $V_{\text{MVSEL2}} = 0.9\text{ V}$, $C_{\text{IN}} = 1\text{ }\mu\text{F}$, $C_{\text{MID_OUT}} = 4.7\text{ }\mu\text{F}$, $C_{\text{OUT}} = 1\text{ }\mu\text{F}$, and $V_{\text{IN}} = V_{\text{MID_OUT}} + 1.5\text{ V}$ (unless otherwise noted); typical values are at $T_J = 25^\circ\text{C}$

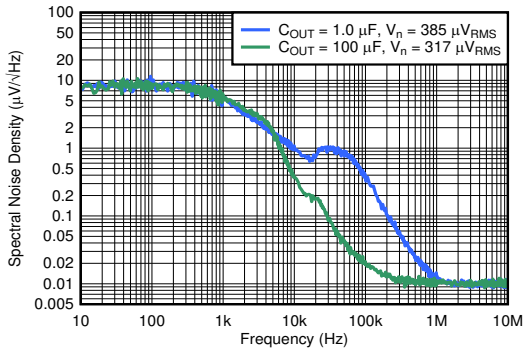

$V_{\text{IN}} = 13\text{ V}$, $V_{\text{OUT}} = 3.3\text{ V}$, $I_{\text{OUT}} = 20\text{ mA}$,
 V_{RMS} bandwidth = 10 Hz to 100 kHz

6-31. Spectral Noise Density vs Frequency and C_{OUT}

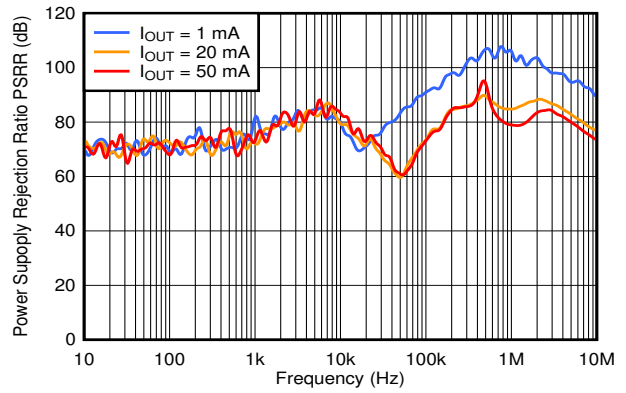

$V_{\text{IN}} = 13\text{ V}$, $C_{\text{IN}} = 0\text{ }\mu\text{F}$, $V_{\text{OUT}} = 3.3\text{ V}$

6-32. OUT PSRR vs Frequency and I_{OUT}

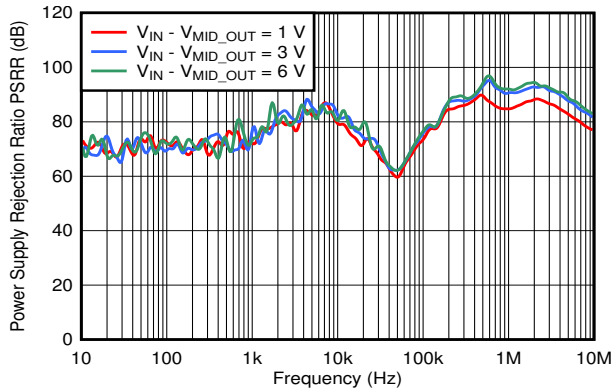

$C_{\text{IN}} = 0\text{ }\mu\text{F}$, $V_{\text{OUT}} = 3.3\text{ V}$, $I_{\text{OUT}} = 20\text{ mA}$

6-33. OUT PSRR vs Frequency and V_{IN}

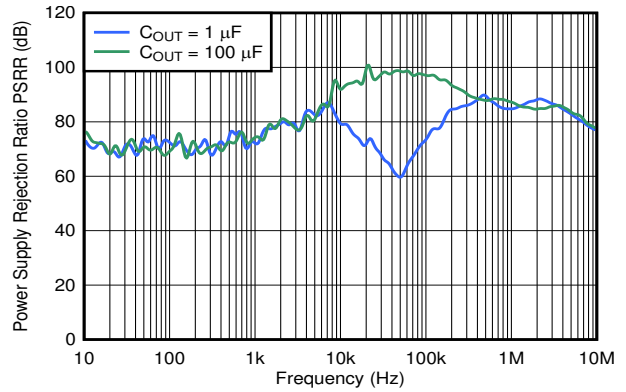

$V_{\text{IN}} = 13\text{ V}$, $C_{\text{IN}} = 0\text{ }\mu\text{F}$, $V_{\text{OUT}} = 3.3\text{ V}$, $I_{\text{OUT}} = 20\text{ mA}$

6-34. OUT PSRR vs Frequency and C_{OUT}

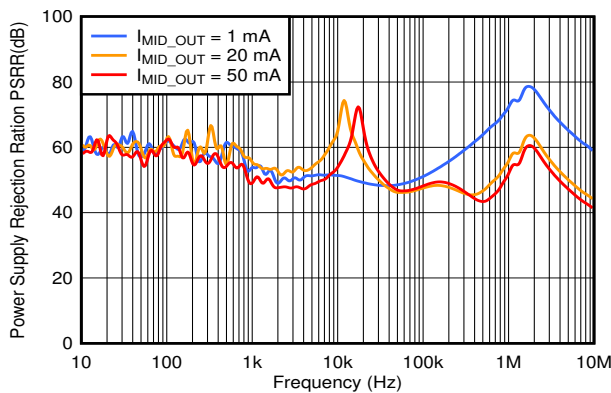

$V_{\text{IN}} = 13\text{ V}$, $C_{\text{IN}} = 0\text{ }\mu\text{F}$, $V_{\text{OUT}} = 3.3\text{ V}$, $I_{\text{OUT}} = 0\text{ mA}$

6-35. MID_OUT PSRR vs Frequency and $I_{\text{MID_OUT}}$

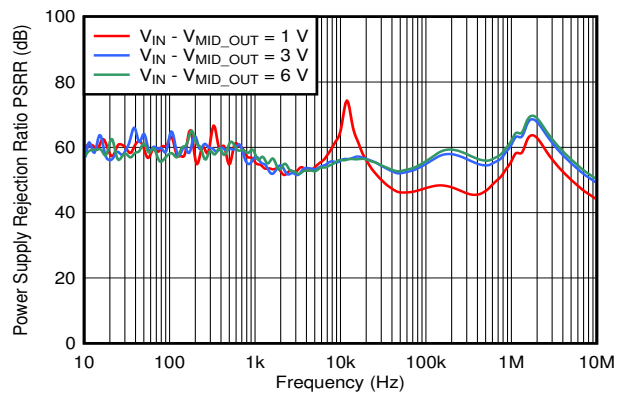

$C_{\text{IN}} = 0\text{ }\mu\text{F}$, $V_{\text{OUT}} = 3.3\text{ V}$, $I_{\text{MID_OUT}} = 20\text{ mA}$, $I_{\text{OUT}} = 0\text{ mA}$

6-36. MID_OUT PSRR vs Frequency and V_{IN}

6.6 Typical Characteristics (continued)

at operating temperature $T_J = 25^\circ\text{C}$, $I_{OUT} = 1\text{ mA}$, $I_{MID_OUT} = 0\text{ mA}$, $V_{EN} = 2\text{ V}$, $V_{MVSEL1} = 0.9\text{ V}$, $V_{MVSEL2} = 0.9\text{ V}$, $C_{IN} = 1\text{ }\mu\text{F}$, $C_{MID_OUT} = 4.7\text{ }\mu\text{F}$, $C_{OUT} = 1\text{ }\mu\text{F}$, and $V_{IN} = V_{MID_OUT} + 1.5\text{ V}$ (unless otherwise noted); typical values are at $T_J = 25^\circ\text{C}$

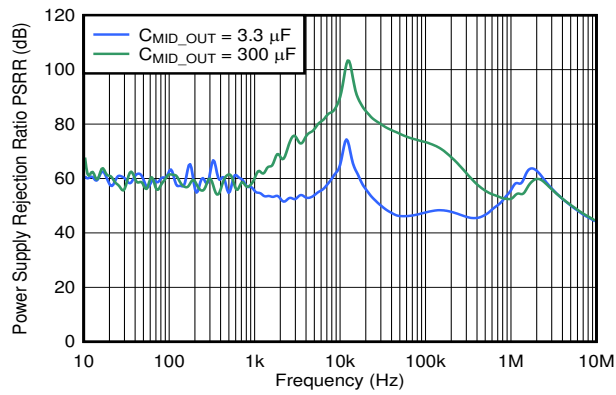

$V_{IN} = 13\text{ V}$, $C_{IN} = 0\text{ }\mu\text{F}$, $V_{OUT} = 3.3\text{ V}$, $I_{MID_OUT} = 20\text{ mA}$,
 $I_{OUT} = 0\text{ mA}$

6-37. MID_OUT PSRR vs Frequency and C_{MID_OUT}

7 Detailed Description

7.1 Overview

The TPS7A43 is an 85-V, low quiescent current, low-dropout (LDO) linear regulator. The very low I_Q performance makes the device an excellent choice for battery-powered or line-power applications that are expected to meet increasingly stringent standby-power standards.

The high accuracy over temperature and power-good indication make this device designed for meeting a broad range of microcontroller power requirements. The device features a selectable MID_OUT voltage pin to provide a secondary voltage to serve as a bias rail for gate drivers.

For increased robustness, the TPS7A43 also incorporates precision enable, output current limit, active discharge, and thermal shutdown protection. The operating junction temperature for this device is from -40°C to $+125^{\circ}\text{C}$.

7.2 Functional Block Diagrams

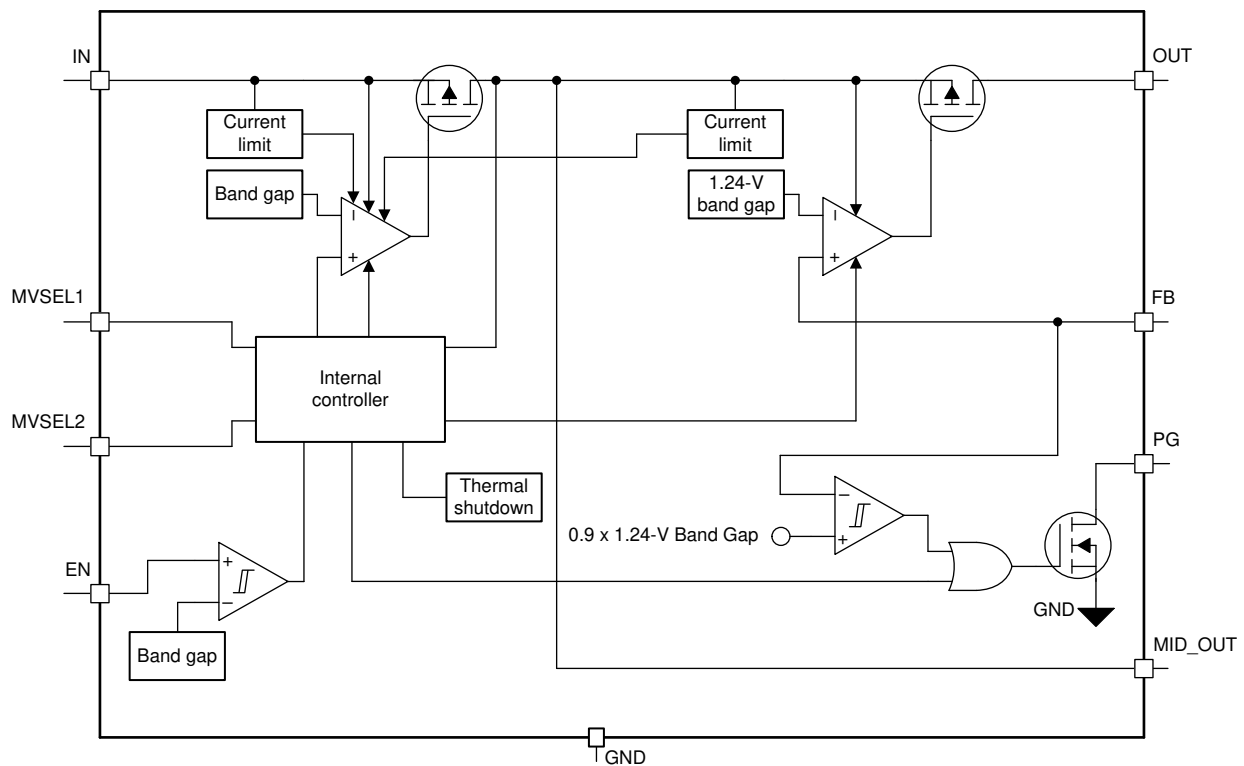

7-1. Adjustable Version

As shown in [Figure 7-3](#), an external resistor divider circuit can be used to enable the device using the input voltage.

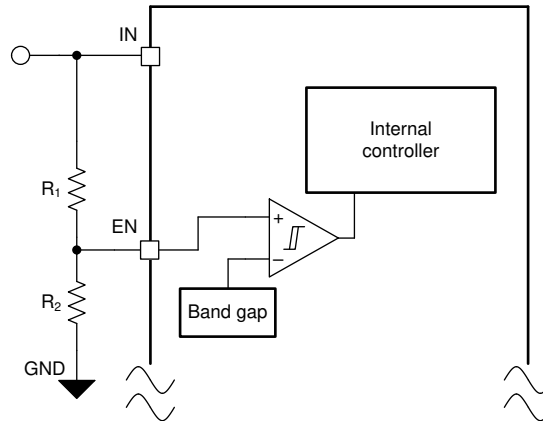

Figure 7-3. Enable the Device Using the Input Voltage

The $V_{EN(HI)}$ (maximum) and $V_{EN(LOW)}$ (minimum) thresholds along with the application input voltage can be used to set the R_1 to R_2 resistor divider ratio. The values of the R_2 and R_1 resistors can also be optimized to minimize the leakage current through the divider.

7.3.3 Dropout Voltage

Dropout voltage (V_{DO}) is defined as the input voltage minus the output voltage ($V_{IN} - V_{OUT}$) at the rated output current (I_{RATED}), where the pass transistor is fully on. I_{RATED} is the maximum I_{OUT} listed in the [Recommended Operating Conditions](#) table. The pass transistor is in the ohmic or triode region of operation, and acts as a switch. The dropout voltage indirectly specifies a minimum input voltage greater than the nominal programmed output voltage at which the output voltage is expected to stay in regulation. If the input voltage falls to less than the nominal output regulation, then the output voltage falls as well.

For a CMOS regulator, the dropout voltage is determined by the drain-source on-state resistance ($R_{DS(ON)}$) of the pass transistor. Therefore, if the linear regulator operates at less than the rated current, the dropout voltage for that current scales accordingly. The following equation calculates the $R_{DS(ON)}$ of the device.

$$R_{DS(ON)} = \frac{V_{DO}}{I_{RATED}} \quad (1)$$

7.3.4 Current Limit

The device has internal current limit circuits for both MID_OUT and OUT rails. These circuits protect the regulator during high-current load transient faults or shorting events on either rails. Both current limit circuits are brick-wall schemes with $I_{CL(MID_OUT)}$ being higher than $I_{CL(OUT)}$. In a high-current load transient fault, the brick-wall scheme limits the output current to the respective current limit ($I_{CL(MID_OUT)}$ or $I_{CL(OUT)}$), both of which are listed in the [Electrical Characteristics](#) table.

When the device is in either current limit, the output voltages are not regulated. When a current limit event occurs, the device begins to heat up because of the increase in power dissipation. When the device is in either current limit, the corresponding pass transistor dissipates power. For instance, when the OUT rail is in current limit, the power dissipation can be calculated as $[(V_{IN} - V_{OUT}) \times I_{CL(OUT)}]$. If thermal shutdown is triggered, the device turns off. After the device cools down, the internal thermal shutdown circuit turns the device back on. If the faulty output current condition continues, the device cycles between current limit and thermal shutdown with approximately a 5-ms time constant. For more information on current limits, see the [Know Your Limits application note](#).

☒ 7-4 shows a diagram of the current limit.

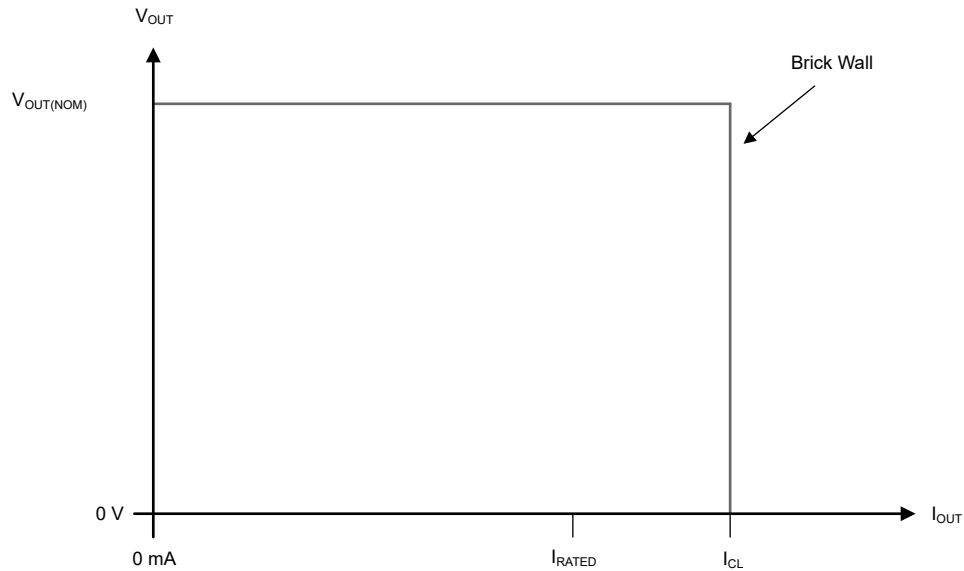

☒ 7-4. Current Limit: Brick-Wall Scheme

7.3.5 Thermal Shutdown

The device contains a thermal shutdown protection circuit to disable the device when the junction temperature (T_J) of the pass transistor rises to $T_{SD(\text{shutdown})}$ (typical). Thermal shutdown hysteresis assures that the device resets (turns on) when the temperature falls to $T_{SD(\text{reset})}$ (typical).

The thermal time-constant of the semiconductor die is fairly short, thus the device can cycle on and off when thermal shutdown is reached until power dissipation is reduced. Power dissipation during start up can be high from large $V_{IN} - V_{OUT}$ voltage drops across the device or from high inrush currents charging large output capacitors. Under some conditions, the thermal shutdown protection disables the device before start up completes.

When the thermal limit is triggered with the load current near the value of the current limit, the output can oscillate prior to the output switching off.

For reliable operation, limit the junction temperature to the maximum listed in the [Recommended Operating Conditions](#) table. Operation above this maximum temperature causes the device to exceed operational specifications. Although the internal protection circuitry of the device is designed to protect against thermal overload conditions, this circuitry is not intended to replace proper heat sinking. Continuously running the device into thermal shutdown or above the maximum recommended junction temperature reduces long-term reliability.

7.3.6 Power Good

The power-good (PG) pin is an open-drain output and can be connected to a regulated supply through an external pullup resistor. The maximum pullup voltage is listed as V_{PG} in the [Recommended Operating Conditions](#) table. For the PG pin to have a valid output, the voltage on the IN pin must be greater than 4 V. When V_{OUT} exceeds $V_{IT(PG,RISING)}$, the PG output is high impedance and the PG pin voltage pulls up to the connected regulated supply. When the regulated output falls below $V_{IT(PG,FALLING)}$, the open-drain output turns on and pulls the PG output low after a short deglitch time. If output voltage monitoring is not needed, the PG pin can be left floating or connected to ground.

The recommended maximum PG pin sink current ($I_{PG-SINK}$) and the leakage current into the PG pin ($I_{LKG(PG)}$) are listed in the [Electrical Characteristics](#) table.

The PG pullup voltage (V_{PG_PULLUP}), the desired minimum power-good output voltage ($V_{PG(MIN)}$), and $I_{LKG(PG)}$ limit the maximum PG pin pullup resistor value (R_{PG_PULLUP}). V_{PG_PULLUP} , the PG pin low-level output voltage ($V_{OL(PG)}$), and $I_{PG-SINK}$ limit the minimum R_{PG_PULLUP} . Maximum and minimum values for R_{PG_PULLUP} can be calculated from the following equations:

$$R_{PG_PULLUP(MAX)} = (V_{PG_PULLUP} - V_{PG(MIN)}) / I_{LKG(PG)_MAX} \quad (2)$$

$$R_{PG_PULLUP(MIN)} = (V_{PG_PULLUP} - V_{OL(PG)}) / I_{PG-SINK} \quad (3)$$

For example, if the PG pin is connected to a pullup resistor with a 3.3-V external supply, from the [Electrical Characteristics](#) table, $R_{PG_PULLUP(MAX)}$ is 25 M Ω . From the [Electrical Characteristics](#) table, $R_{PG_PULLUP(MIN)}$ is 6.6 k Ω .

7.4 Device Functional Modes

7.4.1 Device Functional Mode Comparison

表 7-1 shows the conditions that lead to the different modes of operation. See the [Electrical Characteristics](#) table for parameter values.

表 7-1. Device Functional Mode Comparison

OPERATING MODE	PARAMETER				
	V_{IN}	V_{EN}	I_{MID_OUT}	I_{OUT}	T_J
Normal operation	$V_{IN} > V_{OUT(nom)} + V_{DO}$ and $V_{IN} > V_{IN(min)}$	$V_{EN} > V_{EN(HI)}$	$I_{MID_OUT} < I_{MID_OUT(max)}$	$I_{OUT} < I_{OUT(max)}$	$T_J < T_{SD(shutdown)}$
Dropout operation on MID_OUT	$V_{IN(min)} < V_{IN} < V_{MID_OUT(nom)} + V_{DO(MID_OUT)}$	$V_{EN} > V_{EN(HI)}$	$I_{MID_OUT} < I_{MID_OUT(max)}$	$I_{OUT} < I_{OUT(max)}$	$T_J < T_{SD(shutdown)}$
Dropout operation on OUT	$V_{IN(min)} < V_{IN} < V_{OUT(nom)} + V_{DO(OUT)}$	$V_{EN} > V_{EN(HI)}$	$I_{MID_OUT} < I_{MID_OUT(max)}$	$I_{OUT} < I_{OUT(max)}$	$T_J < T_{SD(shutdown)}$
Disabled (any true condition disables the device)	$V_{IN} < 4\text{ V}$	$V_{EN} < V_{EN(LOW)}$	Not applicable	Not applicable	$T_J > T_{SD(reset)}$

7.4.2 Normal Operation

The device regulates to the nominal output voltages when the following conditions are met:

- The input voltage is greater than the nominal output voltage plus the dropout voltage on either rails ($V_{MID_OUT(nom)} + V_{DO(MID_OUT)}$ and $V_{OUT(nom)} + V_{DO(OUT)}$)
- The current sourced from either MID_OUT and OUT is less than the respective current limit specified in the [Electrical Characteristics](#) table for each rail
- The device junction temperature is less than the thermal shutdown temperature ($T_J < T_{SD(shutdown)}$)
- The enable voltage has previously exceeded the $V_{EN(HI)}$ (maximum) threshold and has not yet decreased to less than the $V_{EN(LOW)}$ minimum threshold
- V_{IN} has exceeded 4 V if the EN pin is left floating

7.4.3 Dropout Operation

Because the TPS7A43 has two output rails (MID_OUT and OUT), the device can be in either $V_{DO(MID_OUT)}$ or $V_{DO(OUT)}$, or in both depending on the input voltage level while all other conditions are met for normal operation. When the input voltage drops to lower than $V_{MID_OUT(nom)} + V_{DO(MID_OUT)}$, the device is in $V_{DO(MID_OUT)}$ dropout. During this rail dropout, V_{MID_OUT} tracks V_{IN} and the transient performance of V_{MID_OUT} becomes significantly degraded because the pass transistor is in the ohmic or triode region, and acts as a switch. The MID_OUT rail line or load transients in the $V_{DO(MID_OUT)}$ dropout can result in large V_{MID_OUT} deviations. When the device is still in $V_{DO(MID_OUT)}$ and when V_{IN} is higher than $V_{OUT(nom)} + V_{DO(OUT)}$, V_{OUT} is in regulation and is not in $V_{DO(OUT)}$ dropout. When V_{IN} drops below $V_{OUT(nom)} + V_{DO(OUT)}$, V_{OUT} is no longer in regulation and transient performance becomes significantly degraded.

When the device is in a steady dropout state (when the device is in both $V_{DO(MID_OUT)}$ and $V_{DO(OUT)}$ dropout, directly after being in a normal regulation state, but *not* during start up), the pass transistor is driven into the ohmic or triode region. When the input voltage returns to a value greater than or equal to $V_{MID_OUT(nom)} + V_{DO(MID_OUT)}$ and greater than $V_{OUT(NOM)} + V_{DO}$, the output voltage (OUT) can overshoot for a short period of time while the device pulls the pass transistor back into the linear region.

7.4.4 Disabled

The outputs of the device can be shutdown by forcing the voltage of the enable pin to less than $V_{EN(LOW)}$ (minimum); see the [Electrical Characteristics](#) table. When disabled, the pass transistor is turned off and internal circuits are shutdown.

8 Application and Implementation

注

以下のアプリケーション情報は、TI の製品仕様に含まれるものではなく、TI ではその正確性または完全性を保証いたしません。個々の目的に対する製品の適合性については、お客様の責任で判断していただくこととなります。お客様は自身の設計実装を検証しテストすることで、システムの機能を確認する必要があります。

8.1 Application Information

8.1.1 MID_OUT Voltage Setting

The MID_OUT voltage has three different output voltage levels (10 V, 12 V, and 15 V), as listed in [表 8-1](#), depending on the MVSEL1 and MVSEL2 pin voltage settings.

表 8-1. MID_OUT Voltage Setting

SET V_{MVSEL1}	SET V_{MVSEL2}	MID_OUT
$V_{MVSEL1} \leq V_{MVSEL1(Low)}$	$V_{MVSEL2} \leq V_{MVSEL2(Low)}$	15 V
$V_{MVSEL1} \leq V_{MVSEL1(Low)}$	$V_{MVSEL2} \geq V_{MVSEL2(High)}$	12 V
$V_{MVSEL1} \geq V_{MVSEL1(High)}$	$V_{MVSEL2} \leq V_{MVSEL2(Low)}$	10 V
$V_{MVSEL1} \geq V_{MVSEL1(High)}$	$V_{MVSEL2} \geq V_{MVSEL2(High)}$	12 V

For adjustable voltage options of the TPS7A43, and to maintain voltage regulation on the MID_OUT and OUT pins, the input voltage must be kept $\geq MID_OUT + V_{DO(MID_OUT)}$. Additionally, to maintain regulation on the OUT pin, the MID_OUT voltage must be set $\geq V_{OUT(nom)} + V_{DO(OUT)}$.

Set the MVSEL1 and MVSEL2 voltages before enabling the device to set the MID_OUT voltage level; however, the MID_OUT voltage setting can be changed to a different level after the device had powered up. Do not allow these pins to float, instead tie them both to GND if not used to set V_{MID_OUT} . When the device is powered while either of these pins are floating, the MID_OUT voltage is not set properly and might switch levels and cause damage to the device.

8.1.2 Adjustable Device Feedback Resistors

The adjustable-version device requires external feedback divider resistors to set the output voltage. V_{OUT} is set using the feedback divider resistors, R_1 and R_2 , according to the following equation:

$$V_{OUT} = V_{FB} \times (1 + R_1 / R_2) \quad (4)$$

To ignore the FB pin current error term in the V_{OUT} equation, set the feedback divider current to 100 times the FB pin current listed in the [Electrical Characteristics](#) table. This setting provides the maximum feedback divider series resistance, as shown in the following equation:

$$R_1 + R_2 \leq V_{OUT} / (I_{FB} \times 100) \quad (5)$$

8.1.3 Recommended Capacitor Types

The device is designed to be stable using low equivalent series resistance (ESR) capacitors at the input and output. Multilayer ceramic capacitors have become the industry standard for these types of applications and are recommended, but must be used with good judgment. Ceramic capacitors that employ X7R-, X5R-, and C0G-rated dielectric materials provide relatively good capacitive stability across temperature, whereas the use of Y5V-rated capacitors is discouraged because of large variations in capacitance.

Regardless of the ceramic capacitor type selected, the effective capacitance varies with operating voltage and temperature. As a rule of thumb, expect the effective capacitance to decrease by as much as 50%. The input and output capacitors recommended in the [Recommended Operating Conditions](#) table account for an effective capacitance of approximately 50% of the nominal value.

8.1.4 Input and Output Capacitor Requirements

An input capacitor is not required for stability except when the device maximum current is sourced from the MID_OUT pin. However, adding an input capacitor is always good analog design practice to counteract reactive input sources and improve transient response, input ripple, and PSRR. Starting with the nominal input capacitor value is required if large, fast transient load or line transients are anticipated on the MID_OUT pin or if the device is located several inches from the input power source.

A minimum of a 3:1 capacitor ratio between C_{MID_OUT} and C_{OUT} is required for proper operation of the TPS7A43 LDO and a 4.7- μ F capacitor can be connected from the MID_OUT pin to GND.

A minimum 1- μ F output capacitor is required for V_{OUT} stability. A maximum 100- μ F output capacitor can be used as long as the 3:1 ratio between C_{MID_OUT} and C_{OUT} is maintained.

8.1.5 Power Dissipation (P_D)

Circuit reliability requires consideration of the device power dissipation, location of the circuit on the printed circuit board (PCB), and correct sizing of the thermal plane. The PCB area around the regulator must have few or no other heat-generating devices that cause added thermal stress.

To first-order approximation, power dissipation in the regulator depends on the input-to-output voltage difference and load conditions. The following equation calculates power dissipation (P_D).

$$P_D = (V_{IN} - V_{OUT}) \times I_{OUT} \quad (6)$$

注

Power dissipation can be minimized, and therefore greater efficiency can be achieved, by correct selection of the system voltage rails. For the lowest power dissipation use the minimum input voltage required for correct output regulation.

For devices with a thermal pad, the primary heat conduction path for the device package is through the thermal pad to the PCB. Solder the thermal pad to a copper pad area under the device. This pad area must contain an array of plated vias that conduct heat to additional copper planes for increased heat dissipation.

The maximum power dissipation determines the maximum allowable ambient temperature (T_A) for the device. According to the following equation, power dissipation and junction temperature are most often related by the junction-to-ambient thermal resistance ($R_{\theta JA}$) of the combined PCB and device package and the temperature of the ambient air (T_A).

$$T_J = T_A + (R_{\theta JA} \times P_D) \quad (7)$$

Thermal resistance ($R_{\theta JA}$) is highly dependent on the heat-spreading capability built into the particular PCB design, and therefore varies according to the total copper area, copper weight, and location of the planes. The junction-to-ambient thermal resistance listed in the [Thermal Information](#) table is determined by the JEDEC standard PCB and copper-spreading area, and is used as a relative measure of package thermal performance.

8.1.6 Estimating Junction Temperature

The JEDEC standard now recommends the use of psi (Ψ) thermal metrics to estimate the junction temperatures of the linear regulator when in-circuit on a typical PCB board application. These metrics are not thermal resistance parameters and instead offer a practical and relative way to estimate junction temperature. These psi metrics are determined to be significantly independent of the copper area available for heat-spreading. The [Thermal Information](#) table lists the primary thermal metrics, which are the junction-to-top characterization parameter (ψ_{JT}) and junction-to-board characterization parameter (ψ_{JB}). As described in [式 8](#) and [式 9](#), these parameters provide two methods for calculating the junction temperature (T_J). Use the junction-to-top characterization parameter (ψ_{JT}) with the temperature at the center-top of device package (T_T) to calculate the junction temperature. Use the junction-to-board characterization parameter (ψ_{JB}) with the PCB surface temperature 1 mm from the device package (T_B) to calculate the junction temperature.

$$T_J = T_T + \psi_{JT} \times P_D \quad (8)$$

where:

- P_D is the dissipated power
- T_T is the temperature at the center-top of the device package

$$T_J = T_B + \psi_{JB} \times P_D \quad (9)$$

where:

- T_B is the PCB surface temperature measured 1 mm from the device package and centered on the package edge

For detailed information on the thermal metrics and how to use them, see the [Semiconductor and IC Package Thermal Metrics application note](#).

8.2 Typical Application

This section discusses the implementation of the TPS7A43 in a cordless power tools application. [Figure 8-1](#) shows a typical circuit diagram for this application.

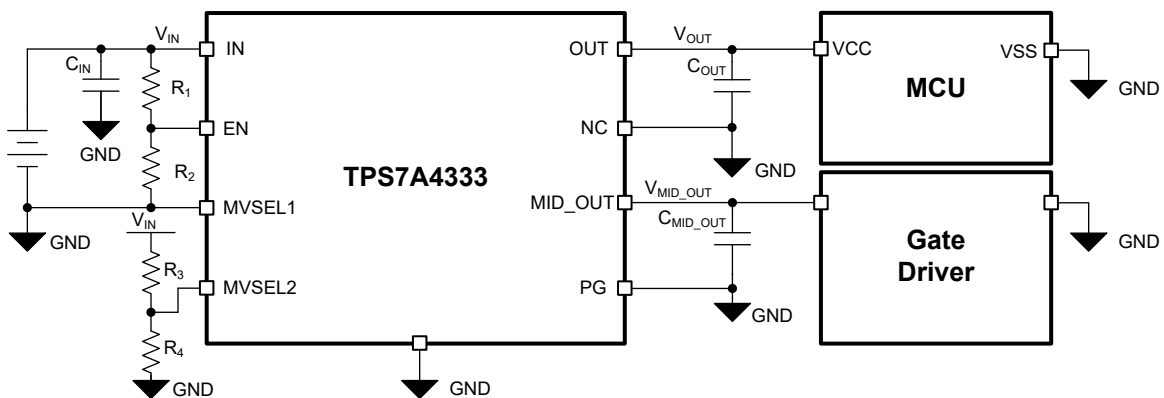

Figure 8-1. Powering Cordless Power Tools

8.2.1 Design Requirements

[Table 8-2](#) summarizes the design requirements for [Figure 8-1](#).

Table 8-2. Design Parameters

PARAMETER	DESIGN VALUES
V_{IN}	15 V (min), 85 V (transient max)
V_{OUT}	3.3 V \pm 2%
V_{MVSEL1}	0 V
V_{MVSEL2}	\geq 0.9 V
V_{MID_OUT}	12 V \pm 5%
$I_{(IN)}$ (no load)	< 9 μ A
I_{OUT} (typical), (max)	20 mA, 50 mA
I_{MID_OUT} (typical), (max)	0 mA, 1 mA
T_A	60°C (max)

8.2.2 Detailed Design Procedure

A fixed 3.3-V output voltage device is used for this application. The MID_OUT voltage is set to 12 V by tying the V_{MVSEL1} pin to GND and setting V_{MVSEL2} to ≥ 0.9 V using the R3 and R4 resistor divider. The value of the R3 and R4 divider ratio must ensure that V_{MVSEL2} is set to ≥ 0.9 V when $V_{IN} \geq 15$ V. To limit the current burned through this divider to 5 μ A, R3 can be calculated using 式 10, and the calculated value then can be rounded to the nearest standard value. When V_{IN} goes all the way up to 85 V during a transient, the V_{MVSEL2} voltage goes up to 3.9 V (which is still lower than the maximum recommended value for this pin, as specified in the [Recommended Operating Conditions](#) table).

$$R3 = (15 \text{ V} - 0.9 \text{ V}) / 5 \mu\text{A} = 2.82 \text{ M}\Omega \quad (10)$$

R4 then can be calculated with 式 11 by using the V_{MVSEL2} value of the same current value.

$$R3 = 0.9 \text{ V} / 5 \mu\text{A} = 180 \text{ k}\Omega \quad (11)$$

The enable precision circuit is also used to turn off the device when V_{IN} drops below 15 V. The R1 and R2 resistor divider is used to set V_{EN} to lower than $V_{EN(Low)}$ of 1.15 V when V_{IN} drops below 15 V. R1 can be calculated using 式 12 to limit the burned current through this divider to 5 μ A, similar to the above divider.

$$R1 = (15 \text{ V} - 1.15 \text{ V}) / 5 \mu\text{A} = 2.77 \text{ M}\Omega \quad (12)$$

式 13 can then be used to calculate R2. The calculated R1 and R2 values can then rounded to the nearest standard values.

$$R2 = 1.15 \text{ V} / 5 \mu\text{A} = 230 \text{ k}\Omega \quad (13)$$

8.2.3 Application Curves

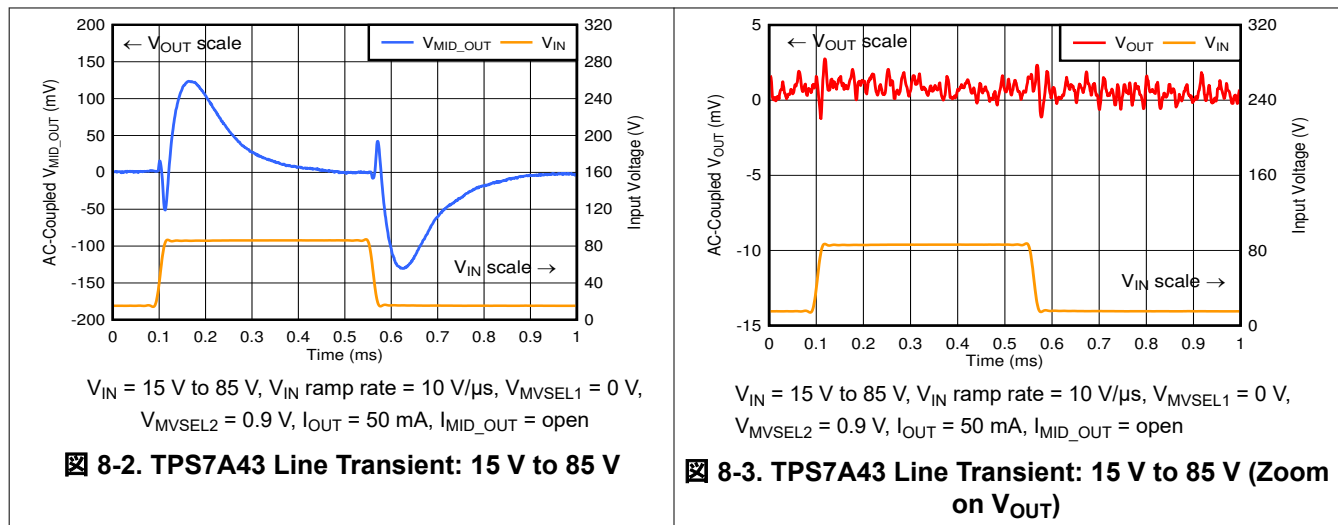

8.3 Power Supply Recommendations

The device is designed to operate from an input supply voltage range of 4 V to 85 V. To ensure that the output voltages are well regulated and dynamic performance is optimum, the input supply must be at least $V_{MID_OUT(nom)} + 1.5$ V. Connect a low output impedance power supply directly to the input pin of the TPS7A43.

8.4 Layout

8.4.1 Layout Guidelines

- Place input and output capacitors as close to the device pins as possible.
- Use copper planes for device connections to optimize thermal performance.
- Place thermal vias around the device and under the thermal pad to distribute heat.
- Only place tented thermal vias directly beneath the thermal pad of the DGQ package. An untented via can wick solder or solder paste away from the thermal pad joint during the soldering process, leading to a compromised solder joint on the thermal pad.

8.4.2 Layout Examples

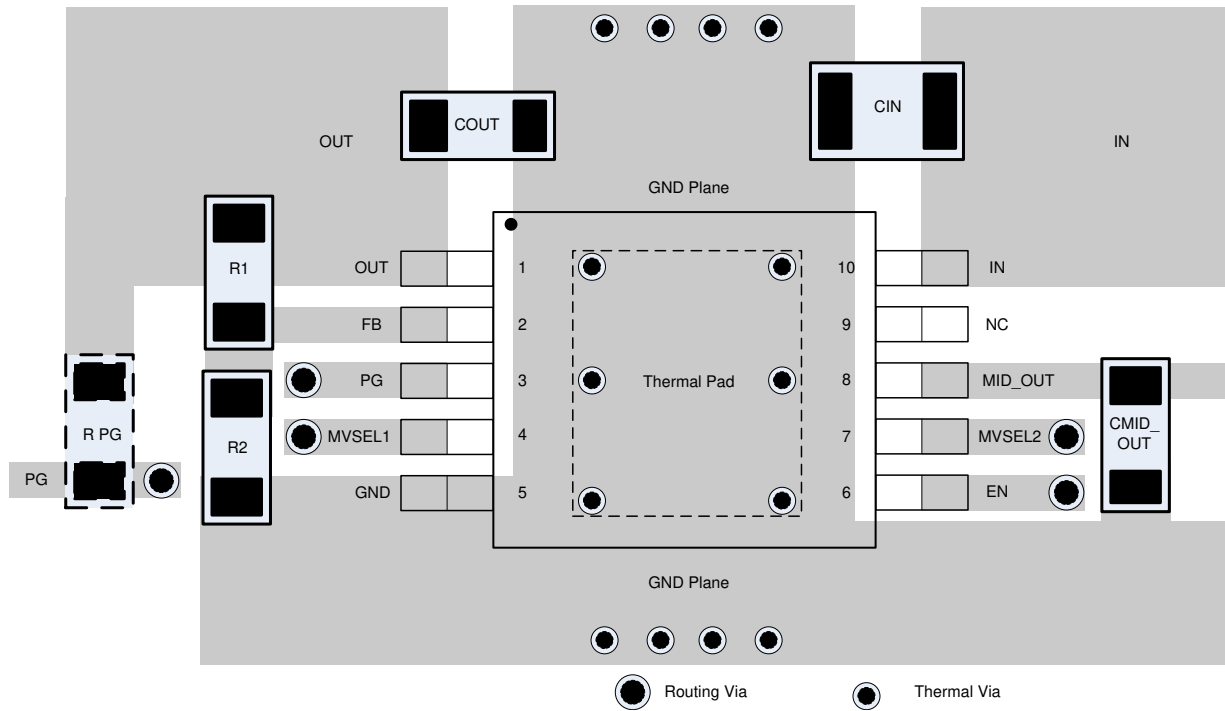

8-4. Adjustable Version Layout Example

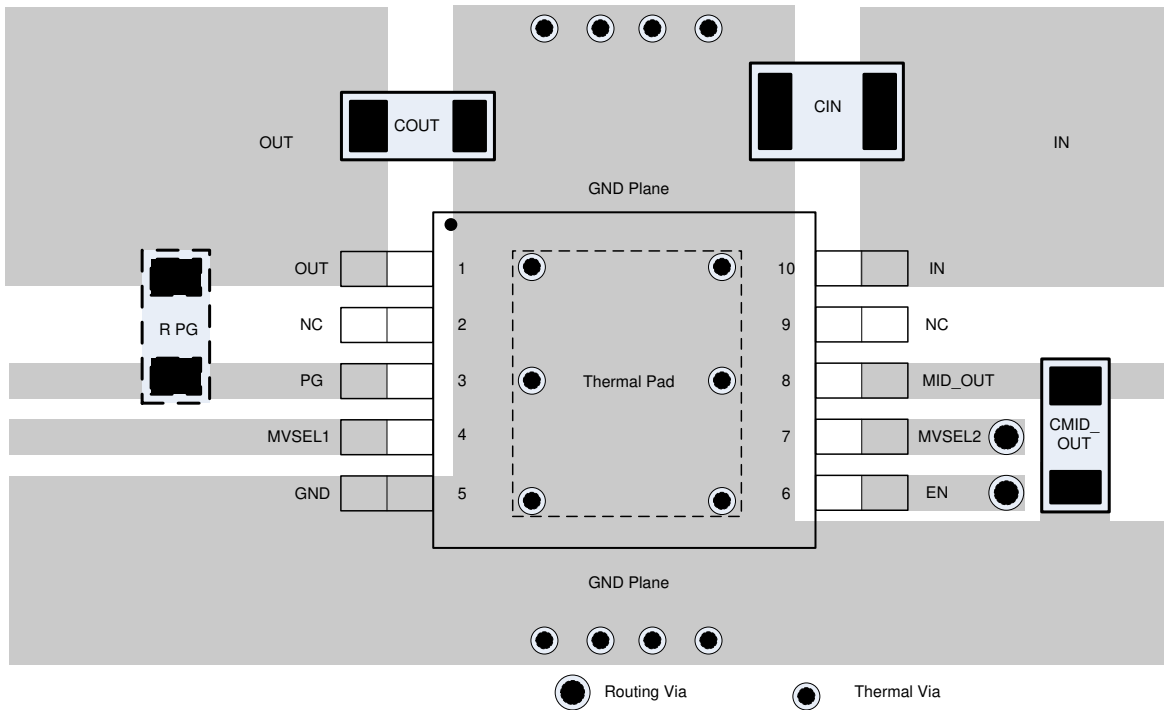

8-5. Fixed Version Layout Example

9 Device and Documentation Support

9.1 Device Support

9.1.1 Development Support

9.1.1.1 Evaluation Modules

An evaluation module (EVM) for a similar P2P device, the TPS7A43, is available to assist in the initial circuit performance evaluation for the TPS7A43. The [TPS7A43EVM-047 Evaluation Module user guide](#) can be requested at the Texas Instruments website through the product folders or purchased directly from the [TI Store](#).

9.1.1.2 Spice Models

SPICE models for the TPS7A43 are available through the [product folder](#) under *Tools & software*.

9.1.2 Device Nomenclature

表 9-1. Device Nomenclature⁽¹⁾

PRODUCT	V _{OUT}
TPS7A43 xx(x)yyyz	<p>xx(x) is the nominal output voltage. For output voltages with a resolution of 100 mV, two digits are used in the ordering number; for output voltages with a resolution of 50 mV, three digits are used (for example, 28 = 2.8 V; 125 = 1.25 V). 01 indicates adjustable output version.</p> <p>yyy is the package designator.</p> <p>z is the package quantity. R is for large quantity reel, T is for small quantity reel.</p>

(1) For the most current package and ordering information see the Package Option Addendum at the end of this document, or visit the device product folder at www.ti.com.

9.2 Documentation Support

9.2.1 Related Documentation

For related documentation see the following:

- Texas Instruments, [TPS7A43EVM-047 Evaluation Module user guide](#)
- Texas Instruments, [LDO Basics: Preventing reverse current blog](#)
- Texas Instruments, [LDO basics: capacitor vs. capacitance blog](#)

9.3 Receiving Notification of Documentation Updates

To receive notification of documentation updates, navigate to the device product folder on ti.com. Click on *Subscribe to updates* to register and receive a weekly digest of any product information that has changed. For change details, review the revision history included in any revised document.

9.4 サポート・リソース

[TI E2E™ サポート・フォーラム](#)は、エンジニアが検証済みの回答と設計に関するヒントをエキスパートから迅速かつ直接得ることができる場所です。既存の回答を検索したり、独自の質問をしたりすることで、設計に必要な支援を迅速に得ることができます。

リンクされているコンテンツは、該当する貢献者により、現状のまま提供されるものです。これらは TI の仕様を構成するものではなく、必ずしも TI の見解を反映したものではありません。TI の[使用条件](#)を参照してください。

9.5 Trademarks

TI E2E™ is a trademark of Texas Instruments.

すべての商標は、それぞれの所有者に帰属します。

9.6 Electrostatic Discharge Caution



This integrated circuit can be damaged by ESD. Texas Instruments recommends that all integrated circuits be handled with appropriate precautions. Failure to observe proper handling and installation procedures can cause damage.

ESD damage can range from subtle performance degradation to complete device failure. Precision integrated circuits may be more susceptible to damage because very small parametric changes could cause the device not to meet its published specifications.

9.7 Glossary

[TI Glossary](#) This glossary lists and explains terms, acronyms, and definitions.

10 Mechanical, Packaging, and Orderable Information

The following pages include mechanical, packaging, and orderable information. This information is the most current data available for the designated devices. This data is subject to change without notice and revision of this document. For browser-based versions of this data sheet, refer to the left-hand navigation.

PACKAGING INFORMATION

Orderable Device	Status (1)	Package Type	Package Drawing	Pins	Package Qty	Eco Plan (2)	Lead finish/ Ball material (6)	MSL Peak Temp (3)	Op Temp (°C)	Device Marking (4/5)	Samples
TPS7A4301DGQR	ACTIVE	HVSSOP	DGQ	10	2500	RoHS & Green	NIPDAUAG	Level-2-260C-1 YEAR	-40 to 125	4301	Samples
TPS7A4333DGQR	ACTIVE	HVSSOP	DGQ	10	2500	RoHS & Green	NIPDAUAG	Level-2-260C-1 YEAR	-40 to 125	4333	Samples
TPS7A4350DGQR	ACTIVE	HVSSOP	DGQ	10	2500	RoHS & Green	NIPDAUAG	Level-2-260C-1 YEAR	-40 to 125	4350	Samples

(1) The marketing status values are defined as follows:

ACTIVE: Product device recommended for new designs.

LIFEBUY: TI has announced that the device will be discontinued, and a lifetime-buy period is in effect.

NRND: Not recommended for new designs. Device is in production to support existing customers, but TI does not recommend using this part in a new design.

PREVIEW: Device has been announced but is not in production. Samples may or may not be available.

OBSOLETE: TI has discontinued the production of the device.

(2) **RoHS:** TI defines "RoHS" to mean semiconductor products that are compliant with the current EU RoHS requirements for all 10 RoHS substances, including the requirement that RoHS substance do not exceed 0.1% by weight in homogeneous materials. Where designed to be soldered at high temperatures, "RoHS" products are suitable for use in specified lead-free processes. TI may reference these types of products as "Pb-Free".

RoHS Exempt: TI defines "RoHS Exempt" to mean products that contain lead but are compliant with EU RoHS pursuant to a specific EU RoHS exemption.

Green: TI defines "Green" to mean the content of Chlorine (Cl) and Bromine (Br) based flame retardants meet JS709B low halogen requirements of <=1000ppm threshold. Antimony trioxide based flame retardants must also meet the <=1000ppm threshold requirement.

(3) MSL, Peak Temp. - The Moisture Sensitivity Level rating according to the JEDEC industry standard classifications, and peak solder temperature.

(4) There may be additional marking, which relates to the logo, the lot trace code information, or the environmental category on the device.

(5) Multiple Device Markings will be inside parentheses. Only one Device Marking contained in parentheses and separated by a "~" will appear on a device. If a line is indented then it is a continuation of the previous line and the two combined represent the entire Device Marking for that device.

(6) Lead finish/Ball material - Orderable Devices may have multiple material finish options. Finish options are separated by a vertical ruled line. Lead finish/Ball material values may wrap to two lines if the finish value exceeds the maximum column width.

Important Information and Disclaimer: The information provided on this page represents TI's knowledge and belief as of the date that it is provided. TI bases its knowledge and belief on information provided by third parties, and makes no representation or warranty as to the accuracy of such information. Efforts are underway to better integrate information from third parties. TI has taken and continues to take reasonable steps to provide representative and accurate information but may not have conducted destructive testing or chemical analysis on incoming materials and chemicals. TI and TI suppliers consider certain information to be proprietary, and thus CAS numbers and other limited information may not be available for release.

In no event shall TI's liability arising out of such information exceed the total purchase price of the TI part(s) at issue in this document sold by TI to Customer on an annual basis.

TAPE AND REEL INFORMATION

QUADRANT ASSIGNMENTS FOR PIN 1 ORIENTATION IN TAPE

*All dimensions are nominal

Device	Package Type	Package Drawing	Pins	SPQ	Reel Diameter (mm)	Reel Width W1 (mm)	A0 (mm)	B0 (mm)	K0 (mm)	P1 (mm)	W (mm)	Pin1 Quadrant
TPS7A4301DGQR	HVSSOP	DGQ	10	2500	330.0	12.4	5.3	3.4	1.4	8.0	12.0	Q1
TPS7A4333DGQR	HVSSOP	DGQ	10	2500	330.0	12.4	5.3	3.4	1.4	8.0	12.0	Q1
TPS7A4350DGQR	HVSSOP	DGQ	10	2500	330.0	12.4	5.3	3.4	1.4	8.0	12.0	Q1

TAPE AND REEL BOX DIMENSIONS

*All dimensions are nominal

Device	Package Type	Package Drawing	Pins	SPQ	Length (mm)	Width (mm)	Height (mm)
TPS7A4301DGQR	HVSSOP	DGQ	10	2500	366.0	364.0	50.0
TPS7A4333DGQR	HVSSOP	DGQ	10	2500	366.0	364.0	50.0
TPS7A4350DGQR	HVSSOP	DGQ	10	2500	366.0	364.0	50.0

GENERIC PACKAGE VIEW

DGQ 10

PowerPAD™ HVSSOP - 1.1 mm max height

3 x 3, 0.5 mm pitch

PLASTIC SMALL OUTLINE

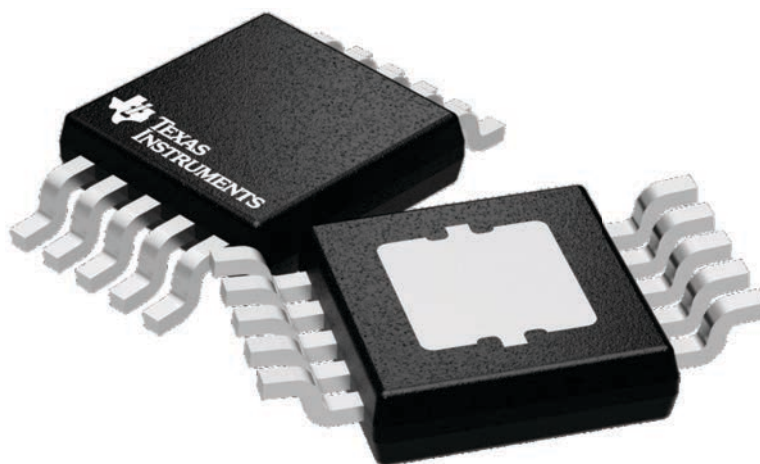

Images above are just a representation of the package family, actual package may vary.
Refer to the product data sheet for package details.

4224775/A

DGQ0010D



PACKAGE OUTLINE

PowerPAD™ - 1.1 mm max height

PLASTIC SMALL OUTLINE

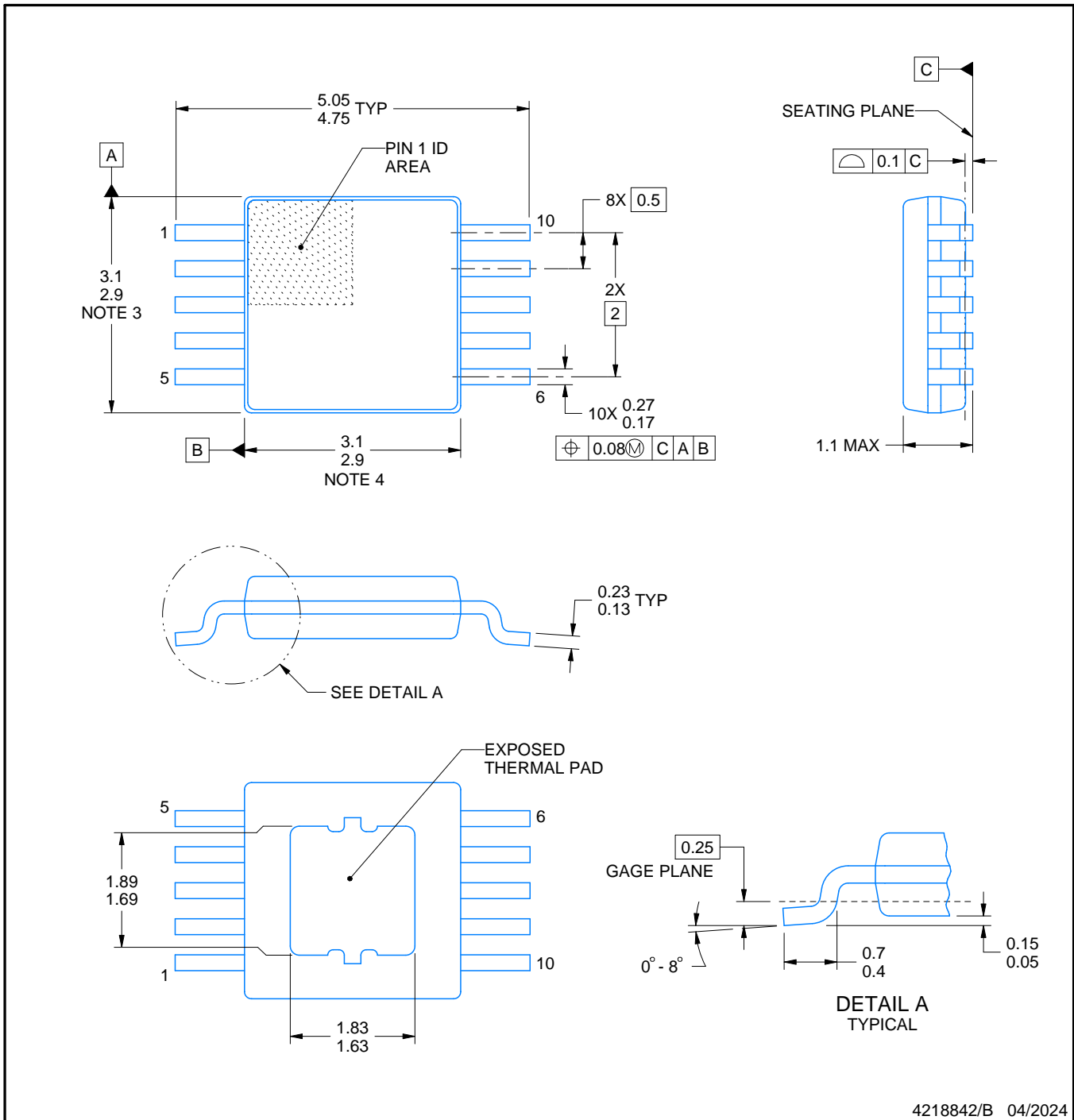

4218842/B 04/2024

PowerPAD is a trademark of Texas Instruments.

NOTES:

1. All linear dimensions are in millimeters. Any dimensions in parenthesis are for reference only. Dimensioning and tolerancing per ASME Y14.5M.
2. This drawing is subject to change without notice.
3. This dimension does not include mold flash, protrusions, or gate burrs. Mold flash, protrusions, or gate burrs shall not exceed 0.15 mm per side.
4. This dimension does not include interlead flash. Interlead flash shall not exceed 0.25 mm per side.
5. Reference JEDEC registration MO-187, variation BA-T.

EXAMPLE STENCIL DESIGN

DGQ0010D

PowerPAD™ - 1.1 mm max height

PLASTIC SMALL OUTLINE

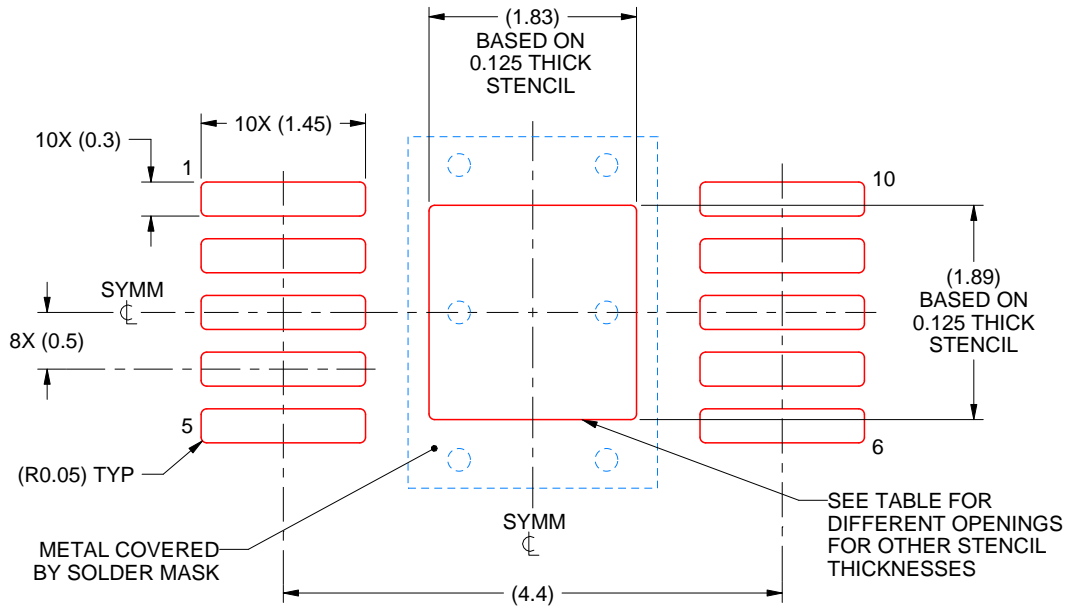

SOLDER PASTE EXAMPLE
EXPOSED PAD
100% PRINTED SOLDER COVERAGE BY AREA
SCALE:15X

STENCIL THICKNESS	SOLDER STENCIL OPENING
0.1	2.05 X 2.11
0.125	1.83 X 1.89 (SHOWN)
0.150	1.67 X 1.73
0.175	1.55 X 1.60

4218842/B 04/2024

NOTES: (continued)

10. Laser cutting apertures with trapezoidal walls and rounded corners may offer better paste release. IPC-7525 may have alternate design recommendations.
11. Board assembly site may have different recommendations for stencil design.

重要なお知らせと免責事項

TI は、技術データと信頼性データ (データシートを含みます)、設計リソース (リファレンス・デザインを含みます)、アプリケーションや設計に関する各種アドバイス、Web ツール、安全性情報、その他のリソースを、欠陥が存在する可能性のある「現状のまま」提供しており、商品性および特定目的に対する適合性の黙示保証、第三者の知的財産権の非侵害保証を含むいかなる保証も、明示的または黙示的にかかわらず拒否します。

これらのリソースは、TI 製品を使用する設計の経験を積んだ開発者への提供を意図したものです。(1) お客様のアプリケーションに適した TI 製品の選定、(2) お客様のアプリケーションの設計、検証、試験、(3) お客様のアプリケーションに該当する各種規格や、その他のあらゆる安全性、セキュリティ、規制、または他の要件への確実な適合に関する責任を、お客様のみが単独で負うものとし、

上記の各種リソースは、予告なく変更される可能性があります。これらのリソースは、リソースで説明されている TI 製品を使用するアプリケーションの開発の目的でのみ、TI はその使用をお客様に許諾します。これらのリソースに関して、他の目的で複製することや掲載することは禁止されています。TI や第三者の知的財産権のライセンスが付与されている訳ではありません。お客様は、これらのリソースを自身で使用した結果発生するあらゆる申し立て、損害、費用、損失、責任について、TI およびその代理人を完全に補償するものとし、TI は一切の責任を拒否します。

TI の製品は、[TI の販売条件](#)、または [ti.com](#) やかかる TI 製品の関連資料などのいずれかを通じて提供する適用可能な条項の下で提供されています。TI がこれらのリソースを提供することは、適用される TI の保証または他の保証の放棄の拡大や変更を意味するものではありません。

お客様がいかなる追加条項または代替条項を提案した場合でも、TI はそれらに異議を唱え、拒否します。

郵送先住所 : Texas Instruments, Post Office Box 655303, Dallas, Texas 75265
Copyright © 2024, Texas Instruments Incorporated