

## TI Designs: TIDA-01388

## 完全なフロントエンド保護機能を持つ、CISPR 25 Class 5 定格のデュアル車載用USB充電器のリファレンス・デザイン



## 概要

この21W、デュアルUSB充電器のリファレンス・デザインは、車載システムに特化して最適化されたものです。このデザインでは、フロントエンド保護機能を、広い入力コンバータと組み合わせて利用し、バッテリーからの動作を可能にしています。フロントエンド・フィルタとコンポーネントの選択は、厳格なCISPR 25 Class 5の伝導電磁気干渉(EMI)標準に合格するよう設計されています。このリファレンス・デザインは既にCISPR 25 Class 5の伝導EMI標準でテスト済みなので、顧客の設計時間を短縮できます。

## リソース

TIDA-01388	デザイン・フォルダ
LMS3655-Q1	プロダクト・フォルダ
TPS2561A-Q1	プロダクト・フォルダ
TPS2513A-Q1	プロダクト・フォルダ

## 特長

- デュアルUSB充電器システム用の、広い $V_{IN}$ のフロントエンド電源
- バッテリーから動作し、バッテリーの逆極性を保護
- 正および負の過渡電圧保護
- CISPR 25 Class 5の伝導EMIテストに合格済み
- すべてのデバイスがAEC-Q100認定済み
- 5.5V~36Vの広い $V_{IN}$ 範囲に対応
- 小型ソリューション

## アプリケーション

- 車載用USB充電器システム
- 車載用インフォテインメント・システム



E2E™ エキスパートに質問

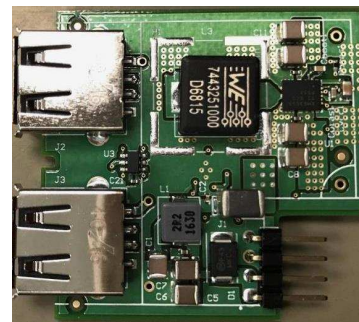
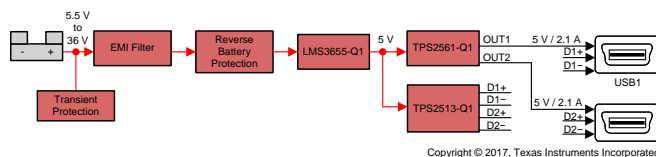

使用許可、知的財産、その他免責事項は、最終ページにあるIMPORTANT NOTICE(重要な注意事項)をご参照くださいますようお願いいたします。英語版のTI製品についての情報を翻訳したこの資料は、製品の概要を確認する目的で便宜的に提供しているものです。該当する正式な英語版の最新情報は、[www.ti.com](http://www.ti.com)で閲覧でき、その内容が常に優先されます。TIでは翻訳の正確性および妥当性につきましては一切保証いたしません。実際の設計などの前には、必ず最新版の英語版をご参照くださいますようお願いいたします。

## 1 System Description

This reference design offers a 21-W dual-automotive USB charger solution with complete front-end protection and small size. The design accepts a wide input voltage range from 5.5 V to 36 V and regulates two outputs of 5 V at 2.1 A for dual USB ports. This design includes an electromagnetic interference (EMI) filter and is compliant with CISPR 25 Class 5 conducted EMI standards.

The design is divided into four major blocks:

1. Front-end protection: Front-end protection has been implemented against positive and negative pulses (ISO7630 Pulse 1, 2a, 3a/b) through transient voltage suppression (TVS). A p-channel field-effect transistor is responsible for implementing reverse battery protection.
2. EMI filter: The design uses a differential EMI filter for conducted EMI suppression. The design also complies with CISPR25 Class 5 conducted EMI limits without using any shielding or common-mode filters.
3. Low EMI front-end DC/DC converters: The design uses the LMS3655-Q1 as the front end DC/DC converter, which is an automotive-qualified, low EMI, 400-kHz switching frequency, 5.5-A synchronous buck regulator. Except for the spread spectrum option, the device comes in an automotive-qualified HotRod™ QFN package with wettable flanks, which reduces parasitic inductance and resistance while increasing efficiency, minimizing switch node ringing, and dramatically lowering EMI.
4. Downstream USB power switch and charging port controller: The charging port controller (TPS2513A-Q1) provides the correct electrical signatures on the data line of the USB charger port while the power switch TPS2561A-Q1 is used as an overcurrent protector for the USB port.

### 1.1 Key System Specifications

表 1. Key System Specifications

PARAMETER	SPECIFICATIONS
$V_{IN}$ minimum	5.5 V
$V_{IN}$ maximum	36 V
$V_{IN}$ nominal	12 V (automotive design)
$V_{OUT1}$	5 V
$I_{OUT1}$	2.1 A
$V_{OUT2}$	5 V
$I_{OUT2}$	2.1 A
Approximate switching frequency	400 kHz
ISO pulse test	TVS diode used for protection
EMI	Passes CISPR 25 Class 5 limits

## 2 System Overview

### 2.1 Block Diagram

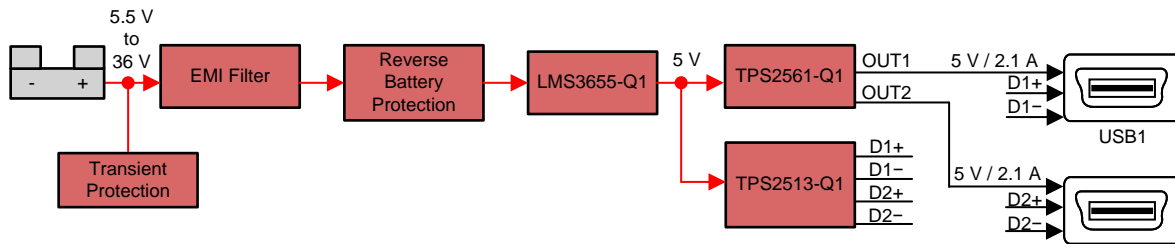

Copyright © 2017, Texas Instruments Incorporated

### 2.2 Design Considerations

The dual USB charger design has multiple protections at the front end of the design.

1. The TVS functions to clamp both positive and negative transient voltage pulses. These pulses include clamped load dump (up to 38 V) and other transients outlined in ISO 7637-2:2004.
2. The PFET is used in the front end so that the system properly responds to a reverse battery polarity event and shuts down appropriately.

A front-end EMI filter enables compliance with the CISPR 25 Class 5 automotive EMI standards, with respect to conducted emissions.

The synchronous buck converter LMS3655-Q1 is a wide input voltage range, low quiescent current, high performance regulator with internal compensation. The normal operating frequency for the LMS3655-Q1 regulator is 400 kHz and is below the AM band. The device is designed with a flip-chip or HotRod technology, which greatly reduces the parasitic inductance of the pins. In addition, the layout of the device allows for reduction in the radiated noise generated by the switching action through partial cancellation of the current-generated magnetic field.

Figure 1 shows the schematic of the front-end DC/DC converter.

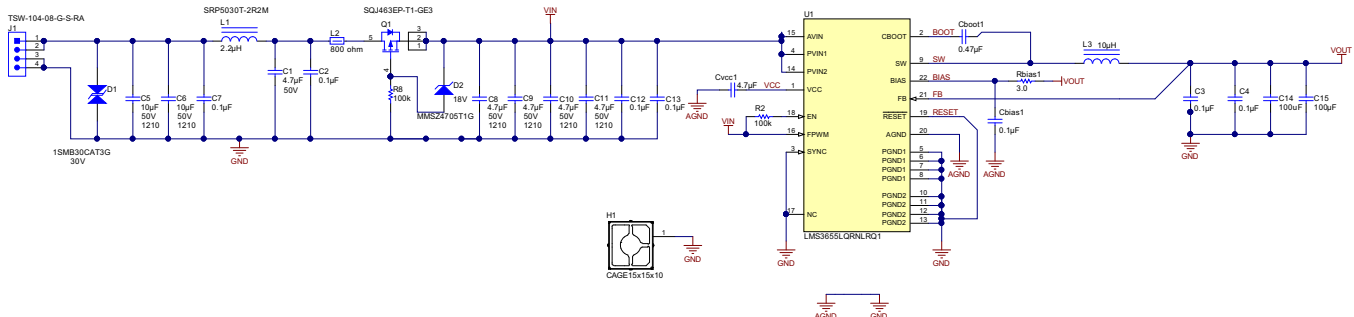

Copyright © 2017, Texas Instruments Incorporated

Figure 1. Schematic of Front-End DC/DC Converter

The TPS2561A-Q1 is a dual-channel, precision-adjustable, current-limited power switch. The overcurrent threshold is user programmable through an external resistor, R5. R5 sets the current-limit threshold for both channels. Set the desired current-limit threshold to 2.3 A because the full load current of each channel is 2.1 A. According to the relation between the current-limit threshold and resistor, R5 is set as 24.3 kΩ in the design.

For use with TPS2561A-Q1, the TPS2513A-Q1 is a low-loss, automotive-qualified, USB charging port solution that is capable of charging all current popular phones and tablets at the time of this writing. An auto-detect feature monitors the USB data line voltage and automatically provides the correct electrical signatures on the data lines to charge compliant devices.

Figure 2 shows the schematic of the USB power switch and dedicated charging port controller.

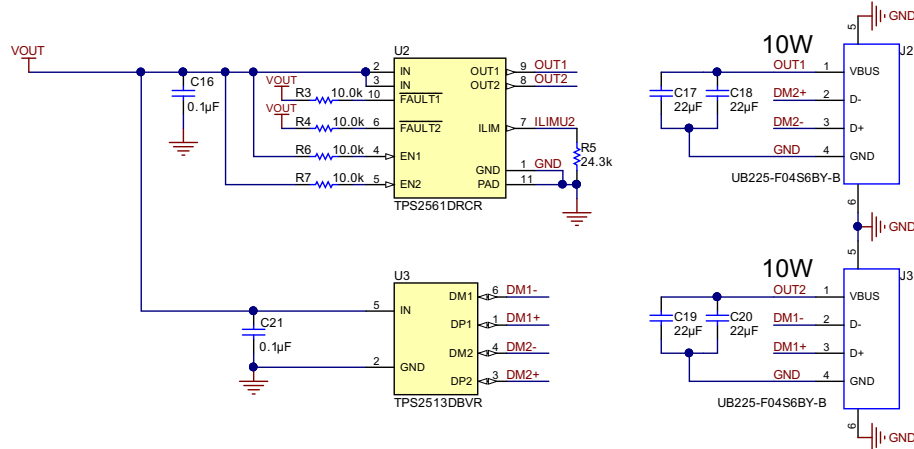

Copyright © 2017, Texas Instruments Incorporated

Figure 2. Schematic of USB Power Switch and Dedicated Charging Port Controller

For design calculations and layout examples, see the data sheets for the relevant devices:

- LMS3655-Q1: [LMS3635-Q1 3.5-A, LMS3655-Q1 5.5-A, 36-V Synchronous, 400-kHz Step-Down Converter Data Sheet](#)
- TPS2561A-Q1: [TPS2561A-Q1 Dual Channel Precision Automotive Adjustable Current-Limited Power Switches Data Sheet](#)
- TPS2513A-Q1: [TPS2513A-Q1, TPS2514A-Q1 USB Dedicated Charging Port Controller Data Sheet](#)

## 2.3 Highlighted Products

### 2.3.1 LMS36X5-Q1

Features:

- Synchronous buck converter
- Qualified for automotive applications (AEC-Q100 qualified)
- Wide operation input voltage: 3.5 V to 36 V (with transient to 42 V)
- Spread spectrum option available, which helps with EMI compliance
- 400-kHz fixed switching frequency, which avoids AM band
- Low quiescent current: 15  $\mu$ A
- $-40^{\circ}\text{C}$  to  $+150^{\circ}\text{C}$  junction temperature range
- Adjustable 3.3-V or 5-V output
- Maximum current load: 3.5 A for LMS3635-Q1, 5.5 A for LMS3655-Q1
- 4 mm  $\times$  5 mm, 0.5-mm pitch VQFN package with wettable flanks

### 2.3.2 TPS2561A-Q1

Features:

- Dual-channel precision adjustable current-limited power switch
- Qualified for automotive applications
- Two separate current limiting channels
- Meets USB current-limiting requirements
- Adjustable current limit, 250 mA to 2.8 A (typ)
- $\pm 7.5\%$  current-limit accuracy at 2.8 A
- Fast overcurrent response: 3.5  $\mu\text{s}$  (typ)
- Two 44-m $\Omega$  high-side MOSFETs
- Operating range: 2.5 V to 6.5 V

### 2.3.3 TPS2513A-Q1

Features:

- Dual-channel precision adjustable current-limited power switch
- Qualified for automotive applications (AEC-Q100 qualified)
- Automatically selects charge mode
- Operating range: 4.5 V to 5.5 V
- Available in SOT23-6 package

### 3 Hardware, Software, Testing Requirements, and Test Results

#### 3.1 Required Hardware

##### 3.1.1 Hardware

The following steps outline the hardware setup:

1. Connect a DC power supply to the board input as [Figure 3](#) shows.
2. To imitate the typical load of a USB output, connect an electronic or resistive load to the dual output as [Figure 3](#) shows. Each 5-V output is rated to a typical current of 2.1 A.



**Figure 3. TIDA-01388 Board Setup**

3. Begin evaluating the performance of the TIDA-01388 design.

#### 3.2 Testing and Results

The following diagrams show the design performance.

##### 3.2.1 Thermal Data

The infrared (IR) thermal image in [Figure 4](#) is taken at the steady state with 12 V<sub>IN</sub> and all outputs at a full load of 2.1 A (no airflow). The ambient temperature is 22°C.



**Figure 4. Thermal Image at Full Load**

### 3.2.2 Efficiency Data

The following [Figure 5](#) shows the graph of the converter efficiency versus load current at different input voltages. The solid lines show the LMS3655-Q1 efficiency loaded up to 4.2 A, with the load connected before the USB power switch. The dashed lines show the system efficiency of both channels loaded up to 2.1 A simultaneously, after the USB power switch.

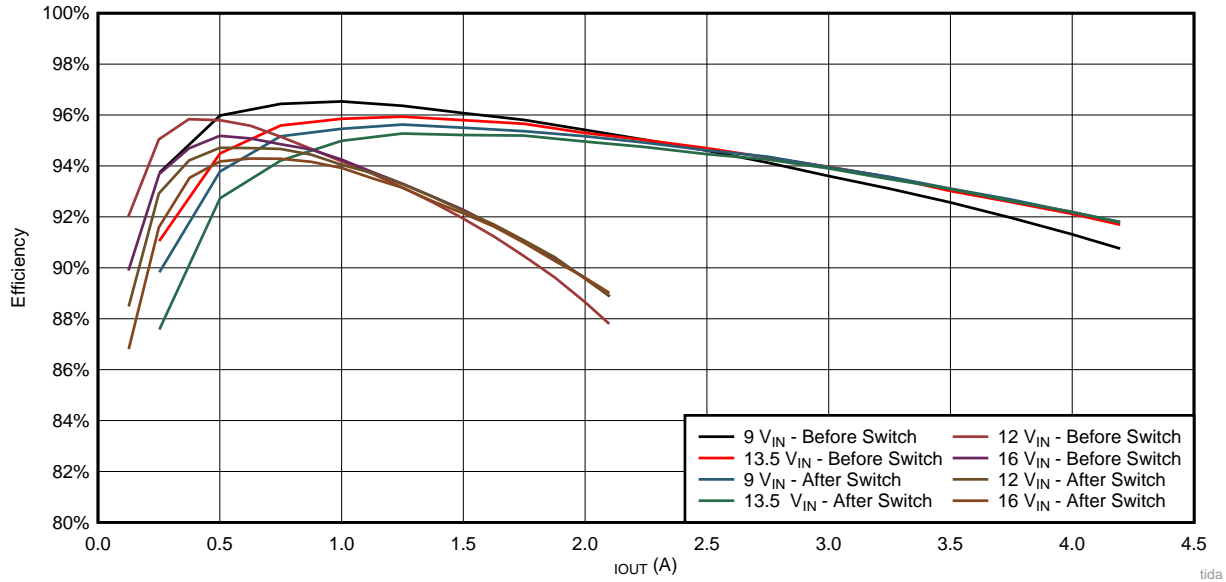

Figure 5. Efficiency versus Load Current

Table 2 and Table 3 list the system efficiency data before the power switch where  $V_{IN} = 9\text{ V}$  and  $V_{IN} = 13.5\text{ V}$ , respectively.

Table 2. System Efficiency Data—Before Switch ( $V_{IN} = 9\text{ V}$ )

$V_{IN}$ (V)	$I_{IN}$ (A)	$V_{OUT}$ (V)	$I_{OUT}$ (A)	$P_{IN}$ (W)	$P_{OUT}$ (W)	EFFICIENCY (%)
9.006	0.009	5.005	0.000	0.081	0.000	0.000
8.983	0.150	5.005	0.252	1.343	1.259	93.730
8.991	0.291	5.004	0.501	2.612	2.507	95.984
8.986	0.433	5.003	0.750	3.891	3.752	96.436
8.996	0.576	5.002	1.000	5.182	5.002	96.532
8.985	0.722	5.001	1.250	6.487	6.251	96.363
8.967	0.870	5.000	1.499	7.801	7.492	95.808
8.998	1.014	4.998	1.749	9.124	8.742	95.417
9.003	1.162	4.996	1.998	10.461	9.982	95.417
8.998	1.313	4.994	2.248	11.814	11.227	95.024
8.991	1.466	4.992	2.498	13.181	12.470	94.607
8.994	1.619	4.988	2.748	14.561	13.707	94.133
9.008	1.772	4.984	2.998	15.962	14.942	93.609
8.987	1.932	4.979	3.247	17.363	16.167	93.111
8.999	2.088	4.974	3.497	18.790	17.394	92.571
8.998	2.249	4.967	3.747	20.237	18.611	91.969
8.997	2.412	4.958	3.997	21.701	19.817	92.320
9.000	2.543	4.949	4.197	22.887	20.771	90.754



**表 3. System Efficiency Data—Before Switch ( $V_{IN} = 13.5\text{ V}$ )**

$V_{IN}$ (V)	$I_{IN}$ (A)	$V_{OUT}$ (V)	$I_{OUT}$ (A)	$P_{IN}$ (W)	$P_{OUT}$ (W)	EFFICIENCY (%)
13.494	0.010	5.004	0.000	0.135	0.000	0.000
13.496	0.104	5.003	0.252	1.404	1.261	89.824
13.498	0.198	5.003	0.501	2.673	2.507	93.785
13.500	0.292	5.002	0.750	3.942	3.752	95.167
13.502	0.388	5.001	1.000	5.239	5.001	95.461
13.504	0.484	5.000	1.250	6.536	6.250	95.625
13.505	0.581	4.999	1.499	7.846	7.494	95.502
13.497	0.679	4.997	1.749	9.164	8.740	95.366
13.499	0.777	4.996	1.998	10.489	9.982	95.169
13.500	0.876	4.993	2.248	11.826	11.224	94.912
13.501	0.976	4.991	2.498	13.177	12.468	94.616
13.502	1.076	4.989	2.748	14.528	13.710	94.367
13.503	1.178	4.985	2.998	15.907	14.945	93.955
13.503	1.280	4.981	3.247	17.284	16.173	93.575
13.493	1.385	4.976	3.497	18.688	17.401	93.115
13.503	1.488	4.970	3.747	20.092	18.623	92.684
13.497	1.594	4.962	3.997	21.514	19.833	92.186
13.503	1.678	4.956	4.197	22.658	20.800	91.801

表 4, 表 5, and 表 6 list the system efficiency data *after* the power switch where  $V_{IN} = 12\text{ V}$ ,  $V_{IN} = 13.5\text{ V}$ , and  $V_{IN} = 16\text{ V}$ , respectively.

**表 4. System Efficiency Data—After Switch ( $V_{IN} = 12\text{ V}$ )**

$V_{IN}$ (V)	$I_{IN}$ (A)	$V_{OUT1}$ (V)	$I_{OUT1}$ (A)	$V_{OUT2}$ (V)	$I_{OUT2}$ (A)	$P_{IN}$ (W)	$P_{OUT}$ (W)	EFFICIENCY (%)
12.00	0.011	5.009	0.000	5.010	0.000	0.132	0.000	0.000
12.00	0.115	5.002	0.123	5.002	0.125	1.380	1.240	89.891
12.00	0.223	4.994	0.251	4.994	0.251	2.676	2.507	93.684
12.01	0.328	4.987	0.374	4.987	0.374	3.939	3.730	94.694
12.00	0.436	4.980	0.500	4.980	0.500	5.232	4.980	95.183
11.99	0.546	4.972	0.626	4.971	0.626	6.547	6.224	95.078
12.01	0.654	4.964	0.750	4.963	0.751	7.855	7.450	94.852
12.00	0.764	4.956	0.876	4.955	0.875	9.168	8.677	94.645
11.99	0.876	4.948	1.000	4.946	1.001	10.503	9.899	94.247
11.99	0.988	4.938	1.126	4.936	1.124	11.846	11.108	93.771
12.01	1.099	4.927	1.250	4.925	1.250	13.199	12.315	93.303
12.00	1.214	4.917	1.376	4.915	1.374	14.568	13.519	92.799
11.99	1.330	4.905	1.501	4.902	1.500	15.947	14.715	92.279
12.01	1.444	4.892	1.624	4.889	1.626	17.342	15.894	91.649
12.00	1.563	4.879	1.750	4.875	1.751	18.756	17.074	91.034
11.99	1.682	4.863	1.874	4.859	1.875	20.167	18.224	90.364
12.00	1.802	4.844	2.000	4.840	2.001	21.624	19.373	89.590
11.99	1.901	4.824	2.100	4.820	2.101	22.793	20.257	88.875

**表 5. System Efficiency Data—After Switch ( $V_{IN} = 13.5\text{ V}$ )**

$V_{IN}$ (V)	$I_{IN}$ (A)	$V_{OUT1}$ (V)	$I_{OUT1}$ (A)	$V_{OUT2}$ (V)	$I_{OUT2}$ (A)	$P_{IN}$ (W)	$P_{OUT}$ (W)	EFFICIENCY (%)
13.50	0.011	5.009	0.000	5.010	0.000	0.149	0.000	0.000
13.51	0.105	5.000	0.125	5.001	0.126	1.419	1.255	88.480
13.50	0.199	4.992	0.250	4.993	0.250	2.687	2.496	92.918
13.50	0.294	4.986	0.376	4.986	0.374	3.969	3.740	94.218
13.49	0.390	4.978	0.500	4.978	0.501	5.261	4.983	94.714
13.51	0.486	4.971	0.626	4.970	0.625	6.566	6.218	94.703
13.50	0.582	4.962	0.750	4.962	0.749	7.857	7.438	94.668
13.49	0.680	4.954	0.874	4.953	0.875	9.173	8.664	94.445
13.51	0.778	4.946	1.000	4.944	0.999	10.511	9.885	94.047
13.49	0.878	4.937	1.124	4.935	1.125	11.844	11.101	93.726
13.49	0.979	4.927	1.250	4.925	1.251	13.207	12.320	93.285
13.51	1.078	4.917	1.374	4.914	1.375	14.564	13.513	92.783
13.51	1.182	4.906	1.502	4.903	1.501	15.969	14.728	92.231
13.50	1.285	4.893	1.626	4.890	1.626	17.348	15.907	91.697
13.49	1.389	4.877	1.750	4.874	1.750	18.738	17.064	91.070
13.51	1.493	4.863	1.876	4.858	1.876	20.170	18.237	90.413
13.50	1.601	4.842	2.000	4.837	2.000	21.614	19.358	89.564
13.49	1.689	4.823	2.101	4.819	2.101	22.785	20.253	88.889

**表 6. System Efficiency Data—After Switch ( $V_{IN} = 16\text{ V}$ )**

$V_{IN}$ (V)	$I_{IN}$ (A)	$V_{OUT1}$ (V)	$I_{OUT1}$ (A)	$V_{OUT2}$ (V)	$I_{OUT2}$ (A)	$P_{IN}$ (W)	$P_{OUT}$ (W)	EFFICIENCY (%)
16.01	0.011	5.009	0.000	5.010	0.000	0.176	0.000	0.000
16.00	0.090	5.000	0.124	5.000	0.126	1.440	1.250	86.806
16.00	0.170	4.992	0.249	4.993	0.250	2.720	2.491	91.590
16.01	0.250	4.985	0.375	4.985	0.376	4.003	3.744	93.535
16.00	0.330	4.978	0.499	4.977	0.500	5.280	4.973	94.177
15.99	0.412	4.970	0.625	4.969	0.625	6.588	6.212	94.292
15.99	0.493	4.962	0.749	4.961	0.749	7.883	7.432	94.282
16.01	0.575	4.954	0.875	4.953	0.875	9.206	8.669	94.165
16.00	0.659	4.945	1.001	4.943	1.002	10.544	9.903	93.919
16.00	0.743	4.935	1.127	4.934	1.126	11.888	11.117	93.518
15.99	0.827	4.926	1.251	4.924	1.250	13.224	12.317	93.146
15.99	0.913	4.916	1.375	4.913	1.376	14.599	13.520	92.608
15.99	0.999	4.904	1.501	4.901	1.501	15.974	14.717	92.133
16.00	1.084	4.891	1.625	4.888	1.625	17.344	15.891	91.622
15.99	1.172	4.876	1.749	4.873	1.749	18.740	17.051	90.986
15.99	1.261	4.859	1.875	4.855	1.873	20.163	18.204	90.283
16.01	1.349	4.842	2.001	4.838	1.998	21.597	19.355	89.618
16.01	1.422	4.826	2.101	4.822	2.100	22.766	20.266	89.016

### 3.2.3 Output Load Regulation

Figure 6 shows a graph of the output load regulation of the converter. The solid lines show the output load regulation loaded up to 4.2 A, before the USB switch. The dashed lines are for the output load regulation loaded up to 2.1 A, after the USB switch.

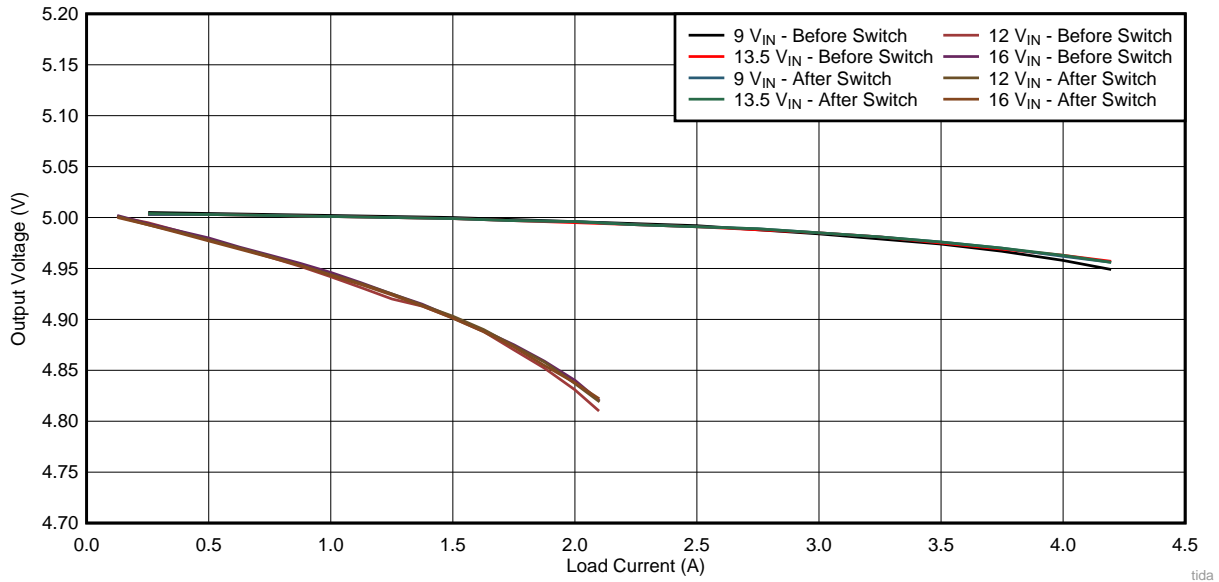

Figure 6. Load Regulation

### 3.2.4 Reverse Battery Protection

This design has implemented protection against a reverse battery connection. Figure 7 and Figure 8 show this performance.

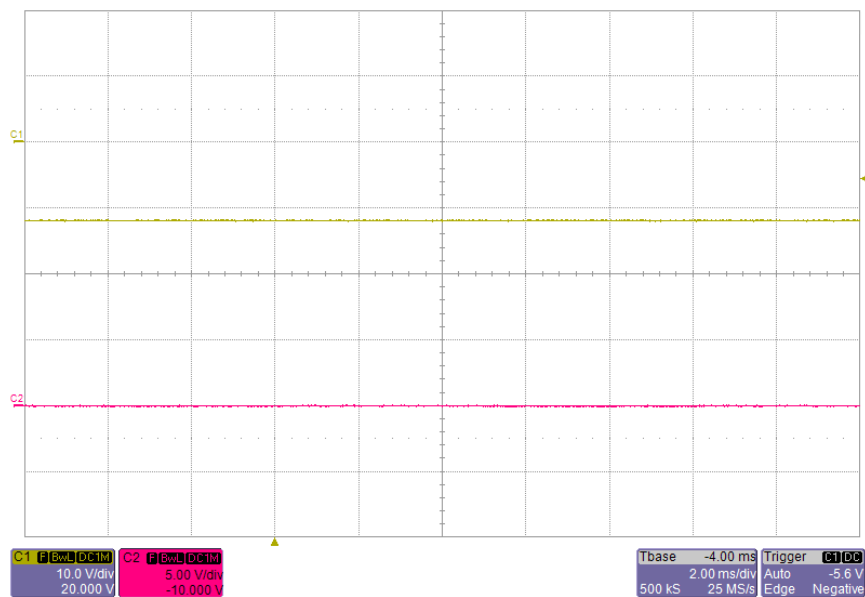

Figure 7. Continuous Reverse Voltage at Input C1: Input (Input Terminal for Battery), C2: V<sub>IN</sub> (Input for DC/DC Converter)



図 8. Transition to Reverse Voltage at Input C1: Input (Input Terminal for battery), C2:  $V_{IN}$  (Input for DC/DC Converter)

### 3.2.5 Start-Up

図 9 shows the start-up waveform at the 12-V input and no load. The yellow waveform is the input voltage, the pink waveform is the output before the power switch, and the blue and green waveforms are the two outputs after the power switch.

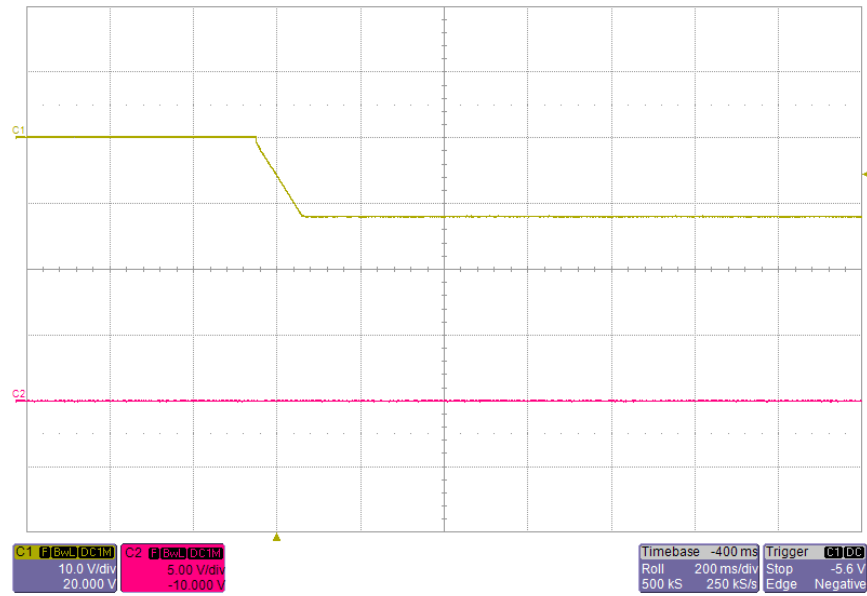

図 9. Start-up Waveform:  $V_{IN} = 12\text{ V}$ ,  $I_{OUT} = 0\text{ A}$   
 C1:  $V_{IN}$ , C2:  $V_{OUT}$  Before Switch, C3: OUT1 After Switch, C4: OUT2 After Switch

### 3.2.6 Dropout Performance

Figure 10 and Figure 11 show the low dropout operation with a 5.5-V input from the battery at no load and full load, respectively. The output voltage remains regulated at the 5.5-V input.

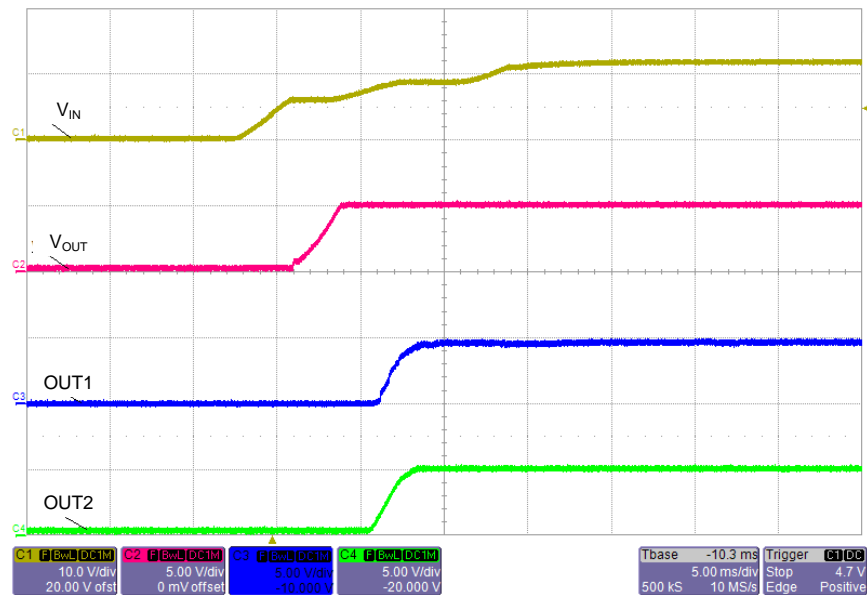
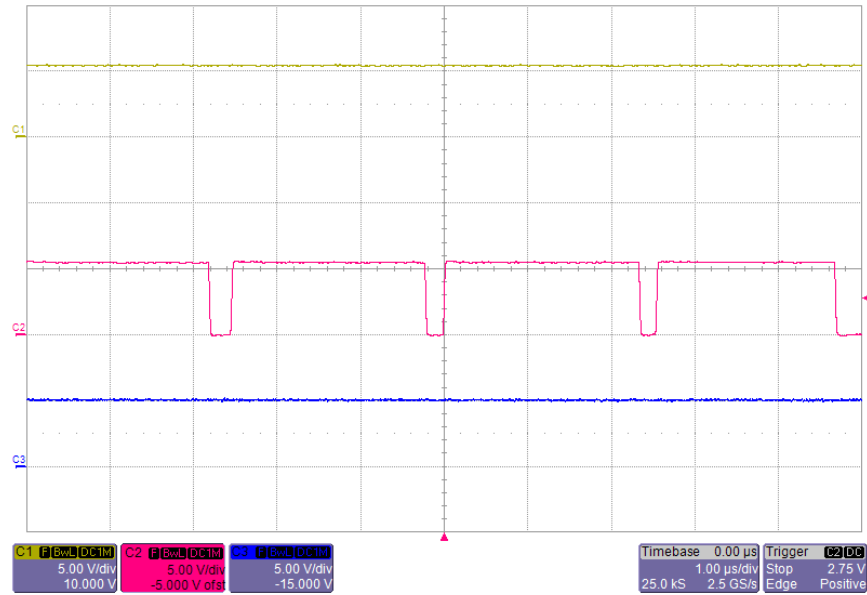

Figure 10. Low Dropout Operation:  $V_{IN} = 5.5\text{ V}$ , No Load  
 C1: Input (Input Terminal for Battery), C2: Switch Node, C3: OUT1 After Switch

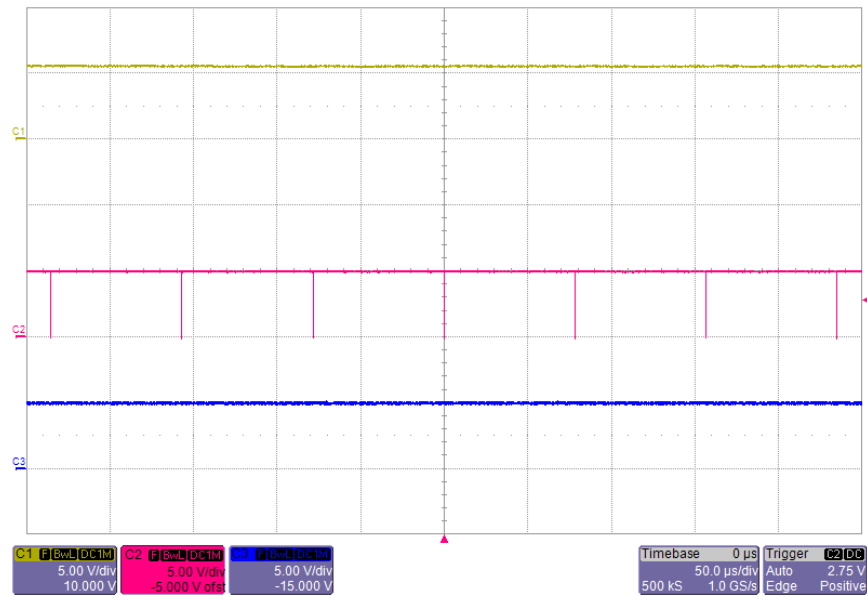

Figure 11. Low Dropout Operation:  $V_{IN} = 5.5\text{ V}$ , Full Load  
 C1: Input (Input Terminal for Battery), C2: Switch Node, C3: OUT1 After Switch

### 3.2.7 Switch Node Voltage and Output Voltage Ripple

Figure 12 shows the switch node voltage. The input voltage is 12 V and both outputs are loaded to 2.1 A. Figure 13 and Figure 14 show zoomed-in views for the rising and falling edges of the switch node. The switch node waveform shows very little overshoot and ringing. The automotive-qualified HotRod QFN package of the LMS3655 with wettable flanks reduces parasitic inductance and resistance while increasing efficiency, minimizing switch node ringing, and dramatically lowering EMI.

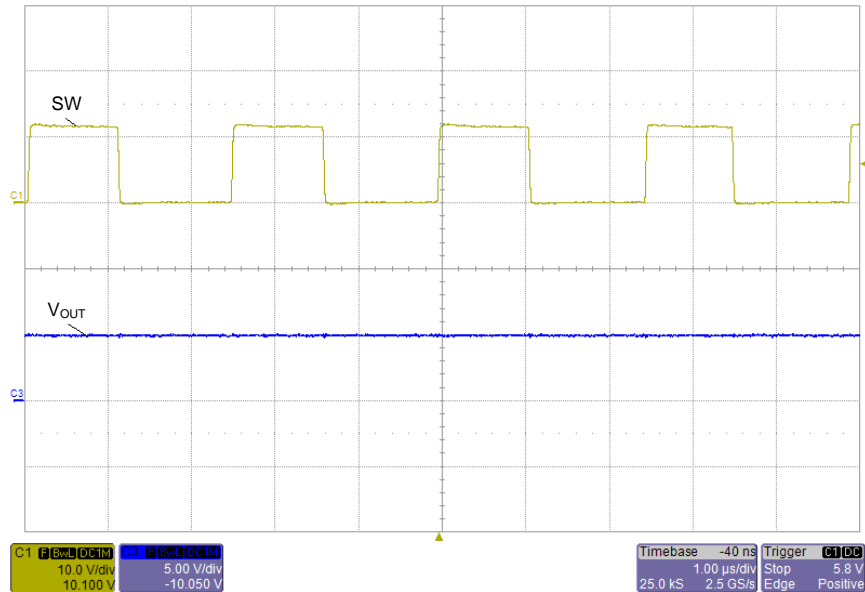

Figure 12. Switch Node Waveform—C1: Switch Node, C3:  $V_{OUT}$  Ripple

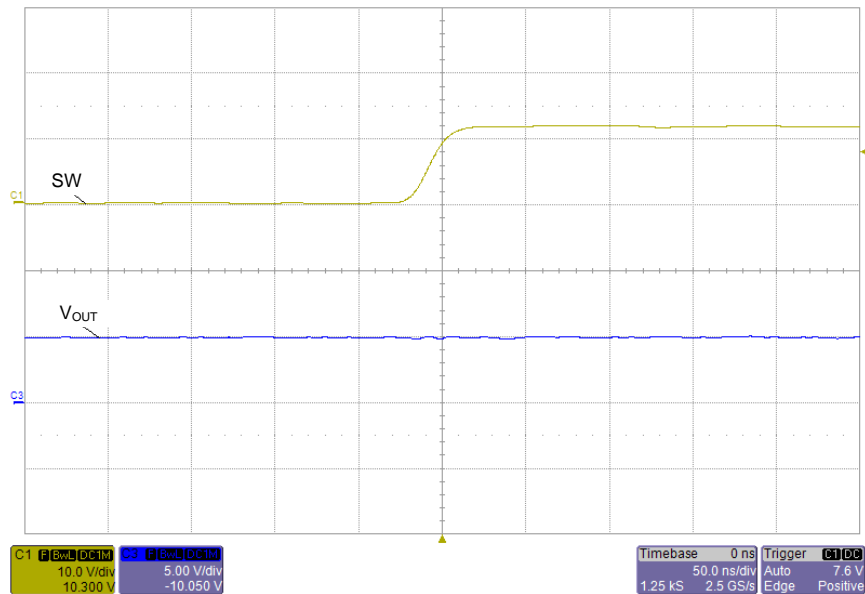

Figure 13. Rising-Edge Switch-Node Waveform—C1: Switch Node, C3:  $V_{OUT}$



図 14. Falling-Edge Switch-Node Waveform—C1: Switch Node, C3:  $V_{OUT}$

### 3.2.8 Load Transient Response

The load transient waveforms monitor the output voltage and the load current. Channel 1 (yellow) and channel 3 (blue) represent the output voltage before and after the USB switch, separately. Both channels are AC coupled. Channel 4 (green) monitors the load current. 図 15 and 図 16 show the load transient response with 12  $V_{IN}$ .

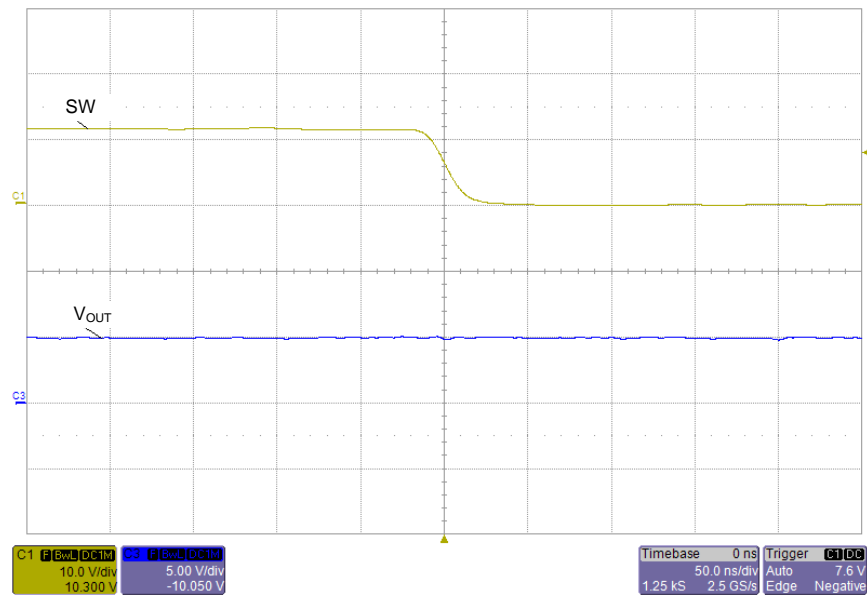

図 15. Load Transient of 1 A to 0 A—C1:  $V_{OUT}$  Before Switch (AC Coupled), C3: OUT1 After Switch (AC Coupled), C4:  $I_{OUT}$



図 16. Load Transient of 2.1 A to 1.0 A—C1:  $V_{OUT}$  Before Switch (AC Coupled), C3: OUT1 After Switch (AC Coupled), C4:  $I_{OUT}$

### 3.2.9 Conducted Emissions

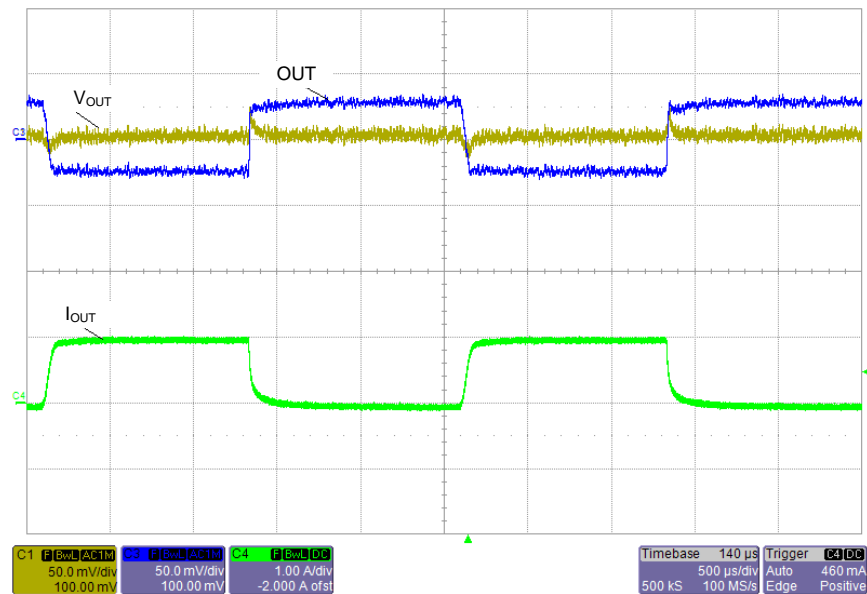
図 17 shows the bench setup for the conducted EMI performance test. The inductor has no shield when testing.

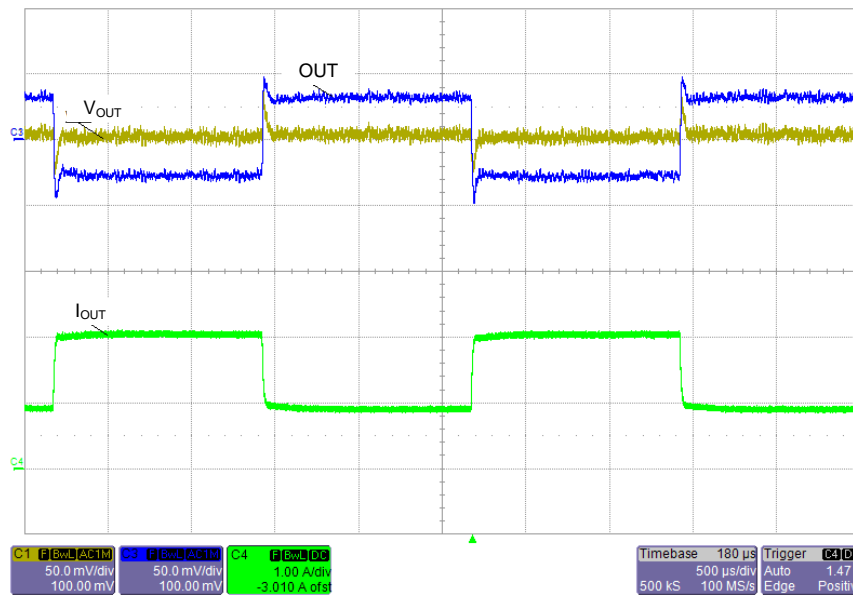

図 17. EMI Test Bench Setup



Figure 18 and Figure 19 show the conducted emissions plots based on the CISPR 25 class 5 standards. The input voltage is 12 V and both outputs are loaded to 2.1 A.

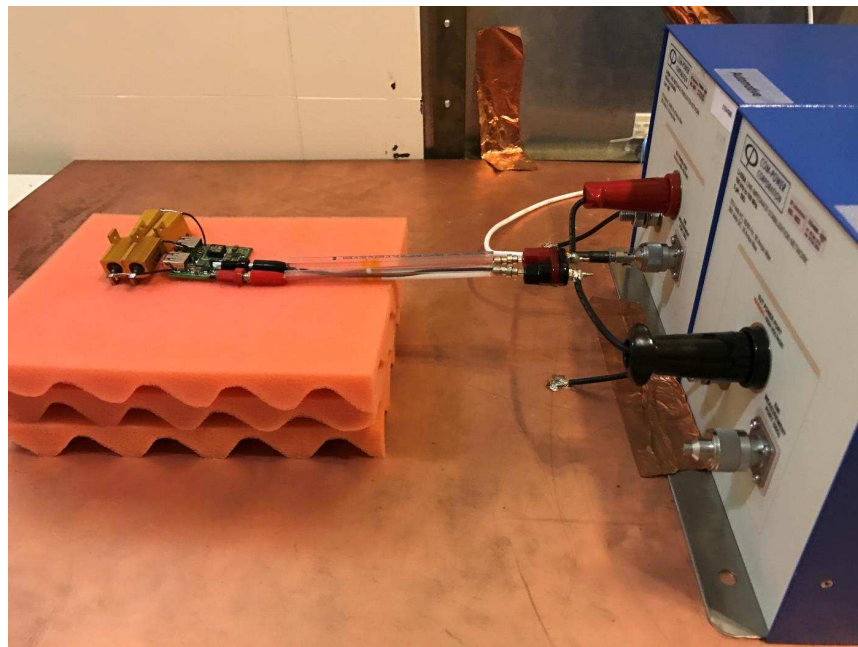
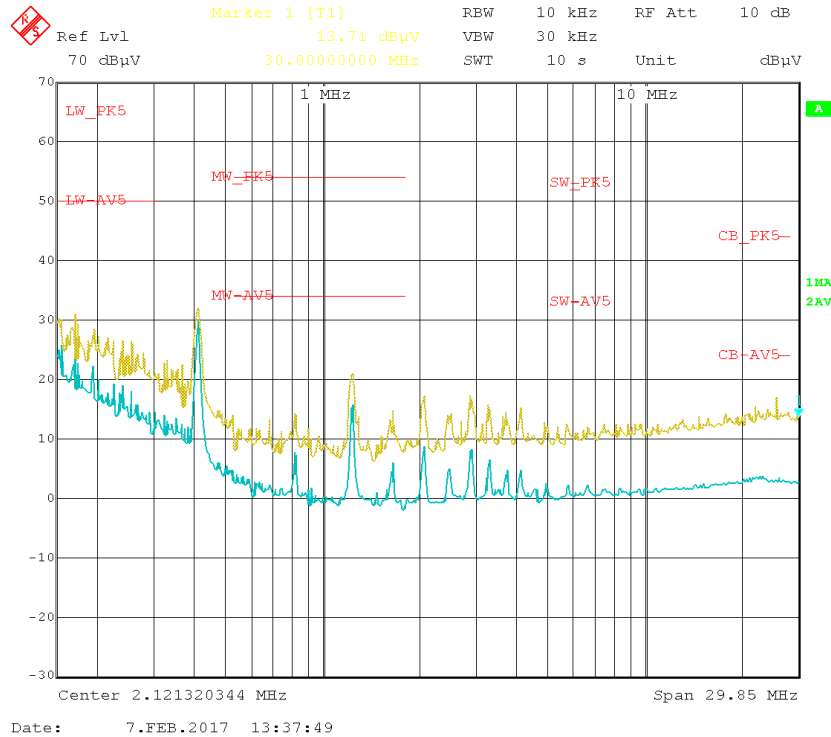

Figure 18. EMI Performance From 150 kHz to 30 MHz:  $V_{IN} = 12\text{ V}$ ,  $I_{OUT} = 4.2\text{ A}$   
 (Yellow: Peak Detection Result; Blue: Average Detection Result; Red: CISPR 25 Class 5 Limits)

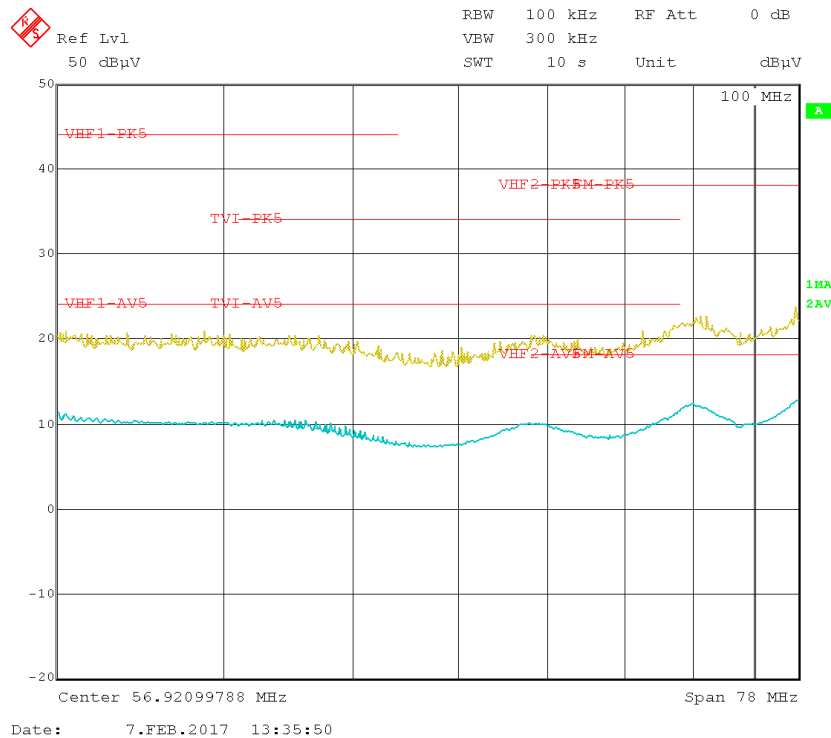

Figure 19. EMI Performance From 30 MHz to 108 MHz:  $V_{IN} = 12\text{ V}$ ,  $I_{OUT} = 4.2\text{ A}$   
 (Yellow: Peak Detection Result; Blue: Average Detection Result; Red: CISPR 25 Class 5 Limits)

## 4 Design Files

### 4.1 Schematics

To download the schematics, see the design files at [TIDA-01388](#).

### 4.2 Bill of Materials

To download the bill of materials (BOM), see the design files at [TIDA-01388](#).

### 4.3 PCB Layout Recommendations

#### 4.3.1 Layout Prints

To download the layer plots, see the design files at [TIDA-01388](#).

### 4.4 Altium Project

To download the Altium project files, see the design files at [TIDA-01388](#).

### 4.5 Gerber Files

To download the Gerber files, see the design files at [TIDA-01388](#).

### 4.6 Assembly Drawings

To download the assembly drawings, see the design files at [TIDA-01388](#).

## 5 Software Files

To download the software files, see the design files at [TIDA-01388](#).

## 6 Related Documentation

1. Texas Instruments, [LMS3635-Q1 3.5-A, LMS3655-Q1 5.5-A, 36-V Synchronous, 400-kHz Step-Down Converter Data Sheet](#)
2. Texas Instruments, [TPS2561A-Q1 Dual Channel Precision Automotive Adjustable Current-Limited Power Switches Data Sheet](#)
3. Texas Instruments, [TPS2513A-Q1, TPS2514A-Q1 USB Dedicated Charging Port Controller Data Sheet](#)
4. Texas Instruments, [TIDA-00366 Reinforced Isolation 3-Phase Inverter With Current Voltage Design Guide](#)

### 6.1 商標

E2E, HotRod are trademarks of Texas Instruments.  
すべての商標および登録商標はそれぞれの所有者に帰属します。

## TIの設計情報およびリソースに関する重要な注意事項

Texas Instruments Incorporated ("TI")の技術、アプリケーションその他設計に関する助言、サービスまたは情報は、TI製品を組み込んだアプリケーションを開発する設計者に役立つことを目的として提供するものです。これにはリファレンス設計や、評価モジュールに関する資料が含まれますが、これらに限られません。以下、これらを総称して「TIリソース」と呼びます。いかなる方法であっても、TIリソースのいずれかをダウンロード、アクセス、または使用した場合、お客様(個人、または会社を代表している場合にはお客様の会社)は、これらのリソースをここに記載された目的にのみ使用し、この注意事項の条項に従うことに合意したものとします。

TIによるTIリソースの提供は、TI製品に対する該当の発行済み保証事項または免責事項を拡張またはいかなる形でも変更するものではなく、これらのTIリソースを提供することによって、TIにはいかなる追加義務も責任も発生しないものとします。TIは、自社のTIリソースに訂正、拡張、改良、およびその他の変更を加える権利を留保します。

お客様は、自らのアプリケーションの設計において、ご自身が独自に分析、評価、判断を行う責任がお客様にあり、お客様のアプリケーション(および、お客様のアプリケーションに使用されるすべてのTI製品)の安全性、および該当するすべての規制、法、その他適用される要件への遵守を保証するすべての責任をお客様のみが負うことを理解し、合意するものとします。お客様は、自身のアプリケーションに関して、(1) 故障による危険な結果を予測し、(2) 障害とその結果を監視し、および、(3) 損害を引き起こす障害の可能性を減らし、適切な対策を行う目的で、安全策を開発し実装するために必要な、すべての技術を保持していることを表明するものとします。お客様は、TI製品を含むアプリケーションを使用または配布する前に、それらのアプリケーション、およびアプリケーションに使用されているTI製品の機能性を完全にテストすることに合意するものとします。TIは、特定のTIリソース用に発行されたドキュメントで明示的に記載されているもの以外のテストを実行していません。

お客様は、個別のTIリソースにつき、当該TIリソースに記載されているTI製品を含むアプリケーションの開発に関連する目的でのみ、使用、コピー、変更することが許可されています。明示的または黙示的を問わず、禁反言の法理その他どのような理由でも、他のTIの知的所有権に対するその他のライセンスは付与されません。また、TIまたは他のいかなる第三者のテクノロジーまたは知的所有権についても、いかなるライセンスも付与されるものではありません。付与されないものには、TI製品またはサービスが使用される組み合わせ、機械、プロセスに関連する特許権、著作権、回路配置利用権、その他の知的所有権が含まれますが、これらに限られません。第三者の製品やサービスに関する、またはそれらを参照する情報は、そのような製品またはサービスを利用するライセンスを構成するものではなく、それらに対する保証または推奨を意味するものでもありません。TIリソースを使用するため、第三者の特許または他の知的所有権に基づく第三者からのライセンス、あるいはTIの特許または他の知的所有権に基づくTIからのライセンスが必要な場合があります。

TIのリソースは、それに含まれるあらゆる欠陥も含めて、「現状のまま」提供されます。TIは、TIリソースまたはその仕様に関して、明示的か暗黙的にかかわらず、他のいかなる保証または表明も行いません。これには、正確性または完全性、権原、続発性の障害に関する保証、および商品性、特定目的への適合性、第三者の知的所有権の非侵害に対する黙示的保証が含まれますが、これらに限られません。

TIは、いかなる苦情に対しても、お客様への弁済または補償を行う義務はなく、行わないものとします。これには、任意の製品の組み合わせに関連する、またはそれらに基づく侵害の請求も含まれますが、これらに限られず、またその事実についてTIリソースまたは他の場所に記載されているか否かを問わないものとします。いかなる場合も、TIリソースまたはその使用に関連して、またはそれらにより発生した、実際の、直接的、特別、付随的、間接的、懲罰的、偶発的、または、結果的な損害について、そのような損害の可能性についてTIが知らされていたかどうかにかかわらず、TIは責任を負わないものとします。

お客様は、この注意事項の条件および条項に従わなかったために発生した、いかなる損害、コスト、損失、責任からも、TIおよびその代表者を完全に免責するものとします。

この注意事項はTIリソースに適用されます。特定の種類の資料、TI製品、およびサービスの使用および購入については、追加条項が適用されます。これには、半導体製品(<http://www.ti.com/sc/docs/stdterms.htm>)、評価モジュール、およびサンプル(<http://www.ti.com/sc/docs/sampterm.htm>)についてのTIの標準条項が含まれますが、これらに限られません。