

TI Designs: TIDA-01585

閉ループ速度制御機能を持つ24V、36WのセンサレスBLDC正弦モータ・ドライブのリファレンス・デザイン



概要

このブラシレスDC (BLDC)モータ・ドライブのリファレンス・デザインは、閉ループ制御を使用し、2つのチップだけで高い速度精度を達成しています。最初のチップは、コスト効果の高いエン트리・レベルの、広く使用されている超低消費電力MSP430ファミリのMCUです。もう1つのチップ (DRV10987)は、3相、センサレス、180°正弦モータ・ドライブで、パワーMOSFETが内蔵されています。ソリューション全体は、高い効率と小さな外形を持ち、モータに簡単に収容できるよう最適化されています。

リソース

- TIDA-01585 デザイン・フォルダ
- DRV10987 プロダクト・フォルダ
- MSP430FR2311 プロダクト・フォルダ

E2E™ エキスパートに質問

特長

- センサレス36W、24Vドライブで、正弦整流によりブラシレスDC (BLDC)モータを駆動可能
- 閉ループ速度制御により、予測モータ速度の精度を向上
- 高度に統合され保護されたシングル・チップの正弦ブラシレス・モータ・コントローラにより、外付け部品数と可聴帯域ノイズが減少
- 閉ループ・システムで、使用するチップは2つだけ
- 最適化された小さな外形(SFF)により、モータに内蔵可能
- 信頼性の高いスタートアップと、短絡、過電流、ロータのブロックの保護機能を持つ、完全に保護されたシステム
- 動作時周囲温度: -20°C ~ +85°C
- 降圧およびリニア・レギュレータが内蔵されており、電源電圧を効率的に3.3Vに降圧し、内部と外部(TI MSP430™ MCU)の両方の回路に給電

アプリケーション

- 扇風機
- シーリングファン
- 空気清浄機
- 洗濯機、ドライヤーのファン

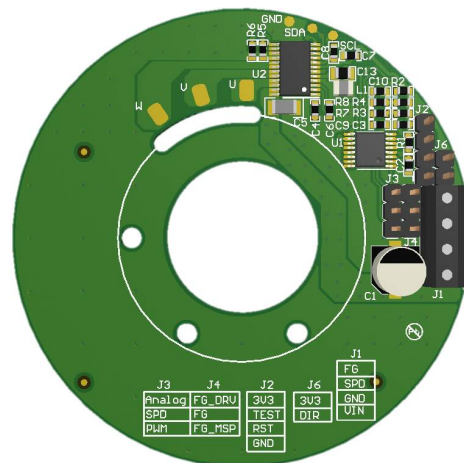
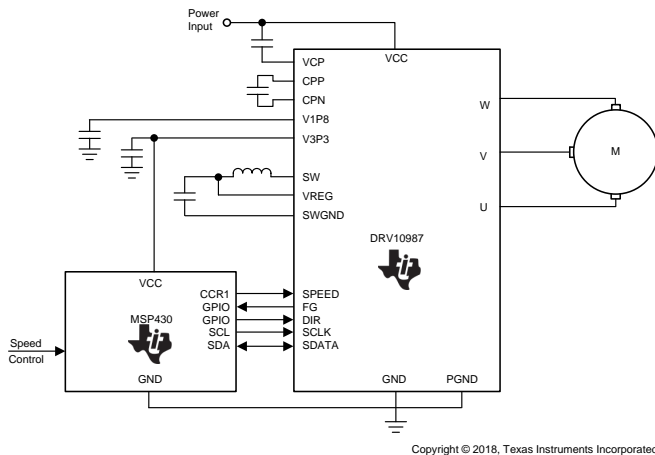



使用許可、知的財産、その他免責事項は、最終ページにあるIMPORTANT NOTICE(重要な注意事項)をご参照くださいますようお願いいたします。英語版のTI製品についての情報を翻訳したこの資料は、製品の概要を確認する目的で便宜的に提供しているものです。該当する正式な英語版の最新情報は、www.ti.comで閲覧でき、その内容が常に優先されます。TIでは翻訳の正確性および妥当性につきましては一切保証いたしません。実際の設計などの前には、必ず最新版の英語版をご参照くださいますようお願いいたします。

1 System Description

In application fields such as appliances and industrial, brushless DC (BLDC) motors are starting to replace traditional brushed DC motors. Compared to the brushed DC motor, the BLDC uses an electric commutator to replace the mechanical commutator, making it more reliable and providing a longer lifetime. BLDC motors are also more efficient than brushed DC motors. For the same input power, a BLDC motor converts more electrical power into mechanical power than a brushed motor.

The general advantages of BLDC motors are as follows:

- High efficiency
- Low audible noise
- Better speed versus torque characteristics
- High dynamic response
- Long operating life due to a lack of electrical and friction losses
- Higher speed ranges

One of the concerns from a design perspective is that driving a BLDC motor is complicated. This task requires engineers to have a high technological background. With the development of integrated circuits, some specific motor drivers with integrated power MOSFETs and control schemes, like the TI DRV10x, help to solve this problem and simplify use of the BLDC motor. Because of such developments, BLDC motors have already been widely used in refrigerators, washing machines, dishwashers, pumps, and different kind of fans.

Some application scenarios require high accuracy; for example, a high-performance BLDC control system. Achieve high accuracy by using closed-loop control in a majority of BLDC control systems. This reference design provides a precise and effective speed control system with closed-loop. It is a cost-effective, small form factor (SFF), three-phase sinusoidal motor drive for a BLDC motor up to a power of 36 W at 24 V. The board accepts the speed command through pulse-width modulation (PWM) or through analog voltage from an external signal, and provides the three motor outputs to drive the BLDC motor with pure sinusoidal current waveform.

This reference design uses only two chips. A simple MCU, MSP430FR2311, accepts the external speed command, and a proportional-integral (PI) control algorithm is implemented to control the driver. The DRV10987 device is a three-phase sensorless motor driver with integrated power MOSFETs and an embedded, proprietary sensorless control scheme. The device has a flexible user interface that accepts analog, PWM, or I²C input from the MCU. The integrated buck converter of the DRV10987 is capable of powering both internal and external circuits. Achieve the optimum motor spin-up profile by tuning all of the applicable configuration parameters inside the electrically erasable programmable read-only memory (EEPROM) of the DRV10987 device.

1.1 Key System Specifications

表 1. Key System Specifications

PARAMETER	MIN	NOM	MAX	UNIT
DC input voltage ⁽¹⁾	18	24	28	V
Power level	0	—	36	W
Output current	0	1.5	2	A
Electrical frequency ⁽²⁾	1	—	1000	Hz
Accuracy ⁽³⁾	—	—	1	%
Operating temperature	-20	25	85	°C

⁽¹⁾ This design can accept a 6.2-V to 28-V power supply, which fits the motor rated voltage. For this test setup, a 24-V nominal value is used to run the specified motor.

⁽²⁾ The maximum electrical frequency for DRV10987 is 1000 Hz. This parameter and pole pairs determine the maximum mechanical speed of the target motor. The maximum speed of the motor, which is used in test setup of this design, is 1000 RPM.

⁽³⁾ This parameter indicates the maximum speed error.

2 System Overview

2.1 Block Diagram



図 1. TIDA-01585 Block Diagram

2.2 Highlighted Products

The following subsections detail the highlighted products used in this reference design, including the key features for their selection. See their respective product data sheets for complete details on any highlighted device.

2.2.1 MSP430FR2311

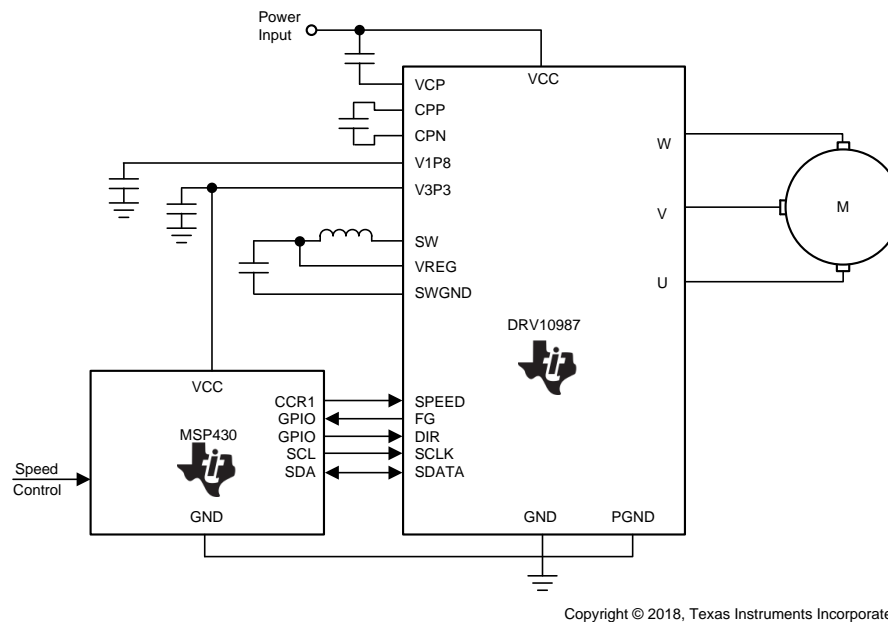
The ultra-low-power MSP430FR231x FRAM MCU family consists of several devices that feature embedded nonvolatile FRAM and different sets of peripherals targeted for various sensing and measurement applications. The architecture, FRAM, and peripherals, combined with extensive low-power modes, are optimized to achieve extended battery life in portable and wireless sensing applications. FRAM is a new nonvolatile memory that combines the speed, flexibility, and endurance of SRAM with the stability and reliability of flash, all at a lower total power consumption.

The MSP430FR231x FRAM MCU is the world's first MCU with a configurable low-leakage current sense amplifier, and features a powerful 16-bit reduced instruction set computer (RISC) central processing unit (CPU), 16-bit registers, and constant generators that contribute to maximum code efficiency. The digitally-controlled oscillator (DCO) also allows the device to wake up from low-power modes to active mode typically in less than 10 μ s. Additionally, developers can reduce PCB real estate by up to 75% with integrated analog, EEPROM, crystal, and MCU functionality in a 4-mm \times 3.5-mm package. The feature set of this MCU is ideal for applications ranging from smoke detectors to portable health and fitness accessories.

図 2 shows the MSP430FR231X block diagram.



図 2. MSP430FR231X Block Diagram

2.2.2 DRV10987

The DRV10987 is a three-phase sensorless motor driver with integrated power MOSFETs, which provide drive current capability up to 2 A (continuous). The device uses a proprietary 180° sensorless control scheme to provide continuous sinusoidal drive, which significantly reduces the pure-tone acoustics that typically occur as a result of commutation by keeping the electrically-induced torque ripple small. Therefore, the device is specifically designed for 12- to 24-V motor drive applications with low noise and a low external component count.

The device is configurable through a simple I²C interface to reprogram specific motor parameters in registers, and program the EEPROM to accommodate different motor parameters and spin-up profiles for different customer applications. The user can control the motor directly through the PWM input, analog input, or I²C inputs. The motor speed feedback is available through either the FG pin or I²C interface.

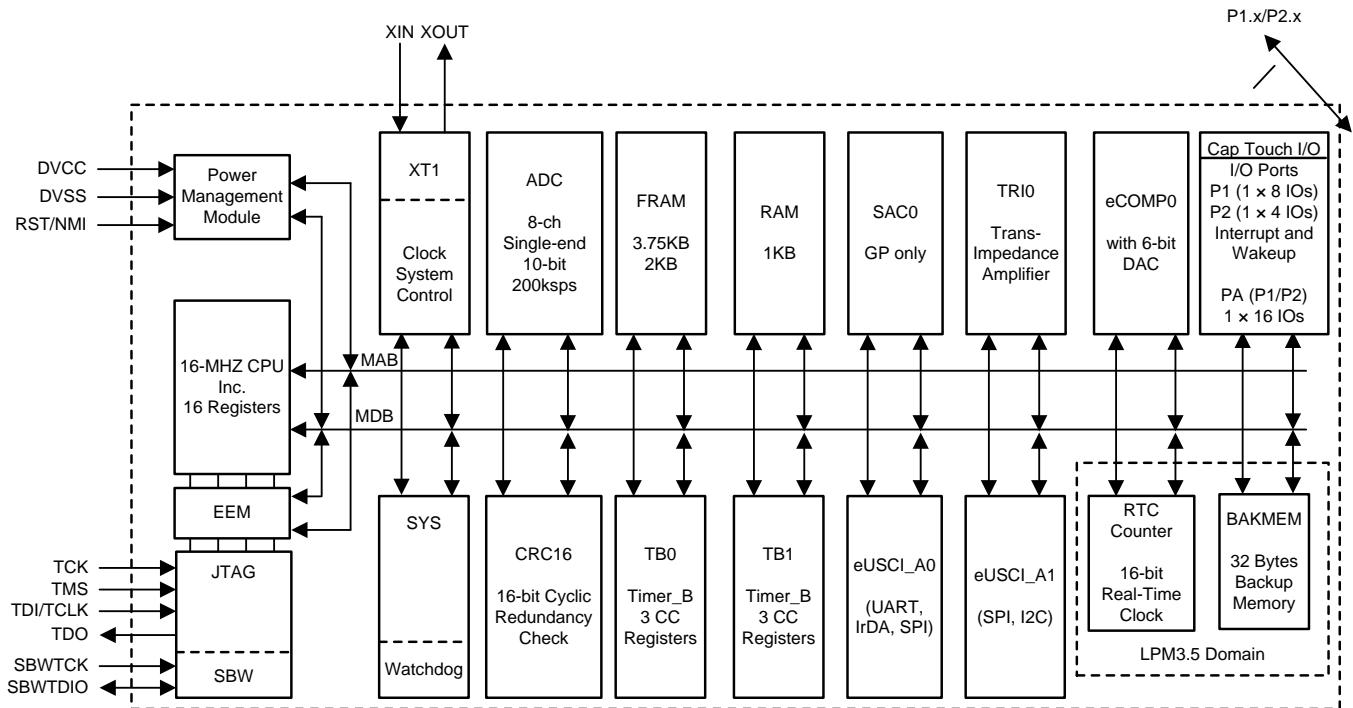
The DRV10987 features extensive protection and fault detect mechanisms to ensure reliable operation. Voltage surge protection prevents the input VCC capacitor from overcharging, which is typical during motor deceleration. The device provides overcurrent protection without the requirement of an external current sense resistor. Rotor lock detect is available through several methods. The user can configure these methods with register settings to ensure reliable operation. The device provides additional protection for undervoltage lockout (UVLO) and for thermal shutdown.

The DRV10987 driver features an integrated buck and linear regulator to efficiently step down the supply voltage to either 5 V or 3.3 V for powering both internal and external circuits. The device is available in either a sleep mode or a standby mode version to conserve power when the motor is inactive.

図 3 shows the DRV10987 block diagram.



図 3. DRV10987 Block Diagram

表 2. Connector Description

CONNECTOR	PINS	DESCRIPTION
J1 ⁽¹⁾	1: VIN; 2: GND; 3: SPD; 4: FG	External power input and speed command interface
J2	1: GND; 2: TCK; 3: TDIO; 4: 3V3	Reserved for MSP430™ MCU programming; connect to external specified programmer or LaunchPad™ Development Kit
J3	1: ANALOG; 2: SPD; 3: PWM	External signal type selection for speed control; short circuit pins 1 and 2 for analog or short circuit pins 2 and 3 for PWM
J4	1: FG_DRV; 2: FG; 3: FG_MSP	Output signal type selection for motor speed feedback; short circuit pins 1 and 2 for DRV10987 output or short circuit pins 2 and 3 for MCU output
J6	1: 3V3; 2: DIR	Motor spin direction control; short circuit pins 1 and 2 for reverse rotation; if MCU determines the direction, keep it open

⁽¹⁾ Operation voltage ranges from 6.2 V to 28 V. The test setup (see 3.2) uses a normal value of 24 V to run the specified motor. SPD is defined as the external speed control signal input. Specify this pin as analog or PWM by setting J3.

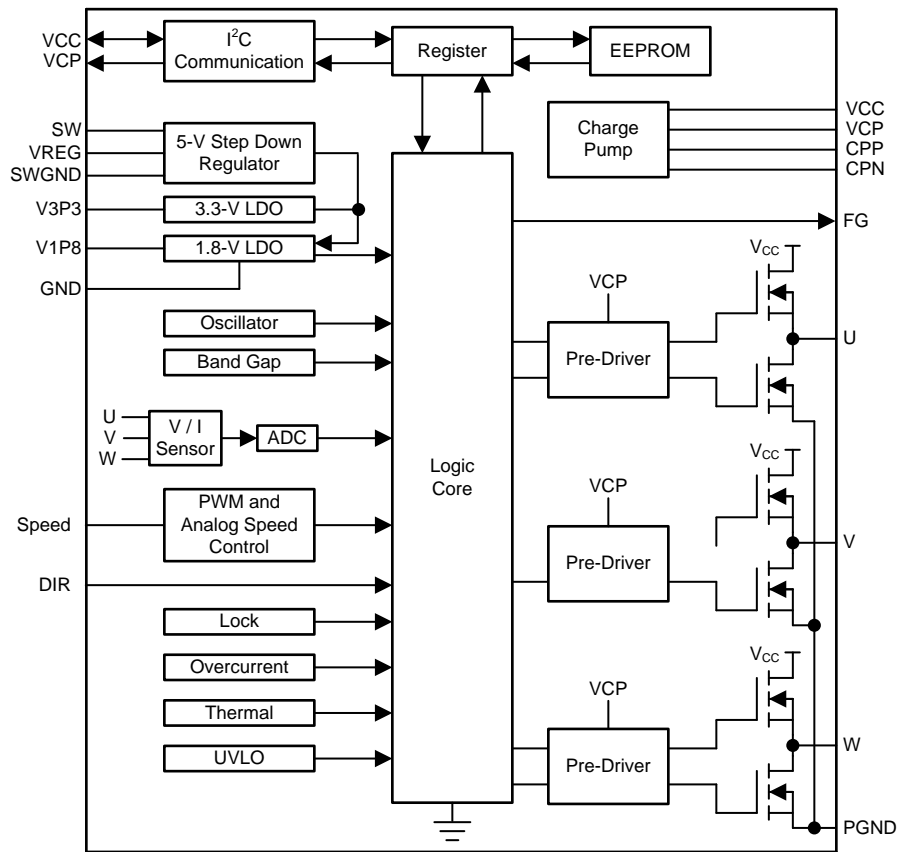
2.3.2 Closed-Loop Section

図 5 shows the closed-loop section of the reference design.

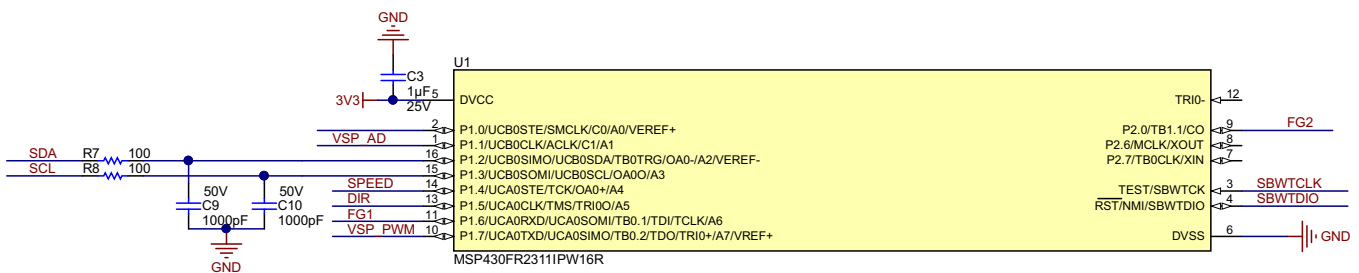

Copyright © 2018, Texas Instruments Incorporated

図 5. Closed-Loop Section

An MSP430FR2311 MCU functions as the closed loop in this reference design. The MCU accepts the external speed command, which is either analog or PWM, from the SPD pin of connector J1. The integrated buck and linear regulator of the DRV10987 device powers the MCU, eliminating the need for an additional power source (see 2.3.1). The user can obtain the actual motor speed feedback from the FG pin of J1. To achieve high-accuracy speed control, the MCU sends a PWM speed control signal to DRV10987 through pin 14 (P1.4) after calculating the closed-loop PI algorithm. Pin 13 (P1.5) has been assigned to control the spin direction of the motor, which requires the J6 connector to be open. The user can also obtain the actual speed of the motor through pin 9 (P2.0) by short-circuiting the FG and FG_MSP pins of J4.

2.3.3 PI Closed-Loop Speed Control

This reference design implements a proportional-integral (PI) control algorithm for closed-loop speed control. PI control algorithms have two basic modes: position mode and increment mode. 式 1 shows a discrete expression of the position mode of the PI algorithm:

$$\mu_k = K_p \times e_k + K_i \times \sum_{i=1}^{k-1} e_i + \mu_0 \tag{1}$$

where,

- e_k is the speed error,
- K_p is the proportional gain,

- e_k is the integration factor.

When using a position mode PI algorithm, the main issue occurs when switching between closed loop and open loop because the system creates an impulse, which results in an unstable motor. The output of position mode PI control directly relates to all past statuses. The limited precision and memory of the speed calculations in the MCU creates unavoidable accuracy errors in the full-position calculations.

For these reasons, this reference design makes use of the increment mode PI algorithm. 式 2 shows the formula. 式 3 shows the simplified formula.

$$\Delta\mu_k = \mu_k - \mu_{k-1} = K_P \times (e_k - e_{k-1}) + K_I \times e_k \tag{2}$$

$$\mu_k = \mu_{k-1} + (K_P + K_I) \times e_k - K_P \times e_{k-1} \tag{3}$$

The control increment is output and then added to the current control input. This action drives the PWM to adjust the speed of the motor. MCU implementation also becomes easier with the incremental speed control (see 図 6).



図 6. PI Closed-Loop Speed Control

2.3.4 Thermal Design

Proper thermal design is crucial for safe and reliable operation of semiconductors. Operating a semiconductor at higher operating temperatures reduces the area of safe operation and can result in failure or reduced life of the device.

The goal of the thermal design is to limit the junction temperature of the switches inside the DRV10987 device within the safe values. The data sheet specifies that the insulated-gate bipolar transistor (IGBT) has a maximum junction temperature rating of 150°C. This specification indicates that the user must design a heat dissipation area to account for this limit when operating at the full load capacity.

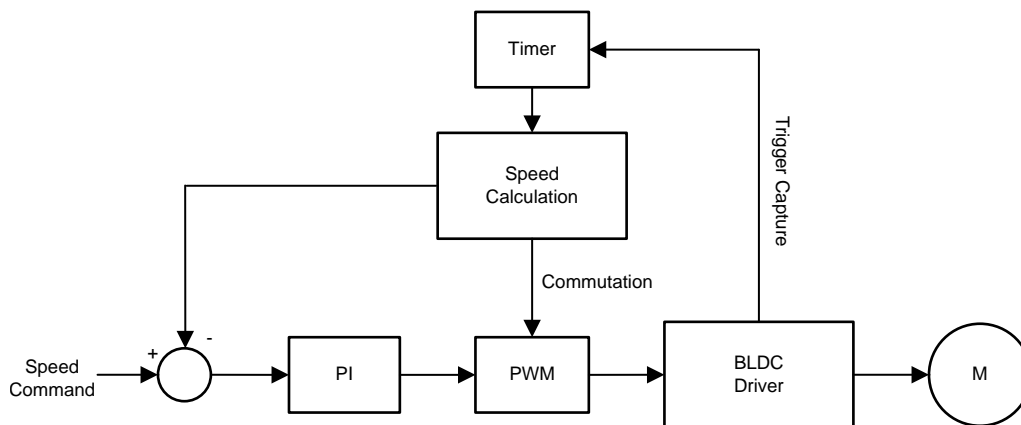
3 Hardware, Software, Testing Requirements, and Test Results

3.1 Required Hardware and Software

3.1.1 Hardware

3.1.1.1 Hardware Overview

Figure 7 shows the overview of the PCB for the TIDA-01585 design. The previous Table 2 describes the connector configuration.

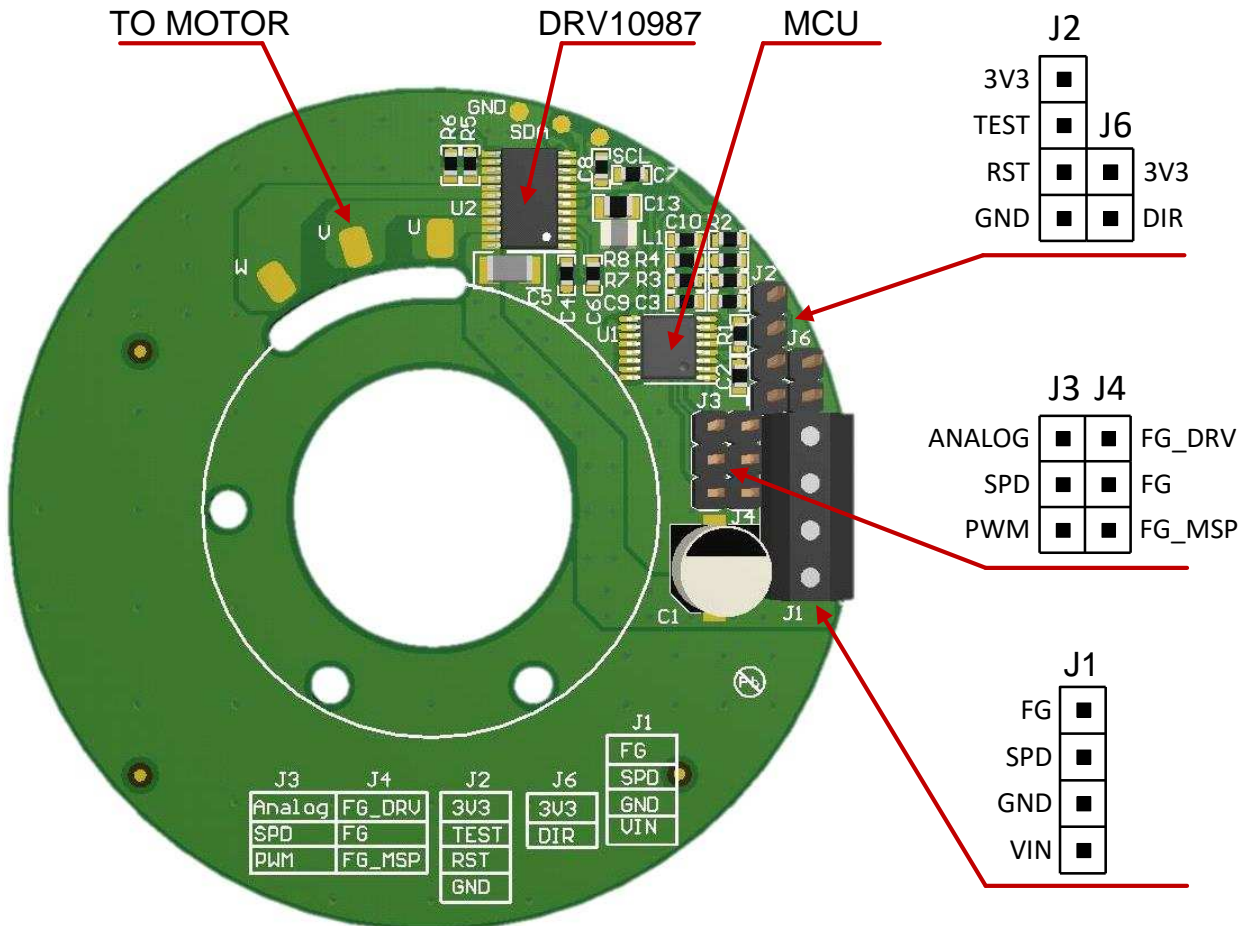

Figure 7. Hardware Overview

3.1.1.2 Programming Interface for MSP430™ MCU

J2 is reserved as the programming interface for the MCU. The designer can program the MSP430 MCU using the JTAG port, Spy-Bi-Wire (SBW), and the bootloader BSL. In this reference design, SBW has been adopted for programming and is a two-wire Spy-Bi-Wire interface. Spy-Bi-Wire can be used to interface with MSP430 development tools and device programmers. Table 3 lists the Spy-Bi-Wire interface pin requirements. For further details on interfacing to development tools and device programmers, see [MSP430 Hardware Tools User's Guide](#).

表 3. Spy-Bi-Wire Pin Requirements and Functions

J2 PIN NO.	DEVICE SIGNAL	DIRECTION	SBW FUNCTION
1	VSS	—	Ground supply
2	TEST/SBWTCK	IN	Spy-Bi-Wire clock input
3	RST/NMI/SBWDIO	IN, OUT	Spy-Bi-Wire data input and output
4	VCC	—	Power supply

3.1.2 Firmware

3.1.2.1 Application Firmware Description

The firmware of this reference design runs on MSP430FR2311, in which a PI algorithm of closed-loop speed control is implemented. The firmware also configures the DRV10987 over I²C and reads the actual speed of motor. The user must adjust the parameters of the DRV10987 device based on a specific motor by editing DRV10987.c file.

表 4 lists the system components for the firmware of this reference design.

表 4. TIDA-01585 Firmware System Components

ITEMS	DESCRIPTION
Integrated development environment (IDE)	Code Composer Studio™ (CCS) v7.4
Target MCU	MSP430FR2311
LaunchPad™ Development Kit	MSP430™ LaunchPad™
MCU - DRV10987 connection	P1.2 — SDA
	P1.3 — SCL
	P1.4 — SPEED
	P1.5 — DIR
	P1.6 — FG
MCU digital inputs and outputs	P1.1 — PIN1 J3
	P1.7 — PIN3 J3
	P2.0 — PIN3 J4

3.1.2.2 Prerequisites for Developing and Running TIDA-01585

This reference design board can work as a stand-alone board after flashing the MCU firmware and downloading it to the MSP430 MCU. To develop and debug the firmware using TI's [CCS Integrated Development Environment \(IDE\)](#), a TI [LaunchPad](#) kit is required for programming and debugging the reference board. 図 8 shows the hardware interconnections required between the design board and the LaunchPad for flashing the code in this reference design. Make sure that the jumper has been removed before connecting the LaunchPad and TIDA-01585 board.



図 8. LaunchPad™ and TIDA-01585 Board Connections Diagram

Make sure to download and install the following prerequisites to the computer:

- [Code Composer Studio™ \(CCS\) v7.4](#)
- [TIDA_01585_RevA Firmware](#)

3.1.2.3 Programming MSP430™

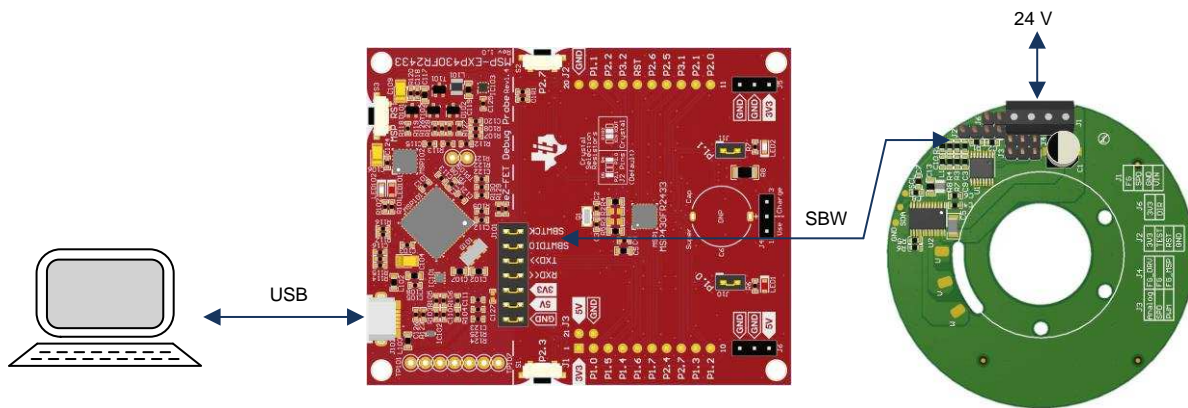
The user can edit and program the firmware of the MSP430 MCU. The instructions for programming the TIDA-01585 board are as follows:

1. Import the TIDA_01585_RevA project using TI's CCS software.
2. Connect the LaunchPad programmer to the TIDA-01585 board, as the previous 図 8 shows.
3. Build the project by clicking the *Build* button (hammer icon), which if run successfully, appears as follows in 図 9.
4. Click the *Debug* button (bug icon) as shown in 図 9.



図 9. Build and Debug Using Code Composer Studio™ From TI

3.1.2.4 Flow Chart Overview

図 10 shows the flow chart of the firmware in the MCU. TI offers a firmware example in which a PI algorithm has been implemented. The user can set and modify different PI parameters in different states to guarantee a smooth and slow start, restart, or both, while allowing a fast response between load transient or speed variation from one to another.

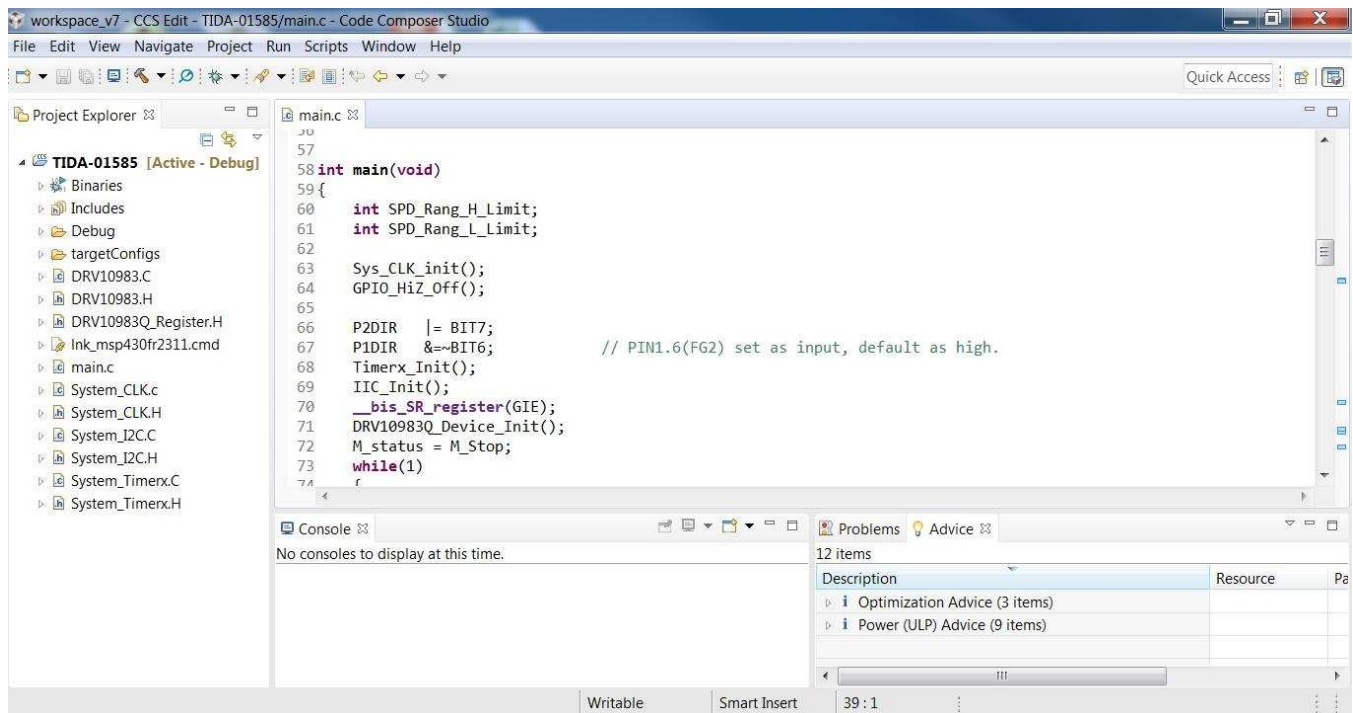

図 10. Flow Chart Overview

3.2 Testing and Results

3.2.1 Test Setup

3.2.1.1 Get Prepared

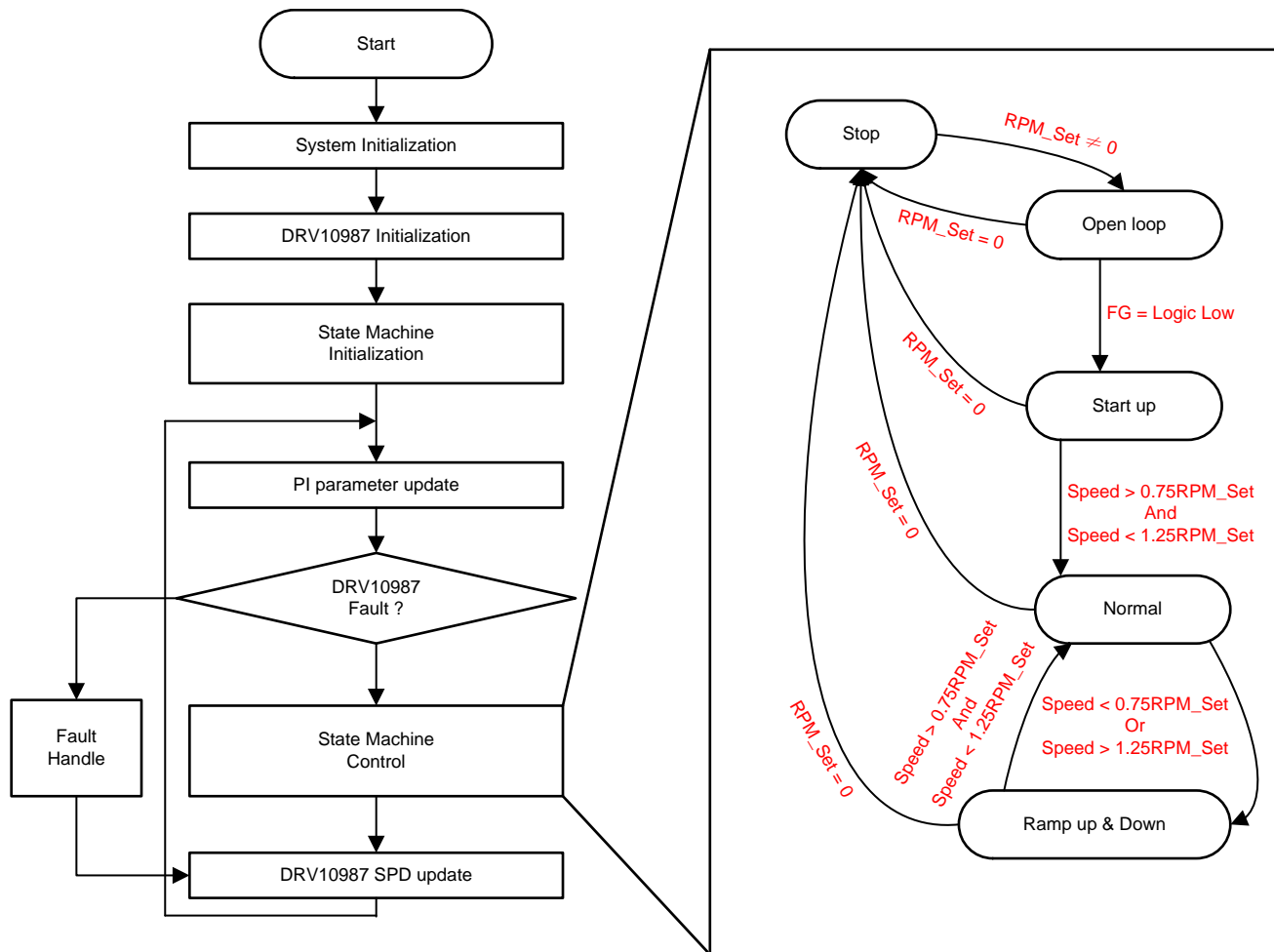
Testing the performance of the reference design board requires some materials and equipment for preparation. 表 5 lists the materials required for the test setup and their basic usage. The user can load a different motor, but must adjust the firmware before testing.

表 5. Materials for Test Setup

MATERIALS	USAGE	COMMENTS
LaunchPad™	Debug and program	MSP-EXP430FR2433 Development Kit
Computer	Debug and program	Code Composer Studio™ (CCS) v7.4 downloaded and installed
TIDA-01585 board	Main driver board	Firmware programmed
24-V BLDC motor	Main power motor	0 to 1000 RPM, $P_{MAX} > 36$ W
Fan blade	Normal load	Different sizes and pieces of blade will have different max loads
DC source	Power supply	Up to 24 V, 2 A
Signal source	Speed control input	Input signal: 5 to 20 kHz, 3.3-V logic level

3.2.1.2 Test Setup Procedure

The following steps show how to set up the test platform in the lab during the test:

1. Ensure that the firmware has been programmed into the MCU (see [3.1.2](#))
2. Connect the three-phase output U, V, and W to the motor windings.
3. Connect the DC power source to the TIDA-01585 board. Keep the power OFF.
4. Set the spin direction through the J6 pin. Short circuit or open for different direction.
5. Set the input speed control signal mode as PWM by short circuiting the SPD and PWM pins of J3. The PWM mode is the default mode in the firmware.
6. Short circuit the FG and FG_DRV pins of J4 to choose DRV10987 as the actual speed output.
7. Connect the PWM signal source to the SPD pin of J1.
8. Fix the motor and fan blade in the fixture.
9. Ensure the output voltage of the DC power source is 24 V and maximum output current is 2 A. Power on the design.

☒ 11 shows an image of the test setup in action.



図 11. Test Setup Image

3.2.2 Test Results

The test includes the start-up profile, runtime waveform, acceleration, deceleration, speed accuracy, and different protection tests.

3.2.2.1 Start-Up Profile

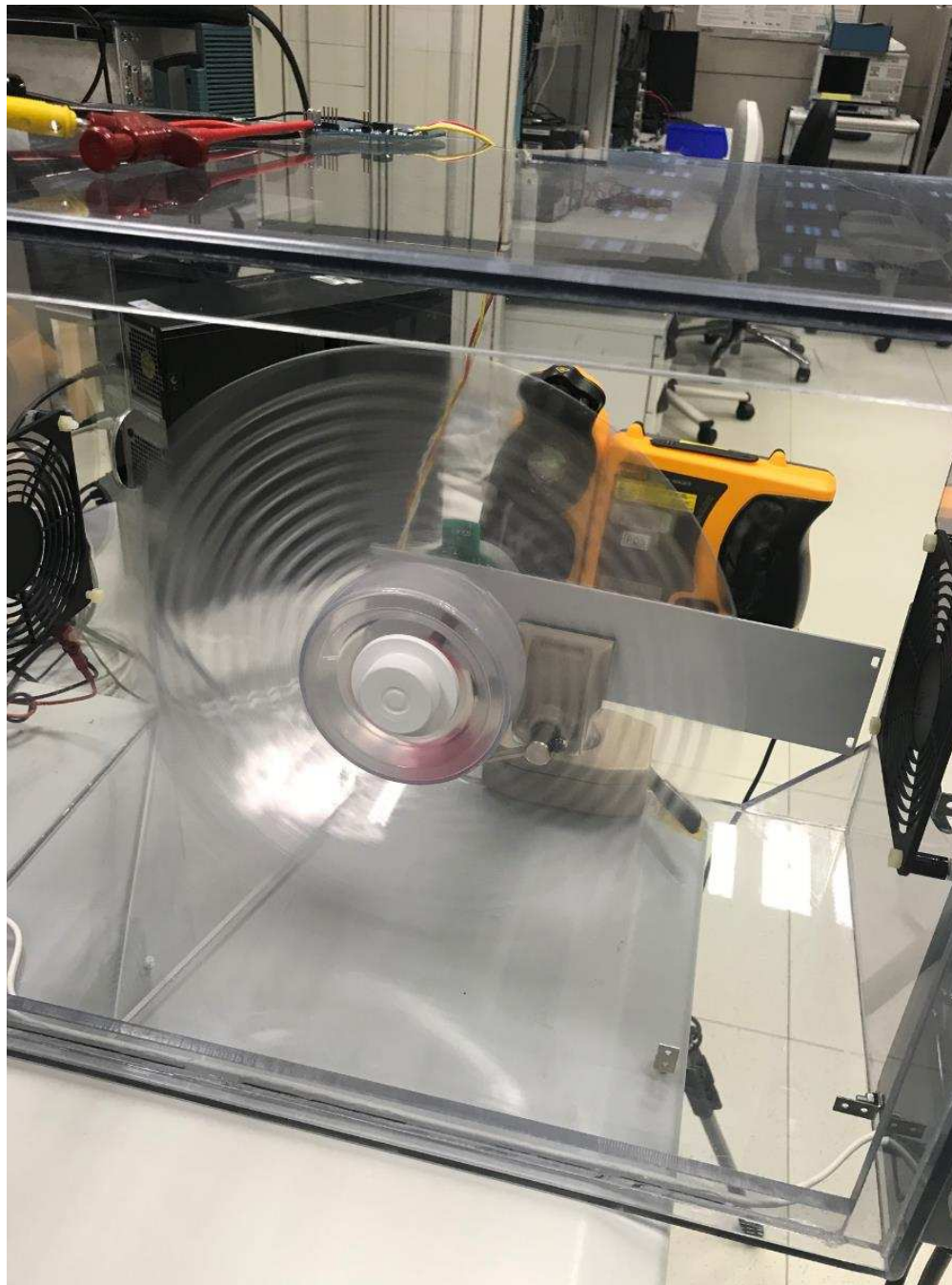
In this reference design, all the parameters for DRV10987 have been optimized based on one specified motor. These designer must modify the parameters if using a different motor. TI proposes using a [graphic user interface](#) (GUI) to optimize the parameters of the DRV10987 for a new motor. After establishing the optimized parameters through a GUI, the user must edit the DRV10987.c file to program the MCU for the new motor. The following subsections specify the configuration of parameters for the tested motor.

3.2.2.1.1 Case 1—Stationary Motor

As [Figure 12](#) shows, a small current pulse occurs at the beginning of start-up because of the Initial Position Detection (IPD) function of the DRV10987 to detect the initial rotor position. After the IPD finishes, the open-loop acceleration occurs. The speed of motor enters a closed loop control after reaching a defined threshold value through the PI control algorithm from the MCU, where the motor accelerates further.

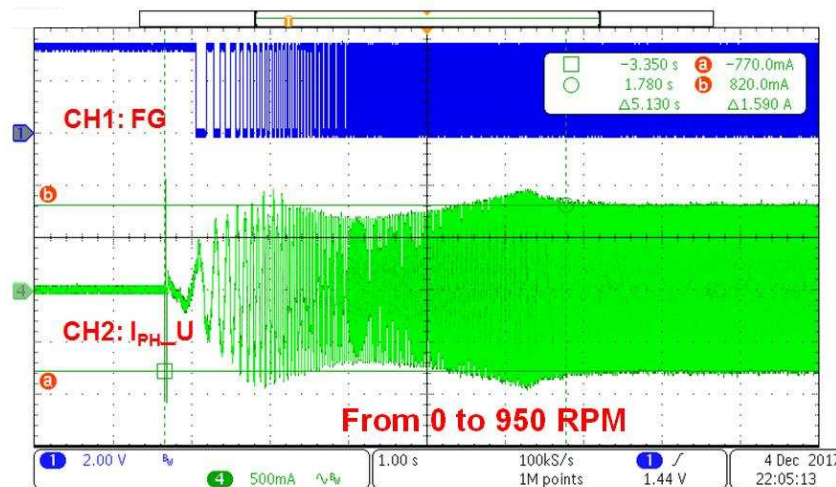

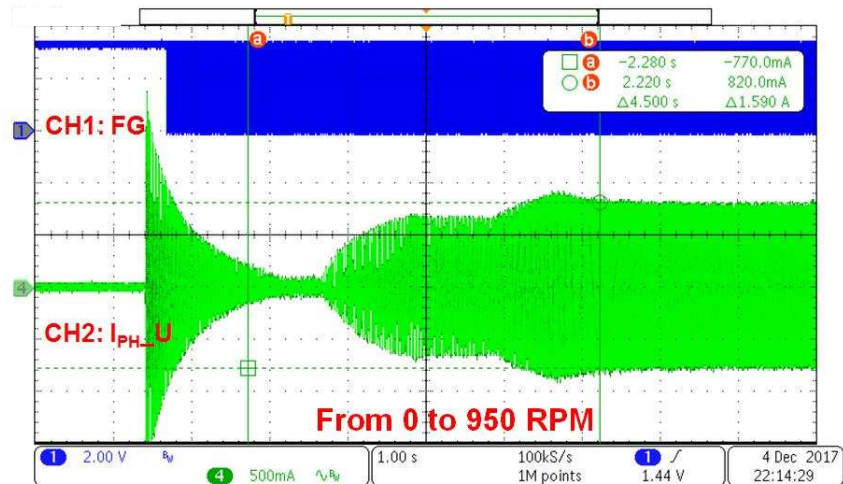

Figure 12. Start-Up: Stationary Motor

3.2.2.1.2 Case 2—Motor Spinning in Forward Direction

As  13 shows, the motor enters the open-loop acceleration directly if it is spinning in a forward direction. The motor speed enters a closed loop control after reaching a defined threshold value through the PI control algorithm from the MCU, where it accelerates further.



 13. Start-Up: Motor Spinning in Forward Direction

3.2.2.1.3 Case 3—Motor Spinning in Reverse Direction

 14 shows the start-up waveform when motor is spinning in the reverse direction. Reverse drive allows the motor to be driven so that it accelerates through zero velocity. The motor achieves the shortest possible spin-up time in systems where the motor is spinning in the reverse direction

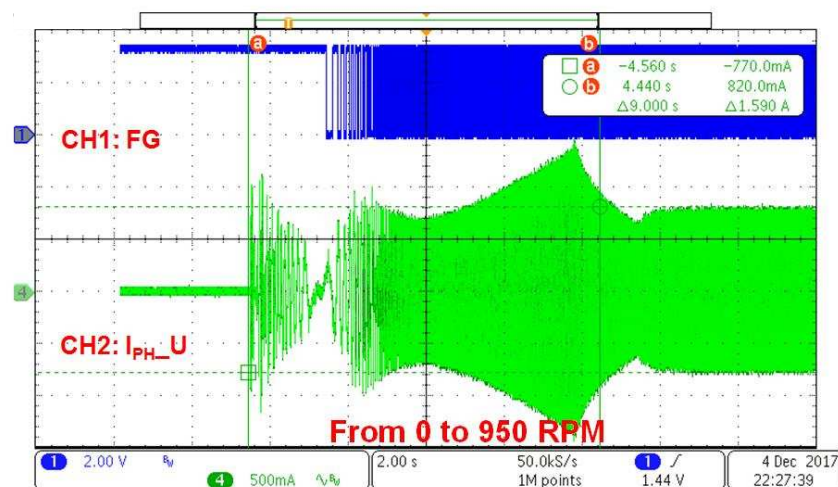

 14. Start-Up: Motor Spinning in Reverse Direction

3.2.2.2 Run Time

Figure 15 shows the winding current of the motor driven by the DRV10987 device and the winding voltage measured with respect to the negative DC bus.

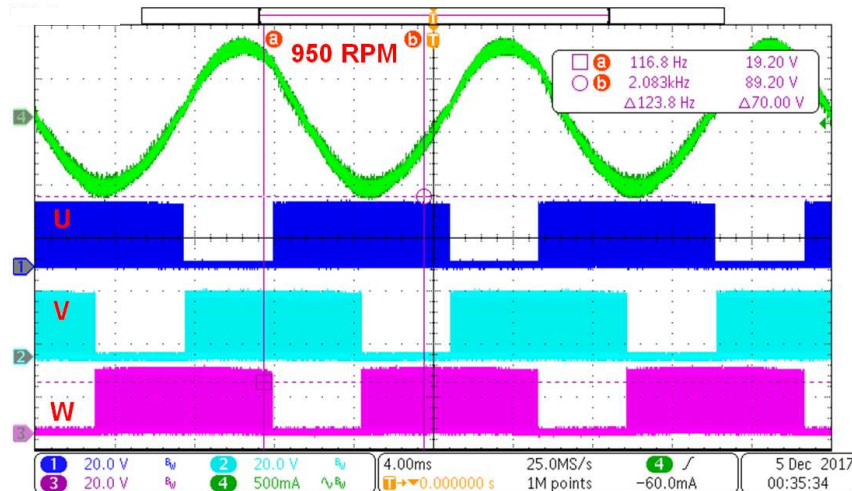

Figure 15. Run Time at 950 RPM

The speed control loop was closed by the onboard MCU at the control loop bandwidth of 20 Hz. The fan blade has a lot of inertia and requires time to settle to the target speed, which is the reason for keeping the control bandwidth very small. Maintaining a small control bandwidth ensures the minimum oscillations of rotor speed at the target point.

3.2.2.3 Acceleration

Figure 16 shows the winding current waveform as well as the three-phase output voltage with respect to the negative DC bus during the acceleration period.

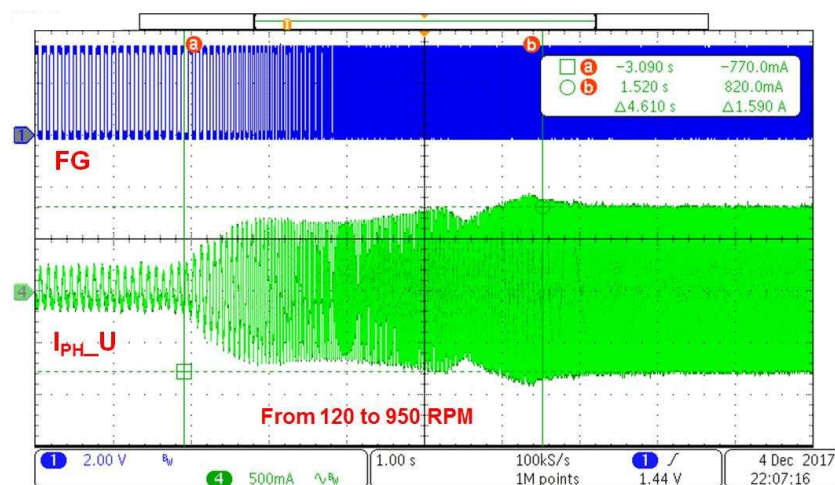

Figure 16. Acceleration

3.2.2.4 Deceleration

Figure 17 shows the winding current waveform of motor as well as the three-phase output voltage with respect to the negative DC bus during the deceleration period.

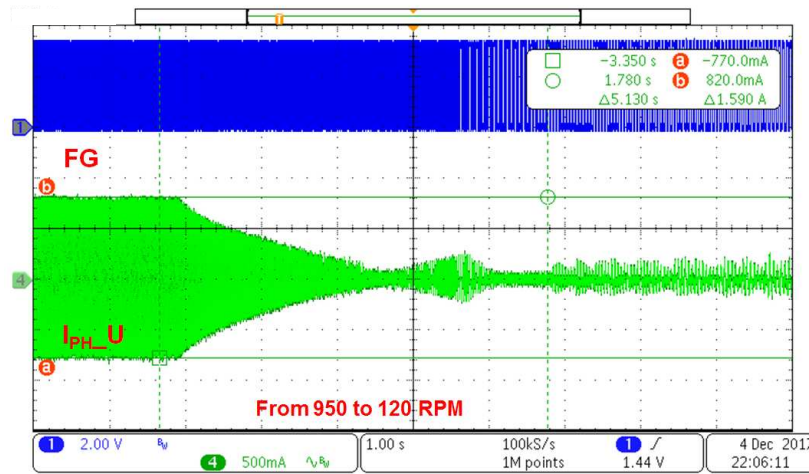

Figure 17. Deceleration

3.2.2.5 Accuracy of Speed Control

The onboard MCU MSP430FR2311 adjusts the duty cycle based on the PI control algorithm to maintain the motor speed at the desired setting. The PWM duty is modified after reading the speed from the DRV10987 device over the I²C interface. During testing, the control loop was running at 20 Hz, which is significantly slower considering the nature of the load, which takes time to settle (see Table 6).

Table 6. Accuracy of Speed Control

DUTY CYCLE	Speed_Set	Speed_Actual	GAP	ERROR%
15	150	151	1	0.67
20	200	201	1	0.50
25	250	251	1	0.40
30	300	300	0	0
35	350	350	0	0
40	400	400	0	0
45	450	449	-1	-0.22
50	500	499	-1	-0.20
55	550	548	-2	-0.36
60	600	598	-2	-0.33
65	650	648	-2	-0.31
70	700	697	-3	-0.43
75	750	747	-3	-0.40
80	800	797	-3	-0.38
85	850	846	-4	-0.47
90	900	896	-4	-0.44
95	950	946	-4	-0.42
98	980	976	-4	-0.41

3.2.2.6 Protection Test

The DRV10987 has comprehensive protection features, such as overcurrent protection (phase-to-phase, phase-to-GND, and phase-to-VCC short circuits), rotor lock detection, anti-voltage surge (AVS) protection, under-voltage lockout (UVLO), overvoltage protection, thermal warning, and shutdown.

3.2.2.6.1 Rotor Lock Test

The motor speed is set at 500 RPM.

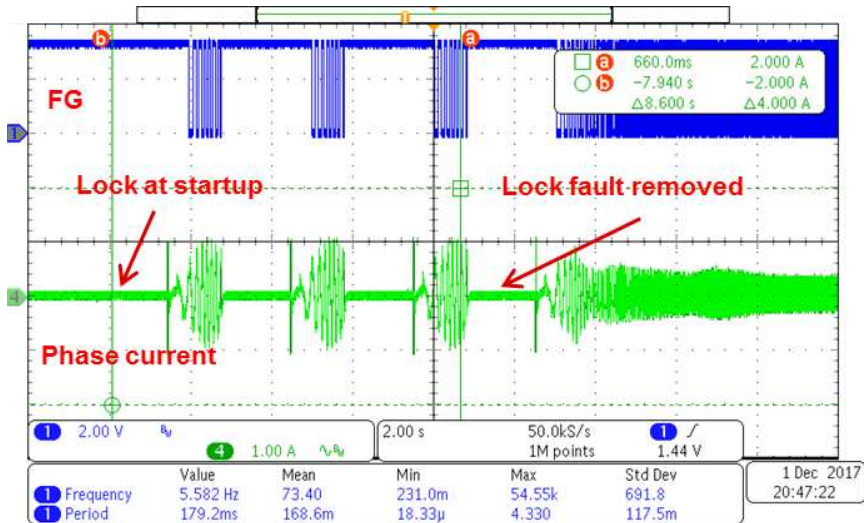
When the motor is blocked or stopped by an external force, lock protection is triggered, and the device stops driving the motor immediately.  18 shows the protection waveform of rotor lock during the start-up phase. The DRV10987 device will try to start driving the motor again every 1.7 s (the user can make this setting in the register) until the lock condition is removed.



図 18. Rotor Lock During Start-up

 19 shows the protection waveform of rotor lock during normal spinning. The phase current increases rapidly and then the protection threshold is triggered. The DRV10987 device defines it as a lock fault and stops the motor. After the lock release time t_{LOCK_OFF} , the DRV10987 device resumes driving the motor again like the start-up.

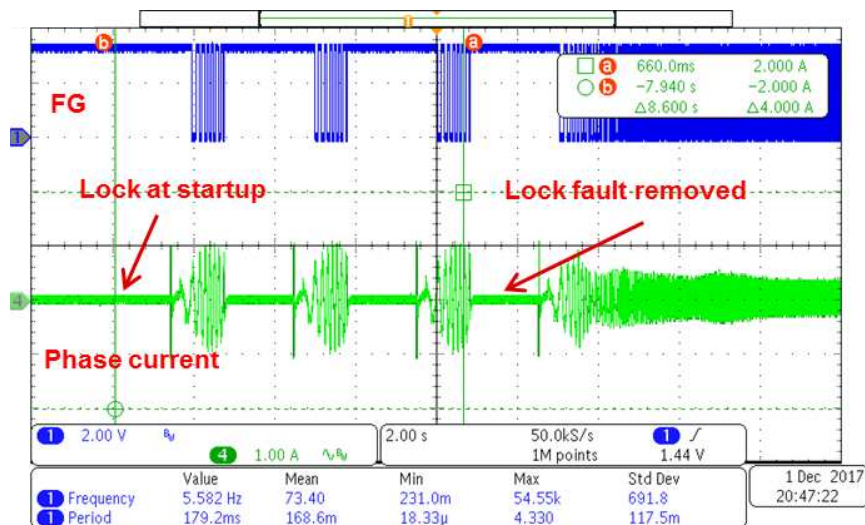
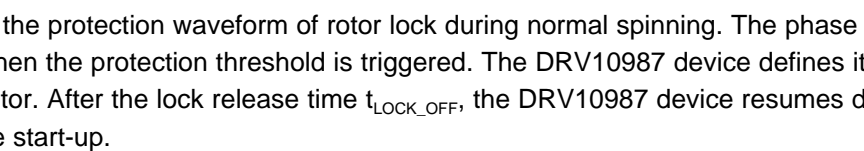

図 19. Rotor Lock While Spinning

3.2.2.7 Thermal Test

To better understand the temperature of power components and the maximum possible operating temperature, the thermal images were plotted at room temperature (25°C) with a closed enclosure, no airflow, and at different load conditions with different input voltages. The board was allowed to run for 30 minutes before capturing a thermal image.

図 20 shows the thermal image for the top side and bottom side of the board. The input voltage is 24-V DC and 1.5 A with a 36-W power output.

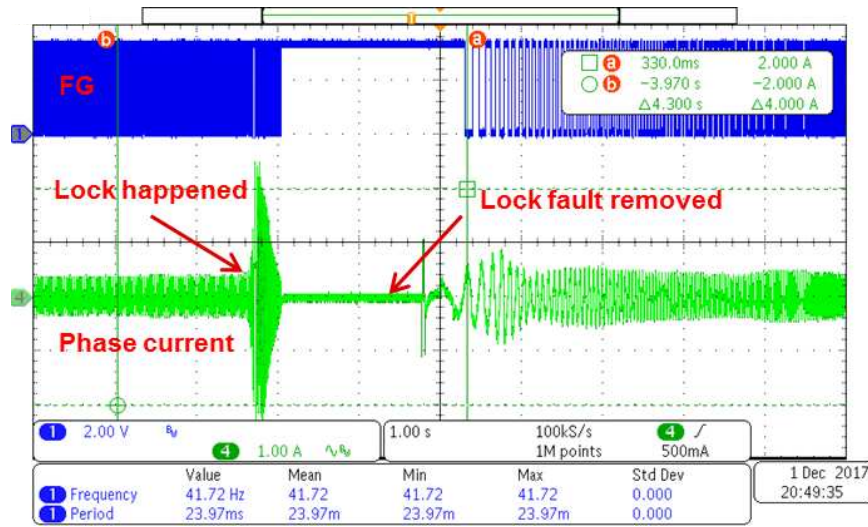

図 20. Temperatures at 24-V DC Input and 36-W Output

3.2.2.8 3.3-V Power Supply Generated by DRV10987

図 21 shows the 3.3 V generated from the DRV10987 step-down regulator. 図 22 shows the ripple in the 3.3-V rail.

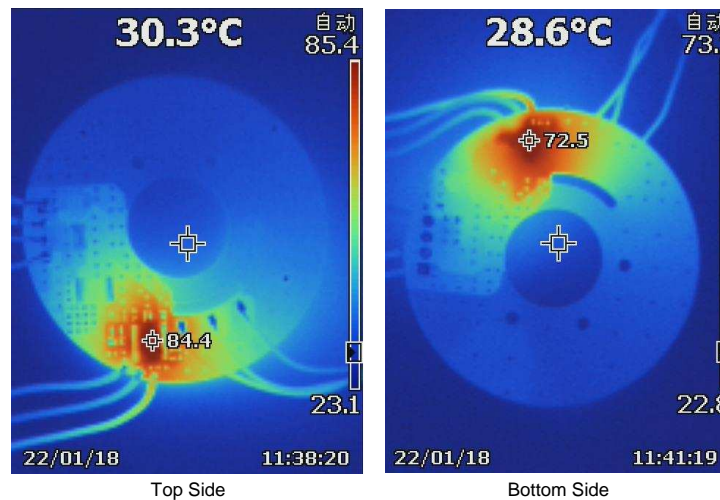

図 21. Output Voltage of 3.3 V From Step-Down Regulator of DRV10987



図 22. Ripple in 3.3-V Output From Step-Down Regulator of DRV10987

4 Design Files

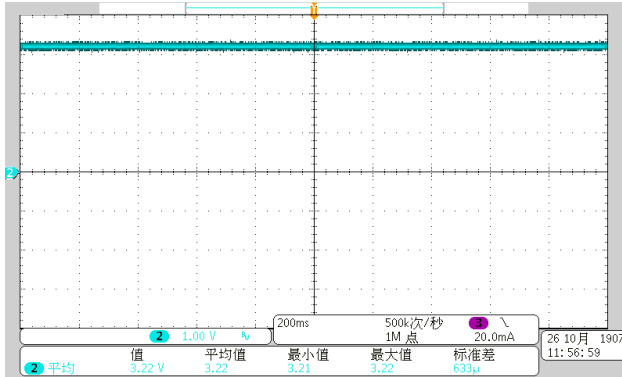
4.1 Schematics

To download the schematics, see the design files at [TIDA-01585](#).

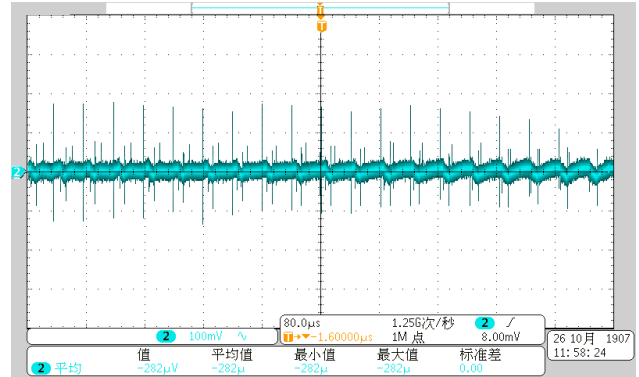
4.2 Bill of Materials

To download the bill of materials (BOM), see the design files at [TIDA-01585](#).

4.3 PCB Layout Recommendations

Use the following layout recommendations when designing the DRV10987 part of the PCB.

- Place the VCC, GND, U, V, and W pins with thick traces because high current passes through these traces.
- Place the capacitor between CPP and CPN, and as close to the CPP and CPN pins as possible.
- Place the capacitor between V1P8 and GND, and as close to the V1P8 pin as possible.
- Connect GND, PGND, and SWGND under the thermal pad.
- Keep the thermal pad connection as large as possible, on both the bottom side and top sides. The pad must be one piece of copper without any gaps.

4.3.1 Layout Prints

To download the layer plots, see the design files at [TIDA-01585](#).

4.4 Altium Project

To download the Altium project files, see the design files at [TIDA-01585](#).

4.5 Gerber Files

To download the Gerber files, see the design files at [TIDA-01585](#).

4.6 Assembly Drawings

To download the assembly drawings, see the design files at [TIDA-01585](#).

5 Software Files

To download the software files, see the design files at [TIDA-01585](#).

6 Related Documentation

1. Texas Instruments, [MSP430™ Hardware Tools User's Guide](#)
2. Texas Instruments, [DRV10987 12- to 24-V, Three-Phase, Sensorless BLDC Motor Driver](#)
3. Texas Instruments, [MSP430FR231x Mixed-Signal Microcontrollers](#)
4. Texas Instruments, [DRV10987 Tuning Guide](#)
5. Texas Instruments, [Integrated 30-W Sensorless BLDC Motor Drive Retrofit Reference Design With 90- to 265-V AC Input](#)

6.1 商標

E2E, MSP430, LaunchPad, Code Composer Studio are trademarks of Texas Instruments.
すべての商標および登録商標はそれぞれの所有者に帰属します。

7 Terminology

- AVS**— Anti-voltage surge
- BLDC**— Brushless DC (motor)
- BSL**— Bootloader
- CCS**— Code Composer Studio
- CPU**— Central processing unit
- ESD**— Electrostatic discharge
- FET**— Field-effect transistor
- FRAM**— Ferroelectric random-access memory
- IDE**— Integrated development environment
- IGBT**— Insulated gate bipolar transistor
- MCU**— Microcontroller unit
- MOSFET**— Metal–oxide–semiconductor field-effect transistor
- PI**— Proportional integral
- PWM**— Pulse width modulation
- RISC**— Reduced instruction set computing
- RMS**— Root mean square
- RPM**— Rotation per minute
- SBW**— Spy-Bi-Wire
- SFF**— Small form factor
- SPI**— Serial peripheral interface
- SRAM**— Static random-access memory
- UVLO**— Undervoltage lockout

8 About the Author

YICHANG (RICHARD) WANG is a systems architect at Texas Instruments, where he is responsible for developing reference design solutions for the industrial segment. Richard brings to this role his extensive experience in home appliances, including power electronics, high-frequency DC-DC, AC-DC converters, analog circuit design, and so forth. Richard got his master's degree in electrical engineering and automation from Nanjing University of Aeronautics and Astronautics, China.

KIM YANG is a Field Applications Engineer at Texas Instruments, where he is responsible for supporting analog solution design for industrial customer and home appliances application. Kim's extensive experience in home appliances is including industrial interface, DC/DC, AC/DC converter, signal chain and so forth. Kim got his Bachelors and master's degree in power electronics and power drives from Wuhan University of Technology, China.

TIの設計情報およびリソースに関する重要な注意事項

Texas Instruments Incorporated ("TI")の技術、アプリケーションその他設計に関する助言、サービスまたは情報は、TI製品を組み込んだアプリケーションを開発する設計者に役立つことを目的として提供するものです。これにはリファレンス設計や、評価モジュールに関係する資料が含まれますが、これらに限られません。以下、これらを総称して「TIリソース」と呼びます。いかなる方法であっても、TIリソースのいずれかをダウンロード、アクセス、または使用した場合、お客様(個人、または会社を代表している場合にはお客様の会社)は、これらのリソースをここに記載された目的にのみ使用し、この注意事項の条項に従うことに合意したものとします。

TIによるTIリソースの提供は、TI製品に対する該当の発行済み保証事項または免責事項を拡張またはいかなる形でも変更するものではなく、これらのTIリソースを提供することによって、TIにはいかなる追加義務も責任も発生しないものとします。TIは、自社のTIリソースに訂正、拡張、改良、およびその他の変更を加える権利を留保します。

お客様は、自らのアプリケーションの設計において、ご自身が独自に分析、評価、判断を行う責任がお客様にあり、お客様のアプリケーション(および、お客様のアプリケーションに使用されるすべてのTI製品)の安全性、および該当するすべての規制、法、その他適用される要件への遵守を保証するすべての責任をお客様のみが負うことを理解し、合意するものとします。お客様は、自身のアプリケーションに関して、(1) 故障による危険な結果を予測し、(2) 障害とその結果を監視し、および、(3) 損害を引き起こす障害の可能性を減らし、適切な対策を行う目的での、安全策を開発し実装するために必要な、すべての技術を保持していることを表明するものとします。お客様は、TI製品を含むアプリケーションを使用または配布する前に、それらのアプリケーション、およびアプリケーションに使用されているTI製品の機能性を完全にテストすることに合意するものとします。TIは、特定のTIリソース用に発行されたドキュメントで明示的に記載されているもの以外のテストを実行していません。

お客様は、個別のTIリソースにつき、当該TIリソースに記載されているTI製品を含むアプリケーションの開発に関連する目的でのみ、使用、コピー、変更することが許可されています。明示的または黙示的を問わず、禁反言の法理その他どのような理由でも、他のTIの知的所有権に対するその他のライセンスは付与されません。また、TIまたは他のいかなる第三者のテクノロジーまたは知的所有権についても、いかなるライセンスも付与されるものではありません。付与されないものには、TI製品またはサービスが使用される組み合わせ、機械、プロセスに関連する特許権、著作権、回路配置利用権、その他の知的所有権が含まれますが、これらに限られません。第三者の製品やサービスに関する、またはそれらを参照する情報は、そのような製品またはサービスを利用するライセンスを構成するものではなく、それらに対する保証または推奨を意味するものでもありません。TIリソースを使用するため、第三者の特許または他の知的所有権に基づく第三者からのライセンス、もしくは、TIの特許または他の知的所有権に基づくTIからのライセンスが必要な場合があります。

TIのリソースは、それに含まれるあらゆる欠陥も含めて、「現状のまま」提供されます。TIは、TIリソースまたはその仕様に関して、明示的か暗黙的にかかわらず、他のいかなる保証または表明も行いません。これには、正確性または完全性、権原、続発性の障害に関する保証、および商品性、特定目的への適合性、第三者の知的所有権の非侵害に対する黙示的保証が含まれますが、これらに限られません。

TIは、いかなる苦情に対しても、お客様への弁済または補償を行う義務はなく、行わないものとします。これには、任意の製品の組み合わせに関連する、またはそれらに基づく侵害の請求も含まれますが、これらに限られず、またその事実についてTIリソースまたは他の場所に記載されているか否かを問わないものとします。いかなる場合も、TIリソースまたはその使用に関連して、またはそれらにより発生した、実際の、直接的、特別、付随的、間接的、懲罰的、偶発的、または、結果的な損害について、そのような損害の可能性についてTIが知らされていたかどうかにかかわらず、TIは責任を負わないものとします。

お客様は、この注意事項の条件および条項に従わなかったために発生した、いかなる損害、コスト、損失、責任からも、TIおよびその代表者を完全に免責するものとします。

この注意事項はTIリソースに適用されます。特定の種類の資料、TI製品、およびサービスの使用および購入については、追加条項が適用されます。これには、半導体製品(<http://www.ti.com/sc/docs/stdterms.htm>)、評価モジュール、およびサンプル(<http://www.ti.com/sc/docs/sampterm.htm>)についてのTIの標準条項が含まれますが、これらに限られません。