

TI Designs: TIDA-01635

90Hzリフレッシュ・レートの仮想/拡張現実ディスプレイ用のバックライトとLCDバイアスのリファレンス・デザイン



概要

このリファレンス・デザインでは、ウェアラブル・デバイス、特に拡張現実(AR)および仮想現実(VR)ヘッドセットで使用するLCDディスプレイ用の電源ソリューションについて説明します。LP8556は、リフレッシュ・レートと同期して、小さなデューティ・サイクルの大電流を供給でき、電流の精度の高いバックライト・ドライバを実現できます。LCDのバイアス電力ドライバは、使いやすくパッケージの小さいTPS65132によって提供されます。詳細な設計理論、部品の選択、テスト結果についても解説します。

リソース

TIDA-01635	デザイン・フォルダ
LP8556	プロダクト・フォルダ
TPS65132	プロダクト・フォルダ
TPS61089	プロダクト・フォルダ
TPS563201	プロダクト・フォルダ

特長

- 90Hzのストロープ・バックライト
- 6チャンネルで50mAをサポート
- 10%デューティ・サイクル・モードでのバックライト点灯
- 1つのリチウムイオン・バッテリー入力、または12Vのアダプタ入力に対応

アプリケーション

- 仮想現実および拡張現実用のヘッドセットおよび眼鏡
- ハンドセット: スマートフォン
- STBおよびDVR



E2E™ エキスパートに質問

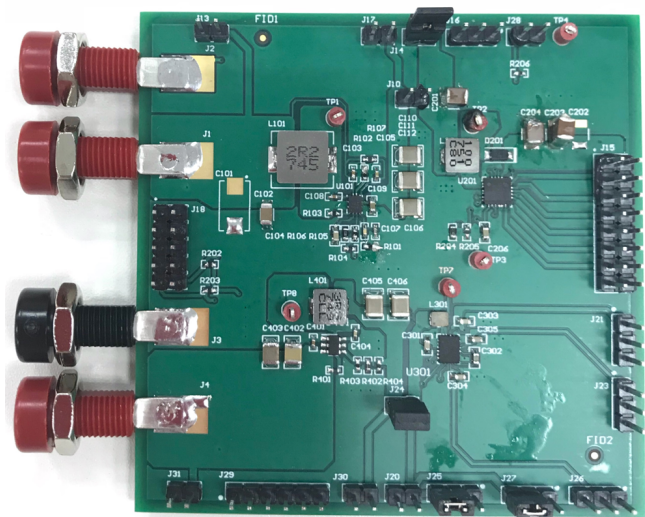
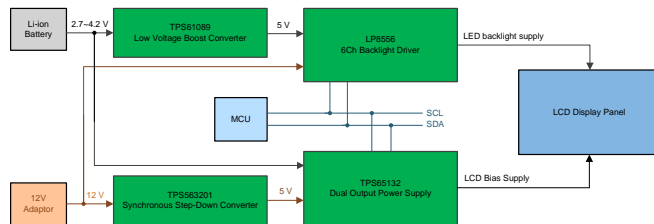

使用許可、知的財産、その他免責事項は、最終ページにあるIMPORTANT NOTICE (重要な注意事項)をご参照ください。よろしくお願いいたします。

1 System Description

Virtual reality (VR) and augmented reality (AR) are hot new things in technology at the moment. VR/AR headsets or glasses are essential equipment that require a high refresh rate to provide good experience. This reference design describes the high current accuracy backlight and LCD bias solution for 90-Hz refresh-rate AR/VR displays.

1.1 Key System Specifications

表 1. Key System Specifications

PARAMETER	SPECIFICATIONS
V _{IN} range	One Li-ion battery input or 12-V adaptor
LED configuration	8 LEDs in series x 2 strings
High LED current	Maximum 95 mA per string x 2 strings
High current accuracy	1% accuracy and 0.5% mismatching
Dimming control	PWM dimming frequency 90 Hz, 10% duty cycle

2 System Overview

2.1 Block Diagram

図 1. TIDA-01635 Block Diagram

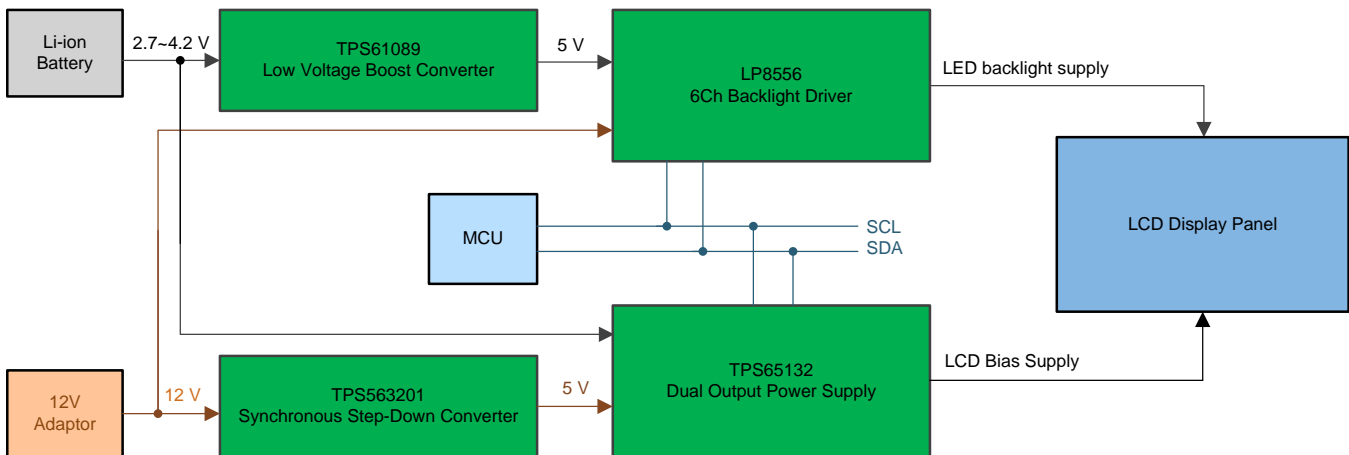

2.2 Design Considerations

In this reference design, a 6-channel, maximum 50 mA per channel LED backlight driver (LP8556) is used to drive 2 strings of 8-pcs LEDs with constant a 90-Hz, 10% duty strobe light. It supports an I²C interface to online configure the device to achieve various output settings. The TPS65132 device is used as the LCD bias power supply. TPS61089 and TPS563201 are boost and buck converters, respectively, which provide proper input voltage for the backlight and bias drivers.

2.3 Highlighted Products

Key features of the devices used in this reference design are described in the following descriptions. For complete details, see the device product folders ([LP8556](#), [TPS65132](#), [TPS61089](#), and [TPS563201](#)).

2.3.1 LP8556

The LP8556 is a 6-channel WLED backlight driver with wide VDD input voltage of 2.7 V to 20 V. 7-V to 43-V boost switch output-voltage range supports as few as 3 WLEDs in series per channel and as many as 12. The configurable channel count (1 to 6) supports 50 mA per channel. The boost converter uses adaptive output voltage control for setting the optimal LED driver voltages, minimizing power consumption by adjusting the output voltage to lowest sufficient level under all conditions. Output resolution can be set up to 15 bits for smoother and pleasant brightness changes. Programmable slew rate control and spread spectrum scheme minimize switching noise and improve EMI performance. In addition, phase shifted LED PWM dimming allows reduced audible noise and smaller boost output capacitors. The LP8556 has a comprehensive set of safety features that ensure robust operation of the device and external components.

2.3.2 TPS65132

The TPS65132 family is designed to supply positive/negative driven applications. The device uses a single inductor scheme for both outputs to provide the user smallest solution size, a small bill-of-material as well as high efficiency. The devices offer best line and load regulation at low noise. With its input voltage range of 2.5 V to 5.5 V, it is optimized for products powered by single-cell batteries (Li-Ion, Ni-Li, Li-Polymer) and fixed 3.3-V and 5-V rails. The TPS65132 family provides 80 mA and 150 mA output current options with programmability to 40 mA. There are both CSP and QFN package options available.

2.3.3 TPS61089

The TPS61089 is a fully-integrated synchronous boost converter with a 19-m Ω main power switch and a 27-m Ω rectifier switch. The device provides a high efficiency and small size power solution for portable equipment. The TPS61089 features wide input voltage range from 2.7 V to 12 V to support applications powered with single cell or two cell lithium-ion/polymer batteries. The TPS61089 has 7-A continuous switch current capability and provides output voltage up to 12.6 V.

2.3.4 TPS563201

The TPS563201 is a simple, easy-to-use, 3-A synchronous step-down converter in SOT-23 package. The device is optimized to operate with minimum external component counts and also optimized to achieve low standby current. TPS563201 operates in pulse-skip mode, which maintains high efficiency during light load operation.

2.4 System Design Theory

This reference design uses one LP8556 as backlight converter to control 2 strings of LEDs. The design offers a strobe light with 10% duty at 90 Hz. In VR headset glasses, each string gives backlight to display of each eye. A TPS65132 is used to drive LCD bias. The other TPS61089 and TPS563201 converter input voltage to regulated 5 V. Either the lithium-ion battery input or 12-V adaptor input could be provided both together.

図 2. TIDA-01635 Schematic

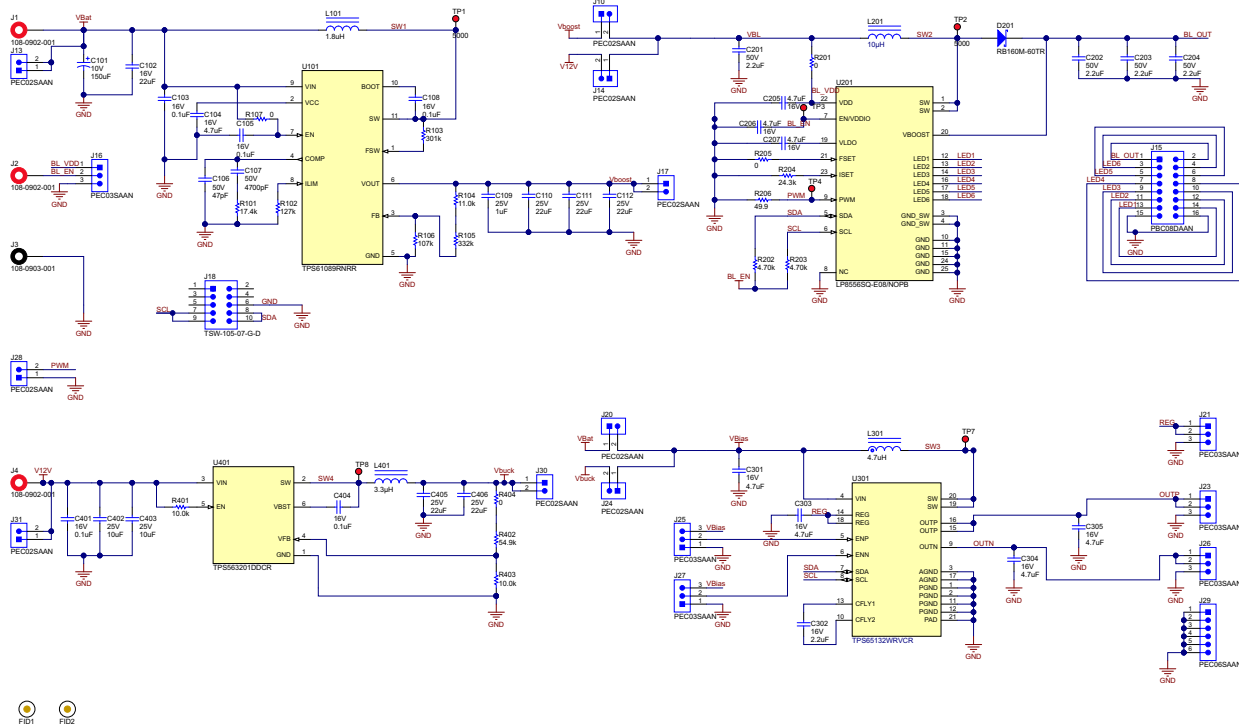

2.4.1 Backlight Driver Design

Requirements for the backlight driver:

表 2. Design Parameters

SPECIFICATION	VALUE
Input voltage (V_{IN})	5 V
Output current (I_{LED})	95 mA per string
Output LED configure	8 LEDs × 2 strings
LED maximum forward voltage (V_f)	3.5 V
Schottky diode forward voltage (V_d)	0.49 V

2.4.1.1 Boost Inductor Selection

After considering efficiency, inductor ripple current, and component form factor, a 10- μ H inductor was chosen, and the driver is operating at 1250 kHz. The inductor peak-to-peak current can be calculated by 式 1:

$$I_{pp} = \frac{1}{L \times F_s \times \left(\frac{1}{V_{out} + V_F - V_m} + \frac{1}{V_m} \right)}$$

where

- $V_{IN} = 5$ V
- $L = 10$ μ H
- $f_{SW} = 1250$ kHz
- 8 LEDs output with V_{OUT} of 28 V
- $V_F = 0.49$ V

(1)

The peak-to-peak current is 0.33 A, and the average input current is 1.08 A. The boost inductor then has a peak current 1.41 A. The LP8556 device current limit register is chosen maximum 2.8 A to leave some margin and allow output capacitors to charge up quickly. The inductor must have a higher saturation current than the LP8556 current to prevent current increasing suddenly due to inductor saturation.

2.4.1.2 Output Capacitor Selection

Select the output capacitor to meet requirements for output voltage ripple and loop stability of the whole system. The output capacitor can be calculated by 式 2:

$$C_{out} = \frac{I_{out} \times (V_{out} - V_m)}{F_s \times V_{out} \times \Delta V_{out}}$$

where

- ΔV_{OUT} is the output ripple voltage
- I_{OUT} is the total LED current, 190 mA

(2)

Take care when evaluating the capacitance under DC bias. The DC bias can reduce the capacitance significantly so that the remaining valid capacitance is smaller than rated value.

2.4.1.3 Register Settings

The LP8556 device is available in two packages: DSBGA and QFN. TI recommends the QFN package for its thermal dissipation and large current capability, and it is the package used in this reference design. Additionally, LP8556 has various EPROM versions to differentiate configurations with many features. E09 version is selected in this reference design because it is allowed to use all of the 6 channels at first place. Actually, if I2C bus is available in the system, EPROMs can be rewritten all the time on line.

A few settings to consider:

1. Both large current limit range and large output voltage range are selected.
2. 95 mA is spread in 3 channels, so each channel outputs approximately 32 mA. The maximum current bits choose 50 mA and adjust the 12 bits in A0h and A1h registers to get 32 mA.
3. Output strobe current follows input the PWM signal, which is 90 Hz and 10% duty. The LP8556 device is set to direct PWM dimming mode by simply connecting PWM pin to ground.

Recommended register settings used in this reference design are shown in 表 3.

表 3. LP8556 Register Settings

ADDRESS	VALUE
98H	0x98[7]=1b
9EH	0x22
A0H	0x21
A1H	0xFA
A2H	0x29
A3H	0x02
A4H	0x72
A5H	0xF4
A6H	0x80
A7H	0xFE
A8H	0x04
A9H	0xE0
AAH	0x0F
ABH	0x00
ACH	0x00
ADH	0x00
AEH	0x0E

2.4.2 Boost Converter Design

Requirements for the boost converter:

表 4. Design Parameters

SPECIFICATION	VALUE
Minimum input voltage	2.7 V
Output current	2 A
Output voltage	5 V

2.4.2.1 Boost Inductor Selection

The inductance is primarily selected by output power and ripple current. Generally, the inductor ripple current is 20% of its average current, and the inductor value can be derived by 式 3:

$$L_{boost} = \frac{1}{I_{in} \times 0.2 \times f_{SW} \times \left(\frac{1}{V_{out} - V_{in}} + \frac{1}{V_{in}} \right)}$$

where

- f_{SW} is the switching frequency 500 kHz
 - $V_{OUT} = 5$ V,
 - $V_{IN} = 2.7$ V,
- (3)

I_{IN} is the average input current, which is calculated in 式 4, taking η 0.75 as the efficiency

$$I_{in} = \frac{V_{out} \times I_{out}}{\eta \times V_{in}}$$
(4)

With equation 式 3 and 式 4, use an inductor value of 2.2 μ H to calculate the peak-to-peak current in inductor:

$$I_{pp} = \frac{1}{L \times f_{sw} \times \left(\frac{1}{V_{out} - V_{in}} + \frac{1}{V_{in}} \right)}$$
(5)

Thus, the peak inductor current is $I_{IN} + 0.5 \times I_{PP}$, which is 5.5 A.

2.4.2.2 Output Capacitor Selection

Similar to 2.4.1.2, the boost output capacitor is selected by considering the output voltage ripple. Three 22- μ F ceramic capacitors are used in this reference design to provide steady output voltage for backlight driver input.

2.4.2.3 Compensation Design

The COMP pin is the output of the internal trans-conductance error amplifier. Use 式 6 and 式 7 to calculate R101 and C107 in 図 1:

$$R_{101} = \frac{2\pi \times V_{out} \times R_{sense} \times f_c \times C_{out}}{(1-D) \times V_{ref} \times G_{EA}}$$
(6)

$$C_{107} = \frac{R_{out} \times C_{out}}{2 \times R_{101}}$$

where

- R_{SENSE} is the equivalent internal current sense resistor (0.08 Ω)
 - D is the duty cycle by $(V_{OUT} - V_{IN}) / V_{OUT}$
 - C_{OUT} = output capacitor
 - G_{EA} is the error amplifier's trans-conductance ($G_{EA} = 190 \mu$ A/V)
- (7)

The value of C106 can be calculated by 式 8:

$$C_{106} = \frac{R_{ESR} \times C_{out}}{R_{101}} \quad (8)$$

As the output capacitor is the ceramic capacitor, the ESR is relatively small, so that C106 is very small. In this reference design, a 47-pF capacitor is used to filter the noise on COMP pin.

2.4.3 Buck Converter Design

Requirements for the buck converter as shown in 表 5:

表 5. Design Parameters

SPECIFICATION	VALUE
Input voltage	12 V
Output current	1 A
Output voltage	5 V

2.4.3.1 Output Filter Selection

Design the output LC filter of buck converter to achieve a robust system. Choose the inductor and capacitor of the LC filter according to 表 2 in the TPS563201 data sheet.

The peak-to-peak current in filter inductor can be calculated by 式 9:

$$I_{pp} = \frac{V_{out}}{V_{in}} \times \frac{V_{in} - V_{out}}{L_{buck} \times f_{sw}}$$

where

- $V_{IN} = 12 \text{ V}$
 - $V_{OUT} = 5 \text{ V}$
 - $f_{SW} = 580 \text{ kHz}$
 - $L_{BUCK} = 3.3 \text{ } \mu\text{H}$
- (9)

The output peak current in inductor is:

$$I_{peak} = I_{out} + \frac{I_{pp}}{2}$$
(10)

式 10 yields a 1.8-A peak current.

The RMS current is:

$$I_{rms} = \sqrt{I_{out}^2 + \frac{1}{12} I_{pp}^2}$$
(11)

式 11 yields 1.1 A.

3 Hardware, Software, Testing Requirements, and Test Results

3.1 Required Hardware and Software

3.1.1 Hardware

This reference design is applicable to either a lithium-ion battery or a 12-V adaptor. In the test, a DC power supply is used to provide power supply. Take care that only one supply input is connected once. The battery and adaptor cannot be connected together.

As for the load of this reference design, a LED load board is used for LP8556 output, and 2 resistors are used as the load of TPS65132.

3.1.2 Software

The [LP8556 GUI](#) and [TPS65132 GUI](#) can be downloaded for use with this reference design.

3.2 Testing and Results

3.2.1 Test Setup

This reference design can be applied to two kinds of input voltage source. One is single cell lithium-ion battery, connecting to J1 and J3 (GND); the other is 12-V adaptor, connecting to J4 and J3 (GND). *Take care that J1 and J4 are not connected at the same time.*

A six strings of eight LEDs in series are loaded by the backlight driver LP8556 and connected to J15. To configure LP8556 with required LED current and settings, USB2ANY is connecting to J18 to communicate between GUI and device.

3.2.2 Test Results

3.2.2.1 Battery Input

With a battery voltage source input, TPS61089 and LP8556 operate to drive the backlight LEDs. TPS65132 is powered by a battery directly to drive the bias. A power source with 3.7 V is used to simulate battery voltage. [Figure 3](#), [Figure 4](#), [Figure 5](#), [Figure 6](#), [Figure 7](#), and [Figure 8](#) show the operations waveforms.

図 3. TIDA-01635 Boost Waveforms



CH1: input voltage
CH2: TPS61089 output 5 V

CH3: TPS61089 switching waveform
CH4: LP8556 output current

図 4. TIDA-01635 Boost Waveforms (Zoomed In)

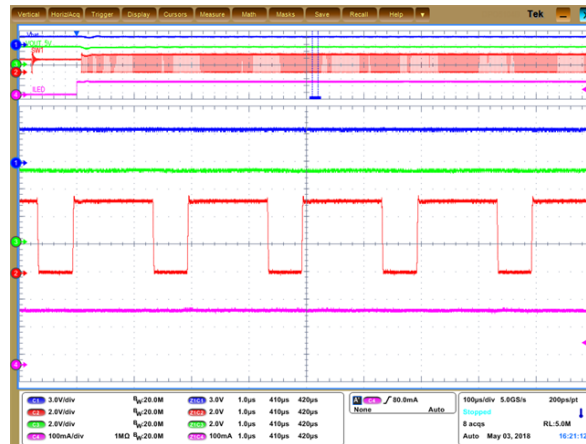

CH1: input voltage
CH2: TPS61089 output 5 V

CH3: TPS61089 switching waveform
CH4: LP8556 output current

図 5. TIDA-01635 LP8556 Backlight Driver Waveforms

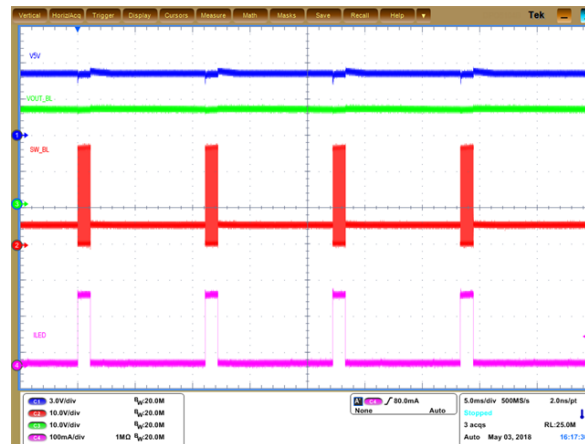

CH1 TPS61089 output 5 V
CH2: LP8556 backlight output voltage

CH3: LP8556 backlight switching waveform
LP8556 output current

図 6. TIDA-01635 Voltage-Ripple Waveforms

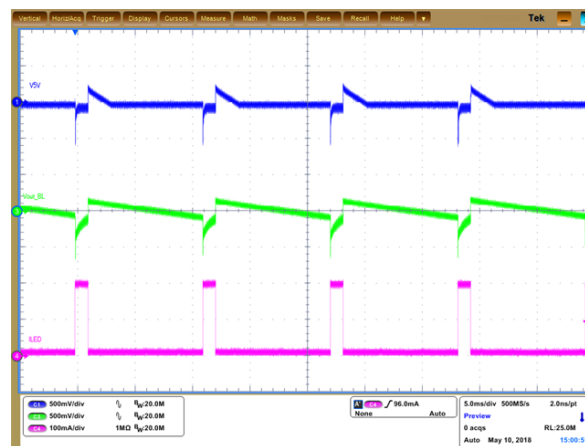

CH1 TPS61089 output 5 V
CH4: LP8556 output current

CH3: LP8556 backlight output voltage

7. Voltage-Ripple Waveforms (Zoomed In)

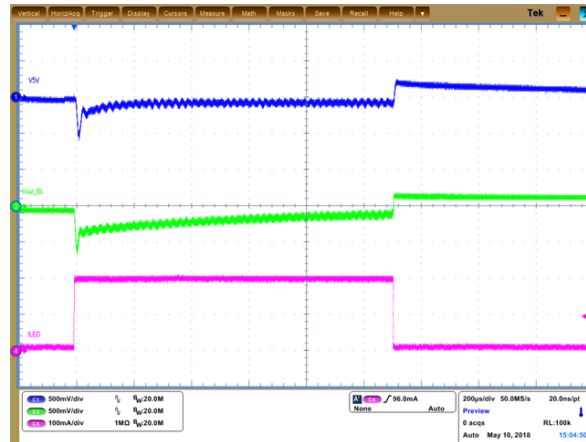

CH1: TPS61089 output 5 V
CH4: LP8556 output current

CH3: LP8556 backlight output voltage

8. TIDA-01635 TPS65132 Waveforms

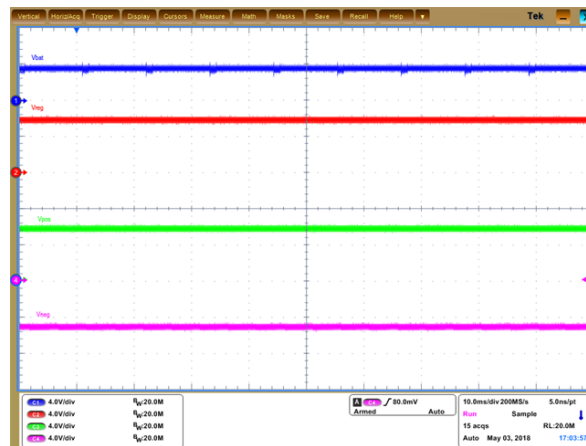

CH1: input voltage
CH2: regulated voltage

CH3: positive output voltage
CH4: negative output voltage

3.2.2.2 12-V Input

A 12-V adaptor voltage is applied to LP8556 directly to drive the backlight LEDs. The TPS563201 device is used to step down 12 V to 5 V and then applied to bias driver TPS65132. [Figure 9](#), [Figure 10](#), [Figure 11](#), [Figure 12](#), and [Figure 13](#) show the waveforms of operations.

Figure 9. TIDA-01635 LP8556 Backlight Driver Waveforms at 12 V_{IN}

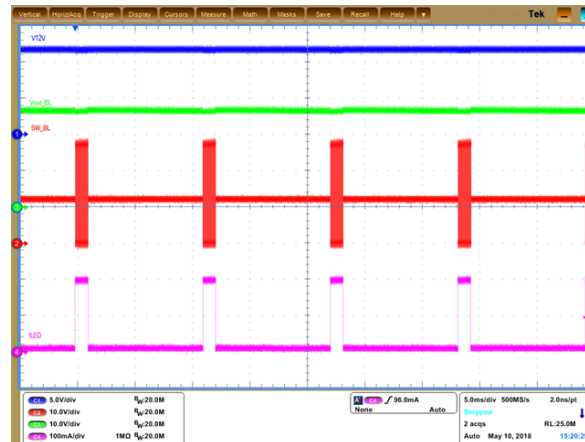

CH1 12-V input voltage
CH2: LP8556 backlight output voltage

CH3: LP8556 backlight switching waveform
CH4: LP8556 output current

Figure 10. TIDA-01635 Voltage-Ripple Waveforms at 12 V_{IN}

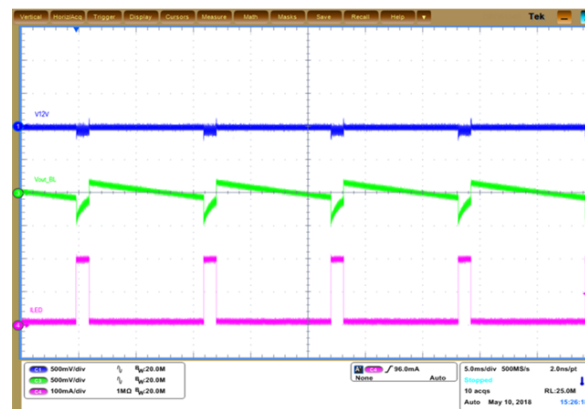

CH1 12-V input voltage
CH2: LP8556 backlight output voltage

CH3: LP8556 backlight switching waveform
CH4: LP8556 output current

図 11. TIDA-01635 Voltage-Ripple Waveforms (Zoomed In) at 12 V_{IN}

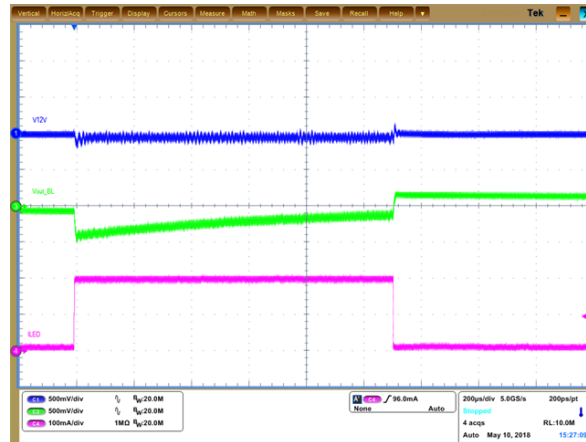

CH1 12-V input voltage
CH2: LP8556 backlight output voltage

CH3: LP8556 backlight switching waveform
CH4: LP8556 output current

図 12. TIDA-01635 Buck Waveforms

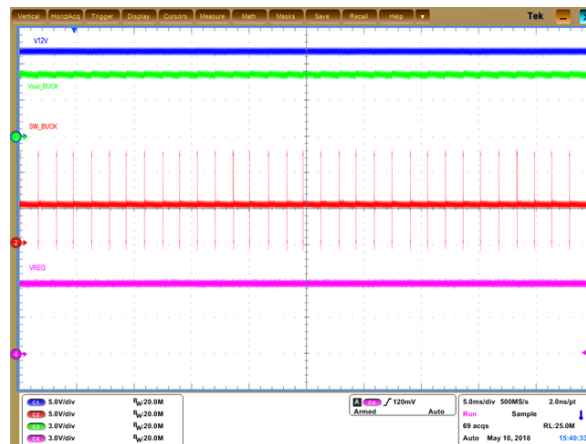

CH1 12-V input voltage
CH2: TPS563201 5-V output

CH3: TPS563201 switching waveform
CH4: TPS65132 output voltage

図 13. TIDA-01635 TPS65132 Waveforms at 12 V_{IN}

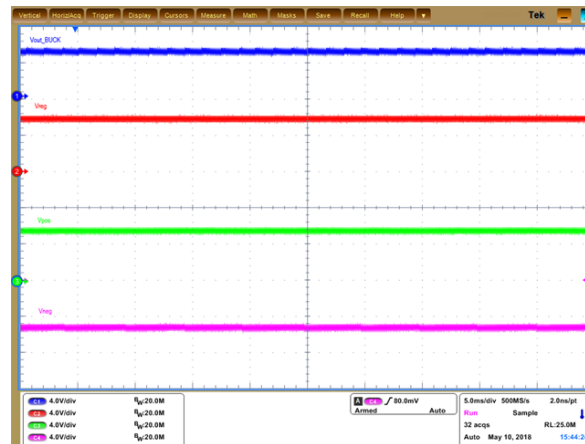

CH1: output voltage of buck converter
 CH2: regulated voltage

CH3: positive output voltage
 CH4: negative output voltage

4 Design Files

4.1 Schematics

To download the schematics, see the design files at [TIDA-01635](#).

4.2 Bill of Materials

To download the bill of materials (BOM), see the design files at [TIDA-01635](#).

4.3 PCB Layout Recommendations

4.3.1 Layout Prints

To download the layer plots, see the design files at [TIDA-01635](#).

4.4 Altium Project

To download the Altium Designer® project files, see the design files at [TIDA-01635](#).

4.5 Gerber Files

To download the Gerber files, see the design files at [TIDA-01635](#).

4.6 Assembly Drawings

To download the assembly drawings, see the design files at [TIDA-01635](#).

5 Software Files

To download the software files, see the design files at [TIDA-01635](#).

6 Related Documentation

1. [LP8556 High-Efficiency LED Backlight Driver for Tablets](#)
2. [TPS65132 Single Inductor - Dual Output Power Supply](#)
3. [TPS56320x 4.5-V to 17-V Input, 3-A Synchronous Step-Down Voltage Regulator in SOT-23](#)

6.1 商標

E2E is a trademark of Texas Instruments.

Altium Designer is a registered trademark of Altium LLC or its affiliated companies.

すべての商標および登録商標はそれぞれの所有者に帰属します。

7 About the Author

Duo Li is an application engineer at Texas Instruments for LED Drivers product line.

重要なお知らせと免責事項

TI は、技術データと信頼性データ(データシートを含みます)、設計リソース(リファレンス・デザインを含みます)、アプリケーションや設計に関する各種アドバイス、Web ツール、安全性情報、その他のリソースを、欠陥が存在する可能性のある「現状のまま」提供しており、商品性および特定目的に対する適合性の黙示保証、第三者の知的財産権の非侵害保証を含むいかなる保証も、明示的または黙示的にかかわらず拒否します。

これらのリソースは、TI 製品を使用する設計の経験を積んだ開発者への提供を意図したものです。(1) お客様のアプリケーションに適した TI 製品の選定、(2) お客様のアプリケーションの設計、検証、試験、(3) お客様のアプリケーションが適用される各種規格や、その他のあらゆる安全性、セキュリティ、またはその他の要件を満たしていることを確実にする責任を、お客様のみが単独で負うものとします。上記の各種リソースは、予告なく変更される可能性があります。これらのリソースは、リソースで説明されている TI 製品を使用するアプリケーションの開発の目的でのみ、TI はその使用をお客様に許諾します。これらのリソースに関して、他の目的で複製することや掲載することは禁止されています。TI や第三者の知的財産権のライセンスが付与されている訳ではありません。お客様は、これらのリソースを自身で使用した結果発生するあらゆる申し立て、損害、費用、損失、責任について、TI およびその代理人を完全に補償するものとし、TI は一切の責任を拒否します。

TI の製品は、TI の販売条件 (www.tij.co.jp/ja-jp/legal/termsofsale.html)、または ti.com やかかる TI 製品の関連資料などのいずれかを通じて提供する適用可能な条項の下で提供されています。TI がこれらのリソースを提供することは、適用される TI の保証または他の保証の放棄の拡大や変更を意味するものではありません。

Copyright © 2018, Texas Instruments Incorporated
日本語版 日本テキサス・インスツルメンツ株式会社

重要なお知らせと免責事項

TI は、技術データと信頼性データ(データシートを含みます)、設計リソース(リファレンス・デザインを含みます)、アプリケーションや設計に関する各種アドバイス、Web ツール、安全性情報、その他のリソースを、欠陥が存在する可能性のある「現状のまま」提供しており、商品性および特定目的に対する適合性の黙示保証、第三者の知的財産権の非侵害保証を含むいかなる保証も、明示的または黙示的にかかわらず拒否します。

これらのリソースは、TI 製品を使用する設計の経験を積んだ開発者への提供を意図したものです。(1) お客様のアプリケーションに適した TI 製品の選定、(2) お客様のアプリケーションの設計、検証、試験、(3) お客様のアプリケーションが適用される各種規格や、その他のあらゆる安全性、セキュリティ、またはその他の要件を満たしていることを確実にする責任を、お客様のみが単独で負うものとします。上記の各種リソースは、予告なく変更される可能性があります。これらのリソースは、リソースで説明されている TI 製品を使用するアプリケーションの開発の目的でのみ、TI はその使用をお客様に許諾します。これらのリソースに関して、他の目的で複製することや掲載することは禁止されています。TI や第三者の知的財産権のライセンスが付与されている訳ではありません。お客様は、これらのリソースを自身で使用した結果発生するあらゆる申し立て、損害、費用、損失、責任について、TI およびその代理人を完全に補償するものとし、TI は一切の責任を拒否します。

TI の製品は、TI の販売条件 (www.tij.co.jp/ja-jp/legal/termsofsale.html)、または ti.com やかかる TI 製品の関連資料などのいずれかを通じて提供する適用可能な条項の下で提供されています。TI がこれらのリソースを提供することは、適用される TI の保証または他の保証の放棄の拡大や変更を意味するものではありません。

Copyright © 2018, Texas Instruments Incorporated
日本語版 日本テキサス・インスツルメンツ株式会社