

デザイン・ガイド: TIDA-010058 スタンバイ電力が 50mW 未満の 5V/2A、12V/2.5A のデュアル出力フライバックのリファレンス・デザイン



概要

このリファレンス・デザインは、UCC28742 に基づく 2 次側レギュレーションを使用した、デュアル出力フライバック・コンバータです。5V レールは $\pm 1\%$ 以内の精度でレギュレートされ、12V レールのクロス・レギュレーションは 25%~100% の負荷において $-8\% \sim +14\%$ の範囲内です。このデザインは、コスト最適化のため単層 PCB を使用します。ピーク効率 は 115V/50Hz で 82.82%、230V/50Hz で 83.19% です。スタンバイ・モードでの消費電力は、115V/50Hz で 31.6mW、230V/50Hz で 54.2 mW です。

リソース

TIDA-010058	デザイン・フォルダ
UCC28742	プロダクト・フォルダ
TL431	プロダクト・フォルダ



[E2E™ エキスパートに質問](#)

特長

- 50W 電源アプリケーションで、スタンバイ時消費電力が 50mW 未満
- フォトカプラ帰還により高速な過渡応答と緊密な電源レギュレーションを実現
- バレー・スイッチング付きの DCM 動作により効率を向上し EMI を低減
- スタートアップ電流が非常に小さく、VDD ヒステリシスが大きいため、低いバイアス容量を実現
- 入力低電圧ライン、出力過電圧、過電流、短絡を含むフォルト保護機能

アプリケーション

- 調理台
- 洗濯機 / 乾燥機
- 住宅用エアコン
- コーヒーメーカー
- 空気清浄機と加湿器

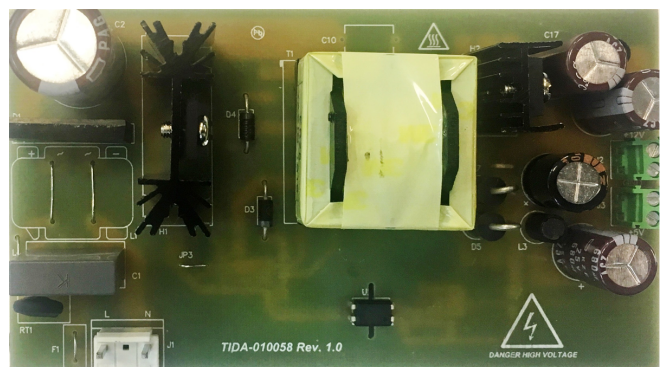
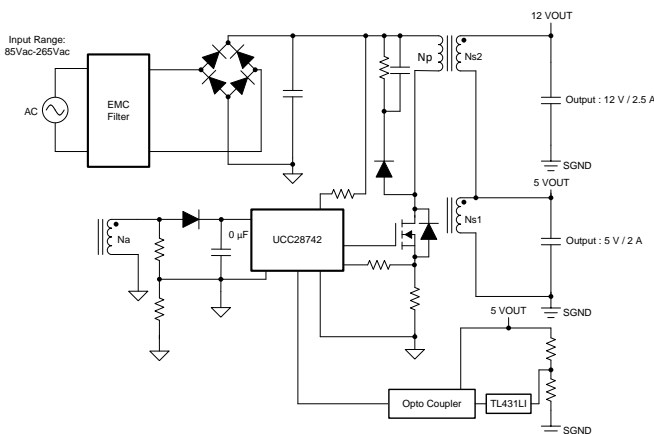

使用許可、知的財産、その他免責事項は、最終ページにあるIMPORTANT NOTICE (重要な注意事項)をご参照くださいますようお願いいたします。

1 System Description

Standby power is electricity used by appliances and equipment while switched off or not performing primary functions. Standby power is also used by circuits that are continually energized even when the device is turned off.

Under the Energy-Using Product (EuP) directive, the commission sets maximum limits for passive standby and off-mode power. The objective of the eco-design requirements for standby and off mode is to ensure the lowest possible energy use for household appliances and electronic products. The main requirement is that standby power of an appliance system without a display must not consume more than 0.5 W, and the standby power of an appliance system with an information display must not consume more than 1 W. The EU directive is expected to change from 500-mW to 300-mW standby power following the release of this design, making it difficult for new functions, such as Wi-Fi®, large displays, and drive power requirements for the active state up, to achieve the new standby power target. A solution is a lower bias power supply for cost-effective total system standby power consumption with no cost increase to the bill of materials (BOM).

1.1 Key System Specifications

表 1. TIDA-010058 Electrical Performance Specifications

PARAMETER	TEST CONDITIONS	MINIMUM	TYPICAL	MAXIMUM	UNIT
INPUT CHARACTERISTICS					
V_{IN}	AC-line input voltage	85	220	265	VRMS
f_{LINE}	Line frequency	47	50	63	Hz
P_{STBY}	No-load input power	$V_{IN}=typ, I_O=0A$		50	mW
OUTPUT CHARACTERISTICS					
V_{O1}	DC output voltage 1	$V_{IN} = typ, I_O = 0$ to I_{OR}	5		V
$V_{RIPPLE1}$	Output voltage ripple 1	$V_{IN} = typ, I_O = I_{OR}$		50	mV
I_{OR1}	Output rated current 1	$V_{IN} = \text{min to max}$	2		A
V_{O2}	DC output voltage 2	$V_{IN} = typ, I_O = 0$ to I_{OR}	12		V
$V_{RIPPLE2}$	Output voltage ripple 2	$V_{IN} = typ, I_O = I_{OR}$		100	mV
I_{OR2}	Output rated current 2	$V_{IN} = \text{min to max}$	2.5		A
η	Average efficiency	$V_{IN}= typ, \text{average of 25\%, 50\%, 75\%, and 100\% Load}$		83.5	%
SYSTEMS CHARACTERISTICS					
f_{SW}	Switching frequency			100	kHz

2 System Overview

2.1 Block Diagram

Figure 1 shows the high-level block diagram of the circuit. The main parts of this reference design are the isolated flyback power supply controller (UCC28742) and the adjustable precision shunt regulator with optimized reference current (TL431LI).

Figure 1. TIDA-010058 Block Diagram

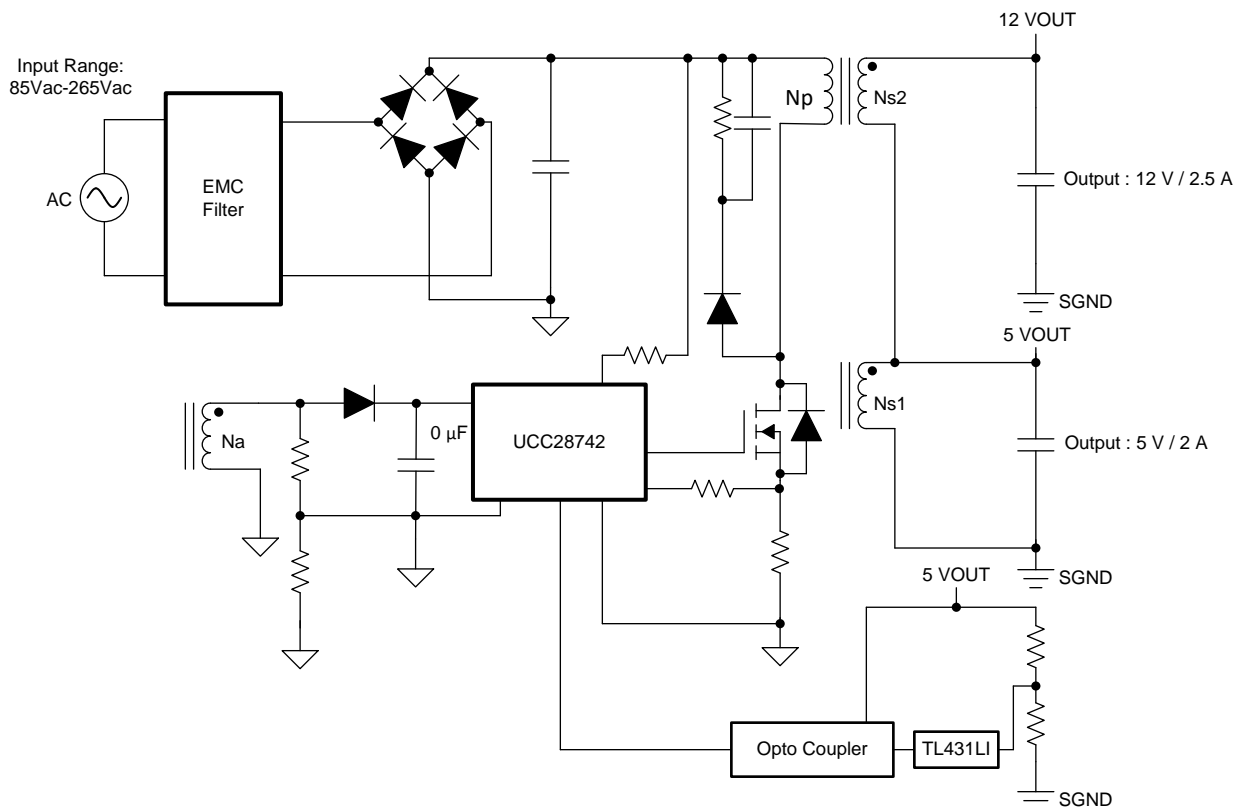

2.2 Design Considerations

Most industrial applications require a bias power supply and have at least dual power rails for the entire system: 3.3 V or 5 V for the system controller and 12 V or 15 V for the power module. This reference design provides dual isolated outputs of 5 V with 2 A and 12 V with 2.5 A that cover most industrial applications. This design also achieves very low power consumption in standby mode. The design is suited for use in isolated offline systems requiring low standby power, high efficiency, and low BOM cost.

2.3 Highlighted Products

This reference design features the following devices, which are selected based on their specifications and cost consideration. For more information on each of these devices, see their respective product folders at TI.com or click on the links for the product folders under Resources.

2.3.1 UCC28742

The UCC28742 is a flyback power-supply controller which provides high-performance voltage regulation using an optically coupled feedback signal from a secondary-side voltage regulator. The device provides accurate constant-current regulation using primary-side feedback. The controller operates in discontinuous-conduction mode (DCM) with valley-switching to minimize switching losses and allow for the use of low cost output rectifiers. The control law scheme combines frequency with primary peak-current amplitude modulation to provide high conversion efficiency across the load range. The control law provides a wide dynamic operating range of output power which allows the power-supply designer to achieve low standby power dissipation. During low-power operating conditions, the power-management features of the controller reduce the device operating current at switching frequencies below 25 kHz. At and above this frequency, the UCC28742 includes features in the modulator to reduce the EMI peak energy of the fundamental switching frequency and harmonics. A complete low-cost and low component-count solution is realized using a straight-forward design process.

2.3.2 TL431LI

This standard device has proven ubiquity and versatility across a wide range of applications, ranging from power to signal path. This is due to its key components containing an accurate voltage reference and op amp, which are very fundamental analog building blocks. TL43xLI is used in conjunction with its key components to behave as a single voltage reference, error amplifier, voltage clamp or comparator with integrated reference. TL43xLI can be operated and adjusted to cathode voltages from 2.495V to 36V, making this part optimum for a wide range of end equipments in industrial, auto, telecom and computing. In order for this device to behave as a shunt regulator or error amplifier, $>1\text{mA}$ ($I_{\text{min(max)}}$) must be supplied in to the cathode pin. Under this condition, feedback can be applied from the Cathode and Ref pins to create a replica of the internal reference voltage. Various reference voltage options can be purchased with initial tolerances (at 25°C) of 0.5%, and 1%. These reference options are denoted by B (0.5%) and A (1.0%) after the TL431LI or TL432LI. TL431LI and TL432LI are both functionally the same, but have separate pinout options. The TL43xLIX devices are characterized for operation from 0°C to 70°C, the TL43xLIXL devices are characterized for operation from -40°C to 85°C, and the TL43xLIXQ devices are characterized for operation from -40°C to 125°C.

2.4 System Design Theory

During voltage regulation (CV mode), the UCC28742 operates in frequency modulation mode and peak current amplitude modulation mode.

The UCC28742 internally limits its operating frequency between $f_{\text{SW(min)}}$ and $f_{\text{SW(max)}}$, typically between 200 Hz and 105 kHz. The choice of transformer primary inductance and primary-peak current sets the maximum operating frequency of the converter, which must be equal to or lower than $f_{\text{SW(max)}}$. Conversely, the choice of maximum target operating frequency and primary-peak current determines the transformer primary-inductance value. The actual minimum switching frequency for any particular converter depends on several factors, including minimum loading level, leakage inductance losses, switch-node capacitance losses, other switching and conduction losses, and bias-supply requirements.

$$C_{DD} = \frac{(I_{RUN} + 1 \text{ mA}) \times \frac{C_{OUT} \times V_{OCV}}{I_{OCC}}}{(V_{DD(on).min} - V_{DD(off).max})} \quad (2)$$

2.4.3 VDD Start-Up Resistance R_{STR}

Once the VDD capacitance is known, the start-up resistance from V_{BULK} to achieve the power-on delay time (t_{STR}) target can be determined using 式 3.

$$R_{STR} = \frac{\sqrt{2} \times V_{IN(min)}}{I_{START} + \frac{V_{DD(on)} \times C_{DD}}{t_{STR}}} \quad (3)$$

2.4.4 VS Resistor Divider

The VS divider resistors determine the output voltage regulation point of the flyback converter. The high-side divider resistor (R_{S1}) determines the line voltage at which the controller enables continuous DRV operation. R_{S1} is initially determined based on the transformer auxiliary to primary turns-ratio and the desired input voltage operating threshold. R_{S1} can be calculated using 式 4.

$$R_{S1} = \frac{V_{IN(run)} \times \sqrt{2}}{N_{PA} \times I_{VSL(run)}} \quad (4)$$

$I_{VSL(run)}$ is VS pin run current with a typical value of 210 μ A for a design. The low-side VS pin resistor is selected based on desired output over voltage V_{OV} and can be calculated using 式 5.

$$R_{S2} = \frac{R_{S1} \times V_{OVP}}{N_{AS} \times (V_{OV} + V_F) - V_{OVP}} \quad (5)$$

2.4.5 Transformer Turns Ratio N_{PS} , Inductance L_p , Primary-Peak Current $I_{PP(MAX)}$

The maximum primary-to-secondary turns ratio can be determined by the target maximum switching frequency at full load, the minimum input capacitor bulk voltage, and the estimated DCM resonant time.

Determine the maximum available total duty cycle of the on time and secondary conduction time based on the target switching frequency and DCM resonant time. For DCM resonant time, assume 500 kHz if an estimate is not available from previous designs. For the transition mode operation limit, the period required from the end of secondary current conduction to the first valley of the V_{DS} voltage is $\frac{1}{2}$ of the DCM resonant period, or 1 μ s assuming 500-kHz resonant frequency. D_{MAX} can be determined using 式 6.

$$D_{MAX} = 1 - \left(\frac{t_R}{2} \times f_{MAX} \right) - D_{MAGCC} \quad (6)$$

Once D_{MAX} is known, the maximum turns ratio of the primary to secondary can be determined using 式 7. D_{MAGCC} is defined as the secondary diode conduction duty cycle when load current reaches a specified limit operation. It is set internally by the UCC28742 at 0.475. The total voltage on the secondary winding needs to be determined, which is the sum of V_{OCV} , and the secondary rectifier, V_F . N_{PS} can be determined using 式 7.

$$N_{PS} = \frac{D_{MAX} \times V_{BULK(min)}}{D_{MAGCC} \times (V_{OCV} + V_F)} \quad (7)$$

N_{PS} is determined also with other design factors such as voltage and current ratings of the primary MOSFET, secondary rectifier diode, as well as the secondary MOSFET if the synchronous rectifier is used. Once an optimum turns ratio is determined from a detailed transformer design, use this ratio for the other parameters.

The primary transformer inductance and primary-peak current, $I_{PP(MAX)}$, can be calculated using the standard energy storage equation for flyback transformers. Primary current, maximum switching frequency, and output and transformer efficiency are included in 式 8 and 式 9.

The transformer primary current should be determined. Primary current is simply the maximum current sense threshold divided by the current sense resistance.

$$I_{PP(max)} = \frac{V_{CST(max)}}{R_{CS}} \quad (8)$$

$$L_P = \frac{2 \times (V_{OCV} + V_F) \times I_{OCC}}{\eta_{XFMR} \times I_{PP(max)}^2 \times f_{MAX}} \quad (9)$$

3 Hardware, Testing Requirements, and Test Results

3.1 Required Hardware

3.1.1 Test Equipment Needed

- Chroma AC source MODEL 61603
- Chroma DC E-load MODEL 6314A
- Single-phase power meter WT210
- Tektronix DPO 3054
- Multimeter (current): Fluke 287C
- Multimeter (voltage): Fluke 287C
- Electrical thermography: Fluke TiS55
- EMI test receiver: KH3939

3.1.2 Test Setup

- Connect the line of the AC source on the design input (pin 1 of connector J1), and connect the neutral of the AC source on the TIDA-010058 input (pin 2 of connector J1) through the current sensing module of the power meter.
- Connect the voltage sensing module to the design input (connector J1).
- Connect an electronic load to the 12-V output terminal (connector J2) with the load set to draw 30 W through the multimeter.
- Connect another electronic load to the 5-V output terminal (connector J3) with the load set to draw 10 W.
- Turn on the AC source connected to the design input with a universal input voltage (85-V to 264-V AC).
- Once the design activates, monitor the input power consumption and dual output performance.
- Turn off the AC source and disconnect the AC source from the board when the test is complete.

3.2 Testing and Results

3.2.1 Efficiency With Load Variation

図 3. Efficiency With Load Variation

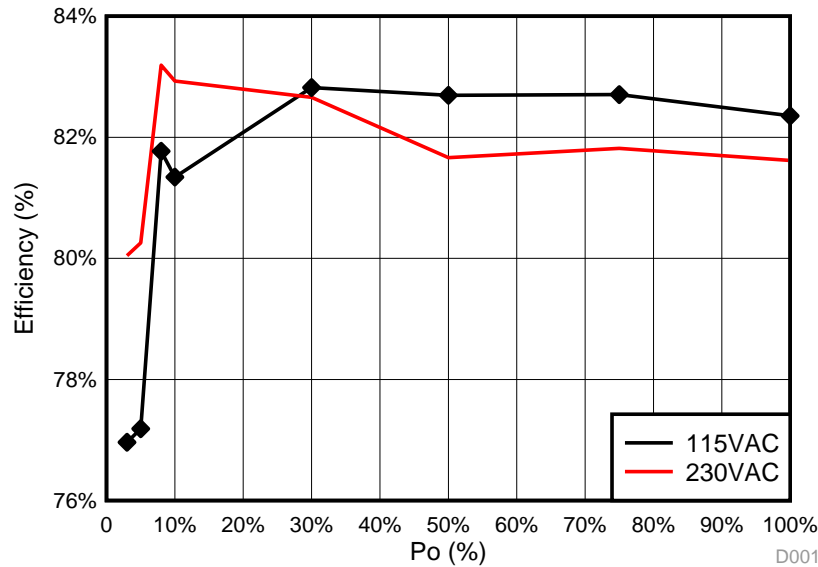

3.2.1.1 115-V AC/50-Hz Efficiency Measurement

表 2. 115-V AC/50-Hz Efficiency Measurement

Vin (Vac)	LOAD (%)	PIN (W)	Vout1 (V)	Iout1 (A)	Vout2 (V)	Iout2 (A)	Pout (V)	η (%)
115 V	3%	1.61	4.99	0.05	12.37	0.08	1.24	76.96%
	5%	2.74	4.99	0.1	12.43	0.13	2.11	77.19%
	8%	4.10	4.99	0.15	12.4	0.21	3.35	81.77%
	10%	5.20	4.99	0.2	12.43	0.26	4.23	81.34%
	30%	15.00	4.99	0.57	12.44	0.77	12.42	82.82%
	50%	24.60	4.98	0.92	12.41	1.27	20.34	82.69%
	75%	36.30	4.98	1.33	12.38	1.89	30.02	82.70%
	100%	47.60	4.97	1.7	12.35	2.49	39.20	82.35%

3.2.1.2 230-V AC/50-Hz Efficiency Measurement

表 3. 230-V AC/50-Hz Efficiency Measurement

Vin (Vac)	LOAD (%)	PIN (W)	Vout1 (V)	Iout1 (A)	Vout2 (V)	Iout2 (A)	Pout (V)	η (%)
230 V	3%	1.55	4.99	0.05	12.39	0.08	1.24	80.05%
	5%	2.64	4.99	0.1	12.46	0.13	2.12	80.26%
	8%	4.04	4.99	0.15	12.44	0.21	3.36	83.19%
	10%	5.11	4.99	0.2	12.46	0.26	4.24	82.93%
	30%	15.02	4.99	0.57	12.43	0.77	12.42	82.66%
	50%	24.91	4.98	0.92	12.41	1.27	20.34	81.66%
	75%	36.67	4.98	1.33	12.37	1.89	30.00	81.82%
	100%	48.00	4.97	1.7	12.34	2.49	39.18	81.62%

3.2.2 Cross Regulation

3.2.2.1 Cross Regulation Under 115-V AC/50 Hz

表 4. Vin = 115 V, Vout1

LOAD 2 / LOAD 1	3%	5%	8%	10%	30%	50%	75%	100%
1%	4.99	4.99	4.99	4.99	4.99	4.99	4.99	4.99
3%	4.99	4.99	4.99	4.99	4.99	4.99	4.99	4.99
5%	4.99	4.99	4.99	4.99	4.99	4.99	4.99	4.99
8%	4.99	0.99	4.99	4.99	4.99	4.99	4.99	4.99
10%	4.99	4.99	4.99	4.99	4.99	4.99	4.99	4.99
30%	4.99	4.99	4.99	4.99	4.99	4.99	4.99	4.99
50%	4.99	4.99	4.99	4.99	4.99	4.99	4.99	4.99
75%	4.99	5	4.99	4.99	4.99	4.99	4.99	4.99
100%	4.99	4.99	4.99	4.99	4.99	4.99	4.99	4.99

表 5. Vin = 115 V, Vout2

LOAD 2 / LOAD 1	3%	5%	8%	10%	30%	50%	75%	100%
1%	13.08	13.85	14.48	15.03	-	-	-	-
3%	12.39	12.74	13.06	13.35	15.21	-	-	-
5%	12.16	12.46	12.69	12.89	14.28	15.32	-	-
8%	11.9	12.26	12.44	12.58	13.61	14.38	-	-
10%	11.75	12.15	12.34	12.46	13.35	14.01	14.71	-
30%	-	11.29	11.63	11.83	12.49	12.8	13.14	13.43
50%	-	10.67	11.11	11.3	12.19	12.46	12.68	12.88
75%	-	10.07	10.58	10.9	11.91	12.21	12.41	12.55
100%	-	-	-	-	-	12.04	12.24	12.37

3.2.2.2 Cross Regulation Under 230-V AC/50 Hz
表 6. Vin = 230 V, Vout1

LOAD 2 / LOAD 1	3%	5%	8%	10%	30%	50%	75%	100%
1%	4.99	4.99	4.99	4.99	4.99	4.99	4.99	4.99
3%	4.99	4.99	4.99	4.99	4.99	4.99	4.99	4.99
5%	4.99	4.99	4.99	4.99	4.99	4.99	4.99	4.99
8%	4.99	4.99	4.99	4.99	4.99	4.99	4.99	4.99
10%	4.99	4.99	4.99	4.99	4.99	4.99	4.99	4.99
30%	4.99	4.99	4.99	4.99	4.99	4.99	4.99	4.99
50%	4.99	4.99	4.99	4.99	4.99	4.99	4.99	4.99
75%	4.99	5	4.99	4.99	4.99	4.99	4.99	4.99
100%	4.99	4.99	4.99	4.99	4.99	4.99	4.99	4.99

表 7. Vin = 230 V, Vout2

LOAD 2 / LOAD 1	3%	5%	8%	10%	30%	50%	75%	100%
1%	13.08	13.87	14.54	15.1	-	-	-	-
3%	12.39	12.78	13.1	13.38	15.26	-	-	-
5%	12.15	12.48	12.7	12.9	14.26	-	-	-
8%	11.87	12.26	12.45	12.6	13.59	14.38	-	-
10%	11.71	12.14	12.35	12.48	13.34	14.02	14.72	-
30%	-	11.34	11.68	11.87	12.49	12.8	13.14	13.44
50%	-	-	11.17	11.43	12.19	12.45	12.69	12.9
75%	-	-	-	10.98	11.92	12.21	12.41	12.57
100%	-	-	-	-	11.7	12.03	12.24	12.38

3.2.3 No-Load Power Consumption
表 8. No-Load Power Consumption

Vin (V)	85	115	130	150	180	200	230	265
Pin (mW)	27	36.7	43.12	35.02	40.47	39.33	48.2	59.1

3.2.4 Thermal Test

図 4. Thermal Test Under 230-V AC and Full Load

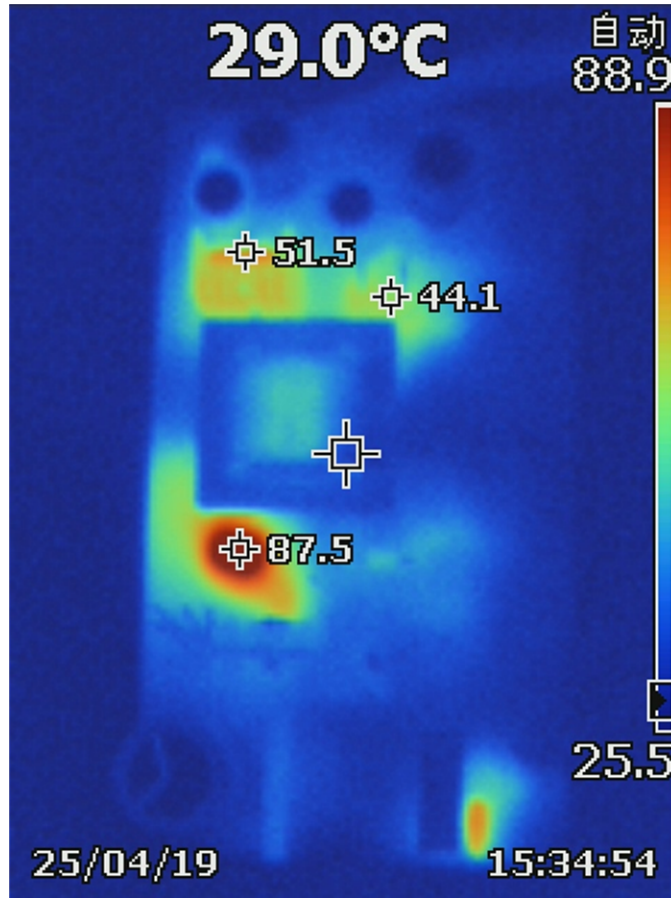

The thermal test shows a top view of the board because all of the power components are on the top layer. The output load is 5 V-2 A and 12 V-2.5 A and runs for 30 minutes. The ambient temperature was 22.5°C, open frame.

図 7 shows the test under 230-V AC input and full load.

図 7. V_{DS} Under 230-V AC Input and Full Load



図 8 shows the test under 265-V AC input and full load.

図 8. V_{DS} Under 265-V AC Input and Full Load

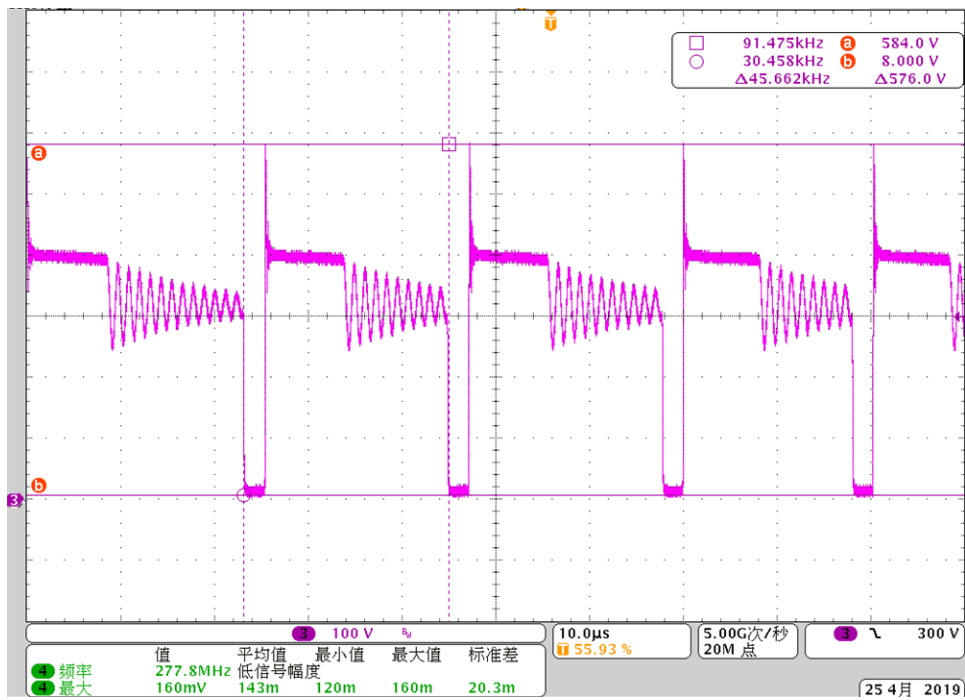
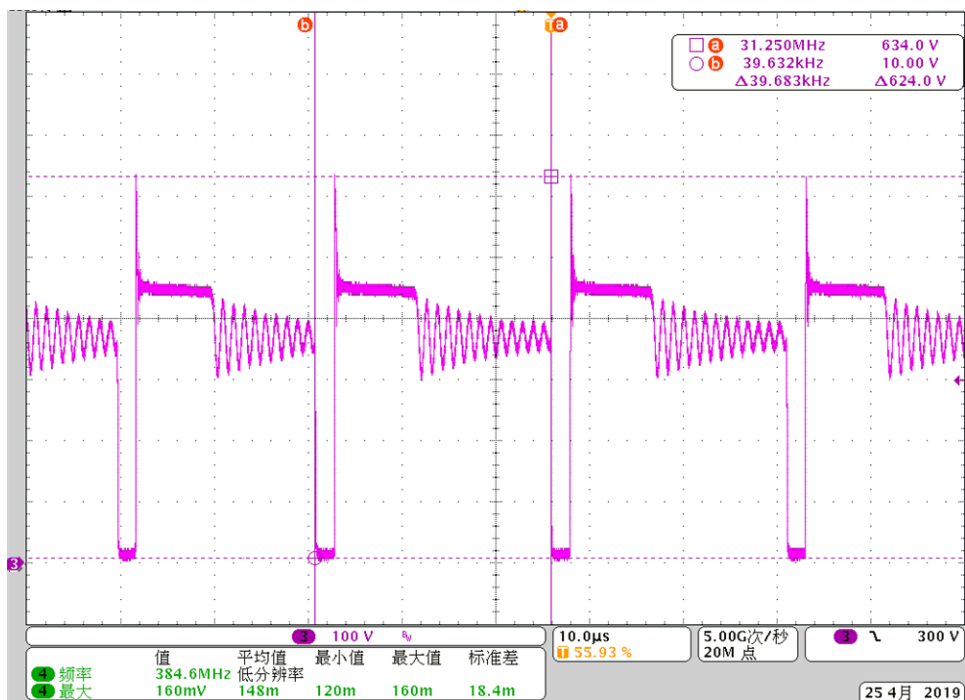

3.3.2 Secondary Rectifier Diode Stress V_{DD}

図 9 shows the test under 265-V AC input and full load.

図 9. V_{DD} of 5 V Under 265-V AC Input and Full Load



図 10. V_{DD} of 12 V Under 265-V AC Input and Full Load



3.3.3 Output Voltage Ripple

図 11. Output Voltage Ripple Under 85-V AC Input and Full Load

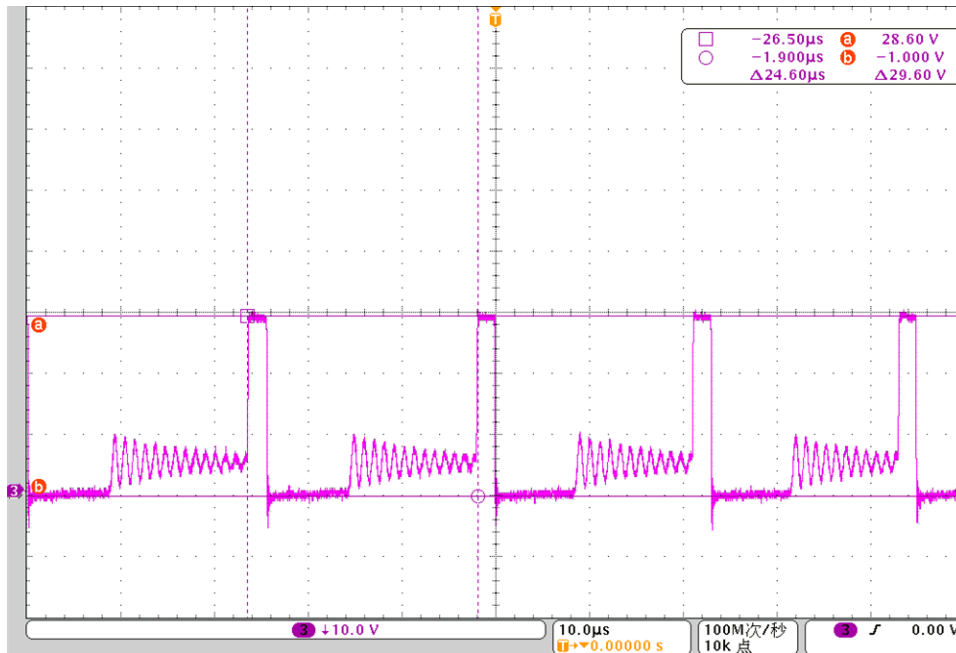
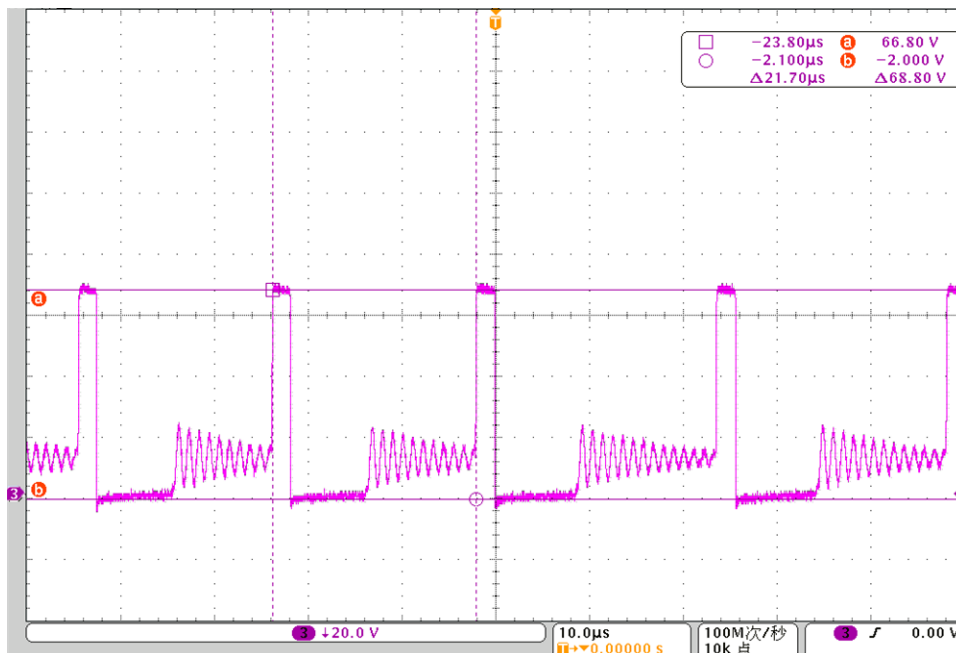

図 12. Output Voltage Ripple Under 115-V AC Input and Full Load



図 13. Output Voltage Ripple Under 230-V AC Input and Full Load

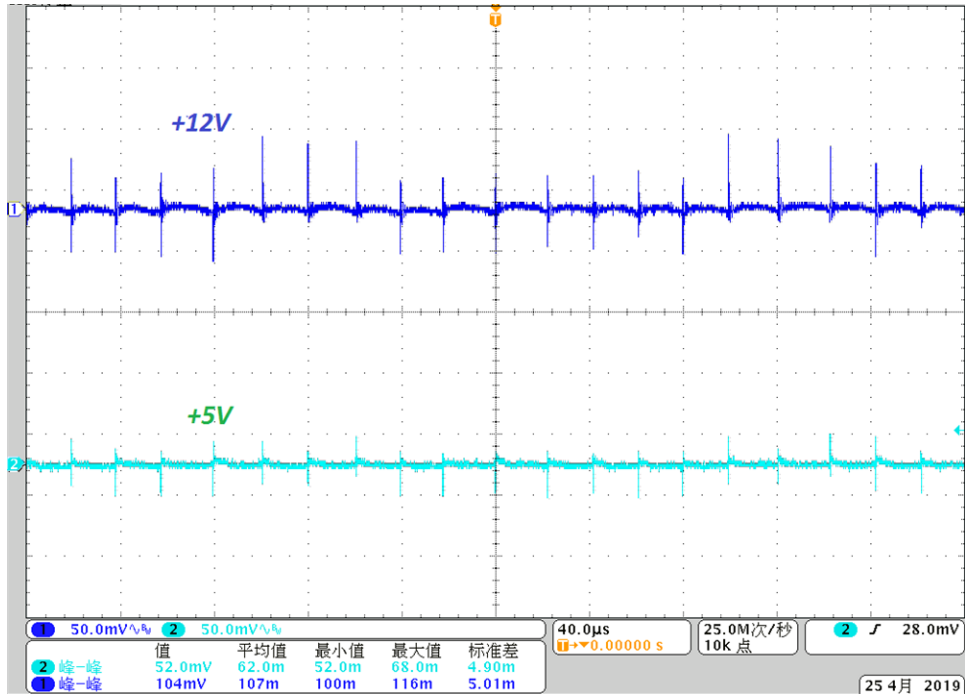

図 14. Output Voltage Ripple Under 265-V AC Input and Full Load

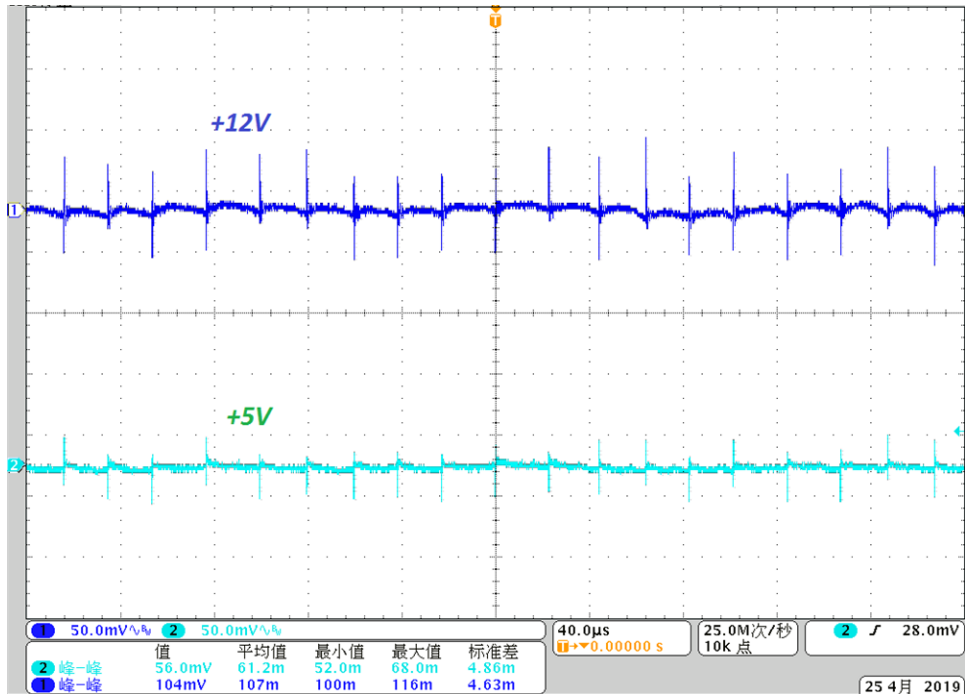

3.3.4 Conducted Emission (EN55022 Class B)

☒ 15 shows the test under 230-V AC/50 Hz and full load.

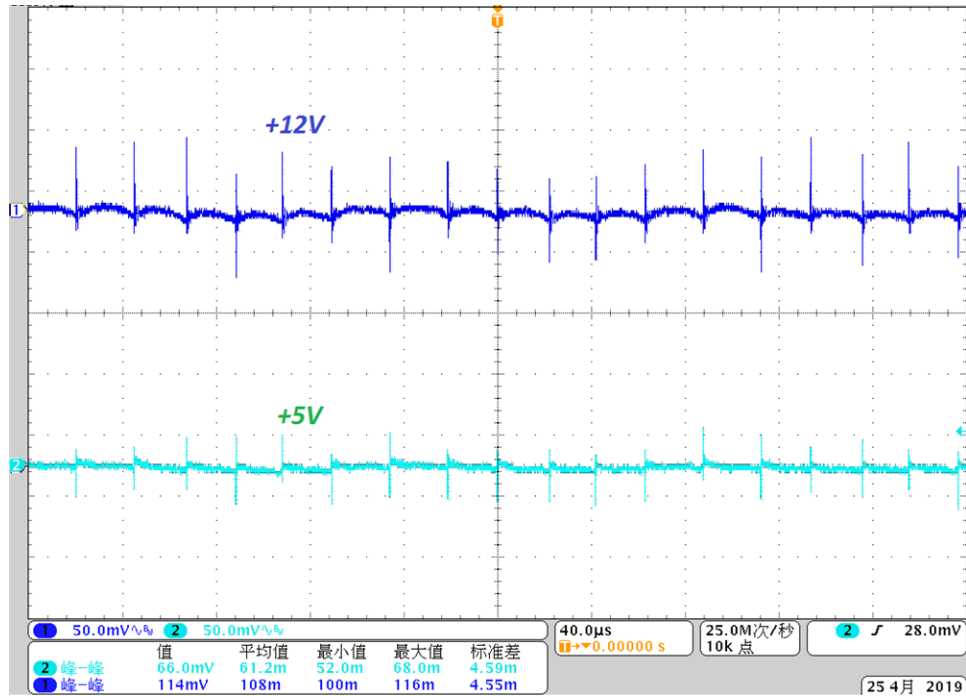
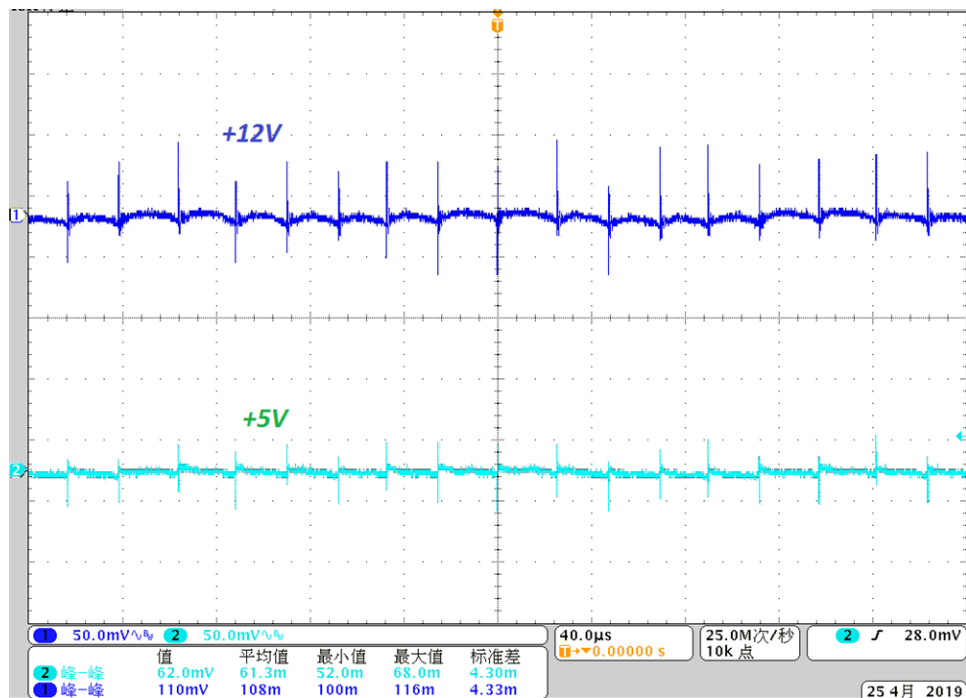
☒ 15. Conducted Emission Test Under 230-V AC/50-Hz Input and Full Load

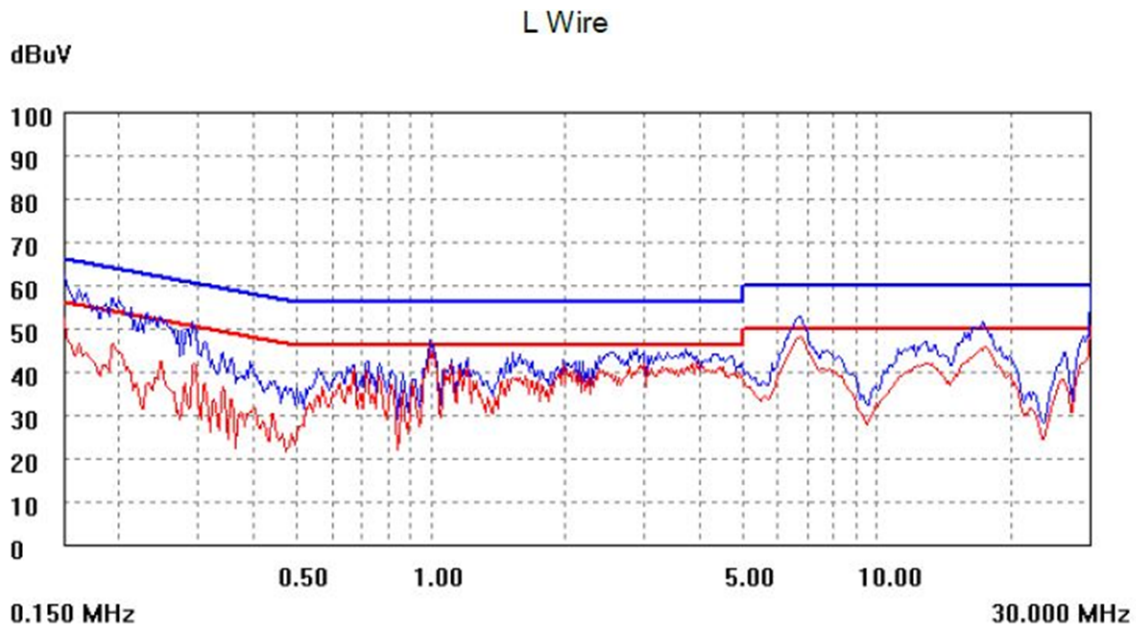

4 Design Files

4.1 Schematics

To download the schematics, see the design files at [TIDA-010058](#).

4.2 Bill of Materials

To download the bill of materials (BOM), see the design files at [TIDA-010058](#).

4.3 PCB Layout Recommendations

To increase the reliability and feasibility of the project, use the following guidelines:

- Minimize stray capacitance on the VS node.
- Place the voltage sense resistors R17 and R18 close to the VS pin.
- Connect the high-voltage input to a non-switching source of high voltage — not to the MOSFET drain — to avoid injecting high-frequency capacitive current pulses into the device.
- Connect the main power loop ground and the UCC28742 ground through a single point connection at the C2 ground pin.
- Arrange the components to minimize the loop areas of the switching currents as much as possible.

4.3.1 Layout Prints

To download the layer plots, see the design files at [TIDA-010058](#).

4.4 Altium Project

To download the Altium Designer® project files, see the design files at [TIDA-010058](#).

4.5 Gerber Files

To download the Gerber files, see the design files at [TIDA-010058](#).

4.6 Assembly Drawings

To download the assembly drawings, see the design files at [TIDA-010058](#).

5 Related Documentation

1. Texas Instruments, [UCC28742 High-Efficiency Flyback Controller With Optocoupler Feedback Data Sheet](#)

5.1 商標

E2E is a trademark of Texas Instruments.

Altium Designer is a registered trademark of Altium LLC or its affiliated companies.

Wi-Fi is a registered trademark of Wi-Fi Alliance.

すべての商標および登録商標はそれぞれの所有者に帰属します。

6 About the Author

YUAN (JASON) TAO is a systems engineer at Texas Instruments, where he is responsible for developing reference design solutions for the industrial segment. Yuan brings to this role his extensive experience in power electronics, high-frequency DC/DC, AC/DC converters, and analog circuit design. Yuan earned his master of IC design and manufacture from Shanghai Jiao Tong University in 2007.

重要なお知らせと免責事項

TI は、技術データと信頼性データ(データシートを含みます)、設計リソース(リファレンス・デザインを含みます)、アプリケーションや設計に関する各種アドバイス、Web ツール、安全性情報、その他のリソースを、欠陥が存在する可能性のある「現状のまま」提供しており、商品性および特定目的に対する適合性の黙示保証、第三者の知的財産権の非侵害保証を含むいかなる保証も、明示的または黙示的にかかわらず拒否します。

これらのリソースは、TI 製品を使用する設計の経験を積んだ開発者への提供を意図したものです。(1) お客様のアプリケーションに適した TI 製品の選定、(2) お客様のアプリケーションの設計、検証、試験、(3) お客様のアプリケーションに該当する各種規格や、その他のあらゆる安全性、セキュリティ、規制、または他の要件への確実な適合に関する責任を、お客様のみが単独で負うものとします。

上記の各種リソースは、予告なく変更される可能性があります。これらのリソースは、リソースで説明されている TI 製品を使用するアプリケーションの開発の目的でのみ、TI はその使用をお客様に許諾します。これらのリソースに関して、他の目的で複製することや掲載することは禁止されています。TI や第三者の知的財産権のライセンスが付与されている訳ではありません。お客様は、これらのリソースを自身で使用した結果発生するあらゆる申し立て、損害、費用、損失、責任について、TI およびその代理人を完全に補償するものとし、TI は一切の責任を拒否します。

TI の製品は、[TI の販売条件](#)、または [ti.com](https://www.ti.com) やかかる TI 製品の関連資料などのいずれかを通じて提供する適用可能な条項の下で提供されています。TI がこれらのリソースを提供することは、適用される TI の保証または他の保証の放棄の拡大や変更を意味するものではありません。

お客様がいかなる追加条項または代替条項を提案した場合でも、TI はそれらに異議を唱え、拒否します。

郵送先住所 : Texas Instruments, Post Office Box 655303, Dallas, Texas 75265

Copyright © 2022, Texas Instruments Incorporated