

Texas Instruments Registration and Identification System

Description of Multipage, Selective Addressable and Selective Addressable (Secured) Transponders

Reference Guide

October 1999

TIRIS Technology by
Texas Instruments™

Texas Instruments Registration and Identification System

***Description of Multipage, Selective Addressable and
Selective Addressable (Secured) Transponders***

Reference Guide

TIRIS Technology by
Texas Instruments™

Literature Number: SCBU020

October 1999



Contents

1	General	7
1.1	Introduction	7
1.2	Nomenclature	8
2	Function	8
2.1	Memory Organization	8
2.2	Selective Addressing Principle	9
2.3	Function Overview	10
3	EMI/EMC Performance	24
3.1	General	24
3.2	CE Declaration	24
3.3	TIRIS™ System Performance	25
4	Read and Write Principle	26
4.1	Read	26
4.2	Write and Program	26
5	Measurement Set-Ups	28
5.1	Measurement Set-Up: Resonance Frequency, Bandwidth, Quality Factor of Transponder	28
5.2	Measurement Set-Up: Powering Field Strength	29
5.3	Measurement Set-Up: Transponder Signal Strength	30
6	General Product Data	31
6.1	Memory	31
6.2	Data Retention	32
6.3	ESD	33
Appendix A	Conversion Formula	34
A.1	Abbreviations	34

List of Figures

1	System Configuration Showing the Reader, Antenna, and Transponder	7
2	Block Diagram of the TIRIS Transponder	7
3	Memory Organisation of the MPT 0/17	8
4	Memory Organisation of the SAMPT & SAMPTS 0/17-24	9
5	MPT Read Data Format	11
6	Data Format of the General Read Page Function	12
7	Data Format of the Selective Read Page Function	14
8	Data Format of the Program Page Function	16
9	Data Format of the Selective Program Page Function	18
10	Data Format of the Lock Page Function	20
11	Data Format of the Selective Lock Page Function	22
12	TIRIS System Immunity over a Spectrum of 6 Decades	25
13	FM Principle Used for the Read Function of TIRIS Transponders	26
14	Write and Program Function	26
15	Charge, Write and Program principle used for TIRIS, Showing the Voltage at the Exciter (Reader) and Transponder Antenna Coil	27
16	Determination of the Resonance Frequency and -3db Bandwidth by Monitoring the Pick-Up Coil Voltage ...	28
17	Measurement Set-up for the Determination of Transponder Resonance Frequency, Bandwidth and Quality Factor	28
18	Test Set-up for Powering Field Strength Determination	29
19	Received Signal at the Pick-up Coil, if Power Field Strength is Sufficient	30
20	Determination of the Transponder Signal Strength (Data Transmission Signal Strength) with Helmholtz Aperture	30
21	Monitored Signal Voltage at the Spectrum Analyser (Time Domain Mode)	31
22	32
23	33

List of Tables

1	Responses to General Read Page	13
2	Responses to General Read Page	15
3	Responses to Program Page	17
4	Responses to Selective Program Page	19
5	Responses to Lock Page.....	21
6	Responses to Selective Lock Page.....	23

Edition Notice: Second Edition October 1999

This is the second edition of this manual, it describes the following transponder families:

Multipage Transponder (MPT)

Selective Addressable Multipage Transponder (SAMPT)

Selective Addressable Multipage Transponder (Secure) (SAMPTS)

The manual includes technical information concerning the function, technical specifications, application and environmental related data.

Texas Instruments reserves the right to change its products or services at any time without notice. TI provides customer assistance in various technical areas, but does not have full access to data concerning the uses and applications of customer's products. Therefore TI assumes no responsibility for customer product design or for infringement of patents and/or the rights of third parties, which may result from assistance provided by TI.

The TIRIS™ logo and the word TIRIS™ are registered trademarks of Texas Instruments Incorporated.

Copyright © 1996 Texas Instruments Incorporated.

All rights reserved.

1 General

1.1 Introduction

The TIRIS transponder is a key product in low frequency RFID systems that can be used for a variety of applications.

Electro Magnetic signals are used to power the passive (batteryless) device, to transmit the identification number to a reader unit or to program the device with new data. The basic principle is described in Figure 1.

The transponder comprises an antenna, a charge capacitor, a resonance capacitor and the integrated circuit (Figure 2). The antenna inductance and a capacitor form a high quality resonant circuit.

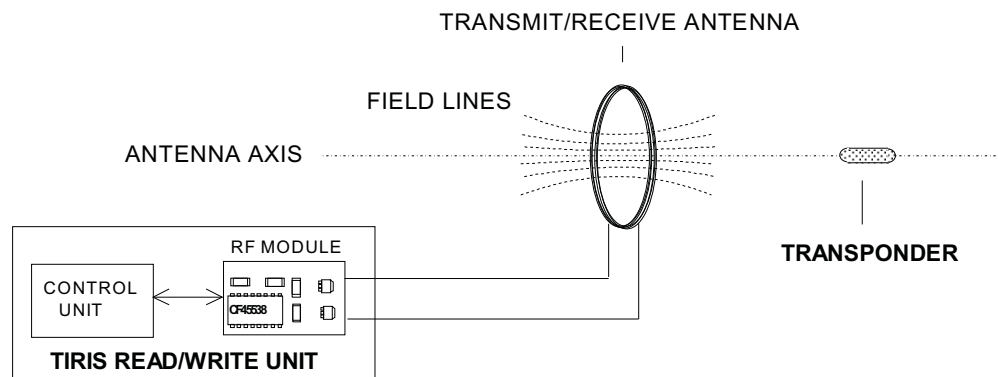

Figure 1. System Configuration Showing the Reader, Antenna, and Transponder

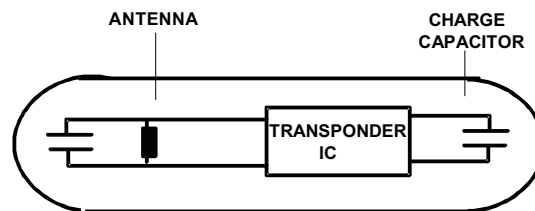

Figure 2. Block Diagram of the TIRIS Transponder

1.2 Nomenclature

In this manual we describes the following transponders:

Multipage Transponder with 17 R/W pages (MPT 0/17)

Selective Addressable Multipage Transponder with 17 R/W pages and 24 bits selective address (SAMPT 0/17-24)

Selective Addressable Multipage Transponder (Secure) with 17 R/W pages and 24 bits selective address (SAMPTS 0/17-24) Transponder Packaging

The dimensions of the transponder are given in . For information to the availability of the described functionalities in different packages view our internet home page <http://www.tiris.com>

2 Function

2.1 Memory Organization

Figure 3 shows the memory organization principle of the EEPROM cells for the MPT 0/17. Figure 4 shows the memory organization principle of the EEPROM cells for the SAMPT and SAMPTS 0/17-24.

The memory organization described and shown here is that used by TIRIS readers, if you use readers other than TIRIS readers (customer designed) the allocation of the 64 data bits depends on the reader software.

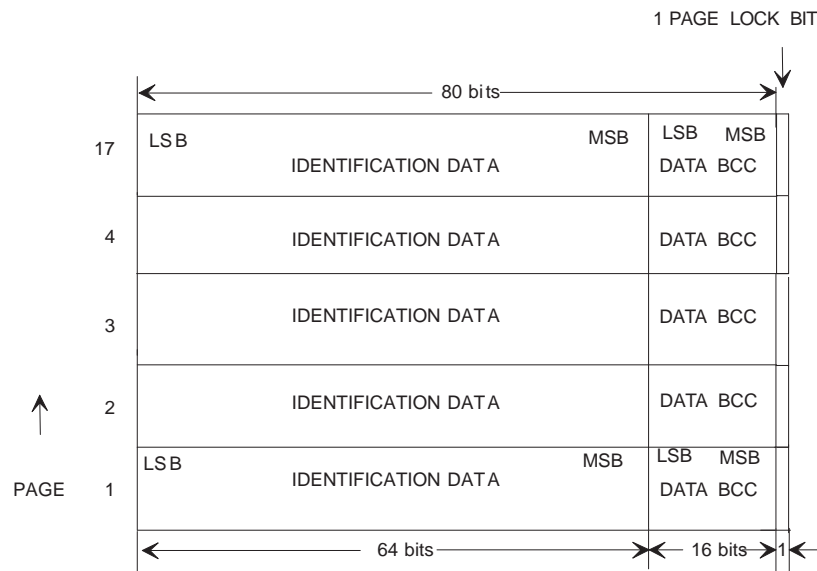

Figure 3. Memory Organisation of the MPT 0/17

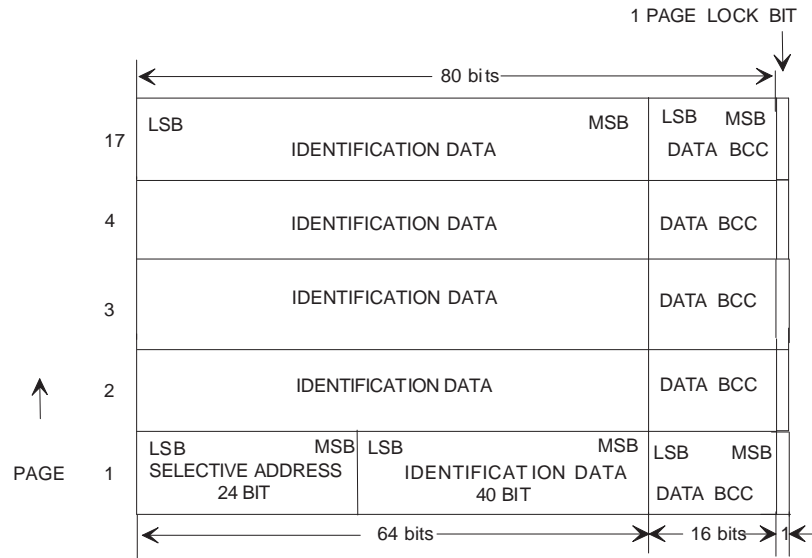

Figure 4. Memory Organisation of the SAMPT & SAMPTS 0/17-24

The memory is structured into 17 pages each containing 80 data bits and one lock bit each. 64 bits are used for identification data and 16 bits for protection data (Data BCC). The page lock bit can be set by sending the corresponding command to the transponder. Once a page is locked it cannot be reset (unlocked). The pages are organized as follows:

MPT 0/17: Each page is readable, user programmable and lockable.

SAMPT 0/17-24: The 64 bits of page 1 are divided into 24 selective address bits which make up the selective address of the transponder and the remaining 40 identification bits. Each page is readable, user programmable and lockable.

SAMPTS 0/17-24: The 64 bits of page 1 are divided into 24 selective address bits which make up the selective address of the transponder and the remaining 40 identification bits. Each page is readable, user programmable and lockable.

2.2 Selective Addressing Principle

In SAMPT 0/17-24 and SAMPTS 0/17-24 page 1 contains 24 selective address bits and 40 identification data bits. Some commands can only be executed by selective addressable transponders if they are addressed with its selective address, otherwise they discharge and do not reply.

Thus selective addressing is useful for applications where:

- several transponders are in close proximity.
- several transponders are in the reading/programming range so that more than one transponder would be read/programmed/locked. With selective addressable types only the transponder addressed with its selective address executes the command.

2.3 Function Overview

The functions that can be performed by the different multipage transponders are as follows (refer to section 2.3.1 Function Description for details about the different functions):

MPT 0/17:	Charge Only Read General Read Page Program Page Lock Page		
SAMPT 0/17-24:	General Read Page Selective Read Page Selective Program Page Selective Lock Page	SAMPTS 0/17-24:	Selective Read Page Selective Program Page Selective Lock Page

2.3.1 Function Description

The functions as mentioned above are:

CHARGE ONLY READ: The contents of page 1 can be read without a specific page address, by just powering-up the transponder.

GENERAL READ PAGE: A page is addressed by sending a page address to the transponder. The content of the addressed page is returned during the subsequent read Phase.

SELECTIVE READ PAGE: To achieve a readout of a specified page selectively, the transponders selective address must be sent to the transponder as well as the page address. The transponder compares the selective address with the corresponding bit field in page 1. If all the bits match, the function is executed; otherwise the transponder does not respond.

PROGRAM PAGE: A 64-bit identification and a 16 bit BCC are sent to the transponder and programmed into the specified page. The transponder responds with the new contents of the page.

SELECTIVE PROGRAM PAGE: In order to program a specified page selectively, the selective address must be sent to the transponder in addition to the page address. The transponder compares the selective address with the corresponding bit field in page 1. If all the bits match, the function is executed; otherwise the transponder does not respond.

LOCK PAGE (Disable reprogramming): A specified page can be locked in order to create a read only page. The transponder responds with the contents of the addressed page and conformation that the page has been locked.

SELECTIVE LOCK PAGE: In order to lock a specified page selectively, the selective address must be sent to the transponder in addition to the page address. The transponder compares the selective address with the corresponding bit field in page 1. If all the bits match, the function is executed; otherwise the transponder does not respond.

2.3.2 Multipage Transponder Read Data Format

The following read data format is sent out by all multipage transponders after receiving a read, program or lock command.

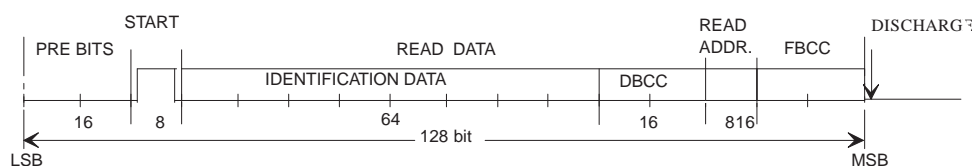

Figure 5. MPT Read Data Format

DESCRIPTION	BITS	VALUE (HEX)		COMMENT
		MSB	LSB	
Pre Bits	16		0000	
Start Byte	8		7E	x: identification data
Read Data	80		yyyyxxxxxxxxxxxxxxxxxxx	y: data BCC
Read Address	8		ps s	ps: page + statu
Read Frame BCC	16		zzzz	
TOTAL	128			

All parts of the multipage transponder read data format are transmitted with LSB first. The data format starts with 16 pre bits (0000HEX) and ends with the Read Frame Block Check Character (Read FBCC). In order to be ready for a new activation the transponder discharges the charge capacitor during bit 129.

80 read data bits are located between the start byte (7EHEX) and the read address. The read data bits are user programmable and lockable. The read data is split into 64 identification data bits which are transmitted first, followed by 16 protection data bits (DBCC). Because it allows optimum data security, CRC-CCITT is used as protection algorithm for both DBCC and FBCC.

The read address consists of a 2-bit status field and a 6-bit page field. The status field transmitted first, provides information about the function the multipage transponder has executed, and the page field shows which page was affected.

	READ ADDRESS			
	MSB		LSB	
	P	P	P	S
	PAGE		STATUS	
	MSB	LSB	MSB	LSB
Page 1	000001		00	Read unlocked page
Page 2	000010		01	Programming done
...			10	Read locked page
Page 16	010000		11	Reserved *)
Page 17	010001			
	000000		00	Read unlocked page, locking not correctly executed
	000000		01	Programming done, but possibly not reliable
	000000		10	Read locked page, but locking possibly not reliable

*) If the status indicates 'Reserved', the read data cannot be interpreted as identification data.

2.3.3 Write Data Format

The write function is used to transfer commands, addresses and data to the transponder in order to activate certain functions. Writing is started after the charge phase. It is achieved by switching the RF Modules transmitter off and on according to the data bits. The duration of the transmitter deactivation defines whether it is a low bit or a high bit (see section 4.2 for detailed information).

Since the memory of the multipage transponder is structured in multiple pages the reader has to send the write address to the transponder in order to read, program or lock a specified page.

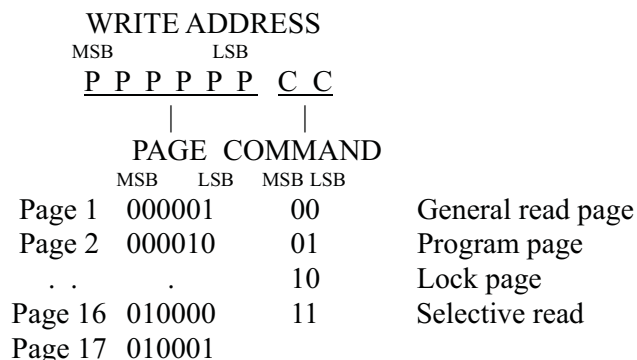

The write address byte consists of a 2-bit command field and a 6-bit page address. The command field which is transmitted first (LSB first), determines the function to be executed in the transponder. The page field defines the affected page.

2.3.3.1 General Read Page

The general read function is applicable to: MPT 0/17 & SAMPT 0/17-24

The general read page function is provided to allow a selected page to be read. Figure 6 shows the data format to be sent to the transponder in order to read a specified page.

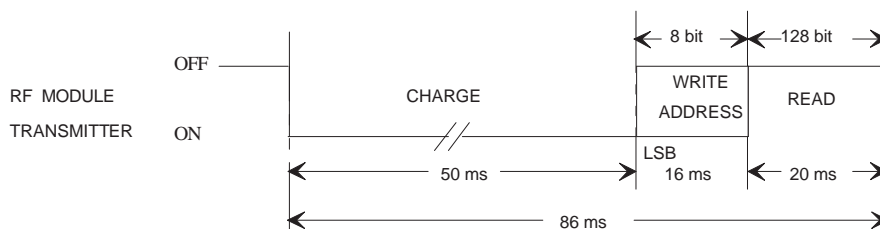

Figure 6. Data Format of the General Read Page Function

For additional information about the write address see section 2.3.3.

Note: If page 1 of an MPT 0/17 is to be read, the page address does not need to be sent. The read phase can start immediately after the charge phase.

If the general read page command is corrupted, the transponder could detect the wrong command. If the number of bits in the write data format are not correct, the transponder discharges its charge capacitor (no response).

After having received the data format of the general read page function the multipage transponder responds with the read data format (see section 2.3.2). Table 1 shows the possible responses. The reader has to check the response and repeat the command if necessary.

Table 1. Responses to General Read Page

WRITE ADDRESS		READ ADDRESS		DESCRIPTION
COMMAND	PAGE	STATUS	PAGE	
General Read Page	x	Read unlocked page	x	General read page of unlocked page x executed
General Read Page	x	Read locked page	x	General read page of locked page x executed
General Read Page	x	Read unlocked page	y	General read page of unlocked page y executed, y>x: write address was not correctly received
General Read Page	x	Read locked page	y	General read page of locked page y executed, y>x: write address was not correctly received
General Read Page	x	Read unlocked page	z	General read page of unlocked page z executed, z<x: max. page or write address was not correctly received
General Read Page	x	Read locked page	z	General read page of locked page z executed, z<x: z=max. page or write address was not correctly received
General Read Page	x	Reserved	x	No identification data in page x
General Read Page	x	Reserved	y	No identification data in page y, y>x: write address was not correctly received
General Read Page	x	Reserved	z	No identification data in page z, z<x: z=max. page or write address was not correctly received
General Read Page	0	No response		Page 0 is not valid

2.3.3.2 Selective Read Page

The selective read function is applicable to: SAMPT 0/17-24 & SAMPTS 0/17-24

In contrast to the general read page function, the selective read page function reads a specified page of a specific multipage transponder by specifying its selective address during the write phase. Figure 7 shows the RF transmitter signal to selectively read a multipage transponder.

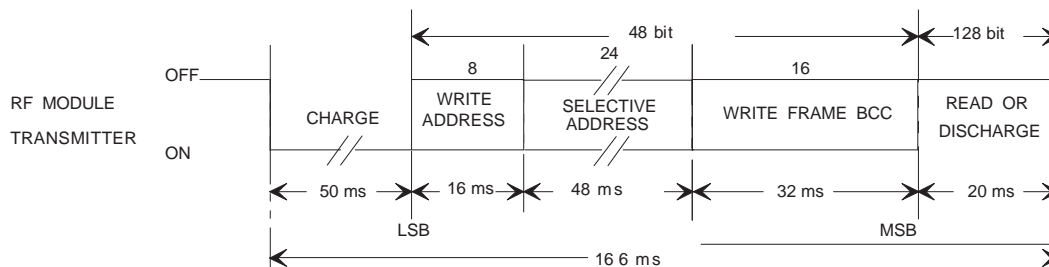

Figure 7. Data Format of the Selective Read Page Function

DESCRIPTION	BITS	VALUE (HEX)		DURATION (ms)	COMMENT
		MSB	LSB		
Write Address	8		pc	16	pc: page + command
Selective Address	24		xxxxxx	48	x: identification of page 1
Write Frame BCC	16		zzzz	32	z: protection data
TOTAL	48			96	

See section 2.3.3 for additional information on the write address.

All parts of the data format must be sent to the transponder with LSB first.

The selective address is compared bitwise with the corresponding bit field of page 1. If all bits match, the selective read page function is executed.

The 16-bit Write Frame Block Check Character (Write FBCC) which protects the write address and the selective address must be generated by the CRC-CCITT algorithm.

The data format of the read page function is checked by the transponder using the hardware CRC Generator. The read page function is executed by the transponder if:

- the selective read page command is detected
- the selective address is O.K.
- the write data format has the correct number of bits
- the write FBCC check is positive

After having received the data format of the selective read page function the multipage transponder responds in the read data format (see section 2.3.2). Table 2 shows the possible responses. The reader has to check the response and repeat the command if necessary.

Table 2. Responses to General Read Page

WRITE ADDRESS		READ ADDRESS		DESCRIPTION
COMMAND	PAGE	STATUS	PAGE	
Selective Read	x	Read unlocked page	x	Selective read page of unlocked page x was executed
Selective Read	x	Read locked page	x	Selective read page of locked page x was executed
Selective Read	x	Read unlocked page	z	Selective read page of unlocked page z was executed, z<x: z=max. page
Selective Read	x	Read locked page	z	Selective read page of locked page z was executed, z<x: z=max. page
Selective Read	x	Reserved	x	Selective read page of page x was executed. No identification data in page x
Selective Read	x	Reserved	z	Selective read page of page z was executed. No identification data in page z, z<x: z=max. page
Selective Read	x	No response		Selective read page was not executed, because a CRC or framing error occurred or the selective address was not valid during write function
Selective Read	0	No response		page 0 is not valid

2.3.3.3 Program Page

The program page function is applicable to: MPT 0/17

The program page function is used to program the write data into a specified page of a multipage transponder. For that purpose the following data format must be sent to the transponder with LSB first.

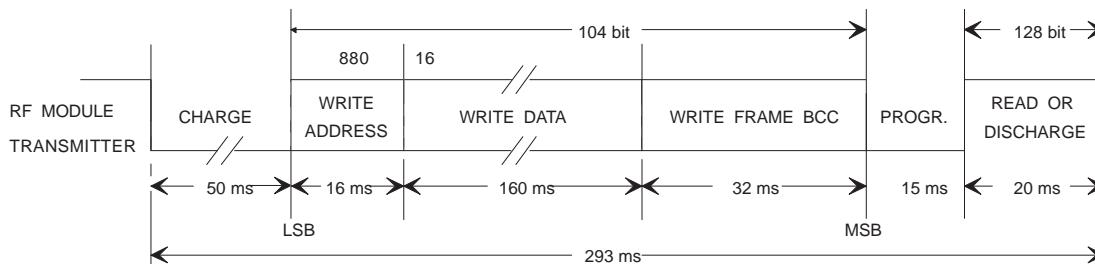

Figure 8. Data Format of the Program Page Function

DESCRIPTION	BITS	VALUE (HEX)		DURATION (ms)	COMMENT
		MSB	LSB		
Write Address	8		pc	16	pc: page + command
Write Data	80	yyyyxxxxxxxxxxxxxxxx	x	160	x: identification data & protection data
Write Frame BCC	16		zzzz	32	z: protection data
TOTAL	104			208	

For additional information on the write address see section 2.3.3.

The 80 bit write data split into 64 identification data bits and 16 protection data bits (DBCC) must be transmitted consecutively.

Because it provides optimum data security, CRC-CCITT is used as protection algorithm for the calculation of the DBCC and the 16-bit Write Frame Block Check Character (Write FBCC), which protects the write address and the write data.

The multipage transponder checks the received data using a hardware CRC Generator. The program page function is executed if:

- the program page command is detected
- the write data format has the correct number of bits
- the write FBCC check is OK
- the RF field strength is high enough to generate a reliable programming voltage

After having received the data format of the program page function the multipage transponder responds in the read data format (see section 2.3.2). Table 3 shows the possible responses. The reader has to check the response and repeat the command if necessary.

Table 3. Responses to Program Page

WRITE ADDRESS		READ ADDRESS		DESCRIPTION
COMMAND	PAGE	STATUS	PAGE	
Program Page	x	Programming done	x	Programming of page x correctly executed
	x			
Program Page	x	Programming done	0	Programming of page x executed, but probably not reliable
Program Page	x	Read locked page	x	Programming of locked page x not executed
Program Page	x	Read unlocked page	x	Programming of unlocked page x not executed, RF field strength too low
Program Page	x	No response		Programming not executed because of CRC error or framing error
Program Page	x	Read unlocked page	z	Programming not executed, z<x: page x not available, page z = max. page and is unlocked
Program Page	x	Read locked page z	x	Programming not executed, z<x: page x not available, page z = max. page and is locked
Program Page	x	Reserved	z	No identification data in page x
Program Page	x	Reserved	z	No identification data in page z, z<x: z=max. page
Program Page	0	No response		Page 0 is not valid

Function

2.3.3.4 Selective Program Page

The selective program page function is applicable to: SAMPT 0/17-24 & SAMPTS 0/17-24

In contrast to the program page function, the selective program page function programs the write data into a specified page of a specific multipage transponder by giving the transponders selective address during the write phase. For that purpose the following data format must be sent to the transponder with LSB first.

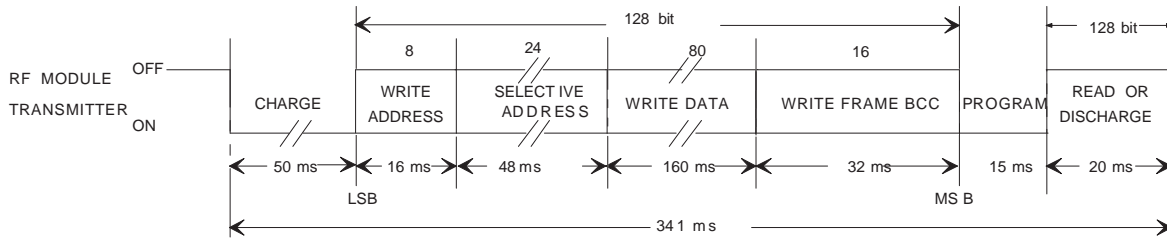

Figure 9. Data Format of the Selective Program Page Function

DESCRIPTION	BITS	VALUE (HEX)		DURATION (ms)	COMMENT
		MSB	LSB		
Write Address	8		pc	16	pc: page + command
Selective Address	24		xxxxxx	48	x: part of identification of page 1
Write Data	80		yyyyxxxxxxxxxxxxxxxxx	160	x: identification data & protection data
Write Frame BCC	16		zzzz	32	z: protection data
TOTAL	128			256	

For additional information on the write address see section 2.3.3.

The selective address is compared bitwise with the corresponding bit field of page 1. If all bits match, the selective program page function is executed.

The 80 bit write data split into 64 identification data bits and 16 protection data bits (DBCC) must be transmitted consecutively.

Because it provides optimum data security, CRC-CCITT is used as protection algorithm for the calculation of the DBCC and the 16-bit Write Frame Block Check Character (Write FBCC), which protects the write address, the selective address and the write data.

The multipage transponder checks the received data using a hardware CRC Generator. The selective program page function is executed if:

- the program page command is detected
- the selective address is OK
- the write data format has the correct number of bits
- the write FBCC check is OK
- the RF field strength is high enough to generate a reliable programming voltage

After having received the data format of the selective program page function the multipage transponder responds in the read data format (see section 2.3.2). Table 4 shows the possible responses. The reader has to check the response and repeat the command if necessary.

Table 4. Responses to Selective Program Page

WRITE ADDRESS		READ ADDRESS		DESCRIPTION
COMMAND	PAGE	STATUS	PAGE	
Program Page	x	Programming done	x	Programming of page x correctly executed
Program Page	x	Programming done	0	Programming of page x executed, but probably not reliable
Program Page	x	Read locked page	x	Programming of locked page x not executed
Program Page	x	Read unlocked page	x	Programming of unlocked page x not executed, RF field strength too low
Program Page x	x	No response		Programming not executed because of CRC error, framing error or wrong selective address
Program Page	x	Read unlocked page	z	Programming not executed, z<x: page x not available, page z = max. page and is unlocked
Program Page	x	Read locked page	z	Programming not executed, z<x: page x not available, page z = max. page and is locked
Program Page	x	Reserved	x	No identification data in page x
Program Page	x	Reserved	z	No identification data in page z, z<x: z=max. page
Program Page	0	No response		Page 0 is not valid

Function

2.3.3.5 Lock Page

The lock page function is applicable to: MPT 0/17

The lock page function is used to lock the content of a specified page of a multipage transponder. For that purpose the following data format must be sent to the transponder with LSB first.

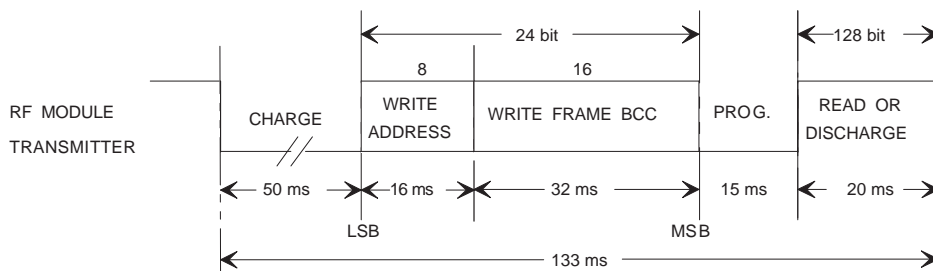

Figure 10. Data Format of the Lock Page Function

DESCRIPTION	BITS	VALUE (HEX)		DURATION (ms)	COMMENT
		MSB	LSB		
Write Address	8		pc	16	pc: page + command
Write Frame BCC	16		zzzz	32	z: protection data
TOTAL 128	24			48	

For additional information on the write address see section 2.3.3.

The 16-bit Write Frame Block Check Character (Write FBCC) which protects the write address must be generated by the CRC-CCITT algorithm.

The data format of the lock page function is checked by the transponder using the hardware CRC Generator. The lock page function is executed by the transponder if:

- the lock page command is detected
- the write data format has the correct number of bits
- the write FBCC check is positive
- the RF field strength is high enough to generate reliable programming voltage

After having received the data format of the lock page function the multipage transponder responds in the read data format (see section 2.3.2). Table 5 shows the possible responses. The reader has to check the response and repeat the command if necessary.

Table 5. Responses to Lock Page

WRITE ADDRESS		READ ADDRESS		DESCRIPTION
COMMAND	PAGE	STATUS	PAGE	
Lock Page	x	Read locked page	x	Locking of page x correctly executed
Lock Page	x	Read locked page	0	Locking of page x executed, but probably not reliable
Lock Page	x	No response		Locking not executed, because of CRC error or framing error
Lock Page	x	Read unlocked page	x	Locking of page x not executed, RF field strength too low. Page is not locked
Lock Page	x	Read unlocked page	0	Locking of page x not executed because field strength dropped. Page is not locked
Lock Page	x	Read unlocked page	z	Read unlocked page z, z<x: page x not available. z = max. page. Lock page was not executed
Lock Page	x	Read locked page	z	Read locked page z, z<x: page x not available. z = max. page. Lock page was not executed
Lock Page	x	Reserved	x	No identification data in page x
Lock Page	x	Reserved	z	No identification data in page z, z<x, z=max. page
Lock Page	0	No response		Page 0 is not valid

2.3.3.6 Selective Lock Page

The selective lock page function is applicable to: SAMPT 0/17-24 & SAMPTS 0/17-24

In contrast to the lock page function, the selective lock page function locks a specified page of a specific multipage transponder by giving the transponder's selective address during the write phase. For that purpose the following data format must be sent to the transponder with LSB first.

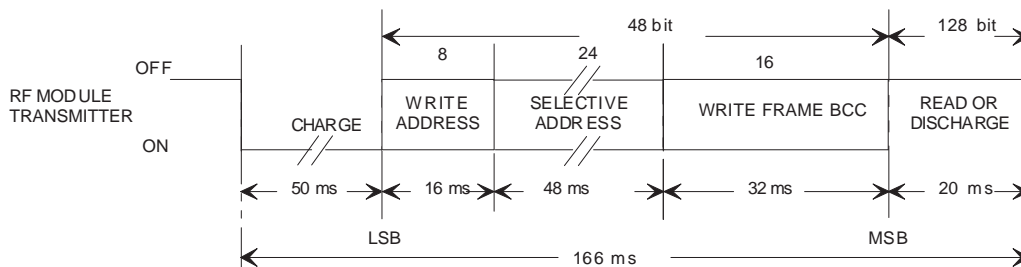

Figure 11. Data Format of the Selective Lock Page Function

DESCRIPTION	BITS	VALUE (HEX)		DURATION (ms)	COMMENT
		MSB	LSB		
Write Address	8		pc	16	pc: page + command
Selective Address	24		xxxxxx	48	x: part of identification of page 1
Write Frame BCC	16		zzzz	32	z: protection data
TOTAL	48			96	

For additional information on the write address see section 2.3.3.

The selective address is compared bitwise with the corresponding bit field of page 1. If all bits match, the selective lock page function is executed.

The 16-bit Write Frame Block Check Character (Write FBCC) which protects the write address and the selective address must be generated by the CRC-CCITT algorithm.

The data format of the selective lock page function is checked by the transponder using the hardware CRC Generator. The selective lock page function is executed by the transponder if:

- the lock page command is detected
- the selective address is OK
- the write data format has the correct number of bits
- the write FBCC check is positive
- the RF field strength is high enough to generate reliable programming voltage

After having received the data format of the selective lock page function the multipage transponder responds in the read data format (see section 2.3.2). Table 6 shows the possible responses. The reader has to check the response and repeat the command if necessary.

Table 6. Responses to Selective Lock Page

WRITE ADDRESS		READ ADDRESS		DESCRIPTION
COMMAND	PAGE	STATUS	PAGE	
Lock Page	x	Read locked page	x	Locking of page x correctly executed
Lock Page	x	Read locked page	0	Locking of page x executed, but probably not reliable
Lock Page	x	No response		Locking not executed, because of CRC error, framing error or wrong selective address
Lock Page	x	Read unlocked page	x	Locking of page x not executed, RF field strength too low. Page is not locked
Lock Page	x	Read unlocked page	0	Locking of page x was not executed because field strength dropped. Page is not locked
Lock Page	x	Read unlocked page	z	Read unlocked page z, z<x: page x not available. z = max. page. Lock page was not executed
Lock Page	x	Read locked page	z	Read locked page z, z<x: page x not available. z = max. page. Lock page was not executed
Lock Page	x	Reserved	x	No identification data in page x
Lock Page	x	Reserved	z	No identification data in page z, z<x, z=max. page
Lock Page	0	No response		Page 0 is not valid

3 EMI/EMC Performance

3.1 General

For any given RF-ID system, the EMI/EMC performance is determined by three factors:

1. The reader design and the resulting noise immunity performance.
2. The signal strength of the transponder and Signal/Noise ratio at the receiver input.
3. The transponder immunity to EM fields:
 - The most critical EMI factor or component in a system is the reader immunity.
 - A high transponder data signal facilitates reader design through the higher Signal/Noise ratio.
 - The least critical component is the transponder. Immunity levels are generally very high.

All EMI sources can be classified into three different categories:

- Broad band "industrial" noise of sporadic or continuous nature.
- Discrete radio frequency signals unmodulated or FM /FSK modulated.
- Discrete radio frequency signals which are AM or ASK modulated.

3.2 CE Declaration



CE–Declaration

The products described in this document comply fully with the European EMC directive 89/336/EEC as tested according to pr ETS 300 683.

3.3 TIRIS™ System Performance

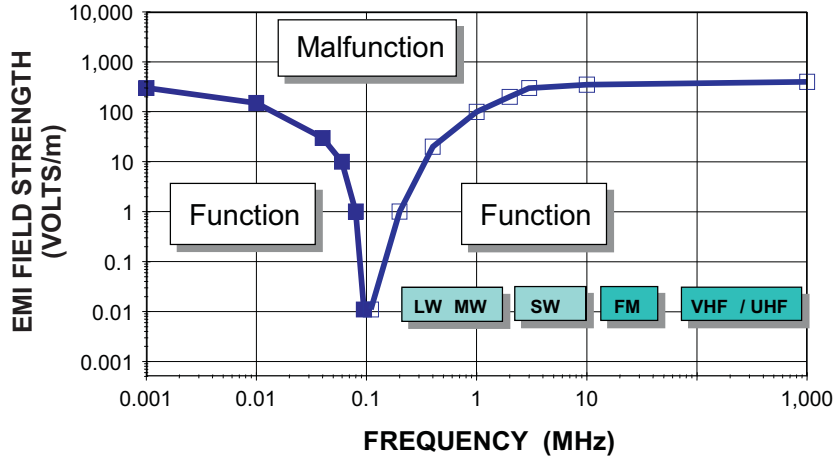

Figure 12. TIRIS System Immunity over a Spectrum of 6 Decades

The graph shows the EMI Immunity level in V/m as function of the frequency range from 1 kHz to 1000 MHz. Measurement condition: minimum 90% read probability at maximum read range, using a standard TIRIS reader.

4 Read and Write Principle

This section describes the modulation principle used in the transponder for sending out its telegram (read) as well as the principle for sending data to the transponder (write, or program).

4.1 Read

After reading, programming or locking of a specified page, the transponder sends out its protocol using FSK modulation.

The typical data low bit frequency is 134.2 kHz, the typical data high bit frequency is 123.2 kHz. The low and high bits have different durations, because each bit takes 16 RF cycles to transmit. The high bit has a typical duration of 129.2 μ s, the low bit of 119.9 μ s. Figure 13 shows the FM principle used.

Data encoding is done in NRZ mode (Non Return to Zero). The clock is derived from the RF carrier by a divide-by-16 function.

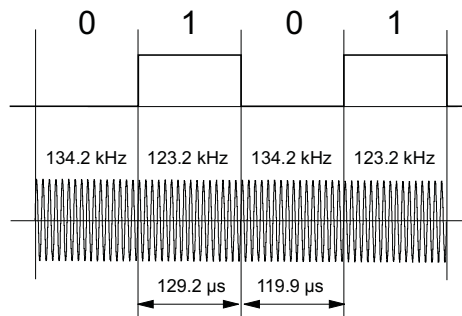

Figure 13. FM Principle Used for the Read Function of TIRIS Transponders

4.2 Write and Program

The write function is used to transfer commands, addresses and data to the transponder in order to activate certain functions. Writing is started after the charge phase (RF transmitter on for 15..50 ms using a frequency of 134,2 kHz), it is achieved by switching the RF Module's transmitter off and on according to the data bits. Modulation index of this amplitude modulation is 100%.

A write bit has a typical duration of $t_{bit} = 2$ ms. The duration of the transmitter deactivation (pulse width) defines whether it is a low bit or a high bit. During a high bit the transmitter is deactivated for t_{offH} and activated afterwards for t_{onH} . During a low bit the transmitter is deactivated for t_{offL} and activated afterwards for t_{onL} . Figure 14 shows the RF Modules transmitter during write and program function.

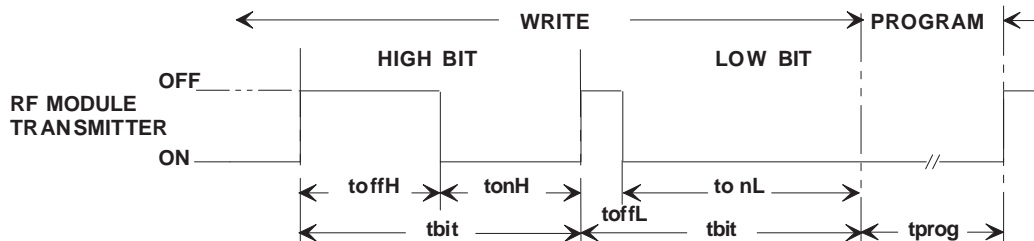
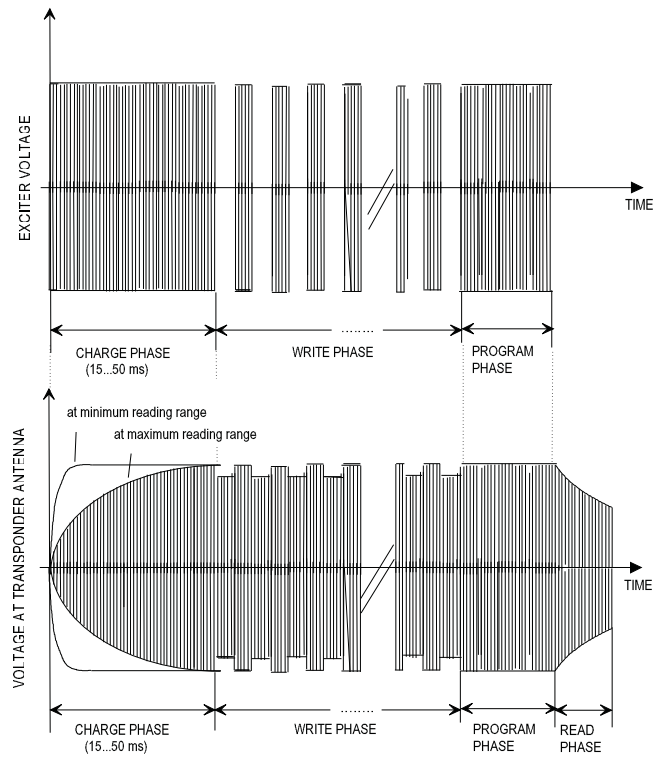

Figure 14. Write and Program Function

Figure 15 describes the write and programming function by showing the transmitter output signal and the transponder RF input signal.



- Charge: Continuous RF Module Transmitter output Signal
- Write: Pulse width modulation of the RF module transmitter output signal
- Program: Continuous RF module transmitter output signal
- Read: Frequency Shift Keying of the transponder resonant circuit oscillation

Figure 15. Charge, Write and Program principle used for TIRIS, Showing the Voltage at the Exciter (Reader) and Transponder Antenna Coil

5 Measurement Set-Ups

This section describes typical measurement set-ups that can be used to determine transponder relevant data such as: resonant frequency, bandwidth, quality factor, powering field strength and transponder signal field strength as listed in the relevant Package Product Parameters under "Recommended Operating Conditions".

For the examples and figures here we have used a 32 mm Glass Transponder as a representative device, but the principles are the same for all package types.

5.1 Measurement Set-Up: Resonance Frequency, Bandwidth, Quality Factor of Transponder

This test set-up is suitable for resonant frequency (f_{res}) measurements as well as the determination of the 3dB bandwidth (Δf) of the transponder. The quality factor Q of the transponder resonance circuit can be calculated with equation (1):

$$Q = \frac{f_{res}}{\Delta f} \quad (1)$$

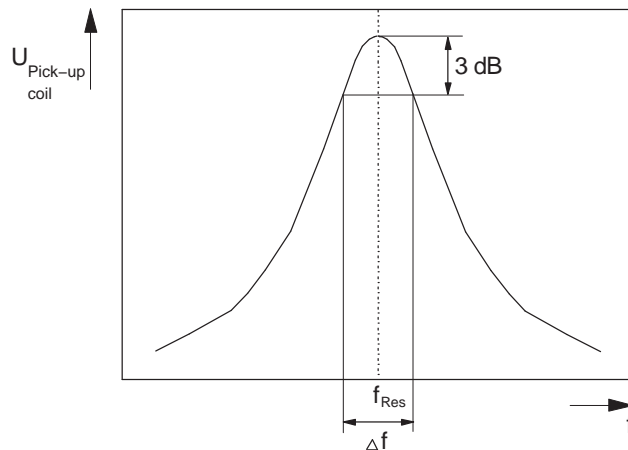

Figure 16. Determination of the Resonance Frequency and -3db Bandwidth by Monitoring the Pick-Up Coil Voltage

The wires of the pick-up coil should be very thin to avoid influence on the measurement results (for example: by damping). The choice of a 1 M. input resistor at the spectrum analyzer is recommended. Figure 17 shows the test set-up. The relation between pick-up coil voltage and frequency is shown in Figure 16.

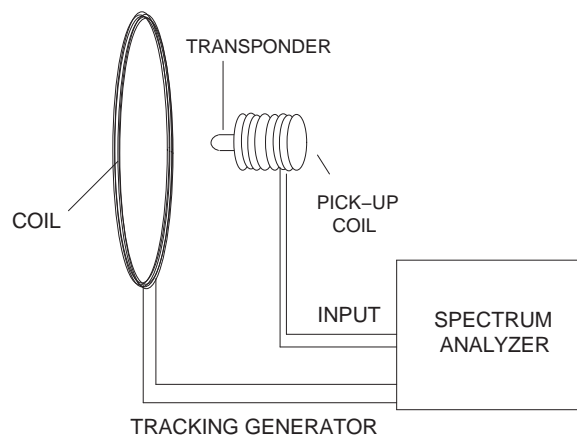

Figure 17. Measurement Set-up for the Determination of Transponder Resonance Frequency, Bandwidth and Quality Factor

5.2 Measurement Set-Up: Powering Field Strength

The following set-up is used to determine the minimum required powering field strength.

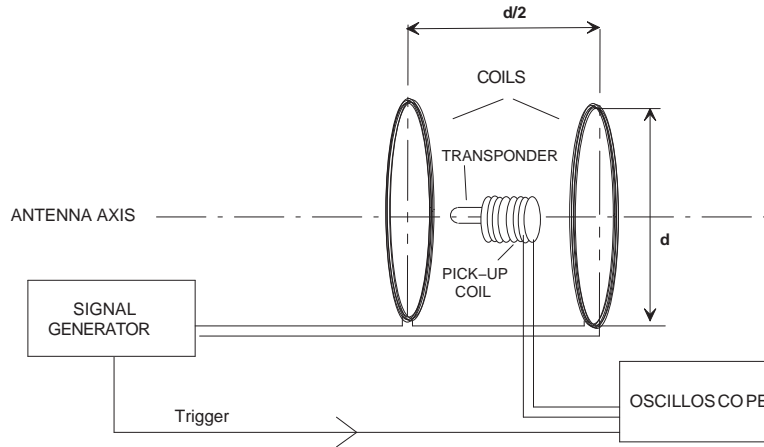

Figure 18. Test Set-up for Powering Field Strength Determination

The field between both serial connected coils is homogeneous, due to the fact that the aperture is built according to the Helmholtz set-up. The circular coils are positioned in parallel on one axis. The distance between the coils is half the coil diameter. The transponder is positioned in the middle of the coil axis.

Determination of the minimum powering field strength is possible by changing the field strength through increasing the coil current. The relation between the generated magnetic flux / field strength and coil current can either be measured with a calibrated field probe, or calculated as follows:

$$B = \frac{4}{5} \cdot \sqrt{\frac{4}{5}} \cdot \frac{\mu_0 \cdot \mu_r \cdot N \cdot I}{d/2} = \mu_0 \cdot \mu_r \cdot H \quad (2)$$

- A B: magnetic flux (Tesla=Wb/m²)
- H: magnetic field strength (/m)
- N: Number of Helmholtz Coil windings
- d: Coil diameter (m)
- I: Coil current (A)
- μ_0 : magnetic field constant (Vs/m) = 4p107 Vs/Am
- μ_r : relative magnetic field constant (in air: =1)

The Helmholtz set-up can be used for the specification of transponders in the temperature range from 40 to +85C. Tests showed, however, that deviations of the field strength caused by temperature are negligible.

The data telegram of the transponder can be captured by a pick-up coil (for example: 10 windings, thin wire to minimize influence) wrapped around the transponder. The pulse modulated signal can be adjusted at the signal generator. The measurement of the power pulse and transponder diagram can be done with the help of an oscilloscope triggered by the generator signal (see Figure 18). As soon as a data telegram is completely detected the minimum necessary field strength (calculated with equation 2) can be monitored.

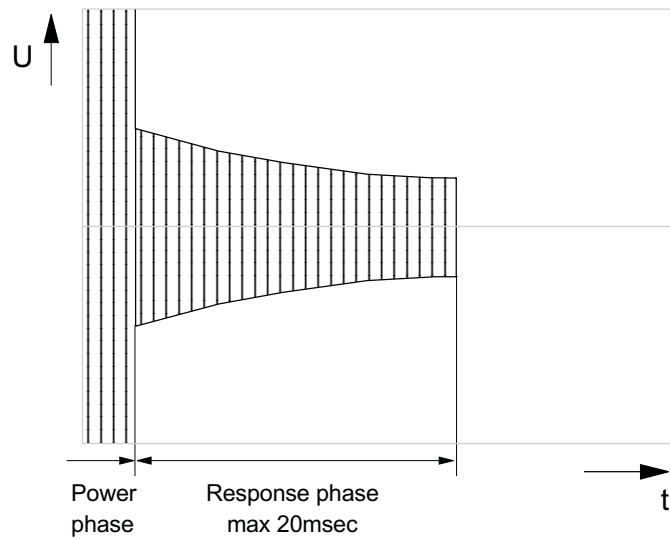

Figure 19. Received Signal at the Pick-up Coil, if Power Field Strength is Sufficient

5.3 Measurement Set-Up: Transponder Signal Strength

The transponder has to be located into a homogeneous field (Helmholtz set-up). The pulsed power signal is generated by a signal generator. A calibrated field strength probe picks up the transponder signal. The field strength can be calculated by using the calibration factor of the field strength probe.

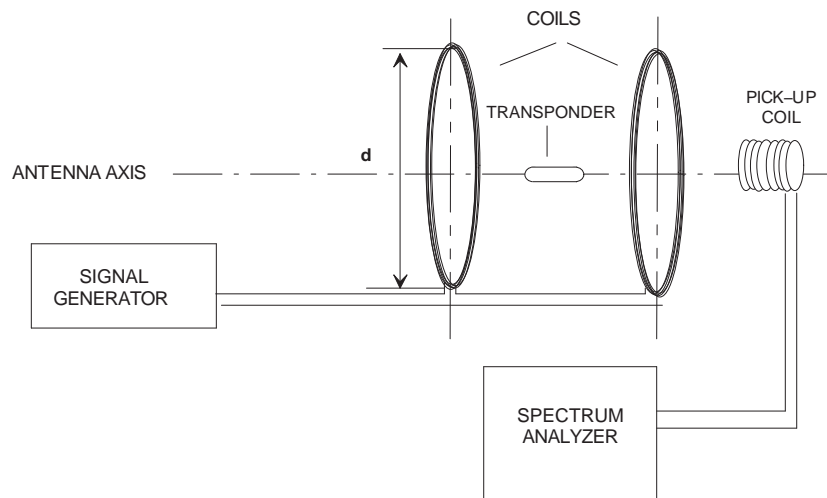

Figure 20. Determination of the Transponder Signal Strength (Data Transmission Signal Strength) with Helmholtz Aperture

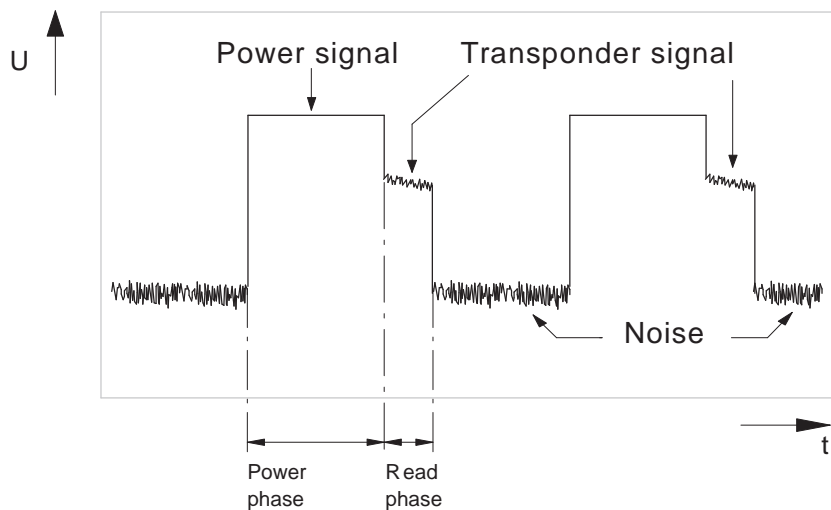

Figure 21. Monitored Signal Voltage at the Spectrum Analyser (Time Domain Mode)

6 General Product Data

6.1 Memory

PARAMETER	DATA
Memory size	1360 bits
Memory organization	17 pages @ 80 bit
Identification data	1088 bit
Error detection (Data BCC)	CRC - CCITT , 16 bit

6.2 Data Retention

For the evaluation of programming endurance and data retention time of user programmable TIRIS multipage transponders the following test sequence has been passed:

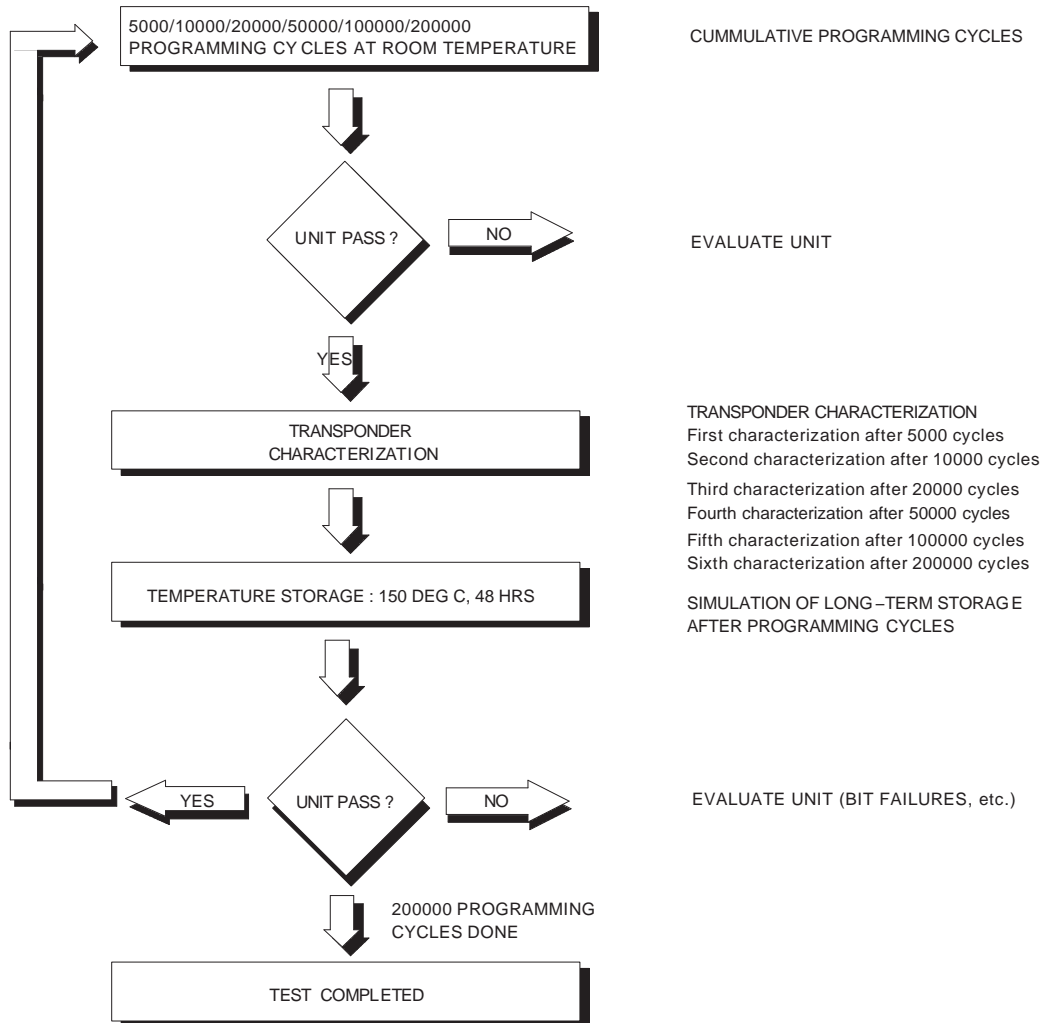

Figure 22.

The following graph shows the equivalent extended data retention time at different ambient temperatures after completion of 100000 programming cycles. Temperature data are derived from measured results at 150 deg C and 48 hrs storage with an acceleration factor of 0.8 eV.

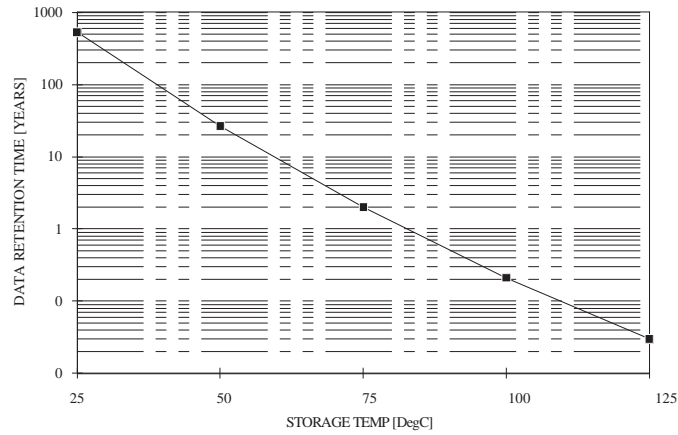

Figure 23.

6.3 ESD

TIRIS transponders are not sensitive to ESD as defined in IEC 801.

Appendix A Conversion Formula

Conversion formula between magnetic flux, magnetic field strength and electric field strength.

$$B = \mu_0 \cdot H$$

$$E = Z_F \cdot H$$

$$H = \frac{E}{dB\mu V \div m} - 51.5 \frac{dB\mu A}{m} ; [H] = \frac{dB\mu A}{m} ; [E] = \frac{dB\mu V}{m}$$

B = Magnetic flux [Tesla = Wb/m² = Vs/m²]; 1 mWb/m² = 0.795 A/m

H = Magnetic field strength (A/m or in logarithmic term dBA/m)

E = Electrical field strength (V/m or in logarithmic term dBV/m)

μ_0 = Magnetic field constant = 1.257 10⁶ Vs/Am

Z_F = Free space impedance = 120 $\pi\Omega$ = 377 Ω

A.1 Abbreviations

BCC — Block Check Character

CRC — Cyclic Redundancy Check

DBCC — Data BCC

EEPROM — Electrical Erasable Programmable Read Only Memory

FBCC — Frame BCC

LSB — Least Significant Bit

MPT — MultiPage Transponder

MSB — Most Significant Bit

RO — Read Only Transponder

R/W — Read/Write Transponder

SAMPT — Selective Programmable Addressable MPT

SAMPTS — Selective Programmable Addressable MPT - Secured

TIRIS — Texas Instruments Registration and Identification System

IMPORTANT NOTICE

Texas Instruments Incorporated and its subsidiaries (TI) reserve the right to make corrections, modifications, enhancements, improvements, and other changes to its products and services at any time and to discontinue any product or service without notice. Customers should obtain the latest relevant information before placing orders and should verify that such information is current and complete. All products are sold subject to TI's terms and conditions of sale supplied at the time of order acknowledgment.

TI warrants performance of its hardware products to the specifications applicable at the time of sale in accordance with TI's standard warranty. Testing and other quality control techniques are used to the extent TI deems necessary to support this warranty. Except where mandated by government requirements, testing of all parameters of each product is not necessarily performed.

TI assumes no liability for applications assistance or customer product design. Customers are responsible for their products and applications using TI components. To minimize the risks associated with customer products and applications, customers should provide adequate design and operating safeguards.

TI does not warrant or represent that any license, either express or implied, is granted under any TI patent right, copyright, mask work right, or other TI intellectual property right relating to any combination, machine, or process in which TI products or services are used. Information published by TI regarding third-party products or services does not constitute a license from TI to use such products or services or a warranty or endorsement thereof. Use of such information may require a license from a third party under the patents or other intellectual property of the third party, or a license from TI under the patents or other intellectual property of TI.

Reproduction of information in TI data books or data sheets is permissible only if reproduction is without alteration and is accompanied by all associated warranties, conditions, limitations, and notices. Reproduction of this information with alteration is an unfair and deceptive business practice. TI is not responsible or liable for such altered documentation.

Resale of TI products or services with statements different from or beyond the parameters stated by TI for that product or service voids all express and any implied warranties for the associated TI product or service and is an unfair and deceptive business practice. TI is not responsible or liable for any such statements.

Following are URLs where you can obtain information on other Texas Instruments products and application solutions:

Products		Applications	
Amplifiers	amplifier.ti.com	Audio	www.ti.com/audio
Data Converters	dataconverter.ti.com	Automotive	www.ti.com/automotive
DSP	dsp.ti.com	Broadband	www.ti.com/broadband
Interface	interface.ti.com	Digital Control	www.ti.com/digitalcontrol
Logic	logic.ti.com	Military	www.ti.com/military
Power Mgmt	power.ti.com	Optical Networking	www.ti.com/opticalnetwork
Microcontrollers	microcontroller.ti.com	Security	www.ti.com/security
Low Power Wireless	www.ti.com/lpw	Telephony	www.ti.com/telephony
		Video & Imaging	www.ti.com/video
		Wireless	www.ti.com/wireless

Mailing Address: Texas Instruments
Post Office Box 655303 Dallas, Texas 75265