

TAS5722L Evaluation Board

This user's guide describes the operation of the TAS5722L Evaluation Board (EVM). The document also provides design information such as schematic, BOM, and PCB layout.

Contents

1	Introduction	2
2	Quick Start Guide	2
3	General Description	5
4	Operating Conditions	5
5	PCB Layout Guidelines	5
6	Reference	6
6.1	TAS5722LEVM Schematic	6
6.2	TAS5722LEVM PCB Layout	8
6.3	TAS5722LEVM Bill of Materials	12

List of Figures

1	TAS5722L Evaluation Board	2
2	Default Jumper Configurations (Top Side)	3
3	Default Jumper Configurations (Bottom Side)	4
4	Default Format	4
5	TAS5722LEVM Schematic (1 of 2).....	6
6	TAS5722LEVM Schematic (2 of 2).....	7
7	Top Overlay	8
8	Top Solder Mask.....	8
9	Top Layer	9
10	Signal Layer 1	9
11	Signal Layer 2	10
12	Bottom Layer.....	10
13	Bottom Solder Mask	11
14	Bottom Overlay	11

List of Tables

1	TAS5722LEVM Default Jumper Settings.....	3
2	EVM Operating Conditions	5
3	TAS5722LEVM BOM	12

1 Introduction

To help investigate and evaluate the TAS5722L performance and capabilities, a fully populated evaluation board has been created. This board is shown in [Figure 1](#). Connected to a PC, an external power supply ($4.5\text{ V} \leq \text{PVDD} \leq 17\text{ V}$), and a signal source, the TAS5722L Evaluation Board easily exercises the features of the amplifier.

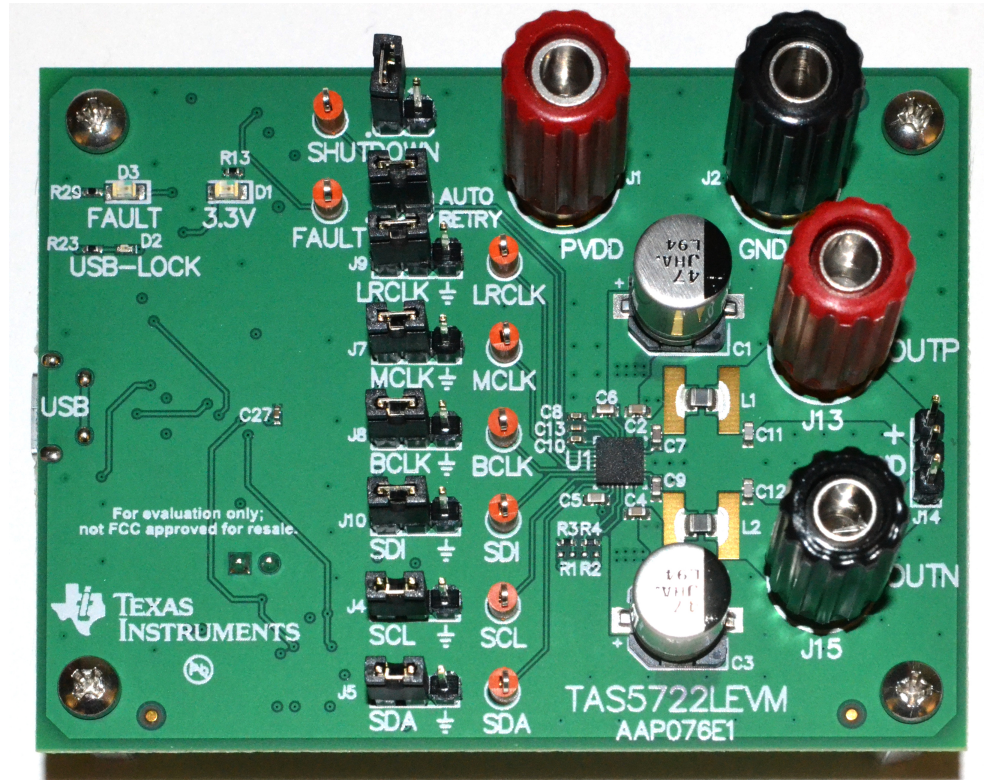

Figure 1. TAS5722L Evaluation Board

2 Quick Start Guide

The following steps are provided as a quick start guide for the EVM.

- Step 1. Make sure all the jumpers are set according to [Table 1](#) and [Figure 2](#) and [Figure 3](#).
- Step 2. Connect the positive and negative output terminals of a speaker to OUTP (RED) and OUTN (BLACK), respectively, on the EVM board.

NOTE: Do not to mix up the OUTP and PVDD terminals since the colors are the same. The same applies to OUTN and GND terminals.

- Step 3. Connect a power supply (4.5 V–17 V) and ground reference to PVDD (RED) and GND (BLACK), respectively, on the EVM board.
- Step 4. Connect a micro USB cable to the EVM and PC to generate 3.3-V supply.
- Step 5. Go to **Control Panel** → **Sound** and select *USB-AudioEVM* under the *Playback* tab. Click on *Set Default* to make it the default playback device. Click on *Properties* and under the *Advanced* tab, make sure that the *Default Format* is shown as *2 channel, 16 bit, 48000 Hz (DVD Quality)* in [Figure 4](#).
- Step 6. Power on the power supply after checking that all the connections are made correctly.
- Step 7. Load a music file in the Microsoft® Windows Media® player. Play that audio file and listen to the output.

Table 1. TAS5722LEVM Default Jumper Settings

Jumper	Position	Comments
J11	OUT	Keep device active
J12	IN	Enable Auto-Retry
J9	Left side	Connect LRCLK to TAS5722L
J7	Left side	Connect MCLK to TAS5722L
J8	Left side	Connect BCLK to TAS5722L
J10	Left side	Connect SDI to TAS5722L
J4	Left side	Connect SCL to TAS5722L
J5	Left side	Connect SDA to TAS5722L
J3	OUT	Write Protection

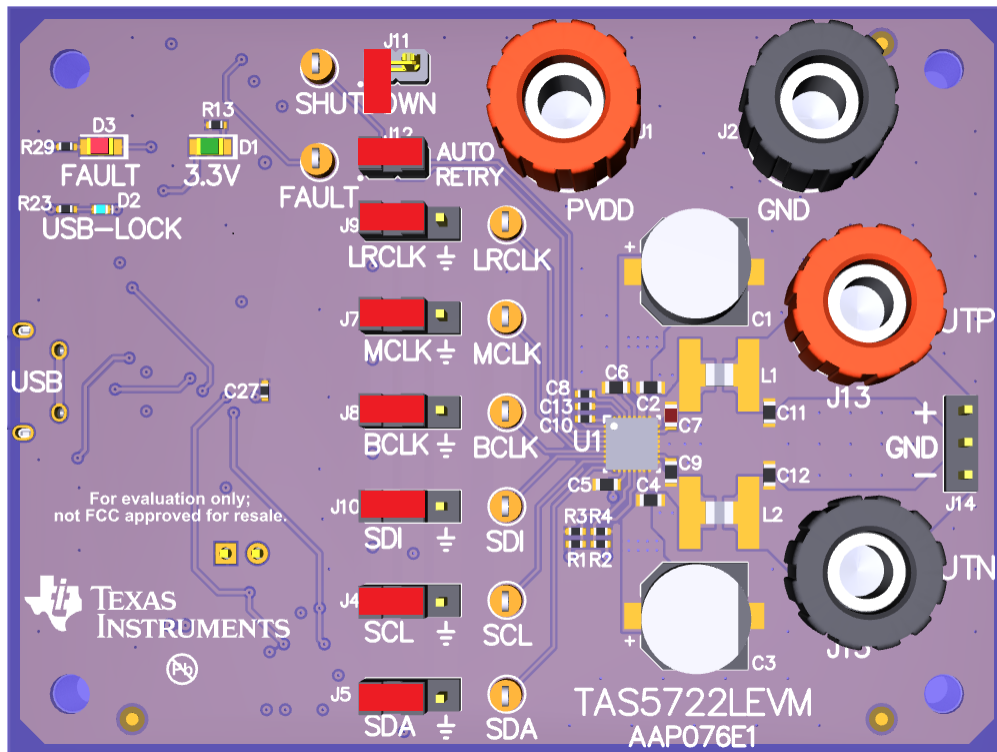

Figure 2. Default Jumper Configurations (Top Side)

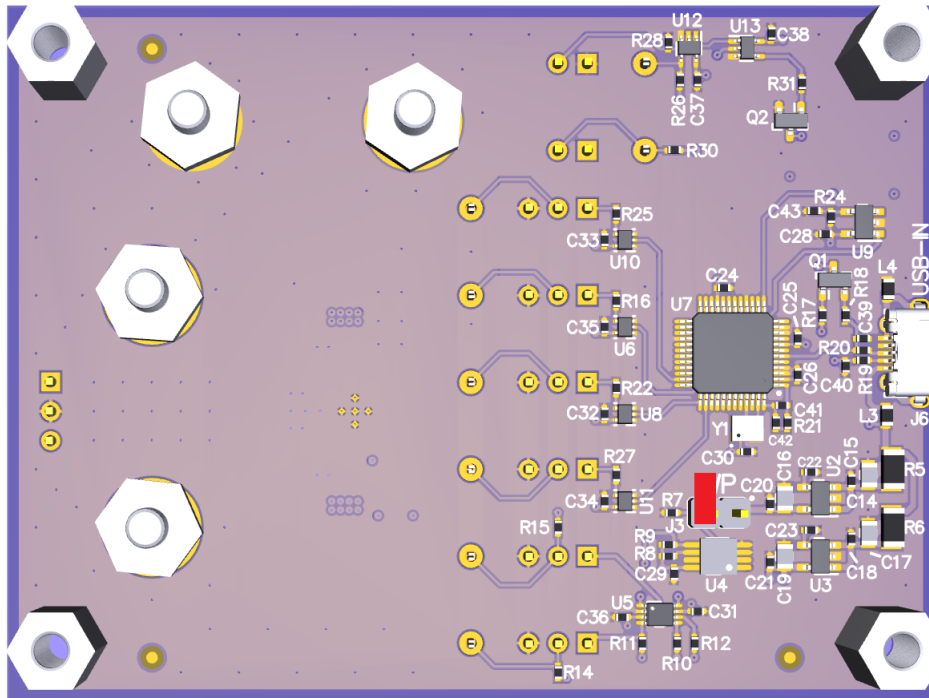

Figure 3. Default Jumper Configurations (Bottom Side)

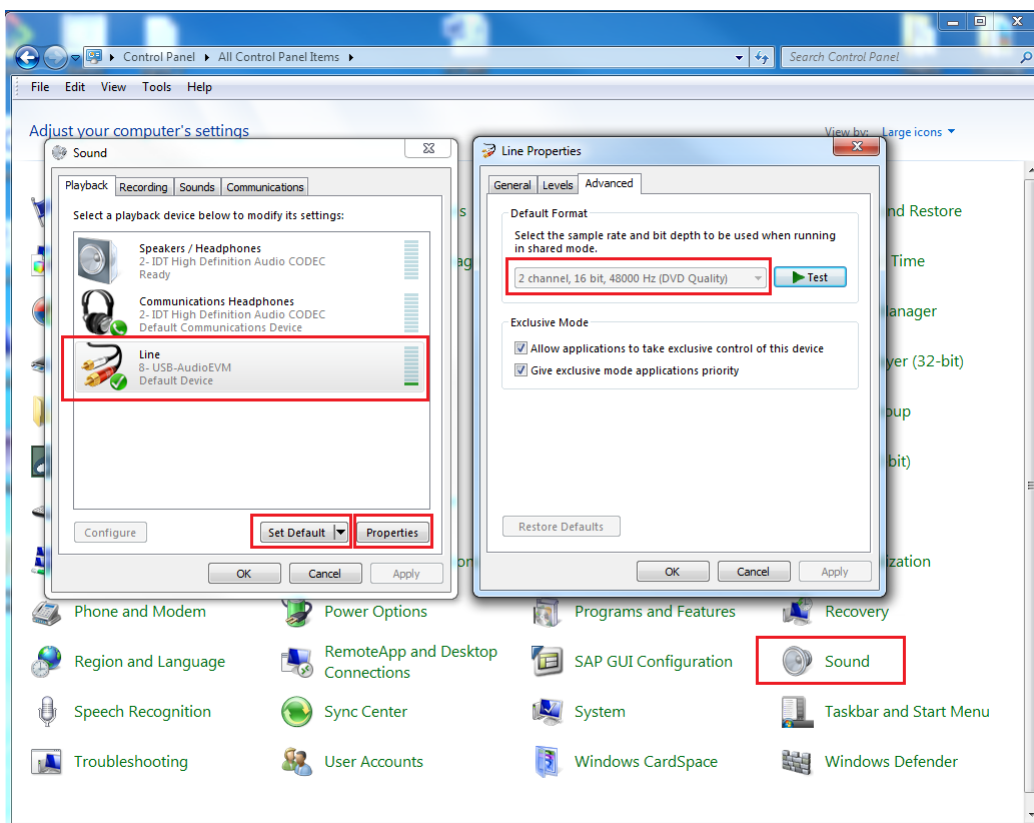

Figure 4. Default Format

3 General Description

The TAS5722L device is a high-efficiency mono Class-D audio power amplifier optimized for high transient power capability to use the dynamic power headroom of small loudspeakers. It is capable of delivering more than 14-W continuously into a 4- Ω speaker. The device has two address pins, which allow up to 8 I²C addressable devices to share a common TDM bus.

The TAS5722L device SAIF supports a variety of standard stereo serial audio formats including I²S, Left justified and Right justified. It also supports a time division multiplexed (TDM) format that is capable of transporting up to 8 channels of audio data on a single bus.

4 Operating Conditions

[Table 2](#) lists the EVM operating conditions.

Table 2. EVM Operating Conditions

Parameter	Operating Condition
PVDD and AVDD	4.5 V to 17 V
DVDD	1.65 V to 2 V
Minimum speaker load	3.2 Ω
I ² C Clock Frequency	Up to 400 kHz

5 PCB Layout Guidelines

Use the following guidelines for PCB layout:

- Pay special attention to the power stage power supply layout. Each H-bridge has two PVDD input pins so that decoupling capacitors can be placed nearby. Use at least a 0.1- μ F capacitor of X5R quality or better for each set of inputs.
- Keep the current circulating loops containing the supply decoupling capacitors, the H-bridges in the device, and the connections to the speakers as tight as possible, to reduce emissions.
- Use ground planes to provide the lowest impedance for power and signal current between the device and the decoupling capacitors. The area directly under the device should be treated as a central ground area for the device, and all device grounds must be connected directly to that area.
- Use a via pattern to connect the area directly under the device to the ground planes in copper layers below the surface. This connection helps to dissipate heat from the device.
- Avoid interrupting the ground plane with circular traces around the device. Interruption disconnects the copper and interrupt flow of heat and current. It is better to use radial copper traces, if necessary.

6 Reference

This section includes the EVM schematic, board layout and BOM.

6.1 TAS5722LEVM Schematic

Figure 5 and Figure 6 illustrate the EVM schematics.

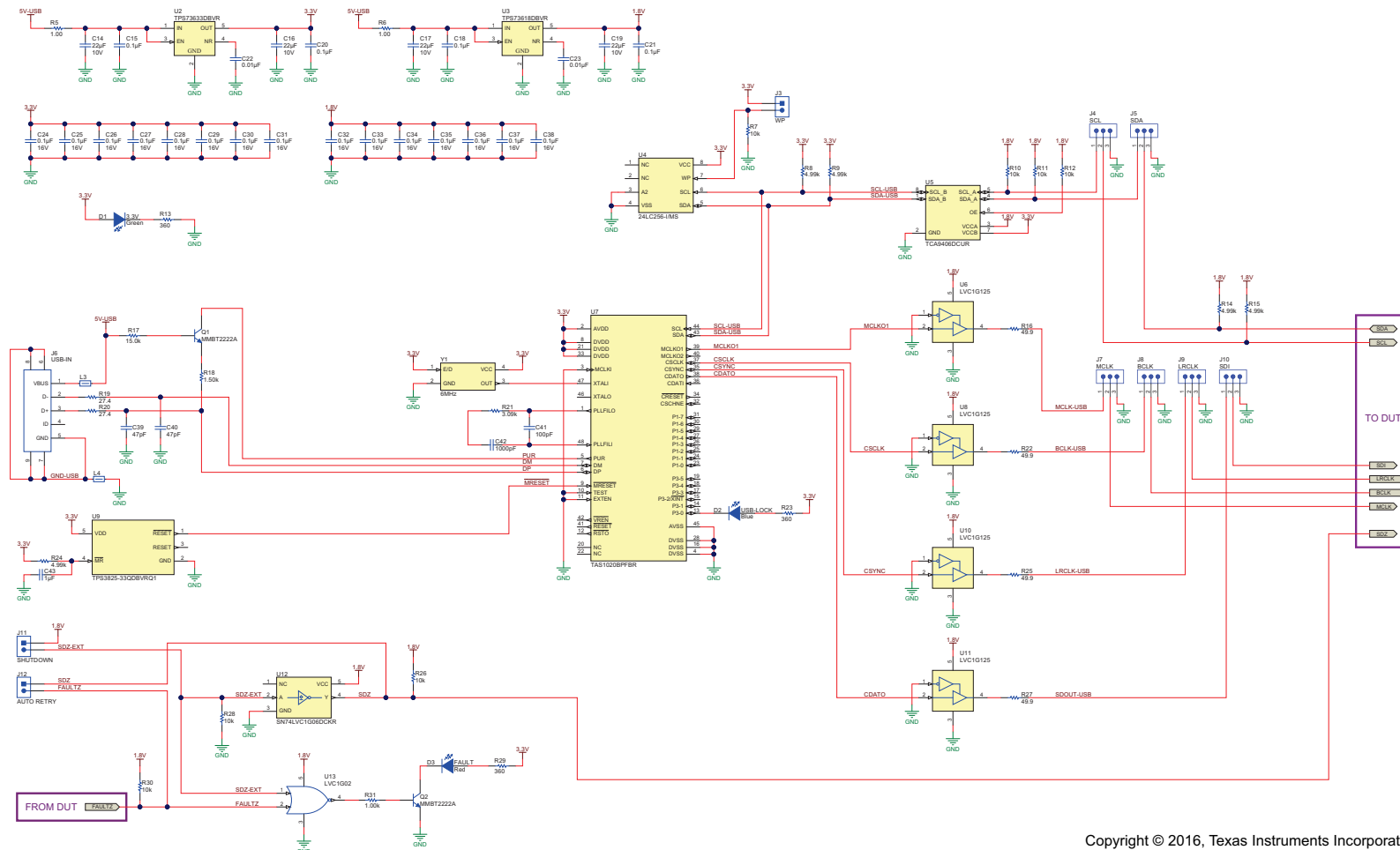

Copyright © 2016, Texas Instruments Incorporated

Figure 5. TAS5722LEVM Schematic (1 of 2)

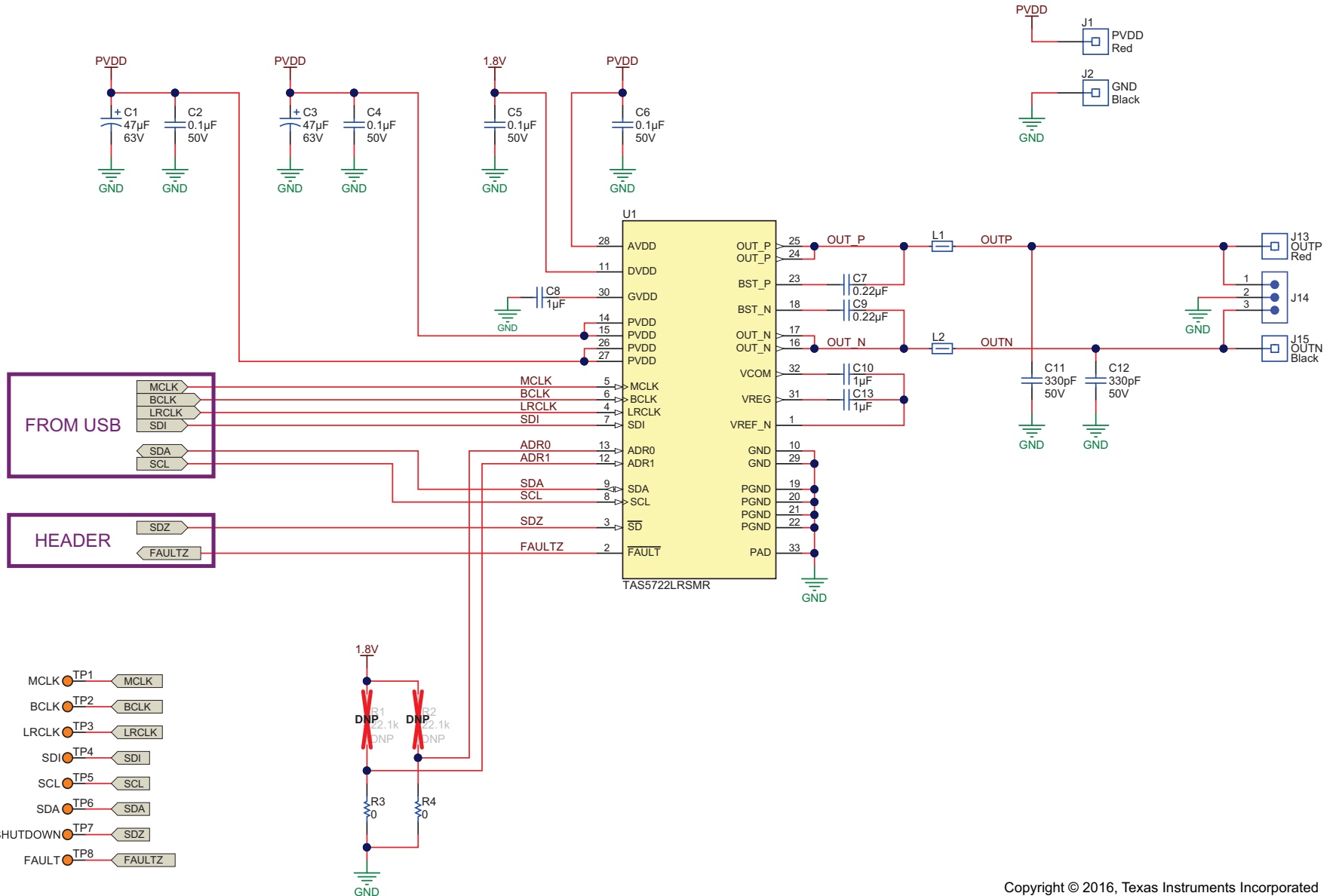

Copyright © 2016, Texas Instruments Incorporated

Figure 6. TAS5722LEVM Schematic (2 of 2)

6.2 TAS5722LEVM PCB Layout

Figure 7 through Figure 14 illustrate the PCB layouts for this EVM.

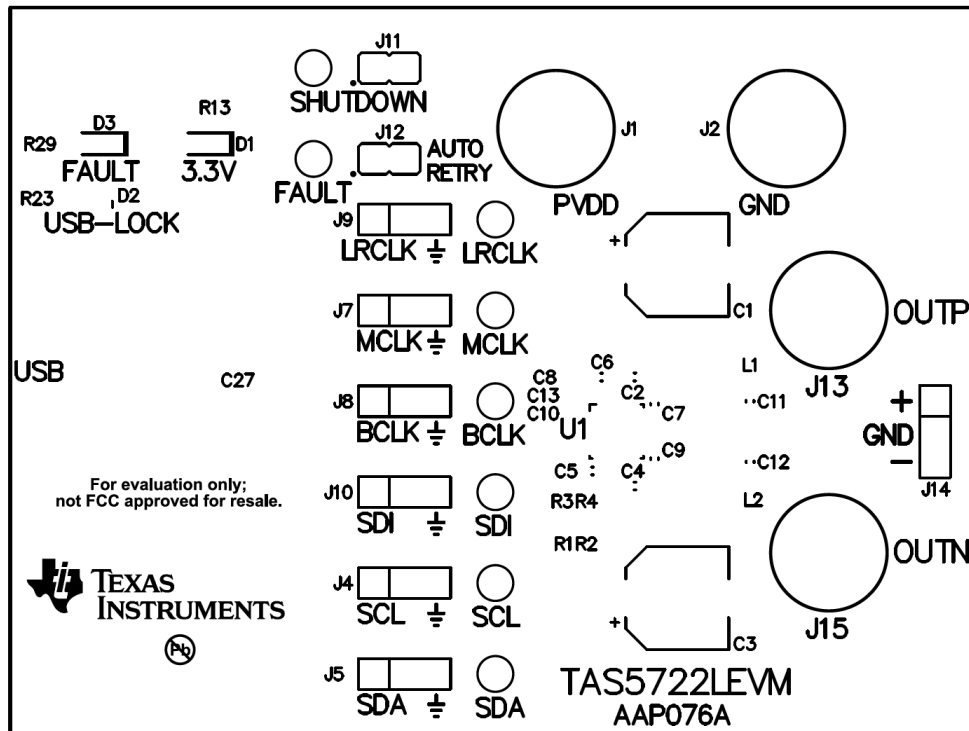

Figure 7. Top Overlay

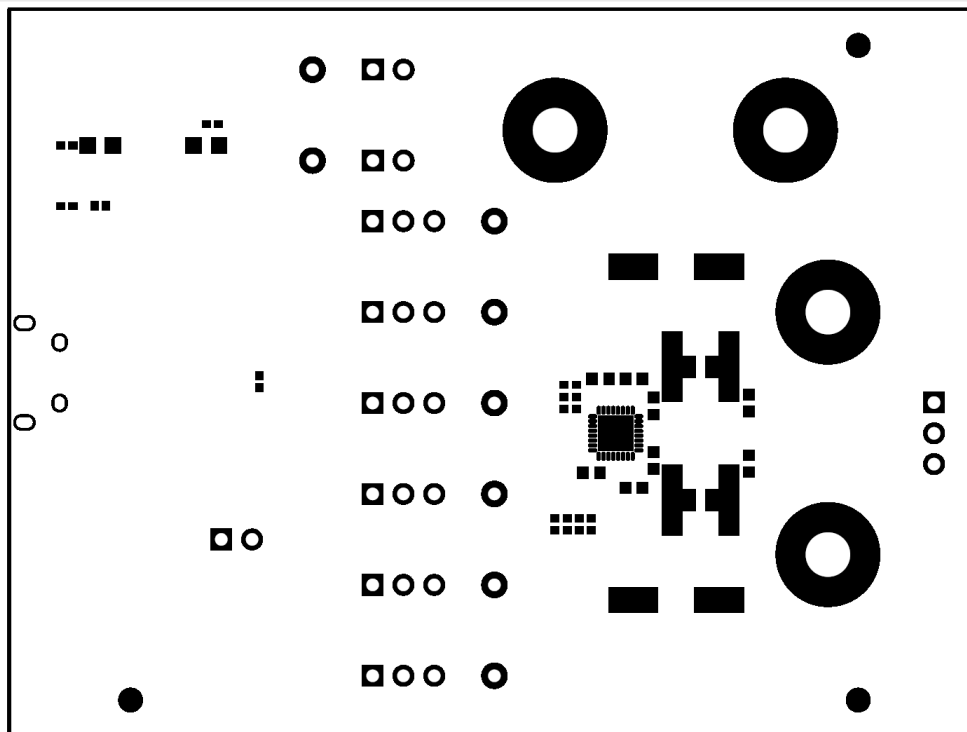

Figure 8. Top Solder Mask

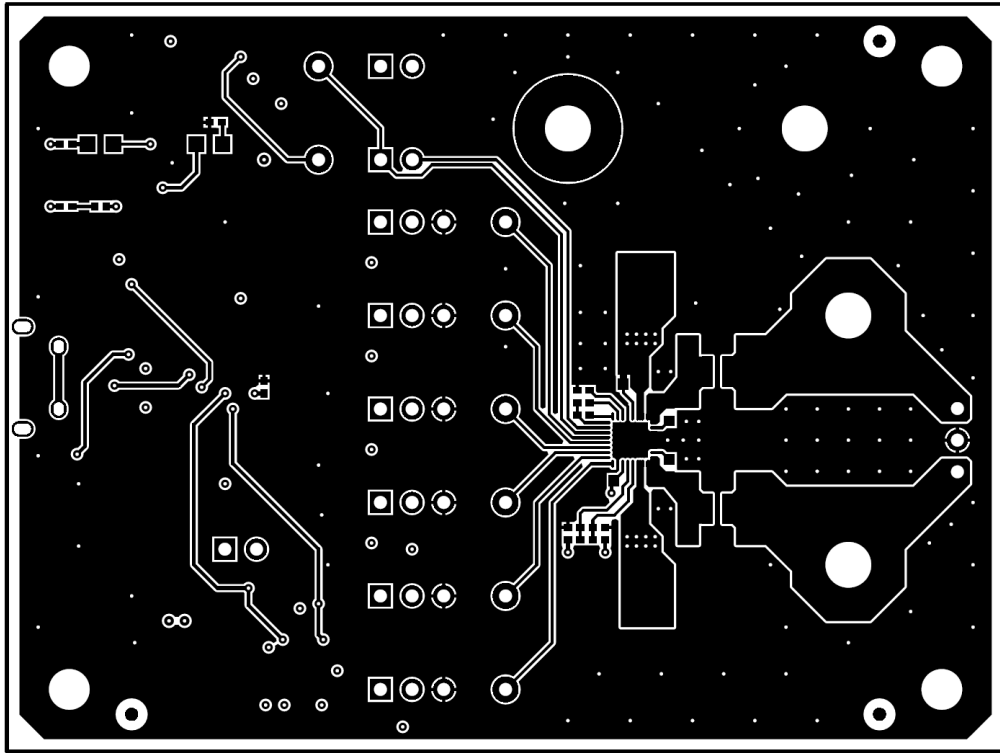

Figure 9. Top Layer

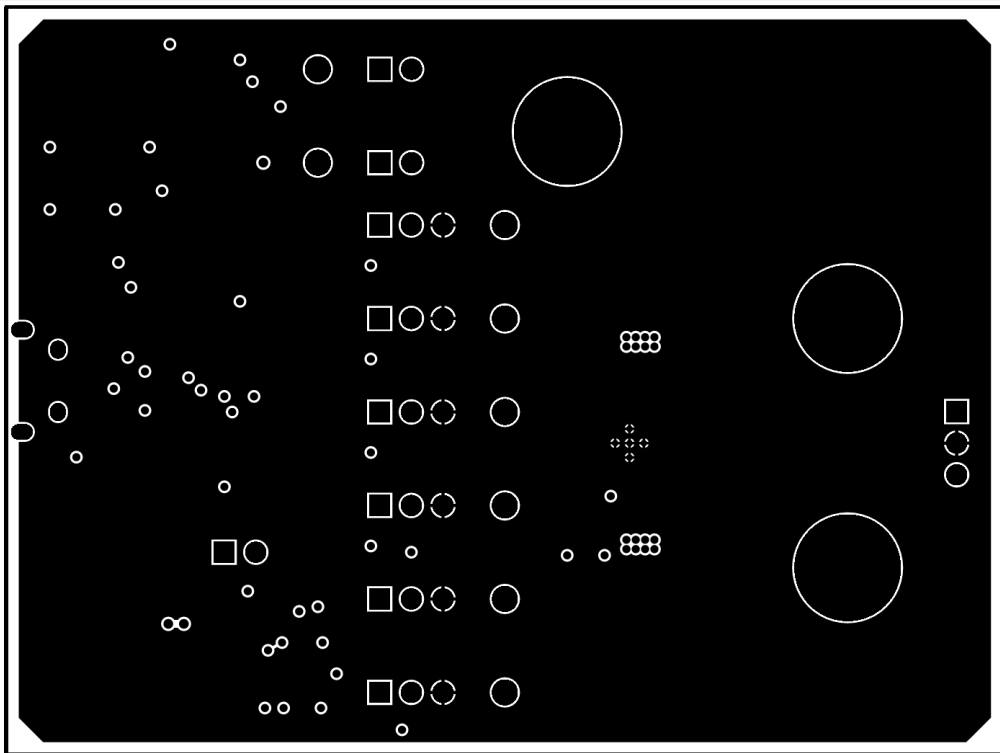

Figure 10. Signal Layer 1

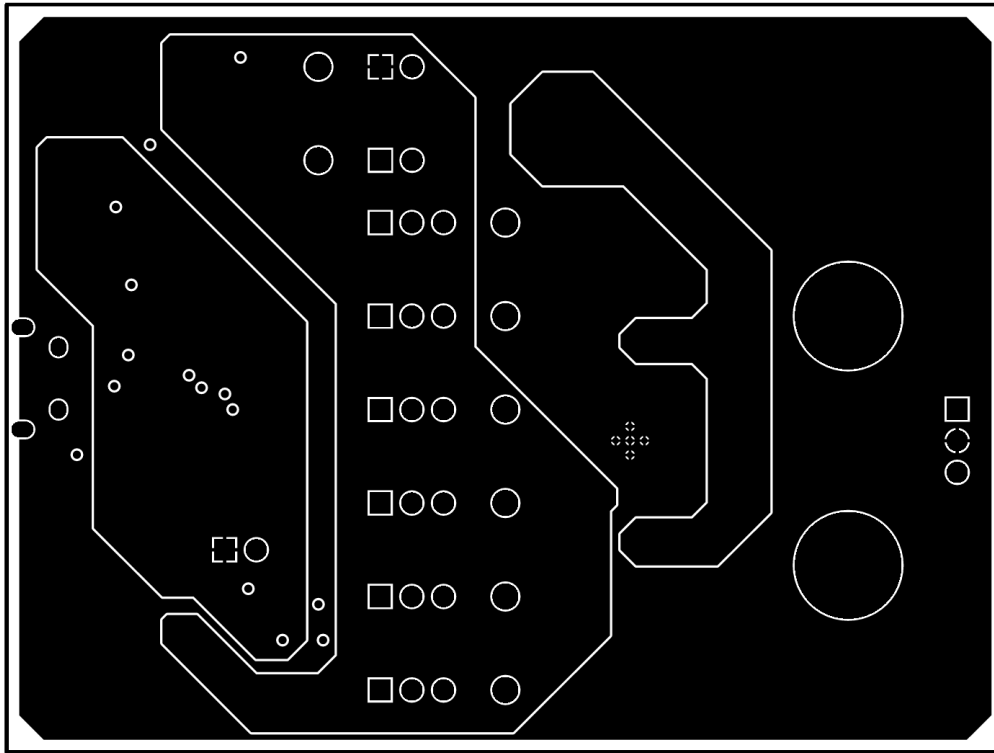

Figure 11. Signal Layer 2

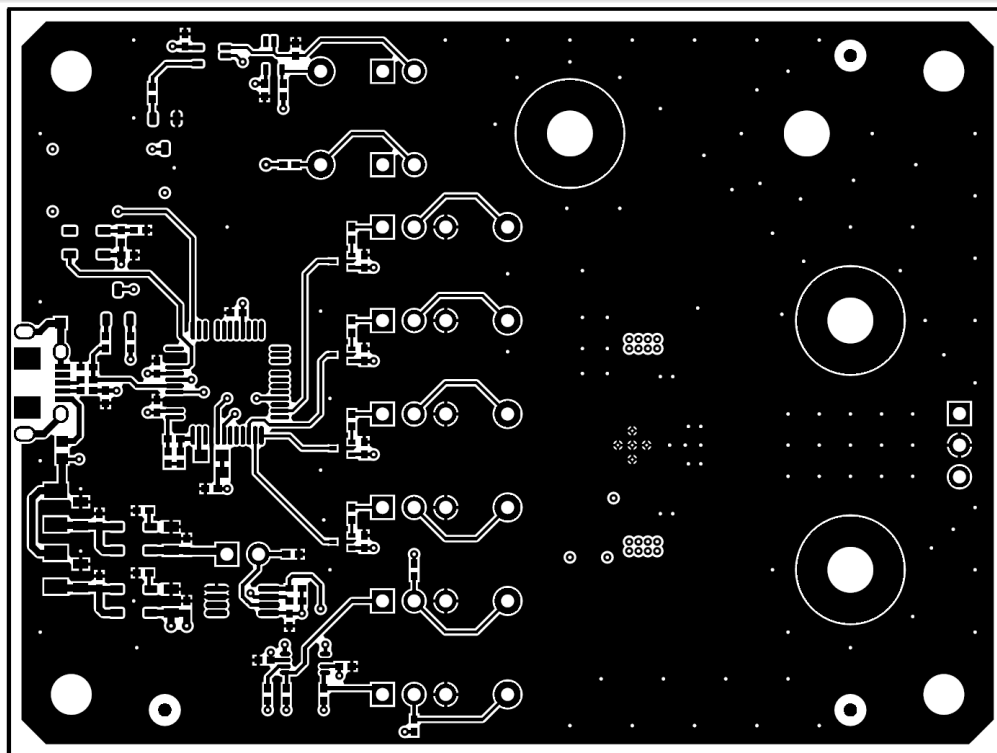

Figure 12. Bottom Layer

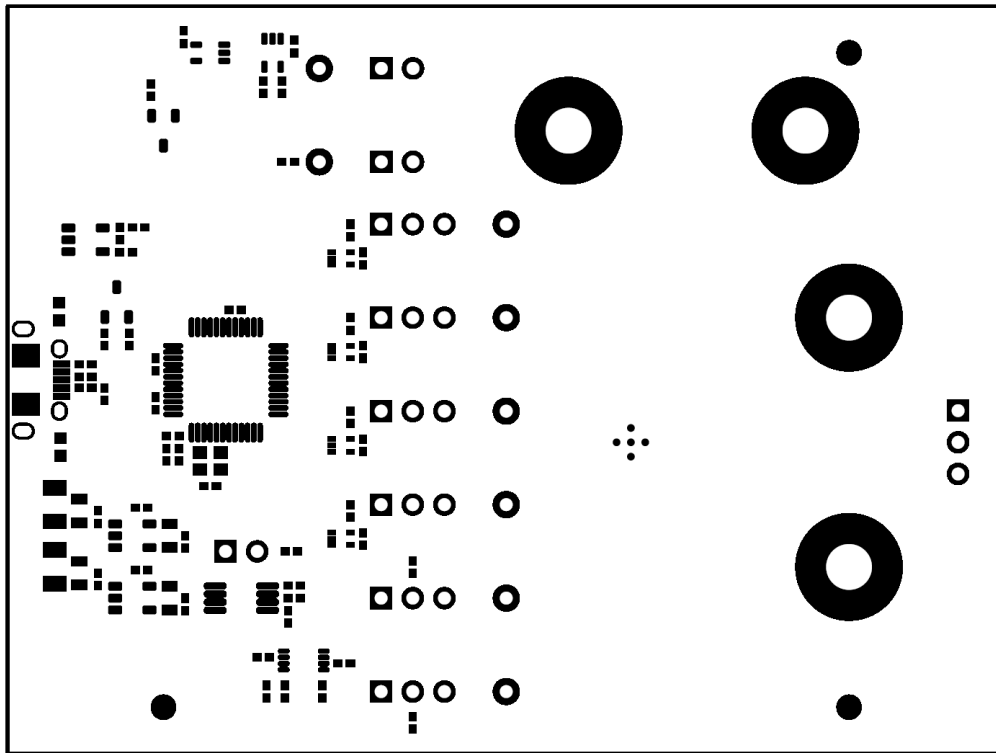

Figure 13. Bottom Solder Mask

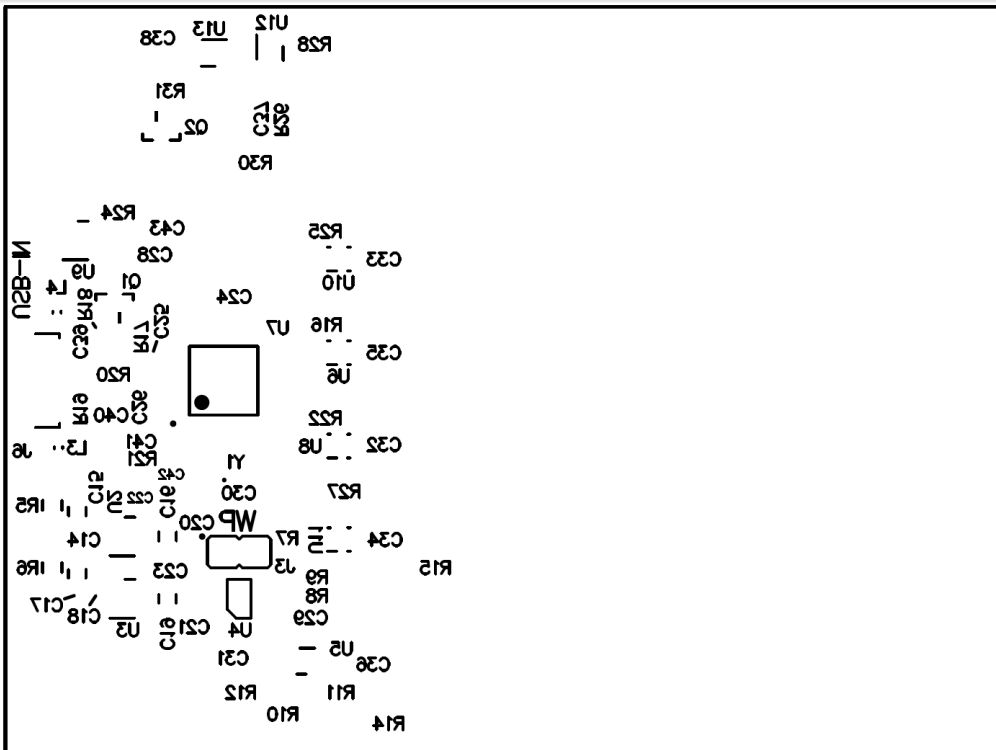

Figure 14. Bottom Overlay

6.3 TAS5722LEVM Bill of Materials

Table 3 lists the TAS5722LEVM BOM.

Table 3. TAS5722LEVM BOM⁽¹⁾

Designator	Qty	Value	Description	Package Reference	Part Number	Manufacturer	Alternate Part Number	Alternate Manufacturer
IPCB1	1		Printed Circuit Board		AAP076	Any	-	-
C1, C3	2	47uF	CAP, AL, 47 µF, 63 V, +/- 20%, AEC-Q200 Grade 2, SMD	D8xL10.2mm	EEE-HA1J470UP	Panasonic		
C2, C4, C5, C6	4	0.1uF	CAP, CERM, 0.1 µF, 50 V, +/- 10%, X7R, 0603	0603	GCM188R71H104KA57D	Murata		
C7, C9	2	0.22uF	CAP, CERM, 0.22 µF, 25 V, +/- 10%, X7R, 0603	0603	GRM188R71E224KA88D	Murata		
C8, C10, C13	3	1uF	CAP, CERM, 1 µF, 16 V, +/- 10%, X5R, 0402	0402	C1005X5R1C105K050BC	TDK		
C11, C12	2	330pF	CAP, CERM, 330 pF, 50 V, +/- 5%, C0G/NP0, 0603	0603	GRM1885C1H331JA01D	Murata		
C14, C16, C17, C19	4	22uF	CAP, CERM, 22 µF, 10 V, +/- 20%, X7R, 0805	0805	GRM21BR61A226ME44L	Murata		
C15, C18, C20, C21	4	0.1uF	CAP, CERM, 0.1 µF, 10 V, +/- 10%, X7R, 0402	0402	GRM155R71A104KA01D	Murata		
C22, C23	2	0.01uF	CAP, CERM, 0.01 µF, 6.3 V, +/- 10%, X7R, 0402	0402	GRM155R70J103KA01D	Murata		
C24, C25, C26, C27, C28, C29, C30, C31, C32, C33, C34, C35, C36, C37, C38	15	0.1uF	CAP, CERM, 0.1 µF, 16 V, +/- 10%, X7R, 0402	0402	GRM155R71C104KA88D	Murata		
C39, C40	2	47pF	CAP, CERM, 47 pF, 25 V, +/- 5%, C0G/NP0, 0402	0402	GRM1555C1E470JA01D	Murata		
C41	1	100pF	CAP, CERM, 100 pF, 50 V, +/- 5%, C0G/NP0, 0402	0402	GRM1555C1H101JA01D	Murata		
C42	1	1000pF	CAP, CERM, 1000 pF, 50 V, +/- 5%, C0G/NP0, 0402	0402	GRM1555C1H102JA01D	Murata		
C43	1	1uF	CAP, CERM, 1 µF, 10 V, +/- 10%, X5R, 0402	0402	C1005X5R1A105K050BB	TDK		
D1	1	Green	LED, Green, SMD	0805 LED	LTST-C171GKT	Lite-On		
D2	1	Blue	LED, Blue, SMD	Blue LED	SMLP12BC7TT86	Rohm		
D3	1	Red	LED, Red, SMD	Red 0805 LED	LTST-C170KRKT	Lite-On		
H1, H2, H3, H4	4		HEX STANDOFF 4-40 ALUMINUM 1/2"	HEX STANDOFF 4-40 ALUMINUM 1/2 inch	2203	Keystone		
H5, H6, H7, H8	4		MACHINE SCREW PAN PHILLIPS 4-40		PMS 440 0038 PH	B&F Fastener Supply		
J1, J13	2		Binding Post, RED, TH	11.4x27.2mm	7006	Keystone		
J2, J15	2		Binding Post, BLACK, TH	11.4x27.2mm	7007	Keystone		
J3, J11, J12	3		Header, 100mil, 2x1, Gold, TH	Sullins 100mil, 1x2, 230 mil above insulator	PBC02SAAN	Sullins Connector Solutions		
J4, J5, J7, J8, J9, J10, J14	7		Header, 100mil, 3x1, Gold, TH	PBC03SAAN	PBC03SAAN	Sullins Connector Solutions		
J6	1		Connector, Receptacle, Micro-USB Type AB, R/A, Bottom Mount SMT	Connector, USB Micro AB	DX4R205JJAR1800	JAE Electronics		
L1, L2	2	180 ohm	Ferrite Bead, 180 ohm @ 100 MHz, 3.4 A, 0806	0806	NFZ2MSM181SN10L	Murata		
L3, L4	2	220 ohm	Ferrite Bead, 220 ohm @ 100 MHz, 2.2 A, 0603	0603	MPZ1608S221A	TDK		
Q1, Q2	2	40 V	Transistor, NPN, 40 V, 0.15 A, SOT-23	SOT-23	MMBT2222A	Fairchild Semiconductor		
R3, R4	2	0	RES, 0, 5%, 0.063 W, 0402	0402	CRCW04020000Z0ED	Vishay-Dale		
R5, R6	2	1.00	RES, 1.00, 1%, 0.25 W, 1206	1206	CRCW12061R00FKEA	Vishay-Dale		

⁽¹⁾ Unless otherwise noted in the *Alternate Part Number* or *Alternate Manufacturer* columns, all parts may be substituted with equivalents.

Table 3. TAS5722LEVM BOM⁽¹⁾ (continued)

Designator	Qty	Value	Description	Package Reference	Part Number	Manufacturer	Alternate Part Number	Alternate Manufacturer
R7, R10, R11, R12, R26, R28, R30	7	10k	RES, 10 k, 5%, 0.063 W, 0402	0402	CRCW040210K0JNED	Vishay-Dale		
R8, R9, R14, R15, R24	5	4.99k	RES, 4.99 k, 1%, 0.063 W, 0402	0402	CRCW04024K99FKED	Vishay-Dale		
R13, R23, R29	3	360	RES, 360, 5%, 0.063 W, 0402	0402	CRCW0402360RJNED	Vishay-Dale		
R16, R22, R25, R27	4	49.9	RES, 49.9, 1%, 0.063 W, 0402	0402	CRCW040249R9FKED	Vishay-Dale		
R17	1	15.0k	RES, 15.0 k, 1%, 0.063 W, 0402	0402	CRCW040215K0FKED	Vishay-Dale		
R18	1	1.50k	RES, 1.50 k, 1%, 0.063 W, 0402	0402	CRCW04021K50FKED	Vishay-Dale		
R19, R20	2	27.4	RES, 27.4, 1%, 0.063 W, 0402	0402	CRCW040227R4FKED	Vishay-Dale		
R21	1	3.09k	RES, 3.09 k, 1%, 0.063 W, 0402	0402	CRCW04023K09FKED	Vishay-Dale		
R31	1	1.00k	RES, 1.00 k, 1%, 0.1 W, 0402	0402	ERJ-2RKF1001X	Panasonic		
SH1, SH2, SH3, SH4, SH5, SH6, SH7, SH8, SH9	9	1x2	Shunt, 100mil, Gold plated, Black	Shunt	969102-0000-DA	3M	SNT-100-BK-G	Samtec
TP1, TP2, TP3, TP4, TP5, TP6, TP7, TP8	8	Orange	Test Point, Miniature, Orange, TH	Orange Miniature Testpoint	5003	Keystone		
U1	1		Digital Input Mono Class-D Audio Amplifier, RSM0032B	RSM0032B	TAS5722LRSMR	Texas Instruments	TAS5722LRSMT	Texas Instruments
U2	1		Single Output Low Noise LDO, 400 mA, Fixed 3.3 V Output, 1.7 to 5.5 V Input, with Reverse Current Protection, 5-pin SOT-23 (DBV), -40 to 85 degC, Green (RoHS & no Sb/Br)	DBV0005A	TPS73633DBVR	Texas Instruments	Equivalent	Texas Instruments
U3	1		Single Output Low Noise LDO, 400 mA, Fixed 1.8 V Output, 1.7 to 5.5 V Input, with Reverse Current Protection, 5-pin SOT-23 (DBV), -40 to 85 degC, Green (RoHS & no Sb/Br)	DBV0005A	TPS73618DBVR	Texas Instruments	Equivalent	Texas Instruments
U4	1		EEPROM, 256KBIT, 400KHZ, MSOP8	MSOP-8	24LC256-I/MS	Microchip		
U5	1		TCA9406 Dual Bidirectional 1-MHz I2C-BUS and SMBus Voltage Level-Translator, 1.65 to 3.6 V, -40 to 85 degC, 8-pin US8 (DCU), Green (RoHS & no Sb/Br)	DCU0008A	TCA9406DCUR	Texas Instruments	Equivalent	Texas Instruments
U6, U8, U10, U11	4		Single Bus Buffer Gate With 3-State Output, DRL0005A	DRL0005A	SN74LVC1G125DRLR	Texas Instruments		Texas Instruments
U7	1		USB Streaming Controller, PFB0048A, NRND	PFB0048A	TAS1020BPFBR	Texas Instruments	TAS1020BPFB	Texas Instruments
U9	1		Processor Supervisory Circuit, DBV0005A	DBV0005A	TPS3825-33QDBVRQ1	Texas Instruments		Texas Instruments
U12	1		Single Inverter Buffer/Driver With Open-Drain Output, DCK0005A	DCK0005A	SN74LVC1G06DCKR	Texas Instruments	SN74LVC1G06DCKT	Texas Instruments
U13	1		SINGLE 2-INPUT POSITIVE-NOR GATE, DCK0005A	DCK0005A	SN74LVC1G02MDCKREP	Texas Instruments		Texas Instruments
Y1	1		Oscillator, 6MHz, 3.3V, SMD	2.5x1x2.5mm	625L3I006M00000	CTS Electrocomponents		
FID1, FID2, FID3, FID4, FID5, FID6	0		Fiducial mark. There is nothing to buy or mount.	Fiducial	N/A	N/A		
R1, R2	0	22.1k	RES, 22.1 k, 1%, 0.063 W, 0402	0402	CRCW040222K1FKED	Vishay-Dale		

STANDARD TERMS AND CONDITIONS FOR EVALUATION MODULES

1. *Delivery:* TI delivers TI evaluation boards, kits, or modules, including any accompanying demonstration software, components, or documentation (collectively, an "EVM" or "EVMs") to the User ("User") in accordance with the terms and conditions set forth herein. Acceptance of the EVM is expressly subject to the following terms and conditions.
 - 1.1 EVMs are intended solely for product or software developers for use in a research and development setting to facilitate feasibility evaluation, experimentation, or scientific analysis of TI semiconductors products. EVMs have no direct function and are not finished products. EVMs shall not be directly or indirectly assembled as a part or subassembly in any finished product. For clarification, any software or software tools provided with the EVM ("Software") shall not be subject to the terms and conditions set forth herein but rather shall be subject to the applicable terms and conditions that accompany such Software
 - 1.2 EVMs are not intended for consumer or household use. EVMs may not be sold, sublicensed, leased, rented, loaned, assigned, or otherwise distributed for commercial purposes by Users, in whole or in part, or used in any finished product or production system.
2. *Limited Warranty and Related Remedies/Disclaimers:*
 - 2.1 These terms and conditions do not apply to Software. The warranty, if any, for Software is covered in the applicable Software License Agreement.
 - 2.2 TI warrants that the TI EVM will conform to TI's published specifications for ninety (90) days after the date TI delivers such EVM to User. Notwithstanding the foregoing, TI shall not be liable for any defects that are caused by neglect, misuse or mistreatment by an entity other than TI, including improper installation or testing, or for any EVMs that have been altered or modified in any way by an entity other than TI. Moreover, TI shall not be liable for any defects that result from User's design, specifications or instructions for such EVMs. Testing and other quality control techniques are used to the extent TI deems necessary or as mandated by government requirements. TI does not test all parameters of each EVM.
 - 2.3 If any EVM fails to conform to the warranty set forth above, TI's sole liability shall be at its option to repair or replace such EVM, or credit User's account for such EVM. TI's liability under this warranty shall be limited to EVMs that are returned during the warranty period to the address designated by TI and that are determined by TI not to conform to such warranty. If TI elects to repair or replace such EVM, TI shall have a reasonable time to repair such EVM or provide replacements. Repaired EVMs shall be warranted for the remainder of the original warranty period. Replaced EVMs shall be warranted for a new full ninety (90) day warranty period.
3. *Regulatory Notices:*
 - 3.1 *United States*
 - 3.1.1 *Notice applicable to EVMs not FCC-Approved:*

This kit is designed to allow product developers to evaluate electronic components, circuitry, or software associated with the kit to determine whether to incorporate such items in a finished product and software developers to write software applications for use with the end product. This kit is not a finished product and when assembled may not be resold or otherwise marketed unless all required FCC equipment authorizations are first obtained. Operation is subject to the condition that this product not cause harmful interference to licensed radio stations and that this product accept harmful interference. Unless the assembled kit is designed to operate under part 15, part 18 or part 95 of this chapter, the operator of the kit must operate under the authority of an FCC license holder or must secure an experimental authorization under part 5 of this chapter.
 - 3.1.2 *For EVMs annotated as FCC – FEDERAL COMMUNICATIONS COMMISSION Part 15 Compliant:*

CAUTION

This device complies with part 15 of the FCC Rules. Operation is subject to the following two conditions: (1) This device may not cause harmful interference, and (2) this device must accept any interference received, including interference that may cause undesired operation.

Changes or modifications not expressly approved by the party responsible for compliance could void the user's authority to operate the equipment.

FCC Interference Statement for Class A EVM devices

NOTE: This equipment has been tested and found to comply with the limits for a Class A digital device, pursuant to part 15 of the FCC Rules. These limits are designed to provide reasonable protection against harmful interference when the equipment is operated in a commercial environment. This equipment generates, uses, and can radiate radio frequency energy and, if not installed and used in accordance with the instruction manual, may cause harmful interference to radio communications. Operation of this equipment in a residential area is likely to cause harmful interference in which case the user will be required to correct the interference at his own expense.

FCC Interference Statement for Class B EVM devices

NOTE: This equipment has been tested and found to comply with the limits for a Class B digital device, pursuant to part 15 of the FCC Rules. These limits are designed to provide reasonable protection against harmful interference in a residential installation. This equipment generates, uses and can radiate radio frequency energy and, if not installed and used in accordance with the instructions, may cause harmful interference to radio communications. However, there is no guarantee that interference will not occur in a particular installation. If this equipment does cause harmful interference to radio or television reception, which can be determined by turning the equipment off and on, the user is encouraged to try to correct the interference by one or more of the following measures:

- Reorient or relocate the receiving antenna.
- Increase the separation between the equipment and receiver.
- Connect the equipment into an outlet on a circuit different from that to which the receiver is connected.
- Consult the dealer or an experienced radio/TV technician for help.

3.2 Canada

3.2.1 For EVMs issued with an Industry Canada Certificate of Conformance to RSS-210

Concerning EVMs Including Radio Transmitters:

This device complies with Industry Canada license-exempt RSS standard(s). Operation is subject to the following two conditions: (1) this device may not cause interference, and (2) this device must accept any interference, including interference that may cause undesired operation of the device.

Concernant les EVMs avec appareils radio:

Le présent appareil est conforme aux CNR d'Industrie Canada applicables aux appareils radio exempts de licence. L'exploitation est autorisée aux deux conditions suivantes: (1) l'appareil ne doit pas produire de brouillage, et (2) l'utilisateur de l'appareil doit accepter tout brouillage radioélectrique subi, même si le brouillage est susceptible d'en compromettre le fonctionnement.

Concerning EVMs Including Detachable Antennas:

Under Industry Canada regulations, this radio transmitter may only operate using an antenna of a type and maximum (or lesser) gain approved for the transmitter by Industry Canada. To reduce potential radio interference to other users, the antenna type and its gain should be so chosen that the equivalent isotropically radiated power (e.i.r.p.) is not more than that necessary for successful communication. This radio transmitter has been approved by Industry Canada to operate with the antenna types listed in the user guide with the maximum permissible gain and required antenna impedance for each antenna type indicated. Antenna types not included in this list, having a gain greater than the maximum gain indicated for that type, are strictly prohibited for use with this device.

Concernant les EVMs avec antennes détachables

Conformément à la réglementation d'Industrie Canada, le présent émetteur radio peut fonctionner avec une antenne d'un type et d'un gain maximal (ou inférieur) approuvé pour l'émetteur par Industrie Canada. Dans le but de réduire les risques de brouillage radioélectrique à l'intention des autres utilisateurs, il faut choisir le type d'antenne et son gain de sorte que la puissance isotrope rayonnée équivalente (p.i.r.e.) ne dépasse pas l'intensité nécessaire à l'établissement d'une communication satisfaisante. Le présent émetteur radio a été approuvé par Industrie Canada pour fonctionner avec les types d'antenne énumérés dans le manuel d'usage et ayant un gain admissible maximal et l'impédance requise pour chaque type d'antenne. Les types d'antenne non inclus dans cette liste, ou dont le gain est supérieur au gain maximal indiqué, sont strictement interdits pour l'exploitation de l'émetteur.

3.3 Japan

3.3.1 *Notice for EVMs delivered in Japan:* Please see http://www.tij.co.jp/lstds/ti_ja/general/eStore/notice_01.page 日本国内に輸入される評価用キット、ボードについては、次のところをご覧ください。
http://www.tij.co.jp/lstds/ti_ja/general/eStore/notice_01.page

3.3.2 *Notice for Users of EVMs Considered "Radio Frequency Products" in Japan:* EVMs entering Japan may not be certified by TI as conforming to Technical Regulations of Radio Law of Japan.

If User uses EVMs in Japan, not certified to Technical Regulations of Radio Law of Japan, User is required by Radio Law of Japan to follow the instructions below with respect to EVMs:

1. Use EVMs in a shielded room or any other test facility as defined in the notification #173 issued by Ministry of Internal Affairs and Communications on March 28, 2006, based on Sub-section 1.1 of Article 6 of the Ministry's Rule for Enforcement of Radio Law of Japan,
2. Use EVMs only after User obtains the license of Test Radio Station as provided in Radio Law of Japan with respect to EVMs, or
3. Use of EVMs only after User obtains the Technical Regulations Conformity Certification as provided in Radio Law of Japan with respect to EVMs. Also, do not transfer EVMs, unless User gives the same notice above to the transferee. Please note that if User does not follow the instructions above, User will be subject to penalties of Radio Law of Japan.

【無線電波を送信する製品の開発キットをお使いになる際の注意事項】 開発キットの中には技術基準適合証明を受けていないものがあります。技術適合証明を受けていないものご使用に際しては、電波法遵守のため、以下のいずれかの措置を取っていただく必要がありますのでご注意ください。

1. 電波法施行規則第6条第1項第1号に基づく平成18年3月28日総務省告示第173号で定められた電波暗室等の試験設備でご使用いただく。
2. 実験局の免許を取得後ご使用いただく。
3. 技術基準適合証明を取得後ご使用いただく。

なお、本製品は、上記の「ご使用にあたっての注意」を譲渡先、移転先に通知しない限り、譲渡、移転できないものとします。

上記を遵守頂けない場合は、電波法の罰則が適用される可能性があることをご留意ください。日本テキサス・インスツルメンツ株式会社

東京都新宿区西新宿 6 丁目 2 4 番 1 号

西新宿三井ビル

3.3.3 *Notice for EVMs for Power Line Communication:* Please see http://www.tij.co.jp/llds/ti_ja/general/eStore/notice_02.page

電力線搬送波通信についての開発キットをお使いになる際の注意事項については、次のところをご覧ください。http://www.tij.co.jp/llds/ti_ja/general/eStore/notice_02.page

4 *EVM Use Restrictions and Warnings:*

4.1 EVMS ARE NOT FOR USE IN FUNCTIONAL SAFETY AND/OR SAFETY CRITICAL EVALUATIONS, INCLUDING BUT NOT LIMITED TO EVALUATIONS OF LIFE SUPPORT APPLICATIONS.

4.2 User must read and apply the user guide and other available documentation provided by TI regarding the EVM prior to handling or using the EVM, including without limitation any warning or restriction notices. The notices contain important safety information related to, for example, temperatures and voltages.

4.3 *Safety-Related Warnings and Restrictions:*

4.3.1 User shall operate the EVM within TI's recommended specifications and environmental considerations stated in the user guide, other available documentation provided by TI, and any other applicable requirements and employ reasonable and customary safeguards. Exceeding the specified performance ratings and specifications (including but not limited to input and output voltage, current, power, and environmental ranges) for the EVM may cause personal injury or death, or property damage. If there are questions concerning performance ratings and specifications, User should contact a TI field representative prior to connecting interface electronics including input power and intended loads. Any loads applied outside of the specified output range may also result in unintended and/or inaccurate operation and/or possible permanent damage to the EVM and/or interface electronics. Please consult the EVM user guide prior to connecting any load to the EVM output. If there is uncertainty as to the load specification, please contact a TI field representative. During normal operation, even with the inputs and outputs kept within the specified allowable ranges, some circuit components may have elevated case temperatures. These components include but are not limited to linear regulators, switching transistors, pass transistors, current sense resistors, and heat sinks, which can be identified using the information in the associated documentation. When working with the EVM, please be aware that the EVM may become very warm.

4.3.2 EVMs are intended solely for use by technically qualified, professional electronics experts who are familiar with the dangers and application risks associated with handling electrical mechanical components, systems, and subsystems. User assumes all responsibility and liability for proper and safe handling and use of the EVM by User or its employees, affiliates, contractors or designees. User assumes all responsibility and liability to ensure that any interfaces (electronic and/or mechanical) between the EVM and any human body are designed with suitable isolation and means to safely limit accessible leakage currents to minimize the risk of electrical shock hazard. User assumes all responsibility and liability for any improper or unsafe handling or use of the EVM by User or its employees, affiliates, contractors or designees.

4.4 User assumes all responsibility and liability to determine whether the EVM is subject to any applicable international, federal, state, or local laws and regulations related to User's handling and use of the EVM and, if applicable, User assumes all responsibility and liability for compliance in all respects with such laws and regulations. User assumes all responsibility and liability for proper disposal and recycling of the EVM consistent with all applicable international, federal, state, and local requirements.

5. *Accuracy of Information:* To the extent TI provides information on the availability and function of EVMs, TI attempts to be as accurate as possible. However, TI does not warrant the accuracy of EVM descriptions, EVM availability or other information on its websites as accurate, complete, reliable, current, or error-free.

6. *Disclaimers:*
- 6.1 EXCEPT AS SET FORTH ABOVE, EVMS AND ANY WRITTEN DESIGN MATERIALS PROVIDED WITH THE EVM (AND THE DESIGN OF THE EVM ITSELF) ARE PROVIDED "AS IS" AND "WITH ALL FAULTS." TI DISCLAIMS ALL OTHER WARRANTIES, EXPRESS OR IMPLIED, REGARDING SUCH ITEMS, INCLUDING BUT NOT LIMITED TO ANY IMPLIED WARRANTIES OF MERCHANTABILITY OR FITNESS FOR A PARTICULAR PURPOSE OR NON-INFRINGEMENT OF ANY THIRD PARTY PATENTS, COPYRIGHTS, TRADE SECRETS OR OTHER INTELLECTUAL PROPERTY RIGHTS.
- 6.2 EXCEPT FOR THE LIMITED RIGHT TO USE THE EVM SET FORTH HEREIN, NOTHING IN THESE TERMS AND CONDITIONS SHALL BE CONSTRUED AS GRANTING OR CONFERRING ANY RIGHTS BY LICENSE, PATENT, OR ANY OTHER INDUSTRIAL OR INTELLECTUAL PROPERTY RIGHT OF TI, ITS SUPPLIERS/LICENSORS OR ANY OTHER THIRD PARTY, TO USE THE EVM IN ANY FINISHED END-USER OR READY-TO-USE FINAL PRODUCT, OR FOR ANY INVENTION, DISCOVERY OR IMPROVEMENT MADE, CONCEIVED OR ACQUIRED PRIOR TO OR AFTER DELIVERY OF THE EVM.
7. *USER'S INDEMNITY OBLIGATIONS AND REPRESENTATIONS.* USER WILL DEFEND, INDEMNIFY AND HOLD TI, ITS LICENSORS AND THEIR REPRESENTATIVES HARMLESS FROM AND AGAINST ANY AND ALL CLAIMS, DAMAGES, LOSSES, EXPENSES, COSTS AND LIABILITIES (COLLECTIVELY, "CLAIMS") ARISING OUT OF OR IN CONNECTION WITH ANY HANDLING OR USE OF THE EVM THAT IS NOT IN ACCORDANCE WITH THESE TERMS AND CONDITIONS. THIS OBLIGATION SHALL APPLY WHETHER CLAIMS ARISE UNDER STATUTE, REGULATION, OR THE LAW OF TORT, CONTRACT OR ANY OTHER LEGAL THEORY, AND EVEN IF THE EVM FAILS TO PERFORM AS DESCRIBED OR EXPECTED.
8. *Limitations on Damages and Liability:*
- 8.1 *General Limitations.* IN NO EVENT SHALL TI BE LIABLE FOR ANY SPECIAL, COLLATERAL, INDIRECT, PUNITIVE, INCIDENTAL, CONSEQUENTIAL, OR EXEMPLARY DAMAGES IN CONNECTION WITH OR ARISING OUT OF THESE TERMS AND CONDITIONS OR THE USE OF THE EVMS PROVIDED HEREUNDER, REGARDLESS OF WHETHER TI HAS BEEN ADVISED OF THE POSSIBILITY OF SUCH DAMAGES. EXCLUDED DAMAGES INCLUDE, BUT ARE NOT LIMITED TO, COST OF REMOVAL OR REINSTALLATION, ANCILLARY COSTS TO THE PROCUREMENT OF SUBSTITUTE GOODS OR SERVICES, RETESTING, OUTSIDE COMPUTER TIME, LABOR COSTS, LOSS OF GOODWILL, LOSS OF PROFITS, LOSS OF SAVINGS, LOSS OF USE, LOSS OF DATA, OR BUSINESS INTERRUPTION. NO CLAIM, SUIT OR ACTION SHALL BE BROUGHT AGAINST TI MORE THAN ONE YEAR AFTER THE RELATED CAUSE OF ACTION HAS OCCURRED.
- 8.2 *Specific Limitations.* IN NO EVENT SHALL TI'S AGGREGATE LIABILITY FROM ANY WARRANTY OR OTHER OBLIGATION ARISING OUT OF OR IN CONNECTION WITH THESE TERMS AND CONDITIONS, OR ANY USE OF ANY TI EVM PROVIDED HEREUNDER, EXCEED THE TOTAL AMOUNT PAID TO TI FOR THE PARTICULAR UNITS SOLD UNDER THESE TERMS AND CONDITIONS WITH RESPECT TO WHICH LOSSES OR DAMAGES ARE CLAIMED. THE EXISTENCE OF MORE THAN ONE CLAIM AGAINST THE PARTICULAR UNITS SOLD TO USER UNDER THESE TERMS AND CONDITIONS SHALL NOT ENLARGE OR EXTEND THIS LIMIT.
9. *Return Policy.* Except as otherwise provided, TI does not offer any refunds, returns, or exchanges. Furthermore, no return of EVM(s) will be accepted if the package has been opened and no return of the EVM(s) will be accepted if they are damaged or otherwise not in a resalable condition. If User feels it has been incorrectly charged for the EVM(s) it ordered or that delivery violates the applicable order, User should contact TI. All refunds will be made in full within thirty (30) working days from the return of the components(s), excluding any postage or packaging costs.
10. *Governing Law:* These terms and conditions shall be governed by and interpreted in accordance with the laws of the State of Texas, without reference to conflict-of-laws principles. User agrees that non-exclusive jurisdiction for any dispute arising out of or relating to these terms and conditions lies within courts located in the State of Texas and consents to venue in Dallas County, Texas. Notwithstanding the foregoing, any judgment may be enforced in any United States or foreign court, and TI may seek injunctive relief in any United States or foreign court.

Mailing Address: Texas Instruments, Post Office Box 655303, Dallas, Texas 75265
Copyright © 2015, Texas Instruments Incorporated

IMPORTANT NOTICE

Texas Instruments Incorporated and its subsidiaries (TI) reserve the right to make corrections, enhancements, improvements and other changes to its semiconductor products and services per JESD46, latest issue, and to discontinue any product or service per JESD48, latest issue. Buyers should obtain the latest relevant information before placing orders and should verify that such information is current and complete. All semiconductor products (also referred to herein as "components") are sold subject to TI's terms and conditions of sale supplied at the time of order acknowledgment.

TI warrants performance of its components to the specifications applicable at the time of sale, in accordance with the warranty in TI's terms and conditions of sale of semiconductor products. Testing and other quality control techniques are used to the extent TI deems necessary to support this warranty. Except where mandated by applicable law, testing of all parameters of each component is not necessarily performed.

TI assumes no liability for applications assistance or the design of Buyers' products. Buyers are responsible for their products and applications using TI components. To minimize the risks associated with Buyers' products and applications, Buyers should provide adequate design and operating safeguards.

TI does not warrant or represent that any license, either express or implied, is granted under any patent right, copyright, mask work right, or other intellectual property right relating to any combination, machine, or process in which TI components or services are used. Information published by TI regarding third-party products or services does not constitute a license to use such products or services or a warranty or endorsement thereof. Use of such information may require a license from a third party under the patents or other intellectual property of the third party, or a license from TI under the patents or other intellectual property of TI.

Reproduction of significant portions of TI information in TI data books or data sheets is permissible only if reproduction is without alteration and is accompanied by all associated warranties, conditions, limitations, and notices. TI is not responsible or liable for such altered documentation. Information of third parties may be subject to additional restrictions.

Resale of TI components or services with statements different from or beyond the parameters stated by TI for that component or service voids all express and any implied warranties for the associated TI component or service and is an unfair and deceptive business practice. TI is not responsible or liable for any such statements.

Buyer acknowledges and agrees that it is solely responsible for compliance with all legal, regulatory and safety-related requirements concerning its products, and any use of TI components in its applications, notwithstanding any applications-related information or support that may be provided by TI. Buyer represents and agrees that it has all the necessary expertise to create and implement safeguards which anticipate dangerous consequences of failures, monitor failures and their consequences, lessen the likelihood of failures that might cause harm and take appropriate remedial actions. Buyer will fully indemnify TI and its representatives against any damages arising out of the use of any TI components in safety-critical applications.

In some cases, TI components may be promoted specifically to facilitate safety-related applications. With such components, TI's goal is to help enable customers to design and create their own end-product solutions that meet applicable functional safety standards and requirements. Nonetheless, such components are subject to these terms.

No TI components are authorized for use in FDA Class III (or similar life-critical medical equipment) unless authorized officers of the parties have executed a special agreement specifically governing such use.

Only those TI components which TI has specifically designated as military grade or "enhanced plastic" are designed and intended for use in military/aerospace applications or environments. Buyer acknowledges and agrees that any military or aerospace use of TI components which have **not** been so designated is solely at the Buyer's risk, and that Buyer is solely responsible for compliance with all legal and regulatory requirements in connection with such use.

TI has specifically designated certain components as meeting ISO/TS16949 requirements, mainly for automotive use. In any case of use of non-designated products, TI will not be responsible for any failure to meet ISO/TS16949.

Products

Audio	www.ti.com/audio
Amplifiers	amplifier.ti.com
Data Converters	dataconverter.ti.com
DLP® Products	www.dlp.com
DSP	dsp.ti.com
Clocks and Timers	www.ti.com/clocks
Interface	interface.ti.com
Logic	logic.ti.com
Power Mgmt	power.ti.com
Microcontrollers	microcontroller.ti.com
RFID	www.ti-rfid.com
OMAP Applications Processors	www.ti.com/omap
Wireless Connectivity	www.ti.com/wirelessconnectivity

Applications

Automotive and Transportation	www.ti.com/automotive
Communications and Telecom	www.ti.com/communications
Computers and Peripherals	www.ti.com/computers
Consumer Electronics	www.ti.com/consumer-apps
Energy and Lighting	www.ti.com/energy
Industrial	www.ti.com/industrial
Medical	www.ti.com/medical
Security	www.ti.com/security
Space, Avionics and Defense	www.ti.com/space-avionics-defense
Video and Imaging	www.ti.com/video

TI E2E Community

e2e.ti.com