

TLK110 Customer EVM

This user's guide details the design and operation of the evaluation module (EVM) for the TLK110.

Contents

1	TLK110 EVM Purpose and Content	1
2	Information and Specifications	2
2.1	Usage Setup and Configuration	2
2.2	Address Settings	2
2.3	TLK110CUSEVM Connections	2
3	TLK110CUSEVM Specification	3
3.1	Overview	3
3.2	Required Resources	3
3.3	Features	3
3.4	TLK110CUSEVM Block Diagram	4
3.5	PCB Physical Layout	5
3.6	EVM Schematics	6
3.7	Bill of Materials	12
4	Software	15

List of Figures

1	EVM Block Diagram	4
2	EVM Layout.....	5
3	TLK110CUSEVM Top Level Schematics	6
4	TLK110CUSEVM / TLK110 Schematics.....	7
5	TLK110CUSEVM 3.3V/1.5V LDO Schematics.....	8
6	TLK110CUSEVM / SOR Schematics	9
7	TLK110CUSEVM / MII Connector Schematics.....	10
8	TLK110CUSEVM / Magnetics Schematics.....	11

List of Tables

1	TLK110CUSEVM Connections.....	2
2	TLK110CUSEVM Aneg Modes Connections.....	2
3	Bill of Materials.....	12

1 TLK110 EVM Purpose and Content

The purpose of the Industrial Ethernet TLK110CUSEVM is to provide Texas Instruments customers a platform to quickly design and market systems containing the TLK110 device. Customers are encouraged to copy EVM components to expedite their design process. The TLK110CUSEVM operates with only a single voltage (5V from the MII). All other voltages are internally produced.

The EVM kit contains:

- TLK110CUSEVM unit
- Printed copy of this user's guide
- TLK110CUSEVM schematic

2 Information and Specifications

This section contains the specifications of the TLK110CUSEVM card, as well as a description of the card's interfaces, connectors, jumpers, and LEDs.

2.1 Usage Setup and Configuration

Power for the TLK110CUSEVM is supplied via a MII connector.

- If 5V is supplied, the on-board voltage regulator, U1, will convert 5V to 3.3V for the device.
- If 3.3V is supplied from the MII connector, R59 should be assembled and R56 should be removed.
- Make sure the J2 jumper is installed in order to supply 3.3V to the magnetic CT.
- Make sure J1 jumper is installed and configured to MII or RMII.

2.2 Address Settings

The PMD address TLK110CUSEVM Physical Layer device is set by the following jumpers:

- J7: PHY ID [0]
- J6: PHY ID [1]
- J5: PHY ID [2]

The default board setting for the PHY address is 01h. The board may be set to any PHY address 00h - 07h by adding jumpers J5 - J7.

2.3 TLK110CUSEVM Connections

Table 1 describes the connections of the TLK110CUSEVM.

Table 1. TLK110CUSEVM Connections

Jumper	Name	Function
P1	MII male connector	MII interface
J1	MII or RMII selector	Select between MII mode or RMII mode
J14	RESET N	Reset the device
J2	Central tap voltage selector	Enable 3.3V supply to the central tap
U2	RJ45	RJ45 ethernet connector
J5 - J7	PHY ID[0:2]	Configure PHY ID address (default = addr 01h)
J15 (Not populated)	25M out	25M clock output
J10	RMII enable	Enable RMII (default = MII)
J8	CFG CROSSOVER	Disable AMDIX (default = AMDIX ON)
J3	CFG ANEG MODE	See description below
J4	AFG ANEG SPD 0	See description below
J5	AFG ANEG SPD 1	See description below

Table 2. TLK110CUSEVM Aneg Modes Connections

AN-EN	AN_1	AN_0	Forced Mode
0	0	0	10BT, Half duplex
0	0	1	10BT, Full duplex
0	1	0	100BT, Half duplex
0	1	1	100BT, Full duplex
AN-EN	AN_1	AN_0	Advertised Mode
1	0	0	10BT, Half/Full duplex
1	0	1	100BT, Half/Full duplex
1	1	0	10BT, 100BT, Half duplex
1	1	1	10BT, 100BT, Full duplex

3 TLK110CUSEVM Specification

3.1 Overview

The TLK110CUSEVM is a Texas Instruments platform that allows a customer to evaluate the TLK110 device and demonstrate the advanced features specified in the TLK110 datasheet.

The EVM supports 10/100 Base-T and is IEEE 802.3 standard compliant.

The TLK110CUSEVM operates with a single supply (5V or 3.3V) from the MII. All other voltages required for the TLK110 are internally generated in the device.

The TLK110CUSEVM is designed to work in industrial temperatures.

3.2 Required Resources

Any equipment that provides a standard IEEE 802.3, Clause 22 MII DTE interface; e.g. SmartBits/Netcom box.

3.3 Features

The TLK110CUSEVM features include:

- Industrial temperatures (-40°C to 85°C)
- Industrial temperature external magnetics
- Control and status:
 - Configurable 8 PHY Addresses – 01h (default) or any other address between 00h - 07h using jumpers as describes in [Table 1](#)
 - 8 LEDs – 2 power, 6 status LEDs (speed, link, and active data)
- Strap options:
 - MII/RMII jumper (MII disable)
 - Resistor strapping options:
 - Configurable PHY addresses 08h - 31h
 - CFG_ANEG_MODE
 - CFG_ANAEG_SPD_0 ,1
 - CFG_CROSSOVER
 - RESET _N jumper
- Connections for the following interfaces:
 - MII connector
 - RJ-45 connector
- Single sided component placement
- On-board clock – crystal/oscillator dual footprint
- On-board power supplied by MII connector only, resistors to configure 5V or 3.3V operation

3.4 TLK110CUSEVM Block Diagram

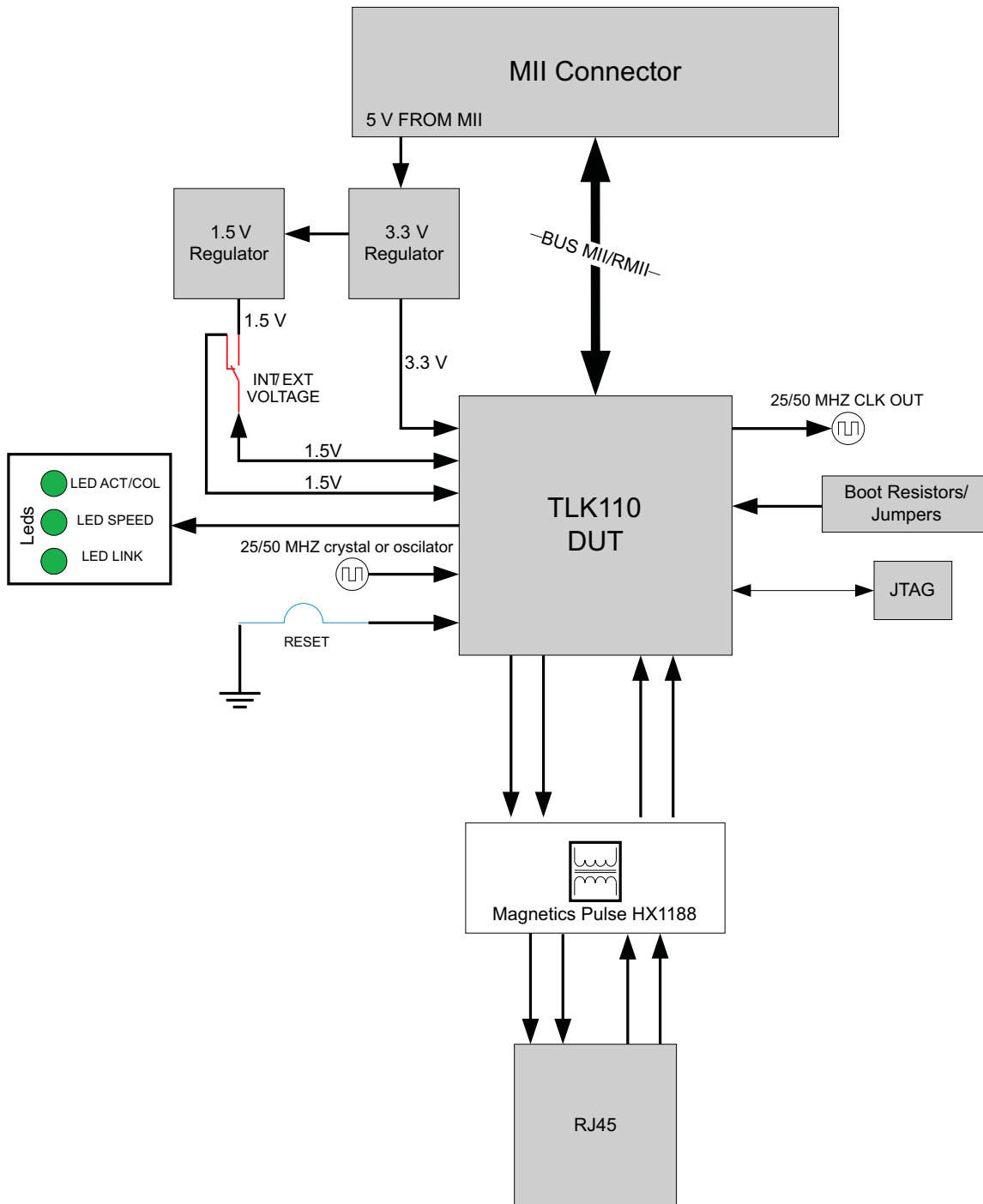

Figure 1. EVM Block Diagram

3.5 PCB Physical Layout

- FR4 material
- Trace impedance differential impedance 100 Ω, ±5%
- Uniform supply and ground planes
- 4 layers
- Combination of through-hole and surface mount technology

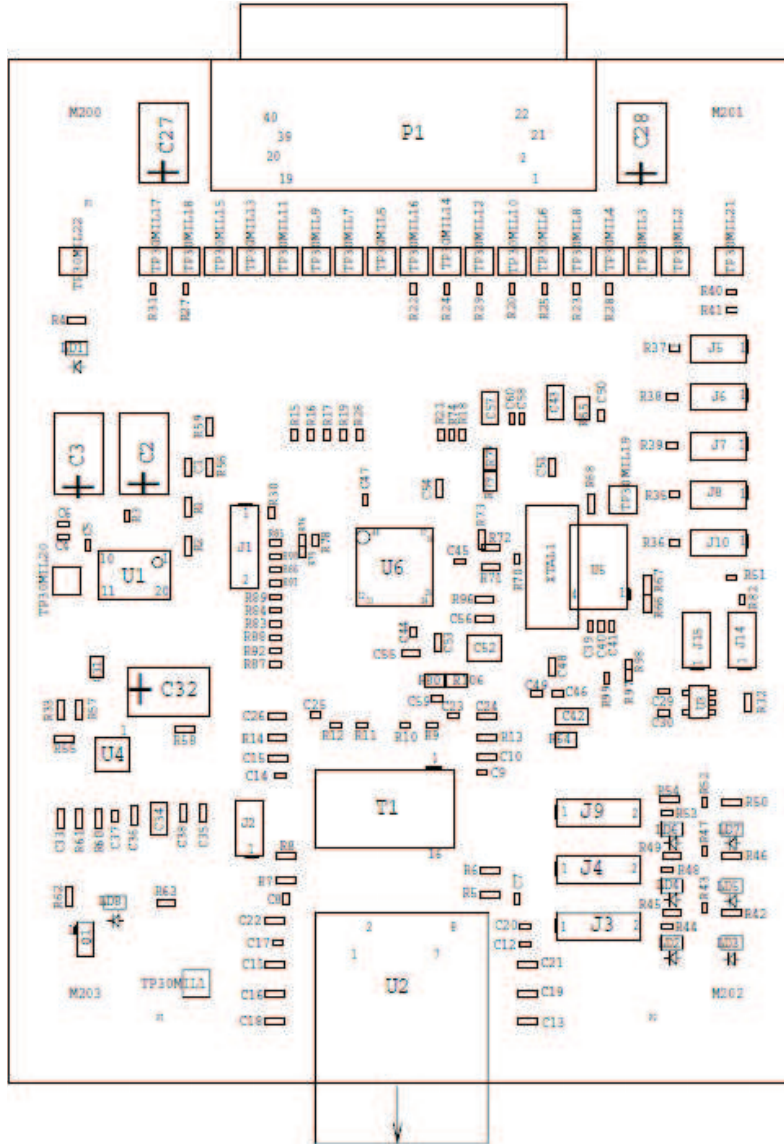

Figure 2. EVM Layout

3.6 EVM Schematics

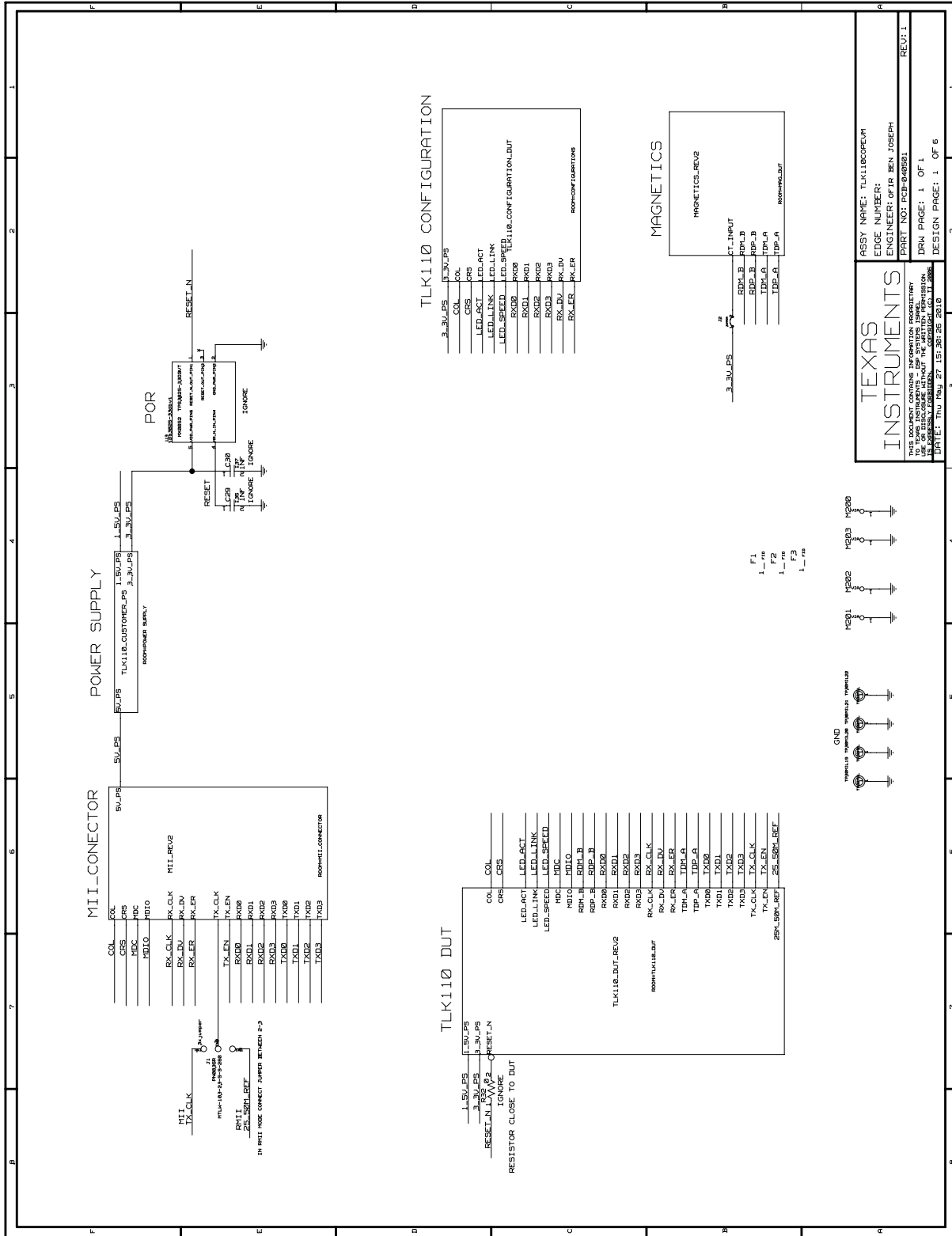

Figure 3. TLK110CUSEVM Top Level Schematics

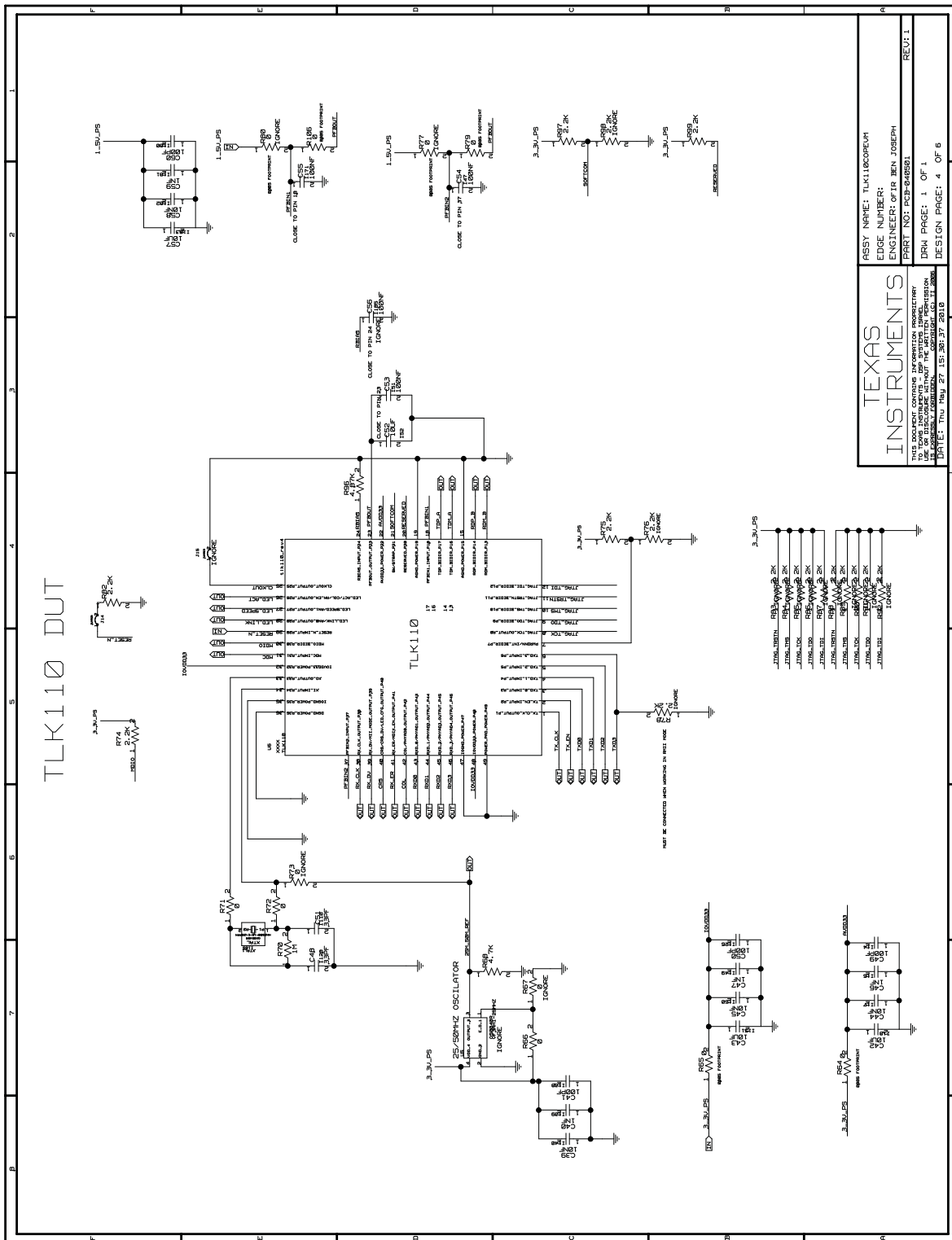

Figure 4. TLK110CUSEVM / TLK110 Schematics

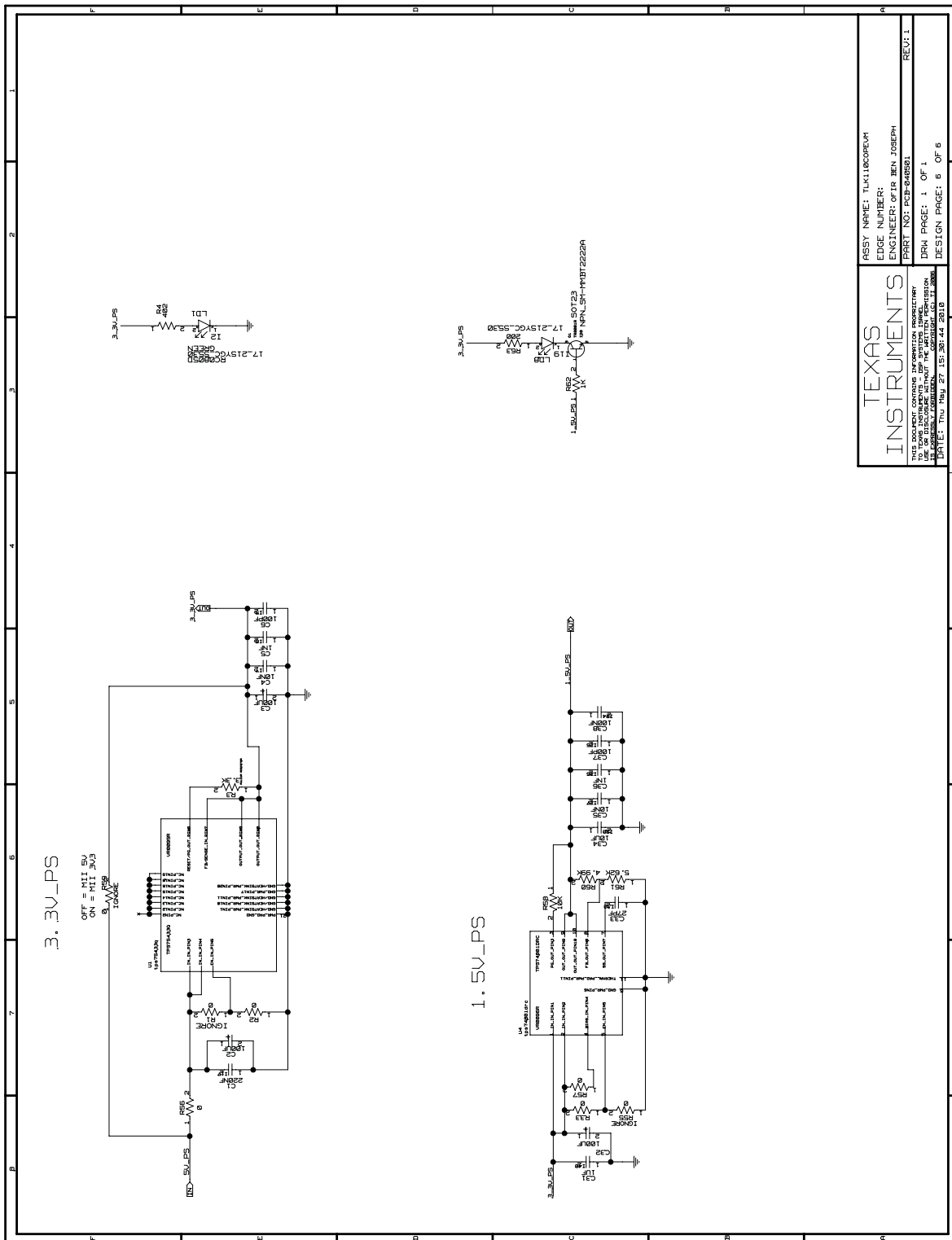
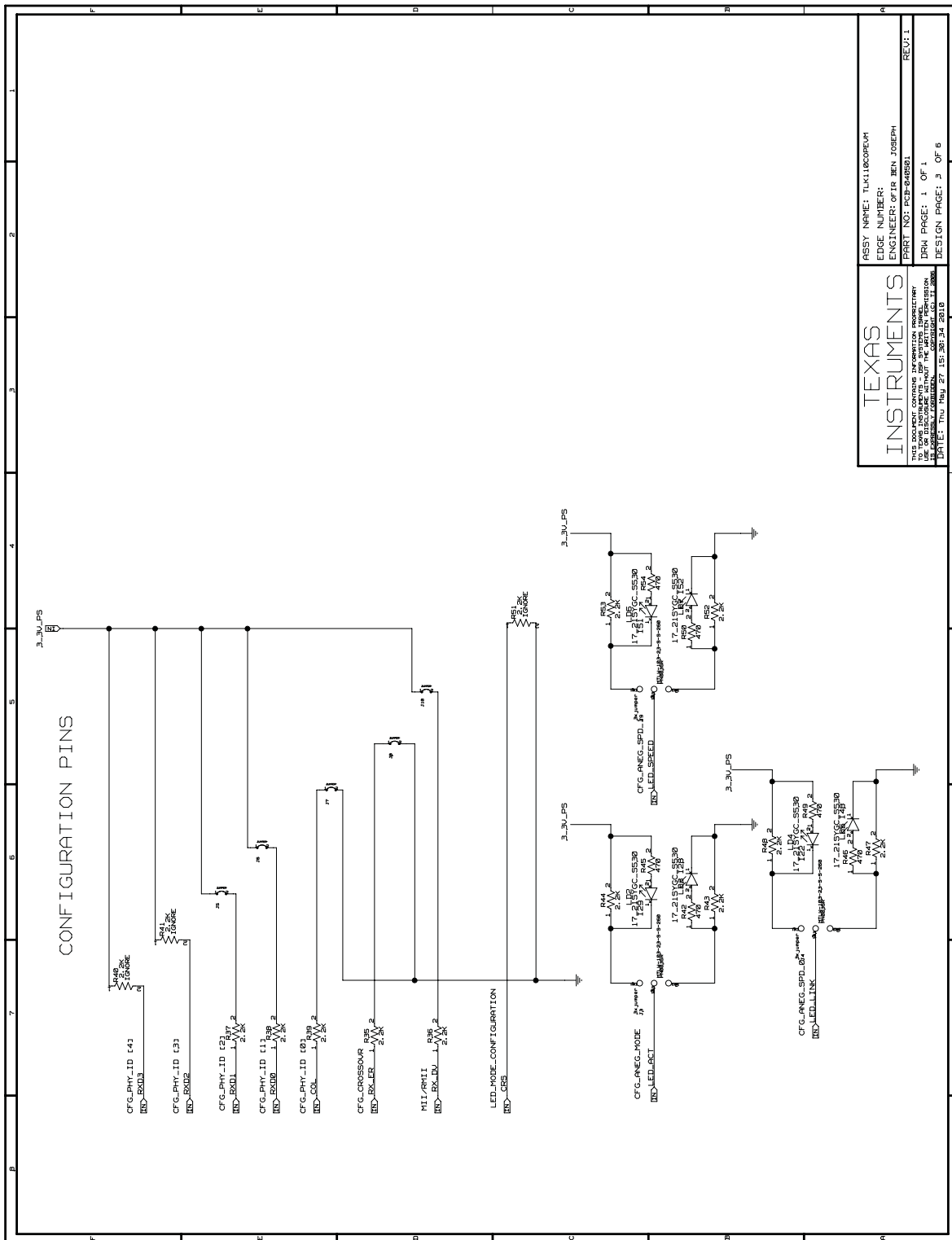
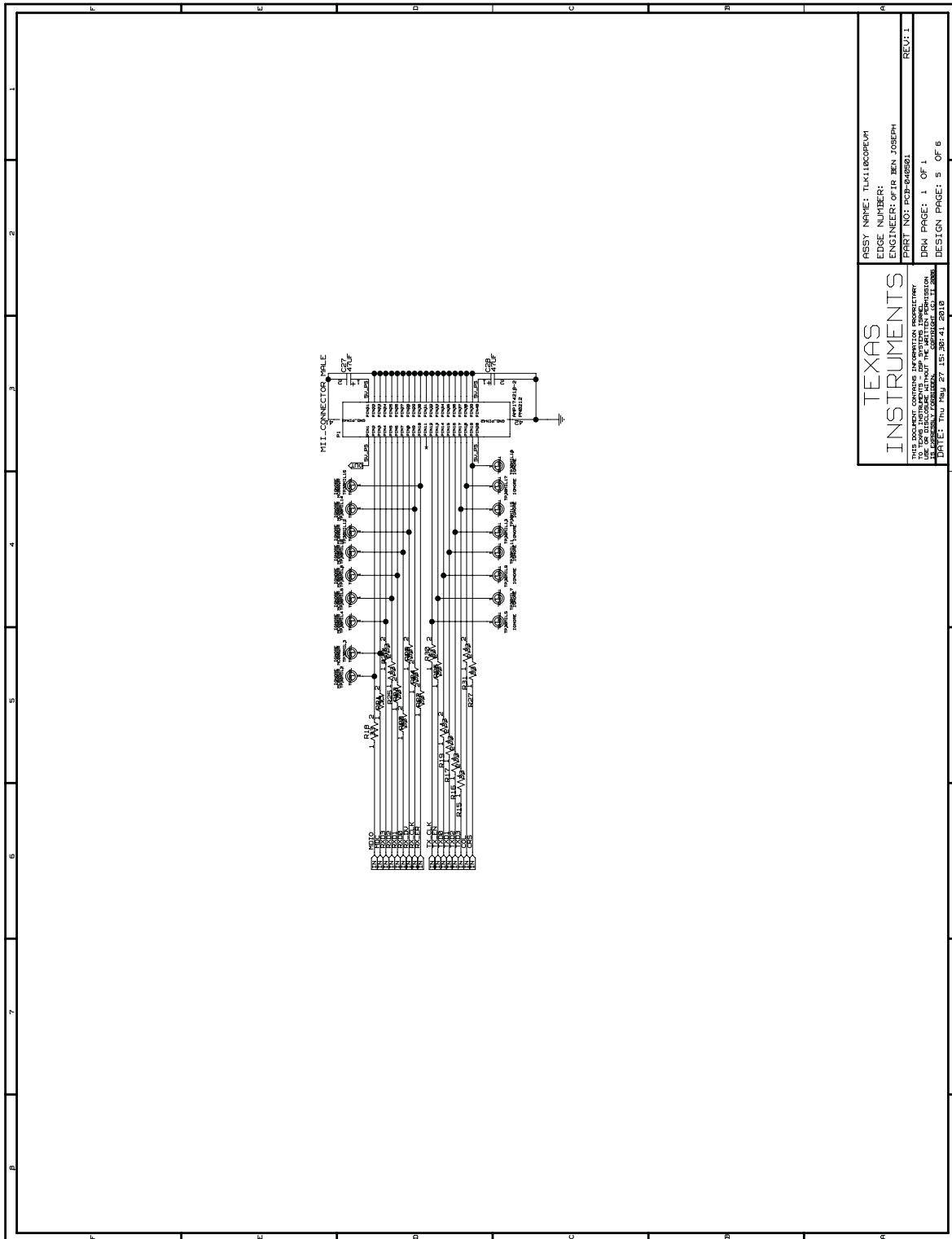

Figure 5. TLK110CUSEVM 3.3V/1.5V LDO Schematics



TEXAS INSTRUMENTS	ASSY NAME: TLK110CUSEVM
	EDGE NUMBER:
	ENGINEER: OFIR BEN JOSEPH
	PART NO: PCB-244501
THIS DRAWING IS UNLESS OTHERWISE SPECIFIED TO BE IN ACCORDANCE WITH THE LATEST EDITION OF THE IPC STANDARD IPC-2221, 2221A, 2221B, 2221C, 2221D, 2221E, 2221F, 2221G, 2221H, 2221J, 2221K, 2221L, 2221M, 2221N, 2221O, 2221P, 2221Q, 2221R, 2221S, 2221T, 2221U, 2221V, 2221W, 2221X, 2221Y, 2221Z, 2221AA, 2221AB, 2221AC, 2221AD, 2221AE, 2221AF, 2221AG, 2221AH, 2221AI, 2221AJ, 2221AK, 2221AL, 2221AM, 2221AN, 2221AO, 2221AP, 2221AQ, 2221AR, 2221AS, 2221AT, 2221AU, 2221AV, 2221AW, 2221AX, 2221AY, 2221AZ, 2221BA, 2221BB, 2221BC, 2221BD, 2221BE, 2221BF, 2221BG, 2221BH, 2221BI, 2221BJ, 2221BK, 2221BL, 2221BM, 2221BN, 2221BO, 2221BP, 2221BQ, 2221BR, 2221BS, 2221BT, 2221BU, 2221BV, 2221BW, 2221BX, 2221BY, 2221BZ, 2221CA, 2221CB, 2221CC, 2221CD, 2221CE, 2221CF, 2221CG, 2221CH, 2221CI, 2221CJ, 2221CK, 2221CL, 2221CM, 2221CN, 2221CO, 2221CP, 2221CQ, 2221CR, 2221CS, 2221CT, 2221CU, 2221CV, 2221CW, 2221CX, 2221CY, 2221CZ, 2221DA, 2221DB, 2221DC, 2221DD, 2221DE, 2221DF, 2221DG, 2221DH, 2221DI, 2221DJ, 2221DK, 2221DL, 2221DM, 2221DN, 2221DO, 2221DP, 2221DQ, 2221DR, 2221DS, 2221DT, 2221DU, 2221DV, 2221DW, 2221DX, 2221DY, 2221DZ, 2221EA, 2221EB, 2221EC, 2221ED, 2221EE, 2221EF, 2221EG, 2221EH, 2221EI, 2221EJ, 2221EK, 2221EL, 2221EM, 2221EN, 2221EO, 2221EP, 2221EQ, 2221ER, 2221ES, 2221ET, 2221EU, 2221EV, 2221EW, 2221EX, 2221EY, 2221EZ, 2221FA, 2221FB, 2221FC, 2221FD, 2221FE, 2221FF, 2221FG, 2221FH, 2221FI, 2221FJ, 2221FK, 2221FL, 2221FM, 2221FN, 2221FO, 2221FP, 2221FQ, 2221FR, 2221FS, 2221FT, 2221FU, 2221FV, 2221FW, 2221FX, 2221FY, 2221FZ, 2221GA, 2221GB, 2221GC, 2221GD, 2221GE, 2221GF, 2221GG, 2221GH, 2221GI, 2221GJ, 2221GK, 2221GL, 2221GM, 2221GN, 2221GO, 2221GP, 2221GQ, 2221GR, 2221GS, 2221GT, 2221GU, 2221GV, 2221GW, 2221GX, 2221GY, 2221GZ, 2221HA, 2221HB, 2221HC, 2221HD, 2221HE, 2221HF, 2221HG, 2221HH, 2221HI, 2221HJ, 2221HK, 2221HL, 2221HM, 2221HN, 2221HO, 2221HP, 2221HQ, 2221HR, 2221HS, 2221HT, 2221HU, 2221HV, 2221HW, 2221HX, 2221HY, 2221HZ, 2221IA, 2221IB, 2221IC, 2221ID, 2221IE, 2221IF, 2221IG, 2221IH, 2221II, 2221IJ, 2221IK, 2221IL, 2221IM, 2221IN, 2221IO, 2221IP, 2221IQ, 2221IR, 2221IS, 2221IT, 2221IU, 2221IV, 2221IW, 2221IX, 2221IY, 2221IZ, 2221JA, 2221JB, 2221JC, 2221JD, 2221JE, 2221JF, 2221JG, 2221JH, 2221JI, 2221JJ, 2221JK, 2221JL, 2221JM, 2221JN, 2221JO, 2221JP, 2221JQ, 2221JR, 2221JS, 2221JT, 2221JU, 2221JV, 2221JW, 2221JX, 2221JY, 2221JZ, 2221KA, 2221KB, 2221KC, 2221KD, 2221KE, 2221KF, 2221KG, 2221KH, 2221KI, 2221KJ, 2221KK, 2221KL, 2221KM, 2221KN, 2221KO, 2221KP, 2221KQ, 2221KR, 2221KS, 2221KT, 2221KU, 2221KV, 2221KW, 2221KX, 2221KY, 2221KZ, 2221LA, 2221LB, 2221LC, 2221LD, 2221LE, 2221LF, 2221LG, 2221LH, 2221LI, 2221LJ, 2221LK, 2221LL, 2221LM, 2221LN, 2221LO, 2221LP, 2221LQ, 2221LR, 2221LS, 2221LT, 2221LU, 2221LV, 2221LW, 2221LX, 2221LY, 2221LZ, 2221MA, 2221MB, 2221MC, 2221MD, 2221ME, 2221MF, 2221MG, 2221MH, 2221MI, 2221MJ, 2221MK, 2221ML, 2221MM, 2221MN, 2221MO, 2221MP, 2221MQ, 2221MR, 2221MS, 2221MT, 2221MU, 2221MV, 2221MW, 2221MX, 2221MY, 2221MZ, 2221NA, 2221NB, 2221NC, 2221ND, 2221NE, 2221NF, 2221NG, 2221NH, 2221NI, 2221NJ, 2221NK, 2221NL, 2221NM, 2221NO, 2221NP, 2221NQ, 2221NR, 2221NS, 2221NT, 2221NU, 2221NV, 2221NW, 2221NX, 2221NY, 2221NZ, 2221OA, 2221OB, 2221OC, 2221OD, 2221OE, 2221OF, 2221OG, 2221OH, 2221OI, 2221OJ, 2221OK, 2221OL, 2221OM, 2221ON, 2221OO, 2221OP, 2221OQ, 2221OR, 2221OS, 2221OT, 2221OU, 2221OV, 2221OW, 2221OX, 2221OY, 2221OZ, 2221PA, 2221PB, 2221PC, 2221PD, 2221PE, 2221PF, 2221PG, 2221PH, 2221PI, 2221PJ, 2221PK, 2221PL, 2221PM, 2221PN, 2221PO, 2221PP, 2221PQ, 2221PR, 2221PS, 2221PT, 2221PU, 2221PV, 2221PW, 2221PX, 2221PY, 2221PZ, 2221QA, 2221QB, 2221QC, 2221QD, 2221QE, 2221QF, 2221QG, 2221QH, 2221QI, 2221QJ, 2221QK, 2221QL, 2221QM, 2221QN, 2221QO, 2221QP, 2221QQ, 2221QR, 2221QS, 2221QT, 2221QU, 2221QV, 2221QW, 2221QX, 2221QY, 2221QZ, 2221RA, 2221RB, 2221RC, 2221RD, 2221RE, 2221RF, 2221RG, 2221RH, 2221RI, 2221RJ, 2221RK, 2221RL, 2221RM, 2221RN, 2221RO, 2221RP, 2221RQ, 2221RR, 2221RS, 2221RT, 2221RU, 2221RV, 2221RW, 2221RX, 2221RY, 2221RZ, 2221SA, 2221SB, 2221SC, 2221SD, 2221SE, 2221SF, 2221SG, 2221SH, 2221SI, 2221SJ, 2221SK, 2221SL, 2221SM, 2221SN, 2221SO, 2221SP, 2221SQ, 2221SR, 2221SS, 2221ST, 2221SU, 2221SV, 2221SW, 2221SX, 2221SY, 2221SZ, 2221TA, 2221TB, 2221TC, 2221TD, 2221TE, 2221TF, 2221TG, 2221TH, 2221TI, 2221TJ, 2221TK, 2221TL, 2221TM, 2221TN, 2221TO, 2221TP, 2221TQ, 2221TR, 2221TS, 2221TT, 2221TU, 2221TV, 2221TW, 2221TX, 2221TY, 2221TZ, 2221UA, 2221UB, 2221UC, 2221UD, 2221UE, 2221UF, 2221UG, 2221UH, 2221UI, 2221UJ, 2221UK, 2221UL, 2221UM, 2221UN, 2221UO, 2221UP, 2221UQ, 2221UR, 2221US, 2221UT, 2221UU, 2221UV, 2221UW, 2221UX, 2221UY, 2221UZ, 2221VA, 2221VB, 2221VC, 2221VD, 2221VE, 2221VF, 2221VG, 2221VH, 2221VI, 2221VJ, 2221VK, 2221VL, 2221VM, 2221VN, 2221VO, 2221VP, 2221VQ, 2221VR, 2221VS, 2221VT, 2221VU, 2221VV, 2221VW, 2221VX, 2221VY, 2221VZ, 2221WA, 2221WB, 2221WC, 2221WD, 2221WE, 2221WF, 2221WG, 2221WH, 2221WI, 2221WJ, 2221WK, 2221WL, 2221WM, 2221WN, 2221WO, 2221WP, 2221WQ, 2221WR, 2221WS, 2221WT, 2221WU, 2221WV, 2221WW, 2221WX, 2221WY, 2221WZ, 2221XA, 2221XB, 2221XC, 2221XD, 2221XE, 2221XF, 2221XG, 2221XH, 2221XI, 2221XJ, 2221XK, 2221XL, 2221XM, 2221XN, 2221XO, 2221XP, 2221XQ, 2221XR, 2221XS, 2221XT, 2221XU, 2221XV, 2221XW, 2221XX, 2221XY, 2221XZ, 2221YA, 2221YB, 2221YC, 2221YD, 2221YE, 2221YF, 2221YG, 2221YH, 2221YI, 2221YJ, 2221YK, 2221YL, 2221YM, 2221YN, 2221YO, 2221YP, 2221YQ, 2221YR, 2221YS, 2221YT, 2221YU, 2221YV, 2221YW, 2221YX, 2221YY, 2221YZ, 2221ZA, 2221ZB, 2221ZC, 2221ZD, 2221ZE, 2221ZF, 2221ZG, 2221ZH, 2221ZI, 2221ZJ, 2221ZK, 2221ZL, 2221ZM, 2221ZN, 2221ZO, 2221ZP, 2221ZQ, 2221ZR, 2221ZS, 2221ZT, 2221ZU, 2221ZV, 2221ZW, 2221ZX, 2221ZY, 2221ZZ	
DATE: Thu May 27 15:26:34 2010	
DESIGN PAGE: 3 OF 5	
REV: 1	

Figure 6. TLK110CUSEVM / SOR Schematics



TEXAS INSTRUMENTS	ASSY NAME: TLK110CUSEVM EDGE NUMBER: ENGINEER: OFIR BEN JOSEPH
	PART NO: PCB-2445501 DRAW PAGE: 1 OF 1 DESIGN PAGE: 5 OF 5
THIS DOCUMENT IS UNCLASSIFIED. FOR INFORMATION ONLY. TO REPORT SUSPECTED UNAUTHORIZED DISSEMINATION, CONTACT: TI.INDUSTRIAL@TI.COM OR 1-800-752-8700 DATE: Thu May 27 15:38:41 2011	

Figure 7. TLK110CUSEVM / MII Connector Schematics

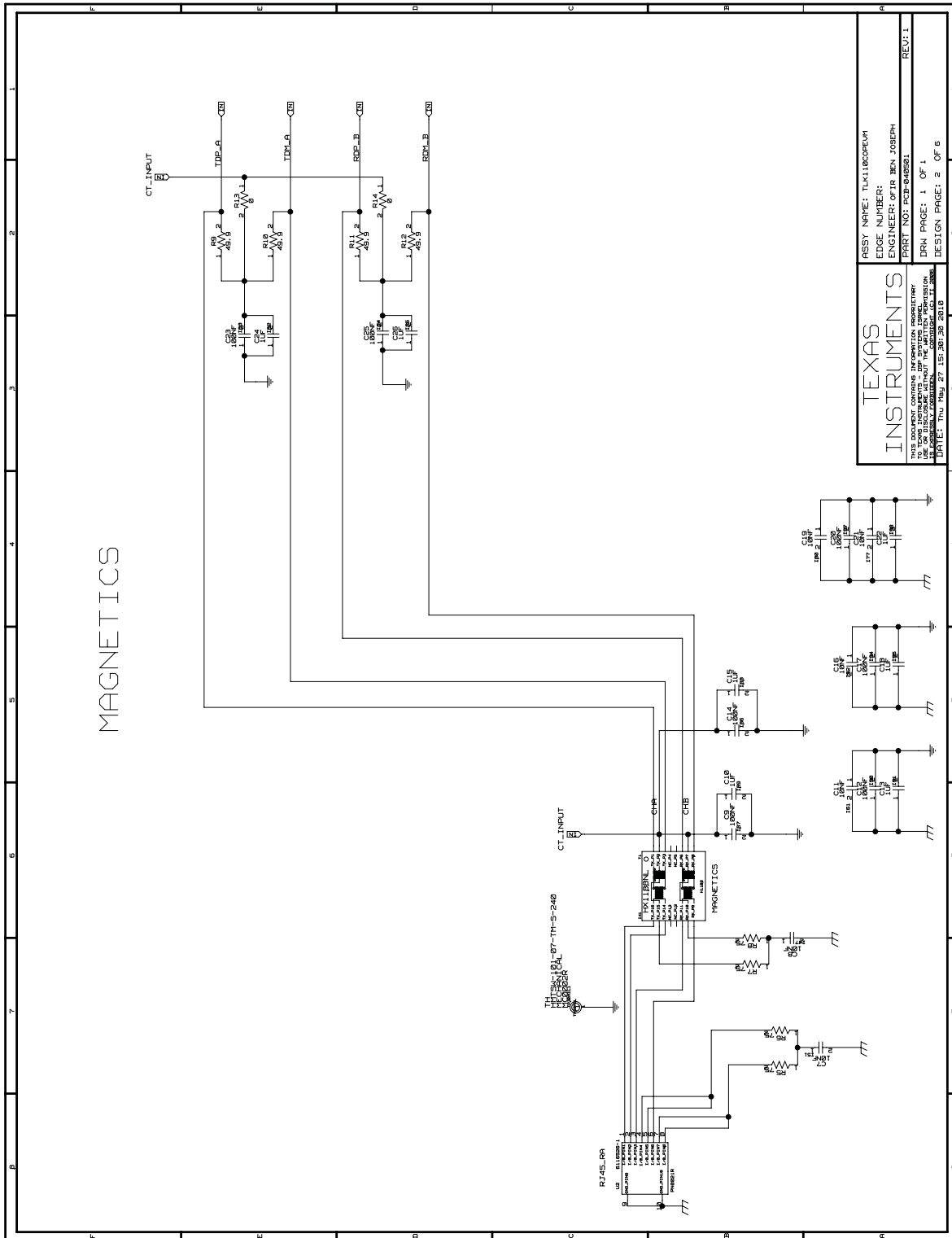

Figure 8. TLK110CUSEVM / Magnetics Schematics

3.7 Bill of Materials

Table 3. Bill of Materials

Part Name	Ref Des	Qty	JEDEC Type	Part No.	Vendor	Vendor Part No.	Value	BOM Ignore	Description	New Part No.
3XJUMPER_MECHANICAL	J1,J3,J4,J9	4	JUMPERX3	PN0035R	SAMTEC	MTLW-103-23-S-S-260	?	?	JUMPERX3 MALE	CON-103260R
8_POS_TH_MEC-PN0021R,8POS,6116526-1	U2	1	8POS	PN0021R	AMP-TYCO	6116526-1	?	?	RJ45 CAT5 8 POS RA Female	CON-111031R
CAPACITOR_SINGLE-CP0042,100NF,10V,10%,10%,RC0402,GMC04X7R104K10NT	C9,C12,C14,C17,C20,C23,C25	7	RC0402	CP0042	CALCHIP	GMC04X7R104K10NT	100NF	?	100NF_X7R_10V_10%_0402	CAT-400134R
CAPACITOR_SINGLE-CP0044,10NF,50V,10%,10%,RC0603,VJ0603Y103KXAT	C11, C16, C19, C21, C35	5	RC0603	CP0044	VITRAMON	VJ0603Y103KXAT	10NF	?	10NF_X7R_50V_10%_0603	CAP-601036R
CAPACITOR_SINGLE-CP0046,1NF,50V,5%,5%,RC0603,CL10B102JBNC	C36	1	RC0603	CP0046	SAMSUNG	CL10B102JBNC	1NF	?	1NF_X7R_50V_5%_0603	CAP-600106R
CAPACITOR_SINGLE-CP0067,10UF,35V,20%,20%,1206,CE_GMK325_F106ZHT	C34,C42,C43,C57	4	1206	CP0067	TAIYO_YUDEN	CE_GMK325_F106ZHT	10UF	?	10UF_Y5V_35V_20%_1206	CAP-401010R
CAPACITOR_SINGLE-CP0105,100NF,16V,10%,10%,0603,CL10B104KONC	C38,C53-C55	4	603	CP0105	SAMSUNG	CL10B104KONC	100NF	?	100NF_X7R_16V_10%_0603	CAP-400136R
CAPACITOR_SINGLE-CP0105,100NF,16V,10%,10%,0603,CL10B104KONC	C56	1	603	CP0105	SAMSUNG	CL10B104KONC	100NF	IGNORE	100NF_X7R_16V_10%_0603	CAP-400136R
CAPACITOR_SINGLE-CP0120,1UF,16V,80%,20%,0805,ECJ2VF1C105Z	C31	1	805	CP0120	PANASONIC	ECJ2VF1C105Z	1UF	?	1UF_Y5V_16V_+80%_-20%_0805	CAP-300108R
CAPACITOR_SINGLE-CP0135,1NF,25V,5%,5%,0402,VJ0402Y102JXXA	C29,C30	2	402	CP0135	VITRAMON	VJ0402Y102JXXA	1NF	IGNORE	1NF_X7R_25V_5%_0402	CAS-600104R
CAPACITOR_SINGLE-CP0135,1NF,25V,5%,5%,0402,VJ0402Y102JXXA	C5,C40,C46,C47,C59	5	402	CP0135	VITRAMON	VJ0402Y102JXXA	1NF	?	1NF_X7R_25V_5%_0402	CAS-600104R
CAPACITOR_SINGLE-CP0136,27PF,50V,1%,1%,0603,0603N270F500NT	C33	1	603	CP0136	HITANO	0603N270F500NT	27PF	?	27PF_NPO_50V_1%_0603	CAP-902716R
CAPACITOR_SINGLE-CP0146,10NF,50V,5%,5%,0402,CL05B103JBNC	C4,C7,C8,C39,C44,C45,C58	7	402	CP0146	SAMSUNG	CL05B103JBNC	10NF	?	10NF_X7R_50V_5%_0402	CAS-601034R
CAPACITOR_SINGLE-CP0147R,100PF,50V,5%,5%,RC0402,VJ0402A101JXAT	C6,C37,C41,C49,C50,C60	6	RC0402	CP0147R	VITRAMON	VJ0402A101JXAT	100PF	?	100PF_NPO_50V_5%_0402	CAP-910004R
CAPACITOR_SINGLE-CP0221,1UF,6.3V,15%,15%,0603,ECJ1VB0J105K	C10,C13,C15,C18,C22,C24,C26	7	603	CP0221	PANASONIC	ECJ1VB0J105K	1UF	?	1UF_X7R_6V3_15%_0603	CAS-300106R
CAPACITOR_SINGLE-CP0255,220NF,16V,5%,5%,0603,0603B224J160NT	C1	1	603	CP0255	HITANO	0603B224J160NT	220NF	?	220NF_16V_5%_0603	CAS-402236R
CAPACITOR_SINGLE-CP0259,33PF,50V,1%,1%,0603,CL10C330FB8NNNC	C48,C51	2	603	CP0259	SAMSUNG	CL10C330FB8NNNC	33PF	?	33PF_NPO_50V_1%_0603	CAP-903316R
CAPACITOR_SINGLE-XXXX,10UF,10V,10%,10%,1210,GRM32AR61C106KAB7L	C52	1	1210	XXXX	MURATA	GRM32AR61C106KAB7L	10UF	?	10UF_X5R_10V_10%_1210 LOW ESR	CAM-301005R
F4107R_SMT5X7-OS0040R,SMT5X7,VF3AH1-25MHZ	U5	1	SMT5X7	OS0040R	VALPEY_FISHER	VF3AH1-25MHZ	?	IGNORE	3.3V TIGHT STABILITY HCMOS SMD OSCILLATOR WITH STANDBY, 25MHz, 25ppm -40+85 (INDUSTRIAL)	OSC-507025R
FIDUSHEL	F1-F3	3	FIDUSHEL	?	?	?	?	?	?	?

Table 3. Bill of Materials (continued)

Part Name	Ref Des	Qty	JEDEC Type	Part No.	Vendor	Vendor Part No.	Value	BOM Ignore	Description	New Part No.
HC49SM_I-25M-INDUSTRIAL_OX0040R	XTAL1	1	HC49SM_I	OX0040R	HEC	HH2500-18-E-25PPM	?	?	XTAL HC49SM 25MHZ 100PPM 18PF INDUSTRIAL	CRS-250018R
HX1188NL_SM16-TF0116R,SM16,	T1	1	SM16	TF0122R	PULSE	HX1188NL	?	?	10/100 BASE-T MAGNETICS	CON-118800R
JUMPER_TH-PN0019,JMP02,90120-0762	J2,J5-J8,J10,J14	7	JMP02	PN0019	MOLEX	90120-0762	?	?	MOLEX JUMPER 0.1 INCH	CON-901202R
JUMPER_TH-PN0019,JMP02,90120-0762	J15	1	JMP02	PN0019	MOLEX	90120-0762	?	IGNORE	MOLEX JUMPER 0.1 INCH	CON-901202R
LED_SM-LD0021,50V,RC0805D,17_21SYGC_S530,GREEN	LD1-LD8	8	RC0805D	LD0021	EVERLIGHT	17_21SYGC_S530	?	?	GREEN_LED_SMD_0805	LED-215301R
MII-PN0212,_AMP174218-2	P1	1	MII-MALE	PN0212	AMP	AMP174218-2	?	?	MII_40PIN_SHILDED_THRA_MALE	CON-174218R
NPN_IC-MMBT222AA-TR0001R	Q1	1	SOT23	TR0001R	XXXX	NPN-SM-MMBT222A	?	?	NPN SOT23 TRANSISTOR	TRS-104023R
PCAP_SINGLE-CT0024,100UF,10V,20%,20%,7343,EEJL1AD107R	C2,C3,C32	3	7343	CT0024	PANASONIC	EEJL1AD107R	100UF	?	100UF_10V_20%_Tantalum_Low_ES R_D_Size	CAP-100343R
PCAP_SINGLE-CT0026R,47UF,20V,10%,10%,7343,TCSVS1D476KDAR	C27,C28	2	7343	CT0026R	SAMSUNG	TCSVS1D476KDAR	47UF	?	47UF_TANT_20V_10%_7343	CAP-047343R
RESISTOR_2PIN-RE0004,0,0.06W,5%,RC0603JW_000E	R1,R32,R55,R59,R67,R73	6	603	RE0004	BOURNS	RC0603JW_000E	0	IGNORE	0_0W06_5%_0603	RES-100006R
RESISTOR_2PIN-RE0004,0,0.06W,5%,RC0603JW_000E	R2,R13,R14,R33,R56,R57,R66,R71,R72	9	603	RE0004	BOURNS	RC0603JW_000E	0	?	0_0W06_5%_0603	RES-100006R
RESISTOR_2PIN-RE0005,0,0.1W,5%,RC0805JW_000E	R64,R65,R79,R106	4	805	RE0005	BOURNS	RC0805JW_000E	0	?	0R_0W1_5%_0805	RES-100008R
RESISTOR_2PIN-RE0005,0,0.1W,5%,RC0805JW_000E	R77,R80	2	805	RE0005	BOURNS	RC0805JW_000E	0	IGNORE	0R_0W1_5%_0805	RES-100008R
RESISTOR_2PIN-RE0044,4.7K,0.06W,5%,CR0603JW-472E	R68	1	603	RE0044	BOURNS	CR0603JW-472E	4.7K	?	4K7_0W06_5%_0603	RES-404706R
RESISTOR_2PIN-RE0085,49.9,0.06W,1%,RC0402FR-0749R9	R9-R12	4	402	RE0085	YAGEO	RC0402FR-0749R9	49.9	?	49R9_0W06_1%_0402	RES-249914R
RESISTOR_2PIN-RE0114R,4.99K,0.06W,1%,CR0603-FX-4991ELF	R60	1	RC0603	RE0114R	BOURNS	CR0603-FX-4991ELF	4.99K	?	RESISTOR_4.99K_1%_0603	RES-349906R
RESISTOR_2PIN-RE0125,1K,0.06W,1%,CR0603FX_1001E	R62	1	603	RE0125	YAGEO	CR0603FX_1001E	1K	?	1K_0W06_1%_0603	RES-300106R
RESISTOR_2PIN-RE0152,470,0.1W,1%,CR0603FX-470R	R42,R45,R46,R49,R50,R54	6	603	RE0152	YAGEO	CR0603FX-470R	470	?	470_0W1_1%_0603	RES-147006R
RESISTOR_2PIN-RE0182,10K,0.06W,1%,RC0603FR_0710K	R58	1	603	RE0182	YAGEO	RC0603FR_0710K	10K	?	10K_0W06_1%_0603	RES-301006R
RESISTOR_2PIN-RE0218,200,0.06W,1%,RC0603FR-07200R	R63	1	603	RE0218	AVX	RC0603FR-07200R	200	?	200R_0W06_1%_0603	RES-320006R
RESISTOR_2PIN-RE0294,75,0.06W,1%,CR0603FX_75R	R5-R8	4	603	RE0294	YAGEO	CR0605FX_75R	75	?	75R_0W06_1%_0603	RES-107506R
RESISTOR_2PIN-RE0343,3.3K,0.06W,1%,CR0402FX-3301G	R3	1	402	RE0343	YAGEO	CR0402FX-3301G	3.3K	?	3K3_0W06_1%_0402	RES-403304R
RESISTOR_2PIN-RE0475,5.62K,0.06W,1%,RC0603FR-075K62	R61	1	603	RE0475	YAGEO	RC0603FR-075K62	5.62K	?	5K62_0W06_1%_0603	RES-856216R
RESISTOR_2PIN-RE0518R,402,0.06W,1%,CR0603-FX-402RELF	R4	1	603	RE0518R	BOURNS	CR0603-FX-402RELF	402	?	RESISTOR_402OHM_1%_0603	RES-140206R
RESISTOR_2PIN-RE0536R,1M,0.06W,1%,RC0402FR-071M	R70	1	RC0402	RE0536R	YAGEO	RC0402FR-071M	1M	?	RESISTOR_1M_1%_0402	RES-600104R

Table 3. Bill of Materials (continued)

Part Name	Ref Des	Qty	JEDEC Type	Part No.	Vendor	Vendor Part No.	Value	BOM Ignore	Description	New Part No.
RESISTOR_2PIN-RE0661R,2.2K,0.06W,1%,CR0402FR-072K2L	R35-R39, R43,R44, R47, R48, R52, R53, R74, R75, R82, R97, R99	16	402	RE0661R	YAGEO	CR0402FR-072K2L	2.2K	?	2.2K_0W06_1%_0402	RES-402204R
RESISTOR_2PIN-RE0661R,2.2K,0.06W,1%,CR0402FR-072K2L	R40, R41, R51, R76, R78, R83-R92, R98	16	402	RE0661R	YAGEO	CR0402FR-072K2L	2.2K	IGNORE	2.2K_0W06_1%_0402	RES-402204R
RESISTOR_2PIN-RE0662R,33,0.06W,1%,CR0402FR-0733R	R15-R31	17	402	RE0662R	YAGEO	CR0402FR-0733R	33	?	33_0W06_1%_0402	RES-103304R
RESISTOR_2PIN-XXXX,4.87K,0.06W,1%,CR0603-FX-4871ELF	R96	1	RC0603	XXXX	BOURNS	CR0603-FX-4871ELF	4.87K	?	RESISTOR_4.87K_1%_0603	RES-404876R
TLK110_REV4_IC-XXXX.	U6	1	QFP50P900X900 X120-49	XXXX	TI	TLK110	?	?	INDUSTRIAL ETHERNET 10/100BT	CON-110000R
TP30MIL_MECHANICAL-MC0002R	TP30MIL1, TP30MIL19-TP30MIL22	5	TH	MC0002R	SAMTEC	HMTSW-101-07-TM-S-240	?	?	TESTPOINT_TH_0.9mm_pad_1.7MM	CON-101240R
TP30MIL_MECHANICAL-MC0002R	TP30MIL2-TP30MIL18	17	TH	MC0002R	SAMTEC	HMTSW-101-07-TM-S-240	?	IGNORE	TESTPOINT_TH_0.9mm_pad_1.7MM	CON-101240R
TPM_MECH_VIA	M200-M203	4	TPM_MECH_VIA	?	?	?	?	?	?	?
TPS3825-33DBVT_IC-MX0052,DBV,TPS3825-33DBVT	U3	1	DBV	MX0052	TI	TPS3825-33DBVT	?	IGNORE	PROCESSOR SUPERVISORY CIRCUITS WITH MR_N INPUT	REG-382533R
TPS74801DRC_IC-VR0096R,SON10,TPS74801DRC	U4	1	SON10	VR0096R	TI	TPS74801DRC	?	?	LDO 1.5A ADJ	REG-748010R
TPS75433Q_IC-VR0095R,TSSOP-20,TPS75433Q	U1	1	TSSOP-20	VR0095R	TI	TPS75433Q	?	?	LDO 3.3V 2A	REG-754330R

4 Software

The EVM does not require any specific software and can be controlled with networking equipment that support a MII interface. However for SmartBits users, TI can provide a proprietary GUI that simplifies the controllability of the TLK110CUSEVM through SmartBits and allows advanced features such as a cable diagnostic tool.

Evaluation Board/Kit Important Notice

Texas Instruments (TI) provides the enclosed product(s) under the following conditions:

This evaluation board/kit is intended for use for **ENGINEERING DEVELOPMENT, DEMONSTRATION, OR EVALUATION PURPOSES ONLY** and is not considered by TI to be a finished end-product fit for general consumer use. Persons handling the product(s) must have electronics training and observe good engineering practice standards. As such, the goods being provided are not intended to be complete in terms of required design-, marketing-, and/or manufacturing-related protective considerations, including product safety and environmental measures typically found in end products that incorporate such semiconductor components or circuit boards. This evaluation board/kit does not fall within the scope of the European Union directives regarding electromagnetic compatibility, restricted substances (RoHS), recycling (WEEE), FCC, CE or UL, and therefore may not meet the technical requirements of these directives or other related directives.

Should this evaluation board/kit not meet the specifications indicated in the User's Guide, the board/kit may be returned within 30 days from the date of delivery for a full refund. **THE FOREGOING WARRANTY IS THE EXCLUSIVE WARRANTY MADE BY SELLER TO BUYER AND IS IN LIEU OF ALL OTHER WARRANTIES, EXPRESSED, IMPLIED, OR STATUTORY, INCLUDING ANY WARRANTY OF MERCHANTABILITY OR FITNESS FOR ANY PARTICULAR PURPOSE.**

The user assumes all responsibility and liability for proper and safe handling of the goods. Further, the user indemnifies TI from all claims arising from the handling or use of the goods. Due to the open construction of the product, it is the user's responsibility to take any and all appropriate precautions with regard to electrostatic discharge.

EXCEPT TO THE EXTENT OF THE INDEMNITY SET FORTH ABOVE, NEITHER PARTY SHALL BE LIABLE TO THE OTHER FOR ANY INDIRECT, SPECIAL, INCIDENTAL, OR CONSEQUENTIAL DAMAGES.

TI currently deals with a variety of customers for products, and therefore our arrangement with the user **is not exclusive.**

TI assumes **no liability for applications assistance, customer product design, software performance, or infringement of patents or services described herein.**

Please read the User's Guide and, specifically, the Warnings and Restrictions notice in the User's Guide prior to handling the product. This notice contains important safety information about temperatures and voltages. For additional information on TI's environmental and/or safety programs, please contact the TI application engineer or visit www.ti.com/esh.

No license is granted under any patent right or other intellectual property right of TI covering or relating to any machine, process, or combination in which such TI products or services might be or are used.

FCC Warning

This evaluation board/kit is intended for use for **ENGINEERING DEVELOPMENT, DEMONSTRATION, OR EVALUATION PURPOSES ONLY** and is not considered by TI to be a finished end-product fit for general consumer use. It generates, uses, and can radiate radio frequency energy and has not been tested for compliance with the limits of computing devices pursuant to part 15 of FCC rules, which are designed to provide reasonable protection against radio frequency interference. Operation of this equipment in other environments may cause interference with radio communications, in which case the user at his own expense will be required to take whatever measures may be required to correct this interference.

EVM Warnings and Restrictions

It is important to operate this EVM within the input voltage range of 5 V or 3.3 V and the output voltage range of N/A V to N/A V .

Exceeding the specified input range may cause unexpected operation and/or irreversible damage to the EVM. If there are questions concerning the input range, please contact a TI field representative prior to connecting the input power.

Applying loads outside of the specified output range may result in unintended operation and/or possible permanent damage to the EVM. Please consult the EVM User's Guide prior to connecting any load to the EVM output. If there is uncertainty as to the load specification, please contact a TI field representative.

During normal operation, some circuit components may have case temperatures greater than 60° C. The EVM is designed to operate properly with certain components above 60° C as long as the input and output ranges are maintained. These components include but are not limited to linear regulators, switching transistors, pass transistors, and current sense resistors. These types of devices can be identified using the EVM schematic located in the EVM User's Guide. When placing measurement probes near these devices during operation, please be aware that these devices may be very warm to the touch.

Mailing Address: Texas Instruments, Post Office Box 655303, Dallas, Texas 75265
Copyright © 2011, Texas Instruments Incorporated

EVALUATION BOARD/KIT/MODULE (EVM) ADDITIONAL TERMS

Texas Instruments (TI) provides the enclosed Evaluation Board/Kit/Module (EVM) under the following conditions:

The user assumes all responsibility and liability for proper and safe handling of the goods. Further, the user indemnifies TI from all claims arising from the handling or use of the goods.

Should this evaluation board/kit not meet the specifications indicated in the User's Guide, the board/kit may be returned within 30 days from the date of delivery for a full refund. THE FOREGOING LIMITED WARRANTY IS THE EXCLUSIVE WARRANTY MADE BY SELLER TO BUYER AND IS IN LIEU OF ALL OTHER WARRANTIES, EXPRESSED, IMPLIED, OR STATUTORY, INCLUDING ANY WARRANTY OF MERCHANTABILITY OR FITNESS FOR ANY PARTICULAR PURPOSE. EXCEPT TO THE EXTENT OF THE INDEMNITY SET FORTH ABOVE, NEITHER PARTY SHALL BE LIABLE TO THE OTHER FOR ANY INDIRECT, SPECIAL, INCIDENTAL, OR CONSEQUENTIAL DAMAGES.

Please read the User's Guide and, specifically, the Warnings and Restrictions notice in the User's Guide prior to handling the product. This notice contains important safety information about temperatures and voltages. For additional information on TI's environmental and/or safety programs, please visit www.ti.com/esh or contact TI.

No license is granted under any patent right or other intellectual property right of TI covering or relating to any machine, process, or combination in which such TI products or services might be or are used. TI currently deals with a variety of customers for products, and therefore our arrangement with the user is not exclusive. TI assumes no liability for applications assistance, customer product design, software performance, or infringement of patents or services described herein.

REGULATORY COMPLIANCE INFORMATION

As noted in the EVM User's Guide and/or EVM itself, this EVM and/or accompanying hardware may or may not be subject to the Federal Communications Commission (FCC) and Industry Canada (IC) rules.

For EVMs **not** subject to the above rules, this evaluation board/kit/module is intended for use for ENGINEERING DEVELOPMENT, DEMONSTRATION OR EVALUATION PURPOSES ONLY and is not considered by TI to be a finished end product fit for general consumer use. It generates, uses, and can radiate radio frequency energy and has not been tested for compliance with the limits of computing devices pursuant to part 15 of FCC or ICES-003 rules, which are designed to provide reasonable protection against radio frequency interference. Operation of the equipment may cause interference with radio communications, in which case the user at his own expense will be required to take whatever measures may be required to correct this interference.

General Statement for EVMs including a radio

User Power/Frequency Use Obligations: This radio is intended for development/professional use only in legally allocated frequency and power limits. Any use of radio frequencies and/or power availability of this EVM and its development application(s) must comply with local laws governing radio spectrum allocation and power limits for this evaluation module. It is the user's sole responsibility to only operate this radio in legally acceptable frequency space and within legally mandated power limitations. Any exceptions to this are strictly prohibited and unauthorized by Texas Instruments unless user has obtained appropriate experimental/development licenses from local regulatory authorities, which is responsibility of user including its acceptable authorization.

For EVMs annotated as FCC – FEDERAL COMMUNICATIONS COMMISSION Part 15 Compliant

Caution

This device complies with part 15 of the FCC Rules. Operation is subject to the following two conditions: (1) This device may not cause harmful interference, and (2) this device must accept any interference received, including interference that may cause undesired operation.

Changes or modifications not expressly approved by the party responsible for compliance could void the user's authority to operate the equipment.

FCC Interference Statement for Class A EVM devices

This equipment has been tested and found to comply with the limits for a Class A digital device, pursuant to part 15 of the FCC Rules. These limits are designed to provide reasonable protection against harmful interference when the equipment is operated in a commercial environment. This equipment generates, uses, and can radiate radio frequency energy and, if not installed and used in accordance with the instruction manual, may cause harmful interference to radio communications. Operation of this equipment in a residential area is likely to cause harmful interference in which case the user will be required to correct the interference at his own expense.

FCC Interference Statement for Class B EVM devices

This equipment has been tested and found to comply with the limits for a Class B digital device, pursuant to part 15 of the FCC Rules. These limits are designed to provide reasonable protection against harmful interference in a residential installation. This equipment generates, uses and can radiate radio frequency energy and, if not installed and used in accordance with the instructions, may cause harmful interference to radio communications. However, there is no guarantee that interference will not occur in a particular installation. If this equipment does cause harmful interference to radio or television reception, which can be determined by turning the equipment off and on, the user is encouraged to try to correct the interference by one or more of the following measures:

- Reorient or relocate the receiving antenna.
- Increase the separation between the equipment and receiver.
- Connect the equipment into an outlet on a circuit different from that to which the receiver is connected.
- Consult the dealer or an experienced radio/TV technician for help.

For EVMs annotated as IC – INDUSTRY CANADA Compliant

This Class A or B digital apparatus complies with Canadian ICES-003.

Changes or modifications not expressly approved by the party responsible for compliance could void the user's authority to operate the equipment.

Concerning EVMs including radio transmitters

This device complies with Industry Canada licence-exempt RSS standard(s). Operation is subject to the following two conditions: (1) this device may not cause interference, and (2) this device must accept any interference, including interference that may cause undesired operation of the device.

Concerning EVMs including detachable antennas

Under Industry Canada regulations, this radio transmitter may only operate using an antenna of a type and maximum (or lesser) gain approved for the transmitter by Industry Canada. To reduce potential radio interference to other users, the antenna type and its gain should be so chosen that the equivalent isotropically radiated power (e.i.r.p.) is not more than that necessary for successful communication.

This radio transmitter has been approved by Industry Canada to operate with the antenna types listed in the user guide with the maximum permissible gain and required antenna impedance for each antenna type indicated. Antenna types not included in this list, having a gain greater than the maximum gain indicated for that type, are strictly prohibited for use with this device.

Cet appareil numérique de la classe A ou B est conforme à la norme NMB-003 du Canada.

Les changements ou les modifications pas expressément approuvés par la partie responsable de la conformité ont pu vider l'autorité de l'utilisateur pour actionner l'équipement.

Concernant les EVMs avec appareils radio

Le présent appareil est conforme aux CNR d'Industrie Canada applicables aux appareils radio exempts de licence. L'exploitation est autorisée aux deux conditions suivantes : (1) l'appareil ne doit pas produire de brouillage, et (2) l'utilisateur de l'appareil doit accepter tout brouillage radioélectrique subi, même si le brouillage est susceptible d'en compromettre le fonctionnement.

Concernant les EVMs avec antennes détachables

Conformément à la réglementation d'Industrie Canada, le présent émetteur radio peut fonctionner avec une antenne d'un type et d'un gain maximal (ou inférieur) approuvé pour l'émetteur par Industrie Canada. Dans le but de réduire les risques de brouillage radioélectrique à l'intention des autres utilisateurs, il faut choisir le type d'antenne et son gain de sorte que la puissance isotrope rayonnée équivalente (p.i.r.e.) ne dépasse pas l'intensité nécessaire à l'établissement d'une communication satisfaisante.

Le présent émetteur radio a été approuvé par Industrie Canada pour fonctionner avec les types d'antenne énumérés dans le manuel d'usage et ayant un gain admissible maximal et l'impédance requise pour chaque type d'antenne. Les types d'antenne non inclus dans cette liste, ou dont le gain est supérieur au gain maximal indiqué, sont strictement interdits pour l'exploitation de l'émetteur.

【Important Notice for Users of this Product in Japan】

This development kit is NOT certified as Confirming to Technical Regulations of Radio Law of Japan

If you use this product in Japan, you are required by Radio Law of Japan to follow the instructions below with respect to this product:

1. Use this product in a shielded room or any other test facility as defined in the notification #173 issued by Ministry of Internal Affairs and Communications on March 28, 2006, based on Sub-section 1.1 of Article 6 of the Ministry's Rule for Enforcement of Radio Law of Japan,
2. Use this product only after you obtained the license of Test Radio Station as provided in Radio Law of Japan with respect to this product, or
3. Use of this product only after you obtained the Technical Regulations Conformity Certification as provided in Radio Law of Japan with respect to this product. Also, please do not transfer this product, unless you give the same notice above to the transferee. Please note that if you could not follow the instructions above, you will be subject to penalties of Radio Law of Japan.

Texas Instruments Japan Limited
(address) 24-1, Nishi-Shinjuku 6 chome, Shinjuku-ku, Tokyo, Japan

<http://www.tij.co.jp>

【ご使用にあたっての注】

本開発キットは技術基準適合証明を受けておりません。

本製品のご使用に際しては、電波法遵守のため、以下のいずれかの措置を取っていただく必要がありますのでご注意ください。

1. 電波法施行規則第6条第1項第1号に基づく平成18年3月28日総務省告示第173号で定められた電波暗室等の試験設備でご使用いただく。
2. 実験局の免許を取得後ご使用いただく。
3. 技術基準適合証明を取得後ご使用いただく。

なお、本製品は、上記の「ご使用にあたっての注意」を譲渡先、移転先に通知しない限り、譲渡、移転できないものとします。

上記を遵守頂けない場合は、電波法の罰則が適用される可能性があることをご留意ください。

日本テキサス・インスツルメンツ株式会社
東京都新宿区西新宿6丁目24番1号
西新宿三井ビル

<http://www.tij.co.jp>

EVALUATION BOARD/KIT/MODULE (EVM) WARNINGS, RESTRICTIONS AND DISCLAIMERS

For Feasibility Evaluation Only, in Laboratory/Development Environments. Unless otherwise indicated, this EVM is not a finished electrical equipment and not intended for consumer use. It is intended solely for use for preliminary feasibility evaluation in laboratory/development environments by technically qualified electronics experts who are familiar with the dangers and application risks associated with handling electrical mechanical components, systems and subsystems. It should not be used as all or part of a finished end product.

Your Sole Responsibility and Risk. You acknowledge, represent and agree that:

1. You have unique knowledge concerning Federal, State and local regulatory requirements (including but not limited to Food and Drug Administration regulations, if applicable) which relate to your products and which relate to your use (and/or that of your employees, affiliates, contractors or designees) of the EVM for evaluation, testing and other purposes.
2. You have full and exclusive responsibility to assure the safety and compliance of your products with all such laws and other applicable regulatory requirements, and also to assure the safety of any activities to be conducted by you and/or your employees, affiliates, contractors or designees, using the EVM. Further, you are responsible to assure that any interfaces (electronic and/or mechanical) between the EVM and any human body are designed with suitable isolation and means to safely limit accessible leakage currents to minimize the risk of electrical shock hazard.
3. You will employ reasonable safeguards to ensure that your use of the EVM will not result in any property damage, injury or death, even if the EVM should fail to perform as described or expected.
4. You will take care of proper disposal and recycling of the EVM's electronic components and packing materials.

Certain Instructions. It is important to operate this EVM within TI's recommended specifications and environmental considerations per the user guidelines. Exceeding the specified EVM ratings (including but not limited to input and output voltage, current, power, and environmental ranges) may cause property damage, personal injury or death. If there are questions concerning these ratings please contact a TI field representative prior to connecting interface electronics including input power and intended loads. Any loads applied outside of the specified output range may result in unintended and/or inaccurate operation and/or possible permanent damage to the EVM and/or interface electronics. Please consult the EVM User's Guide prior to connecting any load to the EVM output. If there is uncertainty as to the load specification, please contact a TI field representative. During normal operation, some circuit components may have case temperatures greater than 60°C as long as the input and output are maintained at a normal ambient operating temperature. These components include but are not limited to linear regulators, switching transistors, pass transistors, and current sense resistors which can be identified using the EVM schematic located in the EVM User's Guide. When placing measurement probes near these devices during normal operation, please be aware that these devices may be very warm to the touch. As with all electronic evaluation tools, only qualified personnel knowledgeable in electronic measurement and diagnostics normally found in development environments should use these EVMs.

Agreement to Defend, Indemnify and Hold Harmless. You agree to defend, indemnify and hold TI, its licensors and their representatives harmless from and against any and all claims, damages, losses, expenses, costs and liabilities (collectively, "Claims") arising out of or in connection with any use of the EVM that is not in accordance with the terms of the agreement. This obligation shall apply whether Claims arise under law of tort or contract or any other legal theory, and even if the EVM fails to perform as described or expected.

Safety-Critical or Life-Critical Applications. If you intend to evaluate the components for possible use in safety critical applications (such as life support) where a failure of the TI product would reasonably be expected to cause severe personal injury or death, such as devices which are classified as FDA Class III or similar classification, then you must specifically notify TI of such intent and enter into a separate Assurance and Indemnity Agreement.

Mailing Address: Texas Instruments, Post Office Box 655303, Dallas, Texas 75265
Copyright © 2012, Texas Instruments Incorporated

IMPORTANT NOTICE

Texas Instruments Incorporated and its subsidiaries (TI) reserve the right to make corrections, enhancements, improvements and other changes to its semiconductor products and services per JESD46, latest issue, and to discontinue any product or service per JESD48, latest issue. Buyers should obtain the latest relevant information before placing orders and should verify that such information is current and complete. All semiconductor products (also referred to herein as "components") are sold subject to TI's terms and conditions of sale supplied at the time of order acknowledgment.

TI warrants performance of its components to the specifications applicable at the time of sale, in accordance with the warranty in TI's terms and conditions of sale of semiconductor products. Testing and other quality control techniques are used to the extent TI deems necessary to support this warranty. Except where mandated by applicable law, testing of all parameters of each component is not necessarily performed.

TI assumes no liability for applications assistance or the design of Buyers' products. Buyers are responsible for their products and applications using TI components. To minimize the risks associated with Buyers' products and applications, Buyers should provide adequate design and operating safeguards.

TI does not warrant or represent that any license, either express or implied, is granted under any patent right, copyright, mask work right, or other intellectual property right relating to any combination, machine, or process in which TI components or services are used. Information published by TI regarding third-party products or services does not constitute a license to use such products or services or a warranty or endorsement thereof. Use of such information may require a license from a third party under the patents or other intellectual property of the third party, or a license from TI under the patents or other intellectual property of TI.

Reproduction of significant portions of TI information in TI data books or data sheets is permissible only if reproduction is without alteration and is accompanied by all associated warranties, conditions, limitations, and notices. TI is not responsible or liable for such altered documentation. Information of third parties may be subject to additional restrictions.

Resale of TI components or services with statements different from or beyond the parameters stated by TI for that component or service voids all express and any implied warranties for the associated TI component or service and is an unfair and deceptive business practice. TI is not responsible or liable for any such statements.

Buyer acknowledges and agrees that it is solely responsible for compliance with all legal, regulatory and safety-related requirements concerning its products, and any use of TI components in its applications, notwithstanding any applications-related information or support that may be provided by TI. Buyer represents and agrees that it has all the necessary expertise to create and implement safeguards which anticipate dangerous consequences of failures, monitor failures and their consequences, lessen the likelihood of failures that might cause harm and take appropriate remedial actions. Buyer will fully indemnify TI and its representatives against any damages arising out of the use of any TI components in safety-critical applications.

In some cases, TI components may be promoted specifically to facilitate safety-related applications. With such components, TI's goal is to help enable customers to design and create their own end-product solutions that meet applicable functional safety standards and requirements. Nonetheless, such components are subject to these terms.

No TI components are authorized for use in FDA Class III (or similar life-critical medical equipment) unless authorized officers of the parties have executed a special agreement specifically governing such use.

Only those TI components which TI has specifically designated as military grade or "enhanced plastic" are designed and intended for use in military/aerospace applications or environments. Buyer acknowledges and agrees that any military or aerospace use of TI components which have **not** been so designated is solely at the Buyer's risk, and that Buyer is solely responsible for compliance with all legal and regulatory requirements in connection with such use.

TI has specifically designated certain components which meet ISO/TS16949 requirements, mainly for automotive use. Components which have not been so designated are neither designed nor intended for automotive use; and TI will not be responsible for any failure of such components to meet such requirements.

Products

Audio	www.ti.com/audio
Amplifiers	amplifier.ti.com
Data Converters	dataconverter.ti.com
DLP® Products	www.dlp.com
DSP	dsp.ti.com
Clocks and Timers	www.ti.com/clocks
Interface	interface.ti.com
Logic	logic.ti.com
Power Mgmt	power.ti.com
Microcontrollers	microcontroller.ti.com
RFID	www.ti-rfid.com
OMAP Applications Processors	www.ti.com/omap
Wireless Connectivity	www.ti.com/wirelessconnectivity

Applications

Automotive and Transportation	www.ti.com/automotive
Communications and Telecom	www.ti.com/communications
Computers and Peripherals	www.ti.com/computers
Consumer Electronics	www.ti.com/consumer-apps
Energy and Lighting	www.ti.com/energy
Industrial	www.ti.com/industrial
Medical	www.ti.com/medical
Security	www.ti.com/security
Space, Avionics and Defense	www.ti.com/space-avionics-defense
Video and Imaging	www.ti.com/video

TI E2E Community

e2e.ti.com