

TPA2013D1 Boost Converter Component Selection

Stephen Crump

Audio and Imaging Products

ABSTRACT

Loss of output power is a common problem in battery-powered systems as the battery discharges. This problem can be overcome with a boost converter to power the audio power amplifiers, like the converter and amplifier in TI's TPA2013D1, a single-chip solution. Passive components used with the converter affect its operation dramatically, so it is necessary to choose these components carefully. This application report provides the information needed to make appropriate choices.

Contents

1	Introduction	3
2	TPA2013D1 Configuration.....	4
3	Boost Circuit Operation	4
4	Simplified Boost Circuit Input/Output Relationships.....	5
5	Boost Circuit Inductor	6
6	Boost Circuit Capacitor	10
7	Boost Circuit Stability	15
8	Conclusions	21

List of Figures

1	Effect of Different Inductors on Output Power	3
2	TPA2013D1 Circuit Configuration	4
3	Boost Converter Inductor Charge and Discharge	5
4	Inductor Current Vs Inductor Value	6
5	V_{CC} and Output Power Vs Inductor Value.....	7
6	Inductance and Current of Nonsaturating and Saturating Inductors	8
7	Effect of Different Inductors on V_{CC} and Output Power.....	9
8	Inductor Current Limit Overshoot From Detector Delay	9
9	Boost Converter Ripple Voltage Vs Output Capacitance	11
10	Relative Capacitance Ranges Vs Applied DC Voltage Measured for X5R and Y5V	12
11	Worst Relative Capacitance Vs Applied DC Voltage Measured for X5R and Y5V.....	12
12	Boost Converter Ripple Voltage Vs Output Capacitor Voltage Rating.....	13
13	Boost Converter Stability Vs Output Capacitance and Voltage Rating	14
14	Boost Converter Loop Response Equivalent Circuits	15
15	Boost Converter Effective Output Filter Response With Nonsaturating 4.7- μ H Inductor	16
16	Boost Converter Fixed Gain and Loop Compensation Response	17
17	Boost Converter Overall Loop Response With Nonsaturating 4.7- μ H Inductor.....	17
18	Boost Converter Effective Output Filter Response With Saturating 4.7- μ H Inductor	18
19	Boost Converter Overall Loop Response With Saturating 4.7- μ H Inductor	19
20	Boost Converter Loop Compensation Response Vs Feedback Resistance and Zero Frequency	20
21	Boost Converter Overall Loop Response Vs Feedback Resistance and Zero Frequency	21

List of Tables

1	Maximum Permissible Inductor DCR Vs Output Power.....	10
---	-------------------------------------------------------	----

2	Tolerance and Temperature Coefficients for Different Capacitor Materials	11
---	--------------------------------------------------------------------------------	----

1 Introduction

A common problem in battery-powered systems is loss of output power as the battery discharges. Output power must be reduced or limited to the level available at minimum battery voltage or distortion will become unacceptable. It is possible to overcome this problem by using a boost converter, a switching device that boosts battery output to a fixed higher voltage, to power the amplifiers. TI's TPA2013D1 combines a high-efficiency boost converter with an efficient class-D amplifier to provide a single-chip solution to the problem.

The basics of boost circuit operation are conceptually fairly simple, but the full scope of operation includes a number of subtleties and details that must be understood for successful circuit design. These affect efficiency, reliability, and stability. These effects can be illustrated with a simple example.

Consider an application in which the goal is a 2.2-W output at 10% THD+N with a battery voltage of 3.6 Vdc and a boost circuit output of 5.5 Vdc. The output voltage corresponding to this goal is shown by the green trace in Figure 1. Here the TPA2013D1 boost converter provides a consistent 5.5 Vdc to its class-D amplifier, and the class-D amplifier produces its intended output, 2.2 Wrms at 10% THD+N. Compare this to the red trace, made with a low-current inductor in the boost circuit, which prevents maintaining a consistent 5.5-Vdc output. A high ripple voltage occurs at the boost circuit output, and the class-D amplifier produces only 1.7 W at 10% THD+N, a loss of 22%.

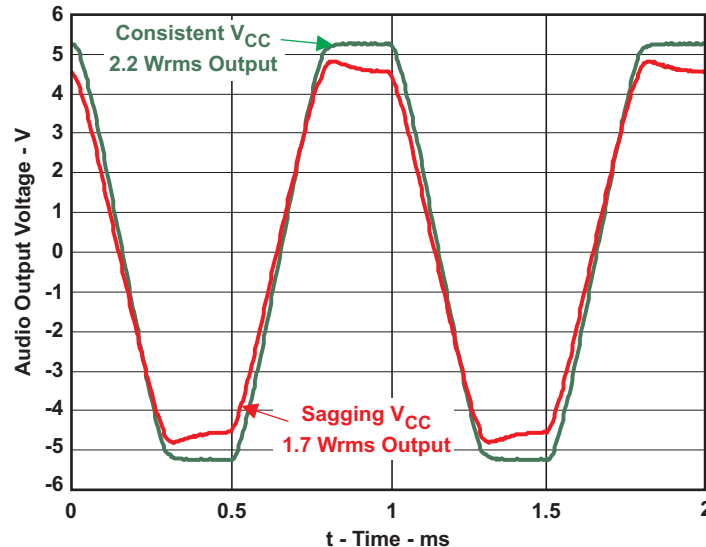

Figure 1. Effect of Different Inductors on Output Power

The difference between the two circuits is simply the inductor. In both cases, the nominal inductor value is 4.7 μ H. However, in the second case, the inductor saturates at fairly low output currents. So, it does not permit the boost converter to transfer the energy required to reach the TPA2013D1 rated output. This demonstrates the importance of selecting the appropriate passive components of a boost converter circuit. This application report provides the information necessary to make the appropriate choices for the TPA2013D1. Full details of boost converter operation can be found in the application report *Understanding Boost Power Stages in Switchmode Power Supplies* (SLVA061).

This document discusses TPA2013D1 configuration, the basics of boost circuit operation and characteristics of boost circuit passive components, their limitations, and the effects of those limitations on circuit operation. The following subjects are discussed.

1. TPA2013D1 Configuration. The block diagram of the integrated circuit (IC) and schematic, including the necessary supporting passive components, are considered.
2. Boost Circuit Operation. Basic theory of operation is discussed.
3. Simplified Boost Circuit Input/Output Relationships. Basic equations governing boost circuit operation

Filter-Free is a trademark of Texas Instruments.

and requirements for supporting passive components are derived.

4. Boost Circuit Inductor. Requirements for this component are reviewed.
5. Boost Circuit Capacitor. Requirements for this component are reviewed.
6. Boost Circuit Stability. Requirements for stability are reviewed.
7. Conclusions. Conclusions are provided as a simplified guide for circuit designers.

2 TPA2013D1 Configuration

This document refers to the TPA2013D1 and its pin designations in describing boost circuit operation. The designators V_{DD} and V_{CC} are used for input voltage and output voltage, respectively, to indicate those quantities. The IC, including its boost converter and class-D amplifier, is connected as shown in Figure 2.

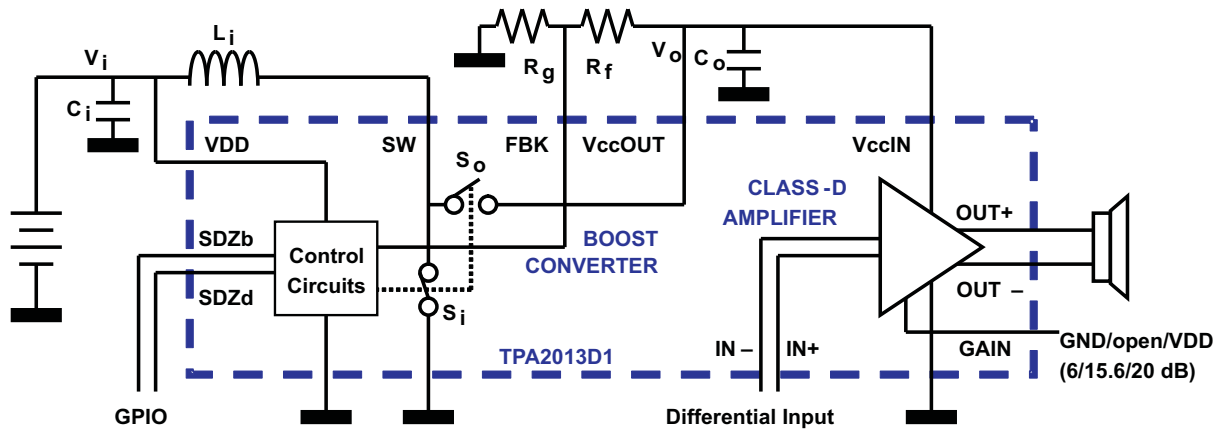

Figure 2. TPA2013D1 Circuit Configuration

The boost converter section includes connections for V_i or V_{DD} and the boost switches, feedback, and shutdown control. The basics of its operation are described in the next section. The class-D section includes a differential input, a Filter-Free™ differential or bridge-tied output, a 3-step gain control, and an independent V_{CC} input.

3 Boost Circuit Operation

A boost circuit produces output voltage by charging an input inductor with current from an input voltage source and then discharging the inductor into an output capacitor. The load for the boost circuit is connected across the output capacitor. The inductor is switched at a high frequency by a switch and a diode or a pair of switches.⁽¹⁾ The charge and discharge duty cycles typically are controlled by analog feedback to a PWM controller that adjusts switch duty cycles to keep the output at a target voltage.

The basic elements and the two switch modes of the boost converter in the TPA2013D1 are illustrated in the schematics of Figure 3. Input switch S_i and output switch S_o are alternately closed and opened to charge input inductor L_i with current and then discharge it into output capacitor C_o to create output voltage V_o , which feeds load Z_L . The feedback path and PWM generator provide the control to maintain a stable, constant output voltage.

⁽¹⁾ A switch and a diode provide the simplest circuit configuration, but in low-voltage circuits the voltage drop across a diode causes relatively high losses and reduces efficiency. The TPA2013D1 uses a pair of switches driven in opposite phase, a configuration called synchronous rectification, to achieve its high efficiency.

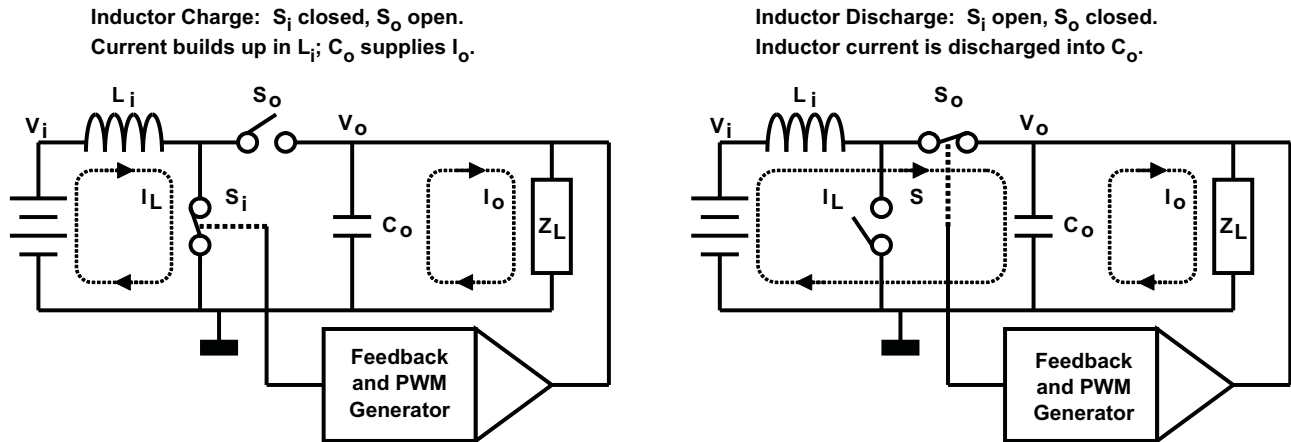

Figure 3. Boost Converter Inductor Charge and Discharge

A number of issues must be considered before a successful design can be completed.

- Input and output voltage and current relationships.
- Requirements for passive components.
- Shortcomings of these components.
- Stability of the feedback loop.

Each of these is considered in the following text.

4 Simplified Boost Circuit Input/Output Relationships

A simplified analysis of steady-state operation of a boost circuit in which losses are ignored provides the following input-output equations for average voltages and currents. The duty cycle of switch S_1 is "d". The second equation follows from the fact that power output must equal power input.

$$\text{Output-to-input voltage ratio: } (V_o / V_i) = 1 / (1 - d).$$

$$\text{Output-to-input current ratio: } (I_o / I_i) = (V_i / V_o) = (1 - d).$$

The first equation shows how to adjust switch duty cycle to achieve a desired output voltage, an important point in determining feedback. The second equation emphasizes that input and output currents are inversely related to input and output voltages as in a transformer. This is an important point in selecting the inductor.

Two other quantities that are crucial in the design of a boost circuit are peak-to-peak ripple current in the inductor, ΔI_L , and peak-to-peak ripple voltage on the capacitor, ΔV_C . These can be calculated with the following equations, which include a formula for d used in the other two equations. The switching period is T_c .

$$\text{Switch duty cycle: } d = [(V_o - V_i) / V_o]$$

$$\text{Inductor ripple current: } \Delta I_L = V_i \times T_c \times [(V_o - V_i) / V_o] / L_i$$

$$\text{Capacitor ripple voltage: } \Delta V_C = I_o \times T_c \times [(V_o - V_i) / V_o] / C_o$$

The ideal results presented here must be adjusted when losses and nonlinearities are considered, but the analysis is complicated. Losses and nonlinearities are approached by examining specific cases. Several other factors are important in boost circuit operation, including the following.

- Input current through the switches in a boost converter must be limited to avoid damaging or destroying them. This imposes a limit on peak inductor current.
- Because of this limit on peak inductor current, inductor ripple current must be kept small relative to inductor average current to maximize average inductor current.
- Capacitor ripple current must be kept small compared to average capacitor voltage to avoid problems

with power supply ripple and EMC (electromagnetic compliance).

5 Boost Circuit Inductor

The inductor is typically larger and more expensive than the other boost circuit components and the most difficult of them to specify. It is important to minimize its inductance, size, and cost. However, lower inductance tends to reduce available output current and circuit stability. Although it is tempting to use the smallest SMD inductors, these components are subject to saturation and resistive losses that reduce performance even further.

5.1 Inductor Value

Inductor ripple current varies inversely with inductance, and peak inductor current ultimately must be governed by the boost converter switch current limit. With a fixed peak value for inductor current, increasing ripple current reduces average output current, and this reduces available output current.

The following graph (Figure 4) compares inductor current generated during one cycle into different value inductors by a TPA2013D1 boost converter with an input of 3 Vdc, a load of 10 Ω , and an output target of 5.5 Vdc. The converter operates at frequency f_c of 600 kHz, period 1.67 μ s, and limits switch current at approximately 1.5 A.

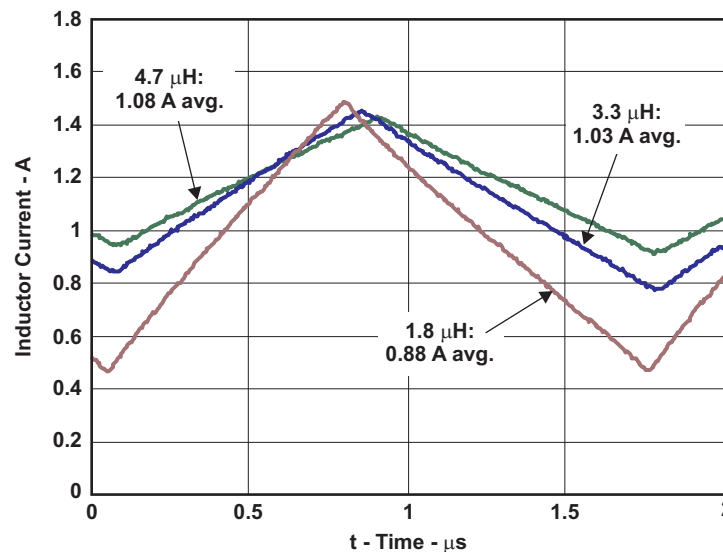

Figure 4. Inductor Current Vs Inductor Value

With each value of inductance, current increases until the current limit is triggered and switch S_1 turns off. The inductor current then discharges until the end of the cycle, returning to its value at the start of the cycle. By symmetry, the average inductor current must be [current limit – (peak-to-peak ripple current)/2]. Obviously, ripple current increases as inductance is reduced, and so average inductor current falls.

Note that the duty cycle of switch S_1 falls as inductance is reduced. This changes the input/output ratio, so that there must be a loss in boost circuit output voltage, the power supply voltage to the class-D amplifier, which reduces available output voltage and power. The effect is small with 4.7 μ H or 3.3 μ H, but larger with 1.8 μ H.

Peak current increases slightly as inductance is reduced. This is because the TPA2013D1 boost converter filters the current signal with a time constant of nominal 100 ns to prevent triggering on noise. This sort of filtering is typical in boost circuits. Current overshoots with low inductance because it permits the current to rise too rapidly. The inductors used to generate the preceding graph are essentially free of saturation up to the TPA2013D1 current limit, and still they have an effect on peak current. A later section discusses how serious the effect of an inductor with significant saturation loss can be.

A reduction in boost circuit output is important because it reduces available audio output power. The graph in Figure 5 compares output voltages from the class-D amplifier using each of the preceding inductors, at 1 kHz and 10% THD+N into 8 Ω. The top traces show boost circuit output voltage in parallel; these are discussed in the following text.

Output voltage, output power, and peak inductor current are almost identical with 4.7 μH and 3.3 μH, because of the small difference in available boost circuit output current. These traces are therefore almost identical. But with 1.8 μH, the boost circuit output current is reduced noticeably, and a loss of audio output power occurs, about 12% compared to 4.7 μH.

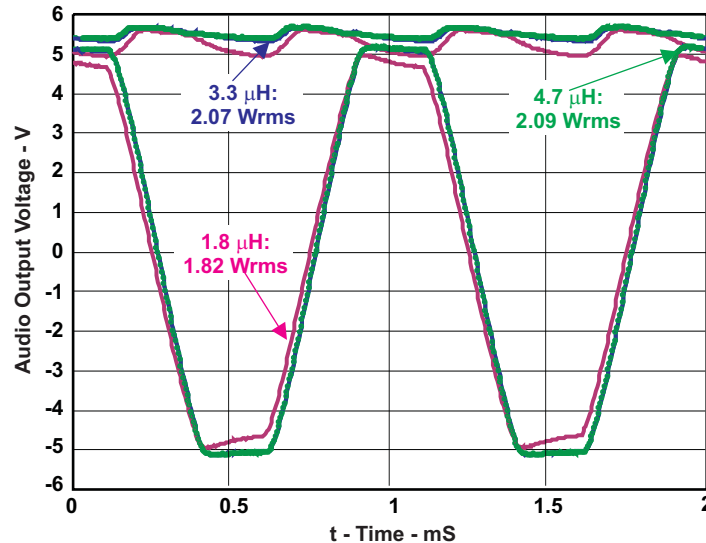

Figure 5. V_{CC} and Output Power Vs Inductor Value

There is a slight sagging in boost circuit output voltage, class-D power supply voltage, with 4.7 μH and 3.3 μH. The power supply sag is larger with 1.8 μH, and this causes the 12% loss in audio output power. Although this is not a serious loss in terms of audibility, it could make meeting a specification for output power more difficult. Before an inductor with low nominal value is used, its effect on audio output power must be understood.

5.2 Inductor Saturation

Inductor saturation can cause greater loss than a nominally low-value inductor because it can reduce incremental inductance dramatically, in some cases to less than 1 μH. Incremental inductance decreases as inductor current increases because of core saturation and loss of core permeability. If the loss is large enough, peak inductor current becomes much larger than average current. Average current falls dramatically and with it, output power. Loss of incremental inductance can even make the boost circuit unstable. Boost circuit control loop response depends partly on the filter that is formed by L_1 and C_o . When the value of one of these is reduced, the unity gain frequency of the loop increases. This effect is discussed later in the document. Inductors suitable for boost circuits retain almost all of their inductance up to the maximum input current. Those inductors that do not retain most of their inductance to that point are probably unsuitable.

Figure 6a compares the inductance of two inductors with a nominal value 4.7 μH versus the current in them. Figure 6b shows current in each inductor when it is used in a TPA2013D1 boost circuit driven to its current limit with input voltage 3.6 Vdc and output voltage target 5.5 Vdc. The first inductor, L1, loses less than 10% of its initial value at 1.5 A, the current limit of TPA2013D1. The second inductor, L2, begins to saturate at approximately 0.2 A and loses more than 80% of its initial value at 1.5 A. L1 produces a nearly constant ramp like those shown in the preceding section, but L2 produces current that rises quickly to a peak and then falls when current limit activates. Three conclusions can be drawn from inspection of the Figure 6b graph.

- Average inductor current is significantly lower with L2 than with L1, and output power is also lower.
- Switch duty cycle is also lower with L2 than with L1, and boost circuit output voltage is also lower.

- Peak inductor current with L2 is well over the expected current limit. As noted previously, boost converters generally require filtering in current sensing to prevent triggering on noise. The necessary delay introduced by this filtering can permit significant overshoot in current limiting with too low an inductance.

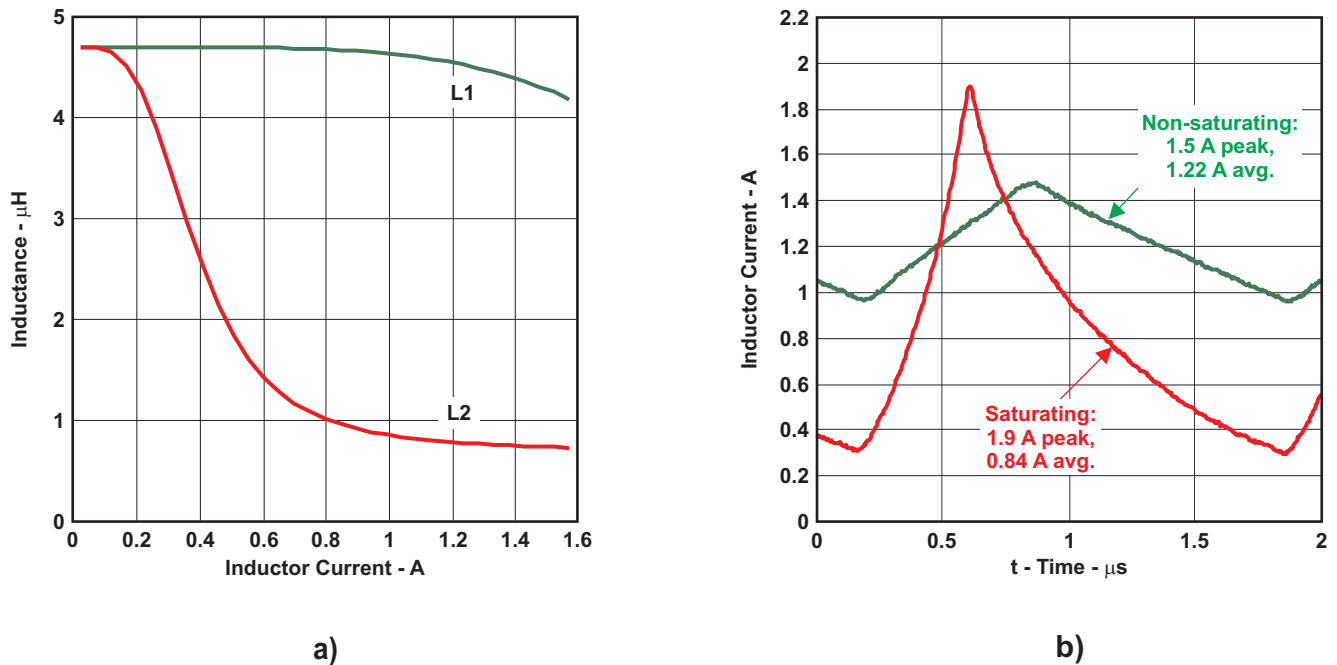

Figure 6. Inductance and Current of Nonsaturating and Saturating Inductors

The first graph of this application report ([Figure 1](#)) compares the result of saturation in L2 to the result of an inductor that does not saturate significantly. The graph is repeated in [Figure 7](#) with traces added for the boost circuit output, the power supply voltage to the class-D amplifier. Power supply ripple caused by a loss of average inductor current during audio output peaks reduces audio output power at 10% THD+N from 2.2 W to 1.7 W. Power supply ripple is essentially negligible with L1, but with L2 it is large enough to cause the boost circuit output to fall more than 0.7 V during the audio output peaks.

Note: L2 is not a defective component or even a poor one. It is possible L2 could be used in relatively low power applications with success. However, L2 is inappropriate for use with the TPA2013D1 in an application in which the target for audio output power is one watt or more.

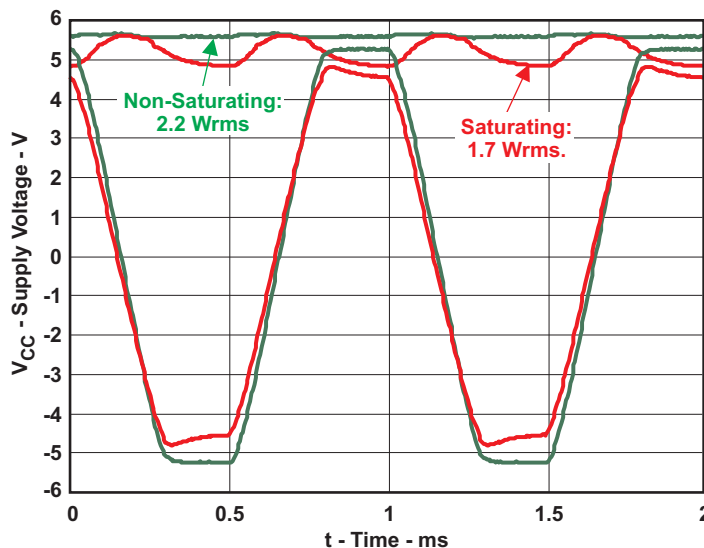

Figure 7. Effect of Different Inductors on V_{CC} and Output Power

In addition to the loss of audio output power, another issue must be considered, current limit overshoot. Peak inductor current reaches 1.9 A with the saturating inductor and input voltage of 3.6 Vdc, as shown in Figure 8a. This overshoot occurs during the 100-ns delay required for filtering against triggering on noise. At the maximum voltage of a Li-Ion battery, nominally 4.2 Vdc, it increases to about 2.1 A, as shown in Figure 8b. With a nonsaturating inductor, peak current is limited to nominal at both input voltages.

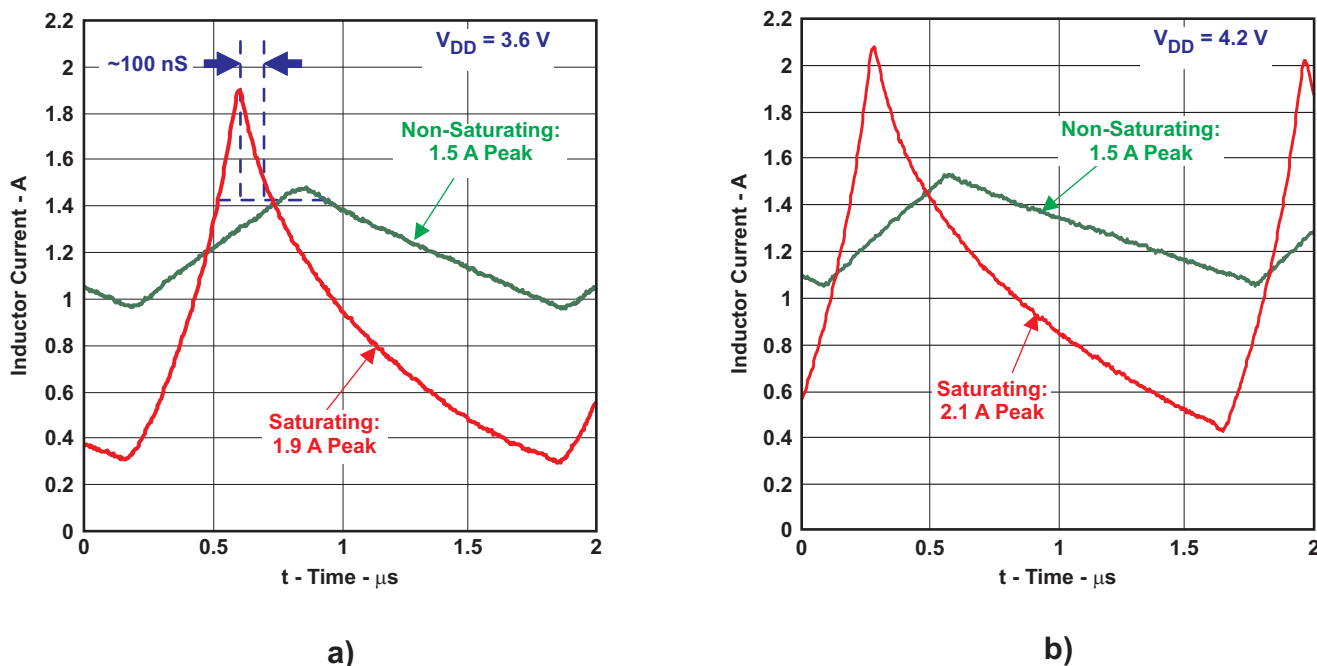

Figure 8. Inductor Current Limit Overshoot From Detector Delay

Inductor current overshoot is an issue because it can reach well above nominal current limit, as in these cases. Repeated overcurrent at levels like these can reduce long-term reliability of the TPA2013D1 (or any other boost converter). So, both nominal value and saturation characteristics must be considered in choosing an inductor. Regarding these parameters, the following rule applies.

Inductance and incremental inductance used with TPA2013D1 must never be less than 2.2 μ H.

Generally, information on inductor saturation is easily available. Inductor manufacturers typically publish data about saturation of their components in graphs of inductance versus dc current or in tables that specify the currents at which inductor values decrease by a specific percentage, typically 10% to 35%. Inductance also is affected by temperature, although the effect is generally not as strong as for dc current. It is vital to review these data before selecting an inductor.

5.3 Inductor and Other Circuit Resistances

Inductor dc resistance (DCR) causes losses because of the rms currents flowing in the inductor. The on-resistances of the switches in TPA2013D1 cause similar losses. Inductor core losses also reduce boost circuit output power, although this effect is typically much smaller than that of DCR. The effective resistance of the switches in the TPA2013D1 synchronous rectifier over the course of a switching cycle is about 190 m Ω , small enough that the losses it causes are not significant even at full inductor current. But if inductor DCR is as large as or larger than the switch resistance, the total resistance may prevent delivering the expected output power.

The effect of circuit resistances is complicated, so no simple equation is available for it. However, the effect can be determined at different power levels to provide a guide to maximum permissible DCR. [Table 1](#) provides such a guide. For intermediate power levels, interpolate.

Table 1. Maximum Permissible Inductor DCR Vs Output Power

Po, W at 1% THD+N	1.0	1.5	2.0
DCR, m Ω maximum	300	180	70

6 Boost Circuit Capacitor

The output capacitor is typically smaller and less expensive than the inductor, but it is just as important to the performance of a boost circuit. It is desirable to minimize its size and cost and therefore its capacitance. However, lower capacitance can compromise circuit stability and EMC⁽¹⁾. Although it is tempting to use the smallest SMD ceramic capacitors, these components are subject to capacitance losses that can compromise stability and EMC even more than low nominal capacitance.

⁽¹⁾ EMC is compliance with regulatory requirements in standardized tests. Electromagnetic interference (EMI) is audible interference above a specification level caused by electromagnetic fields. Because the design objective in this document is for EMC, EMI is not considered.

6.1 Capacitor Value

Output capacitor ripple voltage varies inversely with capacitance as well as directly with the output current and duty cycle of switch S_1 . It is greatest at minimum input voltage, where switch duty cycle is greatest. The following graph ([Figure 9](#)) compares capacitor voltage during one cycle with a TPA2013D1 boost converter with two different capacitors, an input of 3 Vdc, a nonsaturating 4.7- μ H inductor, a load of 10 Ω , and an output target of 5.5 Vdc.

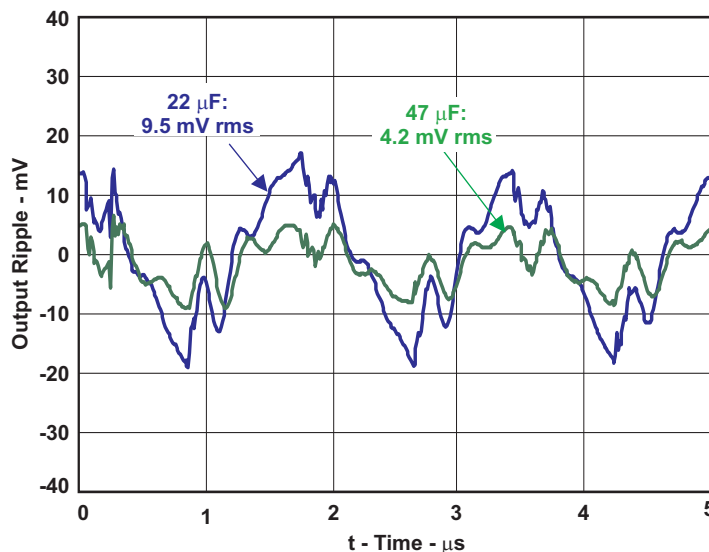

Figure 9. Boost Converter Ripple Voltage Vs Output Capacitance

The ripple voltage waveform is nominally triangular because of the relatively constant currents into and out of the capacitor. However, at low levels like those shown in Figure 9, it is complicated by switching artifacts. The capacitors have nominal values of 47 µF and 22 µF and produce ripple voltages of 4.2 mVrms and 9.5 mVrms. The smaller value produces a larger ripple voltage and is thus more likely to cause difficulty in achieving EMC.

The following equation can be used to try to predict rms ripple voltage.

$$\text{Capacitor RMS ripple voltage: } \Delta V_C \text{ RMS} \approx 0.3 \times I_o \times T_c \times [(V_o - V_i) / V_o] / C_o$$

(RMS value is $\sqrt{\{ (1/T) \times \int (At/T)^2 dt, t = 0 \text{ to } T \}}$, or $\sqrt{\{ (1/T) \times A^2 t^3 / T^2 / 3, t = 0 \text{ to } T \}}$, or $A/\sqrt{3}$, where A is peak value. So compared to peak-to-peak value, ΔV_C , RMS is $0.5/1.723 \approx 0.3$.)

Calculations with this equation predict ripple values of approximately 2.7 mVrms and 5.7 mVrms for these two capacitors, but the measured quantities are 4.2 mVrms and 9.5 mVrms. These differences are not caused by switching artifacts, as might be expected. The artifacts obscure the underlying triangle waveform but do not add significantly to its rms value. The differences are caused by a loss of capacitance in the high-K capacitors used in these measurements, a typical problem with parts like these.

(K is dielectric constant, the relationship between electric field strength in a material and the voltage across it. In high-K materials this “constant” is only a nominal or approximate quantity, because the dielectric constant varies with applied voltage. This will be discussed below.)

High-K capacitors, made of material with high dielectric coefficients like X7R or Y5V, can be smaller than capacitors made of low-K materials like COG. However, high-K materials are less stable than low-K materials. The temperature dependence of various materials, shown in Table 2, is generally well known.

Table 2. Tolerance and Temperature Coefficients for Different Capacitor Materials

Material:	COG/NP0	X7R	X5R	Y5V
Tolerance:	±5%	±10%	±10%	+80/–20%
Temperature Coefficient:	±30 ppm	±15%	±15%	+22/–82%
Range, °C:	–55/+125°C	–55/+125°C	–55/+85°C	–30/+85°C

A capacitor made of X7R material can lose 15% of its initial capacitance at 25°C at any point in the range –55°C to 125°C. Y5V is worse: it can lose 22% over a more narrow temperature range. However, this is not the worst effect encountered in high-K capacitors. Sensitivity to applied voltage is a much greater problem.

In addition to temperature, high-K ceramic capacitors are relatively sensitive to applied voltage, both ac and dc, as well as frequency. Because sensitivity to applied dc voltage is usually a much greater problem than any of the others, the following discussion concentrates on dc voltage sensitivity. [Figure 10](#) and [Figure 11](#) show relative capacitance, capacitance as a percentage of initial capacitance at 0 Vdc voltage versus applied dc voltage as a percentage of rated dc voltage. [Figure 10](#) shows the range of variation that has been observed for X5R and Y5V, with a purple band for the range of variation for X5R and a red band for the range of variation for Y5V. [Figure 11](#) includes only the worst examples.

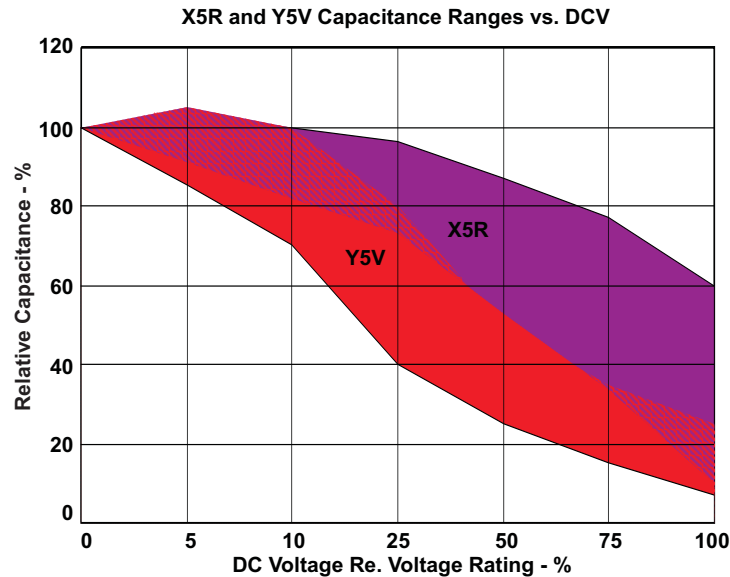

Figure 10. Relative Capacitance Ranges Vs Applied DC Voltage Measured for X5R and Y5V

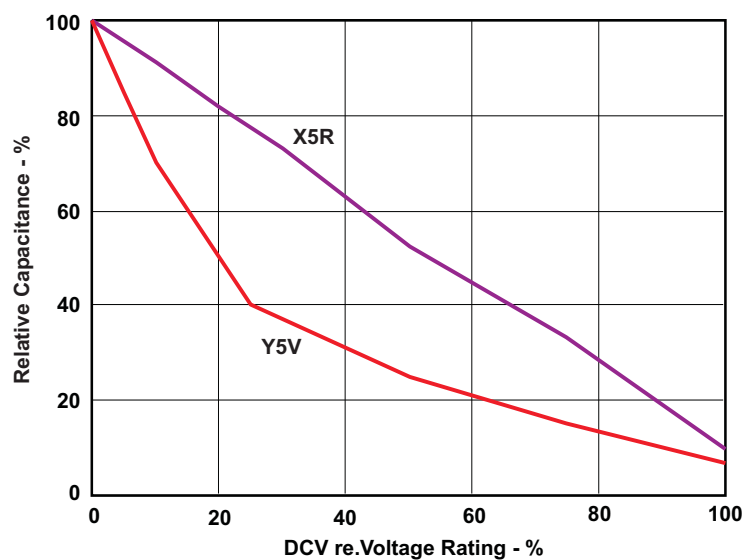

Figure 11. Worst Relative Capacitance Vs Applied DC Voltage Measured for X5R and Y5V

It is possible for an X5R capacitor to lose 60% or more of its initial capacitance at its rated dc voltage. For

Y5V parts, the loss is typically more like 80%. In the graph of ripple voltage measurements (Figure 9), the two capacitors were both X5R, 10 V. A comparison of measured rms ripple voltage to calculations shows that the effective values of the two capacitors were more like 30 μF than 47 μF and more like 13 μF than 22 μF . In each case, the effective value is a little more than 60% of nominal. Boost circuit output voltage of 5.5 Vdc is 55% of the 10-V rating, so this percentage lies in the range for X5R shown in Figure 11.

Results are typically worse with lower-voltage and higher-K capacitors. The following graph (Figure 12) of capacitor ripple voltages repeats the previous one with a third trace added, for a 22 μF , 6.3-V X5R capacitor. The 6.3-V capacitor produces ripple voltage of 16 mVrms. It can be concluded that its effective value is less than 8 μF , about 36% of its nominal value at 0 Vdc. This percentage also lies in the range for X5R shown in Figure 11.

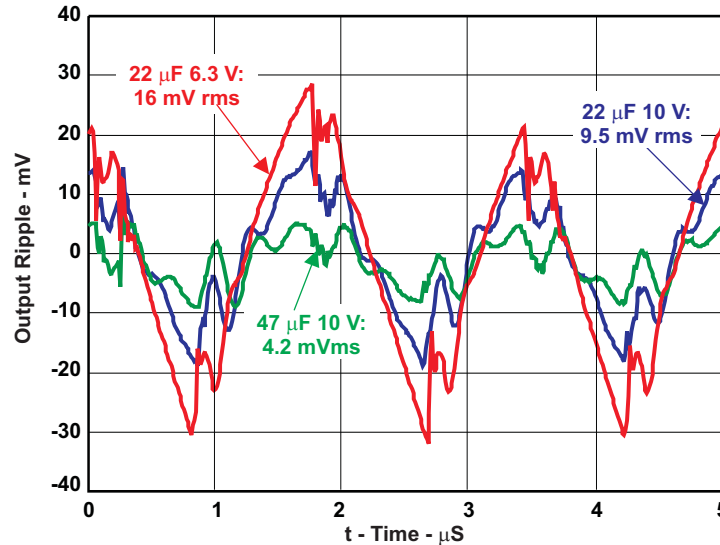

Figure 12. Boost Converter Ripple Voltage Vs Output Capacitor Voltage Rating

While dc voltage sensitivity in the output capacitor can cause increased output ripple voltage and therefore problems with EMC, another issue is potentially worse. As mentioned previously, the response of the feedback loop depends partly on the filter formed by the inductor and output capacitor. If either of these loses a significant part of its expected value, the result can be instability in the boost circuit output.

The graphs shown in Figure 13 compare boost circuit output and ripple voltages against audio output voltages with input voltage 3.6 Vdc, output voltage 5.5 Vdc, load 8 Ω , and two different capacitors. The Figure 13a graph uses the 47- μF , 10-V X5R part from previous measurements, and the Figure 13b graph uses the 22- μF , 6.3-V X5R part. The audio output is set just below the onset of clipping, with THD+N less than 1%. The measurement with the 47- μF , 10-V part shows low boost circuit output ripple and no instability. The measurement with the 22- μF , 6.3-V part, however, shows instability around 60 kHz and slightly higher boost circuit output ripple as a result of the instability.

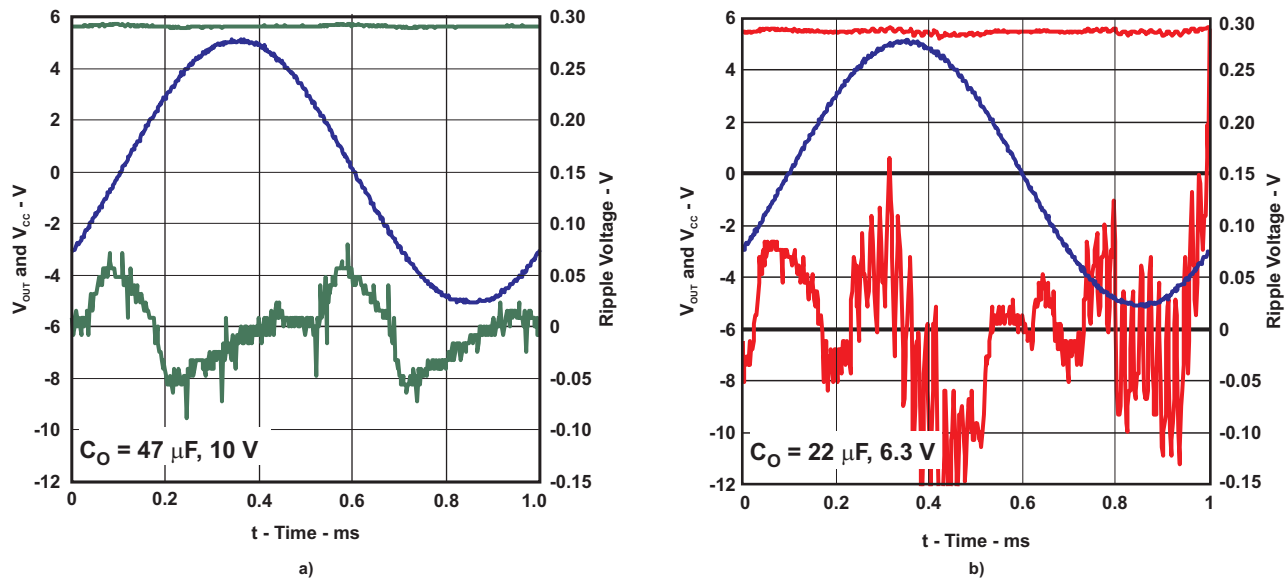

Figure 13. Boost Converter Stability Vs Output Capacitance and Voltage Rating

Audio output power in each case is 1.6 W, so no significant change occurs with the lower value, lower voltage capacitor. However, the instability drives the boost circuit output voltage to peaks that are a significant fraction of a volt over the expected range. The increased voltage produces some risk to long-term reliability of the boost converter. In a circuit with greater instability, the increase in risk is also greater. (A circuit using L2 from the previous discussion and the 22- μF , 6.3-V X5R or a Y5V capacitor is considerably less stable.)

Note: the 22- μF , 6.3-V X5R capacitor is not a defective component. It can be used in other applications with success. However, it is inappropriate to use this capacitor with the TPA2013D1 because of its dc sensitivity and because the TPA2013D1 boost circuit output voltage is a large portion of its rated voltage.

Thus, both nominal value and voltage sensitivity must be considered in choosing a capacitor. The following rule applies.

Capacitance and effective capacitance used with TPA2013D1 must never be less than 12 μF .

7 Boost Circuit Stability

The preceding discussion of instability leads to a consideration of the boost circuit feedback loop response. This response is extremely complex, and a full analysis is therefore beyond the scope of this application report. ⁽¹⁾ Instead, the elements of the response and how passive components affect its closed-loop stability are discussed. Figure 14 shows the closed-loop circuit schematic (a) and the equivalent circuit (b).

- R_f and R_g are the feedback and ground shunt resistors. They cause a fixed low-frequency loss.
- Calculate R_g from R_f : $R_g = R_f \times 0.5 / (V_{CC} - 0.5)$, where the value 0.5 is an internal feedback reference.
- R_z and C_z are internal to TPA2013D1. With R_f and R_g they produce a zero and a high-frequency pole. The zero is used to offset phase lag of the LC filter and restore phase margin near unity loop response.
- A_i is a fixed gain block that provides gain of 4 with phase inversion.
- R_p and C_p are internal to TPA2013D1. They introduce a pole at 180 kHz to eliminate noise.
- A_e is a gain block that includes PWM action and voltage boost. $A_e = V_i / D^2$, where $D^2 = (V_i / V_o)^2$.
- R_e is the effective total of switch resistance R_s of S_i and S_o and DCR of L_i . $R_e = (R_s + DCR) / D^2$.
- L_e is effective inductance. $L_e = L_i / D^2$.
- C_o is output capacitance and R_o is load resistance.
- An element that is not revealed in the schematic is a right-half-plane zero, a characteristic of all boost circuit feedback loops. This zero occurs at approximately $f_{rhp} = R_{load} \times D^2 / L_i$.

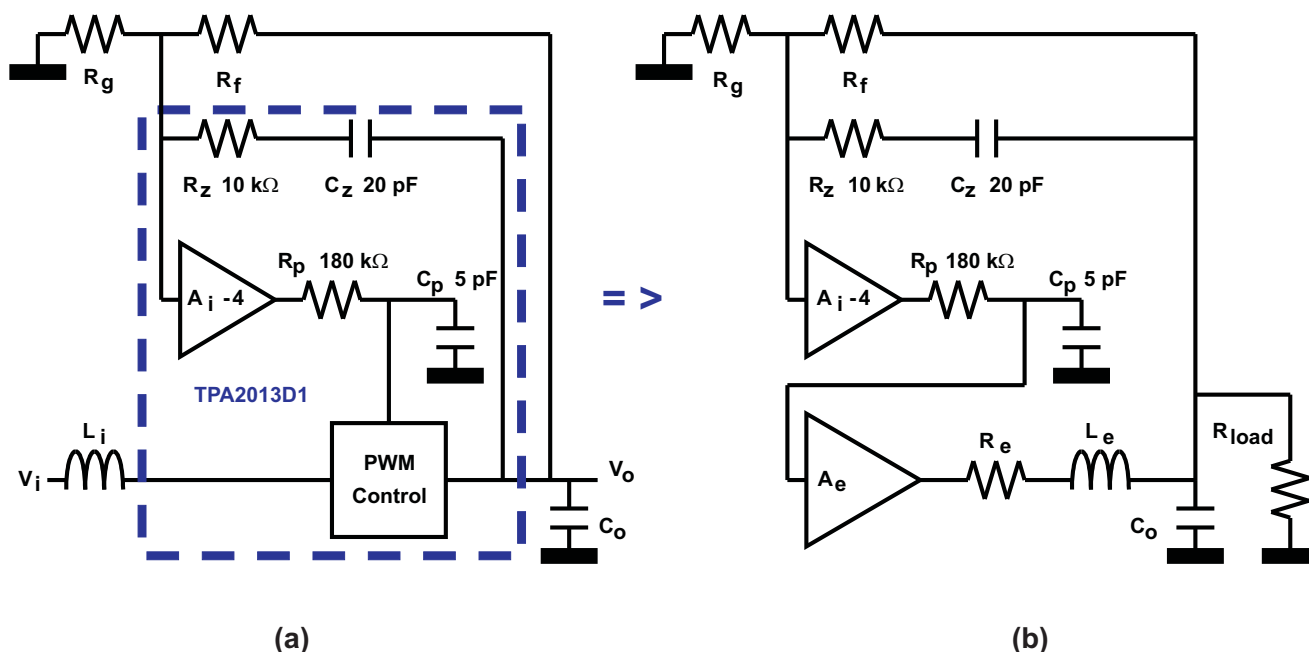
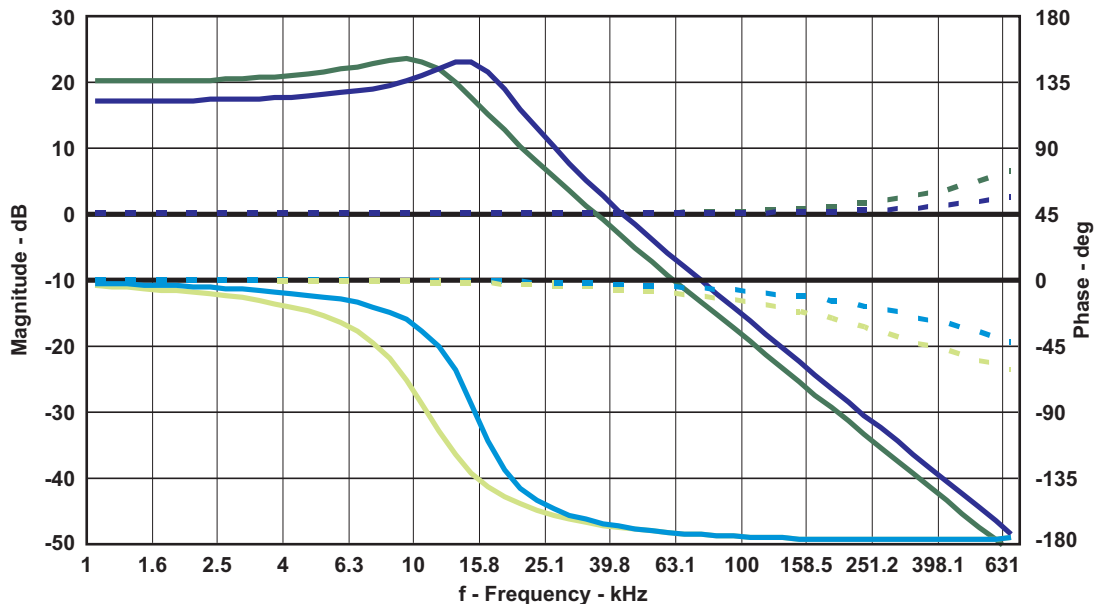

Figure 14. Boost Converter Loop Response Equivalent Circuits

The sections that follow examine the various elements of TPA2013D1 boost circuit response and their combined response. The first section examines the response of gain block A_e and the LC filter plus the RHP zero for a circuit using an appropriate L_i and C_o (see Figure 15). The next section examines the feedback circuit, zero circuit R_z and C_z , fixed gain block A_i , and pole circuit R_f and R_g together as a fairly fixed response. This shows that feedback resistances R_f and R_g must be set to fairly constant values. Finally, the results of the two sections are combined to permit examining gain/phase margin.

Consider a circuit in which L_i is a nonsaturating 4.7-μH inductor with DCR of approximately 30 mΩ and C_o is constant 15 μF. The boost circuit output voltage V_o and current I_o are 5.5 Vdc and 1 A, so the effective R_{load} is 5.5 Ω. Set input voltage V_i to 3 Vdc and 4.2 Vdc. Note the effect on the response of the combined PWM gain block A_e and the LC filter and the response of the RHP zero.

⁽¹⁾ Full details of boost converter operation can be found in the TI application report *Understanding Boost Power Stages in Switchmode Power Supplies* (SLVA061).



$V_i = 3$ Vdc: $A_e = 10.1$ and $L_e = 15.8$ μ H

— = gain block + LC filter response magnitude; — = phase
 - - - = right half plane zero response magnitude; - - - = phase

$V_i = 4.2$ Vdc: $A_e = 7.2$ and $L_e = 8.1$ μ H

— = gain block + LC filter response magnitude; — = phase
 - - - = right half plane zero response magnitude; - - - = phase

Figure 15. Boost Converter Effective Output Filter Response With Nonsaturating 4.7- μ H Inductor

Output voltage of TPA2013D1 boost circuit is typically around 5 Vdc, and the reference voltage for the circuit is 0.5 Vdc. The feedback circuit divides the output voltage by approximately 10 at the feedback input, introducing a loss of approximately 20 dB. The balance of gain in the feedback circuit is A_i , with magnitude 4, or 12 dB. Therefore, net gain of the feedback circuit, independent of the effect of the zero circuit and the pole circuit, is approximately -8 dB. Adding this to the preceding responses shows that the unity magnitude loop response occurs in the range of approximately 25 to 50 kHz, where the LC filter response is approximately +10 dB. Figure 15 indicates that phase margin from the LC filter is small at this point, around 20 degrees. Therefore, it is clear that the margin needs to be improved to ensure stability. This is done in the feedback circuit.

Note that, in this fairly normal case, the phase lag introduced by the RHP zero is negligible compared to phase lag of the LC filter. This is not always the case.

The next graph (Figure 16) shows the response of the combination of the full feedback circuit, including the zero circuit, fixed gain block A_i , and pole circuit. In this case R_f is set to 499 k Ω , so R_g is 49.9 k Ω . This places the zero produced by R_z and C_z at 15.6 kHz and the pole that follows at 123 kHz. Note the addition of the 180-degree inversion in A_i to phase.

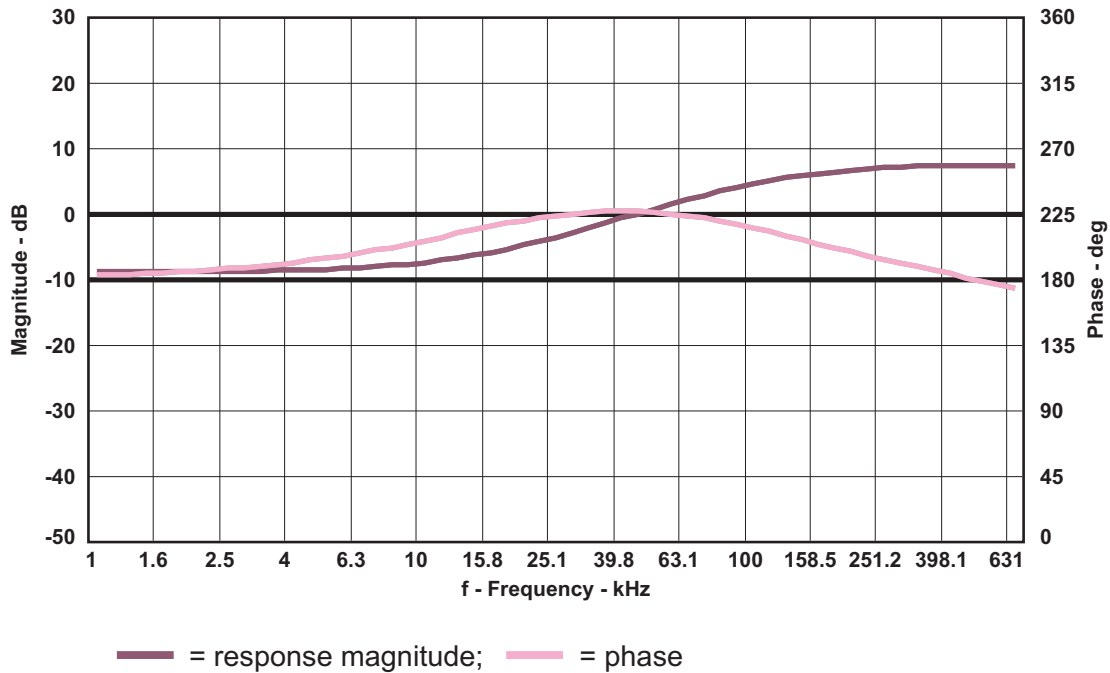
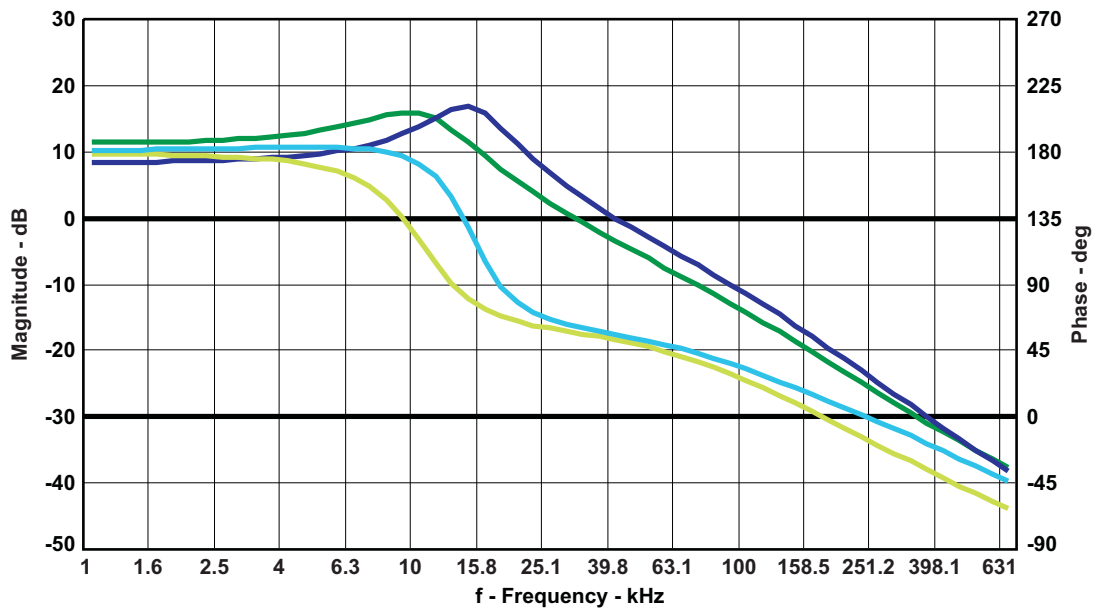

Figure 16. Boost Converter Fixed Gain and Loop Compensation Response

The zero circuit adds a small increase to response magnitude in the range of approximately 25 to 40 kHz. The responses shown in Figure 15 and Figure 16 are combined in the graph of total response (Figure 17), which shows good phase margin.



$V_i = 3 \text{ Vdc}$:

— = total loop response magnitude; — = phase

$V_i = 4.2 \text{ Vdc}$:

— = total loop response magnitude; — = phase

Figure 17. Boost Converter Overall Loop Response With Nonsaturating 4.7- μH Inductor

For the circuit with $L_i = 4.7 \mu\text{H}$, $\text{DCR} = 30 \text{ m}\Omega$, $C_o = 15 \mu\text{F}$, $R_f = 499 \text{ k}\Omega$, $V_o = 5.5 \text{ Vdc}$, $I_o = 1 \text{ A}$, phase and gain margins predicted by simulation are as follows. This circuit has a small risk of instability. See [Figure 17](#).

- $V_i = 3 \text{ Vdc}$
 - Phase margin ≈ 56 degrees at 32 kHz
 - Gain margin ≈ 22 dB at 180 kHz
- $V_i = 4.2 \text{ Vdc}$
 - Phase margin ≈ 56 degrees at 40 kHz
 - Gain margin ≈ 23 dB at 220 kHz

However, margins deteriorate with a saturating inductor, and a voltage-sensitive output capacitor is changed. Presume the inductor is replaced with one that saturates to $1 \mu\text{H}$ at the given output, and the output capacitor is changed to a Y5V part with capacitance that falls to $5 \mu\text{F}$. At the same time, the feedback circuit remains the same as before. A graph of response of the gain plus LC filter block and RHP zero follow ([Figure 18](#)).

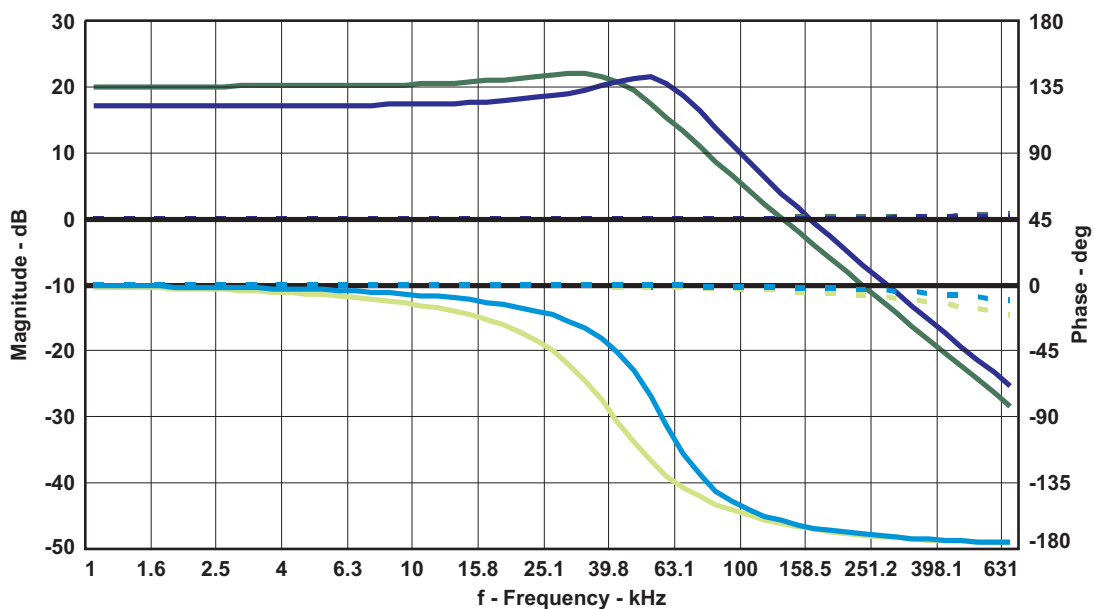

$V_i = 3 \text{ Vdc}$: $A_e = 10.1$ and $L_e = 3.4 \mu\text{H}$

— = gain block + LC filter response magnitude; — = phase
 - - - = right half plane zero response magnitude; - - - = phase

$V_i = 4.2 \text{ Vdc}$: $A_e = 7.2$ and $L_e = 1.7 \mu\text{H}$

— = gain block + LC filter response magnitude; — = phase
 - - - = right half plane zero response magnitude; - - - = phase

Figure 18. Boost Converter Effective Output Filter Response With Saturating 4.7- μH Inductor

The 10-dB-gain response frequency of the gain block plus LC filter has increased dramatically. The next graph ([Figure 19](#)) shows that the unity-gain frequency has increased even more, because the rolloff of the gain block plus LC filter have moved well above the point where the feedback circuit zero begins increasing feedback response gain. The total response is shown in [Figure 19](#). The picture there is not good.

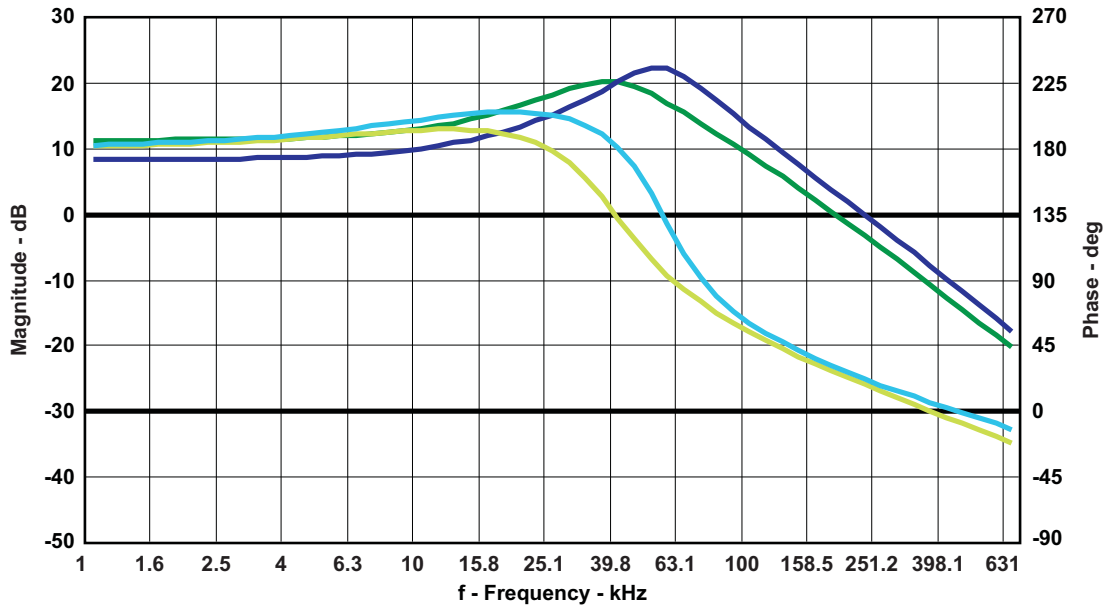

$V_i = 3 \text{ Vdc}$:

— = total loop response magnitude; - - - = phase

$V_i = 4.2 \text{ Vdc}$:

— = total loop response magnitude; - - - = phase

Figure 19. Boost Converter Overall Loop Response With Saturating 4.7- μH Inductor

For the circuit with $L_i = 1 \mu\text{H}$, $\text{DCR} = 30 \text{ m}\Omega$, $C_o = 5 \mu\text{F}$, $R_f = 499 \text{ k}\Omega$, $V_o = 5.5 \text{ Vdc}$, $I_o = 1 \text{ A}$, phase and gain margins have been reduced dramatically, because of the increase in LC filter rolloff frequency. This circuit is marginally stable. See Figure 19.

- $V_i = 3 \text{ Vdc}$
 - Phase margin ≈ 28 degrees at 180 kHz
 - Gain margin ≈ 11 dB at 350 kHz
- $V_i = 4.2 \text{ Vdc}$
 - Phase margin ≈ 22 degrees at 220 kHz
 - Gain margin ≈ 12 dB at 450 kHz

In the simulation model, a 10-pF capacitor has been added across R_g to represent possible stray capacitance there. However, actual parasitic effects are impossible to predict completely. In an actual implementation, parasitic elements can make the situation worse than shown here. In any case, the margins in the revised circuit are not large enough to prevent significant ringing and overshoot at the loop unity-gain frequency. Therefore, the circuit with a saturating inductor and voltage-sensitive output capacitor is unacceptable.

It is difficult to improve margins by varying R_f . In the first case presented, with $L_i = 4.7 \mu\text{H}$, $C_o = 15 \mu\text{F}$, and input voltage fixed at 3 Vdc, varying R_f , by factors of 1/2 and 2 produces the following graph (Figure 20).

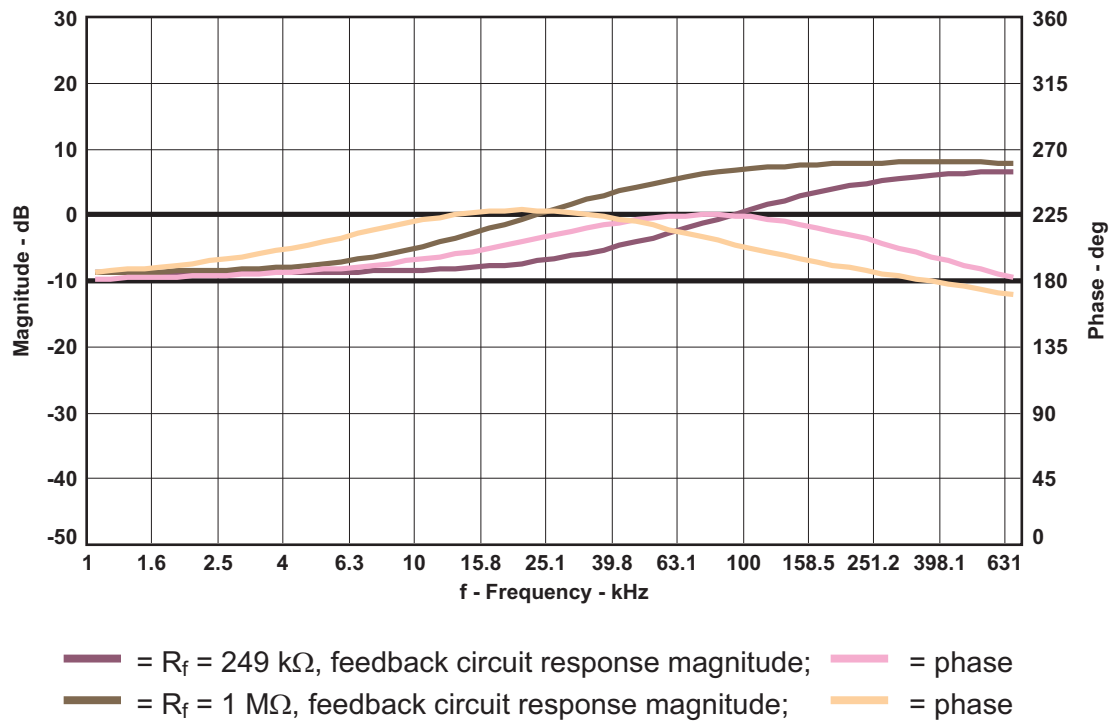

Figure 20. Boost Converter Loop Compensation Response Vs Feedback Resistance and Zero Frequency

With $R_f = 250\text{ k}\Omega$, the zero and following pole occur at twice the previous frequencies. The phase benefit of the zero is not great around the unity-gain frequency of the circuit. With $R_f = 1\text{ M}\Omega$, the zero and following pole occur at half the previous frequencies. So, where the gain block plus LC filter response starts to roll off, the phase benefit of the zero is fading but its gain contribution is high.

The effect can be seen in the following graph (Figure 21) in which $R_f = 249\text{ k}\Omega$ versus $1\text{ M}\Omega$.

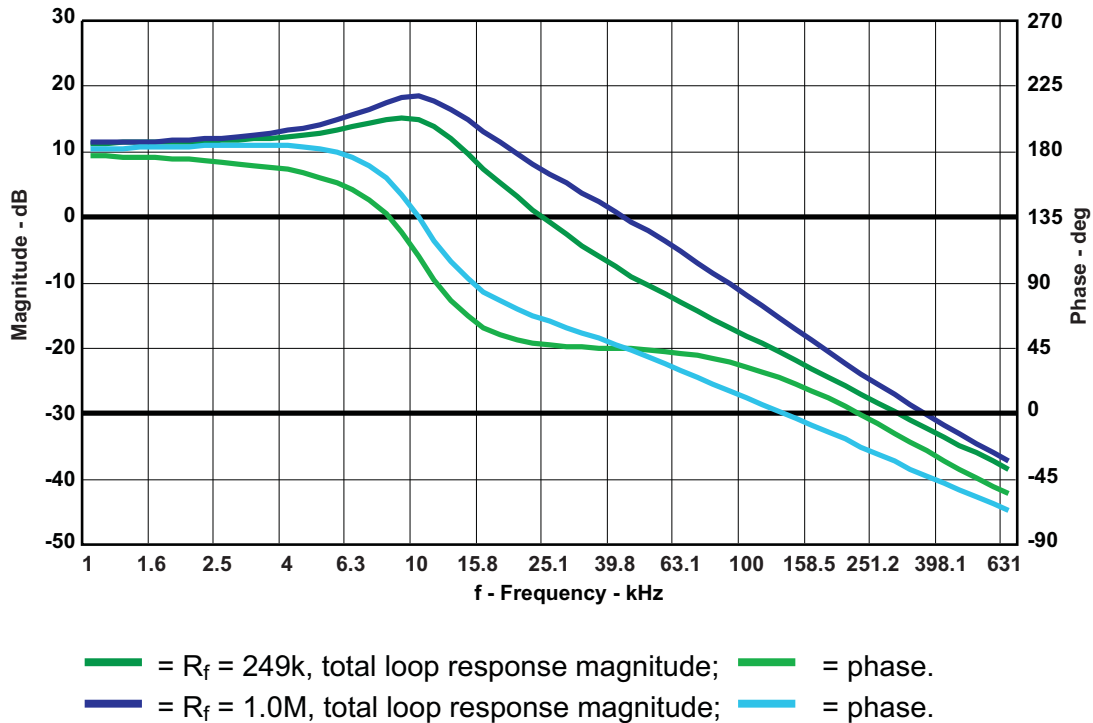

Figure 21. Boost Converter Overall Loop Response Vs Feedback Resistance and Zero Frequency

For the circuit with $L_i = 4.7 \mu\text{H}$, $\text{DCR} = 30 \text{ m}\Omega$, $C_o = 15 \mu\text{F}$, $V_o = 5.5 \text{ Vdc}$, $I_o = 1 \text{ A}$, phase and gain margins predicted by simulation are as follows. In each case, some phase margin has been lost.

- $R_f = 249 \text{ k}\Omega$:
 - Phase margin ≈ 47 degrees at 25 kHz
 - Gain margin ≈ 27 dB at 220 kHz
- $R_f = 1 \text{ M}\Omega$:
 - Phase margin ≈ 43 degrees at 45 kHz
 - Gain margin ≈ 15 dB at 130 kHz

This indicates that a value near 499 k Ω is optimal for R_f .

8 Conclusions

Conclusions that can be drawn from this application report follow.

- Inductor:
 - Output power is nearly constant for high inductor values but falls at low values. Use $L_i = 3.3$ to 6.8 μH for TPA2013D1 in most applications.
 - Limit peak-to-peak ripple current ΔI_L to 40% of average I_L or less to avoid losing output power.
 - Remember that input current I_i is larger than output current I_o ($I_i = I_o \times V_o / V_i$). Ensure that the inductor is rated for input current I_i , not output current I_o .
 - Ensure that inductor L_i retains at least 70% of its nominal value at the peak input current I_i and maximum temperature for a given application.
 - Ensure that inductance of L_i is always more than 2.2 μH , even in saturation and at high temperatures. Otherwise, long-term reliability may be reduced by repeated overcurrent.
 - Minimize inductor DCR to avoid losing output power. Use [Table 1](#) as a guide.
- Output Capacitor:
 - Ensure that effective capacitance is $>12 \mu\text{F}$ for 1-W applications and $>25 \mu\text{F}$ for 2-W applications, even with full dc voltages and at high temperatures. Otherwise, long-term reliability may be reduced

-
- by overvoltage from instability.
- If working capacitance cannot be determined, do the following.
 - Use materials with temperature coefficients at least as good as X5R. Do not use materials like Y5V or Z5U.
 - Use capacitors with voltage ratings at least twice the maximum application voltage. For TPA2013D1, this means at least 10 Vdc.
 - Use capacitors with values 2x calculated values. This plus voltage rating gives the right capacitance.
 - Feedback Resistance:
 - Set feedback resistor $R_f = 499 \text{ k}\Omega$.
 - Set ground resistor $R_g = R_f \times 0.5 / (V_{CC} - 0.5)$.
 - This optimizes phase and gain margin.

IMPORTANT NOTICE

Texas Instruments Incorporated and its subsidiaries (TI) reserve the right to make corrections, modifications, enhancements, improvements, and other changes to its products and services at any time and to discontinue any product or service without notice. Customers should obtain the latest relevant information before placing orders and should verify that such information is current and complete. All products are sold subject to TI's terms and conditions of sale supplied at the time of order acknowledgment.

TI warrants performance of its hardware products to the specifications applicable at the time of sale in accordance with TI's standard warranty. Testing and other quality control techniques are used to the extent TI deems necessary to support this warranty. Except where mandated by government requirements, testing of all parameters of each product is not necessarily performed.

TI assumes no liability for applications assistance or customer product design. Customers are responsible for their products and applications using TI components. To minimize the risks associated with customer products and applications, customers should provide adequate design and operating safeguards.

TI does not warrant or represent that any license, either express or implied, is granted under any TI patent right, copyright, mask work right, or other TI intellectual property right relating to any combination, machine, or process in which TI products or services are used. Information published by TI regarding third-party products or services does not constitute a license from TI to use such products or services or a warranty or endorsement thereof. Use of such information may require a license from a third party under the patents or other intellectual property of the third party, or a license from TI under the patents or other intellectual property of TI.

Reproduction of TI information in TI data books or data sheets is permissible only if reproduction is without alteration and is accompanied by all associated warranties, conditions, limitations, and notices. Reproduction of this information with alteration is an unfair and deceptive business practice. TI is not responsible or liable for such altered documentation. Information of third parties may be subject to additional restrictions.

Resale of TI products or services with statements different from or beyond the parameters stated by TI for that product or service voids all express and any implied warranties for the associated TI product or service and is an unfair and deceptive business practice. TI is not responsible or liable for any such statements.

TI products are not authorized for use in safety-critical applications (such as life support) where a failure of the TI product would reasonably be expected to cause severe personal injury or death, unless officers of the parties have executed an agreement specifically governing such use. Buyers represent that they have all necessary expertise in the safety and regulatory ramifications of their applications, and acknowledge and agree that they are solely responsible for all legal, regulatory and safety-related requirements concerning their products and any use of TI products in such safety-critical applications, notwithstanding any applications-related information or support that may be provided by TI. Further, Buyers must fully indemnify TI and its representatives against any damages arising out of the use of TI products in such safety-critical applications.

TI products are neither designed nor intended for use in military/aerospace applications or environments unless the TI products are specifically designated by TI as military-grade or "enhanced plastic." Only products designated by TI as military-grade meet military specifications. Buyers acknowledge and agree that any such use of TI products which TI has not designated as military-grade is solely at the Buyer's risk, and that they are solely responsible for compliance with all legal and regulatory requirements in connection with such use.

TI products are neither designed nor intended for use in automotive applications or environments unless the specific TI products are designated by TI as compliant with ISO/TS 16949 requirements. Buyers acknowledge and agree that, if they use any non-designated products in automotive applications, TI will not be responsible for any failure to meet such requirements.

Following are URLs where you can obtain information on other Texas Instruments products and application solutions:

Products

Amplifiers	amplifier.ti.com
Data Converters	dataconverter.ti.com
DLP® Products	www.dlp.com
DSP	dsp.ti.com
Clocks and Timers	www.ti.com/clocks
Interface	interface.ti.com
Logic	logic.ti.com
Power Mgmt	power.ti.com
Microcontrollers	microcontroller.ti.com
RFID	www.ti-rfid.com
RF/IF and ZigBee® Solutions	www.ti.com/lprf

Applications

Audio	www.ti.com/audio
Automotive	www.ti.com/automotive
Broadband	www.ti.com/broadband
Digital Control	www.ti.com/digitalcontrol
Medical	www.ti.com/medical
Military	www.ti.com/military
Optical Networking	www.ti.com/opticalnetwork
Security	www.ti.com/security
Telephony	www.ti.com/telephony
Video & Imaging	www.ti.com/video
Wireless	www.ti.com/wireless

Mailing Address: Texas Instruments, Post Office Box 655303, Dallas, Texas 75265
Copyright © 2009, Texas Instruments Incorporated