

TRF79x0ATB NFC/HF RFID Reader Module

User's Guide



Literature Number: SLOU372A
June 2013—Revised June 2014

1	TRF79x0ATB Module Descriptions	5
2	TRF79x0ATB Connections and Technical Details.....	6
3	TRF79x0ATB Module Schematic	8
4	MSP-EXP430F5529 Experimenters Board	11
5	LM4F232 Evaluation Kit (EK-LM4F232).....	12
6	DK-LM3S9B96-EM2-TRF7960R ARM Cortex M-3 Development Board.....	13
7	Quick Start	14
8	Base Application Firmware.....	14
9	Mechanical and Physical Information.....	15
10	Antenna Tuning Details	15
11	TRF79x0ATB Module Read Ranges	19
12	References	20
	Revision History.....	21

List of Figures

1	TRF7960ATB Evaluation Module.....	5
2	TRF7970ATB Evaluation Module.....	6
3	TRF79x0ATB Module Schematic.....	8
4	MSP-EXP430F5438 Development Board	9
5	Debug Header (RF3) Logic Analyzer Connections for Monitoring SPI Communications Between MSP430F5438A and TRF79x0A on TRF79x0ATB Module	10
6	Firmware Development and Debug Setup for MSP-EXP430F5438 Experimenters Board.....	10
7	MSP-EXP430F5529 Development Board.....	11
8	MSP-EXP430F5539 RF EVM Header Pinouts (RF1 and RF2)	11
9	Debug Header (J12) Logic Analyzer Connections for Monitoring SPI Communications Between MSP430F5529 and TRF79x0A on TRF79x0ATB Module	12
10	EK-LM4F232 Development Platform (EM header locations on backside).....	12
11	DK-LM3S9B96-EM2-TRF7960R Development Platform.....	13
12	Theoretical Parallel Resistor Value for Desired Q	17
13	Theoretical Capacitance Values for Resonance at Desired Q	17

List of Tables

1	Connector P1/RF1	6
2	Connector P2/RF2	7

TRF79x0ATB NFC/HF RFID Reader Module

This evaluation module provides directions for TRF7960A and TRF7970A users to implement a 13.56-MHz NFC/RFID reader solution using the TRF79x0A IC connected to a Texas Instruments embedded microcontroller or microprocessor development platform. Examples of such development platforms are: the MSP-EXP430F5438 board, MSP-EXP430F5529 board, the ARM® Cortex™-M3/M4-based board, or any other TI embedded microcontroller platforms with the EM socket headers populated.

This document also covers the TRF79x0ATB module as it relates to using the module for evaluation and development purposes in conjunction with Texas Instruments Embedded Development platforms. It does not cover the in-depth details of the TRF79x0A NFC/RFID IC families, as those details are well documented in the data sheets for those parts, along with application reports that can be found on the product pages (see [Section 12](#)).

FCC/IC Regulatory Compliance:

- FCC – FEDERAL COMMUNICATIONS COMMISSION Part 15, Class A Compliant
- IC – INDUSTRY CANADA Class A Compliant

1 TRF79x0ATB Module Descriptions

The TRF79x0ATB evaluation modules are intended to allow the software application developer to get familiar with the functionalities of either of the TRF79x0A Multi-Standard Fully Integrated 13.56 MHz NFC/RFID reader ICs with the freedom to develop on their Texas Instruments Embedded microcontroller development platform of choice.

The TRF79x0ATB module is also intended to allow customer driven antenna tuning with onboard coil and customer driven antenna form factor design.

The module is hard wired for SPI communications, supports Slave Select and TRF79x0A Direct Mode 2 (default), Direct Mode 1 and Direct Mode 0 operations. The user also has access to and full control over the TRF79x0A EN2 and EN lines, allowing for design and development of ultra low power NFC/HF RFID systems.

The module has an onboard boost converter ([TPS61222DCKT](#)) that boosts +3.3 VDC in to +5 VDC out to TRF79x0A IC for +23 dBm (full transmitter power out) operations.

An impedance matching circuit from 4 Ω to 50 Ω is populated on the module and this is connected to a tuned 50 Ω antenna circuit, which consists of an onboard four turn coil with series and parallel passive elements (capacitors and a resistor).

Test points are available on the board for checking firmware operations with the oscilloscope or logic analyzer, impedance matching and for attaching external antenna.

Connection to Texas Instruments Microcontroller platforms are made via Samtec EM headers located on the underside of the board (Connectors P1/RF1 and P2/RF2).



Figure 1. TRF7960ATB Evaluation Module

Figure 2. TRF7970ATB Evaluation Module

2 TRF79x0ATB Connections and Technical Details

Table 1. Connector P1/RF1

Pin No	Signal Name	Description
1	GND	Ground
2	N/C	
3	MOD	Direct mode, external modulation input
4	N/C	
5	N/C	
6	N/C	
7	IRQ	Interrupt request (from TRF79x0A to MCU)
8	N/C	
9	SYS_CLK	Clock for MCU (optional) If EN = 0 and EN2 = 1, then system clock is set to 60 kHz
10	EN	Chip enable input (If EN = 0, then chip is in power-down mode).
11	N/C	
12	EN2	Pulse enable and selection of power down mode. If EN2 is connected to VIN, then VDD_X is active during power down to support the MCU. Pin can also be used for pulse wake-up from power-down mode.
13	N/C	
14	SLAVE SELECT	Slave Select, I/O_4 (Active Low)
15	N/C	
16	DATA_CLK	Data Clock Input for MCU Communication (from MCU)
17	N/C	
18	MOSI	I/O_7, Master Out, Slave In (Data In from MCU)
19	GND	Ground
20	MISO	I/O_6, Master In, Slave Out (Data Out from TRF7960)

Table 2. Connector P2/RF2

Pin No	Signal Name	Description
1	N/C	
2	N/C	
3	N/C	
4	N/C	
5	N/C	
6	N/C	
7	+3.3VDC IN	+VDC in (to TPS61222DCKT for generation of +5 VDC)
8	N/C	
9	+3.3VDC IN	+VDC in (to TPS61222DCKT for generation of +5 VDC)
10	N/C	
11	N/C	
12	N/C	
13	N/C	
14	N/C	
15	N/C	
16	N/C	
17	N/C	
18	ASK/OOK	Direct mode, selection between ASK and OOK modulation (0 = ASK, 1 = OOK) Also can be configured to provide the received analog signal output (ANA_OUT)
19	N/C	
20	N/C	

MSP-EXP430F5438 Experimenters Board

The MSP430F5438 Experimenter Board (MSP-EXP430F5438) is a development platform for the latest generation MSP430 MCUs. It features a 100-pin socket that supports the [MSP430F5438 data sheet](#) and other devices with similar pinouts. The socket allows for quick upgrades to newer devices or quick applications changes. It is also compatible with many TI low-power RF wireless evaluation modules such as the [CC2520EMK](#) and the TRF79x0ATB module discussed in this document.

The Experimenter Board helps designers quickly learn and develop using the new F5xx MCUs, which provide the industry's lowest active power consumption, more memory and leading integration for applications such as energy harvesting, wireless sensing and automatic metering infrastructure (AMI).

A TI Flash Emulation Tool, like the [MSP-FET430UIF](#), is required to program and debug the MSP430 devices on the experimenter board.

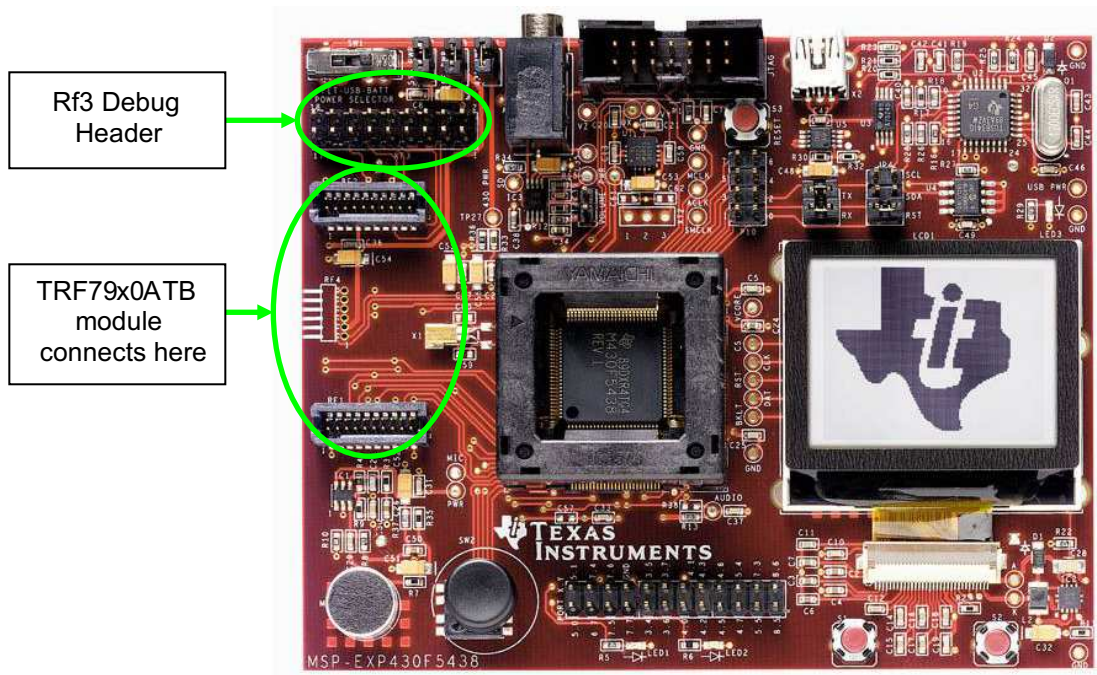

Figure 4. MSP-EXP430F5438 Development Board

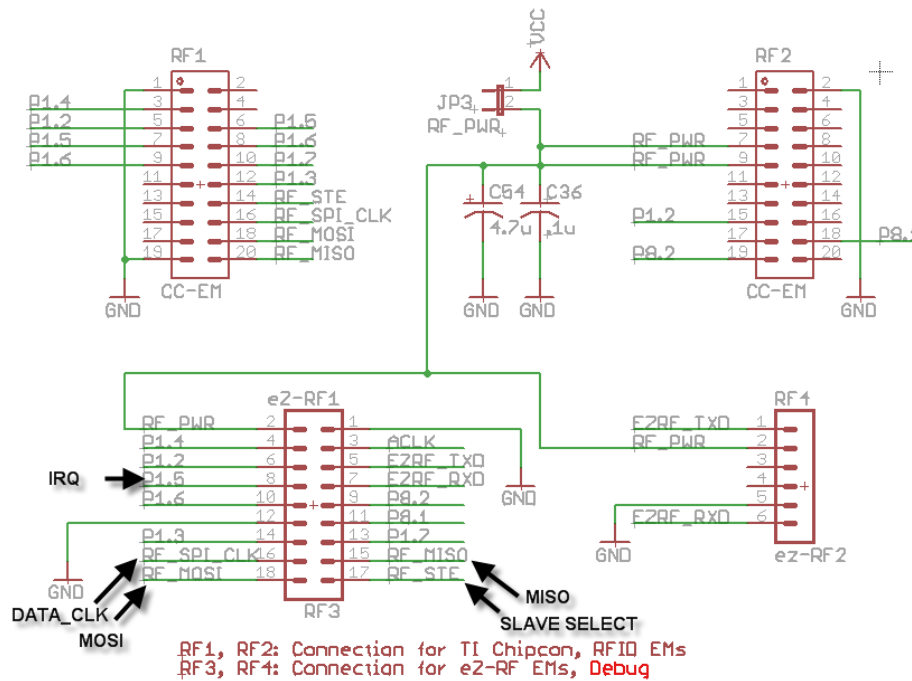

Figure 5. Debug Header (RF3) Logic Analyzer Connections for Monitoring SPI Communications Between MSP430F5438A and TRF79x0A on TRF79x0ATB Module

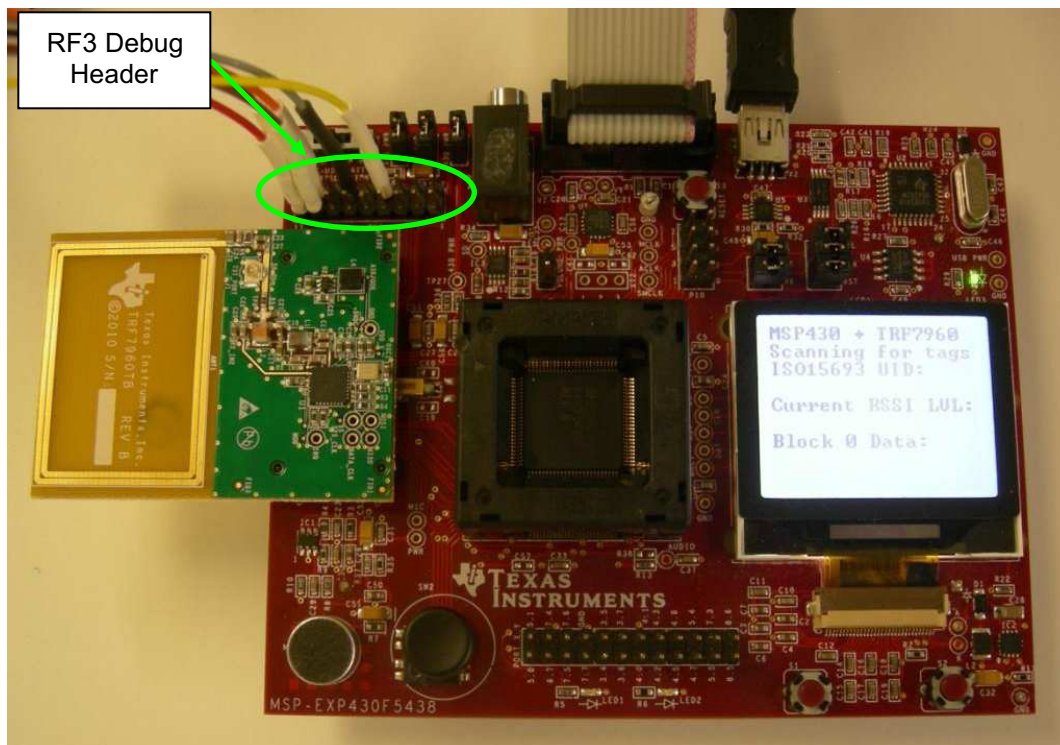

Figure 6. Firmware Development and Debug Setup for MSP-EXP430F5438 Experimenters Board

4 MSP-EXP430F5529 Experimenters Board

The MSP430F5529 Experimenter Board (MSP-EXP430F5529) is a development platform for the MSP430F5529 device, from the latest generation of MSP430 devices with integrated USB. The board is compatible with many TI low-power RF wireless evaluation modules such as the TRF79xxATB modules. The Experimenter Board helps designers quickly learn and develop using the new F55xx MCUs, which provide the industry's lowest active power consumption, integrated USB, and more memory and leading integration for applications such as NFC, HF RFID, energy harvesting, wireless sensing and automatic metering infrastructure (AMI).

The MSP430F5529 device on the experimenter board can be powered and debugged via the integrated ezFET, or via TI Flash Emulation Tool, like the MSP-FET430UIF.

The TRF79x0ATB module plugs into the RF1 and RF2 headers on this MSP-EXP board (see [Figure 7](#) and [Figure 8](#)). For logic analyzer connection during firmware debug, user can use test points on TRF79x0ATB board or pins on header J12 (see [Figure 9](#)).

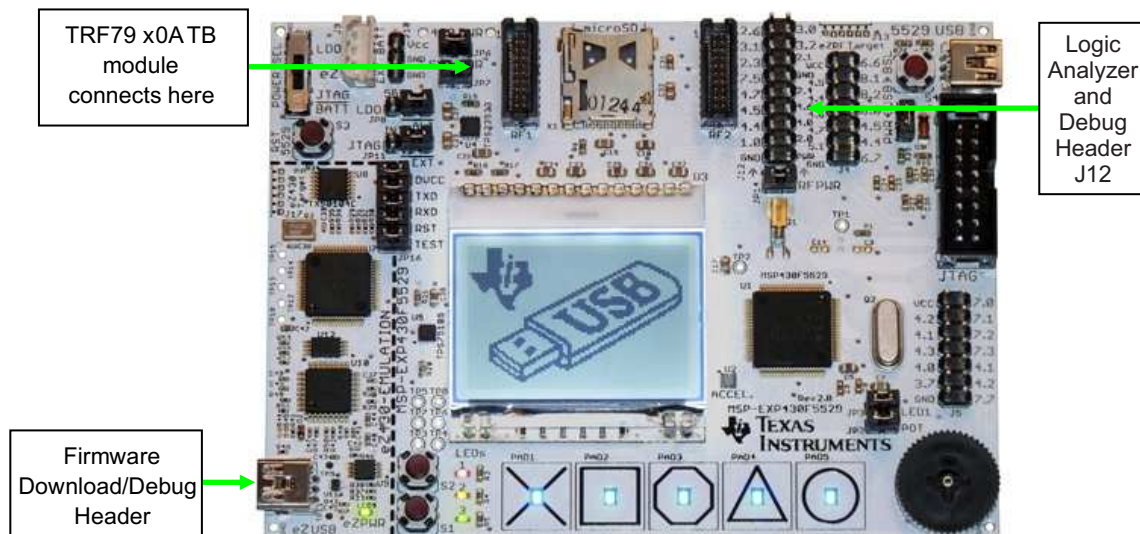

Figure 7. MSP-EXP430F5529 Development Board

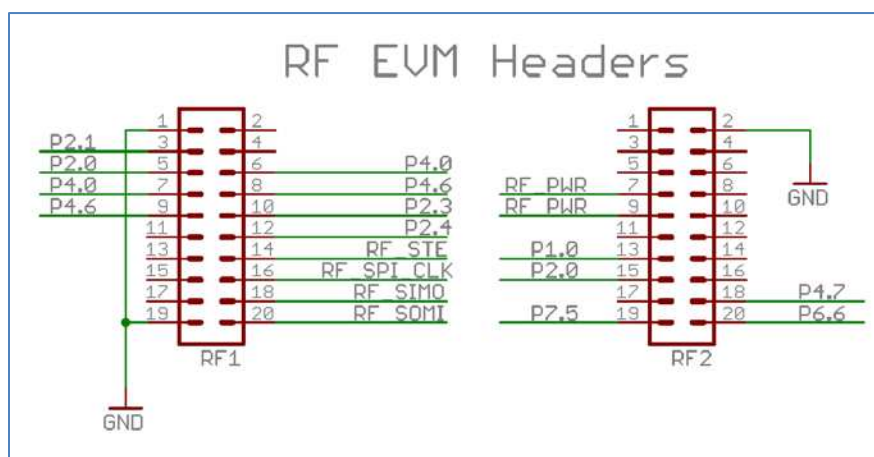

Figure 8. MSP-EXP430F5539 RF EVM Header Pinouts (RF1 and RF2)

6 DK-LM3S9B96-EM2-TRF7960R ARM Cortex M-3 Development Board

The Stellaris® DK-LM3S9B96-EM2-TRF7960R Development Kit provides a feature-rich development platform for Ethernet, USB OTG/Host/Device, and CAN enabled Stellaris ARM Cortex-M3-based microcontrollers. Each board has an In-Circuit Debug Interface (ICDI) that provides hardware debugging functionality not only for the on-board Stellaris devices, but also for any Stellaris microcontroller-based target board. The development kit contains all cables, software, and documentation needed to develop and run applications for Stellaris microcontrollers easily and quickly. The Stellaris DK-LM3S9B96-EM2-TRF7960R Development Kit features: StellarisWare® Peripheral Library, USB Library, and Graphics Library in conjunction with ARM development tools from ARM tools partners. An EPI header to EM header interface board (DK-LM3S9B96-EM2) is needed for use with the TRF7960TB module.



Figure 11. DK-LM3S9B96-EM2-TRF7960R Development Platform

7 Quick Start

1. Plug TRF79x0ATB Module into microcontroller development platform of choice.

NOTE: If DK-LM3S9B96 board, remove SDRAM module and replace with DK-LM3S9B96-EM2 interface board before attempting to mount TRF79x0ATB module.

2. Apply power.
3. Load the base application firmware specific to the platform that you are working with.
4. Test for basic communication and functionality.
5. Modify and Debug code as desired for specific application or protocol.
6. Test for advanced functionality as implemented by modified code.

8 Base Application Firmware

TRF79x0ATB module base application firmware for various Texas Instruments Microcontrollers are available here:

- MSP430F23xx: <http://www.ti.com/litv/zip/sloc203> (Code Composer Studio or IAR)
- MSP430F5438A: <http://focus.ti.com/docs/toolsw/folders/print/msp-exp430f5438.html>
- MSP430F5529: <http://www.ti.com/tool/nfclink>
- LM4F232: <http://www.ti.com/tool/ekc-lm4f232>
- LM3S9B96: <http://www.ti.com/tool/dk-em2-7960r>

9 Mechanical and Physical Information

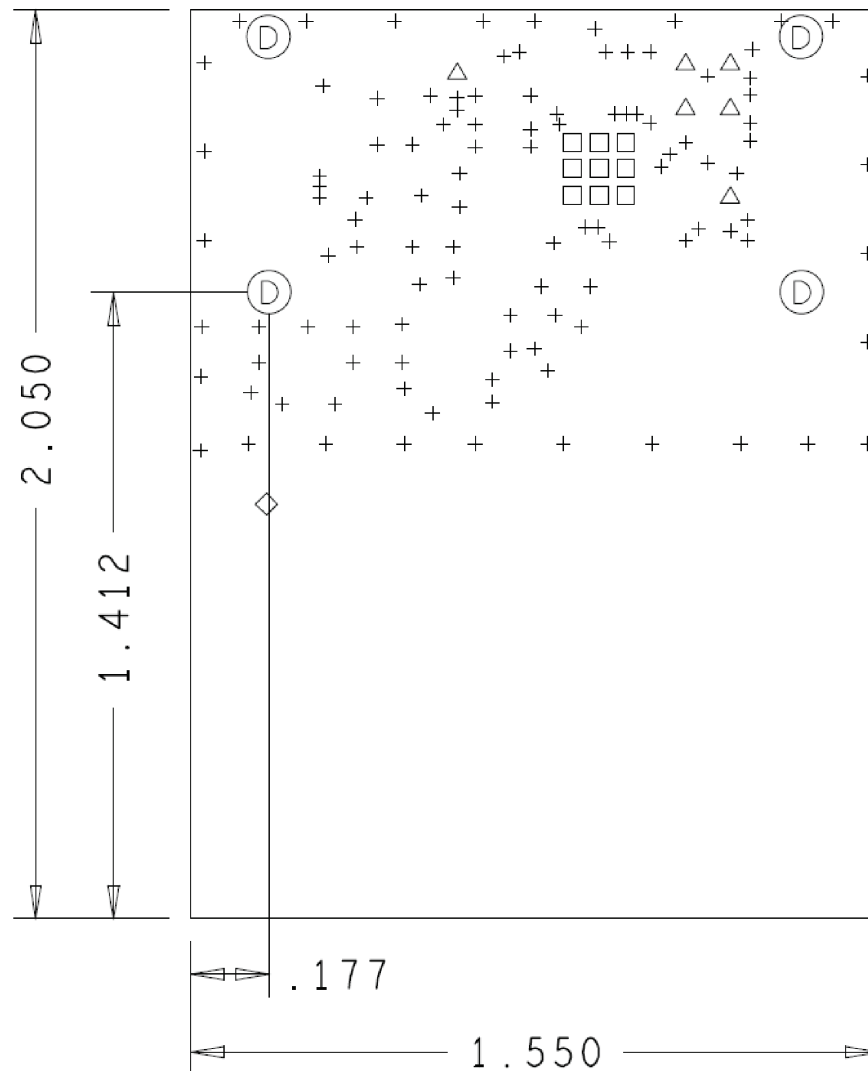

10 Antenna Tuning Details

Module antenna as shipped is tuned for 50 Ω impedance at 13.56 MHz. It has a nominal bandwidth of 1.3 MHz, which results in a quality factor of approximately 10. Module antenna circuit has a board mounted U.FL connector installed for users that want to experiment with different tuning solutions or disconnect onboard antenna and experiment with antennas of their own design or application. Below are some design and application notes for users to reference if they want to change the antenna Q factor or experiment further on their own in order to serve their particular application directly.

TRF79x0ATB coil antenna tuning details starts with calculations to produce the theoretical values shown below (and based on measurements of antenna coil on Rev B board.) The coil value nominally measures 0.95 μH at 13.56 MHz and $X_L = 0.8 + j80.8 = 0.990 @ 63.4^\circ$.

To calculate the necessary values required for course resonance tuning and proper Q setting of the antenna, the following formula is used.

$$C_{RES(total)} = \frac{1}{\omega^2 L}$$

where $\omega = 2\pi f$ (1)

therefore,

$$C_{RES(total)} = \frac{1}{(2\pi \times 13.56 \text{ MHz})^2 \times 0.95 \mu H}$$

$$C_{RES(total)} = 145.157 \text{ pF} \tag{2}$$

The dampening resistor value can now be calculated for a desired Q value using the formula:

$$Q = \frac{R_{PAR}}{2\pi fL} \tag{3}$$

therefore,

$$R_{PAR} = 2\pi fLQ \tag{4}$$

For Q = ~20 (ISO15693 operations):

$$R_{PAR} = 1.29 \text{ k}\Omega \tag{5}$$

(move to standard value of 1.3 kΩ)

For Q = ~10 (ISO14443 and ISO15693 operations):

$$R_{PAR} = 647 \Omega \tag{6}$$

(move to standard value of 680 Ω)

Smith Chart simulation for R_{PAR} value = 1.3 kΩ reveals theoretical parallel and series capacitor values to be 97pF and 51pF, respectively. (This is < +2% change from the calculated total cap value.)

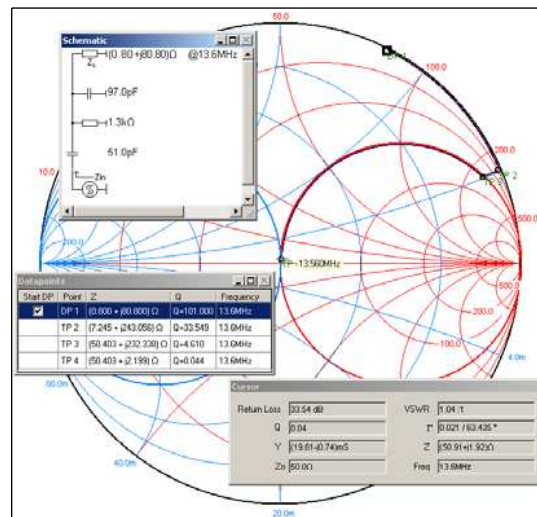

Smith Chart simulation for R_{PAR} value = 680 Ω (standard value) reveals theoretical parallel and series capacitor values to be 82 pF and 69 pF, respectively. (This is < +4% change from the calculated value.)

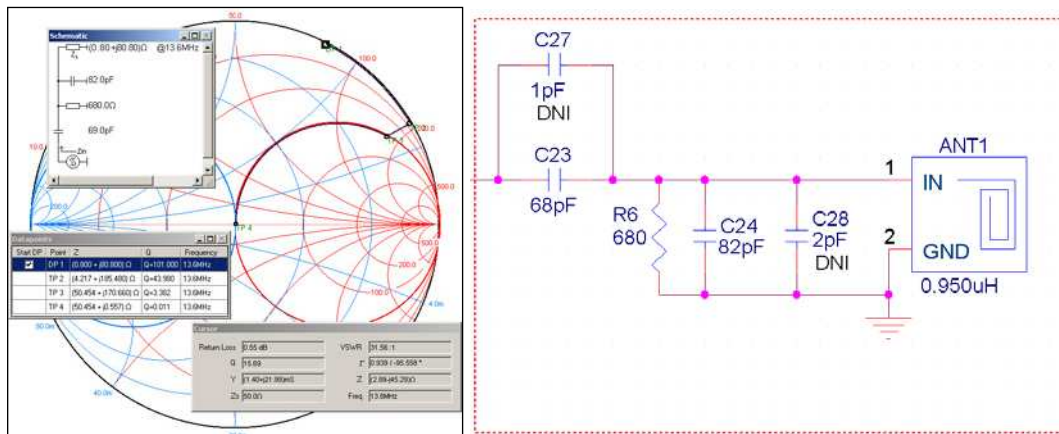

The calculations and simulations for a desired Q range of 5 to 20 results in [Figure 12](#) and [Figure 13](#) that indicate the required resistor and capacitance values should be populated.

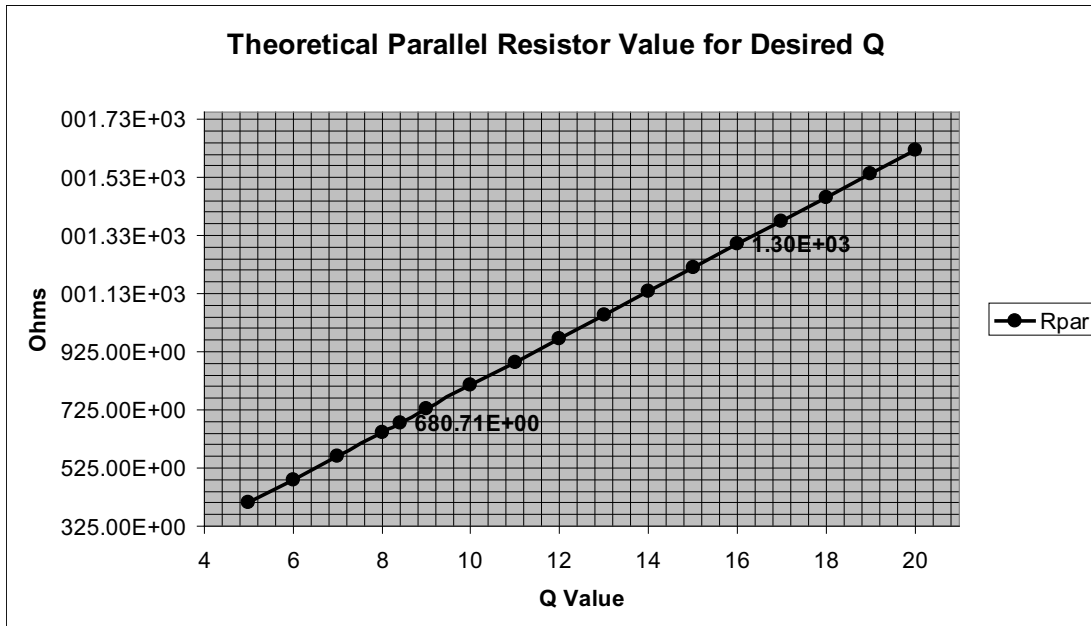

Figure 12. Theoretical Parallel Resistor Value for Desired Q

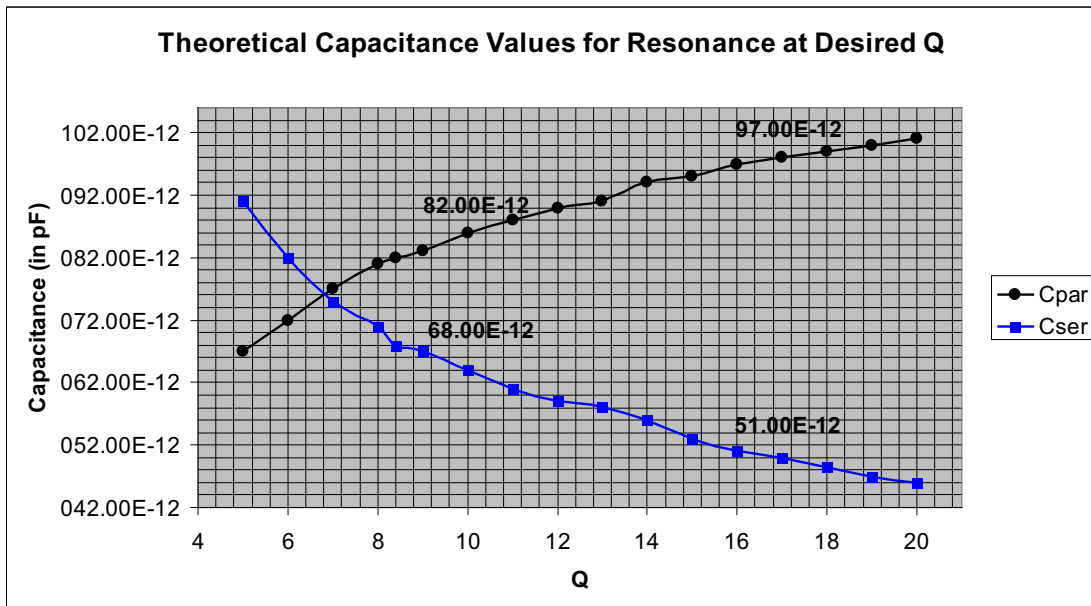
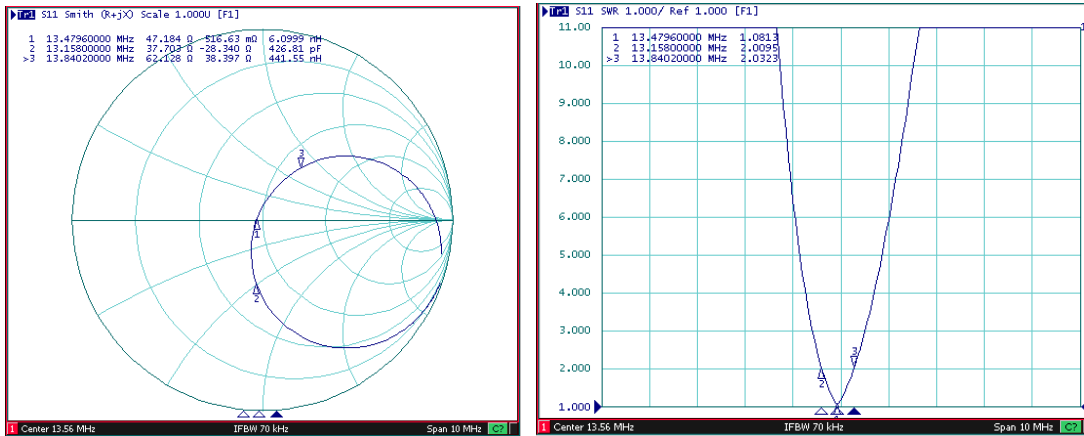
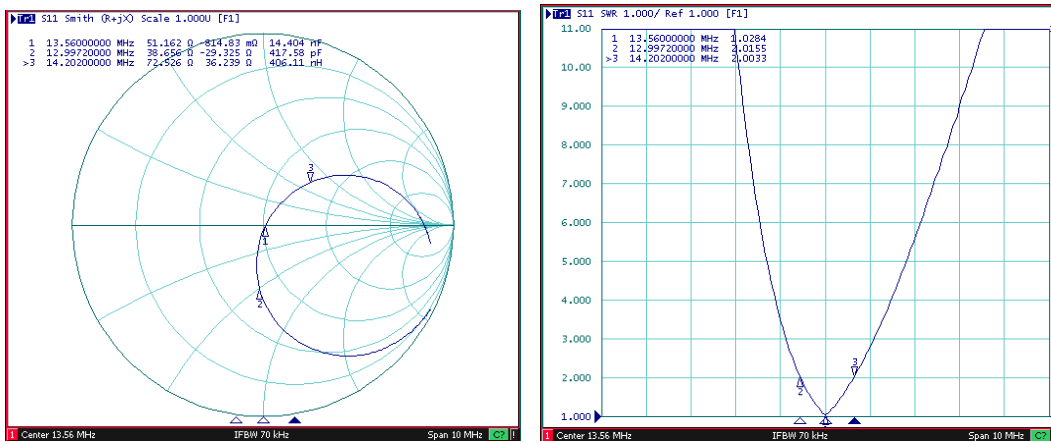

Figure 13. Theoretical Capacitance Values for Resonance at Desired Q

Actual measurements on TRF79x0ATB module for high and lower Q value tuning solutions.



Higher Q Antenna Measurement Plots with Calculated Values (Q = ~20)



Lower Q Antenna Measurement Plots with Calculated Values (Q = ~10)

11 TRF79x0ATB Module Read Ranges

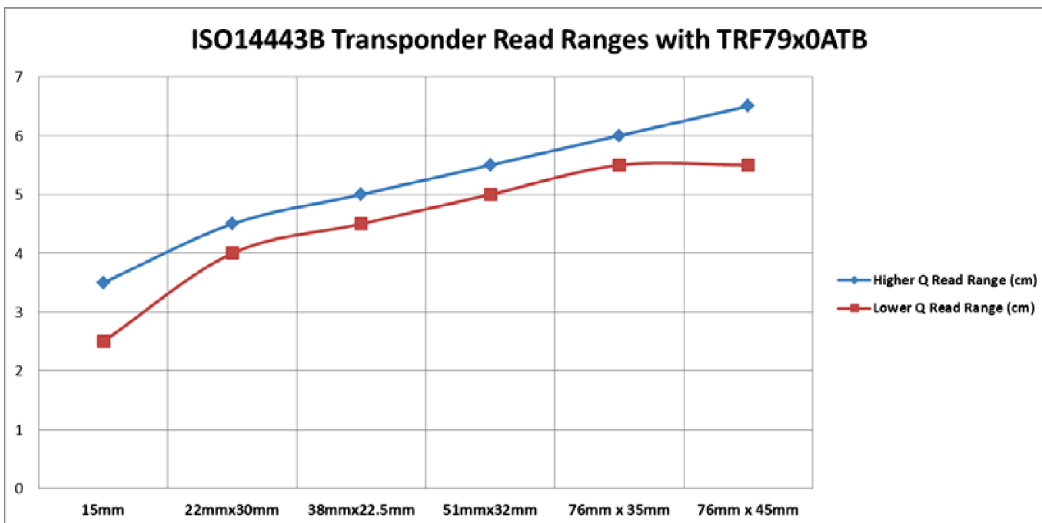
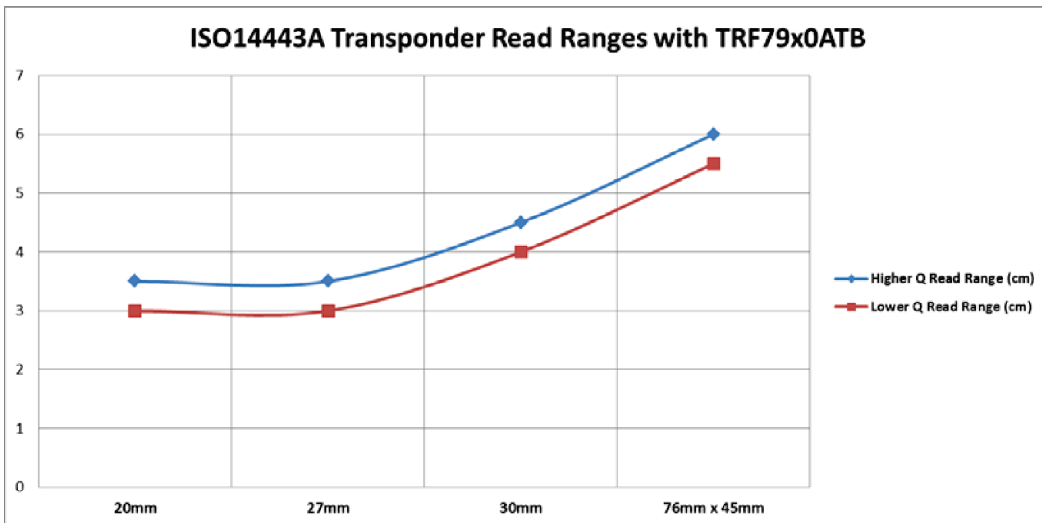
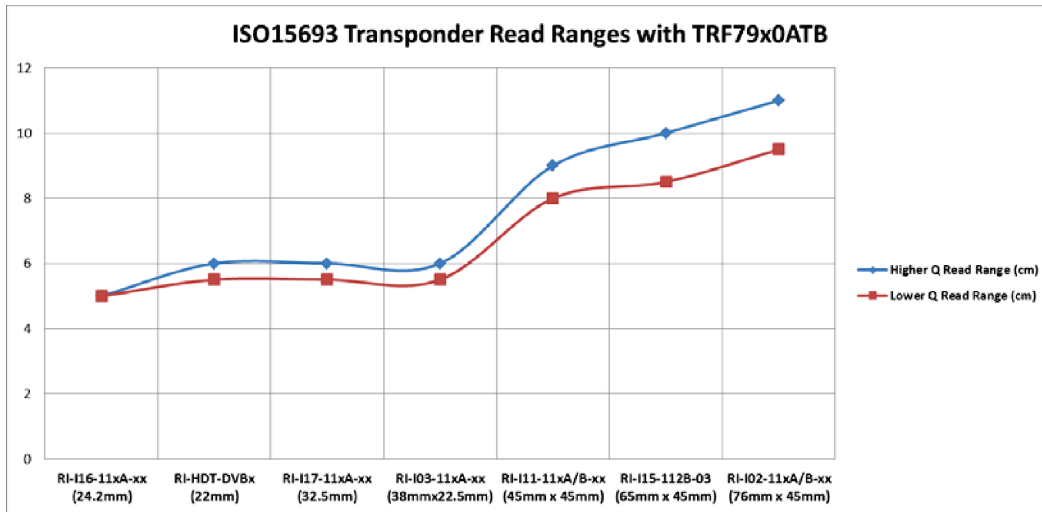

12 References

- TRF7960A Product Page: <http://www.ti.com/product/trf7960A>
- TRF7970A Product Page: <http://www.ti.com/product/trf7970A>
- TPS61222 Product Page: <http://www.ti.com/product/tps61222>
- TRF7960ATB Schematic, BOM and Design files: <http://www.ti.com/lit/zip/sloc221>
- TRF7970ATB Schematic, BOM and Design files: <http://www.ti.com/lit/zip/tidc356>
- LM4F232 Evaluation Kit: <http://www.ti.com/tool/ek-lm4f232>
- *TPS61220, TPS61221, TPS61222 Low Input Voltage Step-Up Converter in 6 Pin SC-70 Package Data Sheet (SLVS776)*
- *MSP430F543x, MSP430F541x Mixed Signal Microcontroller Data Sheet (SLAS612)*
- *TRF7960A Multi-Protocol Fully Integrated 13.56-MHz RFID Reader/Writer IC Data Manual (SLOS732)*
- *TRF7970A Multi-Protocol Fully Integrated 13.56-MHz RFID/Near Field Communication (NFC) Transceiver IC Data Manual (SLOS743)*
- *MSP-EXP430F5529 Experimenter Board User's Guide (SLAU330)*
- *MSP-EXP430F5438 Experimenter Board User's Guide (SLAU263)*
- *Stellaris® LM3S9B96 Development Kit User's Manual (SPMA036)*
- TI ISO15693/ISO18000-3 Inlays/Tags Parametric Search
http://www.ti.com/lstds/ti/wireless_connectivity/nfc_rfid/products.page#o7=Transponders, Inlays and Dies
- Samtec Header and Mate Information
 - SFM: <https://www.samtec.com/technical-specifications/Default.aspx?seriesMaster=SFM>
 - TFM: <https://www.samtec.com/technical-specifications/Default.aspx?seriesMaster=TFM>
- Smith Chart Simulation Tool (licensed copy): <http://www.fritz.dellsperger.net/>

Revision History

Changes from Original (June 2013) to A Revision	Page
--------------------------------------------------------	-------------

- Corrected links in [Section 12](#)..... 20
-

NOTE: Page numbers for previous revisions may differ from page numbers in the current version.

IMPORTANT NOTICE

Texas Instruments Incorporated and its subsidiaries (TI) reserve the right to make corrections, enhancements, improvements and other changes to its semiconductor products and services per JESD46, latest issue, and to discontinue any product or service per JESD48, latest issue. Buyers should obtain the latest relevant information before placing orders and should verify that such information is current and complete. All semiconductor products (also referred to herein as "components") are sold subject to TI's terms and conditions of sale supplied at the time of order acknowledgment.

TI warrants performance of its components to the specifications applicable at the time of sale, in accordance with the warranty in TI's terms and conditions of sale of semiconductor products. Testing and other quality control techniques are used to the extent TI deems necessary to support this warranty. Except where mandated by applicable law, testing of all parameters of each component is not necessarily performed.

TI assumes no liability for applications assistance or the design of Buyers' products. Buyers are responsible for their products and applications using TI components. To minimize the risks associated with Buyers' products and applications, Buyers should provide adequate design and operating safeguards.

TI does not warrant or represent that any license, either express or implied, is granted under any patent right, copyright, mask work right, or other intellectual property right relating to any combination, machine, or process in which TI components or services are used. Information published by TI regarding third-party products or services does not constitute a license to use such products or services or a warranty or endorsement thereof. Use of such information may require a license from a third party under the patents or other intellectual property of the third party, or a license from TI under the patents or other intellectual property of TI.

Reproduction of significant portions of TI information in TI data books or data sheets is permissible only if reproduction is without alteration and is accompanied by all associated warranties, conditions, limitations, and notices. TI is not responsible or liable for such altered documentation. Information of third parties may be subject to additional restrictions.

Resale of TI components or services with statements different from or beyond the parameters stated by TI for that component or service voids all express and any implied warranties for the associated TI component or service and is an unfair and deceptive business practice. TI is not responsible or liable for any such statements.

Buyer acknowledges and agrees that it is solely responsible for compliance with all legal, regulatory and safety-related requirements concerning its products, and any use of TI components in its applications, notwithstanding any applications-related information or support that may be provided by TI. Buyer represents and agrees that it has all the necessary expertise to create and implement safeguards which anticipate dangerous consequences of failures, monitor failures and their consequences, lessen the likelihood of failures that might cause harm and take appropriate remedial actions. Buyer will fully indemnify TI and its representatives against any damages arising out of the use of any TI components in safety-critical applications.

In some cases, TI components may be promoted specifically to facilitate safety-related applications. With such components, TI's goal is to help enable customers to design and create their own end-product solutions that meet applicable functional safety standards and requirements. Nonetheless, such components are subject to these terms.

No TI components are authorized for use in FDA Class III (or similar life-critical medical equipment) unless authorized officers of the parties have executed a special agreement specifically governing such use.

Only those TI components which TI has specifically designated as military grade or "enhanced plastic" are designed and intended for use in military/aerospace applications or environments. Buyer acknowledges and agrees that any military or aerospace use of TI components which have **not** been so designated is solely at the Buyer's risk, and that Buyer is solely responsible for compliance with all legal and regulatory requirements in connection with such use.

TI has specifically designated certain components as meeting ISO/TS16949 requirements, mainly for automotive use. In any case of use of non-designated products, TI will not be responsible for any failure to meet ISO/TS16949.

Products

Audio	www.ti.com/audio
Amplifiers	amplifier.ti.com
Data Converters	dataconverter.ti.com
DLP® Products	www.dlp.com
DSP	dsp.ti.com
Clocks and Timers	www.ti.com/clocks
Interface	interface.ti.com
Logic	logic.ti.com
Power Mgmt	power.ti.com
Microcontrollers	microcontroller.ti.com
RFID	www.ti-rfid.com
OMAP Applications Processors	www.ti.com/omap
Wireless Connectivity	www.ti.com/wirelessconnectivity

Applications

Automotive and Transportation	www.ti.com/automotive
Communications and Telecom	www.ti.com/communications
Computers and Peripherals	www.ti.com/computers
Consumer Electronics	www.ti.com/consumer-apps
Energy and Lighting	www.ti.com/energy
Industrial	www.ti.com/industrial
Medical	www.ti.com/medical
Security	www.ti.com/security
Space, Avionics and Defense	www.ti.com/space-avionics-defense
Video and Imaging	www.ti.com/video

TI E2E Community

e2e.ti.com