

Using the UCC28250EVM-564

User's Guide



Literature Number: SLUU441A
September 2010–Revised October 2011

Half-Bridge DC-to-DC Converter With Secondary-Side Control

1 Introduction

This EVM is to aid in evaluating UCC28250 PWM device with secondary-side control in DC-to-DC symmetrical half-bridge converter topology. The targeted application is telecom module design with nominal 48-V input. UCC28250 is a PWM controller that can be used for primary-side control or secondary-side control. In this EVM, UCC28250 is placed at the secondary side to make secondary-side control.

2 Description

The EVM is a 100-W symmetrical half-bridge DC-to-DC converter that converts 36 V to 75 V DC to a regulated output voltage 3.3 V and maximum 30-A load current.

2.1 Typical Applications

- Telecom Power Supplies with Secondary-Side Control
- Server Systems
- Datacom
- DSP's, ASIC's, and FPGA's

2.2 Features

- Start up from telecom input voltage 36 V to 75 V DC with initial assistance of external auxiliary supply on the secondary side.
- Regulated output voltage 3.3 V with maximum 30-A load current.
- Smooth and monotonic output voltage turn on with up to 90% pre-biased output voltage.
- Output voltage regulation from no load to full load, and from low line to high line.
- Secondary-side Enable ON/OFF function and manual switch.
- Secondary-side control.
- Voltage-mode control.
- Control-driven synchronous rectifier.
- Non-latching output over voltage protection.
- Hiccup over current protection.
- Telecom basic isolation from primary to secondary 1500 V.

CAUTION

Before doing any test with this EVM, please read this document especially [Section 3](#) through [Section 6](#). Without a thorough reading of this document, strange behavior of operation and possible damage may be resulted in the test.

3 Electrical Performance Specifications

Table 1. UCC28250EVM-564 Electrical Performance Specifications

PARAMETER	TEST CONDITIONS	MIN	TYP	MAX	UNITS
Input Characteristics					
Voltage range		36	48	75	V
Maximum input current	$V_{IN} = 36\text{ V}$ and $I_{OUT} = 30\text{ A}$			3.5	A
No load input current	$V_{IN} = 75\text{ V}$			90	mA
Output Characteristics					
Output voltage, V_{OUT}	Output current = 0 A	3.25	3.3	3.35	V
Output load current, I_{OUT}				30	A
Output voltage regulation	Line regulation: input voltage = 36 V to 75 V			0.15%	
	Load regulation: output current = 0 A to 23 A			0.15%	
Output voltage ripple	At $I_{OUT} = 30\text{ A}$			50	mVpp
Output over current		35			A
Systems Characteristics					
Switching frequency			200		kHz
Operation frequency			400		
Peak efficiency			91%		
Full load efficiency			90%		
Operating temperature	Min 200 LFM force air flow		45		°C

4 Schematic

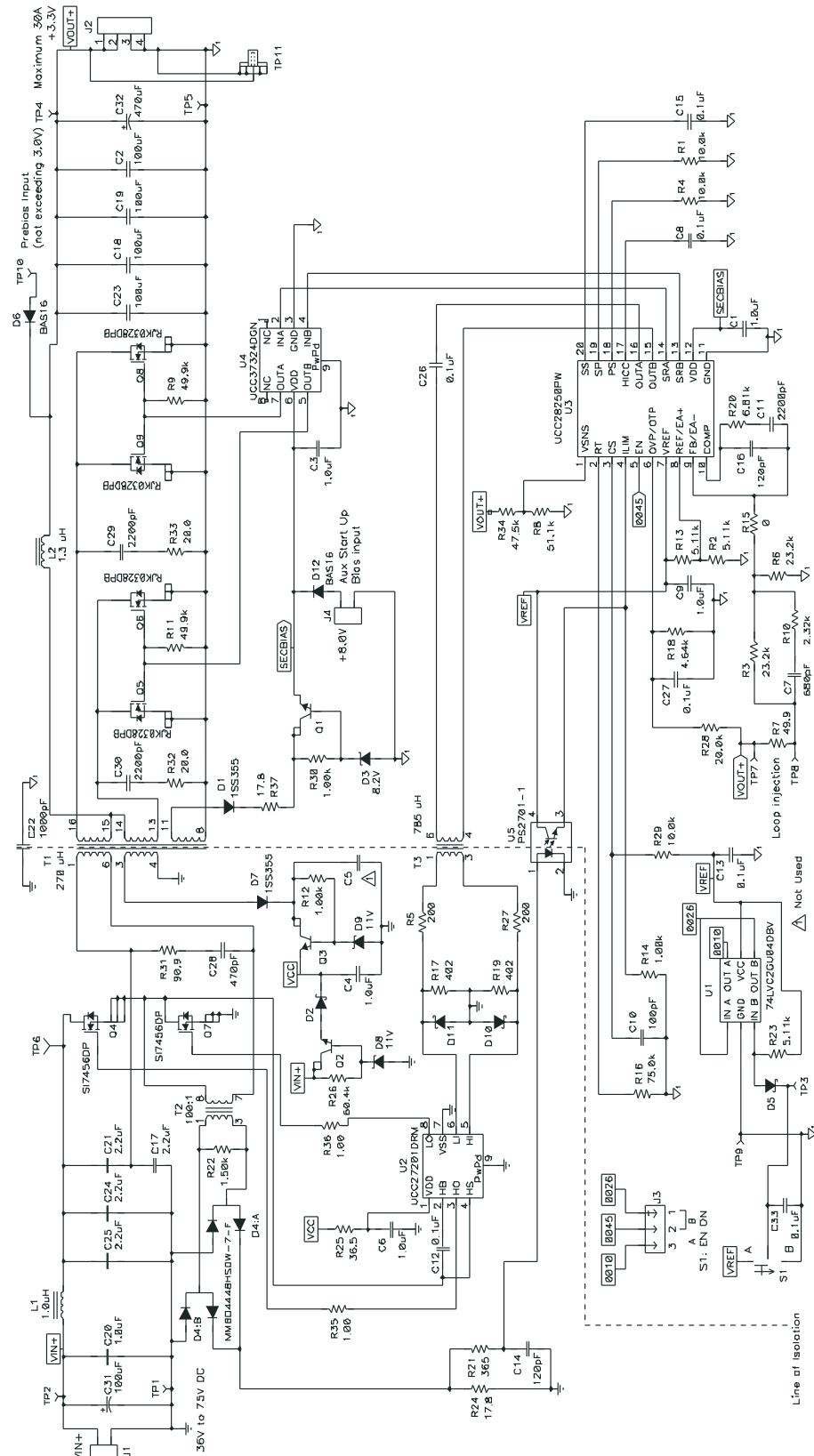

Figure 1. UCC28250EVM-564 Schematic

5 Test Setup

5.1 Test Equipment

Voltage source for main power: HP 6015A DC power supply

Voltage source for secondary initial bias: 8.0-V/0.1-A DC voltage source compatible

Multimeters: Fluke 45 dual display multimeter

Output load: HP 6060A DC electronic load

Oscilloscope: Tektronix TDS 460 A 400 MHz

Fan: 200 LFM minimum compatible

Recommended wire gauge: AWG #18 for input voltage connection. AWG #16 for output load connection.

5.2 Recommended Test Setup

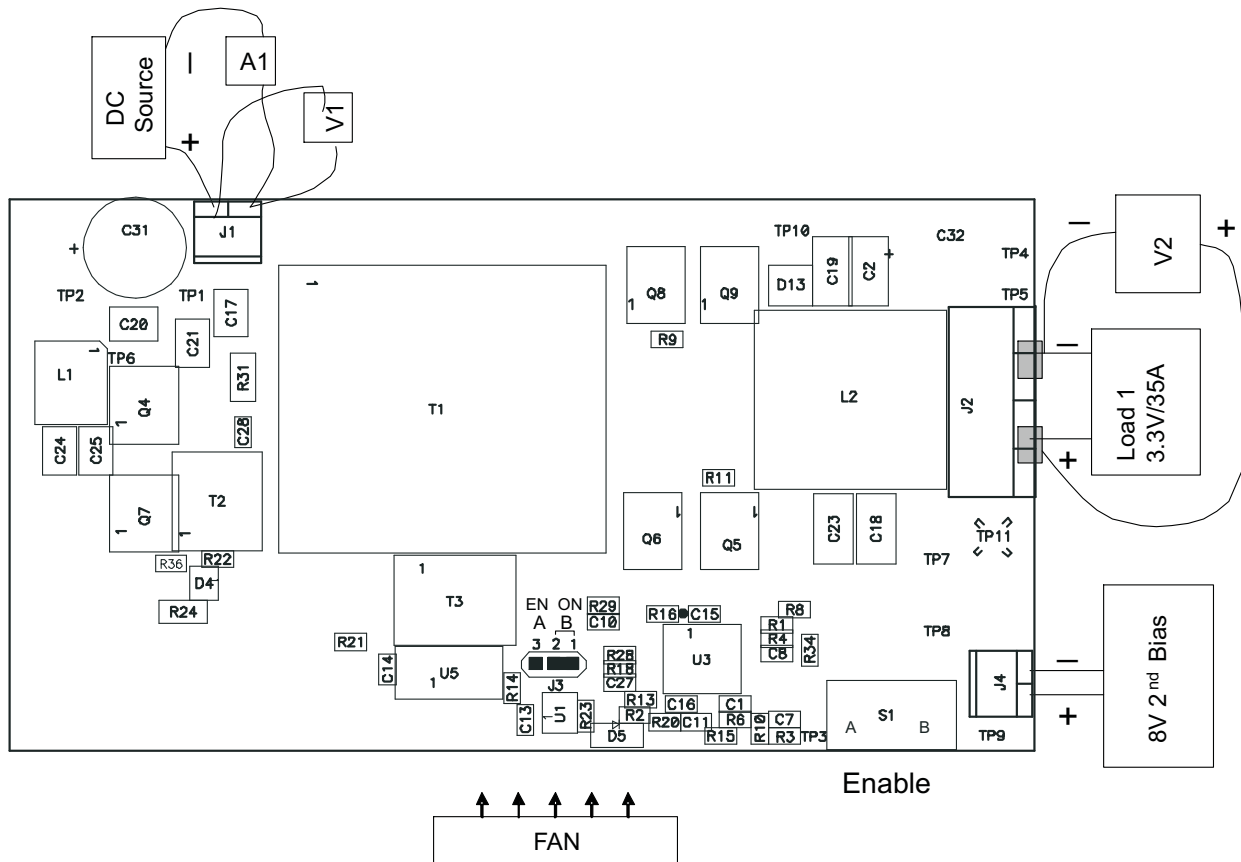

Figure 2. Recommended Test Set Up

5.3 List of Test Points

Table 2. Test Points Function

TEST POINTS	NAME	DESCRIPTION
TP1	PGND	Input voltage negative test point, for efficiency test
TP2	Vin	Input voltage positive test point, for efficiency test
TP3	En_ON	Board Enable On, default low logic, jumper placed on the right
TP4	VOUT+	Output voltage positive test point for efficiency
TP5	VOUT-	Output voltage negative test point for efficiency
TP6	VLine	Primary side positive input after input filter
TP7	Loop+	Feedback loop injection
TP8	Loop-	Feedback loop injection
TP9	GND	Primary side signal ground
TP10	Prebias+	Prebias output positive input
TP11	Vo_Ripple	Output voltage ripple test
J1	INPUT	Input voltage terminals
J2	OUTPUT	Output voltage terminals
J3	En_Logic	Set up enable high or low, default low, jumper cross pin 2 to 1
J4	2nd Bias	Secondary side initial bias, 8.0V

6 Test Procedure

Set up the EVM based on [Figure 2](#).

CAUTION

High voltage and high temperature present when the EVM is in operation!

6.1 Line/Load Regulation and Efficiency Measurement Procedure

1. Verify and confirm J3 jumper is placed across pin 2 to 1.
2. Verify switch S1 is on position A.
3. Connect the ammeter A1 (0 A to 10 A range) between DC source and J1 as shown in [Figure 2](#).
4. Prior to connecting the DC source, it is advisable to limit the source current to 4 A maximum. Make sure the DC source is initially set to 0 V and connected to J1 and A1 as shown in [Figure 2](#).
5. Connect voltmeter, V1 across the DC source as shown in [Figure 2](#).
6. Connect Load1 to J2 as shown in [Figure 2](#). Set Load1 to constant current mode to sink 0 A_{DC} before the input voltage on J1 is applied.
7. Connect voltmeter, V2 to J2 as shown in [Figure 2](#).
8. Connect 8.0 V 2nd Bias to J4. Turn its voltage into 8.0 V.
9. Turn on fan making sure to blow air directly on the EVM.
10. Increase the DC source voltage from 0 V to 36.0 V_{DC}.
11. Snap switch S1 to position B.
12. Remove 8.0 V 2nd Bias.
13. Measure V_{OUT} (V2), I_{OUT}, V_{IN} (V1) and I_{in} (A1).
14. Vary LOAD1 from 0 A to a higher value, up to 30 A_{DC}.
15. Repeat step 10.
16. Increase input voltage to a different value, up to 75 V, and repeat step 10 and 11.

6.2 Equipment Shutdown

1. Decrease Load1 to 0 A.
2. Snap switch S1 to position A.
3. Decrease V_{IN} from 75.0 V_{DC} to 0 V.
4. Shut down V_{IN} and Fan.
5. Shut down the load.

6.3 Notes for Operating this EVM

1. This EVM relies on external auxiliary power supply (8.0 V/0.1 A) to start up. After start up, the board can operate normally without the external auxiliary supply. If the auxiliary supply is removed, the board cannot start up without adding the auxiliary supply back after Enable Off.
2. This EVM does not have line under voltage ON/OFF feature. Please follow 6.1 and 6.2 to turn on and off the board. Strange behavior including damage may be observed if do not follow [Section 6.1](#) and [Section 6.2](#).
3. In evaluating protection features (OVP and OCP, etc.), the external auxiliary power supply should remain connected and setup at 8.0 V which is required to resume the EVM operation after a fault is cleared or in order to operate in hiccup mode in that regarding.

7 Performance Data and Typical Characteristic Curves

Figure 3 through Figure 11 present typical performance curves for UCC28250EVM-564.

7.1 Efficiency

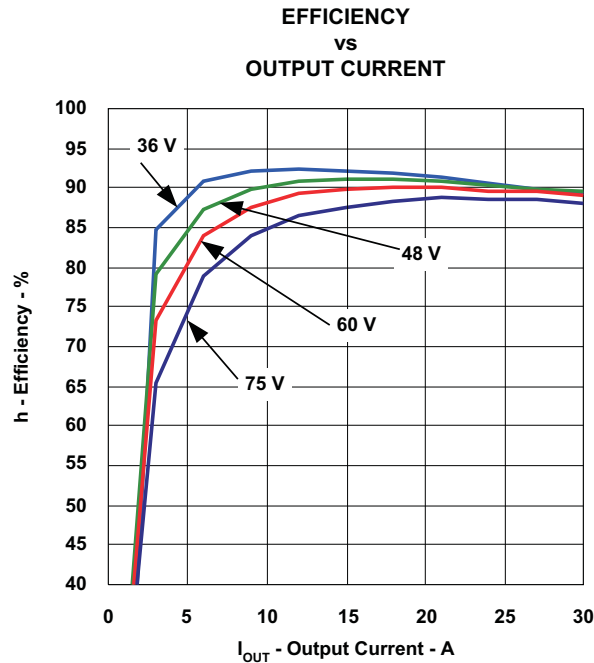

Figure 3. Efficiency

7.2 Load Regulation

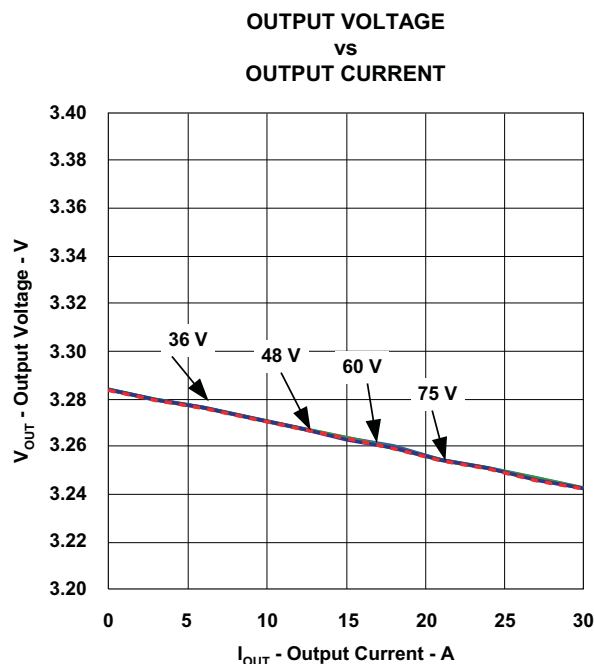

Figure 4. Load Regulation

7.3 Bode Plot

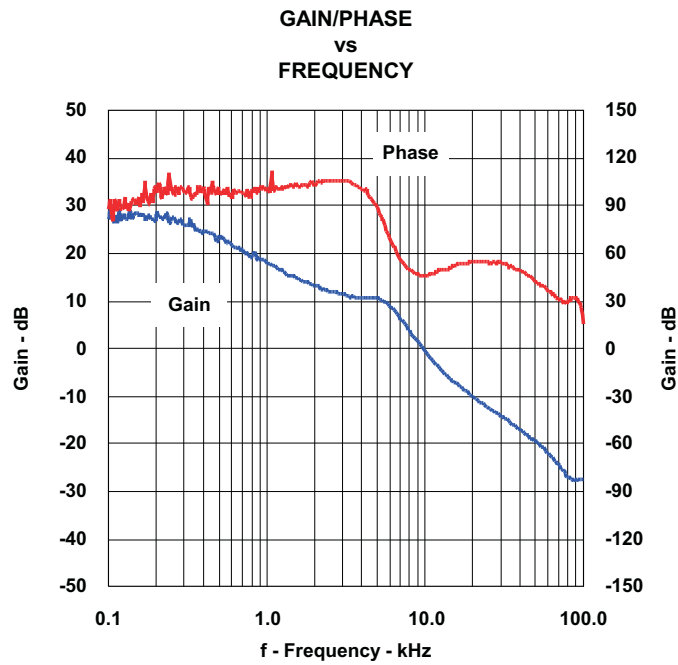

Figure 5. Loop Response Gain and Phase

7.4 Turn-On Waveform

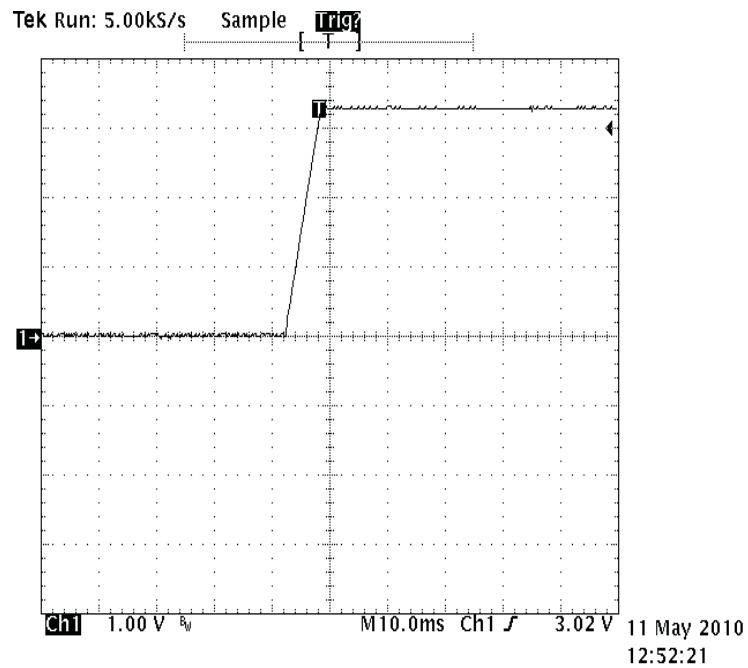

Figure 6. Enable Turn-On Waveform

7.5 Turn-On Waveform with Pre-biased Output Voltage

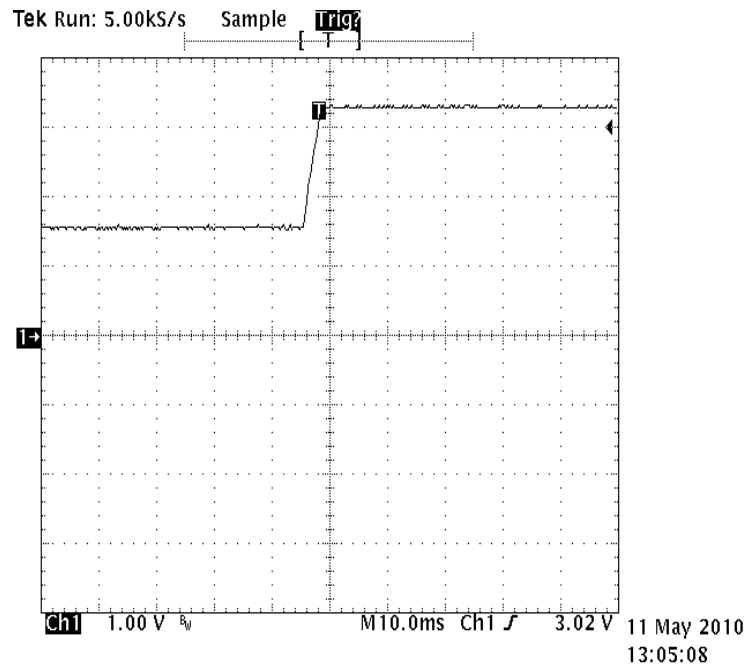

Figure 7. Enable Turn-On Waveform

7.6 Turn-On Waveform with Pre-biased Output Voltage

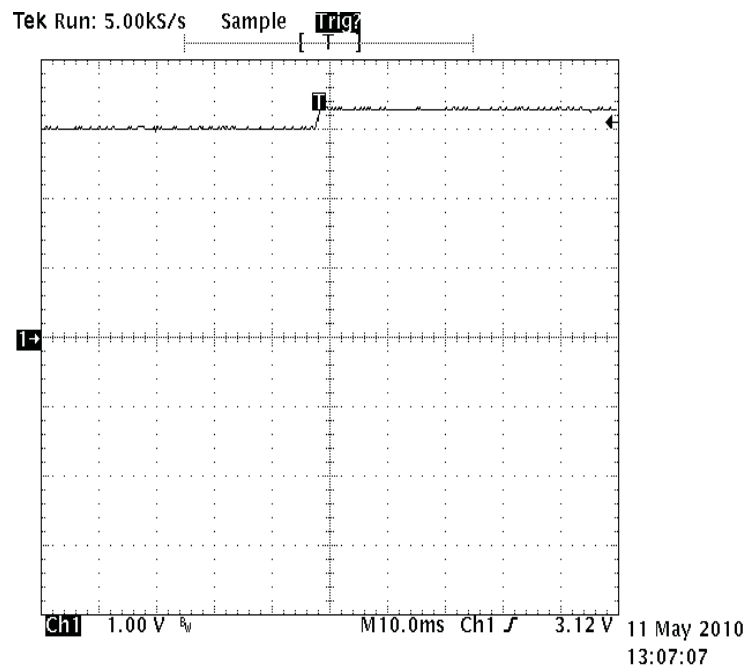

Figure 8. Enable Turn-On Waveform

7.7 Turn-On Waveform with Pre-biased Output Voltage

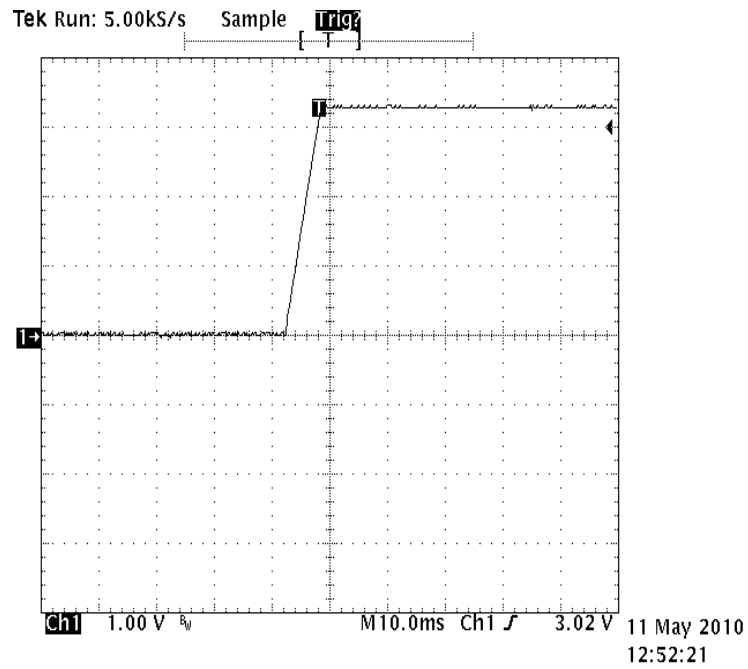

Figure 9. Enable Turn-On Waveform

7.8 Turn-Off Waveform

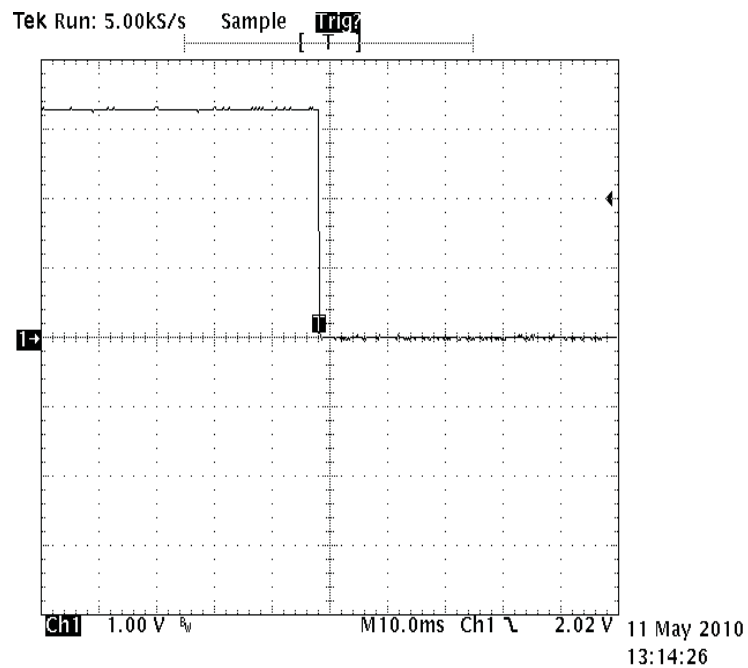

Figure 10. Enable Turn-Off Waveform

7.9 Output Ripple

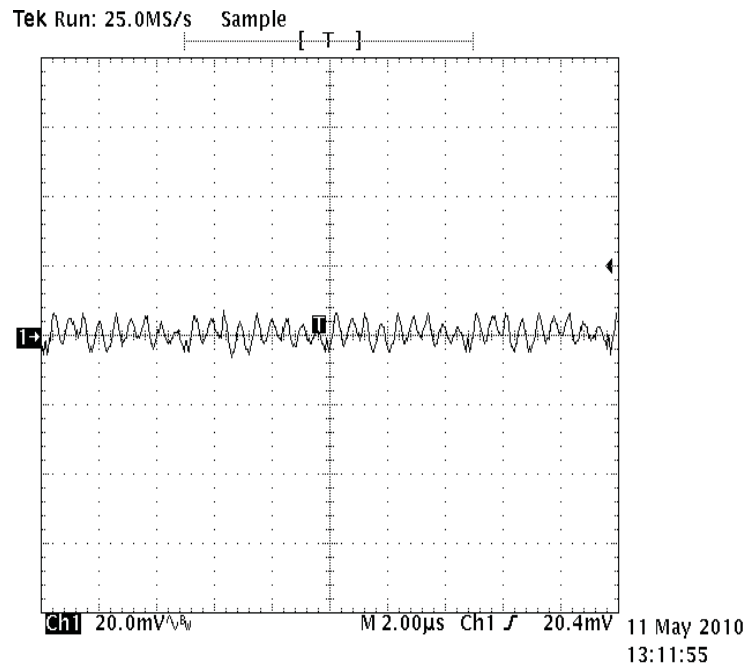

Figure 11. Output Ripple

8 EVM Assembly Drawing and PCB Layout

The following figures (Figure 12 through Figure 17) show the design of the UCC28250EVM-564 printed circuit board. PCB dimensions: L x W = 4.0 in x 2.3 in, PCB material: FR406 or compatible, four layers and 2-oz copper on each layer.

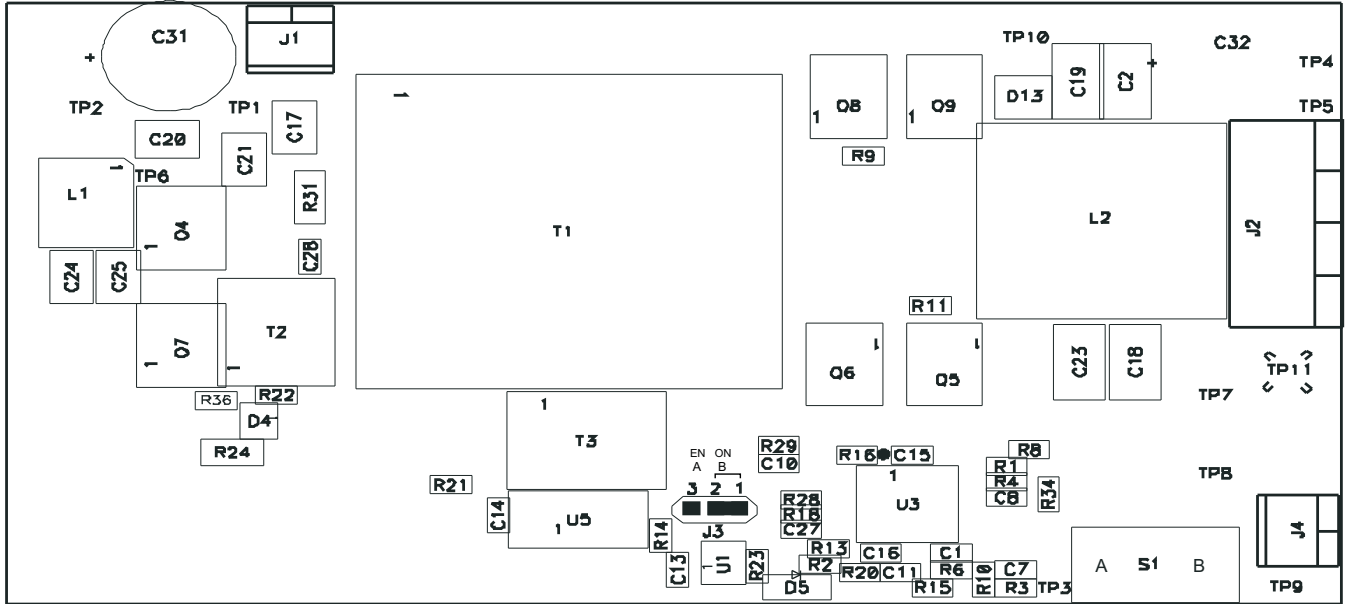

Figure 12. Top Layer Assembly Drawing (top view)

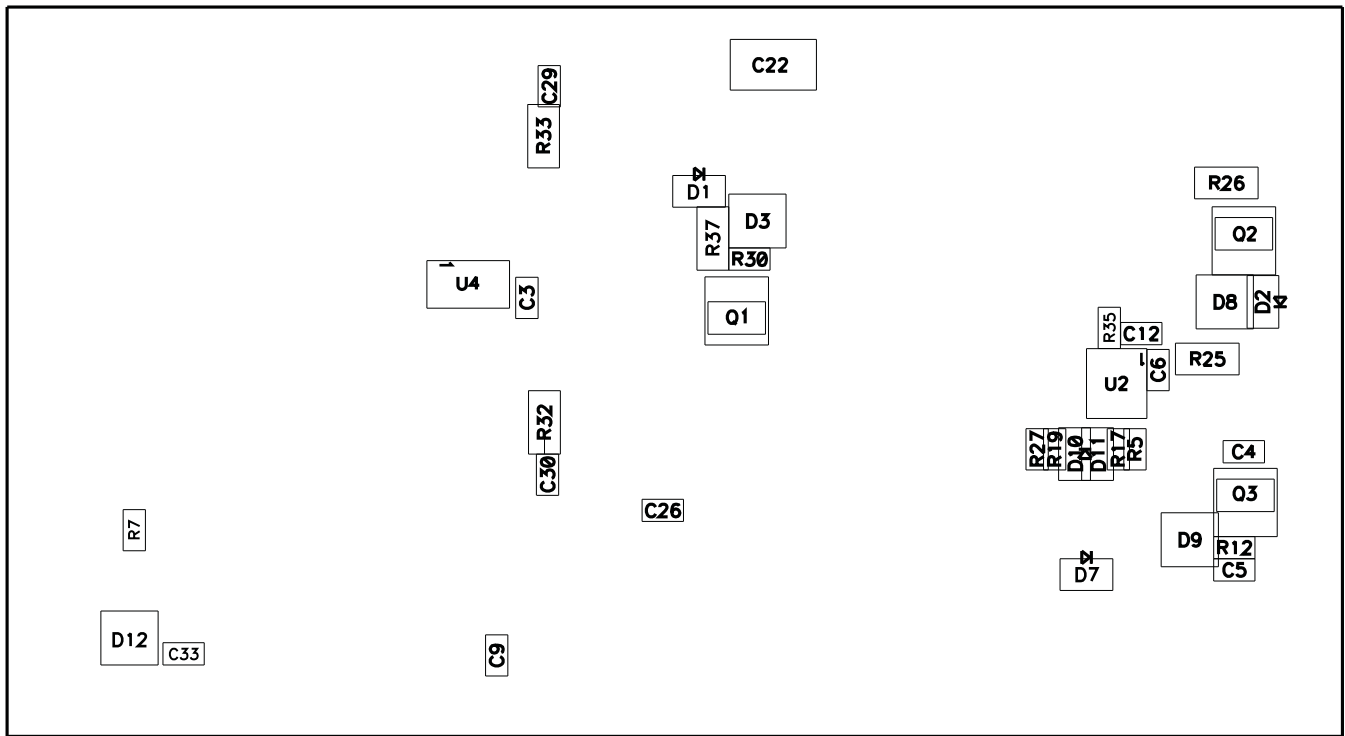

Figure 13. Bottom Assembly Drawing (bottom view)

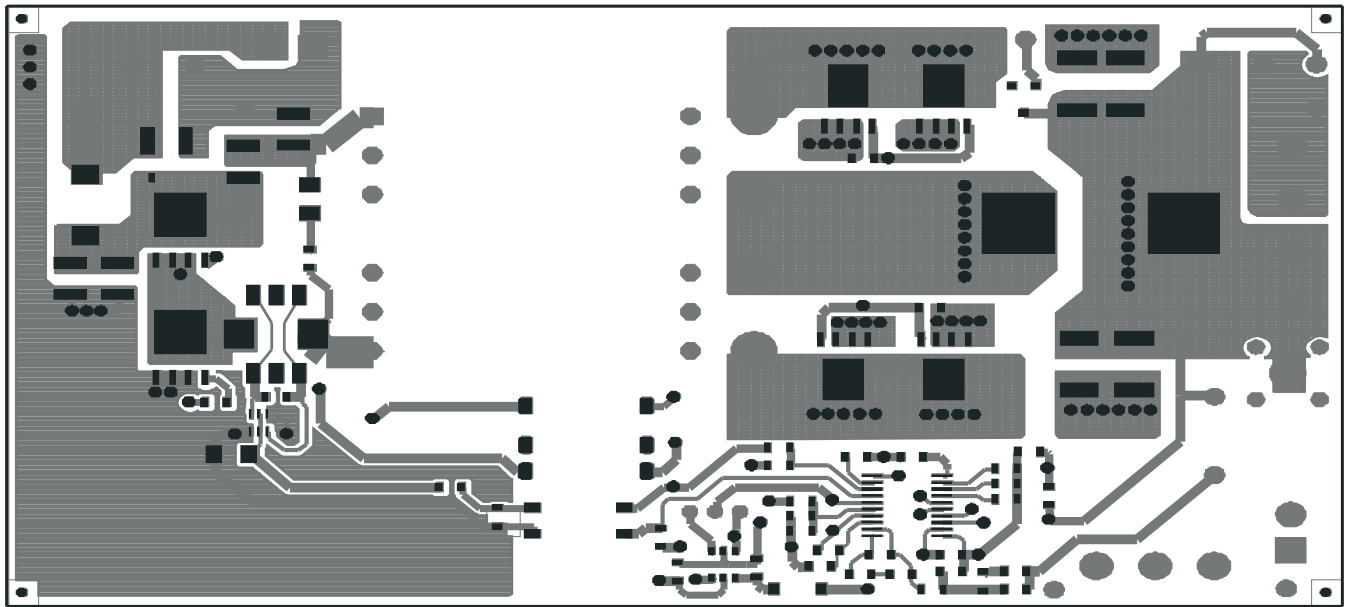

Figure 14. Top Copper (top view)

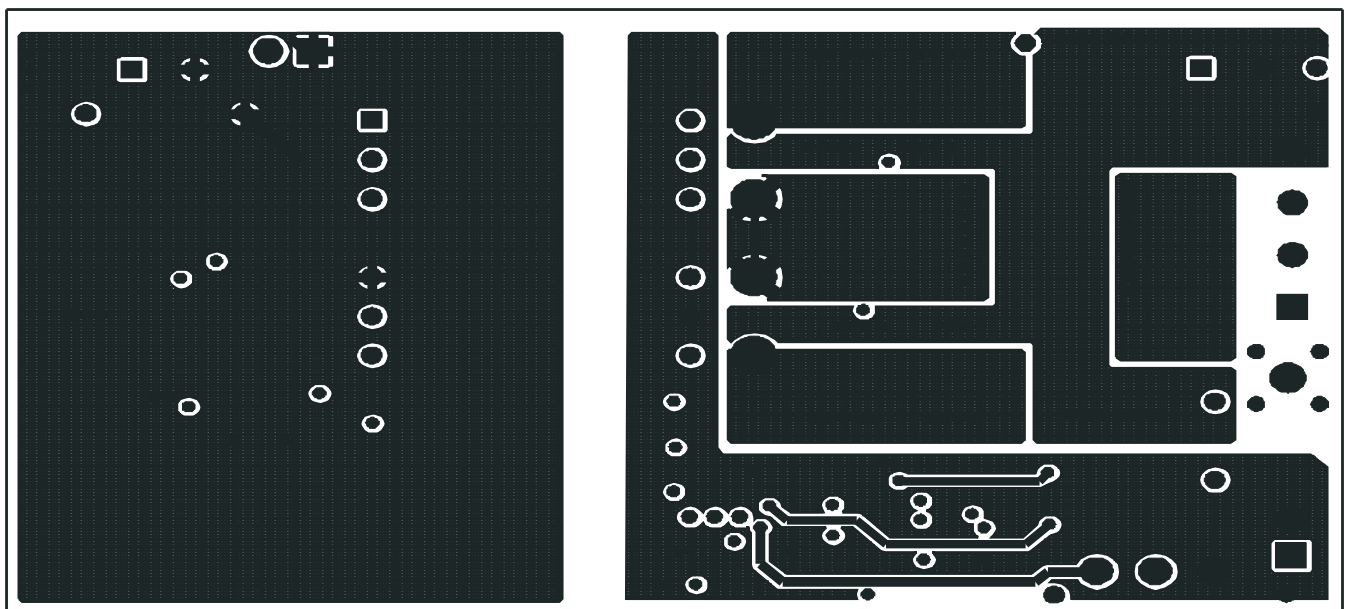

Figure 15. Internal Layer 1 (top view)

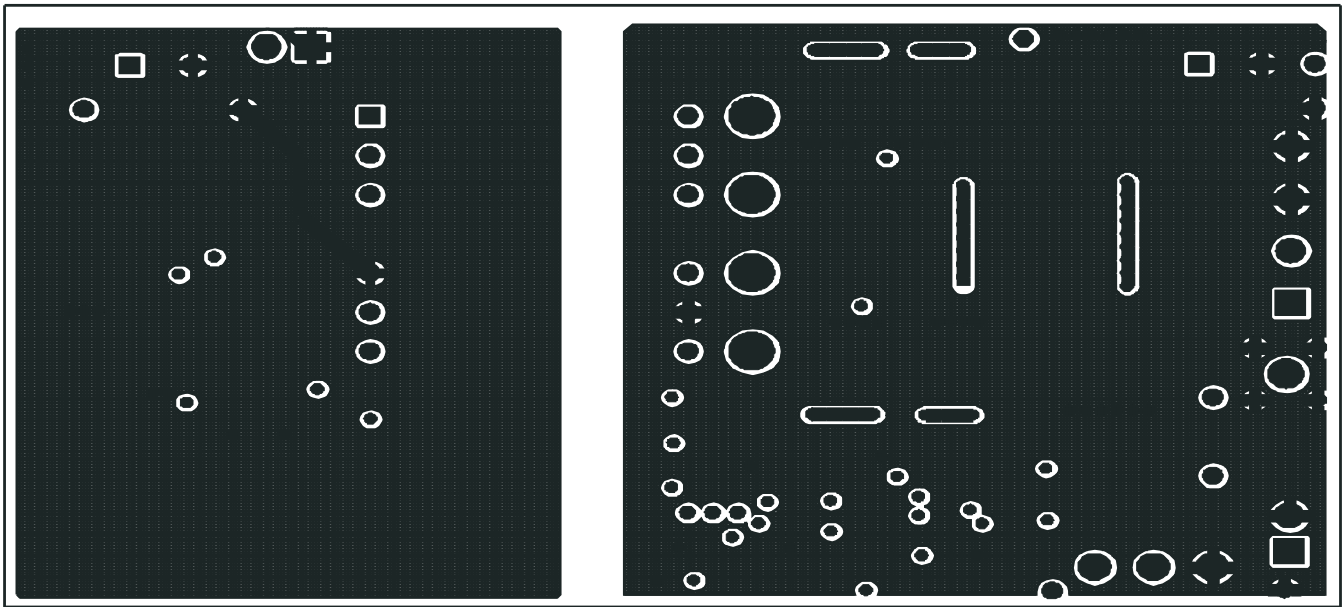

Figure 16. Internal Layer 2 (top view)

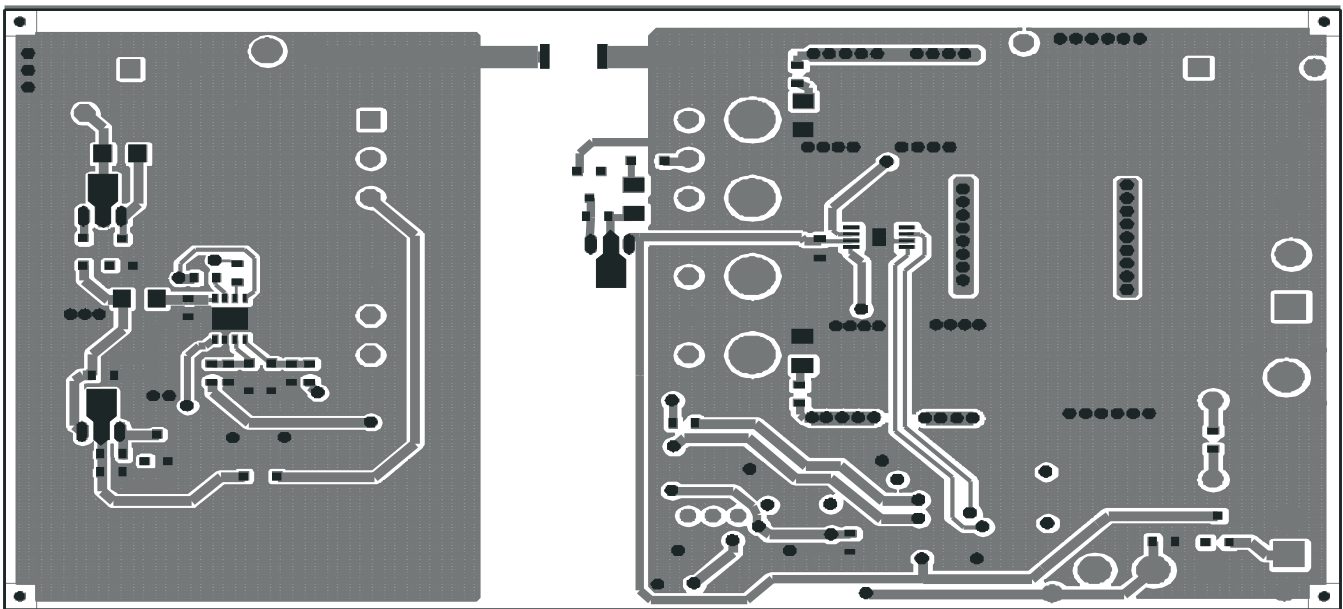

Figure 17. Bottom Copper (top view)

9 List of Materials

The EVM components list according to the schematic shown in [Figure 1](#).

Table 3. UCC28250EVM-564 List of Materials

QTY	REF DES	DESCRIPTION	PART NUMBER	MFR
5	C1, C3, C4, C6, C9	Capacitor, ceramic, 50 V, X5R, ±10%, 1.0 µF, 603	Std	Std
1	C10	Capacitor, ceramic, 50 V, NP0, ±10%, 100 pF, 603	Std	Std
3	C11, C29, C30	Capacitor, ceramic, 50 V, X7R, ±10%, 2200 pF, 603	Std	Std
2	C14, C28	Capacitor, ceramic, 50 V, X7R, ±10%, 470 pF, 603	Std	Std
1	C16	Capacitor, ceramic, 50 V, NP0, ±5%, 120 pF, 603	Std	Std
4	C17, C21, C24, C25	Capacitor, ceramic, 100 V, X7R, ±10%, 2.2 µF, 1210	Std	Std
4	C2, C18, C19, C23	Capacitor, ceramic, 6.3 V, X5R, ±10%, 100 µF, 1812	Std	Std
1	C20	Capacitor, ceramic, 100 V, X7R, ±10%, 1.0 µF, 1210	Std	Std
1	C22	Capacitor, ceramic, 2 kV, X7R, ±10%, 1000 pF, 1808	Std	Std
1	C31	Capacitor, aluminum, 100 V, 105°C, ±20%, 100 µF, 0.315 inch	EEU-PC2A101	Panasonic
1	C32	Capacitor, aluminum, 25 V, 105°C, ±20%, 470 µF, 0.315 inch	UVZ1E471MPD	Nichicon
0	C5	Capacitor, ceramic, 50 V, X7R, ±10%, Not used, 603	Std	Std
1	C7	Capacitor, ceramic, 50 V, X7R, ±10%, 680 pF, 603	Std	Std
7	C8, C12, C13, C15, C26, C27, C33	Capacitor, ceramic, 50 V, X7R, ±10%, 0.1 µF, 603	Std	Std
2	D1, D7	Diode, switching, 90 V, 100 mA IFM, high speed, SOD-323	1SS355TE-17	Rohm
2	D12, D13	Diode, switching, 150 mA, 75 V, 350 mW, SOT23	BAS16	Vishay-Liteon
3	D2, D10, D11	Diode, Schottky, 350 mA, 40 V, SOD323	SD103AWS-7-F	Diodes Inc
1	D3	Diode, Zener, 8.2 V, 20 mA, 350 mW, 8.2V, SOT23	MMBZ5237B-7-F	Diodes Inc
1	D4	Diode, fast switching, 80 V, 500 mA, SOT-363	MMBD44448HSDW-7-F	Diodes
1	D5	Diode, Schottky, 0.5 A, 20 V, SOD-123	MBR0520L	Fairchild
2	D8, D9	Diode, Zener, 11 V, 20 mA, 350 mW, 11V, SOT23	MMBZ5241B-7-F	Diodes Inc
2	J1, J4	Terminal block, 2 pin, 6 A, 3.5 mm, 0.27 inch x 0.25 inch	OSTTE020161	OST
1	J2	Terminal block, 4 -pin, 15 A, 5.1 mm, 0.80 inch x 0.35 inch	ED120/4DS	OST
1	J3	Header, 3 pin, 2 mm spacing, 0.079 inch x 3 inch	TMM-103-01-T-S	Samtec Inc
1	L1	Inductor, SMT, 6 A, 8.8 mΩ, 1.0 µH, 0.287 inch x 0.268 inch	RLF7030T-1R0N6R4	TDK
1	L2	Inductor, power choke, ±20%, 1.3 µH, 18.2 mm x 18.3 mm	7443556130	Würth Elektronik
3	Q1, Q2, Q3	Transistor, NPN high voltage, VCE 100 V, IC1A, SOT89	FCX493TA	Zetex
2	Q4, Q7	MOSFET, N-channel, 100 V, 5.7 A, 25 mΩ, PWRPAK S0-8	SI7456DP	Vishay
4	Q5, Q6, Q8, Q9	MOSFET, N-channel, 30 V, 50 A, 2.6 mΩ, LPAK	RJK0328DPB	Renesas
3	R1, R4, R29	Resistor, chip, 1/16 W, ± 1%, 10.0 kΩ, 603	Std	Std
1	R10	Resistor, chip, 1/16 W, ± 1%, 2.32 kΩ, 603	Std	Std
3	R12, R14, R30	Resistor, chip, 1/16 W, ± 1%, 1.00 kΩ, 603	Std	Std

Table 3. UCC28250EVM-564 List of Materials (continued)

QTY	REF DES	DESCRIPTION	PART NUMBER	MFR
1	R15	Resistor, chip, 1/16 W, $\pm 5\%$, 0 Ω , 603	Std	Std
1	R16	Resistor, chip, 1/16 W, $\pm 1\%$, 75.0 k Ω , 603	Std	Std
2	R17, R19	Resistor, chip, 1/16 W, $\pm 1\%$, 402 Ω , 603	Std	Std
1	R18	Resistor, chip, 1/16 W, $\pm 1\%$, 4.64 k Ω , 603	Std	Std
3	R2, R13, R23	Resistor, chip, 1/16 W, $\pm 1\%$, 5.11 k Ω , 603	Std	Std
1	R20	Resistor, chip, 1/16 W, $\pm 1\%$, 6.81 k Ω , 603	Std	Std
1	R21	Resistor, chip, 1/16 W, $\pm 1\%$, 681 Ω , 603	Std	Std
1	R22	Resistor, chip, 1/16 W, $\pm 1\%$, 1.50 k Ω , 603	Std	Std
2	R24, R37	Resistor, metal film, 1/4 W, $\pm 1\%$, 17.8 Ω , 1206	Std	Std
1	R25	Resistor, metal film, 1/4 W, $\pm 1\%$, 36.5 Ω , 1206	Std	Std
1	R26	Resistor, metal film, 1/4 W, $\pm 1\%$, 60.4 k Ω , 1206	Std	Std
1	R28	Resistor, chip, 1/16 W, $\pm 1\%$, 20.0 k Ω , 603	Std	Std
2	R3, R6	Resistor, chip, 1/16 W, $\pm 1\%$, 23.2 k Ω , 603	Std	Std
1	R31	Resistor, metal film, 1/4 W, $\pm 1\%$, 90.9 Ω , 1206	Std	Std
2	R32, R33	Resistor, metal film, 1/4 W, $\pm 1\%$, 20 Ω , 1206	Std	Std
1	R34	Resistor, chip, 1/16 W, $\pm 1\%$, 47.5 k Ω , 603	Std	Std
2	R35, R36	Resistor, chip, 1/16 W, $\pm 1\%$, 1 Ω , 603	Std	Std
2	R5, R27	Resistor, chip, 1/16 W, $\pm 1\%$, 200 Ω , 603	Std	Std
1	R7	Resistor, chip, 1/16 W, $\pm 1\%$, 49.9 Ω , 603	Std	Std
1	R8	Resistor, chip, 1/16 W, $\pm 1\%$, 51.1 k Ω , 603	Std	Std
2	R9, R11	Resistor, chip, 1/16 W, $\pm 1\%$, 49.9 k Ω , 603	Std	Std
1	S1	Switch, Actuator SPDT, 0.500 inch x 0.260 inch	1101M2S3CQE2	C & K
1	T1	Transformer, Half-Bridge $\pm 30\%$, 270 μH , 1.120 inch x 1.273 inch	AF5096	Vitec Electronics
1	T2	Xfmr, Current Sense, 100:01:00, 0.315 inch x 0.320 inch	CST2-100L	Coilcraft
1	T3	Transformer, 1 primary, 1 secondary, 785 μH , 0.460 x 0.340 inch	PA0185	Pulse
9	TP1, TP2, TP3, TP4, TP5, TP7, TP8, TP9, TP10	Pin, Thru Hole, Tin Plate, for 0.062 PCB's, 0.039 inch	3103-1-00-15-00-00-08-0	Mill-Max
1	TP11	Adaptor, 3.5-mm probe clip (or 131-5031-00), 0.200 inch	131-4244-00	Tektronix
1	U1	DUAL INVERTER GATE, 32mA, 3.3V, SOT23-6	SN74LVC2GU04DBVR	TI
1	U2	120 V Boot, 2.5A Peak, High-Freq. High-Side Low-Side Driver, QFN-8	UCC27201DRM	TI
1	U3	Advanced PWM Controller with Pre-Bias Operation, TSSOP-20	UCC28250PW	TI
1	U4	Dual 4-A High Speed Low-Side Power MOSFET Drivers , MSOP-8	UCC37324DGN	TI
1	U5	Photocoupler, SOP-4	PS2701-1	NEC

Evaluation Board/Kit Important Notice

Texas Instruments (TI) provides the enclosed product(s) under the following conditions:

This evaluation board/kit is intended for use for **ENGINEERING DEVELOPMENT, DEMONSTRATION, OR EVALUATION PURPOSES ONLY** and is not considered by TI to be a finished end-product fit for general consumer use. Persons handling the product(s) must have electronics training and observe good engineering practice standards. As such, the goods being provided are not intended to be complete in terms of required design-, marketing-, and/or manufacturing-related protective considerations, including product safety and environmental measures typically found in end products that incorporate such semiconductor components or circuit boards. This evaluation board/kit does not fall within the scope of the European Union directives regarding electromagnetic compatibility, restricted substances (RoHS), recycling (WEEE), FCC, CE or UL, and therefore may not meet the technical requirements of these directives or other related directives.

Should this evaluation board/kit not meet the specifications indicated in the User's Guide, the board/kit may be returned within 30 days from the date of delivery for a full refund. **THE FOREGOING WARRANTY IS THE EXCLUSIVE WARRANTY MADE BY SELLER TO BUYER AND IS IN LIEU OF ALL OTHER WARRANTIES, EXPRESSED, IMPLIED, OR STATUTORY, INCLUDING ANY WARRANTY OF MERCHANTABILITY OR FITNESS FOR ANY PARTICULAR PURPOSE.**

The user assumes all responsibility and liability for proper and safe handling of the goods. Further, the user indemnifies TI from all claims arising from the handling or use of the goods. Due to the open construction of the product, it is the user's responsibility to take any and all appropriate precautions with regard to electrostatic discharge.

EXCEPT TO THE EXTENT OF THE INDEMNITY SET FORTH ABOVE, NEITHER PARTY SHALL BE LIABLE TO THE OTHER FOR ANY INDIRECT, SPECIAL, INCIDENTAL, OR CONSEQUENTIAL DAMAGES.

TI currently deals with a variety of customers for products, and therefore our arrangement with the user **is not exclusive.**

TI assumes **no liability for applications assistance, customer product design, software performance, or infringement of patents or services described herein.**

Please read the User's Guide and, specifically, the Warnings and Restrictions notice in the User's Guide prior to handling the product. This notice contains important safety information about temperatures and voltages. For additional information on TI's environmental and/or safety programs, please contact the TI application engineer or visit www.ti.com/esh.

No license is granted under any patent right or other intellectual property right of TI covering or relating to any machine, process, or combination in which such TI products or services might be or are used.

FCC Warning

This evaluation board/kit is intended for use for **ENGINEERING DEVELOPMENT, DEMONSTRATION, OR EVALUATION PURPOSES ONLY** and is not considered by TI to be a finished end-product fit for general consumer use. It generates, uses, and can radiate radio frequency energy and has not been tested for compliance with the limits of computing devices pursuant to part 15 of FCC rules, which are designed to provide reasonable protection against radio frequency interference. Operation of this equipment in other environments may cause interference with radio communications, in which case the user at his own expense will be required to take whatever measures may be required to correct this interference.

EVM Warnings and Restrictions

It is important to operate this EVM within the input voltage range of 36 V to 75 V and the output voltage range of 3.3 V .

Exceeding the specified input range may cause unexpected operation and/or irreversible damage to the EVM. If there are questions concerning the input range, please contact a TI field representative prior to connecting the input power.

Applying loads outside of the specified output range may result in unintended operation and/or possible permanent damage to the EVM. Please consult the EVM User's Guide prior to connecting any load to the EVM output. If there is uncertainty as to the load specification, please contact a TI field representative.

During normal operation, some circuit components may have case temperatures greater than 60° C. The EVM is designed to operate properly with certain components above 60° C as long as the input and output ranges are maintained. These components include but are not limited to linear regulators, switching transistors, pass transistors, and current sense resistors. These types of devices can be identified using the EVM schematic located in the EVM User's Guide. When placing measurement probes near these devices during operation, please be aware that these devices may be very warm to the touch.

Mailing Address: Texas Instruments, Post Office Box 655303, Dallas, Texas 75265
Copyright © 2011, Texas Instruments Incorporated

IMPORTANT NOTICE

Texas Instruments Incorporated and its subsidiaries (TI) reserve the right to make corrections, modifications, enhancements, improvements, and other changes to its products and services at any time and to discontinue any product or service without notice. Customers should obtain the latest relevant information before placing orders and should verify that such information is current and complete. All products are sold subject to TI's terms and conditions of sale supplied at the time of order acknowledgment.

TI warrants performance of its hardware products to the specifications applicable at the time of sale in accordance with TI's standard warranty. Testing and other quality control techniques are used to the extent TI deems necessary to support this warranty. Except where mandated by government requirements, testing of all parameters of each product is not necessarily performed.

TI assumes no liability for applications assistance or customer product design. Customers are responsible for their products and applications using TI components. To minimize the risks associated with customer products and applications, customers should provide adequate design and operating safeguards.

TI does not warrant or represent that any license, either express or implied, is granted under any TI patent right, copyright, mask work right, or other TI intellectual property right relating to any combination, machine, or process in which TI products or services are used. Information published by TI regarding third-party products or services does not constitute a license from TI to use such products or services or a warranty or endorsement thereof. Use of such information may require a license from a third party under the patents or other intellectual property of the third party, or a license from TI under the patents or other intellectual property of TI.

Reproduction of TI information in TI data books or data sheets is permissible only if reproduction is without alteration and is accompanied by all associated warranties, conditions, limitations, and notices. Reproduction of this information with alteration is an unfair and deceptive business practice. TI is not responsible or liable for such altered documentation. Information of third parties may be subject to additional restrictions.

Resale of TI products or services with statements different from or beyond the parameters stated by TI for that product or service voids all express and any implied warranties for the associated TI product or service and is an unfair and deceptive business practice. TI is not responsible or liable for any such statements.

TI products are not authorized for use in safety-critical applications (such as life support) where a failure of the TI product would reasonably be expected to cause severe personal injury or death, unless officers of the parties have executed an agreement specifically governing such use. Buyers represent that they have all necessary expertise in the safety and regulatory ramifications of their applications, and acknowledge and agree that they are solely responsible for all legal, regulatory and safety-related requirements concerning their products and any use of TI products in such safety-critical applications, notwithstanding any applications-related information or support that may be provided by TI. Further, Buyers must fully indemnify TI and its representatives against any damages arising out of the use of TI products in such safety-critical applications.

TI products are neither designed nor intended for use in military/aerospace applications or environments unless the TI products are specifically designated by TI as military-grade or "enhanced plastic." Only products designated by TI as military-grade meet military specifications. Buyers acknowledge and agree that any such use of TI products which TI has not designated as military-grade is solely at the Buyer's risk, and that they are solely responsible for compliance with all legal and regulatory requirements in connection with such use.

TI products are neither designed nor intended for use in automotive applications or environments unless the specific TI products are designated by TI as compliant with ISO/TS 16949 requirements. Buyers acknowledge and agree that, if they use any non-designated products in automotive applications, TI will not be responsible for any failure to meet such requirements.

Following are URLs where you can obtain information on other Texas Instruments products and application solutions:

Products

Audio	www.ti.com/audio
Amplifiers	amplifier.ti.com
Data Converters	dataconverter.ti.com
DLP® Products	www.dlp.com
DSP	dsp.ti.com
Clocks and Timers	www.ti.com/clocks
Interface	interface.ti.com
Logic	logic.ti.com
Power Mgmt	power.ti.com
Microcontrollers	microcontroller.ti.com
RFID	www.ti-rfid.com
OMAP Mobile Processors	www.ti.com/omap
Wireless Connectivity	www.ti.com/wirelessconnectivity

Applications

Communications and Telecom	www.ti.com/communications
Computers and Peripherals	www.ti.com/computers
Consumer Electronics	www.ti.com/consumer-apps
Energy and Lighting	www.ti.com/energy
Industrial	www.ti.com/industrial
Medical	www.ti.com/medical
Security	www.ti.com/security
Space, Avionics and Defense	www.ti.com/space-avionics-defense
Transportation and Automotive	www.ti.com/automotive
Video and Imaging	www.ti.com/video

TI E2E Community Home Page

e2e.ti.com

Mailing Address: Texas Instruments, Post Office Box 655303, Dallas, Texas 75265
Copyright © 2011, Texas Instruments Incorporated