

Using the CSD86330EVM-717

User's Guide



Literature Number: SLUU480
February 2011

Synchronous Buck NexFET Power Block

1 Introduction

The CSD86330EVM-717 evaluation module (EVM) uses the CSD86330. The CSD86330 power block is an optimized design for synchronous buck applications offering high-current, high-efficiency, and high-frequency capability in a small 3.3-mm x 3.3-mm outline. CSD86330EVM-717 also uses TPS53219 as a small size single-buck controller with adaptive on-time D-CAP™ mode control. The EVM provides a fixed 1.2-V output at up to 10 A from a 12-V input bus.

2 Description

The CSD86330EVM-717 is designed to use a regulated 12-V bus to produce a regulated 1.2-V output at up to 10 A of load current. The CSD86330EVM-717 is designed to demonstrate the CSD86330 device in a typical low-voltage application while providing test points to evaluate the performance of the board.

2.1 Typical Applications

- Point-of-Load Systems
- Storage Computer
- Server Computer
- Multi-Function Printer
- Embedded Computing

2.2 Features

The CSD86330EVM-717 features:

- 10-A DC Steady State Output Current
- High Efficiency and High-Power Density by Using TI Power Block MOSFET (CSD86330)
- Convenient Test Points for Probing Critical Waveforms

3 Electrical Performance Specifications

Table 1. CSD86330EVM-717 Electrical Performance Specifications

PARAMETER	TEST CONDITIONS	MIN	TYP	MAX	UNITS
Input Characteristics					
Voltage range	V _{IN}	9	12	13.2	V
Maximum input current	V _{IN} = 9 V, I _O = 10 A		1.6		A
No load input current	V _{IN} = 13.2 V, I _O = 0 A		1		mA
Output Characteristics					
Output voltage V _{OUT}	I _O = 5 A	1.164	1.2	1.236	V
Output voltage regulation	Line regulation(V _{IN} = 9 V 13.2 V, I _O =0 A - 10 A)	0.5%			
	Load regulation(V _{IN} = 12 V, I _O = 0 A - 10 A)	0.5%			
Output voltage ripple	V _{IN} = 12 V, I _O = 10 A	40			mV _{PP}
Output load current		0		10	A
Output over current		12			
Systems Characteristics					
Switching frequency		500			kHz
Peak efficiency	V _{IN} = 9 V, 1.2 V/5 A	92%			
Full load efficiency	V _{IN} = 12 V, 1.2 V/10 A	89.4%			
Operating temperature		25			°C

5 Test Setup

5.1 Test Equipment

Voltage Source: The input voltage source V_{IN} should be a 0-V to 13.2-V variable DC source capable of supplying 4 A_{DC} . Connect V_{IN} to board as shown in [Figure 3](#).

Multimeters:

- V1: V_{IN} at TP1 (V_{IN}) and TP2 (GND).
- V2: V_{OUT} at TP5 (V_{OUT}) and TP6 (GND).
- A1: V_{IN} input current.

Output Load: The output load should be an electronic constant resistance mode load capable of 0 A_{DC} to 10 A_{DC} at 1.2 V.

Oscilloscope: A digital or analog oscilloscope can be used to measure the output ripple. The oscilloscope should be set for 1-M Ω impedance, 20-MHz bandwidth, AC coupling, 1- μ s/division horizontal resolution, 50-mV/division vertical resolution. Test points TP5 and TP6 can be used to measure the output ripple voltage by placing the oscilloscope probe tip through TP5 and holding the ground barrel TP6 as shown in [Figure 2](#). Using a leaded ground connection may induce additional noise due to the large ground loop.

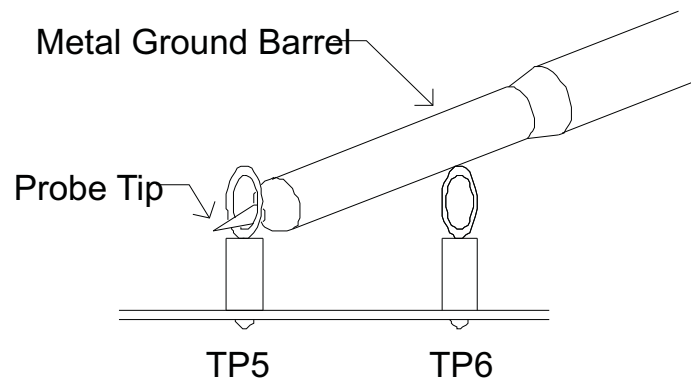

Figure 2. Tip and Barrel Measurement for V_{OUT} Ripple

Fan: Some of the components in this EVM may approach temperatures of 60°C during operation. A small fan capable of 200 LFM to 400 LFM is recommended to reduce component temperatures while the EVM is operating. The EVM should not be probed if the fan is not running.

Recommended Wire Gauge:

- **VIN to VIN1(12-V input):** The recommended wire size is 1x AWG #18 per input connection, with the total length of wire less than 4 feet (a 2 foot input and a 2 foot return).

VOUT1 to LOAD: The recommended wire size is 1x AWG #18, with the total length of wire less than 4 feet (a 2 foot input and a 2 foot return).

5.2 Recommended Test Setup

Figure 3 is the recommended test set up to evaluate the CSD86330EVM-717. Working at an ESD workstation, make sure that any wrist straps, bootstraps or mats are connected referencing the user to earth ground before power is applied to the EVM.

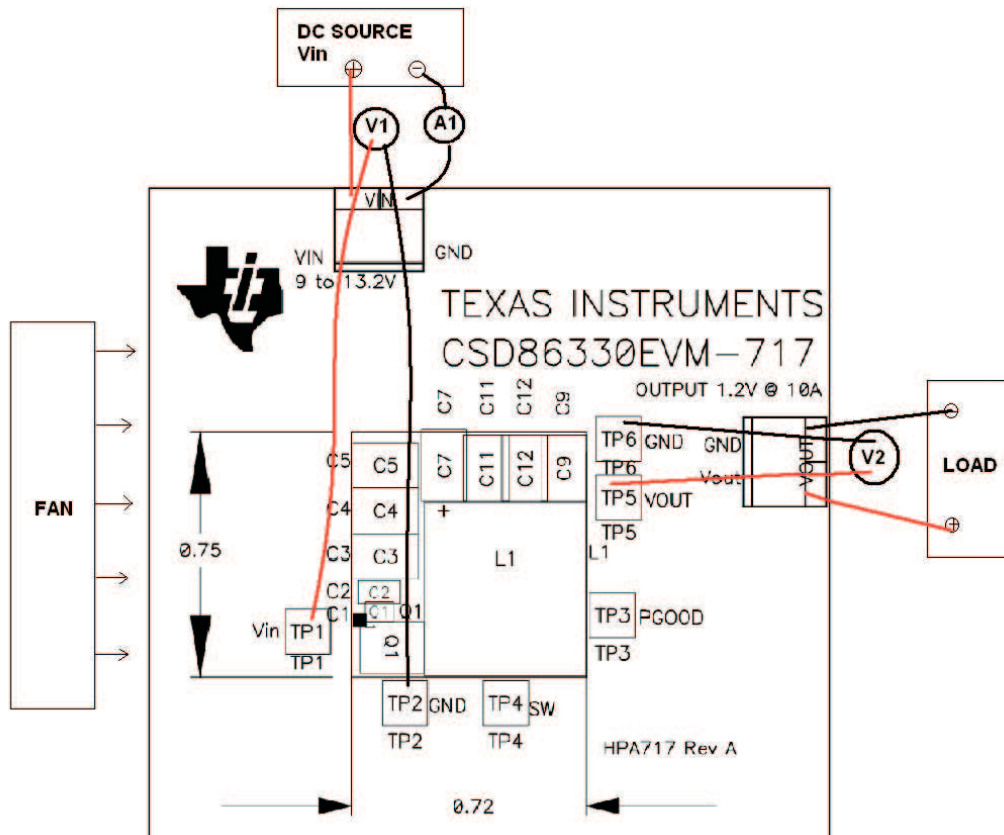

Figure 3. CSD86330EVM-717 Recommended Test Set Up

Input Connections:

- Prior to connecting the DC input source V_{IN} , it is advisable to limit the source current from V_{IN} to 10 A maximum. Make sure V_{IN} is initially set to 0 V and connected as shown in Figure 3.
- Connect a voltmeter V1 at TP1(V_{IN}) and TP2(GND) to measure the input voltage.
- Connect a current meter A1 to measure the input current.

Output Connections:

- Connect load to VOUT1 and set load to constant resistance mode to sink 0 A_{DC} before V_{IN} is applied.
- Connect a voltmeter V2 at TP5 (V_{OUT}) and TP6 (GND) to measure the output voltage.

Other Connections: Place a fan as shown in Figure 3 and turn on, making sure air is flowing across the EVM.

6 Test Procedure

6.1 Line/Load Regulation and Efficiency Measurement Procedure

1. Set up the EVM as described in [Section 5](#) and [Figure 3](#).
2. Ensure load is set to constant resistance mode and to sink 0 A_{DC}.
3. Ensure all configuration settings are as per [Section 6](#).
4. Increase V_{IN} from 0 V to 12 V. Using V1 to measure input voltage.
5. Use V2 to measure V_{OUT} voltage.
6. Vary load from 0 A_{DC} to 10 A_{DC}, V_{OUT} should remain in load regulation.
7. Vary V_{IN} from 9 V to 13.2 V, V_{OUT} should remain in line regulation.
8. Decrease load to 0 A.
9. Decrease V_{IN} to 0 V.

6.2 List of Test Points

Table 2. Test Point Functions

TEST POINTS	NAME	DESCRIPTION
TP1	V _{IN}	Input voltage measurement point
TP2	GND	Ground for V _{IN} measurements
TP3	PGOOD	Power Good monitoring point
TP4	SW	Switch Node monitoring point
TP5	V _{OUT}	Output Voltage measurement point
TP6	GND	Ground for output voltage measurements

6.3 Equipment Shutdown

1. Shut down load
2. Shut down V_{IN}
3. Shut down fan

7 Performance Data and Typical Characteristic Curves

Figure 4 through Figure 11 present typical performance curves for CSD86330EVM-717.

7.1 Efficiency

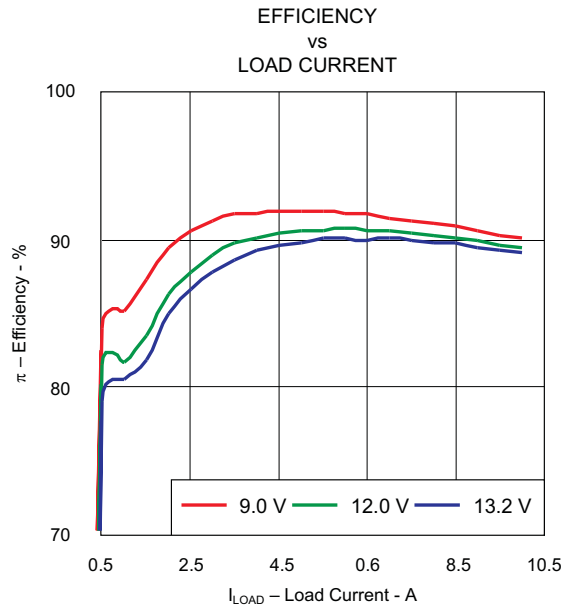

Figure 4. Efficiency

7.2 Light-Load Efficiency

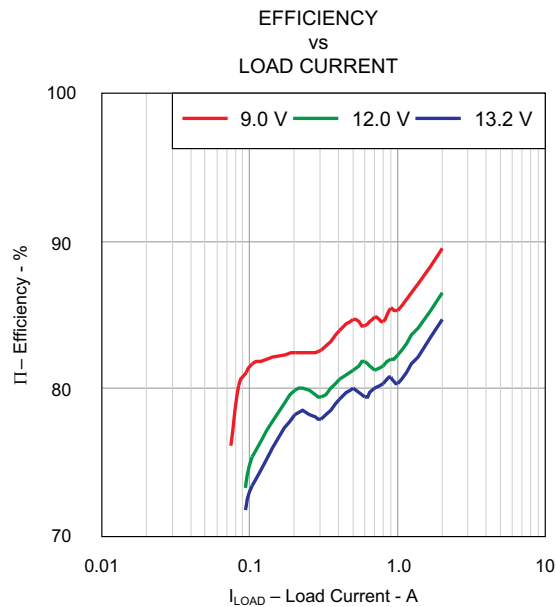

Figure 5. Light-Load Efficiency

7.3 Load Regulation

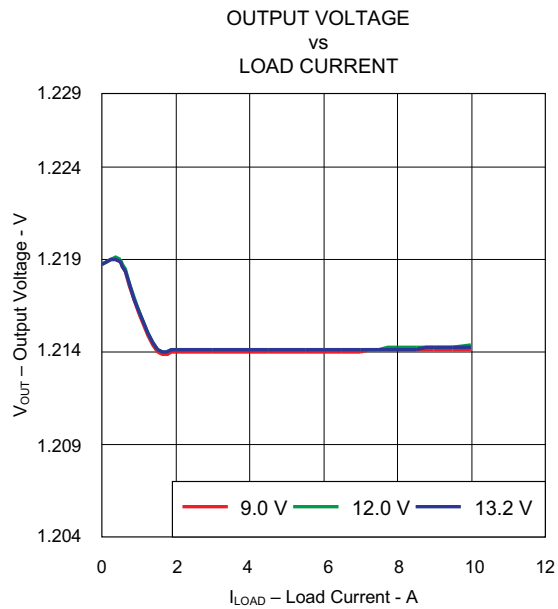

Figure 6. Load Regulation

7.4 Output Transient

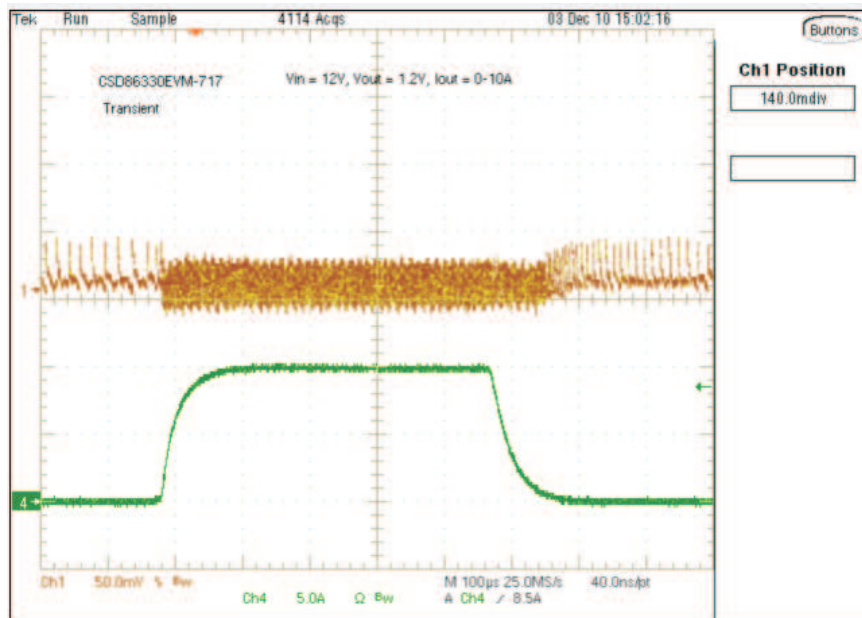

Figure 7. Output-Load Transient

7.5 Output Ripple

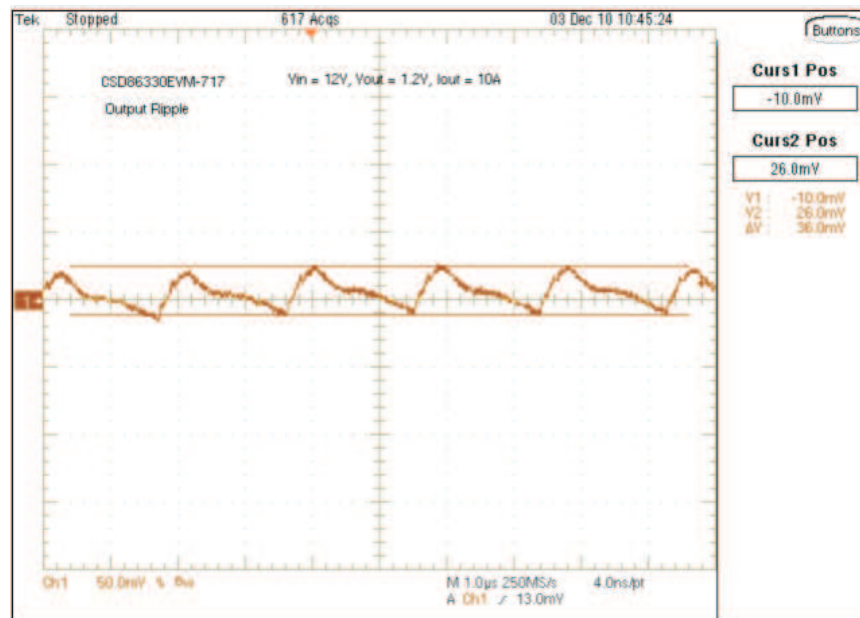

Figure 8. Output Ripple

7.6 Switching Node

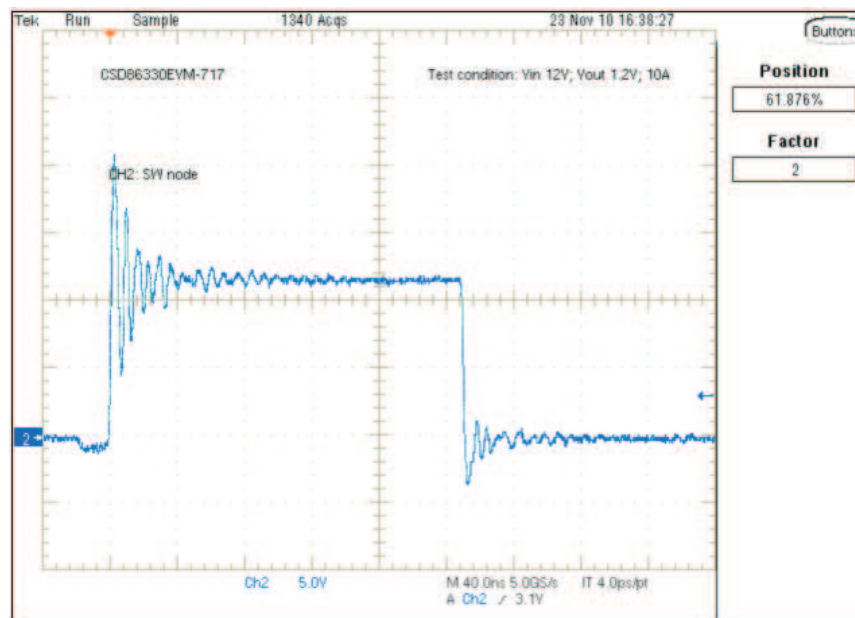

Figure 9. Output Ripple

7.7 Thermal Image

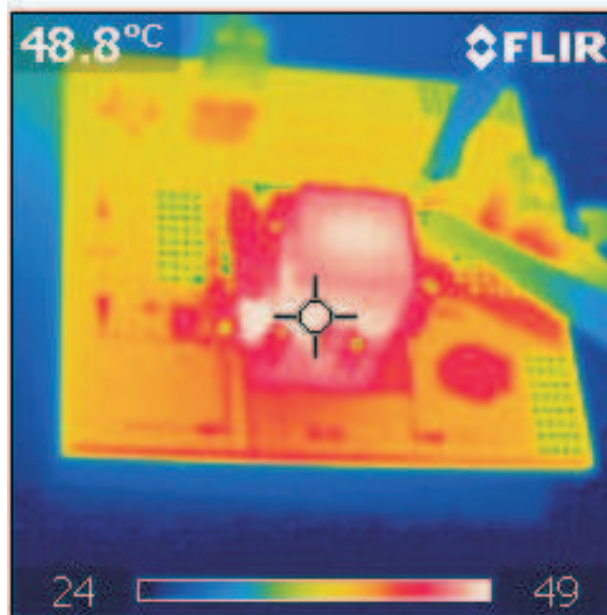

Figure 10. Top Board at 12 V_{IN}, 1.2 V/10 A with natural air convection

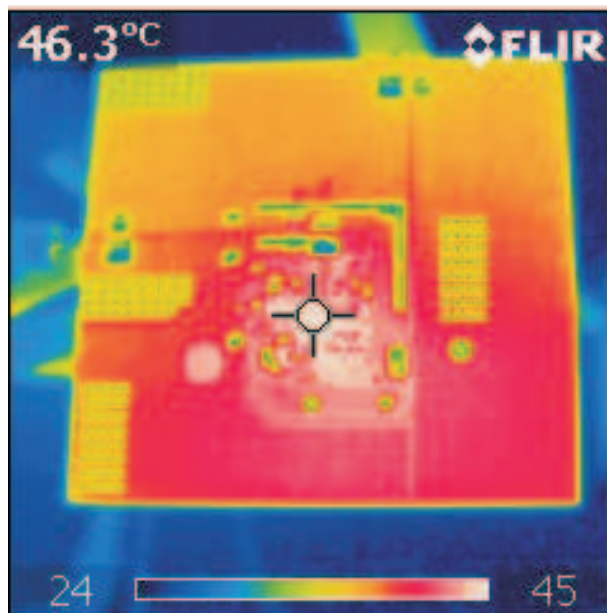

Figure 11. Bottom Board at 12 V_{IN}, 1.2 V/10 A with natural air convection

8 CSD86330EVM-717 Assembly Drawing and PCB Layout

The following figures (Figure 12 through Figure 19) show the design of the CSD86330EVM-717 printed circuit board. The EVM has been designed using six layers and a 2-oz copper circuit board.

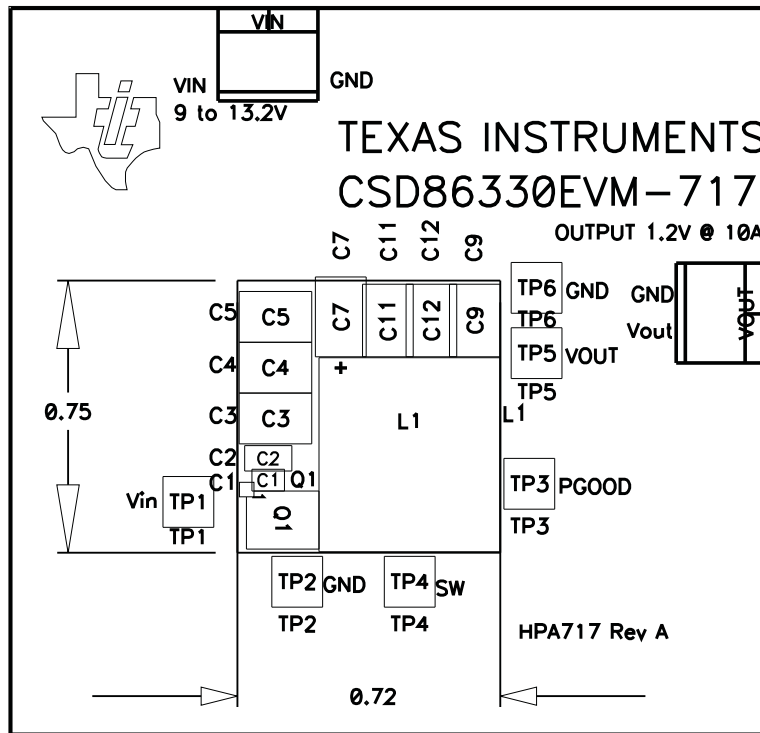

Figure 12. Top Layer Assembly Drawing (top view)

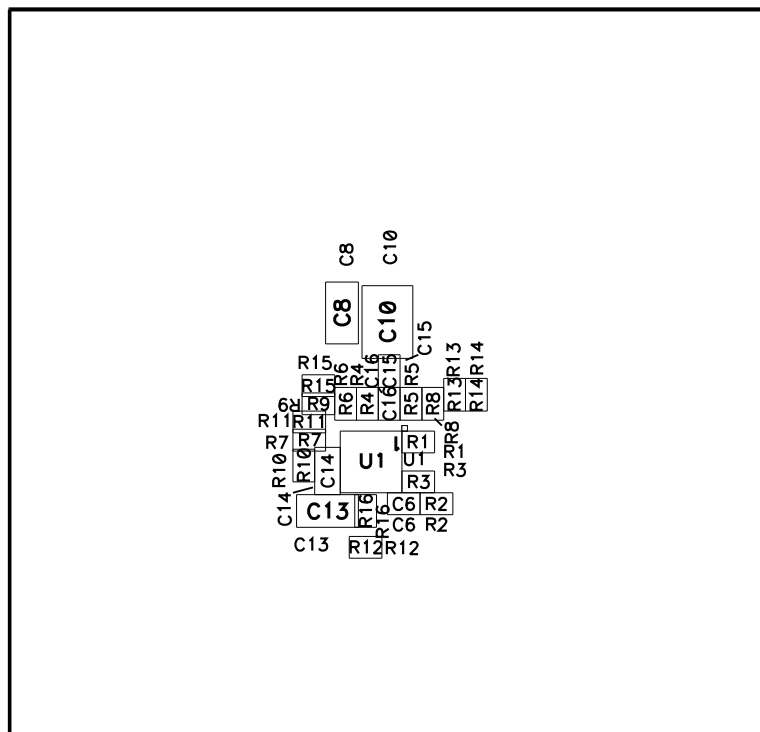

Figure 13. Bottom Layer Assembly Drawing (bottom view)

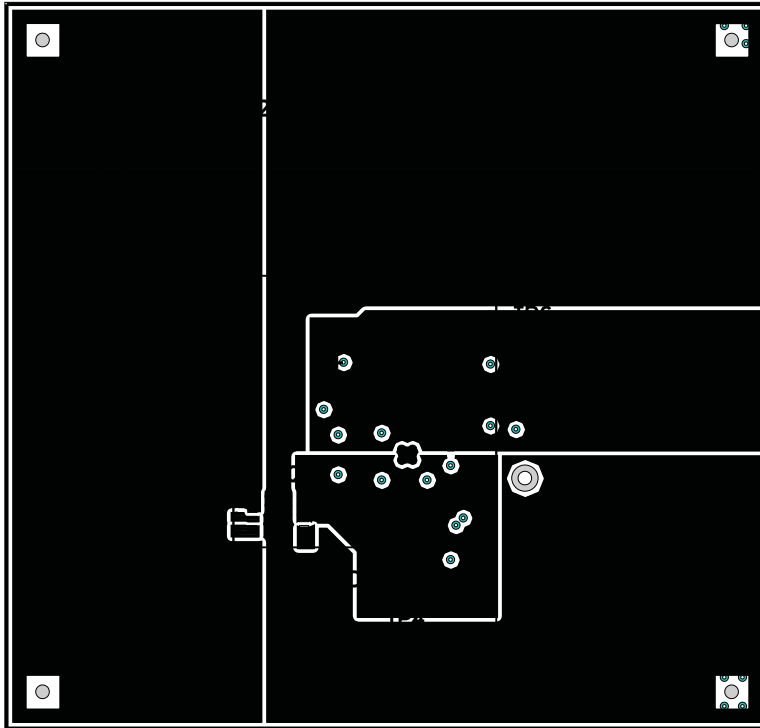

Figure 14. Top Copper

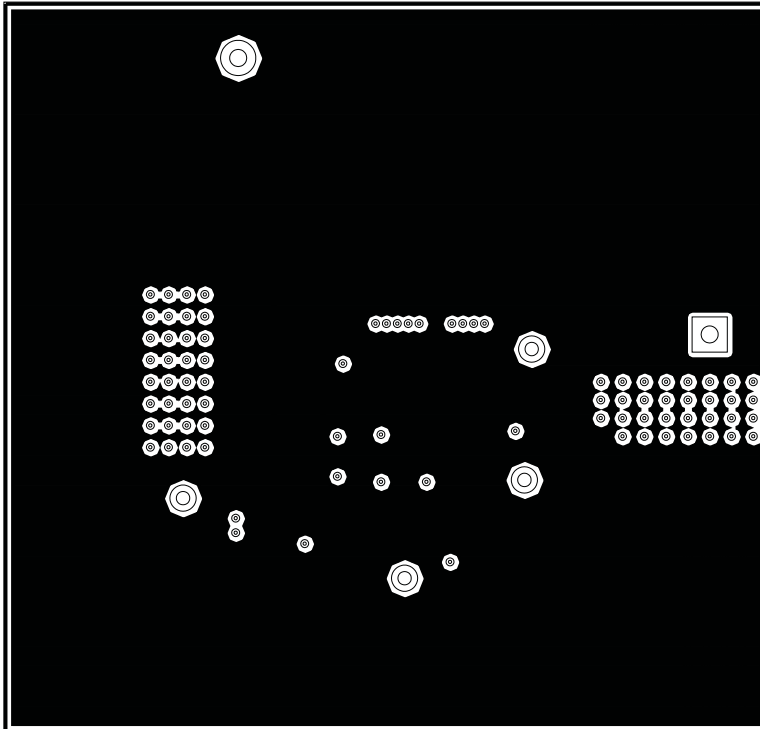

Figure 15. Layer 2

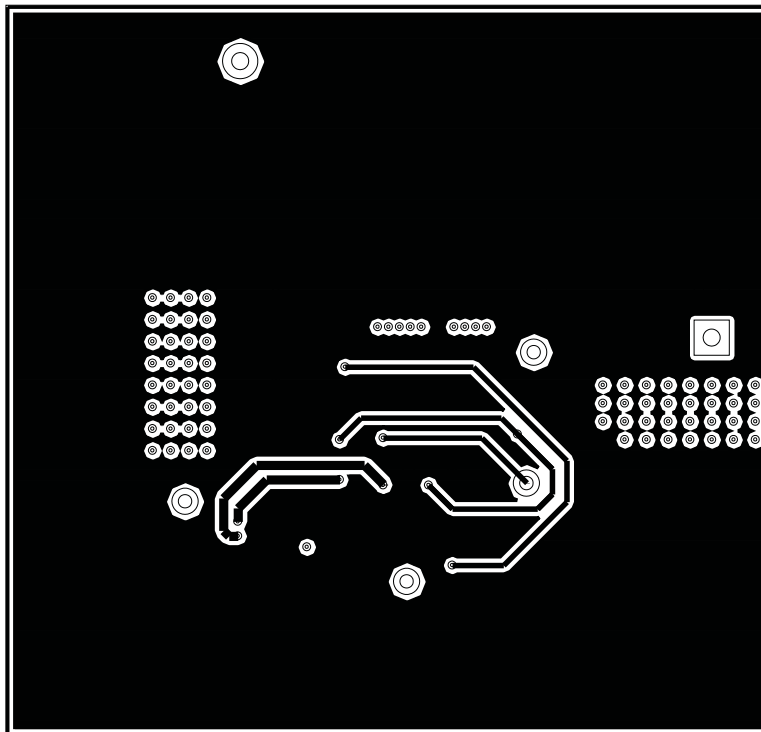

Figure 16. Layer 3

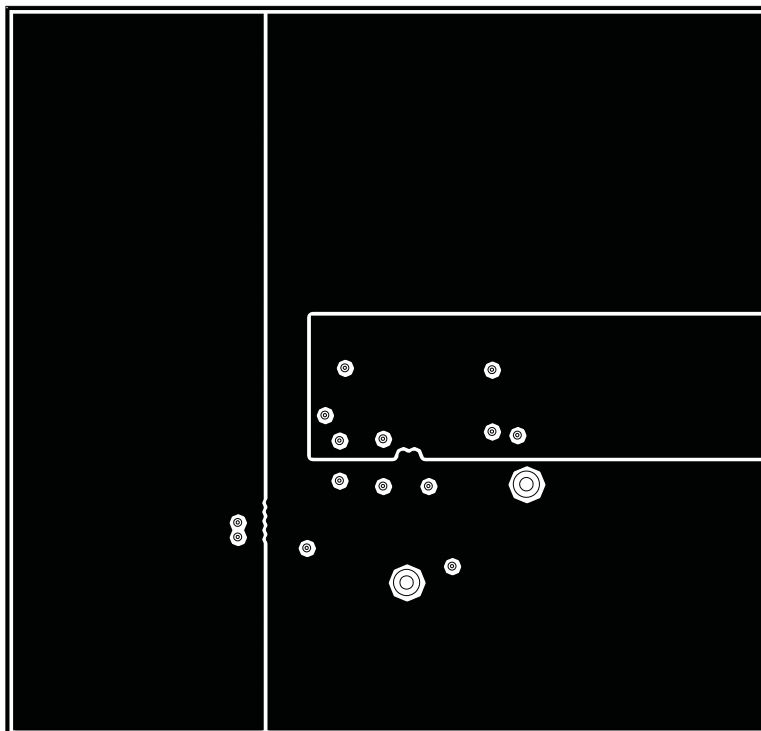

Figure 17. Layer 4

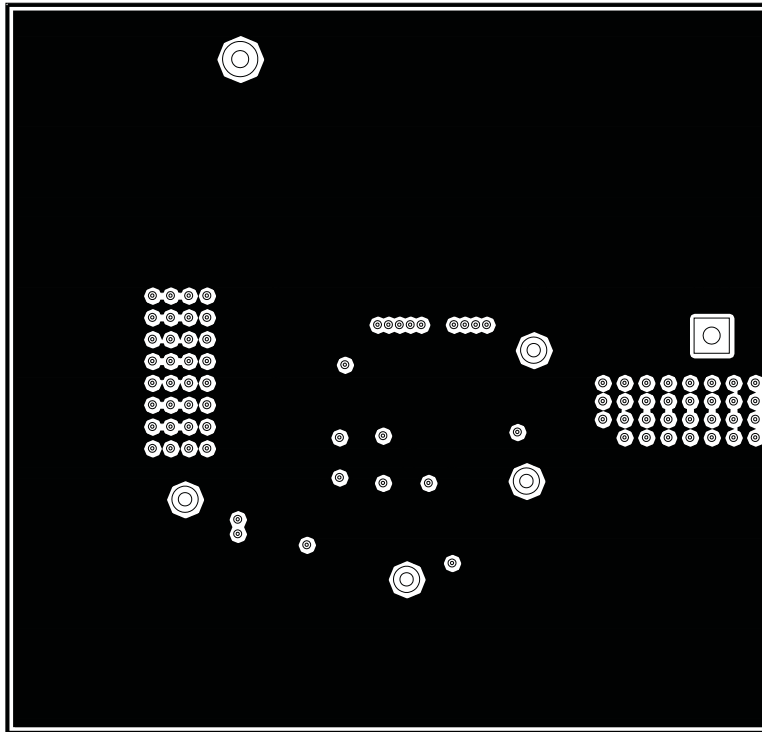

Figure 18. Layer 5

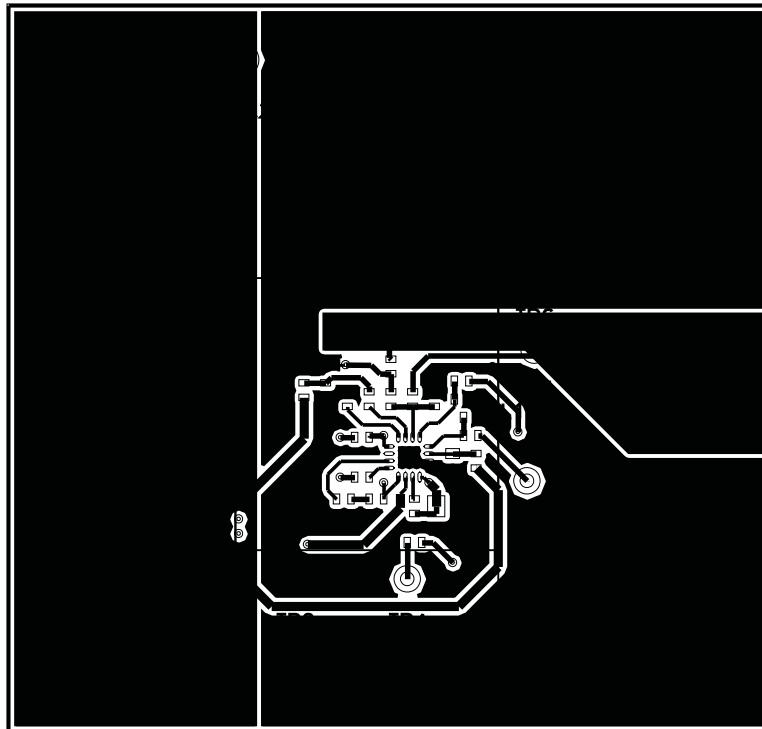

Figure 19. Bottom Layer

9 List of Materials

The EVM components list according to [Figure 1](#).

Table 3. List of Materials

QTY	REF DES	DESCRIPTION	MFR	PART NUMBER
1	C1	Capacitor, ceramic, 25 V, X7R, 10%, 402	Std	Std
2	C2, C14	Capacitor, ceramic, 25 V, X5R, 20%, 603	Std	Std
3	C3, C4, C5	Capacitor, ceramic, 25 V, X5R, 20%, 1210	Std	Std
2	C6	Capacitor, ceramic, 16 V, X7R, 10%, 402	Std	Std
1	C7	Capacitor, POSCAP, 330 μ F, 2.5 V, 0.009 Ω , 20%, Case B2805, 3528(B)	Sanyo	2R5TPE330MA9R
2	C8, C13	Capacitor, ceramic, 10 V, X5R, 20%,	Std	Std
0	C9, C10, C11, C12, C15, C16	Capacitor, ceramic, 6.3 V, X5R, 20%, 1210	Std	Std
1	L1	Inductor, SMT, 24 A, 1.17 m Ω , 0.288 inch x 0.288 inch	Würth Elektronik	7443320100
1	Q1	MOSFET, Synchronous Buck NexFET Power Block, QFN-8 Power	TI	CSD86330Q3D
3	R1, R11, R13	Resistor, chip, 1/16 W, 1%, 402	Std	Std
1	R10	Resistor, chip, 1/16 W, 1%, 402	Std	Std
1	R14	Resistor, chip, 1/16 W, 1%, 402	Std	Std
3	R2, R3, R16	Resistor, chip, 1/16 W, 1%, 402	Std	Std
2	R4, R6	Resistor, chip, 1/16 W, 1%, 402	Std	Std
1	R5	Resistor, chip, 1/16 W, 1%, 402	Std	Std
0	R7, R9, R12, R15	Resistor, chip, 1/16 W, 1%, 402	Std	Std
1	R8	Resistor, chip, 1/16 W, 1%, 402	Std	Std
1	U1	Single Synchronous Step-Down Controller, QFN-16	TI	TPS53219RGT

Evaluation Board/Kit Important Notice

Texas Instruments (TI) provides the enclosed product(s) under the following conditions:

This evaluation board/kit is intended for use for **ENGINEERING DEVELOPMENT, DEMONSTRATION, OR EVALUATION PURPOSES ONLY** and is not considered by TI to be a finished end-product fit for general consumer use. Persons handling the product(s) must have electronics training and observe good engineering practice standards. As such, the goods being provided are not intended to be complete in terms of required design-, marketing-, and/or manufacturing-related protective considerations, including product safety and environmental measures typically found in end products that incorporate such semiconductor components or circuit boards. This evaluation board/kit does not fall within the scope of the European Union directives regarding electromagnetic compatibility, restricted substances (RoHS), recycling (WEEE), FCC, CE or UL, and therefore may not meet the technical requirements of these directives or other related directives.

Should this evaluation board/kit not meet the specifications indicated in the User's Guide, the board/kit may be returned within 30 days from the date of delivery for a full refund. **THE FOREGOING WARRANTY IS THE EXCLUSIVE WARRANTY MADE BY SELLER TO BUYER AND IS IN LIEU OF ALL OTHER WARRANTIES, EXPRESSED, IMPLIED, OR STATUTORY, INCLUDING ANY WARRANTY OF MERCHANTABILITY OR FITNESS FOR ANY PARTICULAR PURPOSE.**

The user assumes all responsibility and liability for proper and safe handling of the goods. Further, the user indemnifies TI from all claims arising from the handling or use of the goods. Due to the open construction of the product, it is the user's responsibility to take any and all appropriate precautions with regard to electrostatic discharge.

EXCEPT TO THE EXTENT OF THE INDEMNITY SET FORTH ABOVE, NEITHER PARTY SHALL BE LIABLE TO THE OTHER FOR ANY INDIRECT, SPECIAL, INCIDENTAL, OR CONSEQUENTIAL DAMAGES.

TI currently deals with a variety of customers for products, and therefore our arrangement with the user **is not exclusive.**

TI assumes **no liability for applications assistance, customer product design, software performance, or infringement of patents or services described herein.**

Please read the User's Guide and, specifically, the Warnings and Restrictions notice in the User's Guide prior to handling the product. This notice contains important safety information about temperatures and voltages. For additional information on TI's environmental and/or safety programs, please contact the TI application engineer or visit www.ti.com/esh.

No license is granted under any patent right or other intellectual property right of TI covering or relating to any machine, process, or combination in which such TI products or services might be or are used.

FCC Warning

This evaluation board/kit is intended for use for **ENGINEERING DEVELOPMENT, DEMONSTRATION, OR EVALUATION PURPOSES ONLY** and is not considered by TI to be a finished end-product fit for general consumer use. It generates, uses, and can radiate radio frequency energy and has not been tested for compliance with the limits of computing devices pursuant to part 15 of FCC rules, which are designed to provide reasonable protection against radio frequency interference. Operation of this equipment in other environments may cause interference with radio communications, in which case the user at his own expense will be required to take whatever measures may be required to correct this interference.

EVM Warnings and Restrictions

It is important to operate this EVM within the input voltage range of 10 VDC to 14 VDC and the output voltage range of 0 ADC to 20ADC.

Exceeding the specified input range may cause unexpected operation and/or irreversible damage to the EVM. If there are questions concerning the input range, please contact a TI field representative prior to connecting the input power.

Applying loads outside of the specified output range may result in unintended operation and/or possible permanent damage to the EVM. Please consult the EVM User's Guide prior to connecting any load to the EVM output. If there is uncertainty as to the load specification, please contact a TI field representative.

During normal operation, some circuit components may have case temperatures greater than 100° C. The EVM is designed to operate properly with certain components above 100° C as long as the input and output ranges are maintained. These components include but are not limited to linear regulators, switching transistors, pass transistors, and current sense resistors. These types of devices can be identified using the EVM schematic located in the EVM User's Guide. When placing measurement probes near these devices during operation, please be aware that these devices may be very warm to the touch.

Mailing Address: Texas Instruments, Post Office Box 655303, Dallas, Texas 75265
Copyright © 2011, Texas Instruments Incorporated

IMPORTANT NOTICE

Texas Instruments Incorporated and its subsidiaries (TI) reserve the right to make corrections, modifications, enhancements, improvements, and other changes to its products and services at any time and to discontinue any product or service without notice. Customers should obtain the latest relevant information before placing orders and should verify that such information is current and complete. All products are sold subject to TI's terms and conditions of sale supplied at the time of order acknowledgment.

TI warrants performance of its hardware products to the specifications applicable at the time of sale in accordance with TI's standard warranty. Testing and other quality control techniques are used to the extent TI deems necessary to support this warranty. Except where mandated by government requirements, testing of all parameters of each product is not necessarily performed.

TI assumes no liability for applications assistance or customer product design. Customers are responsible for their products and applications using TI components. To minimize the risks associated with customer products and applications, customers should provide adequate design and operating safeguards.

TI does not warrant or represent that any license, either express or implied, is granted under any TI patent right, copyright, mask work right, or other TI intellectual property right relating to any combination, machine, or process in which TI products or services are used. Information published by TI regarding third-party products or services does not constitute a license from TI to use such products or services or a warranty or endorsement thereof. Use of such information may require a license from a third party under the patents or other intellectual property of the third party, or a license from TI under the patents or other intellectual property of TI.

Reproduction of TI information in TI data books or data sheets is permissible only if reproduction is without alteration and is accompanied by all associated warranties, conditions, limitations, and notices. Reproduction of this information with alteration is an unfair and deceptive business practice. TI is not responsible or liable for such altered documentation. Information of third parties may be subject to additional restrictions.

Resale of TI products or services with statements different from or beyond the parameters stated by TI for that product or service voids all express and any implied warranties for the associated TI product or service and is an unfair and deceptive business practice. TI is not responsible or liable for any such statements.

TI products are not authorized for use in safety-critical applications (such as life support) where a failure of the TI product would reasonably be expected to cause severe personal injury or death, unless officers of the parties have executed an agreement specifically governing such use. Buyers represent that they have all necessary expertise in the safety and regulatory ramifications of their applications, and acknowledge and agree that they are solely responsible for all legal, regulatory and safety-related requirements concerning their products and any use of TI products in such safety-critical applications, notwithstanding any applications-related information or support that may be provided by TI. Further, Buyers must fully indemnify TI and its representatives against any damages arising out of the use of TI products in such safety-critical applications.

TI products are neither designed nor intended for use in military/aerospace applications or environments unless the TI products are specifically designated by TI as military-grade or "enhanced plastic." Only products designated by TI as military-grade meet military specifications. Buyers acknowledge and agree that any such use of TI products which TI has not designated as military-grade is solely at the Buyer's risk, and that they are solely responsible for compliance with all legal and regulatory requirements in connection with such use.

TI products are neither designed nor intended for use in automotive applications or environments unless the specific TI products are designated by TI as compliant with ISO/TS 16949 requirements. Buyers acknowledge and agree that, if they use any non-designated products in automotive applications, TI will not be responsible for any failure to meet such requirements.

Following are URLs where you can obtain information on other Texas Instruments products and application solutions:

Products

Audio	www.ti.com/audio
Amplifiers	amplifier.ti.com
Data Converters	dataconverter.ti.com
DLP® Products	www.dlp.com
DSP	dsp.ti.com
Clocks and Timers	www.ti.com/clocks
Interface	interface.ti.com
Logic	logic.ti.com
Power Mgmt	power.ti.com
Microcontrollers	microcontroller.ti.com
RFID	www.ti-rfid.com
RF/IF and ZigBee® Solutions	www.ti.com/lprf

Applications

Communications and Telecom	www.ti.com/communications
Computers and Peripherals	www.ti.com/computers
Consumer Electronics	www.ti.com/consumer-apps
Energy and Lighting	www.ti.com/energy
Industrial	www.ti.com/industrial
Medical	www.ti.com/medical
Security	www.ti.com/security
Space, Avionics and Defense	www.ti.com/space-avionics-defense
Transportation and Automotive	www.ti.com/automotive
Video and Imaging	www.ti.com/video
Wireless	www.ti.com/wireless-apps

TI E2E Community Home Page

e2e.ti.com

Mailing Address: Texas Instruments, Post Office Box 655303, Dallas, Texas 75265
Copyright © 2011, Texas Instruments Incorporated