



ABSTRACT

This report discusses the results of the total-ionizing dose (TID) testing for the Texas Instruments TPS7H2140-SEP. The TPS7H2140-SEP device is a fully protected quad-channel eFuse with four integrated 160-mΩ NMOS power FETs. Full diagnostics and high-accuracy current sense enables intelligent control of the loads. An external adjustable current limit improves the reliability of whole system by limiting the inrush or overload current.

The study was done to determine TID effects under high dose rate (HDR) and low dose rate (LDR) up to 30 krad(Si). The results show that all samples passed within the specified limits up to 30 krad(Si) for HDR and LDR.

Table of Contents

1 Device Information	2
1.1 Product Description.....	2
1.2 Device Details.....	2
2 Total Dose Test Setup	3
2.1 Test Overview.....	3
2.2 Test Description and Facilities.....	3
2.3 Test Setup Details.....	3
2.4 Test Configuration and Condition.....	4
3 TID Characterization Test Results	5
3.1 TID Characterization Summary Results.....	5
3.2 Data Sheet Electrical Parameters.....	6
4 Applicable and Reference Documents	11
4.1 Applicable Documents.....	11
4.2 Reference Documents.....	11
A Appendix: HDR TID Report	12
B Appendix B: LDR TID Report	13
C Revision History	14

List of Figures

Figure 1-1. TPS7H2140-SEP Devices Used in Exposure (Front).....	2
Figure 1-2. TPS7H2140-SEP Devices Used in Exposure (Back).....	2
Figure 2-1. Bias Diagram Used in TID Exposure.....	3

List of Tables

Table 1-1. Device and Exposure Details.....	2
Table 2-1. HDR Biased Device Information.....	4
Table 2-2. HDR Unbiased Device Information.....	4
Table 2-3. LDR Biased Device Information.....	4
Table 2-4. LDR Unbiased Device Information.....	4
Table 3-1. TPS7H2140-SEP Data Sheet Electrical Parameters.....	6
Table 3-2. TPS7H2140-SEP Data Sheet Electrical Parameters.....	10

Trademarks

All trademarks are the property of their respective owners.

1 Device Information

1.1 Product Description

The TPS7H2140-SEP device is a fully protected quad-channel eFuse with four integrated 160-mΩ NMOS power FETs. Full diagnostics and high-accuracy current sense enables intelligent control of the loads. An external adjustable current limit improves the reliability of whole system by limiting the inrush or overload current.

1.2 Device Details

Table 1-1 lists the device information used in the TID HDR characterization.

Table 1-1. Device and Exposure Details

TID HDR and LDR Details	
Package	28-pin HTSSOP (PWP)
TI part name	TPS7H2140MPWPTSEP
Device function	Quad-channel eFuse
Quantity tested	HDR : <ul style="list-style-type: none"> • Five biased and five unbiased units at 20-krad(Si) levels • Five biased and five unbiased units at 30-krad(Si) levels • Five correlation units LDR: <ul style="list-style-type: none"> • Five biased and five unbiased units at 20-krad(Si) levels • Five biased and five unbiased units at 30-krad(Si) levels • Five correlation units
HDR radiation facility	Texas Instruments CLAB Dallas, Texas
LDR radiation facility	VPT Rad, Chelmsford, MA
HDR dose rate	50-300-rad(Si)/s
LDR dose rate	10mrad(Si)/s
Irradiation and test temperature	Ambient, room temperature controlled to 25°C ±6°C per MIL-STD-883 and MIL-STD-750



Figure 1-1. TPS7H2140-SEP Devices Used in Exposure (Front)

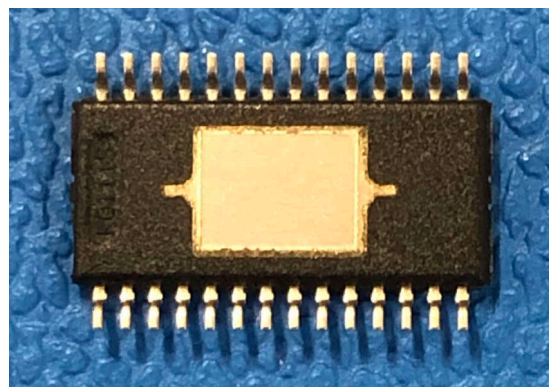

Figure 1-2. TPS7H2140-SEP Devices Used in Exposure (Back)

2 Total Dose Test Setup

2.1 Test Overview

The TPS7H2140-SEP was tested according to MIL-STD-883, Test Method 1019.9. For this testing, Conditions A and D were used. For this test, the product was irradiated up to the target radiation level, and then put through full electrical parametric testing on the production Automated Test Equipment (ATE). All devices remained functional passing all parametric test limits.

2.2 Test Description and Facilities

The TPS7H2140-SEP HDR exposure was performed on biased and unbiased devices in a Co-60 gamma cell at Texas Instruments CLAB in Dallas, Texas. The dose rate for exposure must be between 50 and 300krad(Si) / sec per MIL standard (MIL-STD-883). For the purpose of these tests, the actual dose rate for the devices was 202.039 rad(Si) / sec. After exposure, the devices were packed in dry ice (per MIL-STD-883 Method 1019.9 section 3.10) and tested at room-temperature for post-radiation electrical evaluation using Texas Instruments ATE. ATE test limits are set per data sheet electrical limits based on qualification and characterization data.

The TPS7H2140-SEP LDR exposure was performed on biased and unbiased devices in a Co60 gamma cell under a 10-mrad(Si) / s exposure rate. The dose rate of the irradiator used in the exposure ranges from < 10 mrad(Si) / s to a maximum of approximately 65 rad(Si) / s, determined by the distance from the source. The exposure boards are housed in a lead-aluminum box (as specified in MIL-STD-883 TM 1019.9) to harden the gamma spectrum and minimize dose enhancement effects. The irradiator calibration is maintained by Logmire Laboratories using Thermoluminescence Dosimeters (TLDs) traceable to the National Institute of Standards and Technology (NIST) and the dosimetry was verified using TLDs prior to the radiation exposures. After exposure, the devices were returned to TI Dallas and tested at room temperature for postradiation electrical evaluation using Texas Instruments production ATE. ATE test limits are set per data sheet electrical limits based on qualification and characterization data.

2.3 Test Setup Details

The devices under HDR and LDR exposure were tested in two conditions, biased and unbiased, as described in the following sections.

2.3.1 Unbiased

For the unbiased HDR and LDR conditions, the exposure was performed with all pins grounded.

2.3.2 Biased

Figure 2-1 shows the bias conditions used for HDR and LDR exposure.

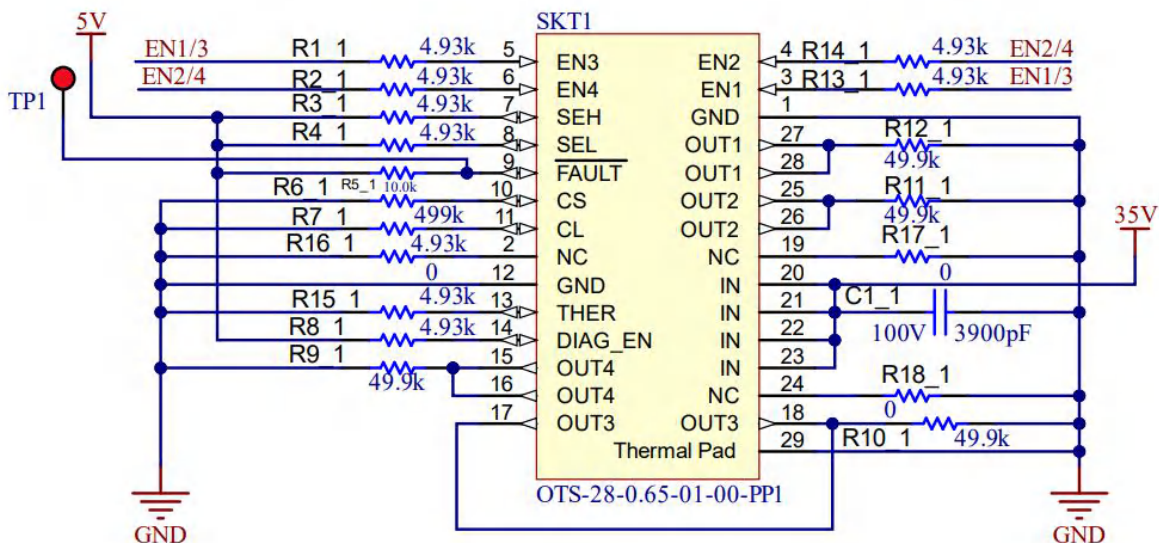

Figure 2-1. Bias Diagram Used in TID Exposure

2.4 Test Configuration and Condition

HDR devices were stressed at 20 krad(Si) and 30 krad(Si) for biased and unbiased conditions.

Table 2-1. HDR Biased Device Information

Total Samples: 10	
Exposure Levels:	
20 krad(Si) (5 samples)	30 krad(Si) (5 samples)
6, 7, 8, 9, 10	16, 17, 18, 19, 20

Table 2-2. HDR Unbiased Device Information

Total Samples: 10	
Exposure levels:	
20 krad(Si) (5 samples)	30 krad(Si) (5 samples)
1, 2, 3, 4, 5	11, 12, 13, 14, 15

LDR devices were stressed at 20 krad(Si) and 30 krad(Si) for biased and unbiased conditions.

Table 2-3. LDR Biased Device Information

Total Samples: 10	
Exposure levels:	
20 krad(Si) (5 samples)	30 krad(Si) (5 samples)
50, 51, 52, 53, 54	55, 56, 57, 58, 59

Table 2-4. LDR Unbiased Device Information

Total Samples: 10	
Exposure levels:	
20 krad(Si) (5 samples)	30 krad(Si) (5 samples)
60, 61, 62, 63, 64	65, 66, 67, 68, 69

3 TID Characterization Test Results

3.1 TID Characterization Summary Results

The results show that all devices were fully functional and within specification limits up to 30 krad(Si) for HDR and LDR TID.

Overall, the TPS7H2140-SEP showed a strong degree of hardness to HDR and LDR TID irradiation up to 30 krad(Si) for both biased and unbiased exposure conditions. The measurements taken post-irradiation for each sample set showed a marginal shift for most parameters at each dose level for both biased and unbiased. The parameters that did show a greater degree of change between pre- and post-irradiation were still within the data sheet electrical specifications (see [Section 3.2](#) for the data sheet electrical parameters table).

See [Appendix A](#) for HDR report up to 30 krad(Si).

See [Appendix B](#) for LDR report up to 30 krad(Si).

3.2 Data Sheet Electrical Parameters

Table 3-1 lists electrical and switching characteristics.

Table 3-1. TPS7H2140-SEP Data Sheet Electrical Parameters

Parameter		Test Conditions		MIN	TYP	MAX	UNIT	Tests
OPERATING VOLTAGE								
IN _{UVLOR}	Internal V _{IN} UVLO rising			3.5	3.7	4	V	6.1
IN _{UVLOF}	Internal V _{IN} UVLO falling			3	3.2	3.4		6.2
HYST _{IN-UVLO}	Internal V _{IN} UVLO hysteresis			0.5				6.3
OPERATING CURRENT								
I _Q	Quiescent current with diagnostics disabled	ENx = 5 V, DIAG_EN = 0 V, I _{OUTx} = 0 A, current limit = 2 A, all channels on				7.0	mA	5.9, 5.10, 5.11, 5.12
I _{Q-DIAG}	Quiescent current with diagnostics enabled	ENx = DIAG_EN = 5 V, I _{OUTx} = 0 A, current limit = 2 A, all channels on				6.2		5.5, 5.6, 5.7, 5.8
I _{SD}	Shutdown current with diagnostics disabled	ENx = DIAG_EN = OUTx = THER = 0 V	T _A = 25°C			0.5	μA	5.13, 5.14, 5.15, 5.16
			T _A = 125°C			5		
I _{SD-DIAG}	Shutdown current with diagnostic enabled	ENx = 0 V, DIAG_EN = 5 V, V _{IN} - V _{OUTx} < V _{OL-OFF} , not in open-load mode				5	mA	5.17, 5.18, 5.19, 5.20
t _{LOW-OFF}	ENx signal low time during cycling	ENx from high to low, if elapsed time > t _{LOW-OFF} , the device enters into standby mode		10	12.5	15	ms	5.49, 5.50, 5.51, 5.52
I _F	IN to OUTx forward leakage current	ENx = DIAG_EN = OUTx = 0	T _A = 25°C			0.5	μA	5.21, 5.22, 5.23, 5.24, 5.25, 5.26, 5.27, 5.28, 5.29, 5.30, 5.31, 5.32, 5.33, 5.34, 5.35, 5.36
			T _A = 125°C			8		
POWER STAGE								
R _{ON}	On-state resistance		T _A = 25°C			165	mΩ	12.1, 12.2, 12.3, 12.4, 12.5, 12.6, 12.7, 12.8, 12.9, 12.10, 12.11, 12.12, 12.13, 12.14, 12.15, 12.16
			T _A = 125°C			280		

Table 3-1. TPS7H2140-SEP Data Sheet Electrical Parameters (continued)

Parameter		Test Conditions		MIN	TYP	MAX	UNIT	Tests
ΔR_{ON}	Percentage Difference in On-state resistance between channels ($R_{ON_CHx} - R_{ON_CHy}$)		$T_A = 25^\circ\text{C}$			6%		12.17, 12.18, 12.19, 12.20, 12.21, 12.22, 12.23, 12.24, 12.25, 12.26, 12.27, 12.28, 12.29, 12.30, 12.31, 12.32, 12.33, 12.34, 12.35, 12.36, 12.37, 12.38, 12.39, 12.40
$I_{CL_INTERNAL}$	Internal current limit	Internal current limit value, CL pin connected to GND			11		A	
$I_{CL_INTERNAL_TSD}$	Current limit during thermal shutdown	Internal current limit value under thermal shutdown			6.5			
I_{CL_TSD}	Current limit during thermal shutdown	External current limit value under thermal shutdown. The percentage of the external current limit setting value			70%			
V_{DS_CLAMP}	Source-to-drain body diode voltage			50		70	V	14.2, 14.4, 14.6, 14.8
OUTPUT DIODE CHARACTERISTICS								
V_F	Drain-source diode voltage	$ENx = 0, I_{OUTx} = -0.15\text{ A}$		0.3	0.7	0.9	V	8.5, 8.6, 8.7, 8.8
I_{R1}	Continuous reverse current from source to drain	$t < 60\text{ s}, V_{IN} = 24\text{ V}, ENx = 0\text{ V}$. Single channel reversed current to supply	$T_A = 25^\circ\text{C}$		2.5		A	
I_{R2}	Continuous reverse current from source to drain	$t < 60\text{ s}, V_{IN} = 24\text{ V}, ENx = 0\text{ V}$. GND pin 1-k Ω resistor in parallel with diode. Reverse-current condition, All channels reversed	$T_A = 25^\circ\text{C}$		2.0			
LOGIC INPUT (ENx, DIAG_EN, SEL, SEH, THER)								
V_{IH}	Logic high-level voltage			2			V	7.101, 7.401, 7.701, 7.1001, 7.131, 7.161, 7.191
V_{IL}	Logic low-level voltage					0.8		
R_{PULL_DOWN}	Logic-pin pulldown resistor	$V_{IN} = V_{DIAG_EN} = 5\text{ V}$		200	275	350	k Ω	7.29
		$V_{IN} = V_{ENx} = V_{SEL} = V_{SEH} = V_{THER} = 5\text{ V}$		100	175	250		7.22, 7.23, 7.24, 7.25, 7.26, 7.27, 7.28
DIAGNOSTICS								
I_{GND_LOSS}	Output leakage current under GND loss condition					100	μA	8.1, 8.2, 8.3, 8.4
V_{OL_OFF}	Open load detection threshold	$V_{ENx} = 0\text{ V}$, when $V_{IN} - V_{OUTx} > V_{OL_OFF}$. Duration longer than t_{OL_OFF} , then open load is detected, off state.		1.6		2.6	V	9.1
t_{OL_OFF}	Open-load detection threshold deglitch time	$V_{ENx} = 0\text{ V}$, when $V_{IN} - V_{OUTx} > V_{OL_OFF}$. Duration longer than t_{OL_OFF} , then open load is detected, off state		300	550	800	μs	9.11
I_{OL_OFF}	Off-state output sink current	$V_{ENx} = 0\text{ V}, V_{DIAG_EN} = 5\text{ V}, V_{IN} - V_{OUTx} = 24\text{ V}$, open load				100	μA	9.2, 9.3, 9.4, 9.5
V_{OL_FAULT}	Fault low-output voltage	$I_{FAULT} = 2\text{ mA}$				0.2	V	9.10

Table 3-1. TPS7H2140-SEP Data Sheet Electrical Parameters (continued)

Parameter		Test Conditions	MIN	TYP	MAX	UNIT	Tests
$t_{CL_DEGLITCH}$	Deglitch time when current limit occurs	ENx = DIAG_EN = 5 V The deglitch time from current limit event to FAULT = Low and V _{CS_FAULT}			220	μs	15.29
T _{SD}	Thermal shutdown threshold		160	175		°C	
T _{SD_RST}	Thermal shutdown status reset threshold			155			
T _{sw}	Thermal swing shutdown threshold			60			
T _{HYS}	Hysteresis for resetting the thermal shutdown or thermal swing			10			
CURRENT SENSE AND CURRENT LIMIT							
K _{CS}	Current sense ratio			300			10.25, 10.26, 10.27, 10.28, 10.29, 10.30, 10.31, 10.32, 10.33, 10.34, 10.35, 10.36, 10.37, 10.38, 10.39, 10.40, 10.41, 10.42, 10.43, 10.44, 10.45, 10.46, 10.47, 10.48
K _{CL}	Current limit ratio			2500			11.15, 11.16, 11.17, 11.18, 11.19, 11.20, 11.21, 11.22, 11.39, 11.40, 11.41, 11.42, 11.43, 11.44, 11.45, 11.46, 11.47, 11.48, 11.49, 11.50
V _{CL_TH}	Current limit internal threshold voltage			0.8		V	
dK _{CS} / K _{CS}	Current sense accuracy, $(I_{CS} \times K_{CS} - I_{OUT}) / I_{OUT} \times 100$	V _{IN} = 13.5 V, I _{OUTx} ≥ 5 mA	-65%		65%		10.1, 10.7, 10.13, 10.19
dK _{CS} / K _{CS}		V _{IN} = 13.5 V, I _{OUTx} ≥ 25 mA	-15%		15%		10.2, 10.8, 10.14, 10.20
dK _{CS} / K _{CS}		V _{IN} = 13.5 V, I _{OUTx} ≥ 50 mA	-8%		8%		10.3, 10.9, 10.15, 10.21
dK _{CS} / K _{CS}		V _{IN} = 13.5 V, I _{OUTx} ≥ 100 mA	-4%		4%		10.4, 10.10, 10.16, 10.22

Table 3-1. TPS7H2140-SEP Data Sheet Electrical Parameters (continued)

Parameter		Test Conditions	MIN	TYP	MAX	UNIT	Tests
dK _{CL} / K _{CL}	External current limit accuracy, $(I_{OUTx} - I_{CL} \times K_{CL}) \times 100 / (I_{CL} \times K_{CL})$	$V_{IN} = 13.5 \text{ V}, I_{LIMIT} \geq 250 \text{ mA}$	-20%		20%		11.1, 11.3, 11.5, 11.7
		$V_{IN} = 13.5 \text{ V}, 2 \text{ A} \leq I_{LIMIT} \leq 4 \text{ A}$	-15%		15%		11.23, 11.24, 11.25, 11.26, 11.27, 11.28, 11.29, 11.30, 11.31, 11.32, 11.33, 11.34
V _{CS_LINEAR}	Current-sense voltage linear range	$V_{IN} \geq 6.5 \text{ V}$	0		4	V	10.761
		$5 \text{ V} \leq V_{IN} < 6.5 \text{ V}$	0	$V_{IN} - 2.5$			10.791
I _{OUTx_LINEAR}	Output-current linear range	$V_{IN} \geq 6.5 \text{ V}, V_{CS_LINEAR} \leq 4 \text{ V}$	0		2.5	A	
		$5 \text{ V} \leq V_{IN} < 6.5 \text{ V}, V_{CS_LINEAR} \leq V_{IN} - 2.5 \text{ V}$	0		2.5		
V _{CS_FAULT}	Current sense pin output voltage	$V_{IN} \geq 7 \text{ V}, \text{FAULT mode}$	4.5		6.5	V	9.12
		$5 \text{ V} \leq V_{IN} < 7 \text{ V}, \text{FAULT mode}$	$\text{Min}(V_{IN} - 2.3, 4.5)$		6.5		
I _{CS_FAULT}	Current-sense pin output current available in fault mode	$V_{CS} = 4.5 \text{ V}, V_{IN} > 7 \text{ V}$	15			mA	9.13
I _{CS_LEAK}	Current-sense leakage current in disabled mode	$V_{DIAG_EN} = 0 \text{ V}$				$T_A = 125^\circ\text{C}$	0.5 μA

Table 3-2. TPS7H2140-SEP Data Sheet Electrical Parameters

PARAMETER		TEST CONDITIONS	MIN	TYP	MAX	UNIT	Test(s)
POWER STAGE							
t_{ON}	Turn-on delay time	$V_{IN} = 13.5\text{ V}$, $V_{DIAG_EN} = 5\text{ V}$, $I_{OUTX} = 500\text{ mA}$, from ENx rising edge to 10% of V_{OUTX}	20	50	90	μs	15.1, 15.8, 15.15, 15.22
t_{OFF}	Turn-off delay time	$V_{IN} = 13.5\text{ V}$, $V_{DIAG_EN} = 5\text{ V}$, $I_{OUTX} = 500\text{ mA}$, from ENx falling edge to 90% of V_{OUTX}	20	50	90		15.2, 15.9, 15.16, 15.23
t_{RISE}	Channel turn-on time	$V_{IN} = 13.5\text{ V}$, $V_{DIAG_EN} = 5\text{ V}$, $I_{OUTX} = 500\text{ mA}$, from 50% of ENx to 90% of V_{OUTX}	66	88	125		15.3, 15.10, 15.17, 15.24
t_{FALL}	Channel turn-off time	$V_{IN} = 13.5\text{ V}$, $V_{DIAG_EN} = 5\text{ V}$, $I_{OUTX} = 500\text{ mA}$, from 50% of ENx to 10% of V_{OUTX}	66	88	125		15.4, 15.11, 15.18, 15.25
t_{MATCH}	$t_{RISE} - t_{FALL}$	$V_{IN} = 13.5\text{ V}$, $I_{OUT} = 500\text{ mA}$. t_{RISE} is the ENx rising edge to $V_{OUTX} = 90\%$. t_{FALL} is the ENx falling edge to $V_{OUTX} = 10\%$.	-50		50		15.7, 15.14, 15.21, 15.28
SR_{ON}	Turn-on slew rate	$V_{IN} = 13.5\text{ V}$, $V_{DIAG_EN} = 5\text{ V}$, $I_{OUTX} = 500\text{ mA}$, from ENx rising edge to 10% of V_{OUTX}	0.1	0.3	0.55	$\text{V}/\mu\text{s}$	15.5, 15.12, 15.19, 15.26
SR_{OFF}	Turn-off slew rate	$V_{IN} = 13.5\text{ V}$, $V_{DIAG_EN} = 5\text{ V}$, $I_{OUTX} = 500\text{ mA}$, from ENx falling edge to 90% of V_{OUTX}	0.1	0.3	0.55		15.6, 15.13, 15.20, 15.27
CURRENT SENSE							
t_{CS_OFF1}	CS settling time from DIAG_EN disabled	$V_{IN} = 13.5\text{ V}$, $V_{ENX} = 5\text{ V}$, $I_{OUTX} = 500\text{ mA}$. Current Limit = 2 A. From V_{DIAG_EN} falling edge to 10% of V_{CS} .			20	μs	16.1
t_{CS_ON1}	CS settling time from DIAG_EN enabled	$V_{IN} = 13.5\text{ V}$, $V_{ENX} = 5\text{ V}$, $I_{OUTX} = 500\text{ mA}$. Current Limit = 2 A. From V_{DIAG_EN} rising edge to 90% of V_{CS} .			20		16.2
t_{CS_OFF2}	CS settling time from IN falling edge	$V_{IN} = 13.5\text{ V}$, $V_{ENX} = 5\text{ V}$, $I_{OUTX} = 500\text{ mA}$. Current Limit = 2 A. From V_{ENX} falling edge to 10% of V_{CS} .	30		100		16.3
t_{CS_ON2}	CS settling time from IN rising edge	$V_{IN} = 13.5\text{ V}$, $V_{ENX} = 5\text{ V}$, $I_{OUTX} = 500\text{ mA}$. Current Limit = 2 A. From V_{ENX} rising edge to 90% of V_{CS} .	50		150		16.4
t_{MUX}	Multi-sense transition delay from channel to channel	$V_{DIAG_EN} = 5\text{ V}$, current sense output delay when multi-sense pins SEL and SEH transition from channel to channel			50		16.5

4 Applicable and Reference Documents

4.1 Applicable Documents

- Texas Instruments, [TPS7H2140-SEP Radiation-Tolerant 32-V, 160-mΩ Quad-Channel eFuse in Space Enhanced Plastic](#), data sheet.
- Texas Instruments, [TPS7H2140-SEP Single-Event Effects](#), radiation report.
- Texas Instruments, [TPS7H2140-SEP Evaluation Module \(EVM\)](#), EVM user's guide.

4.2 Reference Documents

Texas Instruments total ionizing dose radiation (total dose) test procedure follows the standards put forth in MIL-STD-883 TM 1019. The document can be found at the DLA website.

A Appendix: HDR TID Report

This appendix contains the HDR TID report data.

Device Test: 5.10 UJKFAE(IQ_12V_UJKFAE)

TID vs Result Stats

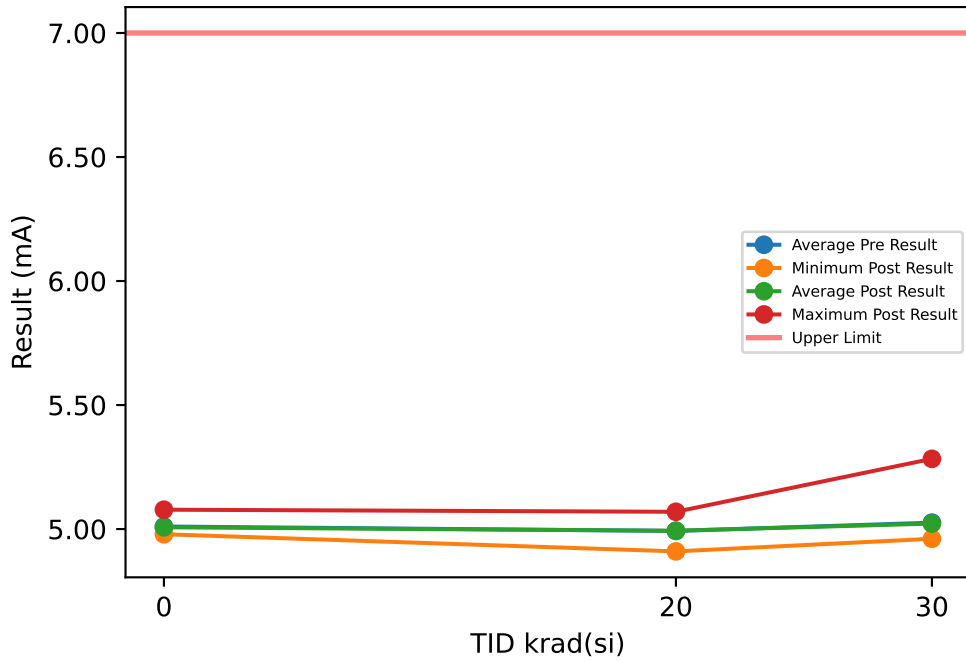

Test Results (Upper Limit = 7.0 (mA))

Serial #	krad(si)	Exposure Conditions	Pre Result	Post Result	Delta
1	20	HDR unbiased	5.0293	5.0218	-0.0075
2	20	HDR unbiased	5.0287	5.005	-0.0237
3	20	HDR unbiased	5.0054	5.0086	0.0032
4	20	HDR unbiased	5.0472	5.0365	-0.0107
5	20	HDR unbiased	5.0779	5.0696	-0.0083
6	20	HDR biased	5.0145	4.9099	-0.1046
7	20	HDR biased	4.932	4.9513	0.0193
8	20	HDR biased	4.9345	4.9559	0.0214
9	20	HDR biased	4.9554	4.9528	-0.0026
10	20	HDR biased	4.8996	5.0196	0.12
11	30	HDR unbiased	5.3061	5.283	-0.0231
12	30	HDR unbiased	4.9671	4.9608	-0.0063
13	30	HDR unbiased	4.9845	4.9678	-0.0167
14	30	HDR unbiased	4.9497	4.9773	0.0276
15	30	HDR unbiased	5.0338	5.0081	-0.0257
16	30	HDR biased	5.0109	5.021	0.0101
17	30	HDR biased	4.964	4.975	0.011
18	30	HDR biased	5.0576	5.0239	-0.0337
19	30	HDR biased	4.9848	4.9734	-0.0114
20	30	HDR biased	4.9995	5.0295	0.03
21	0	correlation	4.9978	4.9949	-0.0029
22	0	correlation	4.9949	4.9922	-0.0027
23	0	correlation	4.985	4.9791	-0.0059
24	0	correlation	5.0815	5.078	-0.0035
25	0	correlation	4.9925	4.991	-0.0015

TID vs Post - Pre Exposure Delta

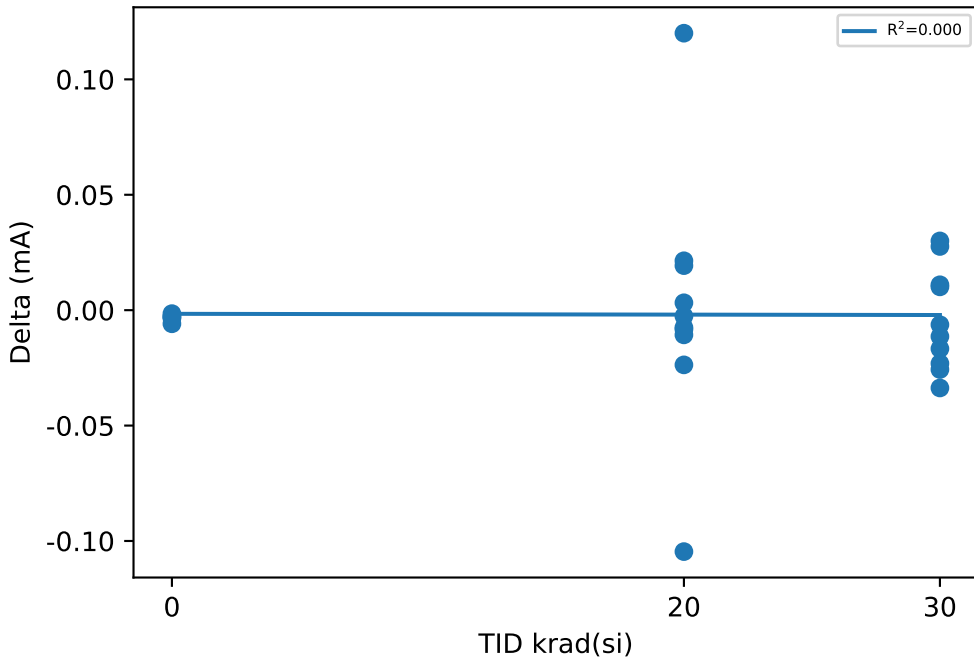

Test Statistics (mA)

krad(si)	Pre Exposure Min	Pre Exposure Avg	Pre Exposure Max	Pre Exposure Std	Post Exposure Min	Post Exposure Avg	Post Exposure Max	Post Exposure Std	Min Delta	Avg Delta	Max Delta	Std Delta
0	4.985	5.0103	5.0815	0.040062	4.9791	5.007	5.078	0.040127	-0.0059	-0.0033	-0.0015	0.0016248
20	4.8996	4.9924	5.0779	0.058339	4.9099	4.9931	5.0696	0.048672	-0.1046	0.00065	0.12	0.054758
30	4.9497	5.0258	5.3061	0.10382	4.9608	5.022	5.283	0.095235	-0.0337	-0.00382	0.03	0.022403

Device Test: 5.1 UJTKLS(Iop_5V_UJTKLS)

TID vs Result Stats

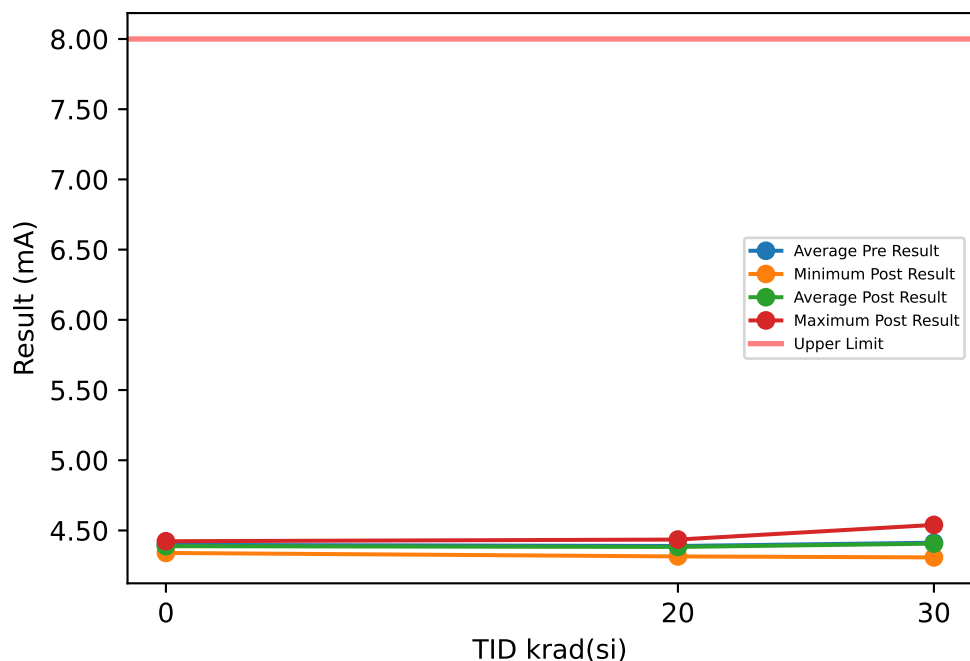

Test Results (Upper Limit = 8.0 (mA))

Serial #	krad(si)	Exposure Conditions	Pre Result	Post Result	Delta
1	20	HDR unbiased	4.4394	4.4352	-0.0042
2	20	HDR unbiased	4.3944	4.382	-0.0124
3	20	HDR unbiased	4.4008	4.3939	-0.0069
4	20	HDR unbiased	4.3845	4.3707	-0.0138
5	20	HDR unbiased	4.446	4.4325	-0.0135
6	20	HDR biased	4.4145	4.315	-0.0995
7	20	HDR biased	4.3817	4.3773	-0.0044
8	20	HDR biased	4.3738	4.3789	0.0051
9	20	HDR biased	4.3309	4.3314	0.0005
10	20	HDR biased	4.329	4.4101	0.0811
11	30	HDR unbiased	4.5559	4.5395	-0.0164
12	30	HDR unbiased	4.3251	4.3082	-0.0169
13	30	HDR unbiased	4.4096	4.3962	-0.0134
14	30	HDR unbiased	4.3825	4.3538	-0.0287
15	30	HDR unbiased	4.4653	4.4602	-0.0051
16	30	HDR biased	4.4295	4.4259	-0.0036
17	30	HDR biased	4.3755	4.3715	-0.004
18	30	HDR biased	4.4261	4.4227	-0.0034
19	30	HDR biased	4.363	4.383	0.02
20	30	HDR biased	4.3956	4.4009	0.0053
21	0	correlation	4.3769	4.3694	-0.0075
22	0	correlation	4.4337	4.4233	-0.0104
23	0	correlation	4.394	4.3842	-0.0098
24	0	correlation	4.4326	4.4231	-0.0095
25	0	correlation	4.35	4.3399	-0.0101

TID vs Post - Pre Exposure Delta

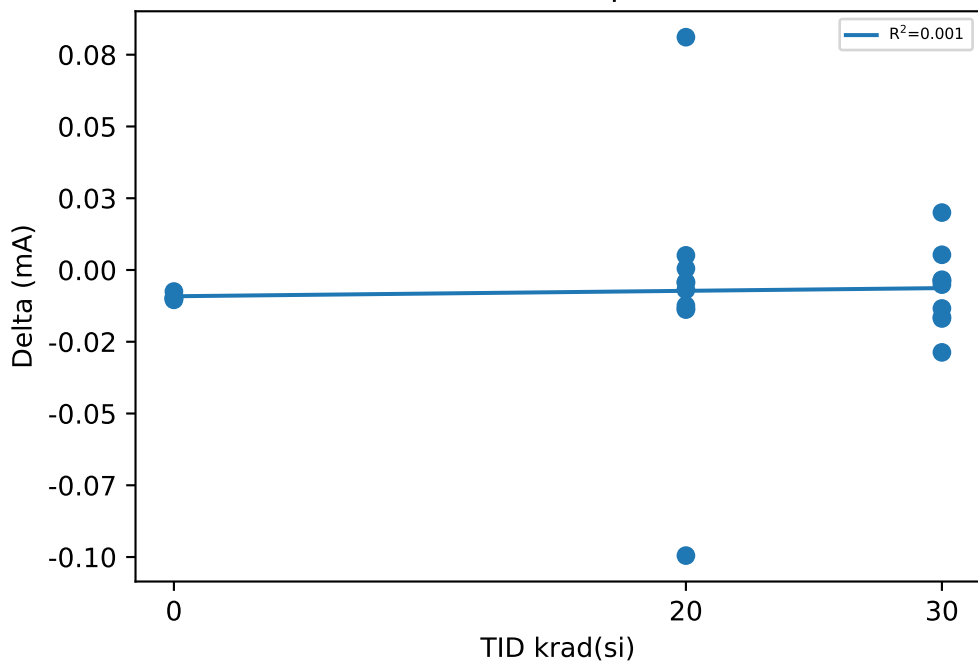

Test Statistics (mA)

krad(si)	Pre Exposure Min	Pre Exposure Avg	Pre Exposure Max	Pre Exposure Std	Post Exposure Min	Post Exposure Avg	Post Exposure Max	Post Exposure Std	Min Delta	Avg Delta	Max Delta	Std Delta
0	4.35	4.3974	4.4337	0.036178	4.3399	4.388	4.4233	0.035889	-0.0104	-0.00946	-0.0075	0.0011459
20	4.329	4.3895	4.446	0.039279	4.315	4.3827	4.4352	0.038752	-0.0995	-0.0068	0.0811	0.043015
30	4.3251	4.4128	4.5559	0.063663	4.3082	4.4062	4.5395	0.062863	-0.0287	-0.00662	0.02	0.013392

Device Test: 5.11 UJKFAE(IQ_28V_UJKFAE)

TID vs Result Stats

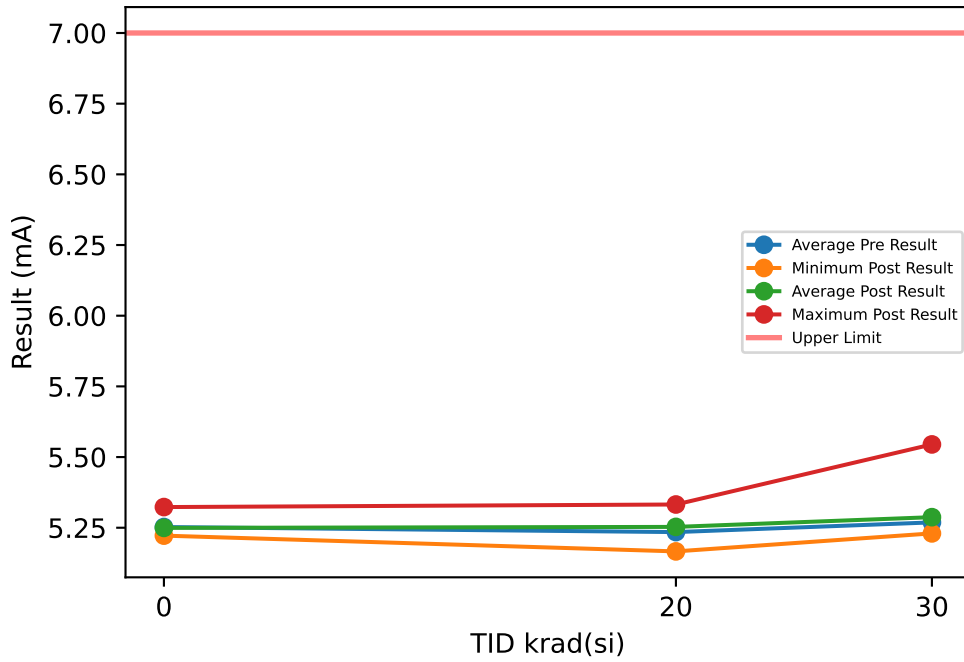

TID vs Post - Pre Exposure Delta

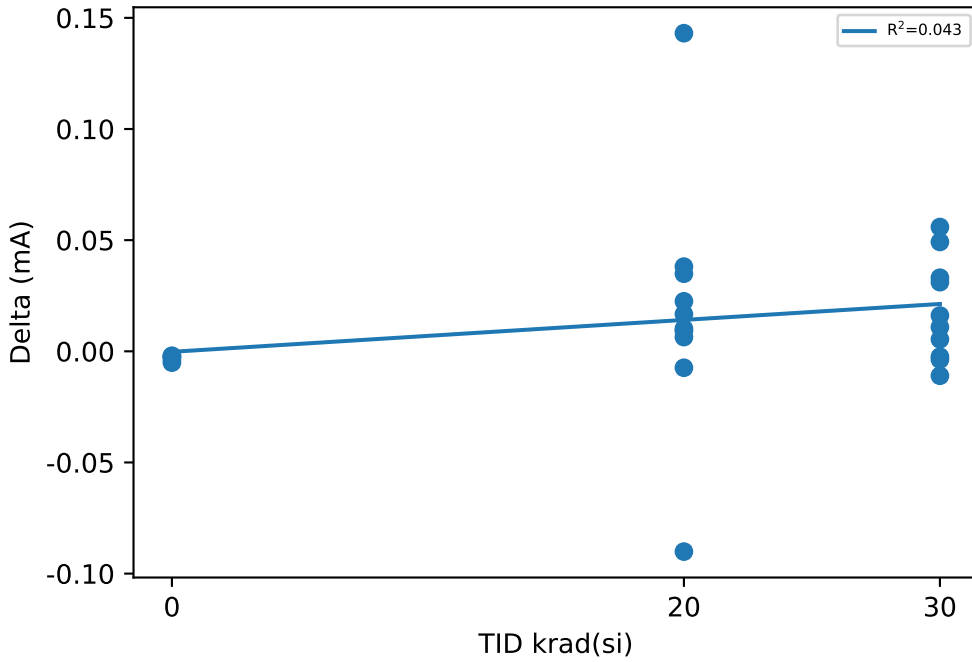

Test Results (Upper Limit = 7.0 (mA))

Serial #	krad(si)	Exposure Conditions	Pre Result	Post Result	Delta
1	20	HDR unbiased	5.272	5.2822	0.0102
2	20	HDR unbiased	5.2715	5.2641	-0.0074
3	20	HDR unbiased	5.2435	5.266	0.0225
4	20	HDR unbiased	5.29	5.2964	0.0064
5	20	HDR unbiased	5.323	5.3322	0.0092
6	20	HDR biased	5.2564	5.1663	-0.0901
7	20	HDR biased	5.1758	5.2107	0.0349
8	20	HDR biased	5.1774	5.2155	0.0381
9	20	HDR biased	5.1997	5.2164	0.0167
10	20	HDR biased	5.1367	5.2798	0.1431
11	30	HDR unbiased	5.5484	5.5447	-0.0037
12	30	HDR unbiased	5.214	5.2301	0.0161
13	30	HDR unbiased	5.2246	5.23	0.0054
14	30	HDR unbiased	5.1956	5.2448	0.0492
15	30	HDR unbiased	5.2759	5.2735	-0.0024
16	30	HDR biased	5.2524	5.2835	0.0311
17	30	HDR biased	5.2031	5.2362	0.0331
18	30	HDR biased	5.3041	5.2931	-0.011
19	30	HDR biased	5.2284	5.2393	0.0109
20	30	HDR biased	5.2425	5.2984	0.0559
21	0	correlation	5.2398	5.2376	-0.0022
22	0	correlation	5.2363	5.2339	-0.0024
23	0	correlation	5.2272	5.2221	-0.0051
24	0	correlation	5.3267	5.3231	-0.0036
25	0	correlation	5.2326	5.2306	-0.002

Test Statistics (mA)

krad(si)	Pre Exposure Min	Pre Exposure Avg	Pre Exposure Max	Pre Exposure Std	Post Exposure Min	Post Exposure Avg	Post Exposure Max	Post Exposure Std	Min Delta	Avg Delta	Max Delta	Std Delta
0	5.2272	5.2525	5.3267	0.04173	5.2221	5.2495	5.3231	0.041563	-0.0051	-0.00306	-0.002	0.0012992
20	5.1367	5.2346	5.323	0.059377	5.1663	5.253	5.3322	0.049521	-0.0901	0.01836	0.1431	0.056729
30	5.1956	5.2689	5.5484	0.10365	5.23	5.2874	5.5447	0.094218	-0.011	0.01846	0.0559	0.022969

Device Test: 5.12 UJKFAE(IQ_32V_UJKFAE)

TID vs Result Stats

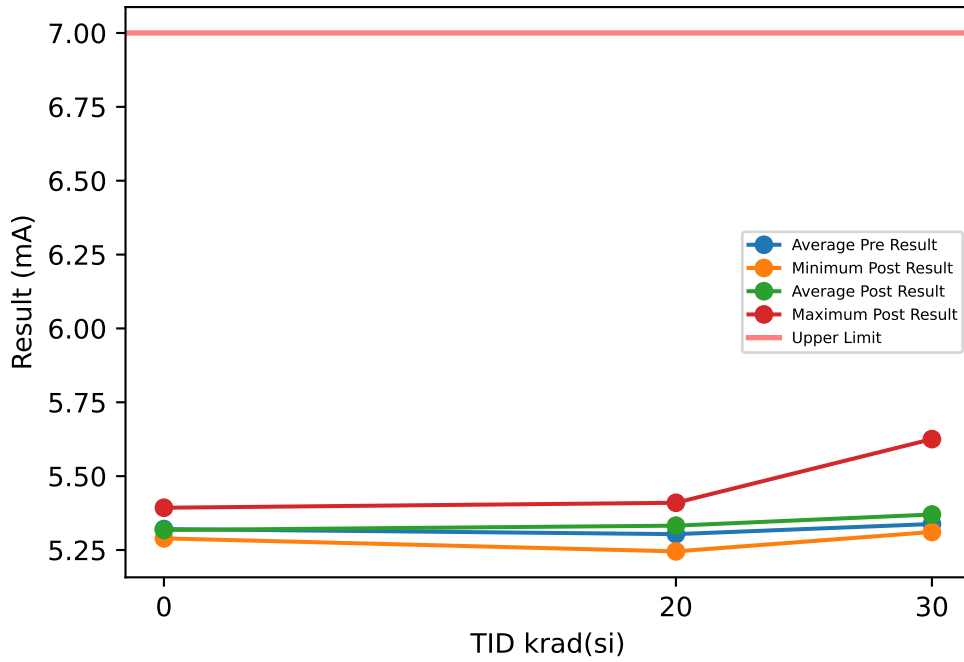

TID vs Post - Pre Exposure Delta

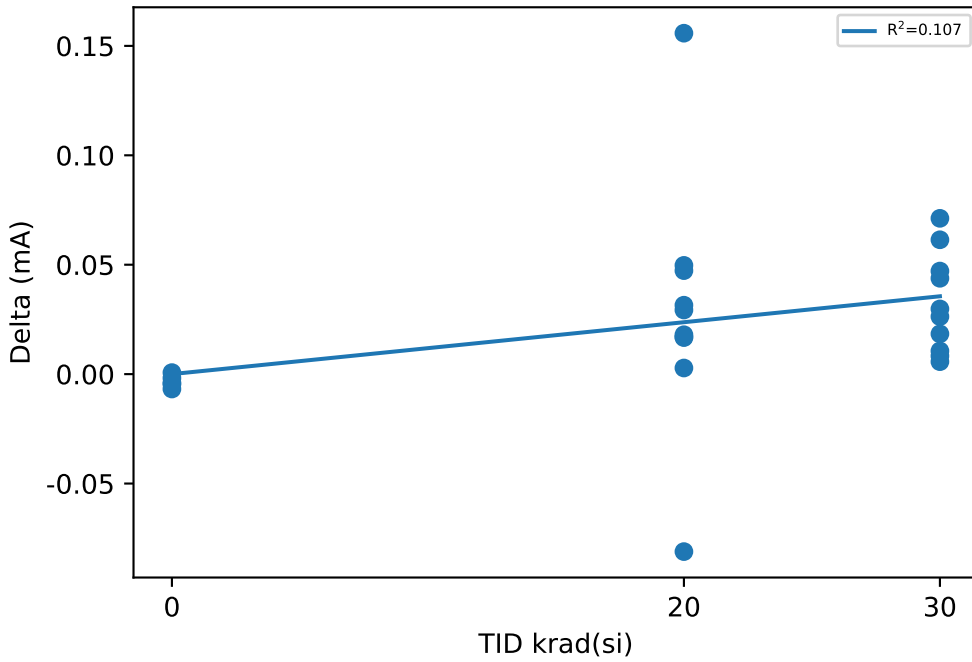

Test Results (Upper Limit = 7.0 (mA))

Serial #	krad(si)	Exposure Conditions	Pre Result	Post Result	Delta
1	20	HDR unbiased	5.3413	5.3593	0.018
2	20	HDR unbiased	5.34	5.3428	0.0028
3	20	HDR unbiased	5.3114	5.3429	0.0315
4	20	HDR unbiased	5.3583	5.3753	0.017
5	20	HDR unbiased	5.3932	5.4099	0.0167
6	20	HDR biased	5.3264	5.2453	-0.0811
7	20	HDR biased	5.245	5.2923	0.0473
8	20	HDR biased	5.249	5.2987	0.0497
9	20	HDR biased	5.269	5.2983	0.0293
10	20	HDR biased	5.2035	5.3593	0.1558
11	30	HDR unbiased	5.6148	5.6254	0.0106
12	30	HDR unbiased	5.285	5.3148	0.0298
13	30	HDR unbiased	5.2925	5.3109	0.0184
14	30	HDR unbiased	5.2665	5.3279	0.0614
15	30	HDR unbiased	5.3464	5.3547	0.0083
16	30	HDR biased	5.3217	5.3655	0.0438
17	30	HDR biased	5.2706	5.3177	0.0471
18	30	HDR biased	5.3733	5.379	0.0057
19	30	HDR biased	5.2983	5.3246	0.0263
20	30	HDR biased	5.3106	5.3818	0.0712
21	0	correlation	5.3059	5.3041	-0.0018
22	0	correlation	5.3062	5.3016	-0.0046
23	0	correlation	5.2962	5.2894	-0.0068
24	0	correlation	5.3971	5.3931	-0.004
25	0	correlation	5.2991	5.2998	0.0007

Test Statistics (mA)

krad(si)	Pre Exposure Min	Pre Exposure Avg	Pre Exposure Max	Pre Exposure Std	Post Exposure Min	Post Exposure Avg	Post Exposure Max	Post Exposure Std	Min Delta	Avg Delta	Max Delta	Std Delta
0	5.2962	5.3209	5.3971	0.042816	5.2894	5.3176	5.3931	0.042575	-0.0068	-0.0033	0.0007	0.0028583
20	5.2035	5.3037	5.3932	0.059609	5.2453	5.3324	5.4099	0.048311	-0.0811	0.0287	0.1558	0.057804
30	5.2665	5.338	5.6148	0.10277	5.3109	5.3702	5.6254	0.093578	0.0057	0.03226	0.0712	0.022855

Device Test: 5.13 UJSQ47(ISD_5V_UJSQ47)

TID vs Result Stats

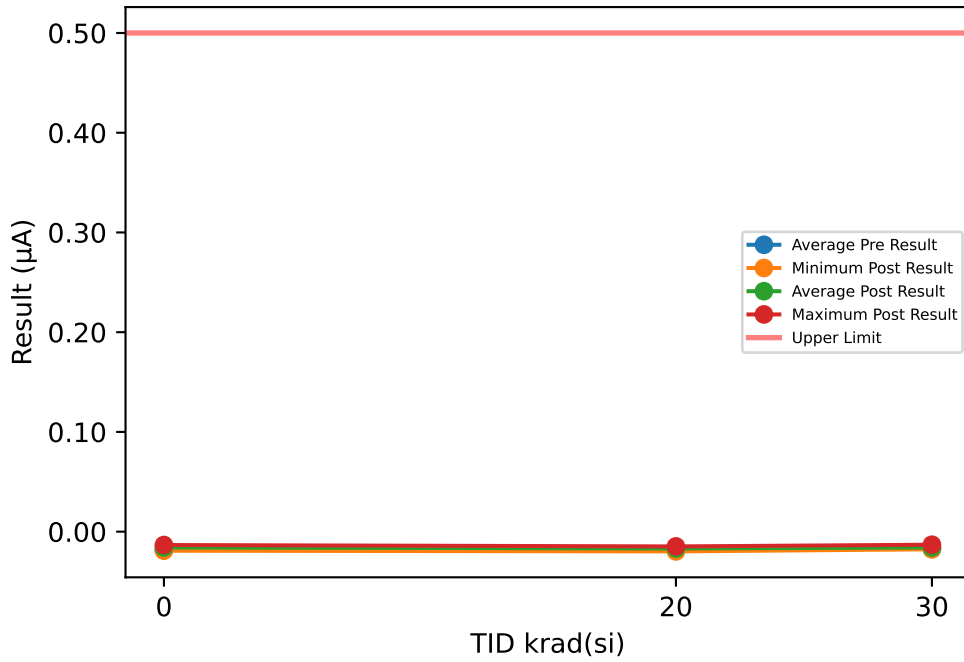

TID vs Post - Pre Exposure Delta

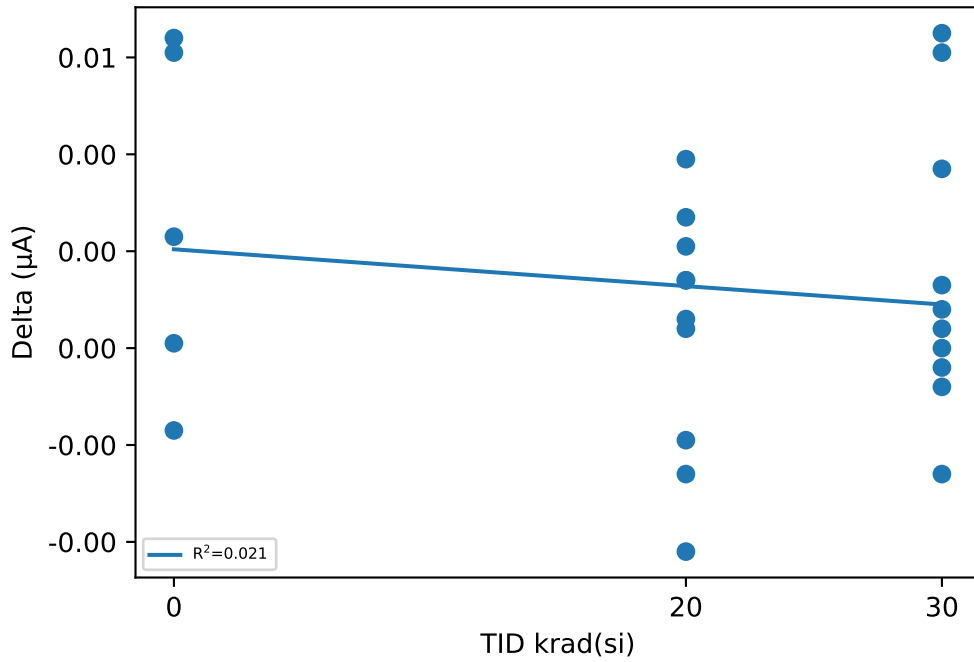

Test Results (Upper Limit = 0.5 (µA))

Serial #	krad(si)	Exposure Conditions	Pre Result	Post Result	Delta
1	20	HDR unbiased	-0.0143	-0.0169	-0.0026
2	20	HDR unbiased	-0.0178	-0.0174	0.0004
3	20	HDR unbiased	-0.0181	-0.016	0.0021
4	20	HDR unbiased	-0.0185	-0.0158	0.0027
5	20	HDR unbiased	-0.0187	-0.0148	0.0039
6	20	HDR biased	-0.0138	-0.018	-0.0042
7	20	HDR biased	-0.0137	-0.0156	-0.0019
8	20	HDR biased	-0.0174	-0.016	0.0014
9	20	HDR biased	-0.0212	-0.0198	0.0014
10	20	HDR biased	-0.0194	-0.0188	0.0006
11	30	HDR unbiased	-0.0152	-0.0156	-0.0004
12	30	HDR unbiased	-0.0144	-0.0131	0.0013
13	30	HDR unbiased	-0.02	-0.0163	0.0037
14	30	HDR unbiased	-0.0176	-0.0176	0
15	30	HDR unbiased	-0.0219	-0.0158	0.0061
16	30	HDR biased	-0.0136	-0.0144	-0.0008
17	30	HDR biased	-0.0185	-0.0177	0.0008
18	30	HDR biased	-0.0149	-0.0175	-0.0026
19	30	HDR biased	-0.0219	-0.0154	0.0065
20	30	HDR biased	-0.0158	-0.0154	0.0004
21	0	correlation	-0.0157	-0.0134	0.0023
22	0	correlation	-0.0174	-0.0191	-0.0017
23	0	correlation	-0.023	-0.0169	0.0061
24	0	correlation	-0.0147	-0.0146	0.0001
25	0	correlation	-0.0218	-0.0154	0.0064

Test Statistics (µA)

krad(si)	Pre Exposure Min	Pre Exposure Avg	Pre Exposure Max	Pre Exposure Std	Post Exposure Min	Post Exposure Avg	Post Exposure Max	Post Exposure Std	Min Delta	Avg Delta	Max Delta	Std Delta
0	-0.023	-0.01852	-0.0147	0.0036955	-0.0191	-0.01588	-0.0134	0.0022039	-0.0017	0.00264	0.0064	0.0035886
20	-0.0212	-0.01729	-0.0137	0.0025414	-0.0198	-0.01691	-0.0148	0.0015779	-0.0042	0.00038	0.0039	0.0025368
30	-0.0219	-0.01738	-0.0136	0.0030839	-0.0177	-0.01588	-0.0131	0.0014733	-0.0026	0.0015	0.0065	0.0029944

Device Test: 5.14 UJSQ47(ISD_12V_UJSQ47)

TID vs Result Stats

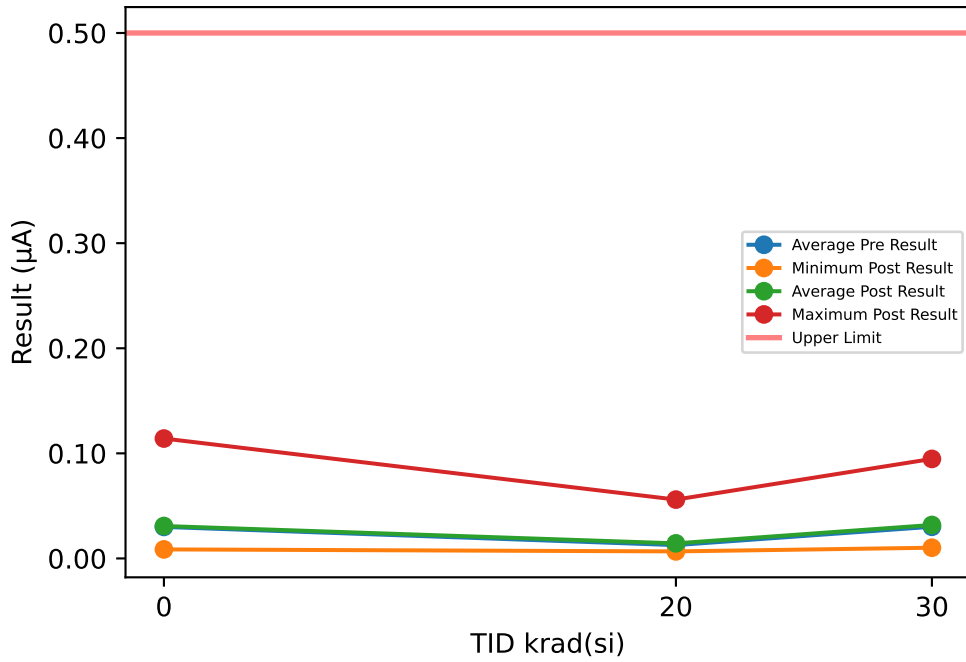

Test Results (Upper Limit = 0.5 (µA))

Serial #	krad(si)	Exposure Conditions	Pre Result	Post Result	Delta
1	20	HDR unbiased	0.0106	0.011	0.0004
2	20	HDR unbiased	0.0517	0.056	0.0043
3	20	HDR unbiased	0.0096	0.0114	0.0018
4	20	HDR unbiased	0.0088	0.0092	0.0004
5	20	HDR unbiased	0.0069	0.0067	-0.0002
6	20	HDR biased	0.0091	0.0084	-0.0007
7	20	HDR biased	0.0098	0.0084	-0.0014
8	20	HDR biased	0.0064	0.0106	0.0042
9	20	HDR biased	0.0054	0.0093	0.0039
10	20	HDR biased	0.0086	0.0125	0.0039
11	30	HDR unbiased	0.0706	0.0639	-0.0067
12	30	HDR unbiased	0.0928	0.0947	0.0019
13	30	HDR unbiased	0.0061	0.0105	0.0044
14	30	HDR unbiased	0.0097	0.0361	0.0264
15	30	HDR unbiased	0.0094	0.0122	0.0028
16	30	HDR biased	0.0594	0.0543	-0.0051
17	30	HDR biased	0.0089	0.0127	0.0038
18	30	HDR biased	0.0066	0.0116	0.005
19	30	HDR biased	0.0327	0.0122	-0.0205
20	30	HDR biased	0.005	0.0102	0.0052
21	0	correlation	0.1164	0.1141	-0.0023
22	0	correlation	0.0063	0.0096	0.0033
23	0	correlation	0.0069	0.0103	0.0034
24	0	correlation	0.0095	0.0117	0.0022
25	0	correlation	0.0108	0.0086	-0.0022

TID vs Post - Pre Exposure Delta

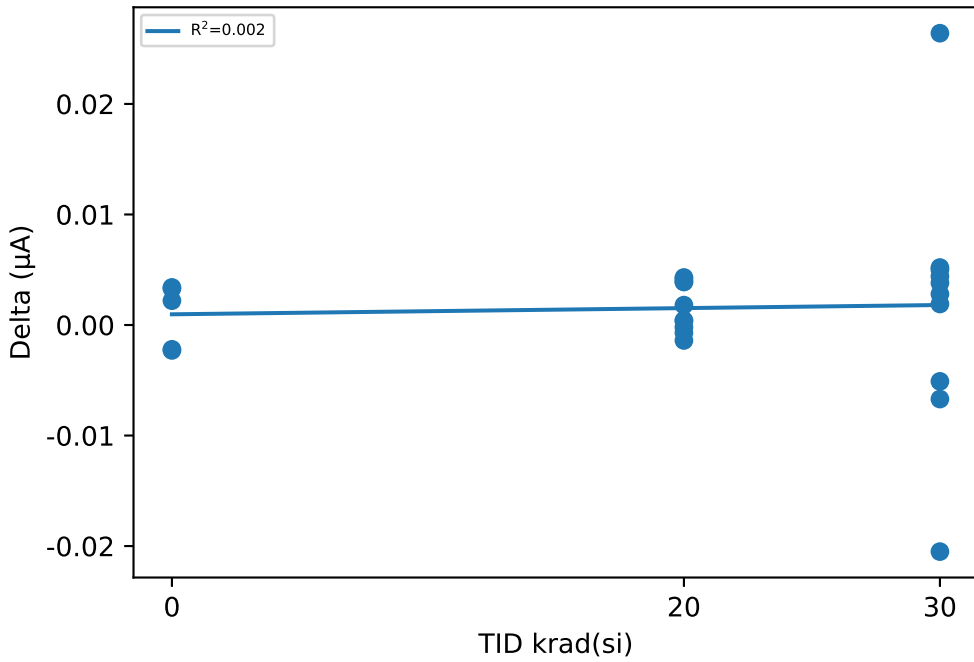

Test Statistics (µA)

krad(si)	Pre Exposure Min	Pre Exposure Avg	Pre Exposure Max	Pre Exposure Std	Post Exposure Min	Post Exposure Avg	Post Exposure Max	Post Exposure Std	Min Delta	Avg Delta	Max Delta	Std Delta
0	0.0063	0.02998	0.1164	0.048345	0.0086	0.03086	0.1141	0.046546	-0.0023	0.00088	0.0034	0.002896
20	0.0054	0.01269	0.0517	0.013804	0.0067	0.01435	0.056	0.014733	-0.0014	0.00166	0.0043	0.0022372
30	0.005	0.03012	0.0928	0.032471	0.0102	0.03184	0.0947	0.029764	-0.0205	0.00172	0.0264	0.011812

Device Test: 5.15 UJSQ47(ISD_28V_UJSQ47)

TID vs Result Stats

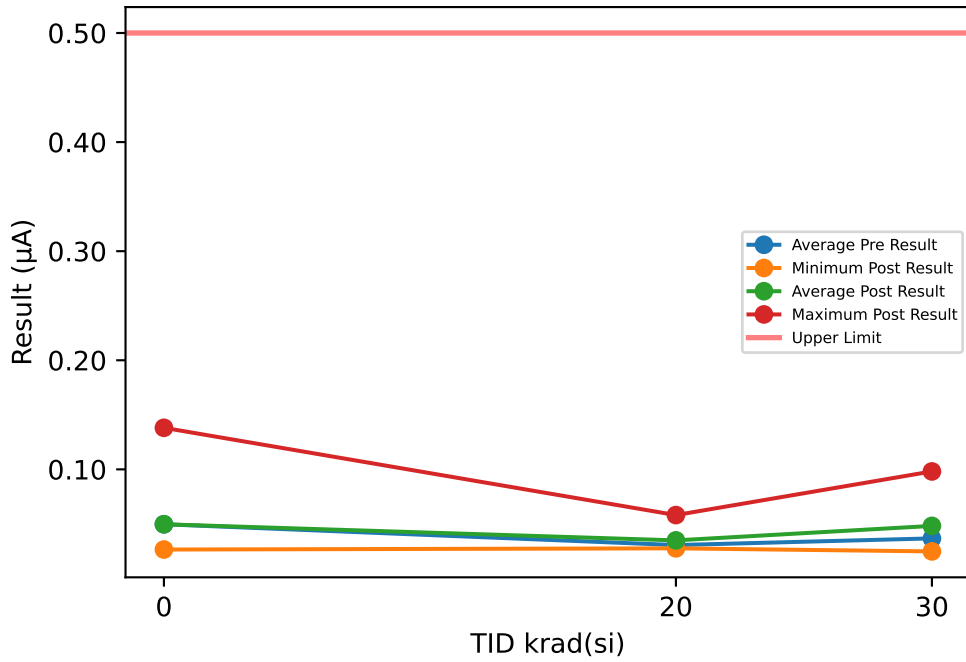

Test Results (Upper Limit = 0.5 (µA))

Serial #	krad(si)	Exposure Conditions	Pre Result	Post Result	Delta
1	20	HDR unbiased	0.032	0.0292	-0.0028
2	20	HDR unbiased	0.0507	0.0581	0.0074
3	20	HDR unbiased	0.0262	0.0278	0.0016
4	20	HDR unbiased	0.0272	0.0291	0.0019
5	20	HDR unbiased	0.0309	0.0276	-0.0033
6	20	HDR biased	0.0286	0.0368	0.0082
7	20	HDR biased	0.0286	0.0366	0.008
8	20	HDR biased	0.0276	0.0362	0.0086
9	20	HDR biased	0.0278	0.0333	0.0055
10	20	HDR biased	0.0264	0.0342	0.0078
11	30	HDR unbiased	0.0678	0.0702	0.0024
12	30	HDR unbiased	0.0725	0.0981	0.0256
13	30	HDR unbiased	0.0244	0.0248	0.0004
14	30	HDR unbiased	0.0251	0.0314	0.0063
15	30	HDR unbiased	0.0258	0.0285	0.0027
16	30	HDR biased	0.041	0.0661	0.0251
17	30	HDR biased	0.0276	0.0406	0.013
18	30	HDR biased	0.0295	0.0455	0.016
19	30	HDR biased	0.0256	0.0364	0.0108
20	30	HDR biased	0.0279	0.0401	0.0122
21	0	correlation	0.143	0.1381	-0.0049
22	0	correlation	0.0279	0.0267	-0.0012
23	0	correlation	0.026	0.0288	0.0028
24	0	correlation	0.0268	0.0265	-0.0003
25	0	correlation	0.0247	0.0283	0.0036

TID vs Post - Pre Exposure Delta

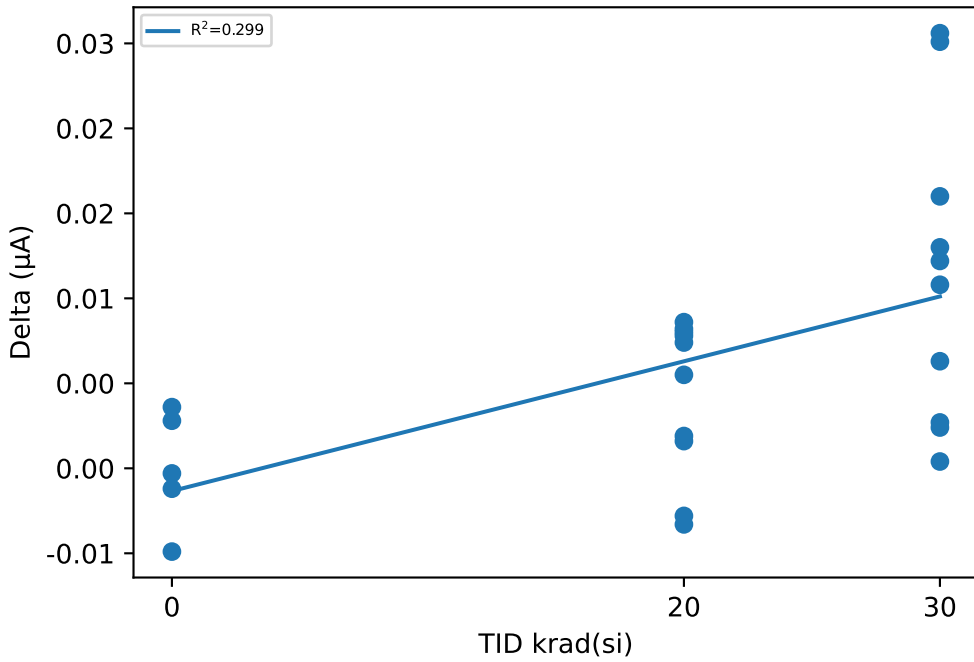

Test Statistics (µA)

krad(si)	Pre Exposure Min	Pre Exposure Avg	Pre Exposure Max	Pre Exposure Std	Post Exposure Min	Post Exposure Avg	Post Exposure Max	Post Exposure Std	Min Delta	Avg Delta	Max Delta	Std Delta
0	0.0247	0.04968	0.143	0.052181	0.0265	0.04968	0.1381	0.049438	-0.0049	2.7756e-18	0.0036	0.0034037
20	0.0262	0.0306	0.0507	0.0072989	0.0276	0.03489	0.0581	0.00894	-0.0033	0.00429	0.0086	0.0046177
30	0.0244	0.03672	0.0725	0.01828	0.0248	0.04817	0.0981	0.023051	0.0004	0.01145	0.0256	0.0089301

Device Test: 5.16 UJSQ47(ISD_32V_UJSQ47)

TID vs Result Stats

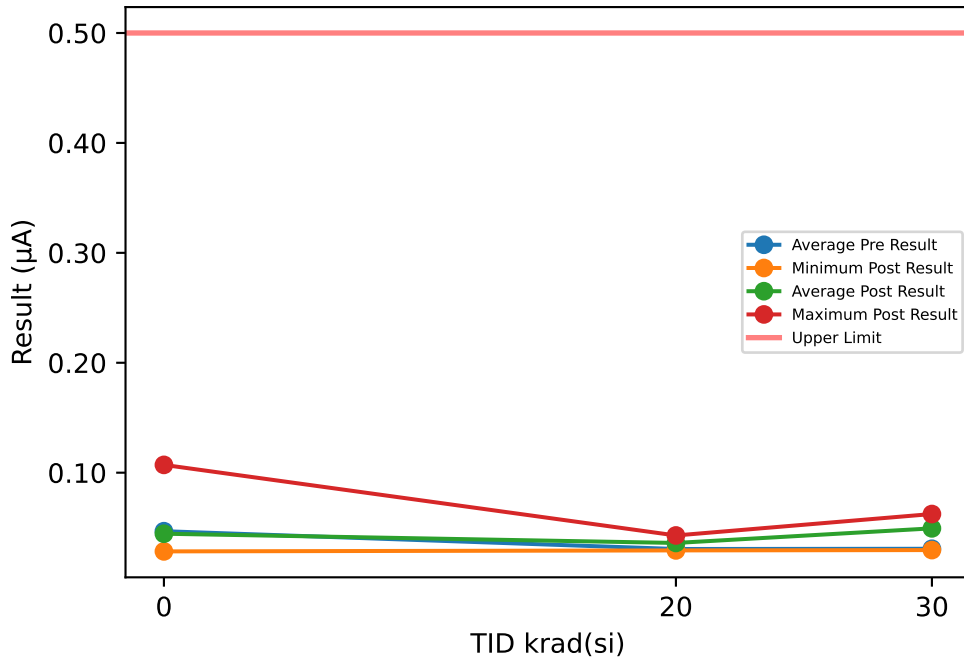

Test Results (Upper Limit = 0.5 (µA))

Serial #	krad(si)	Exposure Conditions	Pre Result	Post Result	Delta
1	20	HDR unbiased	0.0327	0.0303	-0.0024
2	20	HDR unbiased	0.0336	0.0383	0.0047
3	20	HDR unbiased	0.0282	0.0293	0.0011
4	20	HDR unbiased	0.0302	0.0295	-0.0007
5	20	HDR unbiased	0.033	0.0309	-0.0021
6	20	HDR biased	0.0317	0.0406	0.0089
7	20	HDR biased	0.031	0.0413	0.0103
8	20	HDR biased	0.0295	0.0429	0.0134
9	20	HDR biased	0.0293	0.0415	0.0122
10	20	HDR biased	0.0266	0.0362	0.0096
11	30	HDR unbiased	0.0423	0.0484	0.0061
12	30	HDR unbiased	0.036	0.0614	0.0254
13	30	HDR unbiased	0.0266	0.0301	0.0035
14	30	HDR unbiased	0.0285	0.0296	0.0011
15	30	HDR unbiased	0.025	0.0321	0.0071
16	30	HDR biased	0.0311	0.0621	0.031
17	30	HDR biased	0.0293	0.0566	0.0273
18	30	HDR biased	0.0296	0.0624	0.0328
19	30	HDR biased	0.0289	0.0516	0.0227
20	30	HDR biased	0.0306	0.0593	0.0287
21	0	correlation	0.1156	0.1071	-0.0085
22	0	correlation	0.0318	0.0289	-0.0029
23	0	correlation	0.0262	0.0295	0.0033
24	0	correlation	0.0328	0.0285	-0.0043
25	0	correlation	0.0275	0.0284	0.0009

TID vs Post - Pre Exposure Delta

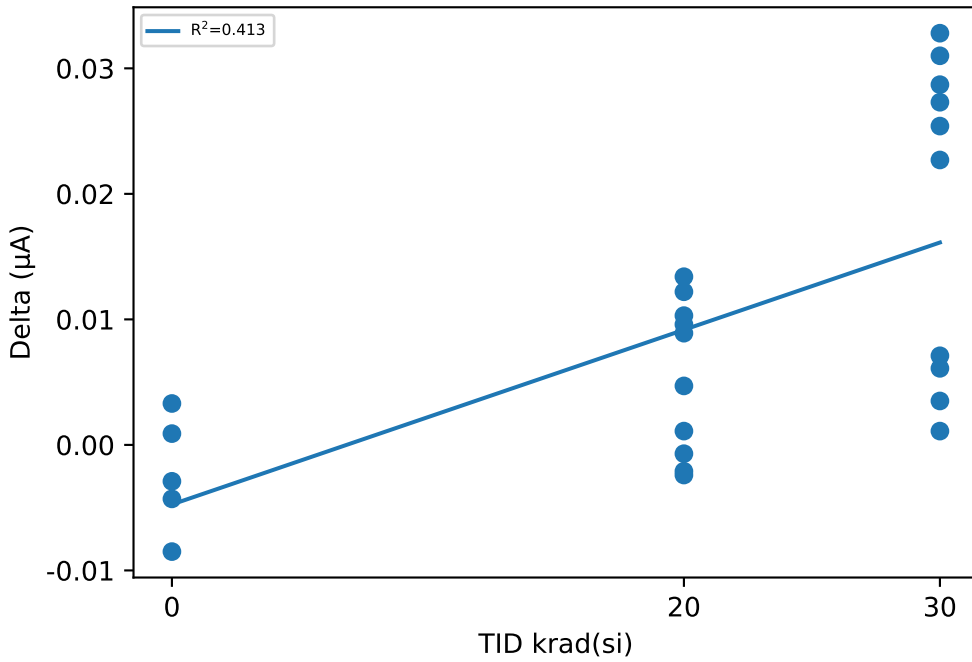

Test Statistics (µA)

krad(si)	Pre Exposure Min	Pre Exposure Avg	Pre Exposure Max	Pre Exposure Std	Post Exposure Min	Post Exposure Avg	Post Exposure Max	Post Exposure Std	Min Delta	Avg Delta	Max Delta	Std Delta
0	0.0262	0.04678	0.1156	0.038572	0.0284	0.04448	0.1071	0.035008	-0.0085	-0.0023	0.0033	0.0045935
20	0.0266	0.03058	0.0336	0.0022449	0.0293	0.03608	0.0429	0.0055579	-0.0024	0.0055	0.0134	0.0061221
30	0.025	0.03079	0.0423	0.004981	0.0296	0.04936	0.0624	0.013719	0.0011	0.01857	0.0328	0.012556

Device Test: 5.17 UJ4UM7(ISD_Diag_5V_UJ4UM7)

TID vs Result Stats

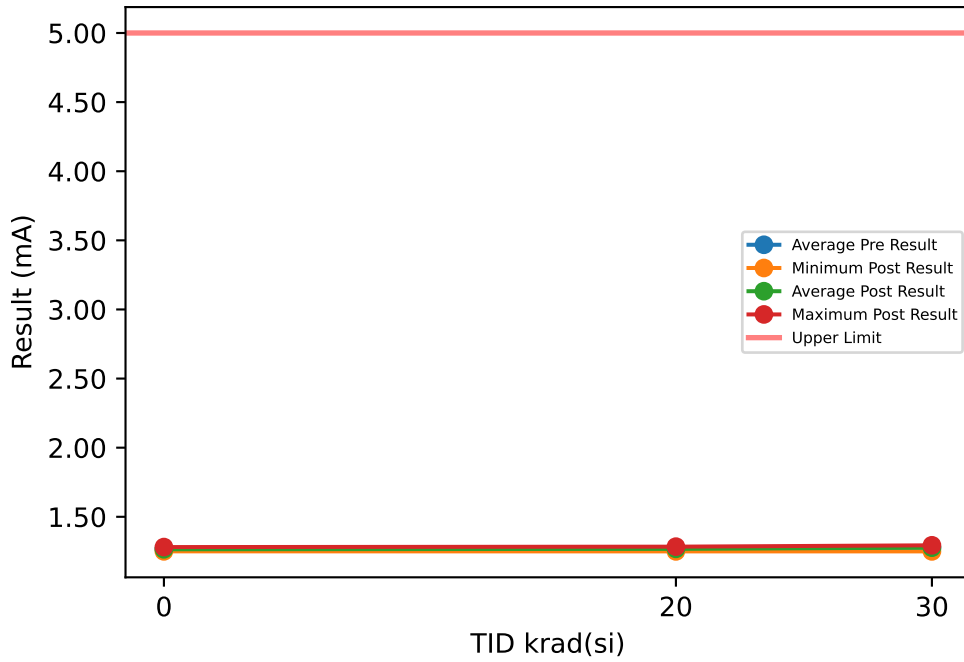

Test Results (Upper Limit = 5.0 (mA))

Serial #	krad(si)	Exposure Conditions	Pre Result	Post Result	Delta
1	20	HDR unbiased	1.2863	1.284	-0.0023
2	20	HDR unbiased	1.2729	1.2689	-0.004
3	20	HDR unbiased	1.2706	1.2687	-0.0019
4	20	HDR unbiased	1.2643	1.2605	-0.0038
5	20	HDR unbiased	1.2823	1.2795	-0.0028
6	20	HDR biased	1.2707	1.2497	-0.021
7	20	HDR biased	1.2702	1.2727	0.0025
8	20	HDR biased	1.2638	1.2672	0.0034
9	20	HDR biased	1.2561	1.2583	0.0022
10	20	HDR biased	1.2511	1.2707	0.0196
11	30	HDR unbiased	1.2955	1.2907	-0.0048
12	30	HDR unbiased	1.2559	1.2497	-0.0062
13	30	HDR unbiased	1.2691	1.2658	-0.0033
14	30	HDR unbiased	1.2728	1.2665	-0.0063
15	30	HDR unbiased	1.2956	1.2938	-0.0018
16	30	HDR biased	1.2851	1.2881	0.003
17	30	HDR biased	1.2638	1.2652	0.0014
18	30	HDR biased	1.2894	1.293	0.0036
19	30	HDR biased	1.2695	1.2775	0.008
20	30	HDR biased	1.2717	1.2761	0.0044
21	0	correlation	1.2618	1.2604	-0.0014
22	0	correlation	1.2834	1.281	-0.0024
23	0	correlation	1.2646	1.2617	-0.0029
24	0	correlation	1.2743	1.2719	-0.0024
25	0	correlation	1.2522	1.25	-0.0022

TID vs Post - Pre Exposure Delta

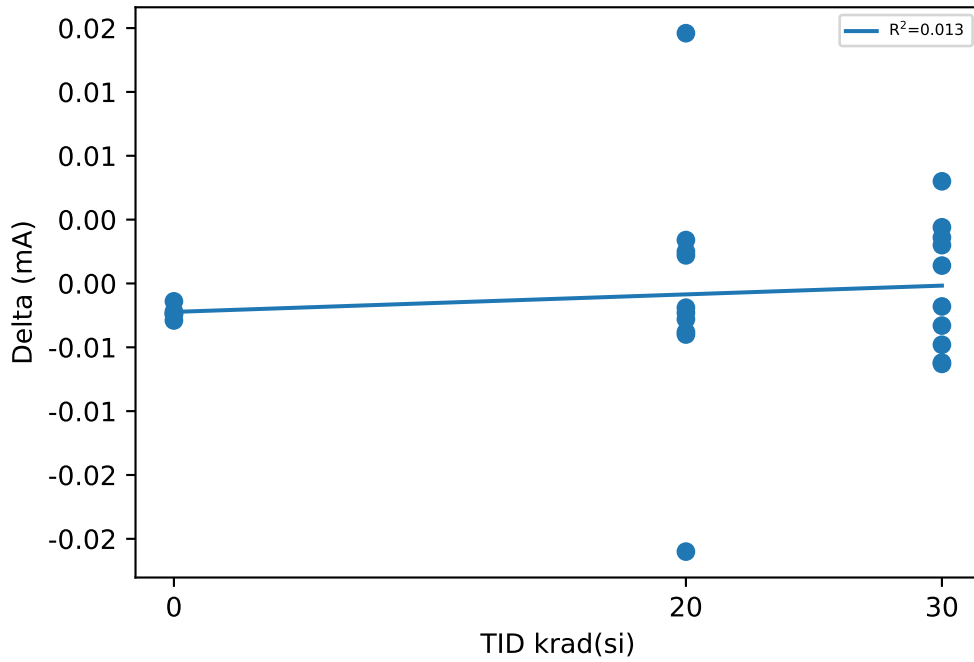

Test Statistics (mA)

krad(si)	Pre Exposure Min	Pre Exposure Avg	Pre Exposure Max	Pre Exposure Std	Post Exposure Min	Post Exposure Avg	Post Exposure Max	Post Exposure Std	Min Delta	Avg Delta	Max Delta	Std Delta
0	1.2522	1.2673	1.2834	0.011977	1.25	1.265	1.281	0.011839	-0.0029	-0.00226	-0.0014	0.00054589
20	1.2511	1.2688	1.2863	0.010718	1.2497	1.268	1.284	0.010027	-0.021	-0.00081	0.0196	0.0099355
30	1.2559	1.2768	1.2956	0.013708	1.2497	1.2766	1.2938	0.014792	-0.0063	-0.0002	0.008	0.0049686

Device Test: 5.18 UJ4UM7(ISD_Diag_12V_UJ4UM7)

TID vs Result Stats

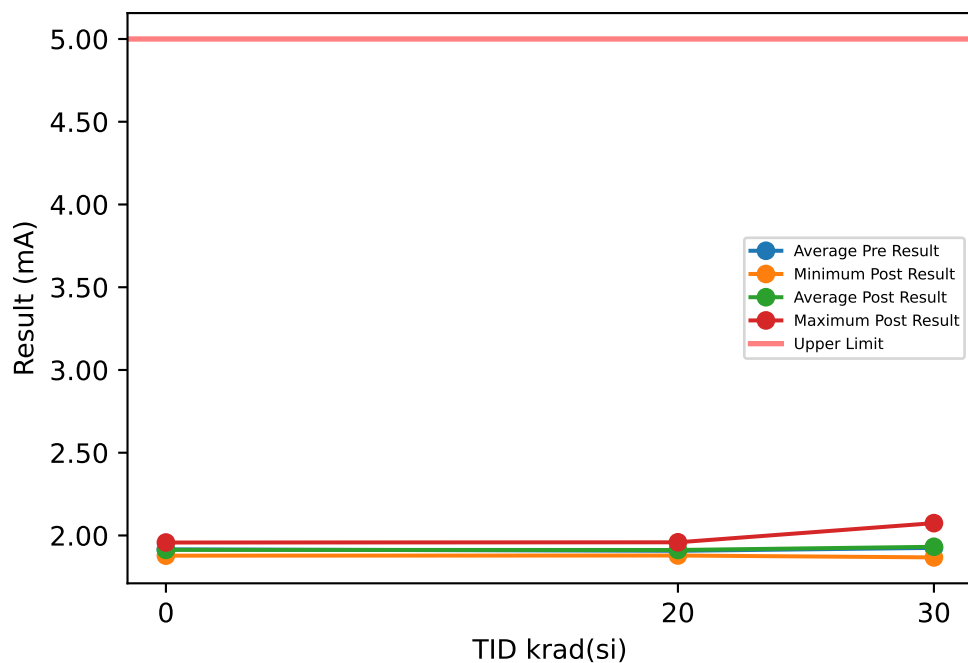

Test Results (Upper Limit = 5.0 (mA))

Serial #	krad(si)	Exposure Conditions	Pre Result	Post Result	Delta
1	20	HDR unbiased	1.9138	1.9065	-0.0073
2	20	HDR unbiased	1.9382	1.9196	-0.0186
3	20	HDR unbiased	1.9107	1.914	0.0033
4	20	HDR unbiased	1.9616	1.9587	-0.0029
5	20	HDR unbiased	1.9507	1.9496	-0.0011
6	20	HDR biased	1.9058	1.8796	-0.0262
7	20	HDR biased	1.8578	1.8807	0.0229
8	20	HDR biased	1.8596	1.879	0.0194
9	20	HDR biased	1.9151	1.9179	0.0028
10	20	HDR biased	1.8597	1.9181	0.0584
11	30	HDR unbiased	2.0859	2.0745	-0.0114
12	30	HDR unbiased	1.9329	1.9358	0.0029
13	30	HDR unbiased	1.8756	1.8675	-0.0081
14	30	HDR unbiased	1.8752	1.9251	0.0499
15	30	HDR unbiased	1.9001	1.8811	-0.019
16	30	HDR biased	1.9038	1.9305	0.0267
17	30	HDR biased	1.8897	1.9088	0.0191
18	30	HDR biased	1.9535	1.9375	-0.016
19	30	HDR biased	1.9248	1.911	-0.0138
20	30	HDR biased	1.9081	1.9436	0.0355
21	0	correlation	1.9167	1.9143	-0.0024
22	0	correlation	1.8809	1.8781	-0.0028
23	0	correlation	1.887	1.8839	-0.0031
24	0	correlation	1.9606	1.9574	-0.0032
25	0	correlation	1.935	1.9309	-0.0041

TID vs Post - Pre Exposure Delta

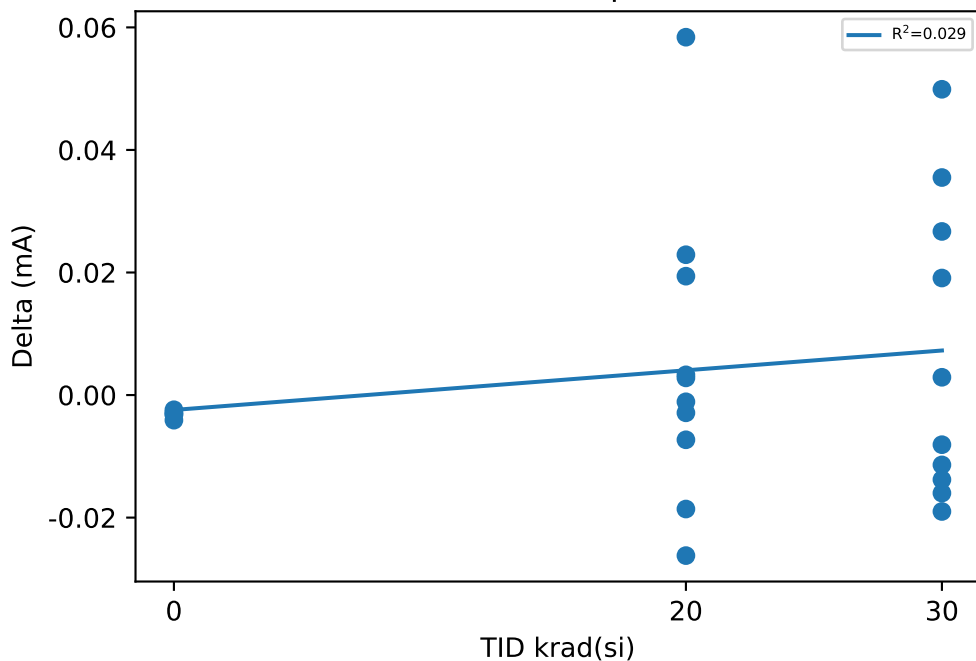

Test Statistics (mA)

krad(si)	Pre Exposure Min	Pre Exposure Avg	Pre Exposure Max	Pre Exposure Std	Post Exposure Min	Post Exposure Avg	Post Exposure Max	Post Exposure Std	Min Delta	Avg Delta	Max Delta	Std Delta
0	1.8809	1.916	1.9606	0.033255	1.8781	1.9129	1.9574	0.033009	-0.0041	-0.00312	-0.0024	0.00063008
20	1.8578	1.9073	1.9616	0.037852	1.879	1.9124	1.9587	0.02764	-0.0262	0.00507	0.0584	0.023964
30	1.8752	1.925	2.0859	0.061721	1.8675	1.9315	2.0745	0.056039	-0.019	0.00658	0.0499	0.024509

Device Test: 5.19 UJ4UM7(ISD_Diag_28V_UJ4UM7)

TID vs Result Stats

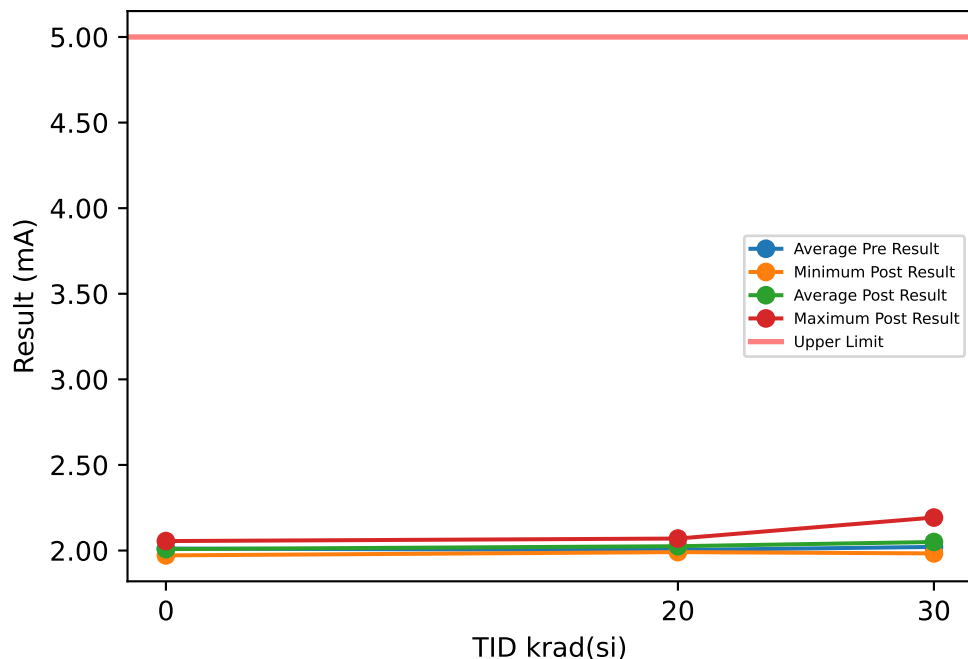

Test Results (Upper Limit = 5.0 (mA))

Serial #	krad(si)	Exposure Conditions	Pre Result	Post Result	Delta
1	20	HDR unbiased	2.0086	2.0196	0.011
2	20	HDR unbiased	2.0344	2.0325	-0.0019
3	20	HDR unbiased	2.003	2.0233	0.0203
4	20	HDR unbiased	2.0563	2.07	0.0137
5	20	HDR unbiased	2.0474	2.0622	0.0148
6	20	HDR biased	2.0022	1.9908	-0.0114
7	20	HDR biased	1.9545	1.9953	0.0408
8	20	HDR biased	1.9575	1.9946	0.0371
9	20	HDR biased	2.0142	2.0333	0.0191
10	20	HDR biased	1.9505	2.031	0.0805
11	30	HDR unbiased	2.1839	2.1927	0.0088
12	30	HDR unbiased	2.0319	2.0595	0.0276
13	30	HDR unbiased	1.9691	1.9832	0.0141
14	30	HDR unbiased	1.9747	2.0444	0.0697
15	30	HDR unbiased	1.9964	1.998	0.0016
16	30	HDR biased	1.9972	2.0446	0.0474
17	30	HDR biased	1.9815	2.024	0.0425
18	30	HDR biased	2.0491	2.0568	0.0077
19	30	HDR biased	2.0229	2.032	0.0091
20	30	HDR biased	2.0047	2.064	0.0593
21	0	correlation	2.0114	2.0081	-0.0033
22	0	correlation	1.9757	1.9716	-0.0041
23	0	correlation	1.9829	1.9788	-0.0041
24	0	correlation	2.0596	2.0553	-0.0043
25	0	correlation	2.0283	2.0275	-0.0008

TID vs Post - Pre Exposure Delta

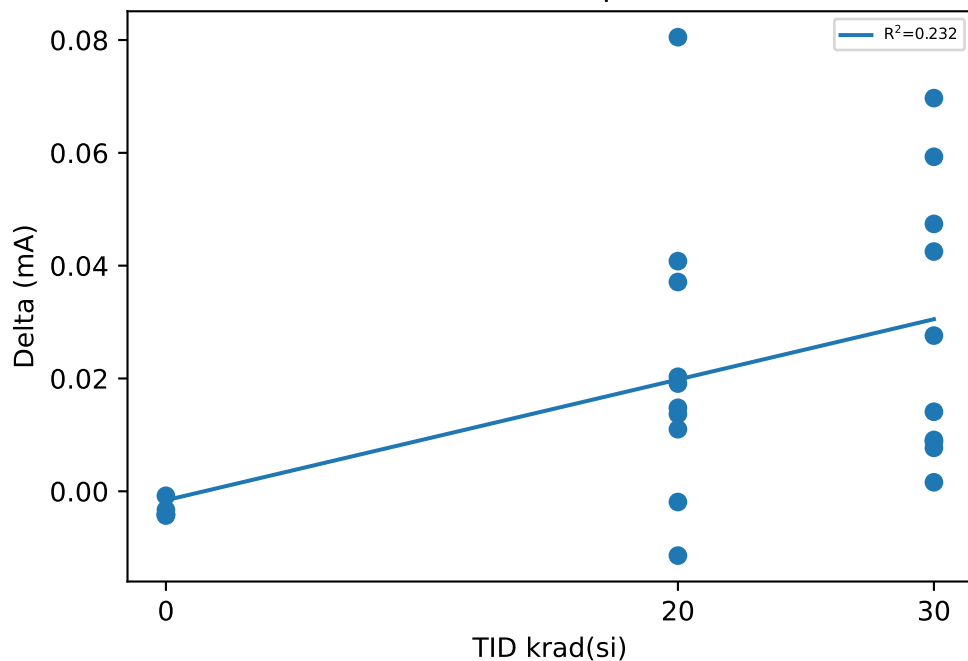

Test Statistics (mA)

krad(si)	Pre Exposure Min	Pre Exposure Avg	Pre Exposure Max	Pre Exposure Std	Post Exposure Min	Post Exposure Avg	Post Exposure Max	Post Exposure Std	Min Delta	Avg Delta	Max Delta	Std Delta
0	1.9757	2.0116	2.0596	0.034262	1.9716	2.0083	2.0553	0.034622	-0.0043	-0.00332	-0.0008	0.0014601
20	1.9505	2.0029	2.0563	0.038202	1.9908	2.0253	2.07	0.027033	-0.0114	0.0224	0.0805	0.025695
30	1.9691	2.0211	2.1839	0.062613	1.9832	2.0499	2.1927	0.056689	0.0016	0.02878	0.0697	0.02433

Device Test: 5.20 UJ4UM7(ISD_Diag_32V_UJ4UM7)

TID vs Result Stats

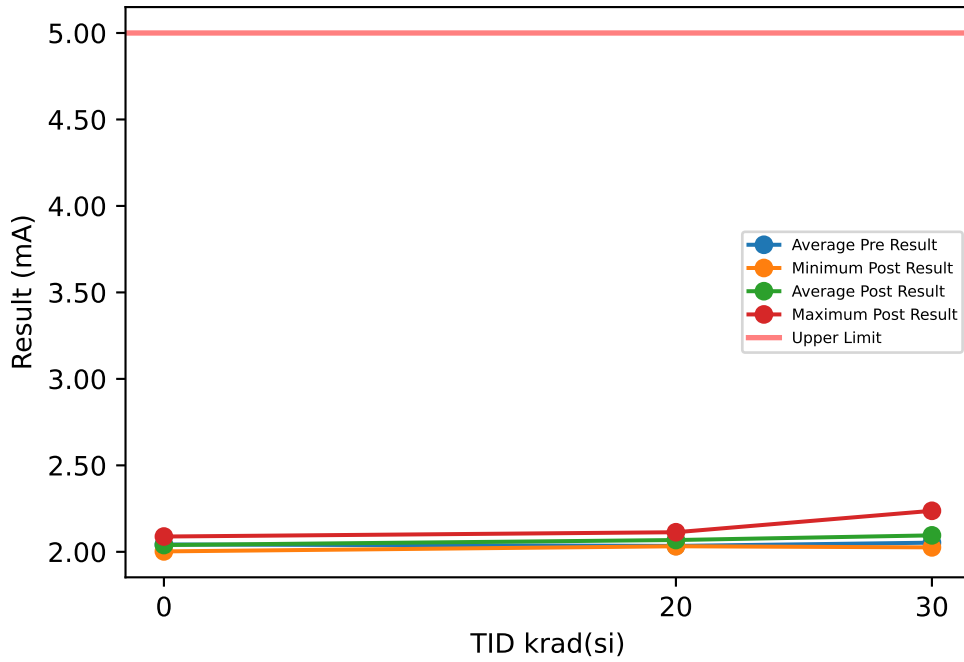

Test Results (Upper Limit = 5.0 (mA))

Serial #	krad(si)	Exposure Conditions	Pre Result	Post Result	Delta
1	20	HDR unbiased	2.0395	2.0592	0.0197
2	20	HDR unbiased	2.0659	2.0749	0.009
3	20	HDR unbiased	2.0332	2.0639	0.0307
4	20	HDR unbiased	2.088	2.1133	0.0253
5	20	HDR unbiased	2.0778	2.1041	0.0263
6	20	HDR biased	2.0344	2.0321	-0.0023
7	20	HDR biased	1.9873	2.0402	0.0529
8	20	HDR biased	1.9898	2.0396	0.0498
9	20	HDR biased	2.0468	2.0795	0.0327
10	20	HDR biased	1.9806	2.0751	0.0945
11	30	HDR unbiased	2.2162	2.2372	0.021
12	30	HDR unbiased	2.0647	2.1072	0.0425
13	30	HDR unbiased	2.0008	2.0258	0.025
14	30	HDR unbiased	2.0077	2.089	0.0813
15	30	HDR unbiased	2.0292	2.0421	0.0129
16	30	HDR biased	2.0287	2.0887	0.06
17	30	HDR biased	2.0113	2.0685	0.0572
18	30	HDR biased	2.079	2.1021	0.0231
19	30	HDR biased	2.0544	2.0794	0.025
20	30	HDR biased	2.0377	2.1124	0.0747
21	0	correlation	2.0408	2.0382	-0.0026
22	0	correlation	2.007	2.0025	-0.0045
23	0	correlation	2.0132	2.0088	-0.0044
24	0	correlation	2.0918	2.0885	-0.0033
25	0	correlation	2.0601	2.0582	-0.0019

TID vs Post - Pre Exposure Delta

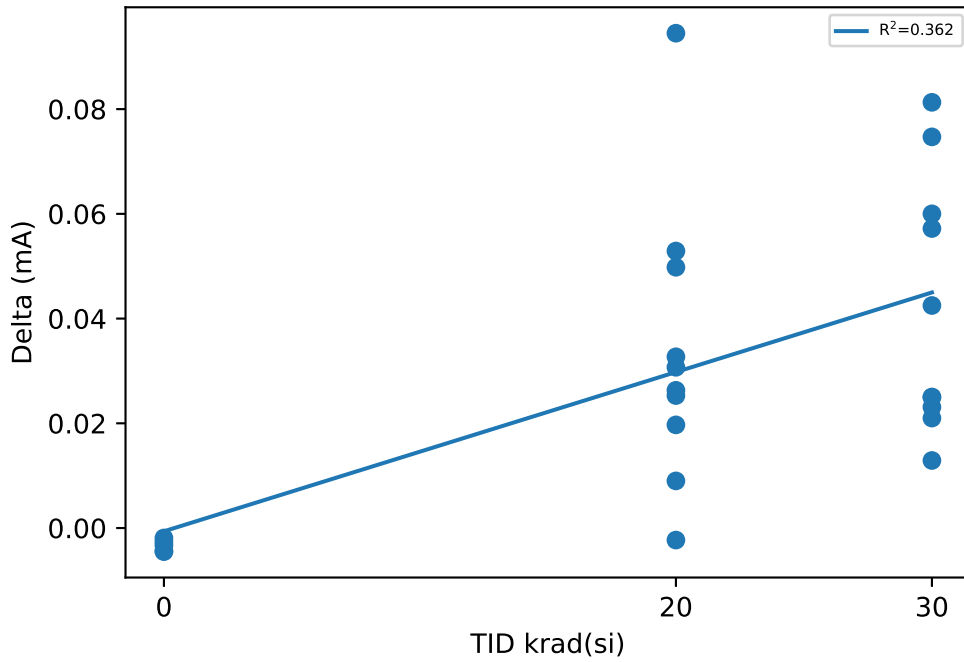

Test Statistics (mA)

krad(si)	Pre Exposure Min	Pre Exposure Avg	Pre Exposure Max	Pre Exposure Std	Post Exposure Min	Post Exposure Avg	Post Exposure Max	Post Exposure Std	Min Delta	Avg Delta	Max Delta	Std Delta
0	2.007	2.0426	2.0918	0.034863	2.0025	2.0392	2.0885	0.035579	-0.0045	-0.00334	-0.0019	0.0011283
20	1.9806	2.0343	2.088	0.038053	2.0321	2.0682	2.1133	0.026973	-0.0023	0.03386	0.0945	0.027001
30	2.0008	2.053	2.2162	0.062677	2.0258	2.0952	2.2372	0.057087	0.0129	0.04227	0.0813	0.024475

Device Test: 5.2 UJTKLS(Iop_12V_UJTKLS)

TID vs Result Stats

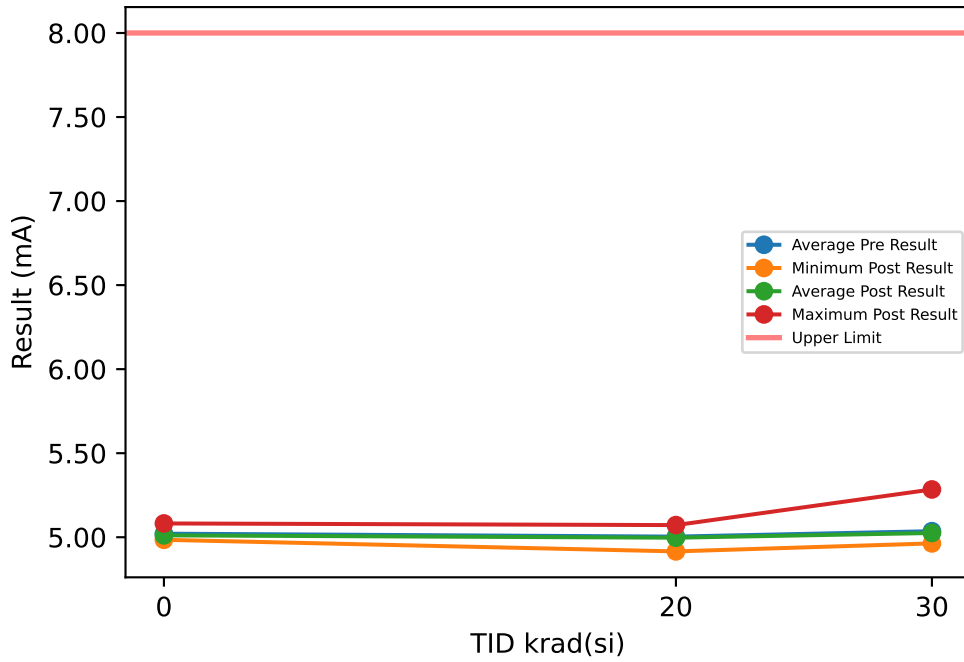

Test Results (Upper Limit = 8.0 (mA))

Serial #	krad(si)	Exposure Conditions	Pre Result	Post Result	Delta
1	20	HDR unbiased	5.0402	5.0264	-0.0138
2	20	HDR unbiased	5.0381	5.0087	-0.0294
3	20	HDR unbiased	5.0149	5.0124	-0.0025
4	20	HDR unbiased	5.0597	5.0428	-0.0169
5	20	HDR unbiased	5.0918	5.0722	-0.0196
6	20	HDR biased	5.0262	4.9157	-0.1105
7	20	HDR biased	4.9424	4.9543	0.0119
8	20	HDR biased	4.9467	4.9608	0.0141
9	20	HDR biased	4.9656	4.9563	-0.0093
10	20	HDR biased	4.9113	5.0219	0.1106
11	30	HDR unbiased	5.3146	5.2842	-0.0304
12	30	HDR unbiased	4.9794	4.9633	-0.0161
13	30	HDR unbiased	4.9925	4.9717	-0.0208
14	30	HDR unbiased	4.9598	4.9841	0.0243
15	30	HDR unbiased	5.0449	5.012	-0.0329
16	30	HDR biased	5.0223	5.0247	0.0024
17	30	HDR biased	4.9748	4.9763	0.0015
18	30	HDR biased	5.0686	5.0268	-0.0418
19	30	HDR biased	4.9952	4.9769	-0.0183
20	30	HDR biased	5.0075	5.0315	0.024
21	0	correlation	5.0077	4.9999	-0.0078
22	0	correlation	5.0061	4.9952	-0.0109
23	0	correlation	4.9939	4.9847	-0.0092
24	0	correlation	5.093	5.082	-0.011
25	0	correlation	5.0053	4.9935	-0.0118

TID vs Post - Pre Exposure Delta

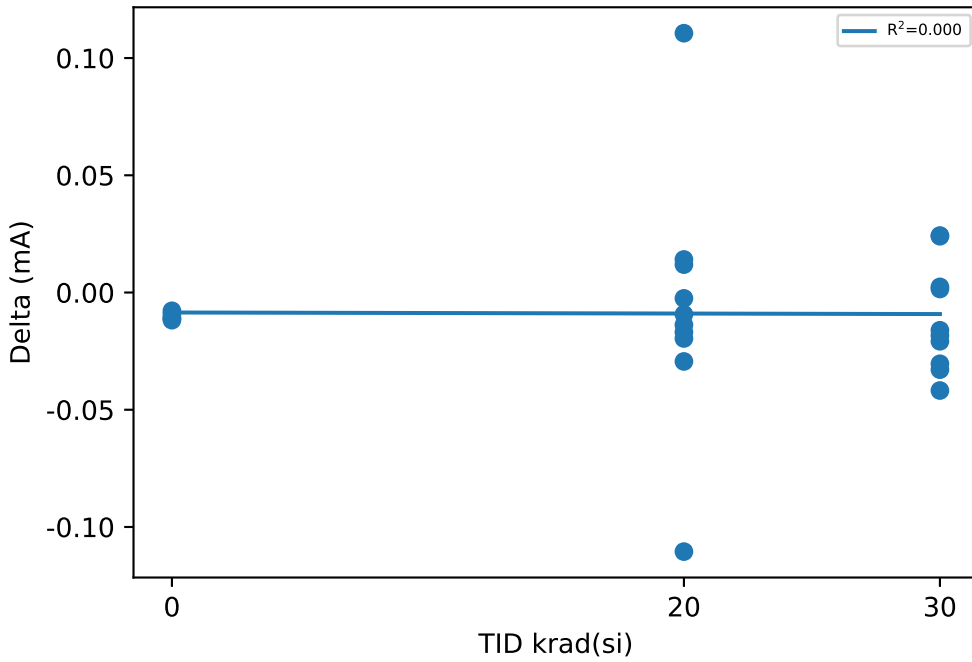

Test Statistics (mA)

krad(si)	Pre Exposure Min	Pre Exposure Avg	Pre Exposure Max	Pre Exposure Std	Post Exposure Min	Post Exposure Avg	Post Exposure Max	Post Exposure Std	Min Delta	Avg Delta	Max Delta	Std Delta
0	4.9939	5.0212	5.093	0.040508	4.9847	5.0111	5.082	0.040037	-0.0118	-0.01014	-0.0078	0.0016149
20	4.9113	5.0037	5.0918	0.058728	4.9157	4.9971	5.0722	0.048317	-0.1105	-0.00654	0.1106	0.053927
30	4.9598	5.036	5.3146	0.10332	4.9633	5.0252	5.2842	0.094519	-0.0418	-0.01081	0.0243	0.023061

Device Test: 5.21 UJ3WW2(IF1_5V_UJ3WW2)

TID vs Result Stats

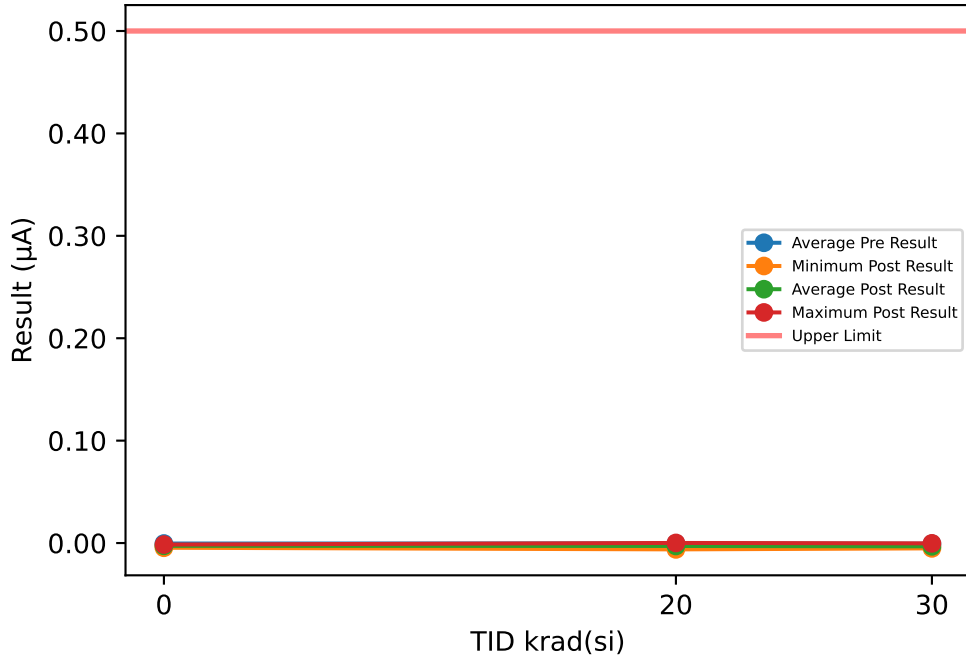

Test Results (Upper Limit = 0.5 (µA))

Serial #	krad(si)	Exposure Conditions	Pre Result	Post Result	Delta
1	20	HDR unbiased	0.0018	-0.0021	-0.0039
2	20	HDR unbiased	0.0006	-0.0044	-0.005
3	20	HDR unbiased	0.001	-0.0028	-0.0038
4	20	HDR unbiased	-0.0054	-0.004	0.0014
5	20	HDR unbiased	-0.0007	-0.0015	-0.0008
6	20	HDR biased	-0.0001	0.0001	0.0002
7	20	HDR biased	-0.0009	-0.003	-0.0021
8	20	HDR biased	-0.0007	-0.0032	-0.0025
9	20	HDR biased	-0.0001	-0.0015	-0.0014
10	20	HDR biased	0.0006	-0.0062	-0.0068
11	30	HDR unbiased	-0.0023	-0.0026	-0.0003
12	30	HDR unbiased	0.0005	-0.0046	-0.0051
13	30	HDR unbiased	-0.0001	-0.003	-0.0029
14	30	HDR unbiased	0.0008	-0.0052	-0.006
15	30	HDR unbiased	-0.0023	-0.0036	-0.0013
16	30	HDR biased	0.0038	-0.0032	-0.007
17	30	HDR biased	-0.0025	-0.0036	-0.0011
18	30	HDR biased	-0.0013	-0.0003	0.001
19	30	HDR biased	-0.0013	-0.0023	-0.001
20	30	HDR biased	-0.0023	-0.0038	-0.0015
21	0	correlation	0.001	-0.0046	-0.0056
22	0	correlation	-0.0015	-0.0024	-0.0009
23	0	correlation	-0.0027	-0.0036	-0.0009
24	0	correlation	0.0036	-0.0015	-0.0051
25	0	correlation	-0.0027	-0.0015	0.0012

TID vs Post - Pre Exposure Delta

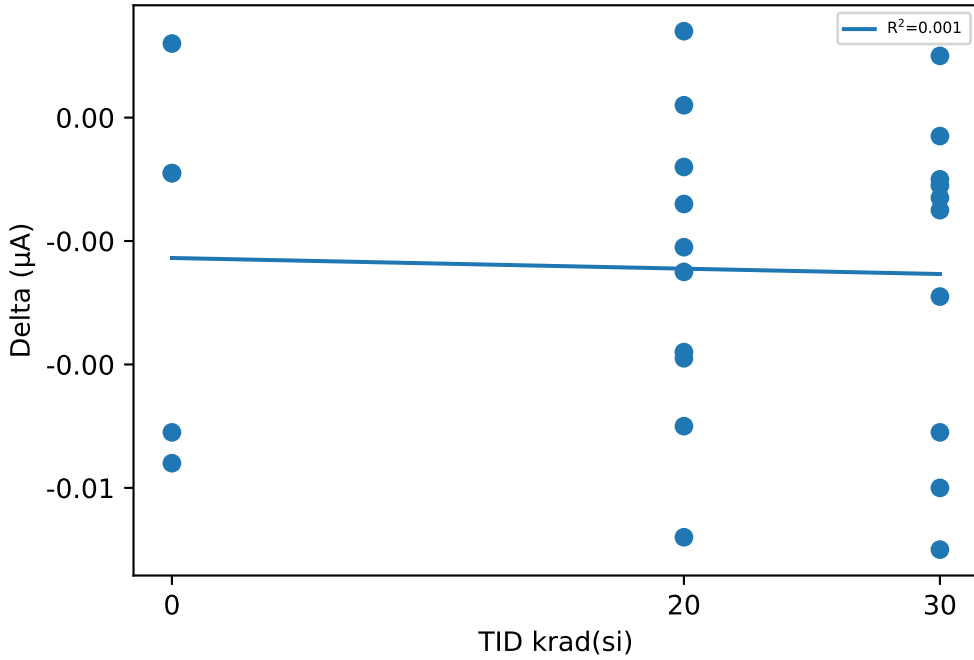

Test Statistics (µA)

krad(si)	Pre Exposure Min	Pre Exposure Avg	Pre Exposure Max	Pre Exposure Std	Post Exposure Min	Post Exposure Avg	Post Exposure Max	Post Exposure Std	Min Delta	Avg Delta	Max Delta	Std Delta
0	-0.0027	-0.00046	0.0036	0.0027264	-0.0046	-0.00272	-0.0015	0.001359	-0.0056	-0.00226	0.0012	0.0029535
20	-0.0054	-0.00039	0.0018	0.0019553	-0.0062	-0.00286	0.0001	0.001764	-0.0068	-0.00247	0.0014	0.0024752
30	-0.0025	-0.0007	0.0038	0.0019983	-0.0052	-0.00322	-0.0003	0.001344	-0.007	-0.00252	0.001	0.002649

Device Test: 5.22 UJ3WW2(IF1_12V_UJ3WW2)

TID vs Result Stats

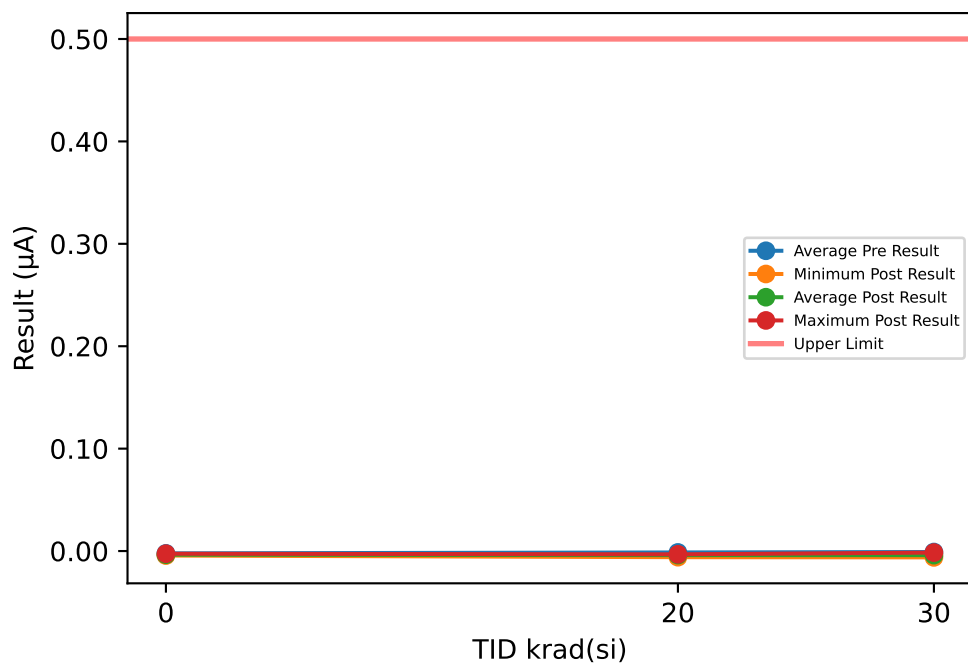

Test Results (Upper Limit = 0.5 (µA))

Serial #	krad(si)	Exposure Conditions	Pre Result	Post Result	Delta
1	20	HDR unbiased	-0.0027	-0.0032	-0.0005
2	20	HDR unbiased	-0.0023	-0.0042	-0.0019
3	20	HDR unbiased	-0.0029	-0.0034	-0.0005
4	20	HDR unbiased	0.0016	-0.0038	-0.0054
5	20	HDR unbiased	-0.0003	-0.0034	-0.0031
6	20	HDR biased	0.0001	-0.0032	-0.0033
7	20	HDR biased	-0.0031	-0.006	-0.0029
8	20	HDR biased	-0.0019	-0.0056	-0.0037
9	20	HDR biased	-0.0003	-0.0032	-0.0029
10	20	HDR biased	-0.0017	-0.0036	-0.0019
11	30	HDR unbiased	-0.0017	-0.0032	-0.0015
12	30	HDR unbiased	-0.0005	-0.0015	-0.001
13	30	HDR unbiased	-0.0029	-0.0046	-0.0017
14	30	HDR unbiased	0.0016	-0.0042	-0.0058
15	30	HDR unbiased	-0.0025	-0.0052	-0.0027
16	30	HDR biased	-0.0005	-0.0034	-0.0029
17	30	HDR biased	-0.0015	-0.003	-0.0015
18	30	HDR biased	0.0008	-0.0048	-0.0056
19	30	HDR biased	-0.0015	-0.0062	-0.0047
20	30	HDR biased	-0.0009	-0.004	-0.0031
21	0	correlation	-0.0037	-0.0044	-0.0007
22	0	correlation	-0.0023	-0.0026	-0.0003
23	0	correlation	-0.0019	-0.004	-0.0021
24	0	correlation	-0.0015	-0.0026	-0.0011
25	0	correlation	-0.0019	-0.0042	-0.0023

TID vs Post - Pre Exposure Delta

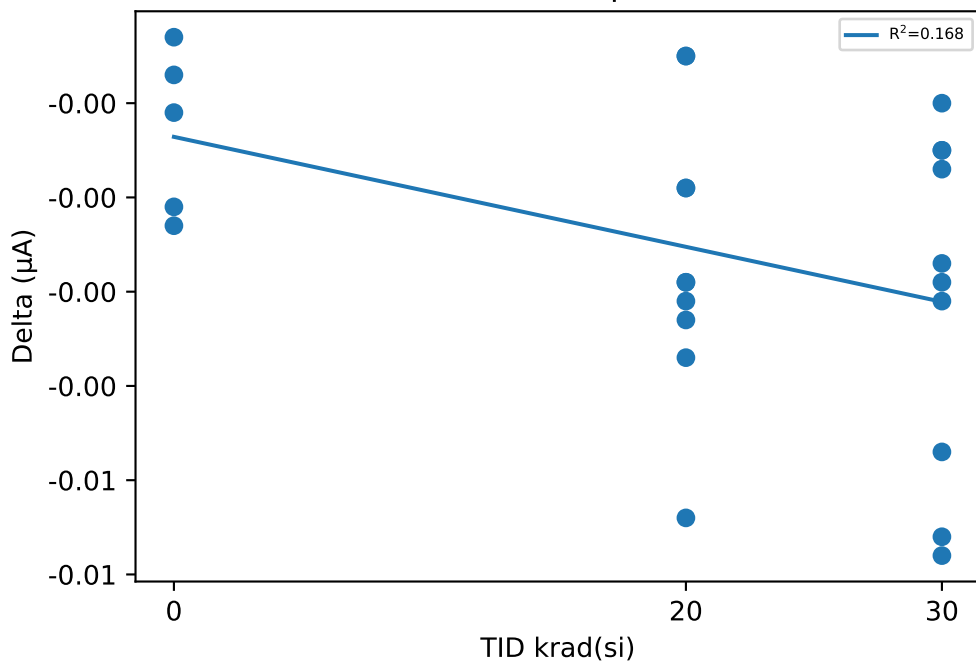

Test Statistics (µA)

krad(si)	Pre Exposure Min	Pre Exposure Avg	Pre Exposure Max	Pre Exposure Std	Post Exposure Min	Post Exposure Avg	Post Exposure Max	Post Exposure Std	Min Delta	Avg Delta	Max Delta	Std Delta
0	-0.0037	-0.00226	-0.0015	0.00085323	-0.0044	-0.00356	-0.0026	0.00088769	-0.0023	-0.0013	-0.0003	0.00087178
20	-0.0031	-0.00135	0.0016	0.0015501	-0.006	-0.00396	-0.0032	0.0010233	-0.0054	-0.00261	-0.0005	0.0014821
30	-0.0029	-0.00096	0.0016	0.0013882	-0.0062	-0.00401	-0.0015	0.0013153	-0.0058	-0.00305	-0.001	0.0017564

Device Test: 5.24 UJ3WW2(IF1_32V_UJ3WW2)

TID vs Result Stats

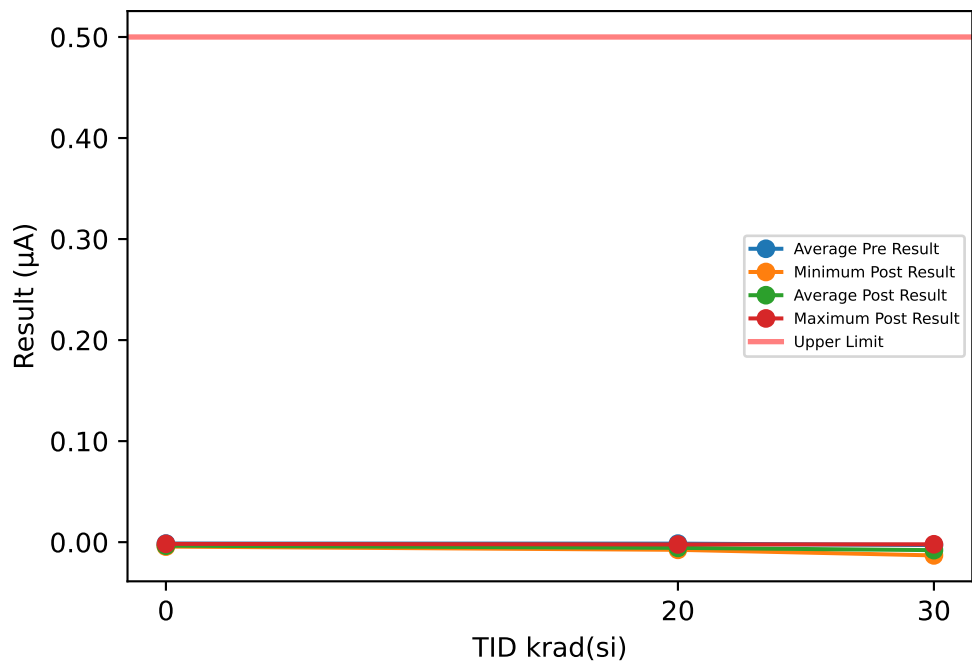

Test Results (Upper Limit = 0.5 (µA))

Serial #	krad(si)	Exposure Conditions	Pre Result	Post Result	Delta
1	20	HDR unbiased	-0.0007	-0.0034	-0.0027
2	20	HDR unbiased	-0.0043	-0.0054	-0.0011
3	20	HDR unbiased	-0.0025	-0.0064	-0.0039
4	20	HDR unbiased	-0.0023	-0.0052	-0.0029
5	20	HDR unbiased	-0.0023	-0.0023	0
6	20	HDR biased	-0.0013	-0.007	-0.0057
7	20	HDR biased	-0.0015	-0.006	-0.0045
8	20	HDR biased	-0.0013	-0.007	-0.0057
9	20	HDR biased	0.0012	-0.0062	-0.0074
10	20	HDR biased	0.0006	-0.0076	-0.0082
11	30	HDR unbiased	-0.0019	-0.006	-0.0041
12	30	HDR unbiased	-0.0043	-0.0021	0.0022
13	30	HDR unbiased	-0.0023	-0.0048	-0.0025
14	30	HDR unbiased	-0.0023	-0.0052	-0.0029
15	30	HDR unbiased	-0.0029	-0.0046	-0.0017
16	30	HDR biased	-0.0039	-0.0101	-0.0062
17	30	HDR biased	-0.0025	-0.0109	-0.0084
18	30	HDR biased	-0.0021	-0.0131	-0.011
19	30	HDR biased	-0.0033	-0.0097	-0.0064
20	30	HDR biased	-0.0033	-0.0125	-0.0092
21	0	correlation	-0.0009	-0.0017	-0.0008
22	0	correlation	-0.0023	-0.0034	-0.0011
23	0	correlation	-0.0017	-0.0044	-0.0027
24	0	correlation	-0.0001	-0.0038	-0.0037
25	0	correlation	-0.0019	-0.0042	-0.0023

TID vs Post - Pre Exposure Delta

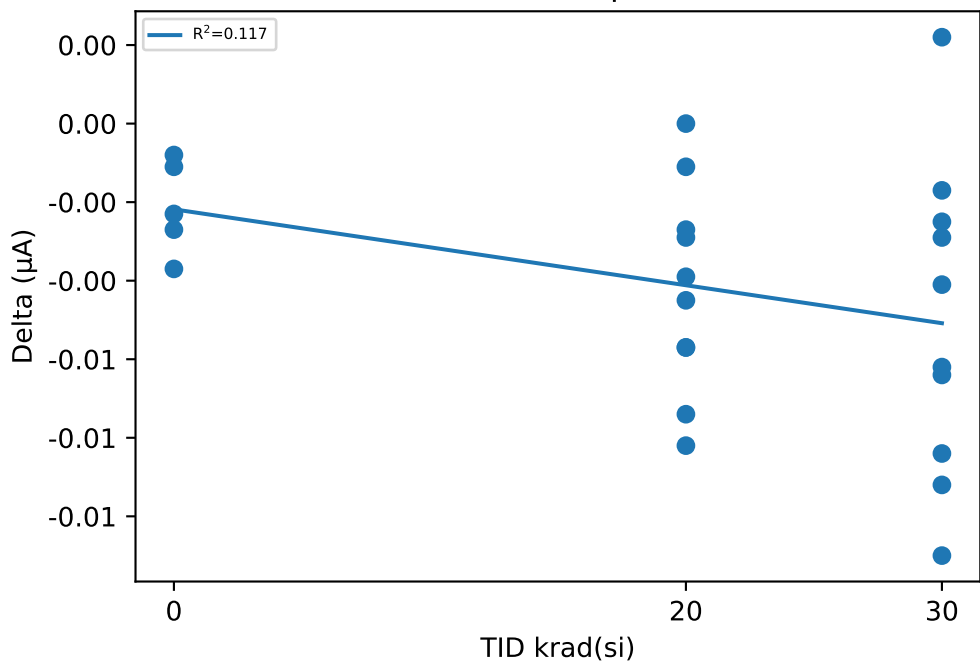

Test Statistics (µA)

krad(si)	Pre Exposure Min	Pre Exposure Avg	Pre Exposure Max	Pre Exposure Std	Post Exposure Min	Post Exposure Avg	Post Exposure Max	Post Exposure Std	Min Delta	Avg Delta	Max Delta	Std Delta
0	-0.0023	-0.00138	-0.0001	0.00087864	-0.0044	-0.0035	-0.0017	0.001077	-0.0037	-0.00212	-0.0008	0.0011883
20	-0.0043	-0.00144	0.0012	0.0015813	-0.0076	-0.00565	-0.0023	0.0016662	-0.0082	-0.00421	0	0.002627
30	-0.0043	-0.00288	-0.0019	0.0008025	-0.0131	-0.0079	-0.0021	0.0038053	-0.011	-0.00502	0.0022	0.0039832

Device Test: 5.25 UJ3WW2(IF2_5V_UJ3WW2)

TID vs Result Stats

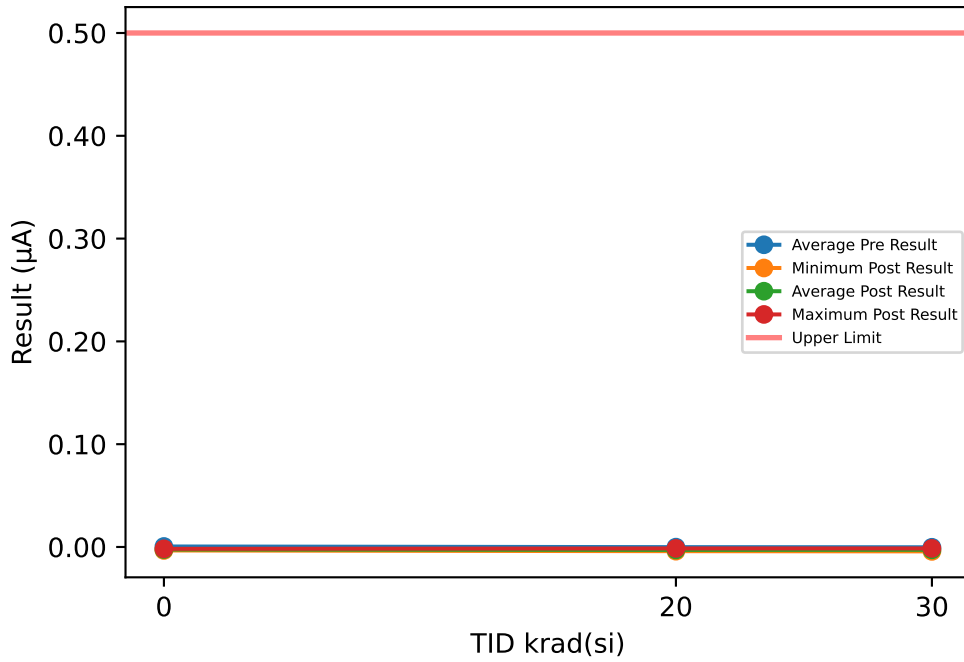

Test Results (Upper Limit = 0.5 (µA))

Serial #	krad(si)	Exposure Conditions	Pre Result	Post Result	Delta
1	20	HDR unbiased	0.0015	-0.003	-0.0045
2	20	HDR unbiased	0.0001	-0.0041	-0.0042
3	20	HDR unbiased	-0.0018	-0.0028	-0.001
4	20	HDR unbiased	-0.0024	-0.0041	-0.0017
5	20	HDR unbiased	0.0013	-0.0034	-0.0047
6	20	HDR biased	0.0001	-0.0032	-0.0033
7	20	HDR biased	-0.0007	-0.002	-0.0013
8	20	HDR biased	0.0013	-0.0014	-0.0027
9	20	HDR biased	-0.002	-0.0022	-0.0002
10	20	HDR biased	0.0011	-0.0026	-0.0037
11	30	HDR unbiased	-0.0003	-0.0022	-0.0019
12	30	HDR unbiased	0.0001	-0.0022	-0.0023
13	30	HDR unbiased	0.0001	-0.0028	-0.0029
14	30	HDR unbiased	-0.0001	-0.0018	-0.0017
15	30	HDR unbiased	-0.0018	-0.0043	-0.0025
16	30	HDR biased	0.0017	-0.0037	-0.0054
17	30	HDR biased	0.0007	-0.0035	-0.0042
18	30	HDR biased	-0.0009	-0.0028	-0.0019
19	30	HDR biased	0.0001	-0.0014	-0.0015
20	30	HDR biased	-0.0024	-0.0028	-0.0004
21	0	correlation	-0.0005	-0.0018	-0.0013
22	0	correlation	0.0027	-0.0018	-0.0045
23	0	correlation	0.0001	-0.0028	-0.0029
24	0	correlation	-0.0001	-0.0026	-0.0025
25	0	correlation	0.0003	-0.0034	-0.0037

TID vs Post - Pre Exposure Delta

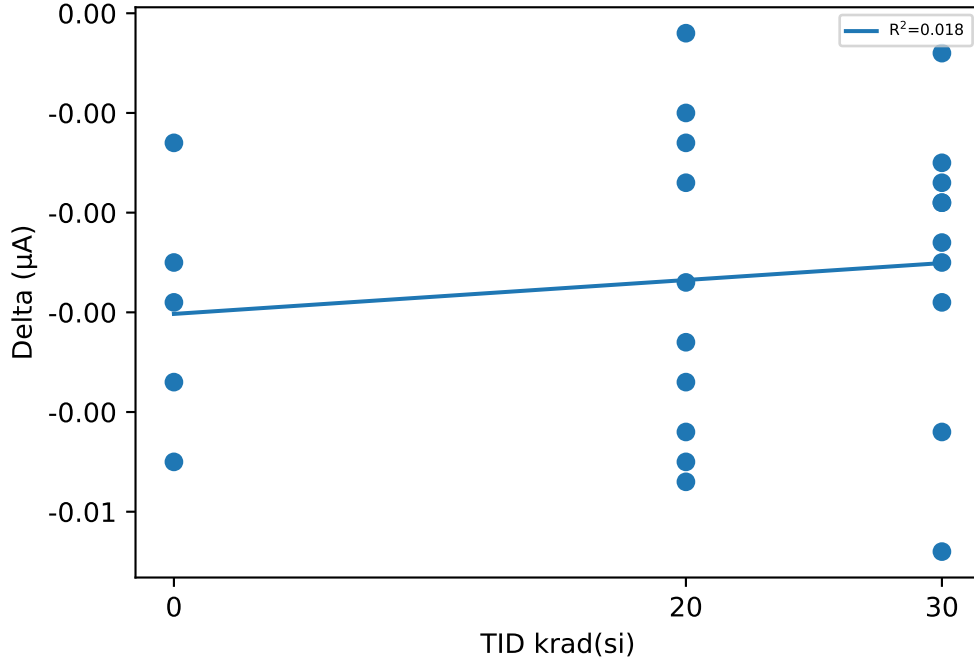

Test Statistics (µA)

krad(si)	Pre Exposure Min	Pre Exposure Avg	Pre Exposure Max	Pre Exposure Std	Post Exposure Min	Post Exposure Avg	Post Exposure Max	Post Exposure Std	Min Delta	Avg Delta	Max Delta	Std Delta
0	-0.0005	0.0005	0.0027	0.0012649	-0.0034	-0.00248	-0.0018	0.00068702	-0.0045	-0.00298	-0.0013	0.0012133
20	-0.0024	-0.00015	0.0015	0.0014954	-0.0041	-0.00288	-0.0014	0.00087407	-0.0047	-0.00273	-0.0002	0.0015966
30	-0.0024	-0.00028	0.0017	0.0011802	-0.0043	-0.00275	-0.0014	0.00089474	-0.0054	-0.00247	-0.0004	0.0014244

Device Test: 5.26 UJ3WW2(IF2_12V_UJ3WW2)

TID vs Result Stats

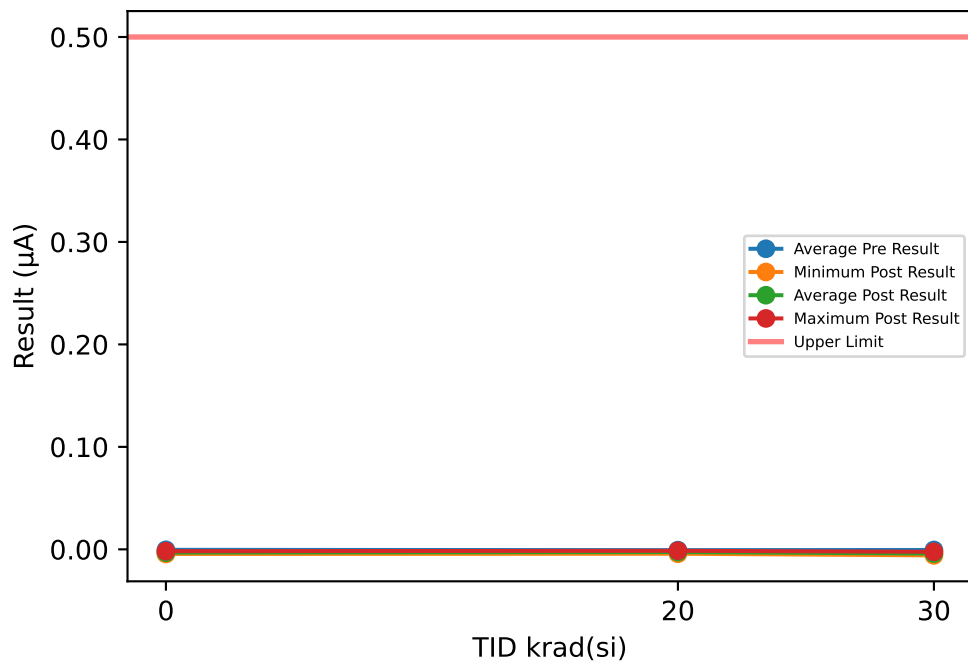

Test Results (Upper Limit = 0.5 (µA))

Serial #	krad(si)	Exposure Conditions	Pre Result	Post Result	Delta
1	20	HDR unbiased	-0.0007	-0.0043	-0.0036
2	20	HDR unbiased	-0.0018	-0.0016	0.0002
3	20	HDR unbiased	0.0011	-0.0024	-0.0035
4	20	HDR unbiased	-0.0011	-0.0028	-0.0017
5	20	HDR unbiased	0.0003	-0.0014	-0.0017
6	20	HDR biased	-0.0016	-0.0024	-0.0008
7	20	HDR biased	-0.0011	-0.0043	-0.0032
8	20	HDR biased	0.0007	-0.0024	-0.0031
9	20	HDR biased	-0.002	-0.0016	0.0004
10	20	HDR biased	-0.0015	-0.0037	-0.0022
11	30	HDR unbiased	0.0007	-0.0032	-0.0039
12	30	HDR unbiased	0.0001	-0.0039	-0.004
13	30	HDR unbiased	-0.0003	-0.0051	-0.0048
14	30	HDR unbiased	-0.0016	-0.0024	-0.0008
15	30	HDR unbiased	-0.0007	-0.0037	-0.003
16	30	HDR biased	-0.0009	-0.0051	-0.0042
17	30	HDR biased	-0.002	-0.0059	-0.0039
18	30	HDR biased	0.0001	-0.0035	-0.0036
19	30	HDR biased	0.0001	-0.0055	-0.0056
20	30	HDR biased	-0.0015	-0.0028	-0.0013
21	0	correlation	0.0033	-0.002	-0.0053
22	0	correlation	-0.004	-0.0045	-0.0005
23	0	correlation	-0.0005	-0.0018	-0.0013
24	0	correlation	0.0005	-0.0043	-0.0048
25	0	correlation	-0.0016	-0.0034	-0.0018

TID vs Post - Pre Exposure Delta

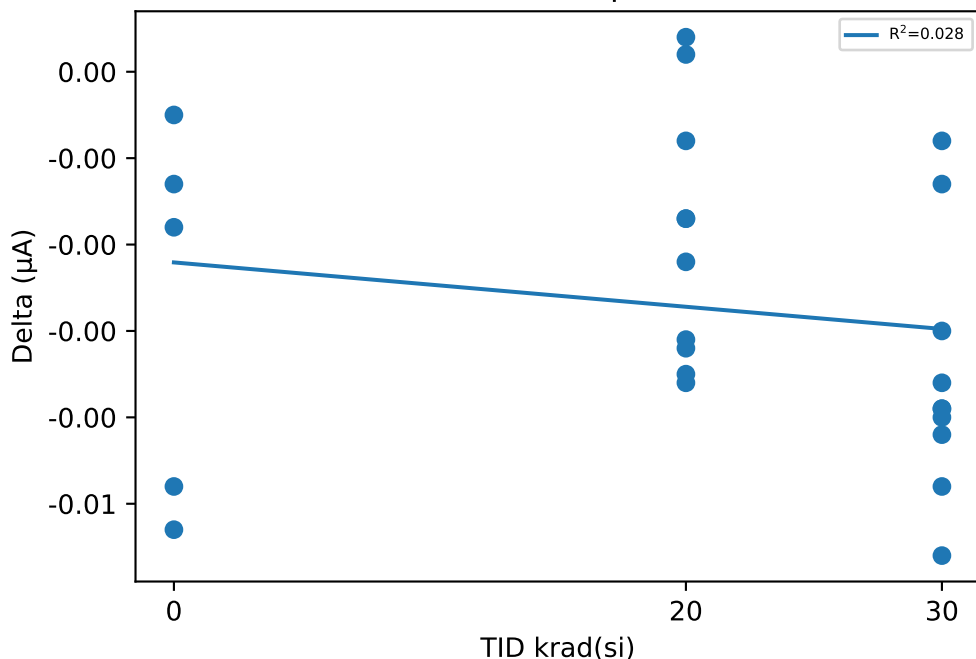

Device Test: 5.27 UJ3WW2(IF2_28V_UJ3WW2)

TID vs Result Stats

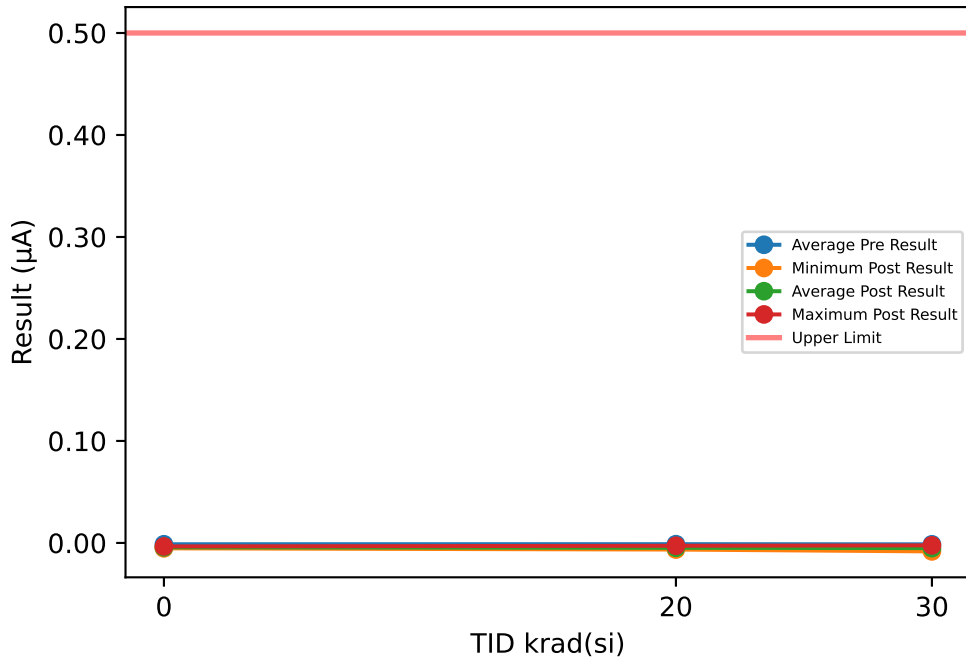

Test Results (Upper Limit = 0.5 (µA))

Serial #	krad(si)	Exposure Conditions	Pre Result	Post Result	Delta
1	20	HDR unbiased	-0.0016	-0.0049	-0.0033
2	20	HDR unbiased	0.0001	-0.0043	-0.0044
3	20	HDR unbiased	-0.002	-0.0034	-0.0014
4	20	HDR unbiased	-0.0013	-0.0043	-0.003
5	20	HDR unbiased	-0.0015	-0.0028	-0.0013
6	20	HDR biased	-0.002	-0.0057	-0.0037
7	20	HDR biased	-0.003	-0.0065	-0.0035
8	20	HDR biased	-0.0016	-0.0051	-0.0035
9	20	HDR biased	-0.0016	-0.0049	-0.0033
10	20	HDR biased	0.0023	-0.0059	-0.0082
11	30	HDR unbiased	-0.0028	-0.003	-0.0002
12	30	HDR unbiased	-0.0015	-0.0041	-0.0026
13	30	HDR unbiased	-0.0028	-0.003	-0.0002
14	30	HDR unbiased	-0.0011	-0.0032	-0.0021
15	30	HDR unbiased	-0.003	-0.0024	0.0006
16	30	HDR biased	-0.0007	-0.0065	-0.0058
17	30	HDR biased	-0.0003	-0.0059	-0.0056
18	30	HDR biased	-0.0007	-0.0083	-0.0076
19	30	HDR biased	-0.0011	-0.0075	-0.0064
20	30	HDR biased	0.0003	-0.0069	-0.0072
21	0	correlation	-0.0022	-0.0053	-0.0031
22	0	correlation	-0.0007	-0.0051	-0.0044
23	0	correlation	-0.0007	-0.0039	-0.0032
24	0	correlation	-0.0007	-0.0034	-0.0027
25	0	correlation	-0.0022	-0.0039	-0.0017

TID vs Post - Pre Exposure Delta

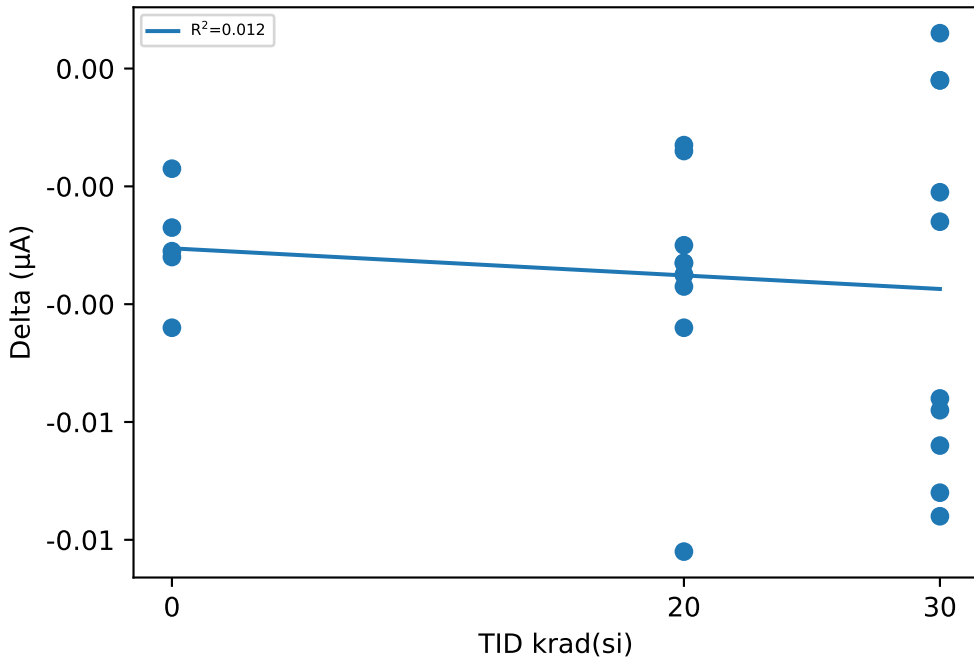

Test Statistics (µA)

krad(si)	Pre Exposure Min	Pre Exposure Avg	Pre Exposure Max	Pre Exposure Std	Post Exposure Min	Post Exposure Avg	Post Exposure Max	Post Exposure Std	Min Delta	Avg Delta	Max Delta	Std Delta
0	-0.0022	-0.0013	-0.0007	0.00082158	-0.0053	-0.00432	-0.0034	0.00083187	-0.0044	-0.00302	-0.0017	0.00097314
20	-0.003	-0.00122	0.0023	0.0014543	-0.0065	-0.00478	-0.0028	0.0011292	-0.0082	-0.00356	-0.0013	0.0018998
30	-0.003	-0.00137	0.0003	0.0011422	-0.0083	-0.00508	-0.0024	0.0021745	-0.0076	-0.00371	0.0006	0.003154

Device Test: 5.28 UJ3WW2(IF2_32V_UJ3WW2)

TID vs Result Stats

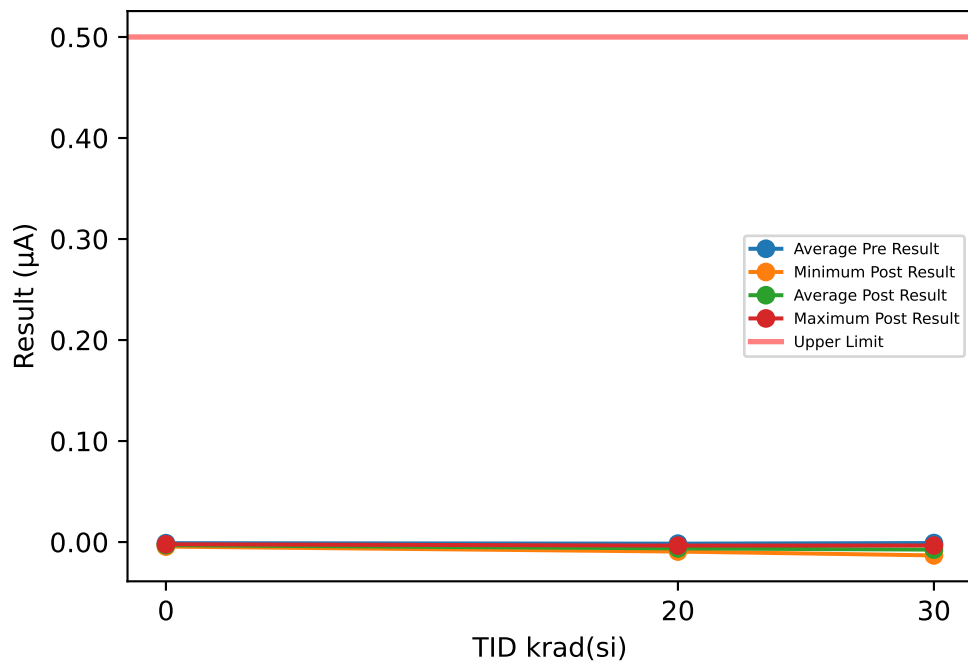

Test Results (Upper Limit = 0.5 (µA))

Serial #	krad(si)	Exposure Conditions	Pre Result	Post Result	Delta
1	20	HDR unbiased	0.0005	-0.0041	-0.0046
2	20	HDR unbiased	-0.0003	-0.0035	-0.0032
3	20	HDR unbiased	-0.0042	-0.0047	-0.0005
4	20	HDR unbiased	-0.0003	-0.0035	-0.0032
5	20	HDR unbiased	-0.0026	-0.0045	-0.0019
6	20	HDR biased	-0.0009	-0.0075	-0.0066
7	20	HDR biased	-0.0022	-0.0094	-0.0072
8	20	HDR biased	-0.0016	-0.0087	-0.0071
9	20	HDR biased	-0.003	-0.0087	-0.0057
10	20	HDR biased	-0.0011	-0.0081	-0.007
11	30	HDR unbiased	-0.002	-0.0047	-0.0027
12	30	HDR unbiased	-0.0018	-0.0047	-0.0029
13	30	HDR unbiased	-0.0015	-0.0049	-0.0034
14	30	HDR unbiased	-0.0007	-0.0045	-0.0038
15	30	HDR unbiased	-0.0001	-0.0034	-0.0033
16	30	HDR biased	0.0003	-0.0092	-0.0095
17	30	HDR biased	-0.0009	-0.01	-0.0091
18	30	HDR biased	-0.0007	-0.0132	-0.0125
19	30	HDR biased	-0.002	-0.0096	-0.0076
20	30	HDR biased	-0.0003	-0.0106	-0.0103
21	0	correlation	-0.0018	-0.0022	-0.0004
22	0	correlation	0.0001	-0.0039	-0.004
23	0	correlation	-0.0003	-0.0045	-0.0042
24	0	correlation	-0.0024	-0.0024	0
25	0	correlation	-0.0011	-0.0024	-0.0013

TID vs Post - Pre Exposure Delta

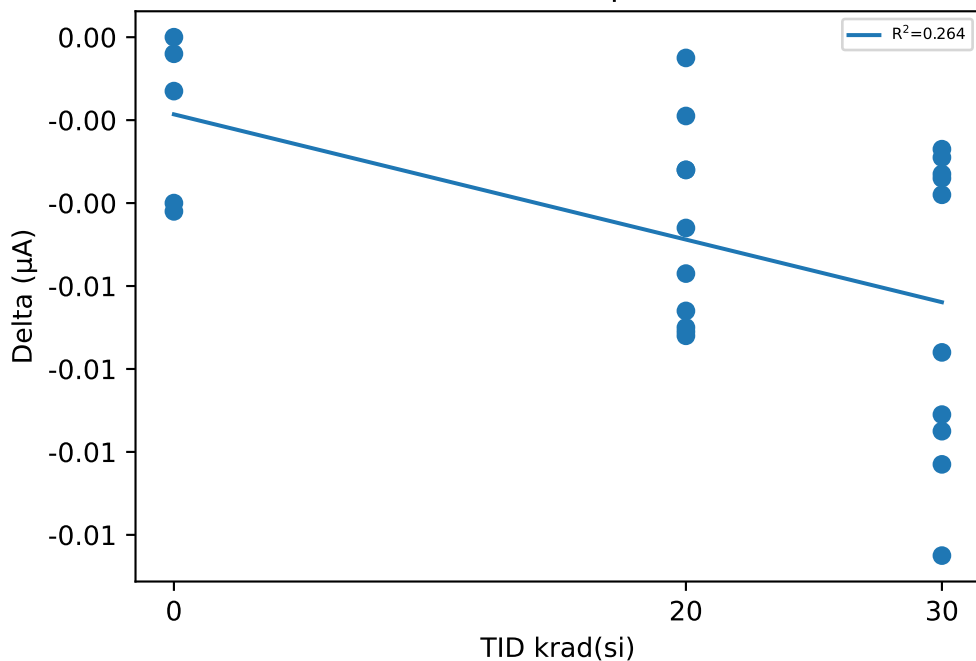

Test Statistics (µA)

krad(si)	Pre Exposure Min	Pre Exposure Avg	Pre Exposure Max	Pre Exposure Std	Post Exposure Min	Post Exposure Avg	Post Exposure Max	Post Exposure Std	Min Delta	Avg Delta	Max Delta	Std Delta
0	-0.0024	-0.0011	0.0001	0.001032	-0.0045	-0.00308	-0.0022	0.0010474	-0.0042	-0.00198	0	0.001993
20	-0.0042	-0.00157	0.0005	0.0014376	-0.0094	-0.00627	-0.0035	0.0024065	-0.0072	-0.0047	-0.0005	0.0024014
30	-0.002	-0.00097	0.0003	0.00082064	-0.0132	-0.00748	-0.0034	0.0033976	-0.0125	-0.00651	-0.0027	0.003681

Device Test: 5.29 UJ3WW2(IF3_5V_UJ3WW2)

TID vs Result Stats

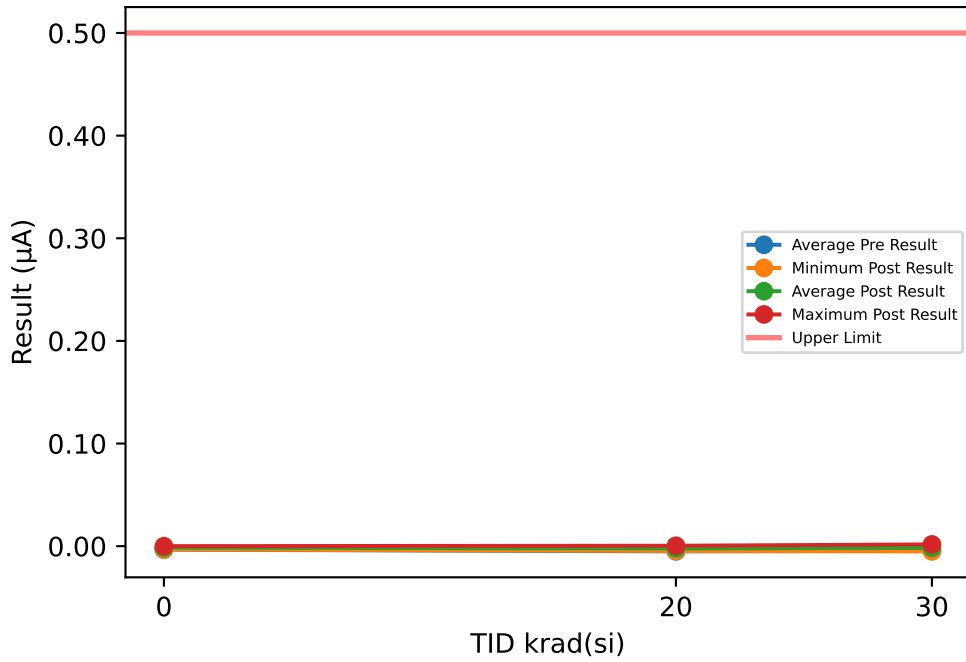

Test Results (Upper Limit = 0.5 (µA))

Serial #	krad(si)	Exposure Conditions	Pre Result	Post Result	Delta
1	20	HDR unbiased	-0.0008	-0.001	-0.0002
2	20	HDR unbiased	-0.0077	-0.002	0.0057
3	20	HDR unbiased	-0.0069	-0.0032	0.0037
4	20	HDR unbiased	-0.0041	0.0004	0.0045
5	20	HDR unbiased	-0.0024	-0.0036	-0.0012
6	20	HDR biased	-0.0086	-0.0012	0.0074
7	20	HDR biased	-0.0057	-0.0008	0.0049
8	20	HDR biased	-0.0065	-0.0016	0.0049
9	20	HDR biased	-0.0033	-0.0047	-0.0014
10	20	HDR biased	-0.0045	-0.0043	0.0002
11	30	HDR unbiased	-0.0035	-0.0014	0.0021
12	30	HDR unbiased	-0.0055	-0.0016	0.0039
13	30	HDR unbiased	-0.0018	0.0017	0.0035
14	30	HDR unbiased	-0.0041	-0.003	0.0011
15	30	HDR unbiased	-0.0073	0.0008	0.0081
16	30	HDR biased	-0.0014	-0.0038	-0.0024
17	30	HDR biased	-0.0067	-0.0006	0.0061
18	30	HDR biased	-0.0057	-0.001	0.0047
19	30	HDR biased	-0.0026	-0.0051	-0.0025
20	30	HDR biased	-0.0061	-0.0016	0.0045
21	0	correlation	-0.0018	0	0.0018
22	0	correlation	-0.0039	-0.0032	0.0007
23	0	correlation	-0.0041	-0.0002	0.0039
24	0	correlation	-0.0033	-0.0016	0.0017
25	0	correlation	-0.0037	-0.0018	0.0019

TID vs Post - Pre Exposure Delta

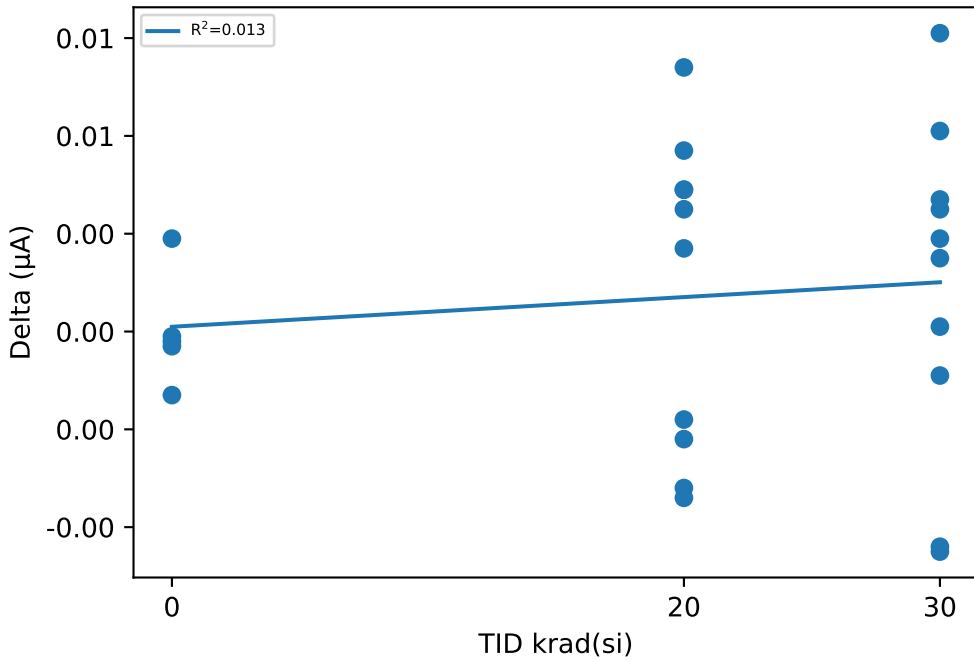

Test Statistics (µA)

krad(si)	Pre Exposure Min	Pre Exposure Avg	Pre Exposure Max	Pre Exposure Std	Post Exposure Min	Post Exposure Avg	Post Exposure Max	Post Exposure Std	Min Delta	Avg Delta	Max Delta	Std Delta
0	-0.0041	-0.00336	-0.0018	0.00092087	-0.0032	-0.00136	0	0.0013069	0.0007	0.002	0.0039	0.0011662
20	-0.0086	-0.00505	-0.0008	0.0024704	-0.0047	-0.0022	0.0004	0.0016727	-0.0014	0.00285	0.0074	0.0031879
30	-0.0073	-0.00447	-0.0014	0.0020907	-0.0051	-0.00156	0.0017	0.0020299	-0.0025	0.00291	0.0081	0.0034249

Device Test: 5.30 UJ3WW2(IF3_12V_UJ3WW2)

TID vs Result Stats

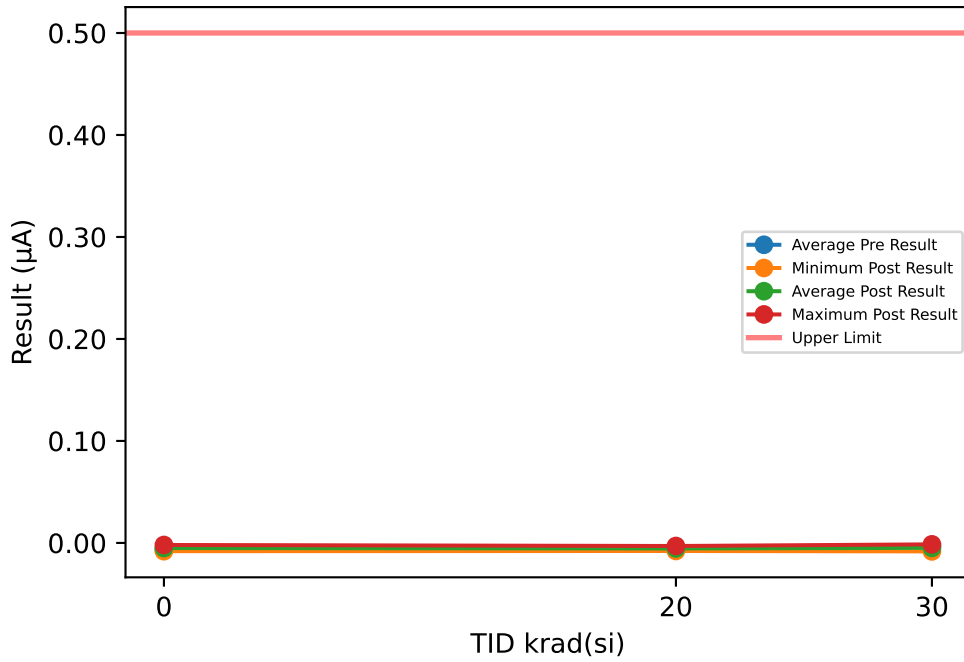

Test Results (Upper Limit = 0.5 (µA))

Serial #	krad(si)	Exposure Conditions	Pre Result	Post Result	Delta
1	20	HDR unbiased	-0.0043	-0.0041	0.0002
2	20	HDR unbiased	-0.0057	-0.0067	-0.001
3	20	HDR unbiased	-0.0055	-0.0079	-0.0024
4	20	HDR unbiased	-0.0053	-0.0061	-0.0008
5	20	HDR unbiased	-0.0047	-0.0071	-0.0024
6	20	HDR biased	-0.0039	-0.003	0.0009
7	20	HDR biased	-0.0057	-0.0034	0.0023
8	20	HDR biased	-0.0006	-0.0053	-0.0047
9	20	HDR biased	-0.002	-0.0057	-0.0037
10	20	HDR biased	-0.0045	-0.0049	-0.0004
11	30	HDR unbiased	-0.0026	-0.0034	-0.0008
12	30	HDR unbiased	-0.0024	-0.0083	-0.0059
13	30	HDR unbiased	-0.0041	-0.0049	-0.0008
14	30	HDR unbiased	-0.0014	-0.0069	-0.0055
15	30	HDR unbiased	-0.0022	-0.0049	-0.0027
16	30	HDR biased	-0.0051	-0.003	0.0021
17	30	HDR biased	-0.0033	-0.0014	0.0019
18	30	HDR biased	-0.0033	-0.0069	-0.0036
19	30	HDR biased	-0.002	-0.0026	-0.0006
20	30	HDR biased	-0.0055	-0.0061	-0.0006
21	0	correlation	-0.0081	-0.0081	0
22	0	correlation	-0.0041	-0.0075	-0.0034
23	0	correlation	-0.0067	-0.002	0.0047
24	0	correlation	-0.0055	-0.0034	0.0021
25	0	correlation	-0.0067	-0.0041	0.0026

TID vs Post - Pre Exposure Delta

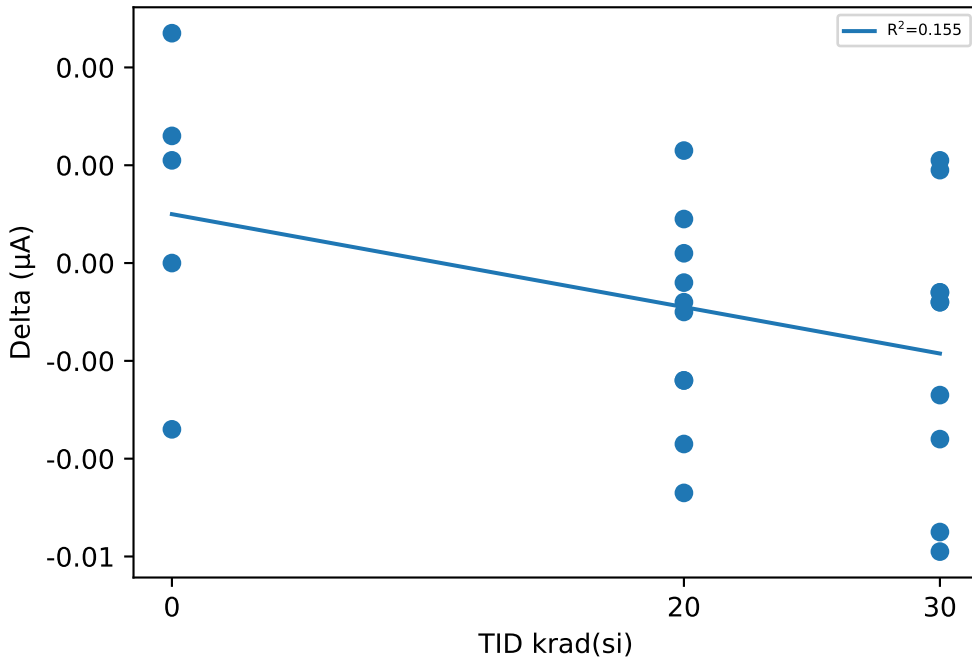

Test Statistics (µA)

krad(si)	Pre Exposure Min	Pre Exposure Avg	Pre Exposure Max	Pre Exposure Std	Post Exposure Min	Post Exposure Avg	Post Exposure Max	Post Exposure Std	Min Delta	Avg Delta	Max Delta	Std Delta
0	-0.0081	-0.00622	-0.0041	0.0015007	-0.0081	-0.00502	-0.002	0.0026565	-0.0034	0.0012	0.0047	0.0030668
20	-0.0057	-0.00422	-0.0006	0.0016877	-0.0079	-0.00542	-0.003	0.0016026	-0.0047	-0.0012	0.0023	0.0021302
30	-0.0055	-0.00319	-0.0014	0.0013503	-0.0083	-0.00484	-0.0014	0.0022202	-0.0059	-0.00165	0.0021	0.0027509

Device Test: 5.3 UJTKLS(Iop_28V_UJTKLS)

TID vs Result Stats

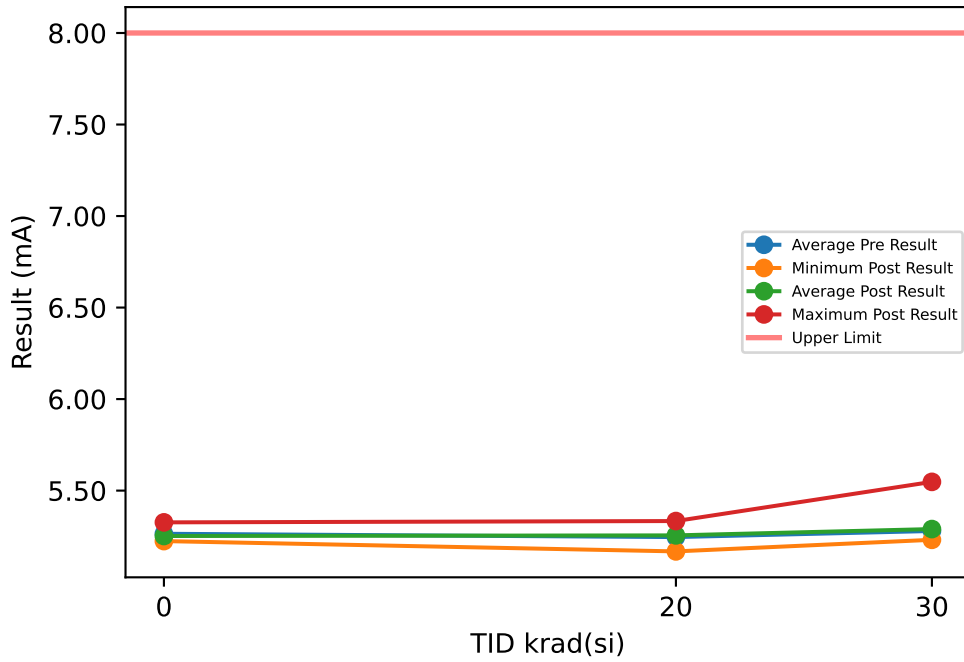

Test Results (Upper Limit = 8.0 (mA))

Serial #	krad(si)	Exposure Conditions	Pre Result	Post Result	Delta
1	20	HDR unbiased	5.284	5.2864	0.0024
2	20	HDR unbiased	5.2809	5.2667	-0.0142
3	20	HDR unbiased	5.2564	5.2669	0.0105
4	20	HDR unbiased	5.3031	5.301	-0.0021
5	20	HDR unbiased	5.3337	5.3337	0
6	20	HDR biased	5.2675	5.1679	-0.0996
7	20	HDR biased	5.188	5.2143	0.0263
8	20	HDR biased	5.1902	5.2176	0.0274
9	20	HDR biased	5.21	5.2178	0.0078
10	20	HDR biased	5.1477	5.2819	0.1342
11	30	HDR unbiased	5.5579	5.5477	-0.0102
12	30	HDR unbiased	5.2254	5.2312	0.0058
13	30	HDR unbiased	5.2336	5.2343	0.0007
14	30	HDR unbiased	5.2046	5.249	0.0444
15	30	HDR unbiased	5.2881	5.2753	-0.0128
16	30	HDR biased	5.2638	5.2873	0.0235
17	30	HDR biased	5.2133	5.2369	0.0236
18	30	HDR biased	5.3144	5.2975	-0.0169
19	30	HDR biased	5.2406	5.2406	0
20	30	HDR biased	5.2521	5.2988	0.0467
21	0	correlation	5.25	5.2398	-0.0102
22	0	correlation	5.2494	5.2359	-0.0135
23	0	correlation	5.2389	5.2242	-0.0147
24	0	correlation	5.3378	5.3265	-0.0113
25	0	correlation	5.2449	5.2336	-0.0113

TID vs Post - Pre Exposure Delta

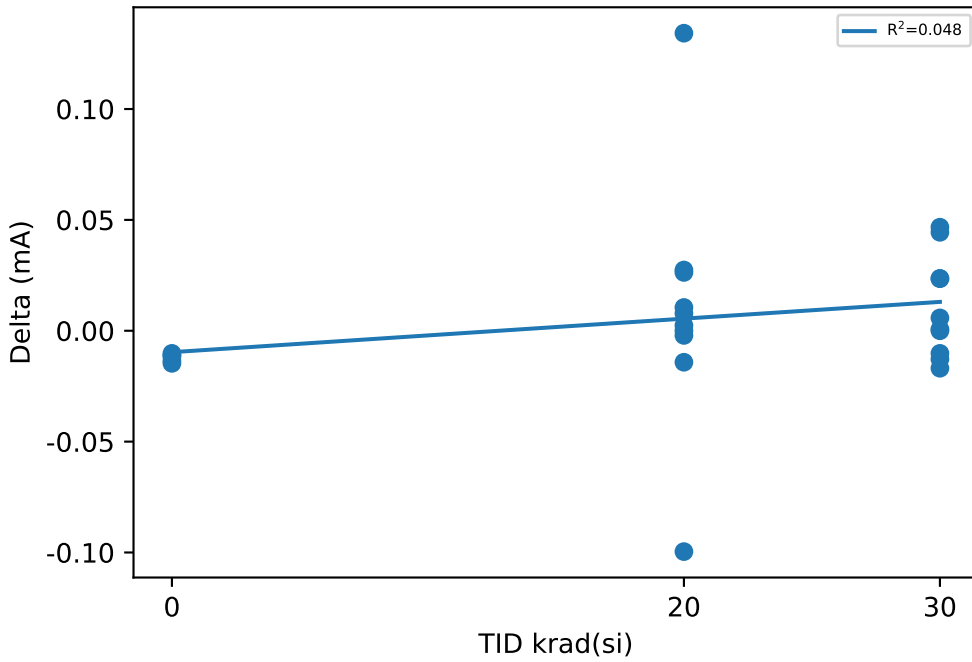

Test Statistics (mA)

krad(si)	Pre Exposure Min	Pre Exposure Avg	Pre Exposure Max	Pre Exposure Std	Post Exposure Min	Post Exposure Avg	Post Exposure Max	Post Exposure Std	Min Delta	Avg Delta	Max Delta	Std Delta
0	5.2389	5.2642	5.3378	0.041383	5.2242	5.252	5.3265	0.042041	-0.0147	-0.0122	-0.0102	0.0018412
20	5.1477	5.2462	5.3337	0.059274	5.1679	5.2554	5.3337	0.049801	-0.0996	0.00927	0.1342	0.056663
30	5.2046	5.2794	5.5579	0.10346	5.2312	5.2899	5.5477	0.094438	-0.0169	0.01048	0.0467	0.022975

Device Test: 5.31 UJ3WW2(IF3_28V_UJ3WW2)

TID vs Result Stats

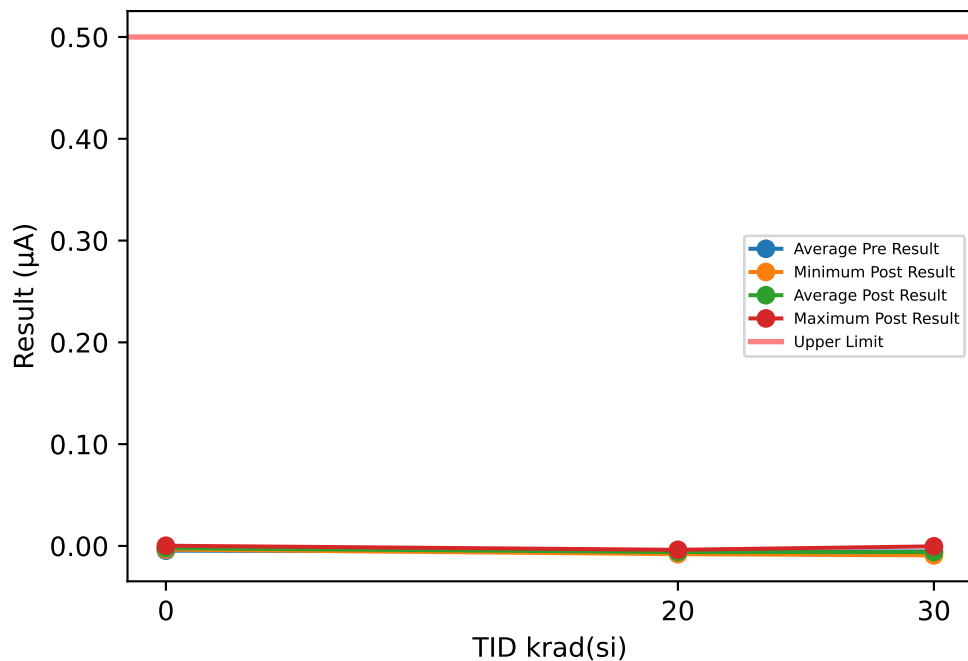

TID vs Post - Pre Exposure Delta

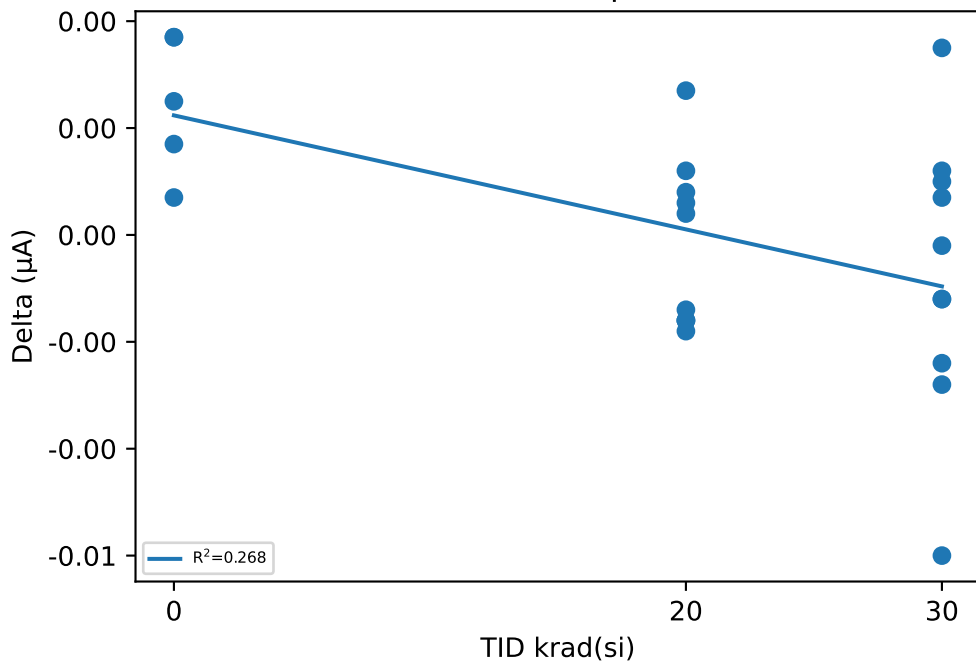

Test Results (Upper Limit = 0.5 (µA))

Serial #	krad(si)	Exposure Conditions	Pre Result	Post Result	Delta
1	20	HDR unbiased	-0.0049	-0.0065	-0.0016
2	20	HDR unbiased	-0.0053	-0.0045	0.0008
3	20	HDR unbiased	-0.0033	-0.0047	-0.0014
4	20	HDR unbiased	-0.0081	-0.0075	0.0006
5	20	HDR unbiased	-0.0063	-0.0079	-0.0016
6	20	HDR biased	-0.0057	-0.0053	0.0004
7	20	HDR biased	-0.0065	-0.0038	0.0027
8	20	HDR biased	-0.0063	-0.0081	-0.0018
9	20	HDR biased	-0.0051	-0.0067	-0.0016
10	20	HDR biased	-0.0065	-0.0053	0.0012
11	30	HDR unbiased	-0.0061	-0.0063	-0.0002
12	30	HDR unbiased	-0.0039	-0.0004	0.0035
13	30	HDR unbiased	-0.0037	-0.003	0.0007
14	30	HDR unbiased	-0.0061	-0.0051	0.001
15	30	HDR unbiased	-0.0045	-0.0057	-0.0012
16	30	HDR biased	-0.0077	-0.0065	0.0012
17	30	HDR biased	-0.0053	-0.0081	-0.0028
18	30	HDR biased	-0.0065	-0.0089	-0.0024
19	30	HDR biased	-0.0063	-0.0075	-0.0012
20	30	HDR biased	-0.0033	-0.0093	-0.006
21	0	correlation	-0.0035	-0.001	0.0025
22	0	correlation	-0.0073	-0.0036	0.0037
23	0	correlation	-0.0049	-0.0032	0.0017
24	0	correlation	-0.0035	0.0002	0.0037
25	0	correlation	-0.0041	-0.0034	0.0007

Test Statistics (µA)

krad(si)	Pre Exposure Min	Pre Exposure Avg	Pre Exposure Max	Pre Exposure Std	Post Exposure Min	Post Exposure Avg	Post Exposure Max	Post Exposure Std	Min Delta	Avg Delta	Max Delta	Std Delta
0	-0.0073	-0.00466	-0.0035	0.0015837	-0.0036	-0.0022	0.0002	0.0017029	0.0007	0.00246	0.0037	0.0012992
20	-0.0081	-0.0058	-0.0033	0.0012728	-0.0081	-0.00603	-0.0038	0.0015188	-0.0018	-0.00023	0.0027	0.001572
30	-0.0077	-0.00534	-0.0033	0.0014385	-0.0093	-0.00608	-0.0004	0.0027385	-0.006	-0.00074	0.0035	0.0026294

Device Test: 5.32 UJ3WW2(IF3_32V_UJ3WW2)

TID vs Result Stats

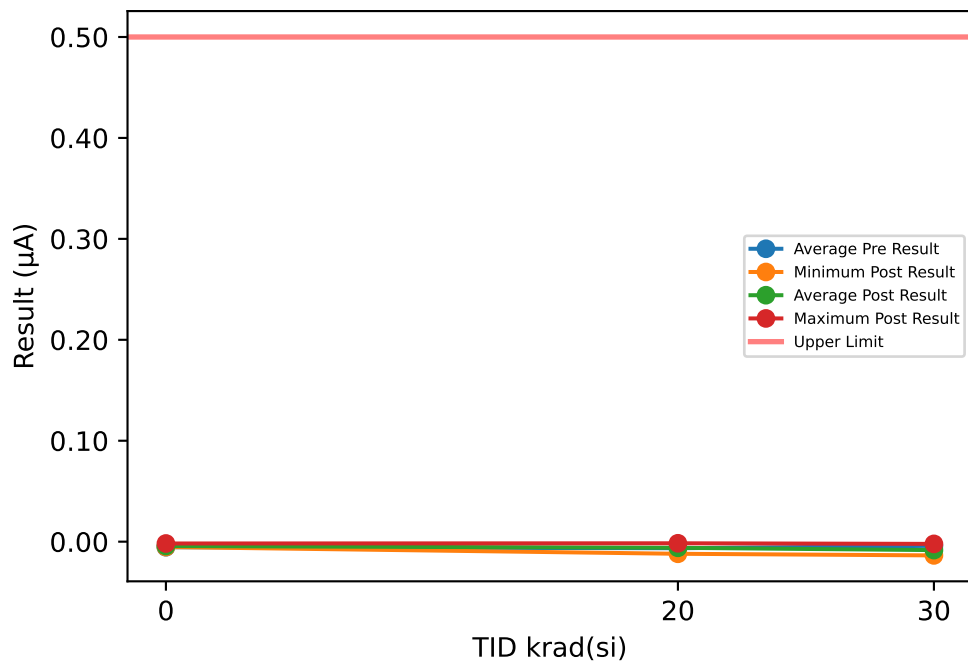

Test Results (Upper Limit = 0.5 (µA))

Serial #	krad(si)	Exposure Conditions	Pre Result	Post Result	Delta
1	20	HDR unbiased	-0.0092	-0.0026	0.0066
2	20	HDR unbiased	-0.0083	-0.0041	0.0042
3	20	HDR unbiased	-0.0039	-0.0016	0.0023
4	20	HDR unbiased	-0.0067	-0.0071	-0.0004
5	20	HDR unbiased	-0.0079	-0.0045	0.0034
6	20	HDR biased	-0.0049	-0.0081	-0.0032
7	20	HDR biased	-0.0059	-0.0069	-0.001
8	20	HDR biased	-0.0043	-0.0085	-0.0042
9	20	HDR biased	-0.0077	-0.012	-0.0043
10	20	HDR biased	-0.0063	-0.0055	0.0008
11	30	HDR unbiased	-0.0063	-0.0061	0.0002
12	30	HDR unbiased	-0.0027	-0.0085	-0.0058
13	30	HDR unbiased	-0.0031	-0.0022	0.0009
14	30	HDR unbiased	-0.0051	-0.0034	0.0017
15	30	HDR unbiased	-0.0059	-0.0049	0.001
16	30	HDR biased	-0.0077	-0.0093	-0.0016
17	30	HDR biased	-0.0022	-0.0134	-0.0112
18	30	HDR biased	-0.0027	-0.0136	-0.0109
19	30	HDR biased	-0.0026	-0.011	-0.0084
20	30	HDR biased	-0.0026	-0.0112	-0.0086
21	0	correlation	-0.012	-0.0049	0.0071
22	0	correlation	-0.0035	-0.0053	-0.0018
23	0	correlation	-0.0045	-0.0053	-0.0008
24	0	correlation	-0.0033	-0.0018	0.0015
25	0	correlation	-0.0041	-0.0043	-0.0002

TID vs Post - Pre Exposure Delta

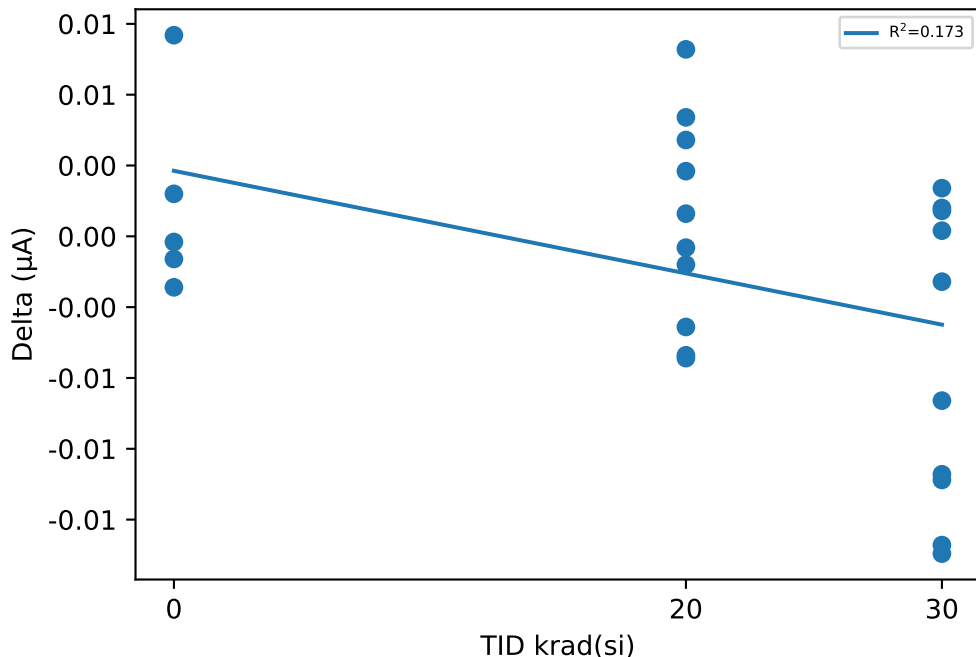

Test Statistics (µA)

krad(si)	Pre Exposure Min	Pre Exposure Avg	Pre Exposure Max	Pre Exposure Std	Post Exposure Min	Post Exposure Avg	Post Exposure Max	Post Exposure Std	Min Delta	Avg Delta	Max Delta	Std Delta
0	-0.012	-0.00548	-0.0033	0.0036759	-0.0053	-0.00432	-0.0018	0.001467	-0.0018	0.00116	0.0071	0.0035303
20	-0.0092	-0.00651	-0.0039	0.0017804	-0.012	-0.00609	-0.0016	0.0030845	-0.0043	0.00042	0.0066	0.0037187
30	-0.0077	-0.00409	-0.0022	0.001974	-0.0136	-0.00836	-0.0022	0.004061	-0.0112	-0.00427	0.0017	0.0052428

Device Test: 5.33 UJ3WW2(IF4_5V_UJ3WW2)

TID vs Result Stats

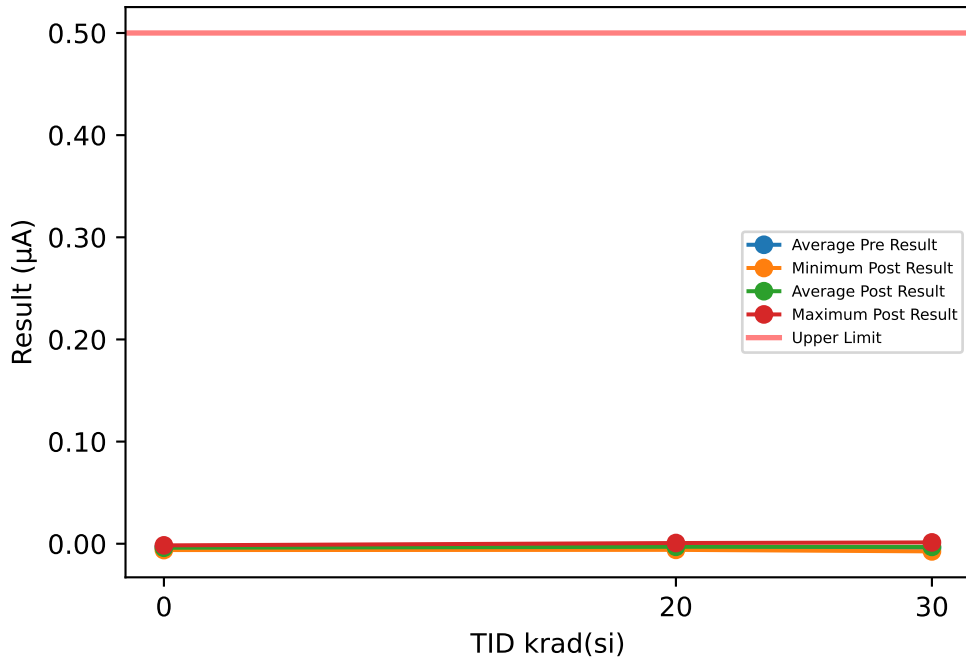

Test Results (Upper Limit = 0.5 (µA))

Serial #	krad(si)	Exposure Conditions	Pre Result	Post Result	Delta
1	20	HDR unbiased	-0.0009	-0.0046	-0.0037
2	20	HDR unbiased	-0.0044	-0.0016	0.0028
3	20	HDR unbiased	-0.0068	-0.006	0.0008
4	20	HDR unbiased	-0.0058	0.0007	0.0065
5	20	HDR unbiased	-0.0056	-0.0028	0.0028
6	20	HDR biased	-0.0021	-0.0026	-0.0005
7	20	HDR biased	-0.006	-0.0016	0.0044
8	20	HDR biased	-0.004	-0.0054	-0.0014
9	20	HDR biased	-0.0021	-0.005	-0.0029
10	20	HDR biased	-0.0017	-0.001	0.0007
11	30	HDR unbiased	-0.0034	-0.0034	0
12	30	HDR unbiased	-0.0025	-0.001	0.0015
13	30	HDR unbiased	-0.005	-0.003	0.002
14	30	HDR unbiased	-0.0027	-0.0075	-0.0048
15	30	HDR unbiased	-0.005	-0.0032	0.0018
16	30	HDR biased	-0.0042	0.0013	0.0055
17	30	HDR biased	-0.0025	-0.0042	-0.0017
18	30	HDR biased	-0.006	-0.0016	0.0044
19	30	HDR biased	-0.0072	-0.0038	0.0034
20	30	HDR biased	-0.0015	-0.0044	-0.0029
21	0	correlation	0.0019	-0.0028	-0.0047
22	0	correlation	-0.0017	-0.0016	0.0001
23	0	correlation	-0.0046	-0.0046	0
24	0	correlation	-0.0066	-0.0044	0.0022
25	0	correlation	-0.0044	-0.0062	-0.0018

TID vs Post - Pre Exposure Delta

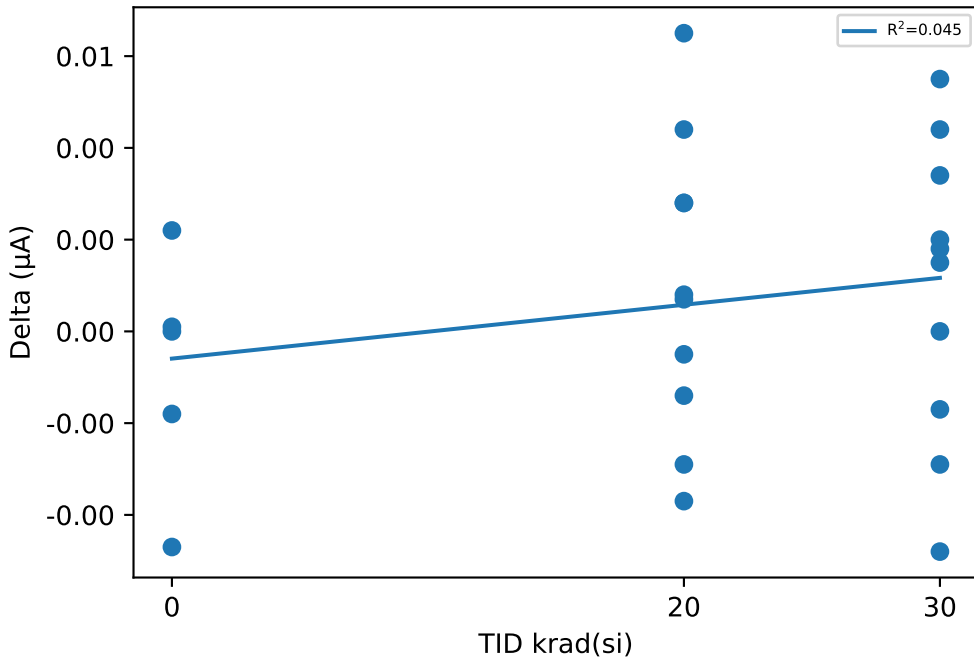

Test Statistics (µA)

krad(si)	Pre Exposure Min	Pre Exposure Avg	Pre Exposure Max	Pre Exposure Std	Post Exposure Min	Post Exposure Avg	Post Exposure Max	Post Exposure Std	Min Delta	Avg Delta	Max Delta	Std Delta
0	-0.0066	-0.00308	0.0019	0.0032844	-0.0062	-0.00392	-0.0016	0.0017697	-0.0047	-0.00084	0.0022	0.0025813
20	-0.0068	-0.00394	-0.0009	0.0021051	-0.006	-0.00299	0.0007	0.0021891	-0.0037	0.00095	0.0065	0.0032267
30	-0.0072	-0.004	-0.0015	0.0017975	-0.0075	-0.00308	0.0013	0.0023304	-0.0048	0.00092	0.0055	0.0032751

Device Test: 5.34 UJ3WW2(IF4_12V_UJ3WW2)

TID vs Result Stats

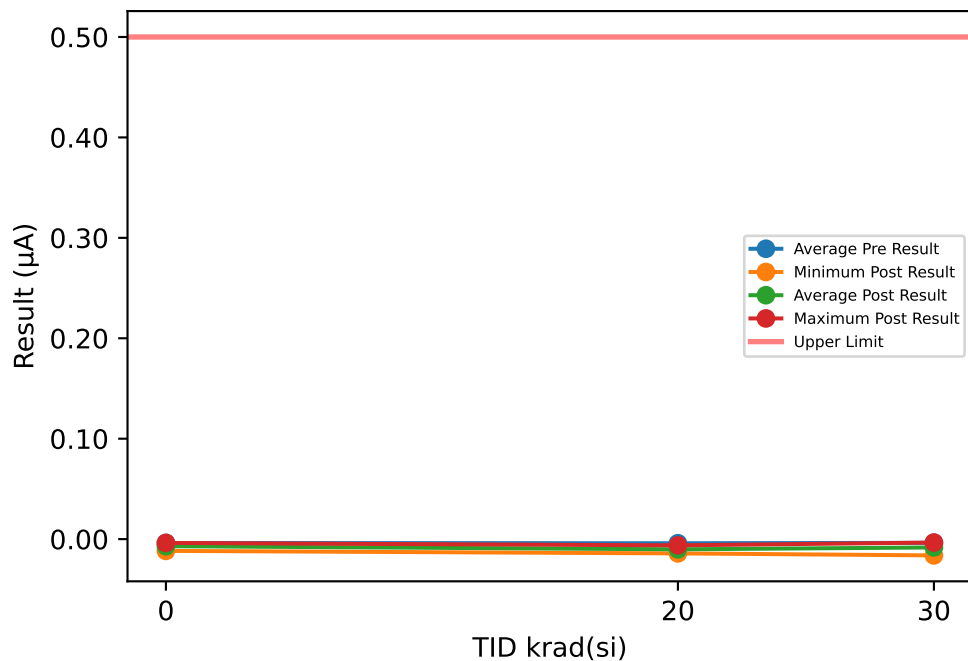

TID vs Post - Pre Exposure Delta

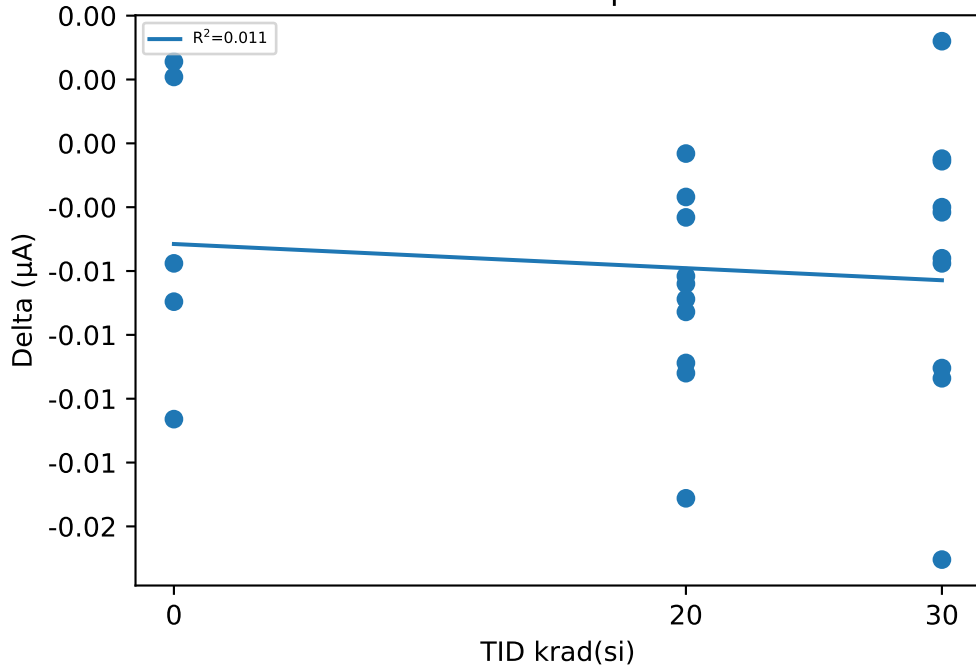

Test Results (Upper Limit = 0.5 (µA))

Serial #	krad(si)	Exposure Conditions	Pre Result	Post Result	Delta
1	20	HDR unbiased	-0.0046	-0.0107	-0.0061
2	20	HDR unbiased	-0.0052	-0.0118	-0.0066
3	20	HDR unbiased	-0.0058	-0.0062	-0.0004
4	20	HDR unbiased	-0.0058	-0.0113	-0.0055
5	20	HDR unbiased	-0.0054	-0.0075	-0.0021
6	20	HDR biased	-0.0003	-0.0142	-0.0139
7	20	HDR biased	-0.0038	-0.0124	-0.0086
8	20	HDR biased	0.0017	-0.0073	-0.009
9	20	HDR biased	-0.0042	-0.0071	-0.0029
10	20	HDR biased	-0.0078	-0.013	-0.0052
11	30	HDR unbiased	-0.004	-0.0087	-0.0047
12	30	HDR unbiased	-0.0046	-0.0052	-0.0006
13	30	HDR unbiased	-0.0025	-0.0052	-0.0027
14	30	HDR unbiased	-0.0005	-0.0097	-0.0092
15	30	HDR unbiased	0.0001	-0.0162	-0.0163
16	30	HDR biased	-0.0029	-0.0117	-0.0088
17	30	HDR biased	-0.0064	-0.0109	-0.0045
18	30	HDR biased	-0.0023	-0.0048	-0.0025
19	30	HDR biased	-0.0074	-0.0034	0.004
20	30	HDR biased	-0.0064	-0.0071	-0.0007
21	0	correlation	-0.0064	-0.0038	0.0026
22	0	correlation	-0.0005	-0.0067	-0.0062
23	0	correlation	-0.003	-0.0077	-0.0047
24	0	correlation	-0.0009	-0.0117	-0.0108
25	0	correlation	-0.0084	-0.0052	0.0032

Test Statistics (µA)

krad(si)	Pre Exposure Min	Pre Exposure Avg	Pre Exposure Max	Pre Exposure Std	Post Exposure Min	Post Exposure Avg	Post Exposure Max	Post Exposure Std	Min Delta	Avg Delta	Max Delta	Std Delta
0	-0.0084	-0.00384	-0.0005	0.0034588	-0.0117	-0.00702	-0.0038	0.0030062	-0.0108	-0.00318	0.0032	0.0059918
20	-0.0078	-0.00412	0.0017	0.0028047	-0.0142	-0.01015	-0.0062	0.0028672	-0.0139	-0.00603	-0.0004	0.0038816
30	-0.0074	-0.00369	0.0001	0.0025362	-0.0162	-0.00829	-0.0034	0.0039408	-0.0163	-0.0046	0.004	0.0056657

Device Test: 5.35 UJ3WW2(IF4_28V_UJ3WW2)

TID vs Result Stats

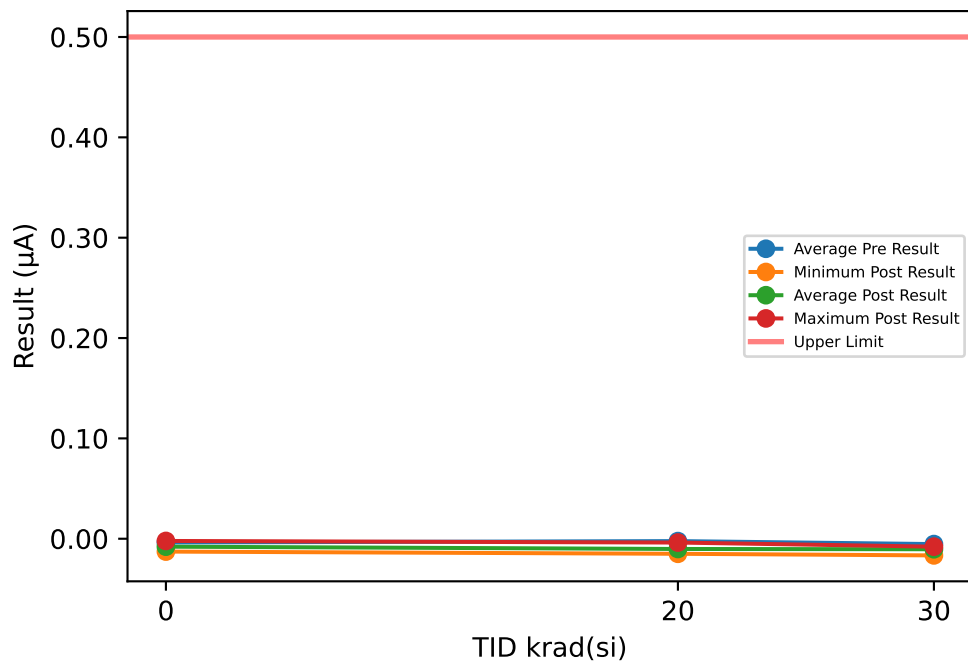

Test Results (Upper Limit = 0.5 (µA))

Serial #	krad(si)	Exposure Conditions	Pre Result	Post Result	Delta
1	20	HDR unbiased	0.0011	-0.0101	-0.0112
2	20	HDR unbiased	-0.0009	-0.0038	-0.0029
3	20	HDR unbiased	-0.0017	-0.0101	-0.0084
4	20	HDR unbiased	-0.0003	-0.015	-0.0147
5	20	HDR unbiased	-0.0046	-0.0089	-0.0043
6	20	HDR biased	-0.0066	-0.0126	-0.006
7	20	HDR biased	-0.0032	-0.0083	-0.0051
8	20	HDR biased	0.0009	-0.0075	-0.0084
9	20	HDR biased	-0.0052	-0.0148	-0.0096
10	20	HDR biased	-0.003	-0.0109	-0.0079
11	30	HDR unbiased	-0.0052	-0.0079	-0.0027
12	30	HDR unbiased	-0.0088	-0.0101	-0.0013
13	30	HDR unbiased	-0.0036	-0.0093	-0.0057
14	30	HDR unbiased	-0.0056	-0.0091	-0.0035
15	30	HDR unbiased	-0.0089	-0.0085	0.0004
16	30	HDR biased	-0.0029	-0.0111	-0.0082
17	30	HDR biased	-0.0038	-0.0101	-0.0063
18	30	HDR biased	-0.0064	-0.0166	-0.0102
19	30	HDR biased	-0.0046	-0.012	-0.0074
20	30	HDR biased	-0.0034	-0.0101	-0.0067
21	0	correlation	-0.0034	-0.0022	0.0012
22	0	correlation	-0.0013	-0.0085	-0.0072
23	0	correlation	-0.0056	-0.0067	-0.0011
24	0	correlation	-0.0003	-0.0093	-0.009
25	0	correlation	-0.008	-0.0128	-0.0048

TID vs Post - Pre Exposure Delta

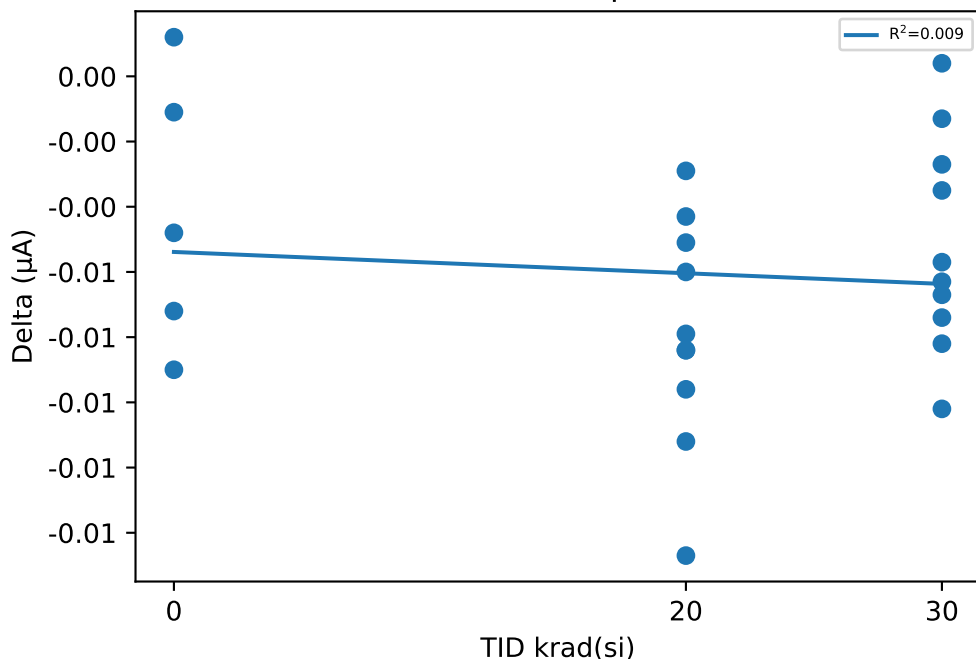

Test Statistics (µA)

krad(si)	Pre Exposure Min	Pre Exposure Avg	Pre Exposure Max	Pre Exposure Std	Post Exposure Min	Post Exposure Avg	Post Exposure Max	Post Exposure Std	Min Delta	Avg Delta	Max Delta	Std Delta
0	-0.008	-0.00372	-0.0003	0.0031428	-0.0128	-0.0079	-0.0022	0.0038814	-0.009	-0.00418	0.0012	0.0042181
20	-0.0066	-0.00235	0.0011	0.0026159	-0.015	-0.0102	-0.0038	0.0033997	-0.0147	-0.00785	-0.0029	0.0034945
30	-0.0089	-0.00532	-0.0029	0.0021478	-0.0166	-0.01048	-0.0079	0.0024598	-0.0102	-0.00516	0.0004	0.0033039

Device Test: 5.36 UJ3WW2(IF4_32V_UJ3WW2)

TID vs Result Stats

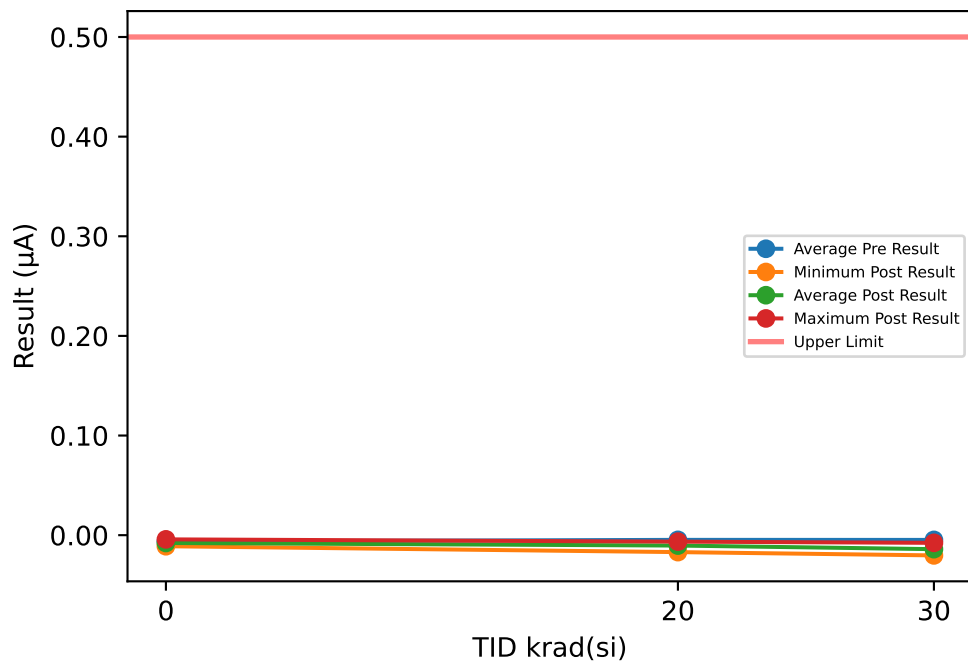

TID vs Post - Pre Exposure Delta

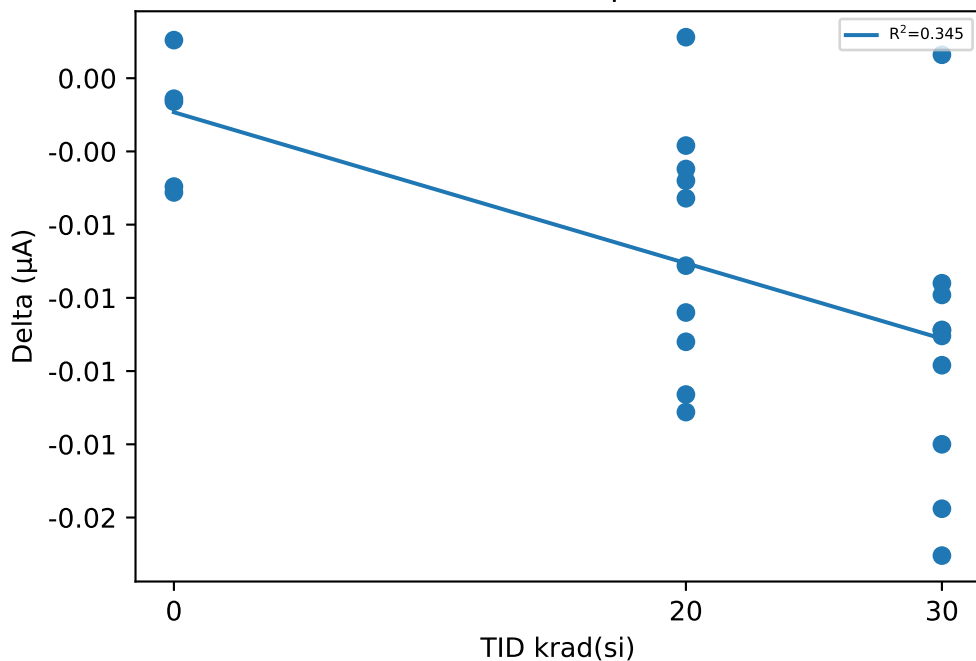

Test Results (Upper Limit = 0.5 (µA))

Serial #	krad(si)	Exposure Conditions	Pre Result	Post Result	Delta
1	20	HDR unbiased	-0.0044	-0.0067	-0.0023
2	20	HDR unbiased	-0.0066	-0.0101	-0.0035
3	20	HDR unbiased	-0.0019	-0.0099	-0.008
4	20	HDR unbiased	-0.0091	-0.0077	0.0014
5	20	HDR unbiased	-0.0034	-0.0065	-0.0031
6	20	HDR biased	-0.003	-0.0138	-0.0108
7	20	HDR biased	-0.0056	-0.017	-0.0114
8	20	HDR biased	-0.0056	-0.0097	-0.0041
9	20	HDR biased	-0.0054	-0.0144	-0.009
10	20	HDR biased	-0.0021	-0.0085	-0.0064
11	30	HDR unbiased	-0.0042	-0.0128	-0.0086
12	30	HDR unbiased	-0.0029	-0.0103	-0.0074
13	30	HDR unbiased	-0.0007	-0.0077	-0.007
14	30	HDR unbiased	-0.0093	-0.0085	0.0008
15	30	HDR unbiased	-0.0066	-0.0152	-0.0086
16	30	HDR biased	-0.0032	-0.0179	-0.0147
17	30	HDR biased	-0.004	-0.0203	-0.0163
18	30	HDR biased	-0.0066	-0.0154	-0.0088
19	30	HDR biased	-0.004	-0.0138	-0.0098
20	30	HDR biased	-0.006	-0.0185	-0.0125
21	0	correlation	-0.0034	-0.0042	-0.0008
22	0	correlation	-0.0074	-0.0111	-0.0037
23	0	correlation	-0.005	-0.0089	-0.0039
24	0	correlation	-0.008	-0.0067	0.0013
25	0	correlation	-0.0076	-0.0083	-0.0007

Test Statistics (µA)

krad(si)	Pre Exposure Min	Pre Exposure Avg	Pre Exposure Max	Pre Exposure Std	Post Exposure Min	Post Exposure Avg	Post Exposure Max	Post Exposure Std	Min Delta	Avg Delta	Max Delta	Std Delta
0	-0.008	-0.00628	-0.0034	0.001993	-0.0111	-0.00784	-0.0042	0.0025745	-0.0039	-0.00156	0.0013	0.0022109
20	-0.0091	-0.00471	-0.0019	0.0022198	-0.017	-0.01043	-0.0065	0.0035236	-0.0114	-0.00572	0.0014	0.0041001
30	-0.0093	-0.00475	-0.0007	0.0024213	-0.0203	-0.01404	-0.0077	0.0042641	-0.0163	-0.00929	0.0008	0.0047233

Device Test: 5.37 UJXYSN(loutleak_5V_UJXYSN)

TID vs Result Stats

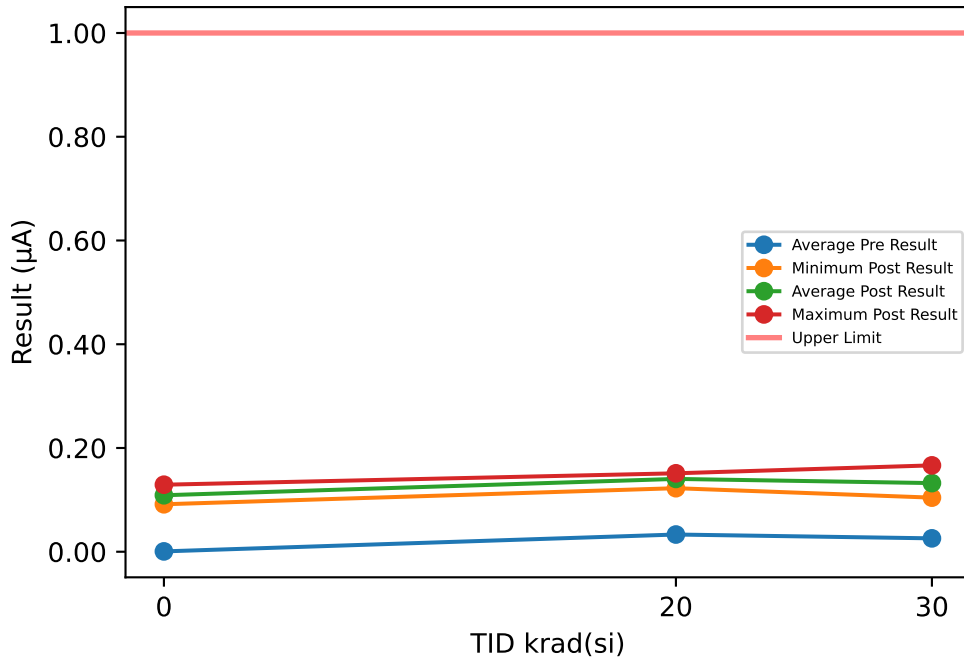

Test Results (Upper Limit = 1.0 (µA))

Serial #	krad(si)	Exposure Conditions	Pre Result	Post Result	Delta
1	20	HDR unbiased	0.0615	0.1512	0.0897
2	20	HDR unbiased	0.0124	0.14	0.1276
3	20	HDR unbiased	0.0336	0.1284	0.0948
4	20	HDR unbiased	0.0419	0.1225	0.0806
5	20	HDR unbiased	0.0186	0.1361	0.1175
6	20	HDR biased	0.0296	0.1421	0.1125
7	20	HDR biased	0.0383	0.1512	0.1129
8	20	HDR biased	0.0798	0.1435	0.0637
9	20	HDR biased	0.0086	0.1412	0.1326
10	20	HDR biased	0.0076	0.1477	0.1401
11	30	HDR unbiased	0.028	0.1183	0.0903
12	30	HDR unbiased	0.0265	0.1168	0.0903
13	30	HDR unbiased	0.0478	0.1544	0.1066
14	30	HDR unbiased	0.0145	0.1427	0.1282
15	30	HDR unbiased	0.0491	0.1189	0.0698
16	30	HDR biased	0.0396	0.1043	0.0647
17	30	HDR biased	0.0253	0.1665	0.1412
18	30	HDR biased	0.0013	0.1421	0.1408
19	30	HDR biased	-0.0177	0.1266	0.1443
20	30	HDR biased	0.0438	0.1327	0.0889
21	0	correlation	0.0232	0.1141	0.0909
22	0	correlation	-0.0246	0.1032	0.1278
23	0	correlation	0.0016	0.1292	0.1276
24	0	correlation	-0.017	0.0915	0.1085
25	0	correlation	0.0201	0.1064	0.0863

TID vs Post - Pre Exposure Delta

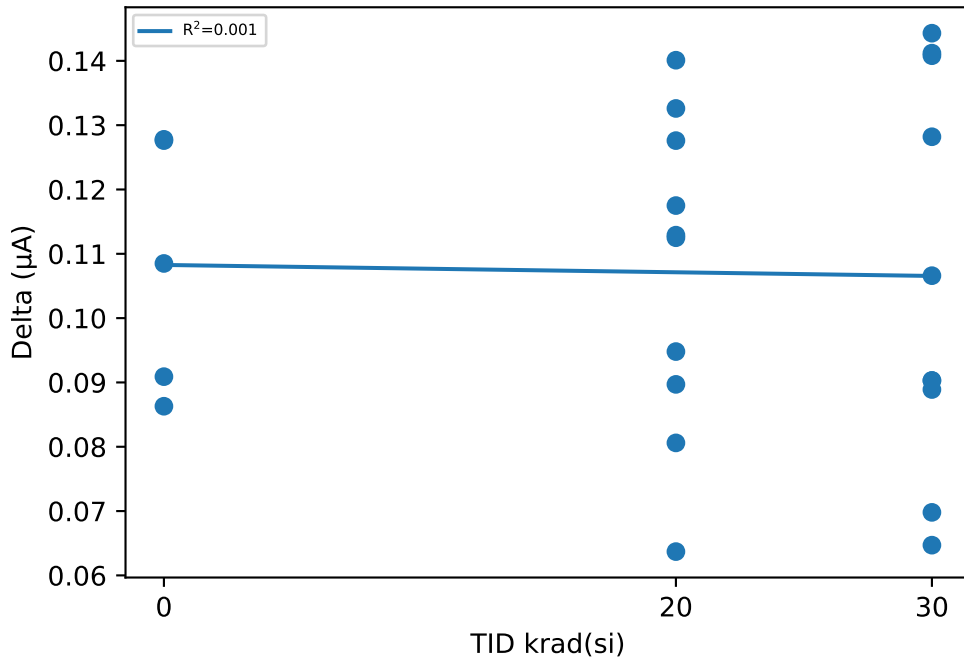

Test Statistics (µA)

krad(si)	Pre Exposure Min	Pre Exposure Avg	Pre Exposure Max	Pre Exposure Std	Post Exposure Min	Post Exposure Avg	Post Exposure Max	Post Exposure Std	Min Delta	Avg Delta	Max Delta	Std Delta
0	-0.0246	0.00066	0.0232	0.021429	0.0915	0.10888	0.1292	0.01397	0.0863	0.10822	0.1278	0.019618
20	0.0076	0.03319	0.0798	0.023555	0.1225	0.14039	0.1512	0.009326	0.0637	0.1072	0.1401	0.024427
30	-0.0177	0.02582	0.0491	0.021518	0.1043	0.13233	0.1665	0.019133	0.0647	0.10651	0.1443	0.030201

Device Test: 5.38 UJXYSN(loutleak_12V_UJXYSN)

TID vs Result Stats

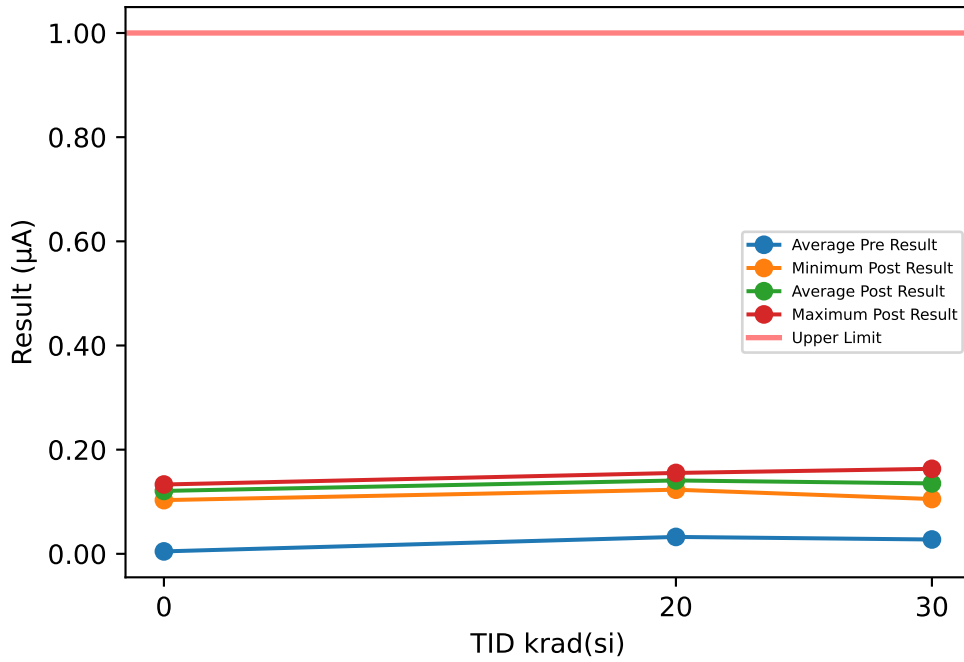

Test Results (Upper Limit = 1.0 (µA))

Serial #	krad(si)	Exposure Conditions	Pre Result	Post Result	Delta
1	20	HDR unbiased	0.0558	0.1517	0.0959
2	20	HDR unbiased	0.0244	0.1231	0.0987
3	20	HDR unbiased	0.0265	0.1365	0.11
4	20	HDR unbiased	0.0241	0.1254	0.1013
5	20	HDR unbiased	0.0018	0.1407	0.1389
6	20	HDR biased	0.0375	0.1541	0.1166
7	20	HDR biased	0.0448	0.1543	0.1095
8	20	HDR biased	0.0737	0.1442	0.0705
9	20	HDR biased	0.0194	0.1233	0.1039
10	20	HDR biased	0.0163	0.1553	0.139
11	30	HDR unbiased	0.018	0.1281	0.1101
12	30	HDR unbiased	0.0443	0.1133	0.069
13	30	HDR unbiased	0.0289	0.1557	0.1268
14	30	HDR unbiased	0.0158	0.1405	0.1247
15	30	HDR unbiased	0.057	0.119	0.062
16	30	HDR biased	0.0411	0.1052	0.0641
17	30	HDR biased	0.0003	0.1594	0.1591
18	30	HDR biased	0.0287	0.1632	0.1345
19	30	HDR biased	0.0065	0.1204	0.1139
20	30	HDR biased	0.0346	0.1472	0.1126
21	0	correlation	0.0398	0.1319	0.0921
22	0	correlation	-0.0117	0.1225	0.1342
23	0	correlation	0.001	0.1331	0.1321
24	0	correlation	-0.0131	0.1031	0.1162
25	0	correlation	0.0073	0.1132	0.1059

TID vs Post - Pre Exposure Delta

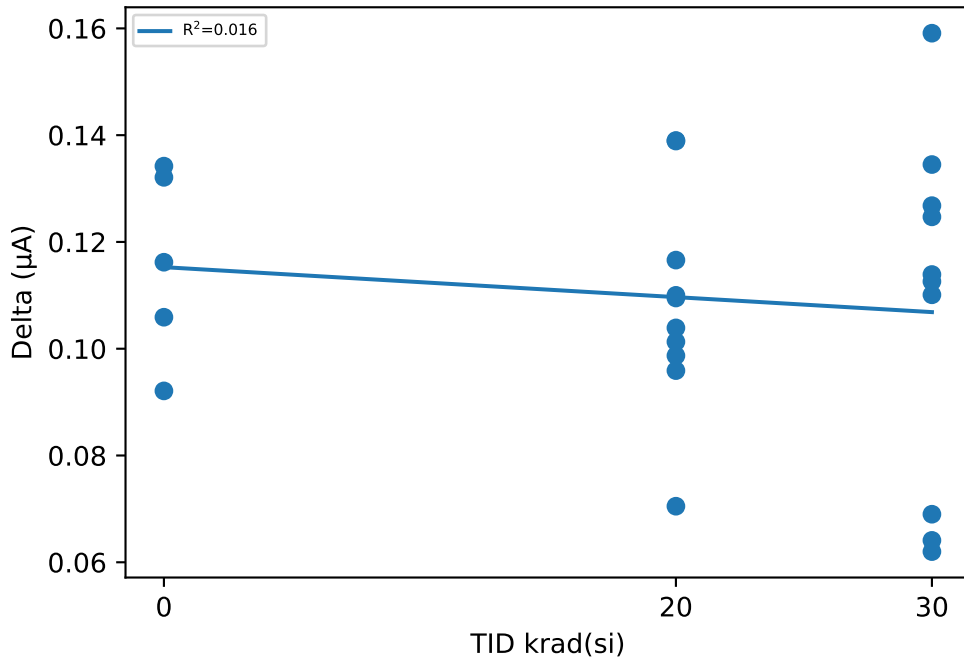

Test Statistics (µA)

krad(si)	Pre Exposure Min	Pre Exposure Avg	Pre Exposure Max	Pre Exposure Std	Post Exposure Min	Post Exposure Avg	Post Exposure Max	Post Exposure Std	Min Delta	Avg Delta	Max Delta	Std Delta
0	-0.0131	0.00466	0.0398	0.021437	0.1031	0.12076	0.1331	0.012732	0.0921	0.1161	0.1342	0.017774
20	0.0018	0.03243	0.0737	0.02099	0.1231	0.14086	0.1553	0.013228	0.0705	0.10843	0.139	0.020262
30	0.0003	0.02752	0.057	0.017636	0.1052	0.1352	0.1632	0.020746	0.062	0.10768	0.1591	0.032608

Device Test: 5.39 UJXYSN(loutleak_28V_UJXYSN)

TID vs Result Stats

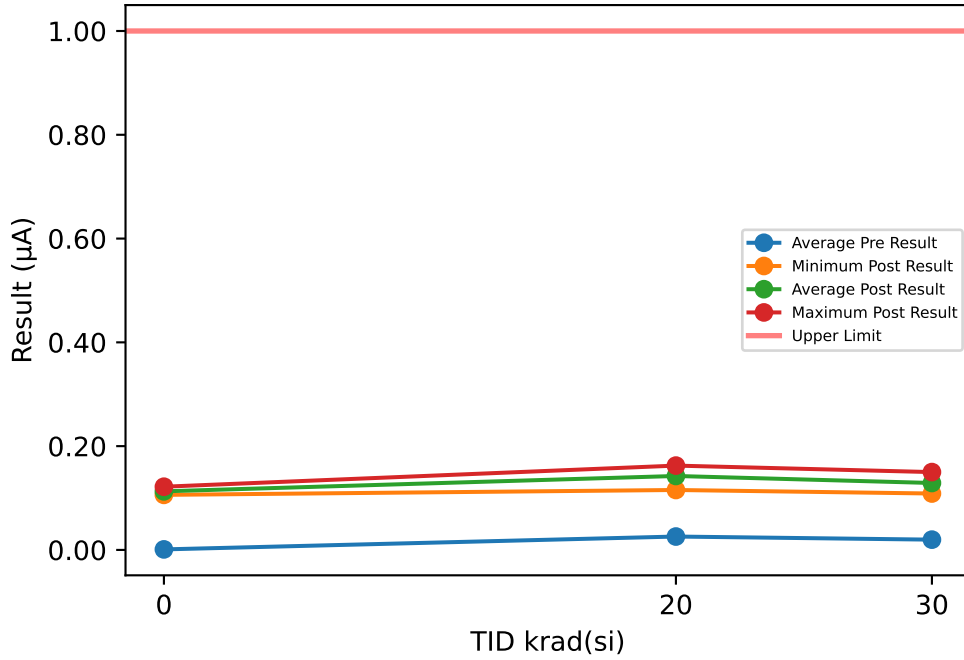

Test Results (Upper Limit = 1.0 (µA))

Serial #	krad(si)	Exposure Conditions	Pre Result	Post Result	Delta
1	20	HDR unbiased	0.0517	0.1622	0.1105
2	20	HDR unbiased	0.0137	0.1461	0.1324
3	20	HDR unbiased	0.0149	0.1449	0.13
4	20	HDR unbiased	0.0277	0.1259	0.0982
5	20	HDR unbiased	0.0048	0.1155	0.1107
6	20	HDR biased	0.0274	0.1347	0.1073
7	20	HDR biased	0.032	0.1625	0.1305
8	20	HDR biased	0.0612	0.1515	0.0903
9	20	HDR biased	0.0222	0.1248	0.1026
10	20	HDR biased	0.0024	0.157	0.1546
11	30	HDR unbiased	0.0118	0.1303	0.1185
12	30	HDR unbiased	0.0258	0.1159	0.0901
13	30	HDR unbiased	0.0293	0.1362	0.1069
14	30	HDR unbiased	0.0074	0.129	0.1216
15	30	HDR unbiased	0.0583	0.1143	0.056
16	30	HDR biased	0.0441	0.1087	0.0646
17	30	HDR biased	-0.0136	0.1267	0.1403
18	30	HDR biased	0.0253	0.15	0.1247
19	30	HDR biased	-0.0099	0.132	0.1419
20	30	HDR biased	0.0197	0.1468	0.1271
21	0	correlation	0.018	0.112	0.094
22	0	correlation	-0.0096	0.1178	0.1274
23	0	correlation	0.0003	0.1218	0.1215
24	0	correlation	-0.012	0.1061	0.1181
25	0	correlation	0.0084	0.1069	0.0985

TID vs Post - Pre Exposure Delta

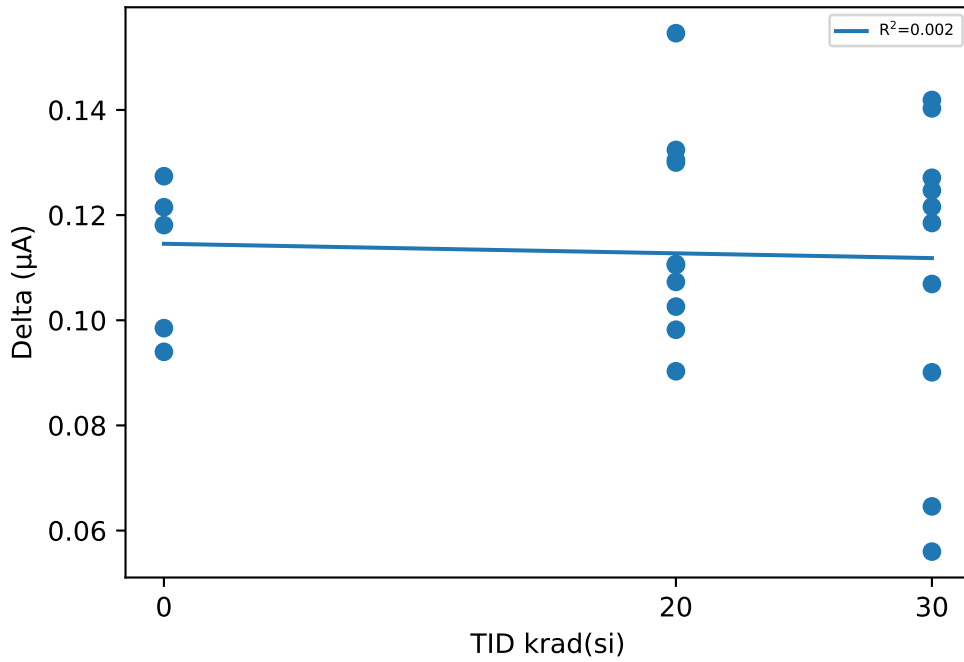

Test Statistics (µA)

krad(si)	Pre Exposure Min	Pre Exposure Avg	Pre Exposure Max	Pre Exposure Std	Post Exposure Min	Post Exposure Avg	Post Exposure Max	Post Exposure Std	Min Delta	Avg Delta	Max Delta	Std Delta
0	-0.012	0.00102	0.018	0.012506	0.1061	0.11292	0.1218	0.006824	0.094	0.1119	0.1274	0.014755
20	0.0024	0.0258	0.0612	0.01896	0.1155	0.14251	0.1625	0.016589	0.0903	0.11671	0.1546	0.019582
30	-0.0136	0.01982	0.0583	0.022223	0.1087	0.12899	0.15	0.013439	0.056	0.10917	0.1419	0.029864

Device Test: 5.4 UJTKLS(Iop_32V_UJTKLS)

TID vs Result Stats

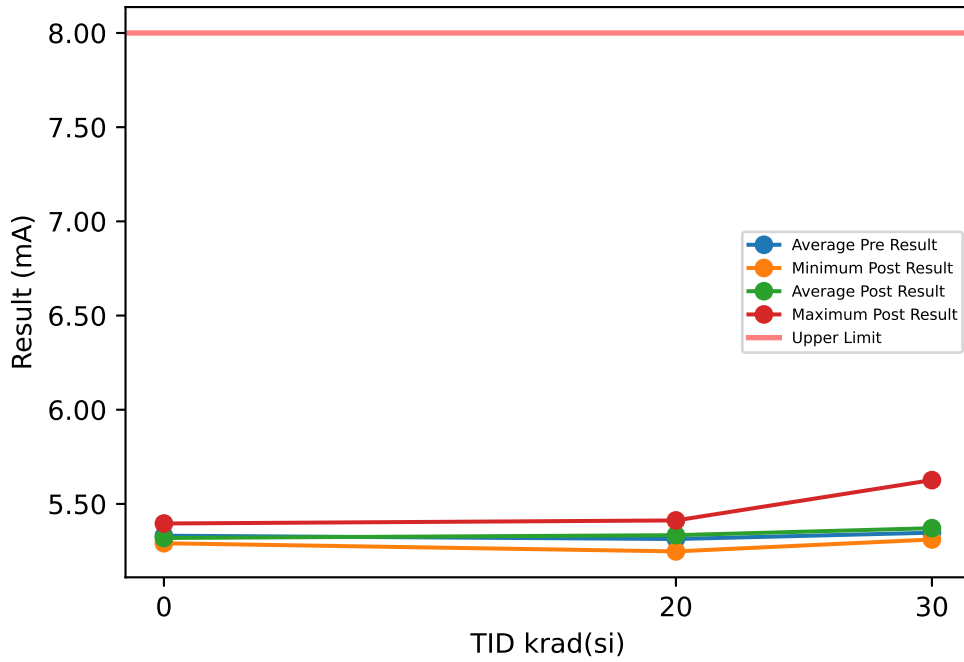

Test Results (Upper Limit = 8.0 (mA))

Serial #	krad(si)	Exposure Conditions	Pre Result	Post Result	Delta
1	20	HDR unbiased	5.3522	5.3604	0.0082
2	20	HDR unbiased	5.3493	5.3466	-0.0027
3	20	HDR unbiased	5.3216	5.3423	0.0207
4	20	HDR unbiased	5.3697	5.3787	0.009
5	20	HDR unbiased	5.404	5.4124	0.0084
6	20	HDR biased	5.3347	5.248	-0.0867
7	20	HDR biased	5.2562	5.2928	0.0366
8	20	HDR biased	5.2577	5.2998	0.0421
9	20	HDR biased	5.2794	5.2996	0.0202
10	20	HDR biased	5.2124	5.3606	0.1482
11	30	HDR unbiased	5.6235	5.6264	0.0029
12	30	HDR unbiased	5.2936	5.316	0.0224
13	30	HDR unbiased	5.3016	5.3111	0.0095
14	30	HDR unbiased	5.2745	5.3302	0.0557
15	30	HDR unbiased	5.3573	5.3559	-0.0014
16	30	HDR biased	5.3316	5.3682	0.0366
17	30	HDR biased	5.2788	5.3185	0.0397
18	30	HDR biased	5.3839	5.3805	-0.0034
19	30	HDR biased	5.309	5.3228	0.0138
20	30	HDR biased	5.3193	5.3832	0.0639
21	0	correlation	5.3154	5.306	-0.0094
22	0	correlation	5.3154	5.3035	-0.0119
23	0	correlation	5.3055	5.2912	-0.0143
24	0	correlation	5.4077	5.3961	-0.0116
25	0	correlation	5.3129	5.2992	-0.0137

TID vs Post - Pre Exposure Delta

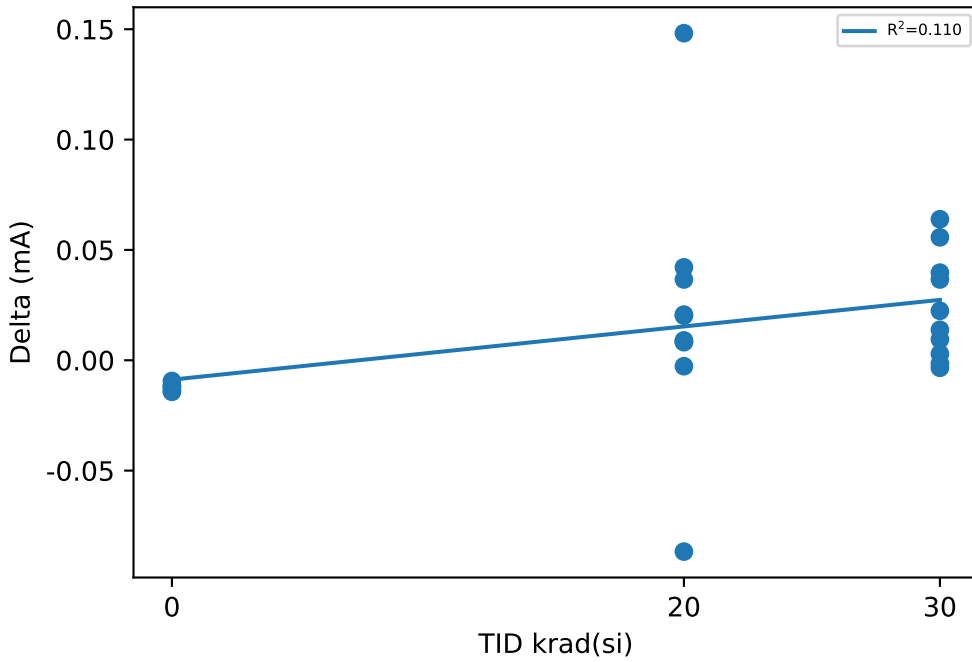

Test Statistics (mA)

krad(si)	Pre Exposure Min	Pre Exposure Avg	Pre Exposure Max	Pre Exposure Std	Post Exposure Min	Post Exposure Avg	Post Exposure Max	Post Exposure Std	Min Delta	Avg Delta	Max Delta	Std Delta
0	5.3055	5.3314	5.4077	0.042857	5.2912	5.3192	5.3961	0.043354	-0.0143	-0.01218	-0.0094	0.0019331
20	5.2124	5.3137	5.404	0.060022	5.248	5.3341	5.4124	0.048561	-0.0867	0.0204	0.1482	0.057245
30	5.2745	5.3473	5.6235	0.10284	5.3111	5.3713	5.6264	0.093726	-0.0034	0.02397	0.0639	0.023945

Device Test: 5.40 UJXYSN(loutleak_32V_UJXYSN)

TID vs Result Stats

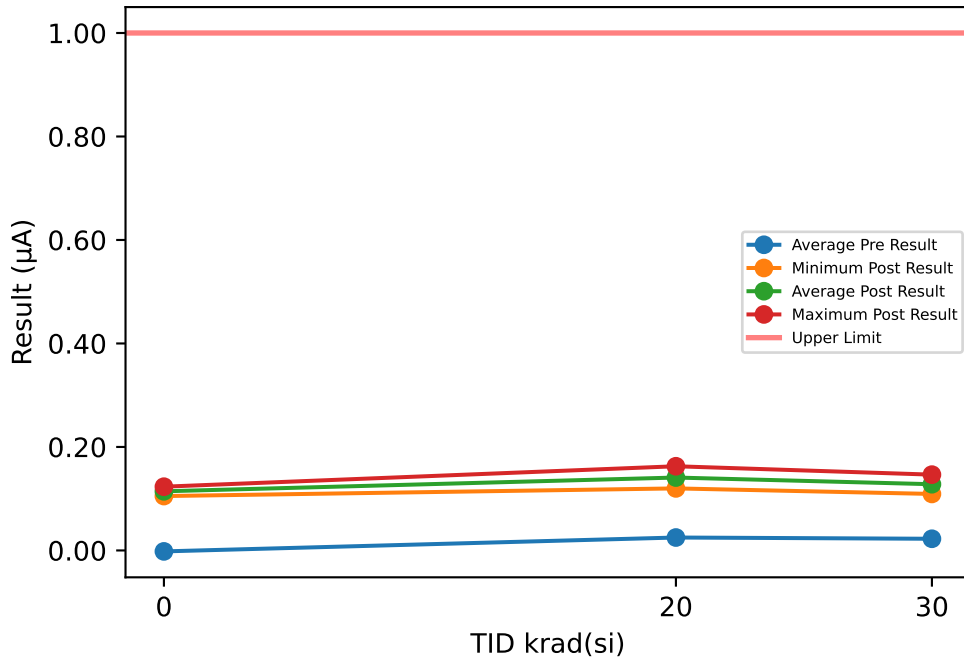

Test Results (Upper Limit = 1.0 (µA))

Serial #	krad(si)	Exposure Conditions	Pre Result	Post Result	Delta
1	20	HDR unbiased	0.042	0.1525	0.1105
2	20	HDR unbiased	0.0083	0.1199	0.1116
3	20	HDR unbiased	0.0267	0.1416	0.1149
4	20	HDR unbiased	0.0185	0.1301	0.1116
5	20	HDR unbiased	0.0085	0.1346	0.1261
6	20	HDR biased	0.0288	0.1498	0.121
7	20	HDR biased	0.0156	0.1627	0.1471
8	20	HDR biased	0.073	0.1277	0.0547
9	20	HDR biased	0.0214	0.1291	0.1077
10	20	HDR biased	0.007	0.161	0.154
11	30	HDR unbiased	0.0121	0.1092	0.0971
12	30	HDR unbiased	0.0061	0.1298	0.1237
13	30	HDR unbiased	0.0361	0.1465	0.1104
14	30	HDR unbiased	0.0192	0.1341	0.1149
15	30	HDR unbiased	0.068	0.11	0.042
16	30	HDR biased	0.0486	0.1093	0.0607
17	30	HDR biased	0.0021	0.132	0.1299
18	30	HDR biased	0.0107	0.1405	0.1298
19	30	HDR biased	-0.0182	0.1291	0.1473
20	30	HDR biased	0.041	0.1394	0.0984
21	0	correlation	0.0098	0.1232	0.1134
22	0	correlation	-0.0255	0.1223	0.1478
23	0	correlation	0.0027	0.1051	0.1024
24	0	correlation	-0.0192	0.1072	0.1264
25	0	correlation	0.023	0.1137	0.0907

TID vs Post - Pre Exposure Delta

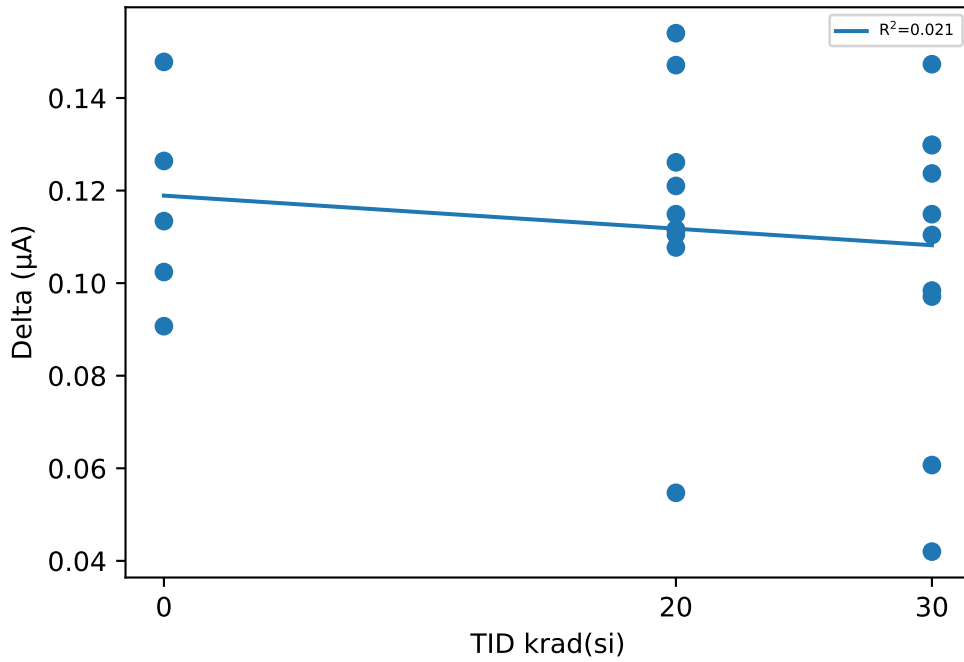

Test Statistics (µA)

krad(si)	Pre Exposure Min	Pre Exposure Avg	Pre Exposure Max	Pre Exposure Std	Post Exposure Min	Post Exposure Avg	Post Exposure Max	Post Exposure Std	Min Delta	Avg Delta	Max Delta	Std Delta
0	-0.0255	-0.00184	0.023	0.020213	0.1051	0.1143	0.1232	0.008346	0.0907	0.11614	0.1478	0.022086
20	0.007	0.02498	0.073	0.02008	0.1199	0.1409	0.1627	0.014923	0.0547	0.11592	0.154	0.026739
30	-0.0182	0.02257	0.068	0.025557	0.1092	0.12799	0.1465	0.013797	0.042	0.10542	0.1473	0.032552

Device Test: 5.49 UJ4NY1(STBY_DEGLITCH_5V_UJ4NY1)

TID vs Result Stats

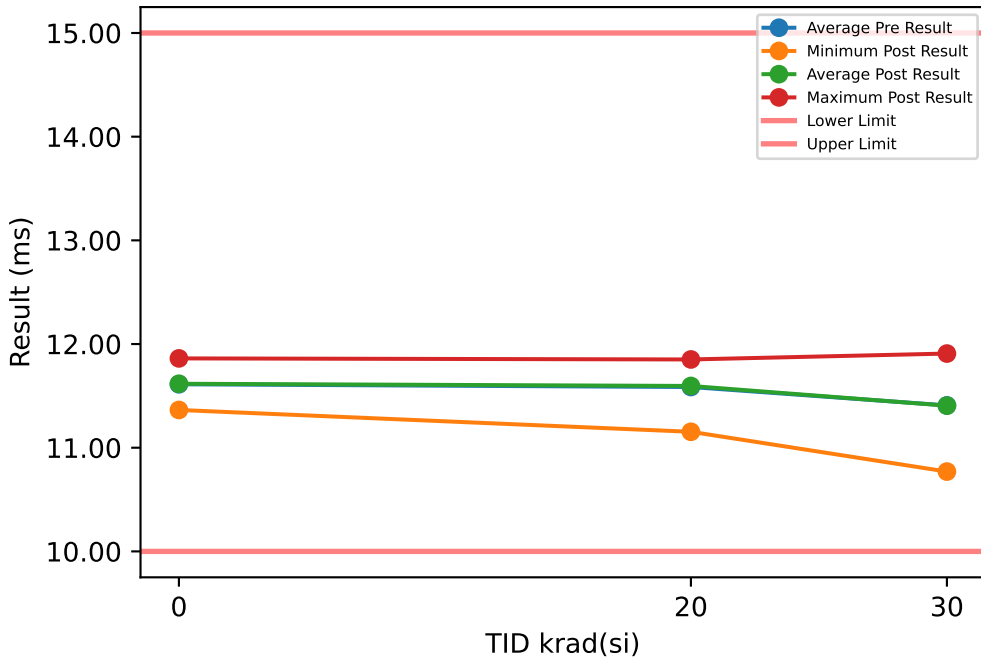

Test Results (Lower Limit = 10.0, Upper Limit = 15.0 (ms))

Serial #	krad(si)	Exposure Conditions	Pre Result	Post Result	Delta
1	20	HDR unbiased	11.177	11.154	-0.0238
2	20	HDR unbiased	11.667	11.673	0.0057
3	20	HDR unbiased	11.633	11.621	-0.0126
4	20	HDR unbiased	11.806	11.848	0.0414
5	20	HDR unbiased	11.306	11.343	0.037
6	20	HDR biased	11.441	11.836	0.3955
7	20	HDR biased	11.596	11.625	0.0289
8	20	HDR biased	11.565	11.53	-0.0347
9	20	HDR biased	11.961	11.851	-0.1098
10	20	HDR biased	11.702	11.476	-0.2258
11	30	HDR unbiased	10.63	10.77	0.1396
12	30	HDR unbiased	11.944	11.908	-0.0361
13	30	HDR unbiased	11.51	11.597	0.0874
14	30	HDR unbiased	11.451	11.785	0.334
15	30	HDR unbiased	11.133	11.1	-0.0332
16	30	HDR biased	11.176	11.163	-0.013
17	30	HDR biased	11.612	11.534	-0.0779
18	30	HDR biased	11.283	11.222	-0.0613
19	30	HDR biased	11.785	11.48	-0.3048
20	30	HDR biased	11.557	11.497	-0.0601
21	0	correlation	11.796	11.862	0.0658
22	0	correlation	11.311	11.364	0.0533
23	0	correlation	11.71	11.593	-0.1166
24	0	correlation	11.473	11.487	0.0145
25	0	correlation	11.771	11.779	0.0078

TID vs Post - Pre Exposure Delta

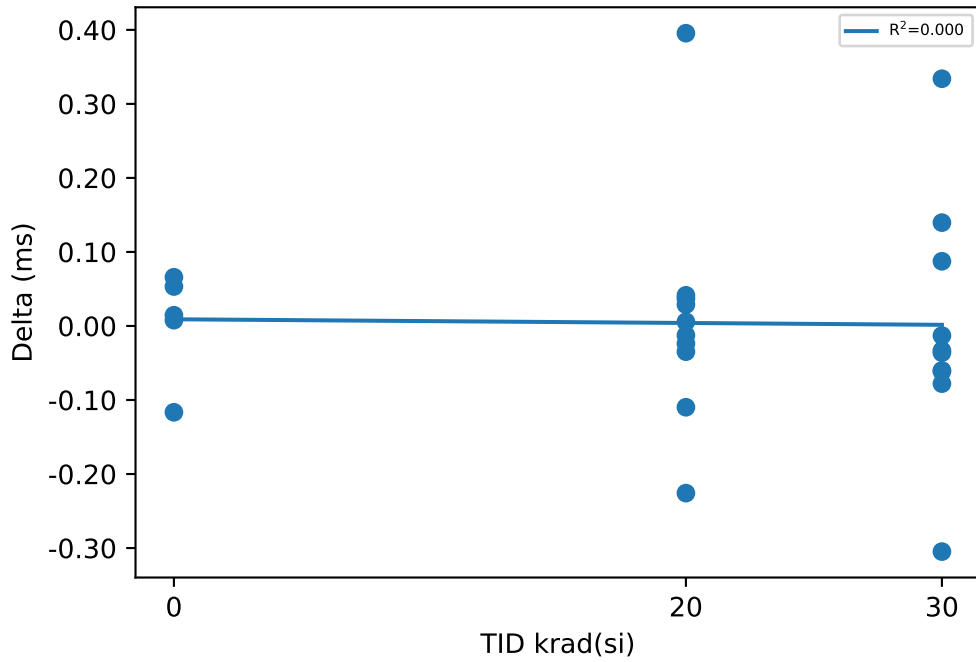

Test Statistics (ms)

krad(si)	Pre Exposure Min	Pre Exposure Avg	Pre Exposure Max	Pre Exposure Std	Post Exposure Min	Post Exposure Avg	Post Exposure Max	Post Exposure Std	Min Delta	Avg Delta	Max Delta	Std Delta
0	11.311	11.612	11.796	0.21128	11.364	11.617	11.862	0.20447	-0.1166	0.00496	0.0658	0.072309
20	11.177	11.586	11.961	0.2305	11.154	11.596	11.851	0.22897	-0.2258	0.01018	0.3955	0.15787
30	10.63	11.408	11.944	0.37341	10.77	11.406	11.908	0.34213	-0.3048	-0.00254	0.334	0.16584

Device Test: 5.5 UJ80MB(IQ_Diag_5V_UJ80MB)

TID vs Result Stats

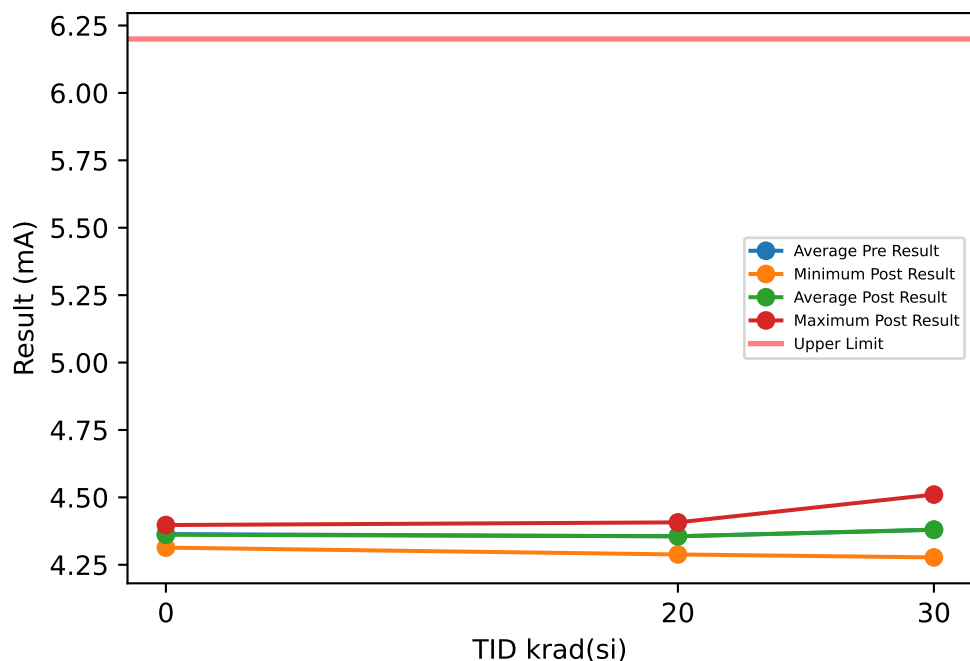

Test Results (Upper Limit = 6.2 (mA))

Serial #	krad(si)	Exposure Conditions	Pre Result	Post Result	Delta
1	20	HDR unbiased	4.4043	4.4073	0.003
2	20	HDR unbiased	4.3631	4.3537	-0.0094
3	20	HDR unbiased	4.3659	4.366	0.0001
4	20	HDR unbiased	4.3503	4.3449	-0.0054
5	20	HDR unbiased	4.4105	4.4061	-0.0044
6	20	HDR biased	4.3827	4.2883	-0.0944
7	20	HDR biased	4.3483	4.3523	0.004
8	20	HDR biased	4.3398	4.3517	0.0119
9	20	HDR biased	4.2978	4.3042	0.0064
10	20	HDR biased	4.2951	4.3812	0.0861
11	30	HDR unbiased	4.5231	4.5104	-0.0127
12	30	HDR unbiased	4.2915	4.2774	-0.0141
13	30	HDR unbiased	4.3763	4.3709	-0.0054
14	30	HDR unbiased	4.3509	4.3258	-0.0251
15	30	HDR unbiased	4.4331	4.4311	-0.002
16	30	HDR biased	4.3951	4.4056	0.0105
17	30	HDR biased	4.3425	4.3524	0.0099
18	30	HDR biased	4.3933	4.398	0.0047
19	30	HDR biased	4.3299	4.3566	0.0267
20	30	HDR biased	4.3614	4.3757	0.0143
21	0	correlation	4.3438	4.3427	-0.0011
22	0	correlation	4.3988	4.3959	-0.0029
23	0	correlation	4.3594	4.3568	-0.0026
24	0	correlation	4.4004	4.3974	-0.003
25	0	correlation	4.3165	4.3136	-0.0029

TID vs Post - Pre Exposure Delta

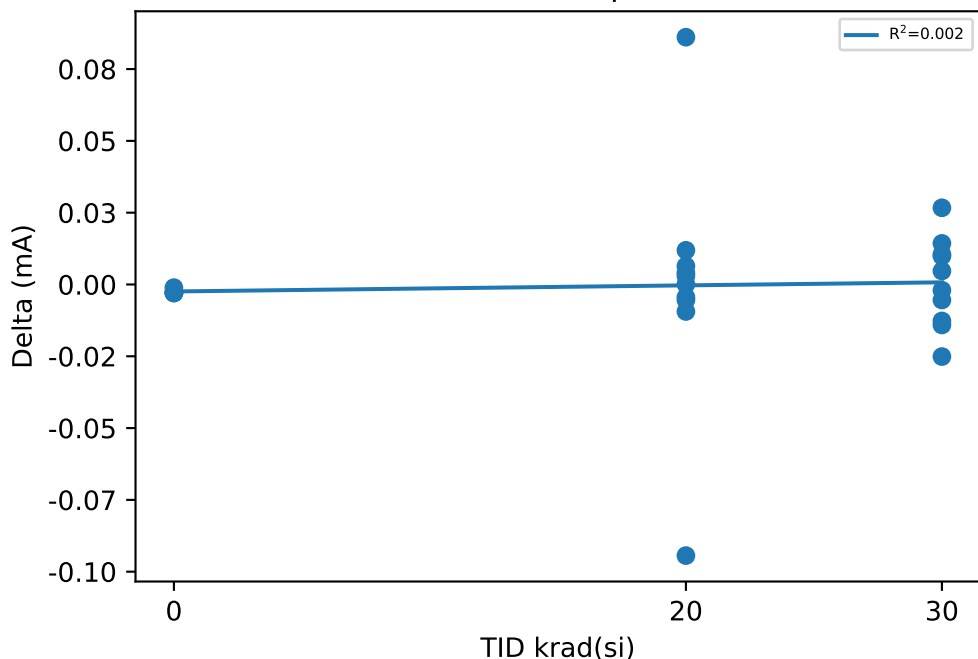

Device Test: 5.50 UJ4NY1(STBY_DEGLITCH_12V_UJ4NY1)

TID vs Result Stats

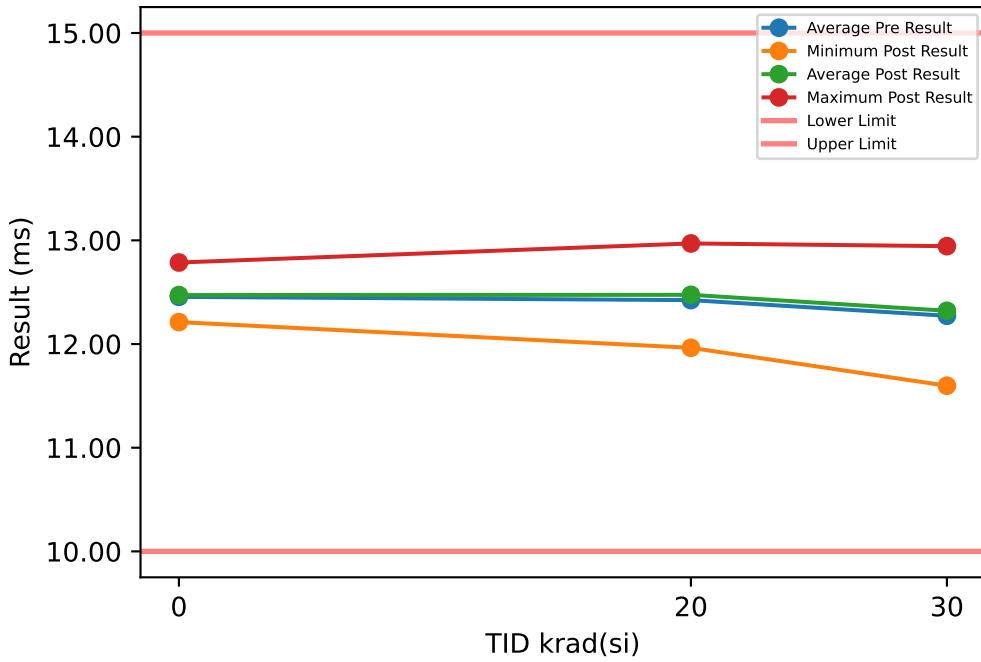

Test Results (Lower Limit = 10.0, Upper Limit = 15.0 (ms))

Serial #	krad(si)	Exposure Conditions	Pre Result	Post Result	Delta
1	20	HDR unbiased	11.903	11.964	0.0605
2	20	HDR unbiased	12.501	12.56	0.059
3	20	HDR unbiased	12.415	12.427	0.0119
4	20	HDR unbiased	12.592	12.645	0.0527
5	20	HDR unbiased	12.129	12.298	0.1686
6	20	HDR biased	12.166	12.672	0.5059
7	20	HDR biased	12.535	12.482	-0.0525
8	20	HDR biased	12.374	12.383	0.0089
9	20	HDR biased	12.944	12.97	0.0259
10	20	HDR biased	12.677	12.345	-0.3316
11	30	HDR unbiased	11.585	11.598	0.0131
12	30	HDR unbiased	12.683	12.944	0.2609
13	30	HDR unbiased	12.273	12.401	0.1284
14	30	HDR unbiased	12.434	12.648	0.2145
15	30	HDR unbiased	12.001	11.948	-0.0534
16	30	HDR biased	12.091	12.162	0.0718
17	30	HDR biased	12.376	12.457	0.0813
18	30	HDR biased	12.166	12.218	0.0519
19	30	HDR biased	12.769	12.46	-0.3088
20	30	HDR biased	12.349	12.373	0.0241
21	0	correlation	12.668	12.601	-0.0664
22	0	correlation	12.142	12.212	0.0697
23	0	correlation	12.448	12.485	0.0376
24	0	correlation	12.249	12.277	0.028
25	0	correlation	12.768	12.786	0.0186

TID vs Post - Pre Exposure Delta

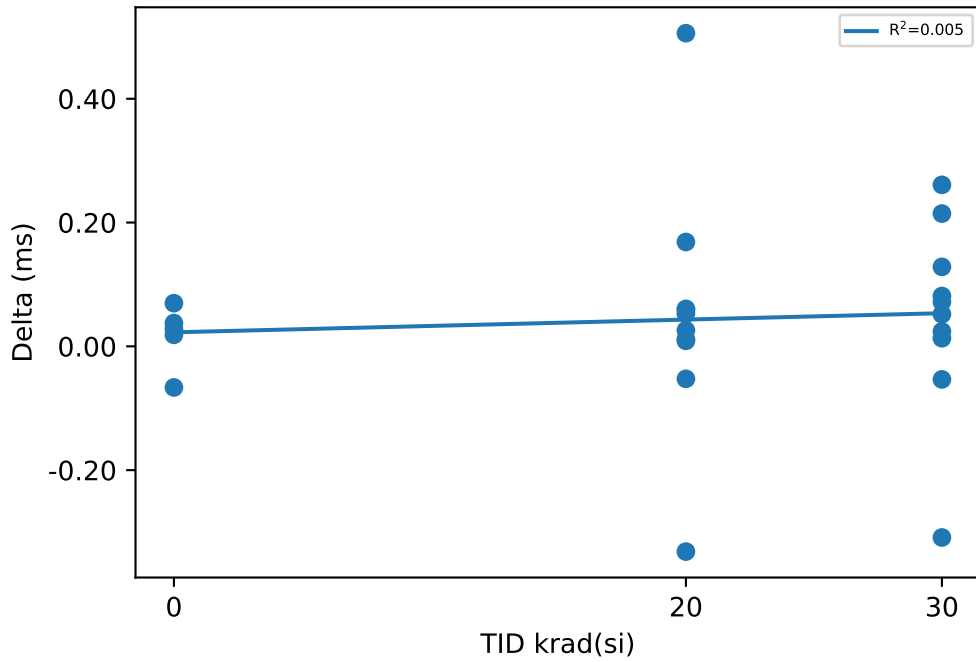

Test Statistics (ms)

krad(si)	Pre Exposure Min	Pre Exposure Avg	Pre Exposure Max	Pre Exposure Std	Post Exposure Min	Post Exposure Avg	Post Exposure Max	Post Exposure Std	Min Delta	Avg Delta	Max Delta	Std Delta
0	12.142	12.455	12.768	0.26614	12.212	12.472	12.786	0.2352	-0.0664	0.0175	0.0697	0.050694
20	11.903	12.424	12.944	0.29967	11.964	12.475	12.97	0.26679	-0.3316	0.05093	0.5059	0.20601
30	11.585	12.273	12.769	0.34128	11.598	12.321	12.944	0.37117	-0.3088	0.04838	0.2609	0.15655

Device Test: 5.51 UJ4NY1(STBY_DEGLITCH_28V_UJ4NY1)

TID vs Result Stats

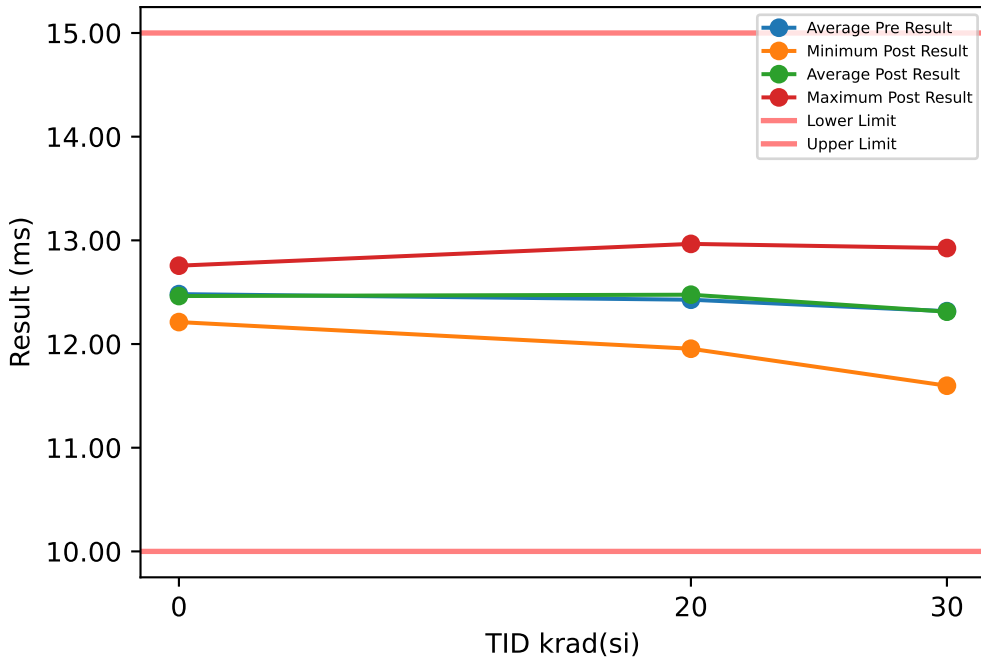

Test Results (Lower Limit = 10.0, Upper Limit = 15.0 (ms))

Serial #	krad(si)	Exposure Conditions	Pre Result	Post Result	Delta
1	20	HDR unbiased	12.073	11.955	-0.1184
2	20	HDR unbiased	12.493	12.584	0.0911
3	20	HDR unbiased	12.401	12.406	0.0056
4	20	HDR unbiased	12.58	12.643	0.0625
5	20	HDR unbiased	12.179	12.128	-0.0509
6	20	HDR biased	12.178	12.691	0.5121
7	20	HDR biased	12.374	12.481	0.1074
8	20	HDR biased	12.37	12.564	0.1945
9	20	HDR biased	12.949	12.966	0.0169
10	20	HDR biased	12.677	12.341	-0.3361
11	30	HDR unbiased	11.566	11.598	0.0323
12	30	HDR unbiased	12.854	12.926	0.0716
13	30	HDR unbiased	12.29	12.4	0.1106
14	30	HDR unbiased	12.379	12.651	0.2718
15	30	HDR unbiased	12.01	11.937	-0.0729
16	30	HDR biased	12.067	12.154	0.0877
17	30	HDR biased	12.545	12.449	-0.0955
18	30	HDR biased	12.14	12.205	0.0649
19	30	HDR biased	12.782	12.424	-0.3585
20	30	HDR biased	12.538	12.376	-0.1613
21	0	correlation	12.678	12.599	-0.0795
22	0	correlation	12.152	12.212	0.0598
23	0	correlation	12.589	12.487	-0.1023
24	0	correlation	12.195	12.261	0.0664
25	0	correlation	12.793	12.756	-0.0377

TID vs Post - Pre Exposure Delta

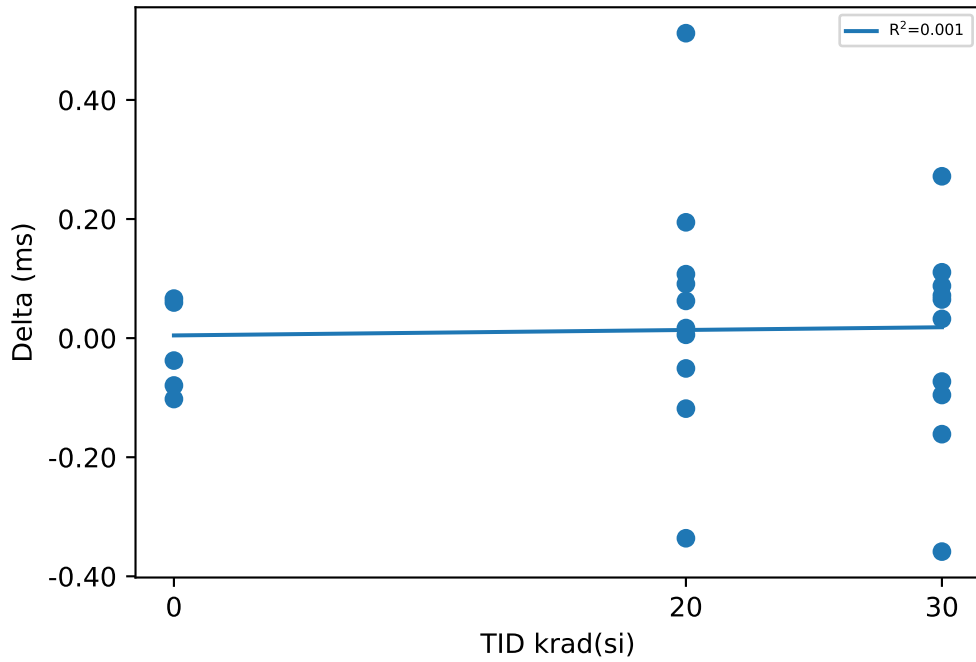

Test Statistics (ms)

krad(si)	Pre Exposure Min	Pre Exposure Avg	Pre Exposure Max	Pre Exposure Std	Post Exposure Min	Post Exposure Avg	Post Exposure Max	Post Exposure Std	Min Delta	Avg Delta	Max Delta	Std Delta
0	12.152	12.482	12.793	0.29089	12.212	12.463	12.756	0.22837	-0.1023	-0.01866	0.0664	0.078184
20	12.073	12.427	12.949	0.26203	11.955	12.476	12.966	0.28855	-0.3361	0.04847	0.5121	0.21864
30	11.566	12.317	12.854	0.38911	11.598	12.312	12.926	0.36836	-0.3585	-0.00493	0.2718	0.17414

Device Test: 5.52 UJ4NY1(STBY_DEGLITCH_32V_UJ4NY1)

TID vs Result Stats

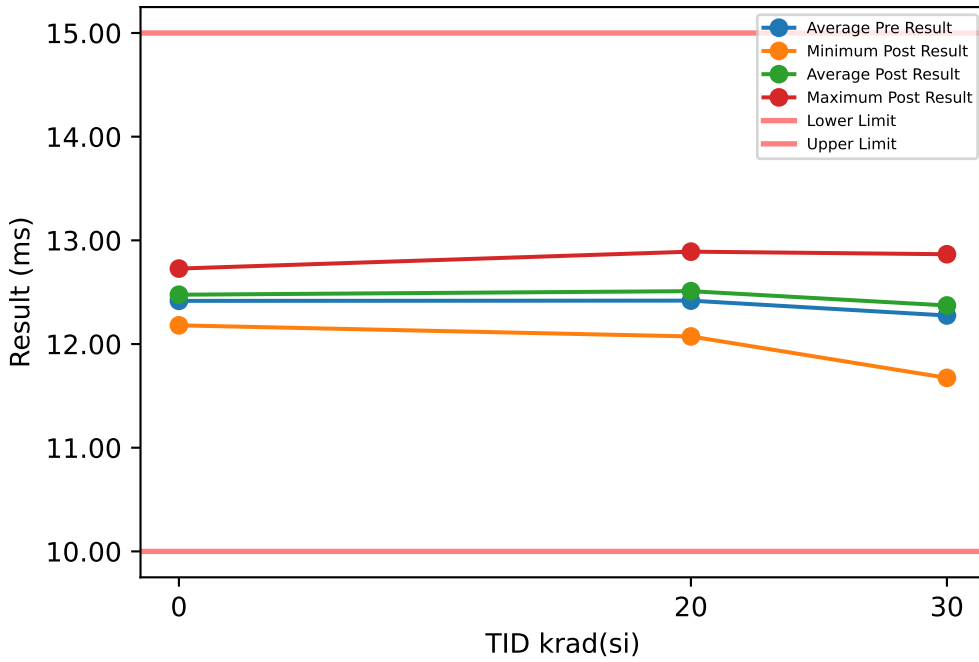

Test Results (Lower Limit = 10.0, Upper Limit = 15.0 (ms))

Serial #	krad(si)	Exposure Conditions	Pre Result	Post Result	Delta
1	20	HDR unbiased	12.029	12.073	0.0439
2	20	HDR unbiased	12.461	12.598	0.1364
3	20	HDR unbiased	12.448	12.554	0.1063
4	20	HDR unbiased	12.548	12.718	0.17
5	20	HDR unbiased	12.096	12.302	0.2054
6	20	HDR biased	12.195	12.642	0.4467
7	20	HDR biased	12.446	12.591	0.145
8	20	HDR biased	12.42	12.46	0.0396
9	20	HDR biased	12.842	12.891	0.0492
10	20	HDR biased	12.701	12.271	-0.4295
11	30	HDR unbiased	11.466	11.674	0.2079
12	30	HDR unbiased	12.68	12.866	0.1863
13	30	HDR unbiased	12.376	12.395	0.019
14	30	HDR unbiased	12.418	12.812	0.3943
15	30	HDR unbiased	11.867	12.081	0.2139
16	30	HDR biased	12.184	12.284	0.1006
17	30	HDR biased	12.41	12.504	0.0933
18	30	HDR biased	12.214	12.198	-0.0163
19	30	HDR biased	12.629	12.493	-0.136
20	30	HDR biased	12.509	12.415	-0.0948
21	0	correlation	12.568	12.637	0.0695
22	0	correlation	12.107	12.18	0.0735
23	0	correlation	12.505	12.467	-0.0375
24	0	correlation	12.232	12.365	0.1334
25	0	correlation	12.67	12.728	0.0572

TID vs Post - Pre Exposure Delta

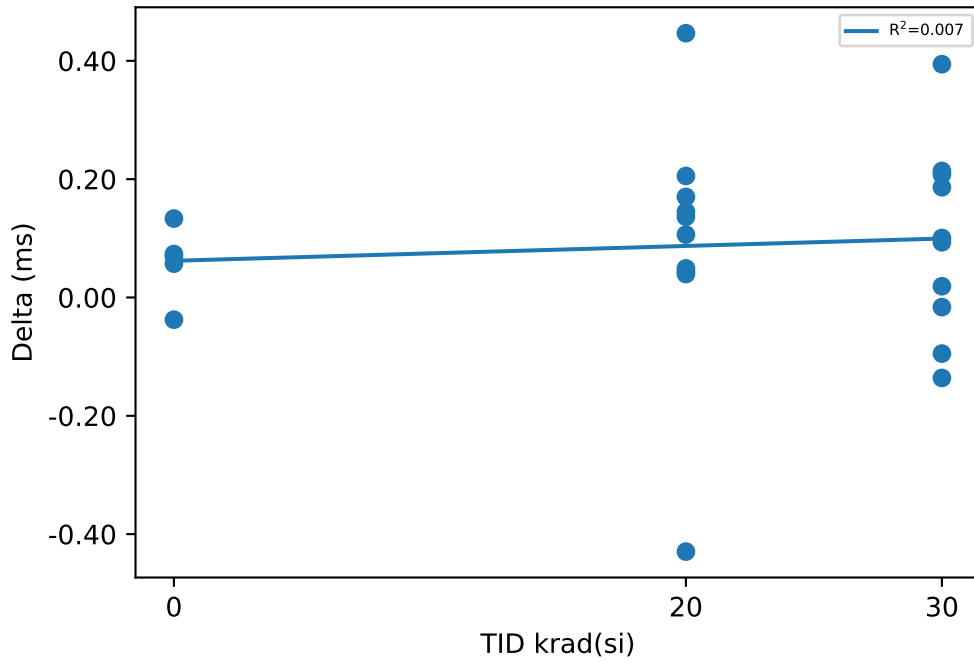

Test Statistics (ms)

krad(si)	Pre Exposure Min	Pre Exposure Avg	Pre Exposure Max	Pre Exposure Std	Post Exposure Min	Post Exposure Avg	Post Exposure Max	Post Exposure Std	Min Delta	Avg Delta	Max Delta	Std Delta
0	12.107	12.416	12.67	0.23727	12.18	12.476	12.728	0.21746	-0.0375	0.05922	0.1334	0.061586
20	12.029	12.419	12.842	0.2548	12.073	12.51	12.891	0.23938	-0.4295	0.0913	0.4467	0.21822
30	11.466	12.275	12.68	0.3691	11.674	12.372	12.866	0.34682	-0.136	0.09682	0.3943	0.16068

Device Test: 5.6 UJ8OMB(IQ_Diag_12V_UJ8OMB)

TID vs Result Stats

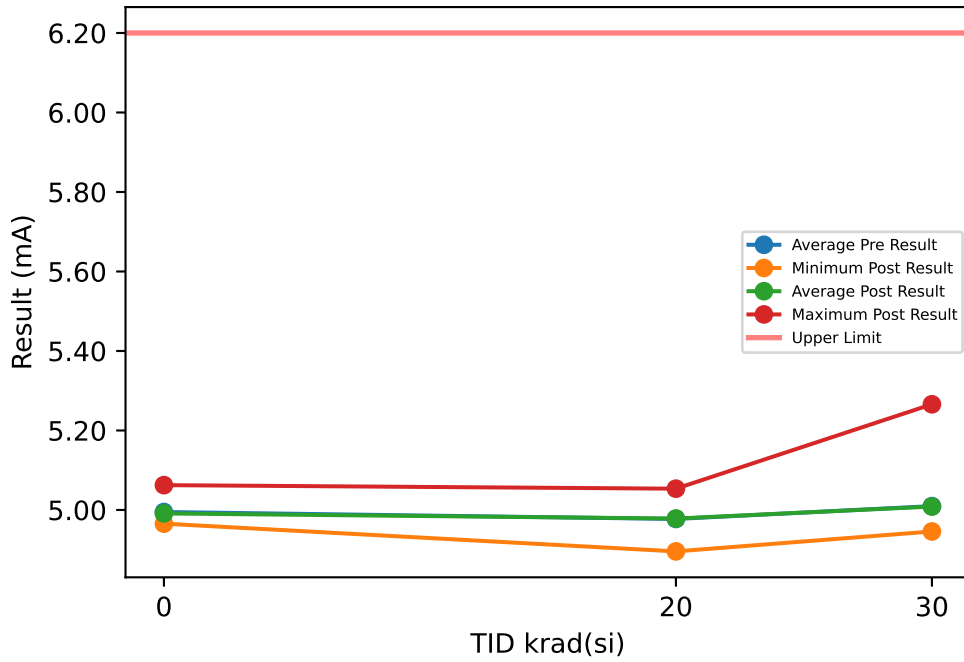

Test Results (Upper Limit = 6.2 (mA))

Serial #	krad(si)	Exposure Conditions	Pre Result	Post Result	Delta
1	20	HDR unbiased	5.0147	5.0059	-0.0088
2	20	HDR unbiased	5.0138	4.9885	-0.0253
3	20	HDR unbiased	4.989	4.9928	0.0038
4	20	HDR unbiased	5.0313	5.0211	-0.0102
5	20	HDR unbiased	5.0649	5.0536	-0.0113
6	20	HDR biased	4.9987	4.8958	-0.1029
7	20	HDR biased	4.9183	4.9377	0.0194
8	20	HDR biased	4.9195	4.9415	0.022
9	20	HDR biased	4.9381	4.9424	0.0043
10	20	HDR biased	4.8859	5.0052	0.1193
11	30	HDR unbiased	5.2923	5.2659	-0.0264
12	30	HDR unbiased	4.952	4.9459	-0.0061
13	30	HDR unbiased	4.9699	4.9499	-0.02
14	30	HDR unbiased	4.934	4.9641	0.0301
15	30	HDR unbiased	5.0177	4.9927	-0.025
16	30	HDR biased	4.9947	5.0078	0.0131
17	30	HDR biased	4.9486	4.9649	0.0163
18	30	HDR biased	5.0397	5.0103	-0.0294
19	30	HDR biased	4.9673	4.9657	-0.0016
20	30	HDR biased	4.9811	5.019	0.0379
21	0	correlation	4.9805	4.9783	-0.0022
22	0	correlation	4.98	4.9767	-0.0033
23	0	correlation	4.9715	4.9656	-0.0059
24	0	correlation	5.0661	5.0625	-0.0036
25	0	correlation	4.9764	4.9733	-0.0031

TID vs Post - Pre Exposure Delta

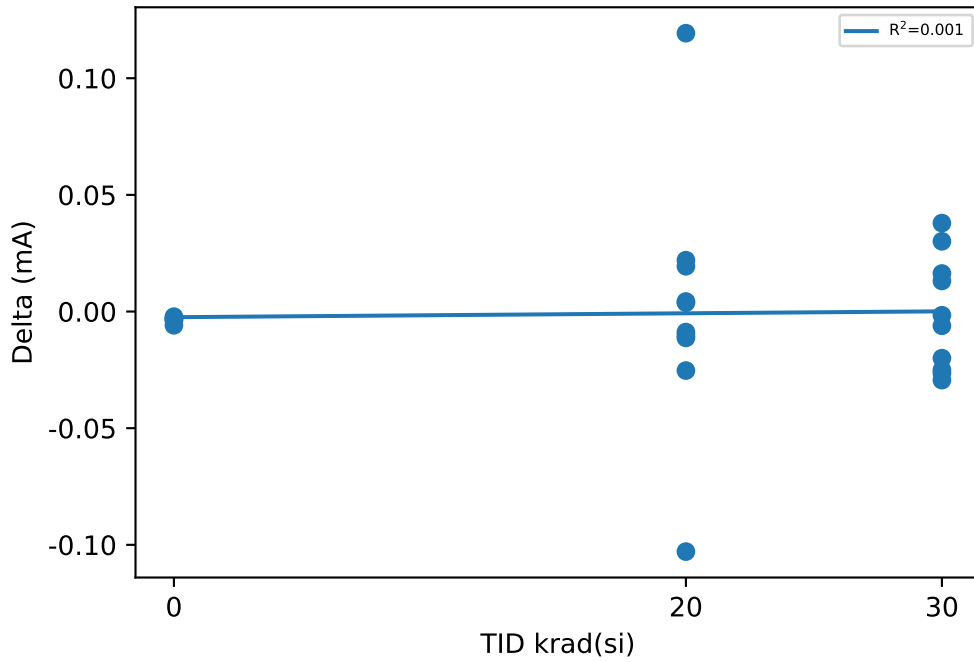

Test Statistics (mA)

krad(si)	Pre Exposure Min	Pre Exposure Avg	Pre Exposure Max	Pre Exposure Std	Post Exposure Min	Post Exposure Avg	Post Exposure Max	Post Exposure Std	Min Delta	Avg Delta	Max Delta	Std Delta
0	4.9715	4.9949	5.0661	0.039964	4.9656	4.9913	5.0625	0.040113	-0.0059	-0.00362	-0.0022	0.0013773
20	4.8859	4.9774	5.0649	0.058336	4.8958	4.9784	5.0536	0.047608	-0.1029	0.00103	0.1193	0.054419
30	4.934	5.0097	5.2923	0.10437	4.9459	5.0086	5.2659	0.094089	-0.0294	-0.00111	0.0379	0.02448

Device Test: 5.7 UJ8OMB(IQ_Diag_28V_UJ8OMB)

TID vs Result Stats

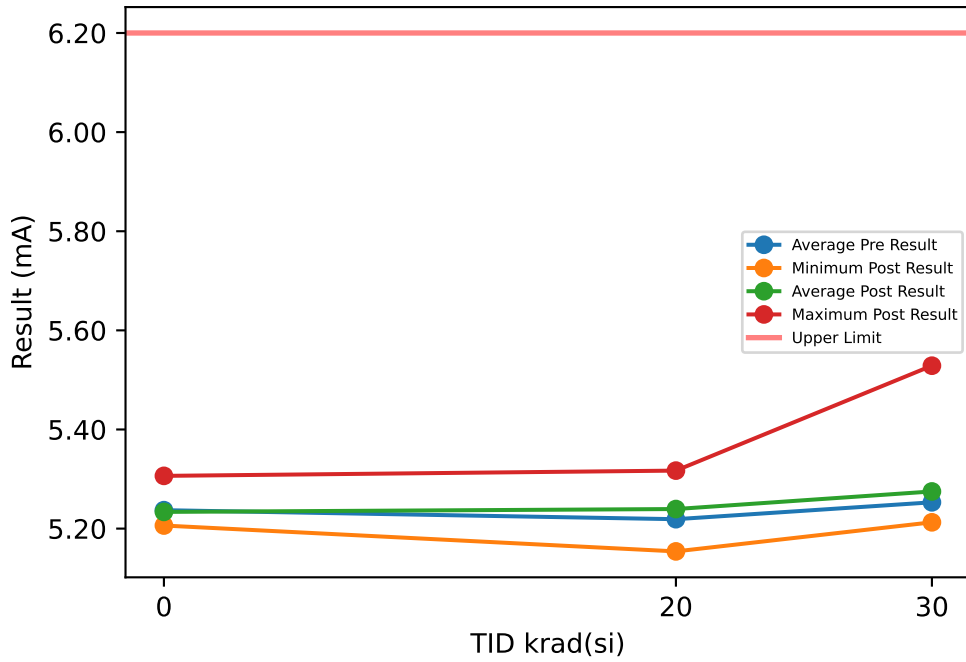

Test Results (Upper Limit = 6.2 (mA))

Serial #	krad(si)	Exposure Conditions	Pre Result	Post Result	Delta
1	20	HDR unbiased	5.2577	5.2687	0.011
2	20	HDR unbiased	5.2559	5.2481	-0.0078
3	20	HDR unbiased	5.2293	5.2479	0.0186
4	20	HDR unbiased	5.273	5.2828	0.0098
5	20	HDR unbiased	5.307	5.317	0.01
6	20	HDR biased	5.2423	5.154	-0.0883
7	20	HDR biased	5.1586	5.2004	0.0418
8	20	HDR biased	5.1612	5.2038	0.0426
9	20	HDR biased	5.183	5.2046	0.0216
10	20	HDR biased	5.1218	5.2673	0.1455
11	30	HDR unbiased	5.5352	5.5287	-0.0065
12	30	HDR unbiased	5.1967	5.2165	0.0198
13	30	HDR unbiased	5.208	5.2127	0.0047
14	30	HDR unbiased	5.1811	5.2307	0.0496
15	30	HDR unbiased	5.2594	5.259	-0.0004
16	30	HDR biased	5.2371	5.2731	0.036
17	30	HDR biased	5.1884	5.2249	0.0365
18	30	HDR biased	5.2872	5.2803	-0.0069
19	30	HDR biased	5.2118	5.2354	0.0236
20	30	HDR biased	5.2256	5.2882	0.0626
21	0	correlation	5.2235	5.2211	-0.0024
22	0	correlation	5.221	5.2178	-0.0032
23	0	correlation	5.2121	5.2062	-0.0059
24	0	correlation	5.3117	5.3064	-0.0053
25	0	correlation	5.2176	5.217	-0.0006

TID vs Post - Pre Exposure Delta

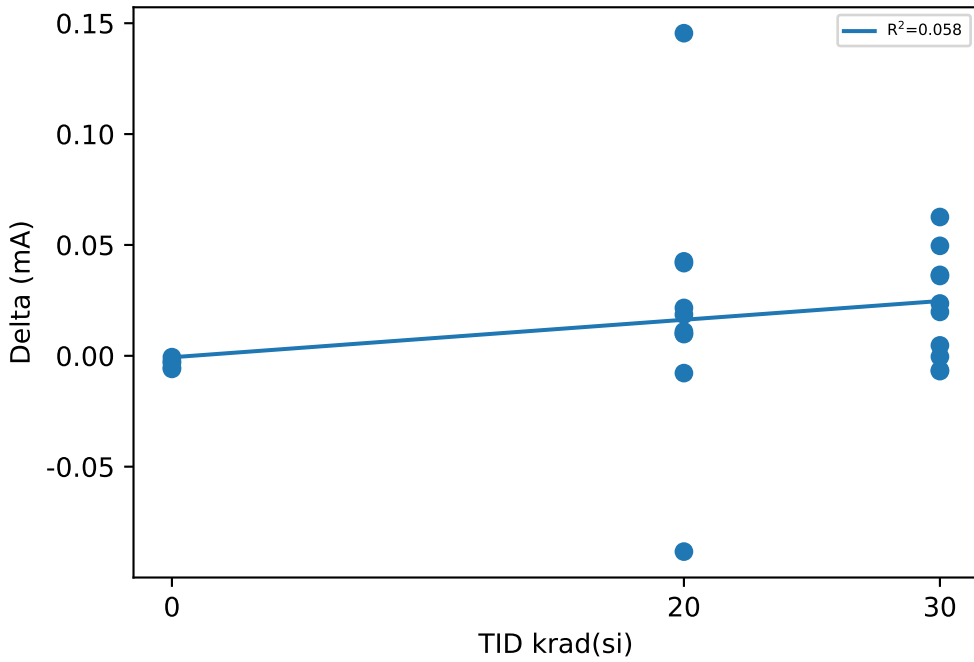

Test Statistics (mA)

krad(si)	Pre Exposure Min	Pre Exposure Avg	Pre Exposure Max	Pre Exposure Std	Post Exposure Min	Post Exposure Avg	Post Exposure Max	Post Exposure Std	Min Delta	Avg Delta	Max Delta	Std Delta
0	5.2121	5.2372	5.3117	0.041876	5.2062	5.2337	5.3064	0.041024	-0.0059	-0.00348	-0.0006	0.0021626
20	5.1218	5.219	5.307	0.059536	5.154	5.2395	5.317	0.048285	-0.0883	0.02048	0.1455	0.057276
30	5.1811	5.253	5.5352	0.1044	5.2127	5.2749	5.5287	0.093196	-0.0069	0.0219	0.0626	0.024203

Device Test: 5.8 UJ8OMB(IQ_Diag_32V_UJ8OMB)

TID vs Result Stats

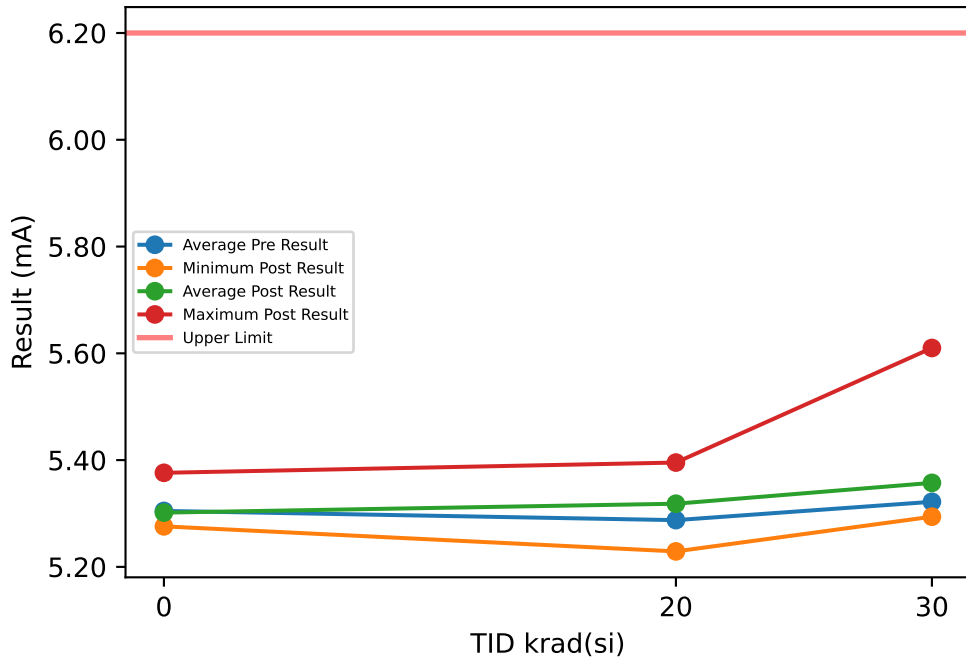

Test Results (Upper Limit = 6.2 (mA))

Serial #	krad(si)	Exposure Conditions	Pre Result	Post Result	Delta
1	20	HDR unbiased	5.3252	5.3458	0.0206
2	20	HDR unbiased	5.3243	5.3275	0.0032
3	20	HDR unbiased	5.2946	5.3262	0.0316
4	20	HDR unbiased	5.3421	5.3604	0.0183
5	20	HDR unbiased	5.3752	5.3954	0.0202
6	20	HDR biased	5.3092	5.229	-0.0802
7	20	HDR biased	5.2317	5.2757	0.044
8	20	HDR biased	5.2317	5.2882	0.0565
9	20	HDR biased	5.2533	5.2872	0.0339
10	20	HDR biased	5.1884	5.3477	0.1593
11	30	HDR unbiased	5.5995	5.61	0.0105
12	30	HDR unbiased	5.2701	5.3007	0.0306
13	30	HDR unbiased	5.276	5.294	0.018
14	30	HDR unbiased	5.2492	5.312	0.0628
15	30	HDR unbiased	5.3286	5.3396	0.011
16	30	HDR biased	5.3049	5.357	0.0521
17	30	HDR biased	5.2545	5.3091	0.0546
18	30	HDR biased	5.357	5.3649	0.0079
19	30	HDR biased	5.2822	5.3152	0.033
20	30	HDR biased	5.2969	5.3711	0.0742
21	0	correlation	5.2889	5.2865	-0.0024
22	0	correlation	5.2899	5.2866	-0.0033
23	0	correlation	5.2801	5.2759	-0.0042
24	0	correlation	5.3808	5.3762	-0.0046
25	0	correlation	5.2844	5.2829	-0.0015

TID vs Post - Pre Exposure Delta

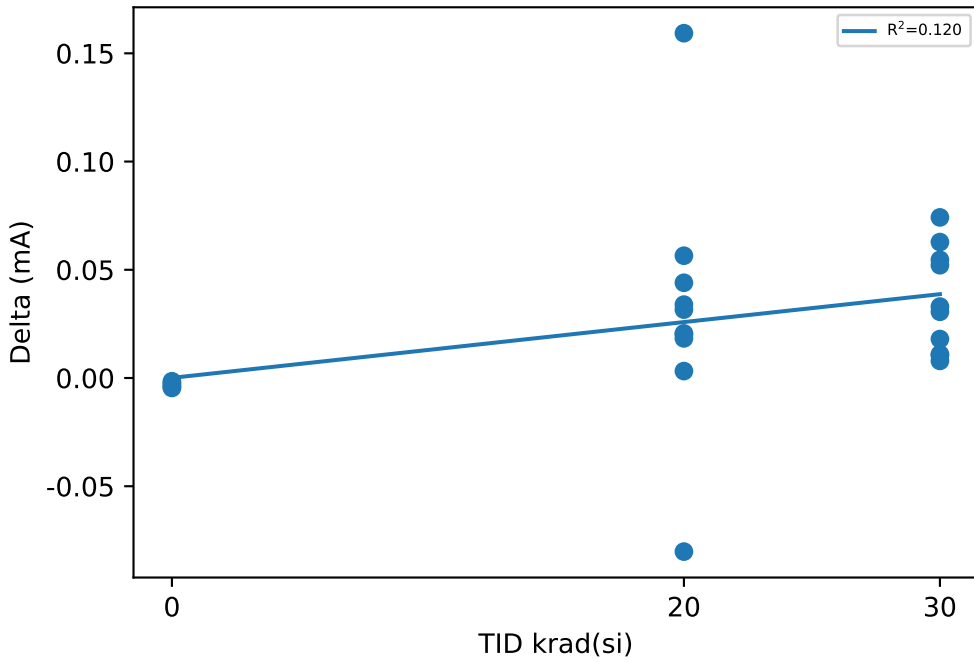

Test Statistics (mA)

krad(si)	Pre Exposure Min	Pre Exposure Avg	Pre Exposure Max	Pre Exposure Std	Post Exposure Min	Post Exposure Avg	Post Exposure Max	Post Exposure Std	Min Delta	Avg Delta	Max Delta	Std Delta
0	5.2801	5.3048	5.3808	0.042653	5.2759	5.3016	5.3762	0.041918	-0.0046	-0.0032	-0.0015	0.0012748
20	5.1884	5.2876	5.3752	0.058866	5.229	5.3183	5.3954	0.048473	-0.0802	0.03074	0.1593	0.058512
30	5.2492	5.3219	5.5995	0.10298	5.294	5.3574	5.61	0.092962	0.0079	0.03547	0.0742	0.024053

Device Test: 5.9 UJKFAE(IQ_5V_UJKFAE)

TID vs Result Stats

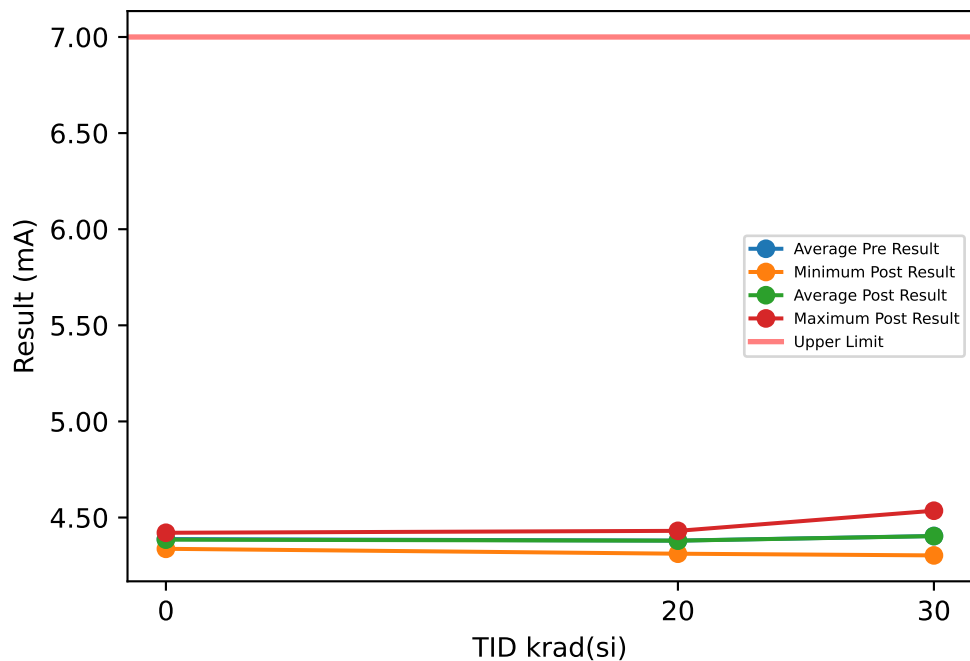

Test Results (Upper Limit = 7.0 (mA))

Serial #	krad(si)	Exposure Conditions	Pre Result	Post Result	Delta
1	20	HDR unbiased	4.4297	4.4307	0.001
2	20	HDR unbiased	4.3869	4.3795	-0.0074
3	20	HDR unbiased	4.3906	4.3913	0.0007
4	20	HDR unbiased	4.3753	4.3682	-0.0071
5	20	HDR unbiased	4.4351	4.4289	-0.0062
6	20	HDR biased	4.4056	4.3118	-0.0938
7	20	HDR biased	4.3714	4.3743	0.0029
8	20	HDR biased	4.3655	4.3768	0.0113
9	20	HDR biased	4.3206	4.328	0.0074
10	20	HDR biased	4.3184	4.4065	0.0881
11	30	HDR unbiased	4.5478	4.5354	-0.0124
12	30	HDR unbiased	4.3167	4.303	-0.0137
13	30	HDR unbiased	4.4	4.3953	-0.0047
14	30	HDR unbiased	4.3737	4.3495	-0.0242
15	30	HDR unbiased	4.4558	4.4563	0.0005
16	30	HDR biased	4.4198	4.4236	0.0038
17	30	HDR biased	4.3657	4.3704	0.0047
18	30	HDR biased	4.4189	4.4219	0.003
19	30	HDR biased	4.3542	4.3809	0.0267
20	30	HDR biased	4.3865	4.3969	0.0104
21	0	correlation	4.3679	4.3659	-0.002
22	0	correlation	4.4236	4.4207	-0.0029
23	0	correlation	4.3849	4.3804	-0.0045
24	0	correlation	4.4234	4.4201	-0.0033
25	0	correlation	4.3404	4.3373	-0.0031

TID vs Post - Pre Exposure Delta

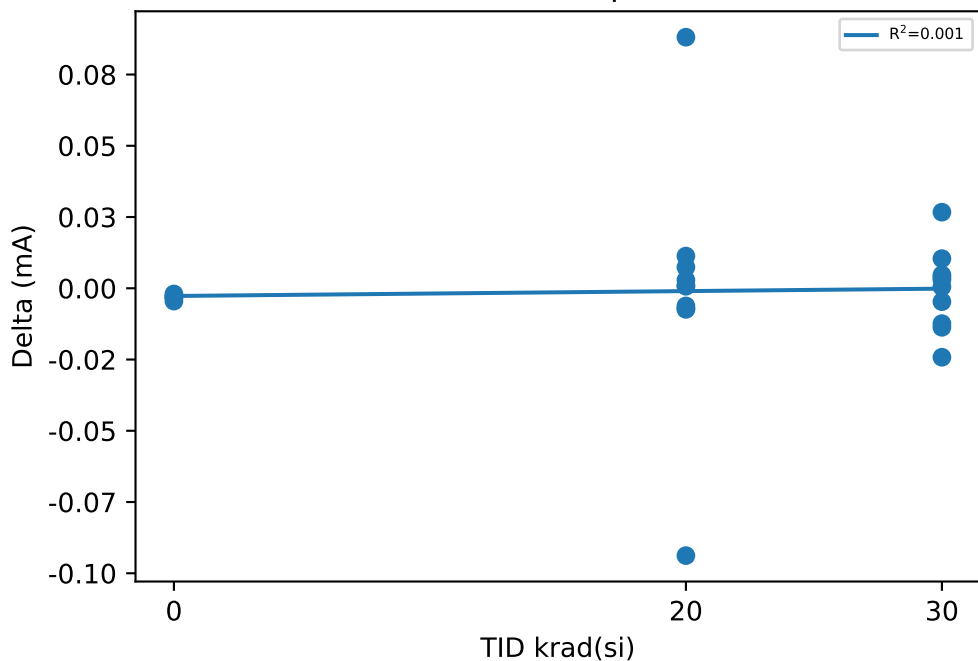

Test Statistics (mA)

krad(si)	Pre Exposure Min	Pre Exposure Avg	Pre Exposure Max	Pre Exposure Std	Post Exposure Min	Post Exposure Avg	Post Exposure Max	Post Exposure Std	Min Delta	Avg Delta	Max Delta	Std Delta
0	4.3404	4.388	4.4236	0.036055	4.3373	4.3849	4.4207	0.035943	-0.0045	-0.00316	-0.002	0.00089889
20	4.3184	4.3799	4.4351	0.039371	4.3118	4.3796	4.4307	0.038482	-0.0938	-0.00031	0.0881	0.043327
30	4.3167	4.4039	4.5478	0.063807	4.303	4.4033	4.5354	0.062947	-0.0242	-0.00059	0.0267	0.014191

Device Test: 6.1 UJCS56(UVLOR_UJCS56)

TID vs Result Stats

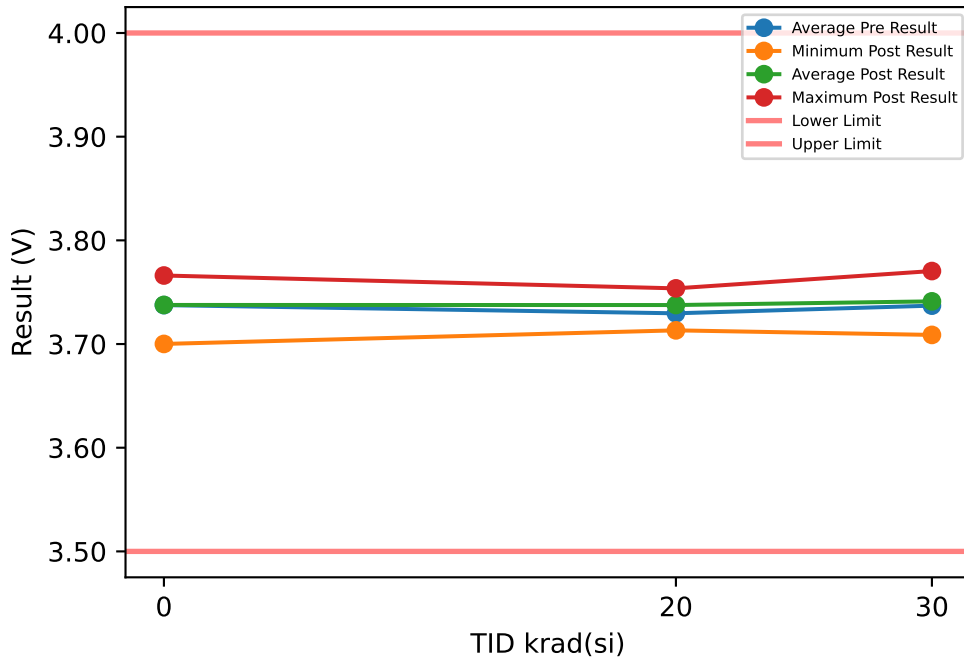

Test Results (Lower Limit = 3.5, Upper Limit = 4.0 (V))

Serial #	krad(si)	Exposure Conditions	Pre Result	Post Result	Delta
1	20	HDR unbiased	3.7341	3.7254	-0.0087
2	20	HDR unbiased	3.7457	3.7427	-0.003
3	20	HDR unbiased	3.7388	3.7497	0.0109
4	20	HDR unbiased	3.7367	3.7422	0.0055
5	20	HDR unbiased	3.7242	3.7364	0.0122
6	20	HDR biased	3.7282	3.7361	0.0079
7	20	HDR biased	3.7249	3.7429	0.018
8	20	HDR biased	3.7251	3.7338	0.0087
9	20	HDR biased	3.7065	3.7132	0.0067
10	20	HDR biased	3.7321	3.7537	0.0216
11	30	HDR unbiased	3.7136	3.7088	-0.0048
12	30	HDR unbiased	3.756	3.741	-0.015
13	30	HDR unbiased	3.7503	3.7374	-0.0129
14	30	HDR unbiased	3.7437	3.7448	0.0011
15	30	HDR unbiased	3.7501	3.7541	0.004
16	30	HDR biased	3.7183	3.7286	0.0103
17	30	HDR biased	3.7502	3.7704	0.0202
18	30	HDR biased	3.7216	3.7333	0.0117
19	30	HDR biased	3.7404	3.7601	0.0197
20	30	HDR biased	3.7261	3.7332	0.0071
21	0	correlation	3.7242	3.7318	0.0076
22	0	correlation	3.7416	3.7419	0.0003
23	0	correlation	3.7504	3.7486	-0.0018
24	0	correlation	3.7665	3.7661	-0.0004
25	0	correlation	3.705	3.7001	-0.0049

TID vs Post - Pre Exposure Delta

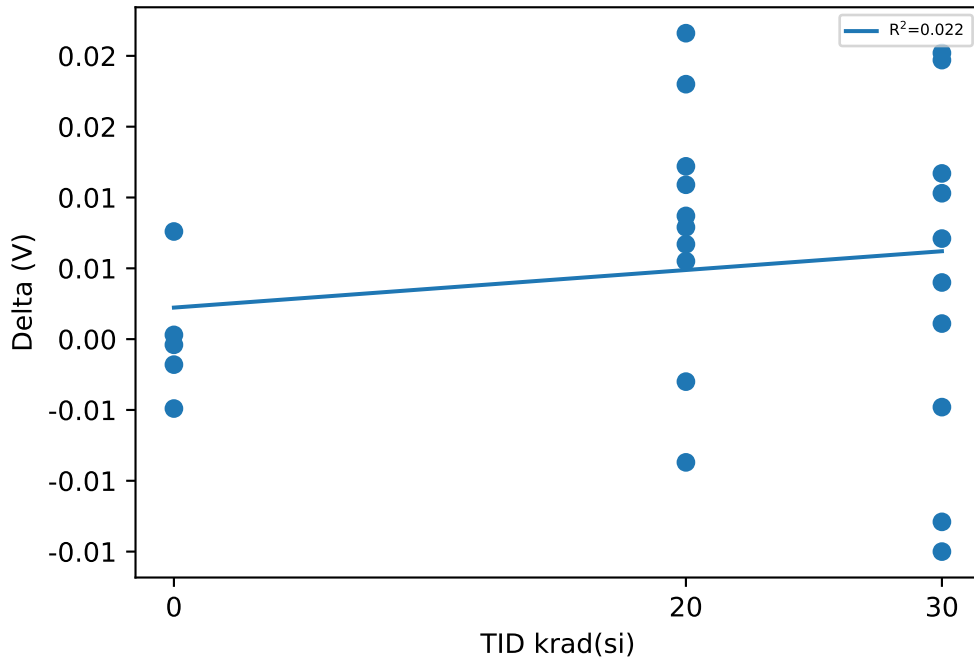

Test Statistics (V)

krad(si)	Pre Exposure Min	Pre Exposure Avg	Pre Exposure Max	Pre Exposure Std	Post Exposure Min	Post Exposure Avg	Post Exposure Max	Post Exposure Std	Min Delta	Avg Delta	Max Delta	Std Delta
0	3.705	3.7375	3.7665	0.023756	3.7001	3.7377	3.7661	0.024452	-0.0049	0.00016	0.0076	0.0046134
20	3.7065	3.7296	3.7457	0.010687	3.7132	3.7376	3.7537	0.011753	-0.0087	0.00798	0.0216	0.0089401
30	3.7136	3.737	3.756	0.015611	3.7088	3.7412	3.7704	0.017444	-0.015	0.00414	0.0202	0.012246

Device Test: 6.2 UJE7RD(UVLOF_UJE7RD)

TID vs Result Stats

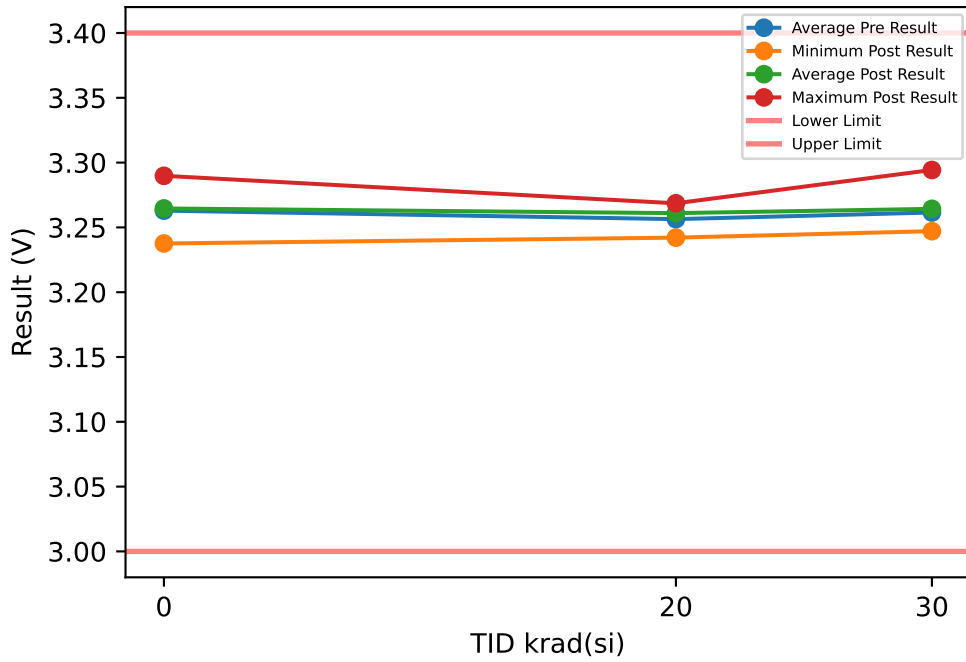

Test Results (Lower Limit = 3.0, Upper Limit = 3.4 (V))

Serial #	krad(si)	Exposure Conditions	Pre Result	Post Result	Delta
1	20	HDR unbiased	3.2635	3.2579	-0.0056
2	20	HDR unbiased	3.2689	3.2627	-0.0062
3	20	HDR unbiased	3.2641	3.2686	0.0045
4	20	HDR unbiased	3.2689	3.2686	-0.0003
5	20	HDR unbiased	3.2586	3.2582	-0.0004
6	20	HDR biased	3.2532	3.2681	0.0149
7	20	HDR biased	3.2585	3.2686	0.0101
8	20	HDR biased	3.243	3.2529	0.0099
9	20	HDR biased	3.2316	3.2421	0.0105
10	20	HDR biased	3.2534	3.2623	0.0089
11	30	HDR unbiased	3.253	3.2484	-0.0046
12	30	HDR unbiased	3.2738	3.2688	-0.005
13	30	HDR unbiased	3.2577	3.2584	0.0007
14	30	HDR unbiased	3.263	3.2633	0.0003
15	30	HDR unbiased	3.2746	3.2739	-0.0007
16	30	HDR biased	3.2384	3.2471	0.0087
17	30	HDR biased	3.284	3.2943	0.0103
18	30	HDR biased	3.2533	3.252	-0.0013
19	30	HDR biased	3.2635	3.2786	0.0151
20	30	HDR biased	3.2536	3.2584	0.0048
21	0	correlation	3.2537	3.2583	0.0046
22	0	correlation	3.274	3.2737	-0.0003
23	0	correlation	3.2635	3.2637	0.0002
24	0	correlation	3.2902	3.2898	-0.0004
25	0	correlation	3.2332	3.2376	0.0044

TID vs Post - Pre Exposure Delta

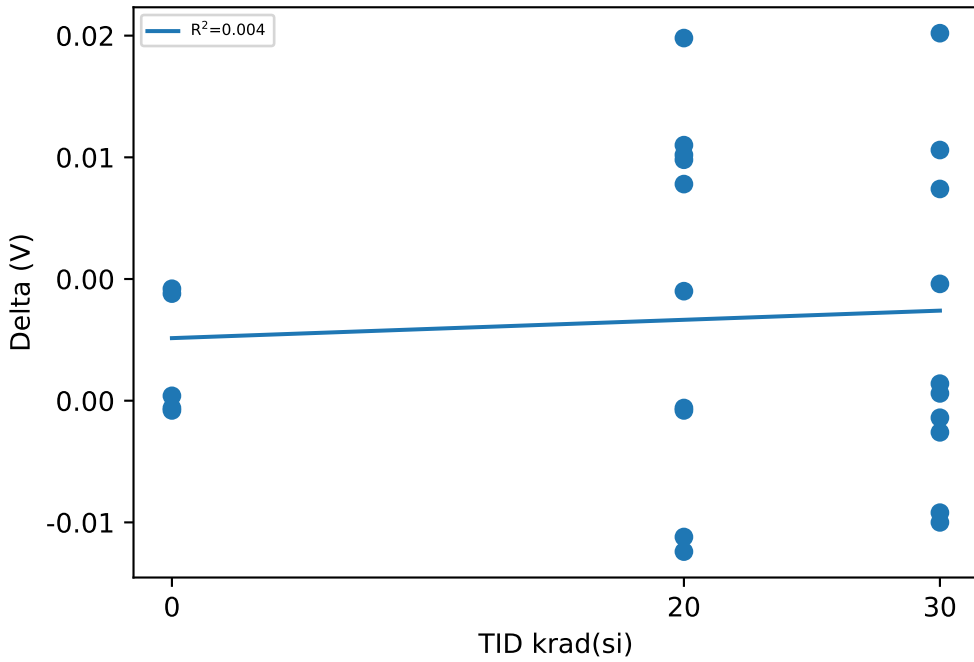

Test Statistics (V)

krad(si)	Pre Exposure Min	Pre Exposure Avg	Pre Exposure Max	Pre Exposure Std	Post Exposure Min	Post Exposure Avg	Post Exposure Max	Post Exposure Std	Min Delta	Avg Delta	Max Delta	Std Delta
0	3.2332	3.2629	3.2902	0.021422	3.2376	3.2646	3.2898	0.019283	-0.0004	0.0017	0.0046	0.0025671
20	3.2316	3.2564	3.2689	0.011763	3.2421	3.261	3.2686	0.0086187	-0.0062	0.00463	0.0149	0.0073592
30	3.2384	3.2615	3.284	0.013272	3.2471	3.2643	3.2943	0.01486	-0.005	0.00283	0.0151	0.0066805

Device Test: 6.3 UJNA02(UVLO_HYS_UJNA02)

TID vs Result Stats

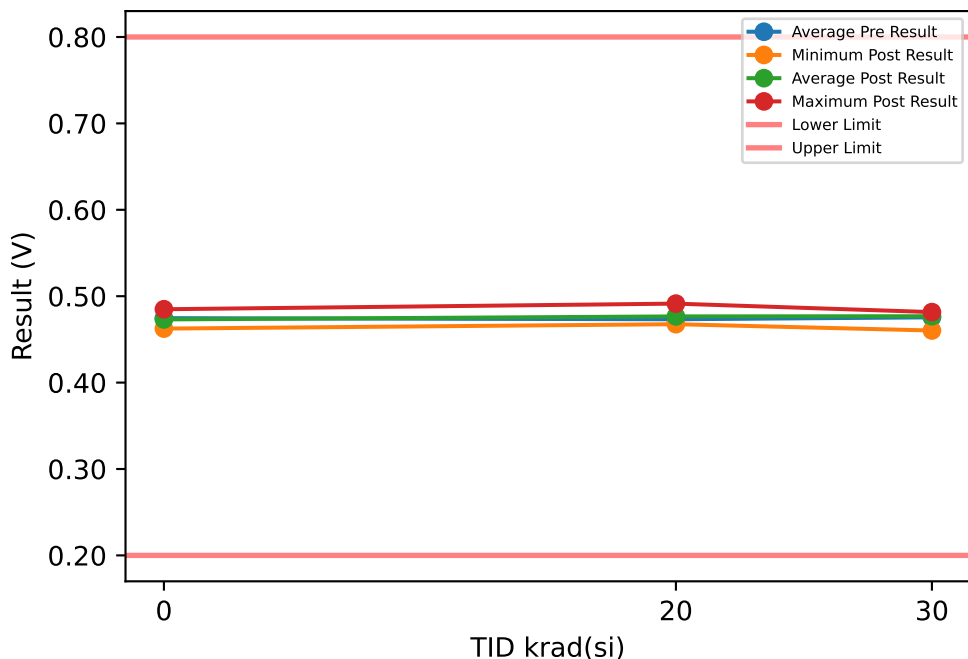

Test Results (Lower Limit = 0.2, Upper Limit = 0.8 (V))

Serial #	krad(si)	Exposure Conditions	Pre Result	Post Result	Delta
1	20	HDR unbiased	0.4706	0.4676	-0.003
2	20	HDR unbiased	0.4769	0.4799	0.003
3	20	HDR unbiased	0.4747	0.4811	0.0064
4	20	HDR unbiased	0.4679	0.4737	0.0058
5	20	HDR unbiased	0.4656	0.4782	0.0126
6	20	HDR biased	0.475	0.4679	-0.0071
7	20	HDR biased	0.4665	0.4743	0.0078
8	20	HDR biased	0.4821	0.4809	-0.0012
9	20	HDR biased	0.4749	0.4712	-0.0037
10	20	HDR biased	0.4787	0.4914	0.0127
11	30	HDR unbiased	0.4605	0.4603	-0.0002
12	30	HDR unbiased	0.4822	0.4722	-0.01
13	30	HDR unbiased	0.4926	0.479	-0.0136
14	30	HDR unbiased	0.4807	0.4816	0.0009
15	30	HDR unbiased	0.4755	0.4803	0.0048
16	30	HDR biased	0.4799	0.4814	0.0015
17	30	HDR biased	0.4662	0.476	0.0098
18	30	HDR biased	0.4683	0.4813	0.013
19	30	HDR biased	0.4769	0.4814	0.0045
20	30	HDR biased	0.4725	0.4748	0.0023
21	0	correlation	0.4705	0.4735	0.003
22	0	correlation	0.4676	0.4682	0.0006
23	0	correlation	0.4868	0.4849	-0.0019
24	0	correlation	0.4763	0.4764	0.0001
25	0	correlation	0.4718	0.4625	-0.0093

TID vs Post - Pre Exposure Delta

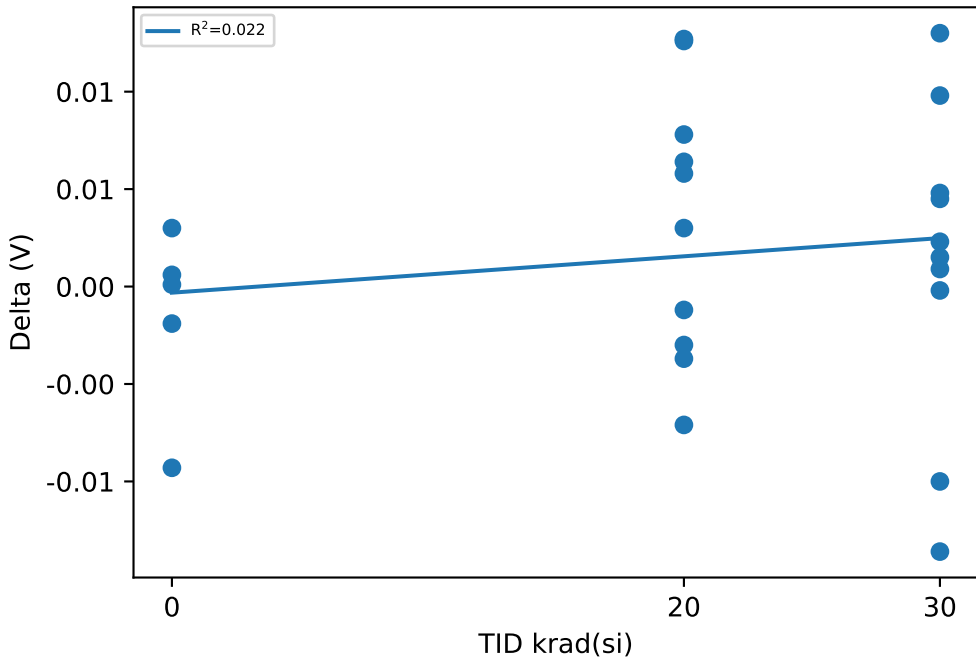

Test Statistics (V)

krad(si)	Pre Exposure Min	Pre Exposure Avg	Pre Exposure Max	Pre Exposure Std	Post Exposure Min	Post Exposure Avg	Post Exposure Max	Post Exposure Std	Min Delta	Avg Delta	Max Delta	Std Delta
0	0.4676	0.4746	0.4868	0.0075063	0.4625	0.4731	0.4849	0.0084655	-0.0093	-0.0015	0.003	0.0046963
20	0.4656	0.47329	0.4821	0.0054666	0.4676	0.47662	0.4914	0.0072325	-0.0071	0.00333	0.0127	0.0068972
30	0.4605	0.47553	0.4926	0.0091772	0.4603	0.47683	0.4816	0.0066728	-0.0136	0.0013	0.013	0.0080607

Device Test: 7.1001 UJTCWZ(EN4_Logic_High_Go-No-Go_UJTCWZ)

TID vs Result Stats

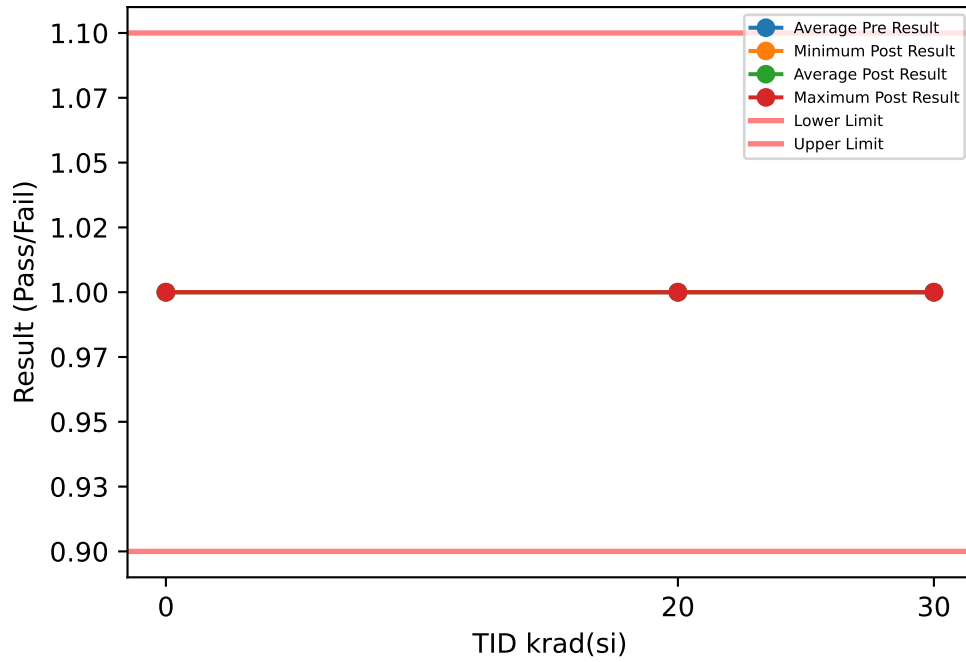

TID vs Post - Pre Exposure Delta

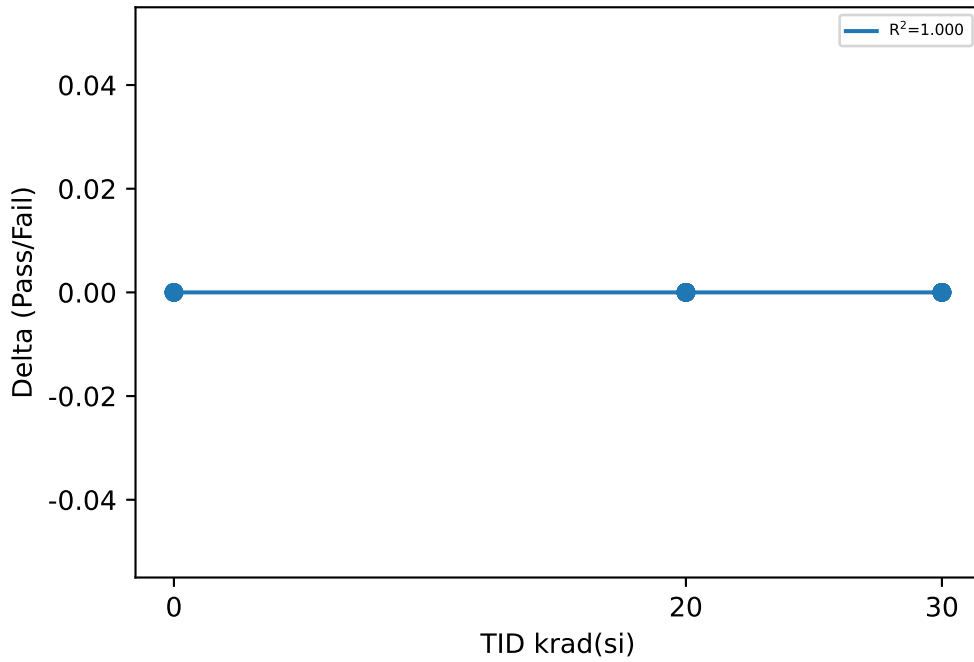

Test Results (Lower Limit = 0.9, Upper Limit = 1.1 (Pass/Fail))

Serial #	krad(si)	Exposure Conditions	Pre Result	Post Result	Delta
1	20	HDR unbiased	1	1	0
2	20	HDR unbiased	1	1	0
3	20	HDR unbiased	1	1	0
4	20	HDR unbiased	1	1	0
5	20	HDR unbiased	1	1	0
6	20	HDR biased	1	1	0
7	20	HDR biased	1	1	0
8	20	HDR biased	1	1	0
9	20	HDR biased	1	1	0
10	20	HDR biased	1	1	0
11	30	HDR unbiased	1	1	0
12	30	HDR unbiased	1	1	0
13	30	HDR unbiased	1	1	0
14	30	HDR unbiased	1	1	0
15	30	HDR unbiased	1	1	0
16	30	HDR biased	1	1	0
17	30	HDR biased	1	1	0
18	30	HDR biased	1	1	0
19	30	HDR biased	1	1	0
20	30	HDR biased	1	1	0
21	0	correlation	1	1	0
22	0	correlation	1	1	0
23	0	correlation	1	1	0
24	0	correlation	1	1	0
25	0	correlation	1	1	0

Test Statistics (Pass/Fail)

krad(si)	Pre Exposure Min	Pre Exposure Avg	Pre Exposure Max	Pre Exposure Std	Post Exposure Min	Post Exposure Avg	Post Exposure Max	Post Exposure Std	Min Delta	Avg Delta	Max Delta	Std Delta
0	1	1	1	0	1	1	1	0	0	0	0	0
20	1	1	1	0	1	1	1	0	0	0	0	0
30	1	1	1	0	1	1	1	0	0	0	0	0

Device Test: 7.101 UJTCWZ(EN1_Logic_High_Go-No-Go_UJTCWZ)

TID vs Result Stats

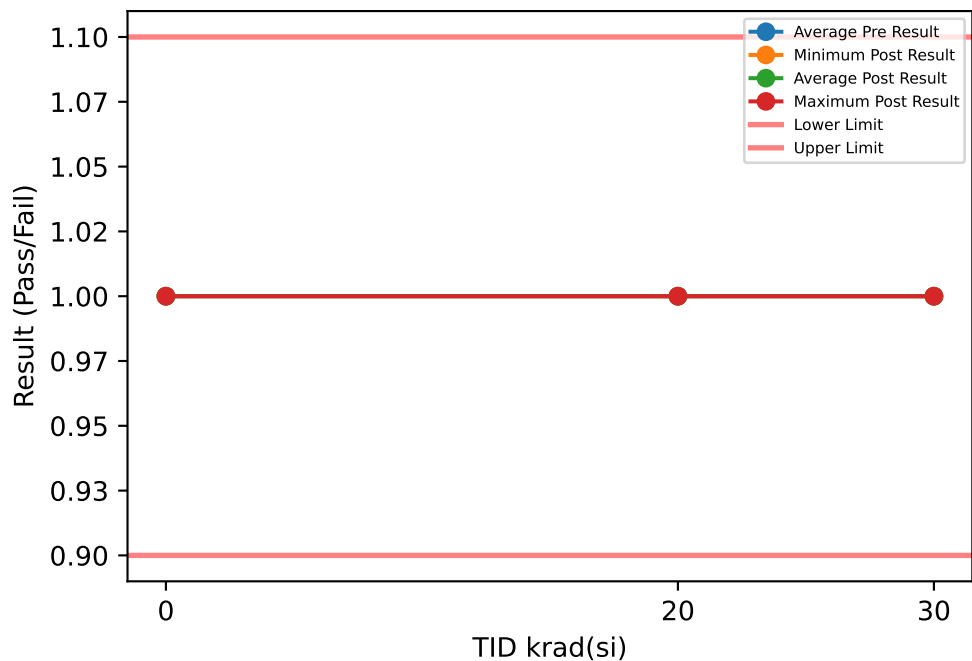

Test Results (Lower Limit = 0.9, Upper Limit = 1.1 (Pass/Fail))

Serial #	krad(si)	Exposure Conditions	Pre Result	Post Result	Delta
1	20	HDR unbiased	1	1	0
2	20	HDR unbiased	1	1	0
3	20	HDR unbiased	1	1	0
4	20	HDR unbiased	1	1	0
5	20	HDR unbiased	1	1	0
6	20	HDR biased	1	1	0
7	20	HDR biased	1	1	0
8	20	HDR biased	1	1	0
9	20	HDR biased	1	1	0
10	20	HDR biased	1	1	0
11	30	HDR unbiased	1	1	0
12	30	HDR unbiased	1	1	0
13	30	HDR unbiased	1	1	0
14	30	HDR unbiased	1	1	0
15	30	HDR unbiased	1	1	0
16	30	HDR biased	1	1	0
17	30	HDR biased	1	1	0
18	30	HDR biased	1	1	0
19	30	HDR biased	1	1	0
20	30	HDR biased	1	1	0
21	0	correlation	1	1	0
22	0	correlation	1	1	0
23	0	correlation	1	1	0
24	0	correlation	1	1	0
25	0	correlation	1	1	0

TID vs Post - Pre Exposure Delta

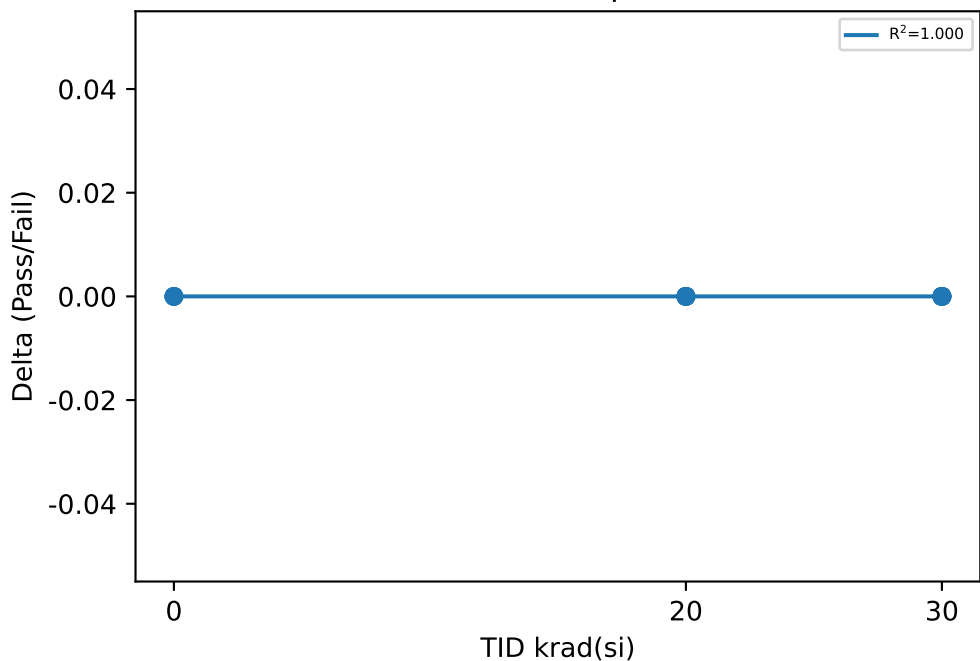

Test Statistics (Pass/Fail)

krad(si)	Pre Exposure Min	Pre Exposure Avg	Pre Exposure Max	Pre Exposure Std	Post Exposure Min	Post Exposure Avg	Post Exposure Max	Post Exposure Std	Min Delta	Avg Delta	Max Delta	Std Delta
0	1	1	1	0	1	1	1	0	0	0	0	0
20	1	1	1	0	1	1	1	0	0	0	0	0
30	1	1	1	0	1	1	1	0	0	0	0	0

Device Test: 7.111 UJVVXI(EN4_Logic_Low_Go-No-Go_UJVVXI)

TID vs Result Stats

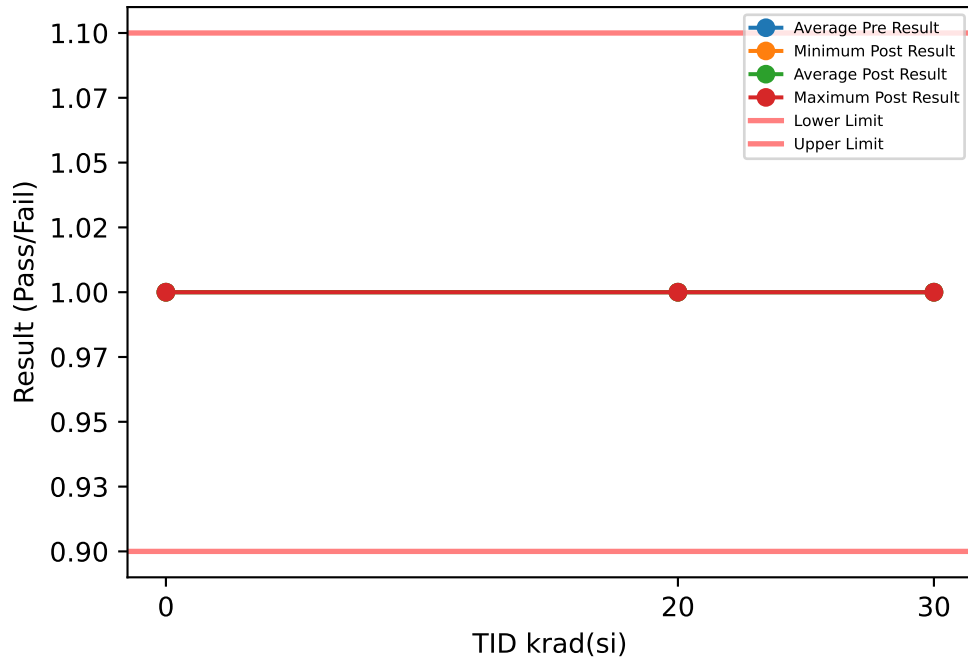

TID vs Post - Pre Exposure Delta

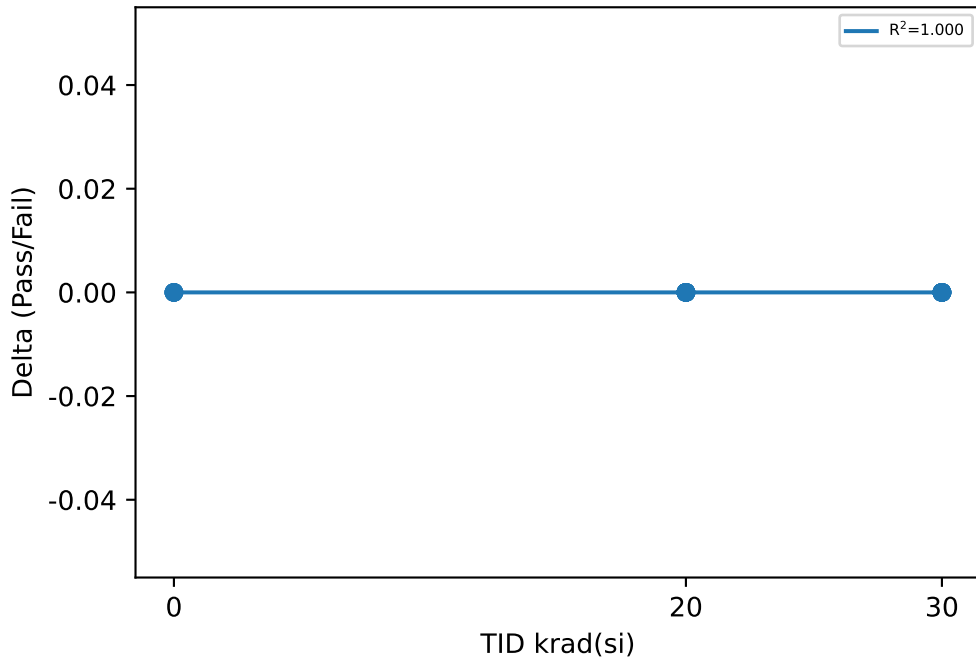

Test Results (Lower Limit = 0.9, Upper Limit = 1.1 (Pass/Fail))

Serial #	krad(si)	Exposure Conditions	Pre Result	Post Result	Delta
1	20	HDR unbiased	1	1	0
2	20	HDR unbiased	1	1	0
3	20	HDR unbiased	1	1	0
4	20	HDR unbiased	1	1	0
5	20	HDR unbiased	1	1	0
6	20	HDR biased	1	1	0
7	20	HDR biased	1	1	0
8	20	HDR biased	1	1	0
9	20	HDR biased	1	1	0
10	20	HDR biased	1	1	0
11	30	HDR unbiased	1	1	0
12	30	HDR unbiased	1	1	0
13	30	HDR unbiased	1	1	0
14	30	HDR unbiased	1	1	0
15	30	HDR unbiased	1	1	0
16	30	HDR biased	1	1	0
17	30	HDR biased	1	1	0
18	30	HDR biased	1	1	0
19	30	HDR biased	1	1	0
20	30	HDR biased	1	1	0
21	0	correlation	1	1	0
22	0	correlation	1	1	0
23	0	correlation	1	1	0
24	0	correlation	1	1	0
25	0	correlation	1	1	0

Test Statistics (Pass/Fail)

krad(si)	Pre Exposure Min	Pre Exposure Avg	Pre Exposure Max	Pre Exposure Std	Post Exposure Min	Post Exposure Avg	Post Exposure Max	Post Exposure Std	Min Delta	Avg Delta	Max Delta	Std Delta
0	1	1	1	0	1	1	1	0	0	0	0	0
20	1	1	1	0	1	1	1	0	0	0	0	0
30	1	1	1	0	1	1	1	0	0	0	0	0

Device Test: 7.131 UJTCWZ(DIAG_Logic_High_Go-No-Go_UJTCWZ)

TID vs Result Stats

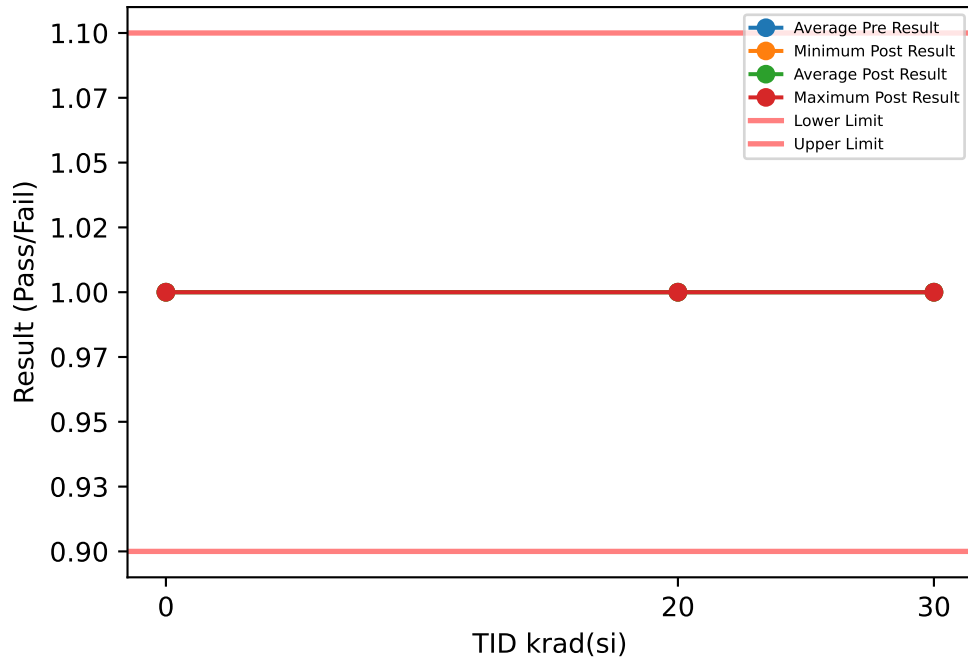

TID vs Post - Pre Exposure Delta

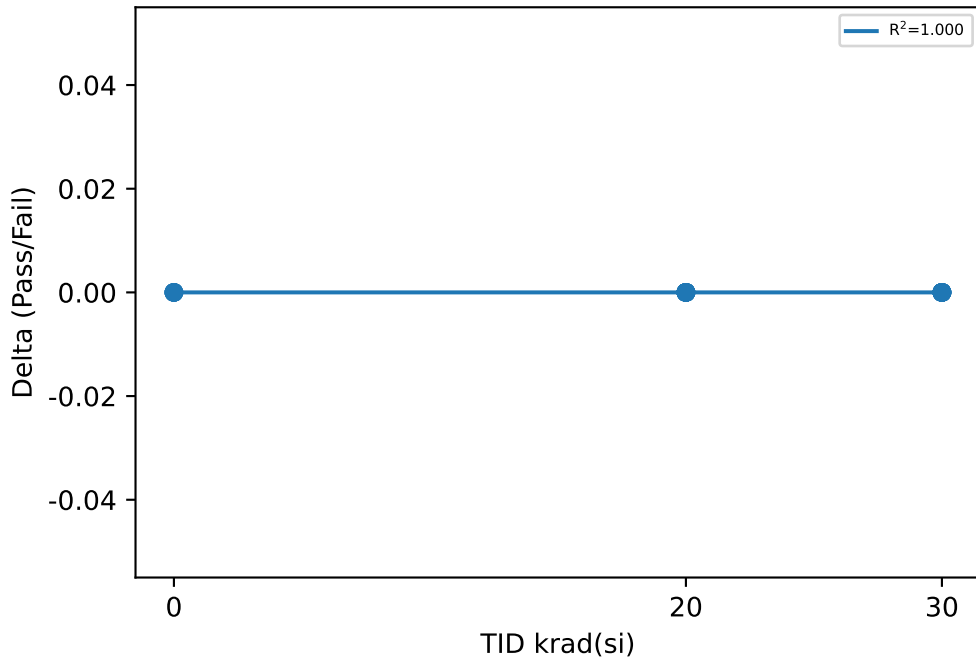

Test Results (Lower Limit = 0.9, Upper Limit = 1.1 (Pass/Fail))

Serial #	krad(si)	Exposure Conditions	Pre Result	Post Result	Delta
1	20	HDR unbiased	1	1	0
2	20	HDR unbiased	1	1	0
3	20	HDR unbiased	1	1	0
4	20	HDR unbiased	1	1	0
5	20	HDR unbiased	1	1	0
6	20	HDR biased	1	1	0
7	20	HDR biased	1	1	0
8	20	HDR biased	1	1	0
9	20	HDR biased	1	1	0
10	20	HDR biased	1	1	0
11	30	HDR unbiased	1	1	0
12	30	HDR unbiased	1	1	0
13	30	HDR unbiased	1	1	0
14	30	HDR unbiased	1	1	0
15	30	HDR unbiased	1	1	0
16	30	HDR biased	1	1	0
17	30	HDR biased	1	1	0
18	30	HDR biased	1	1	0
19	30	HDR biased	1	1	0
20	30	HDR biased	1	1	0
21	0	correlation	1	1	0
22	0	correlation	1	1	0
23	0	correlation	1	1	0
24	0	correlation	1	1	0
25	0	correlation	1	1	0

Test Statistics (Pass/Fail)

krad(si)	Pre Exposure Min	Pre Exposure Avg	Pre Exposure Max	Pre Exposure Std	Post Exposure Min	Post Exposure Avg	Post Exposure Max	Post Exposure Std	Min Delta	Avg Delta	Max Delta	Std Delta
0	1	1	1	0	1	1	1	0	0	0	0	0
20	1	1	1	0	1	1	1	0	0	0	0	0
30	1	1	1	0	1	1	1	0	0	0	0	0

Device Test: 7.141 UJVVXI(DIAG_Logic_Low_Go-No-Go_UJVVXI)

TID vs Result Stats

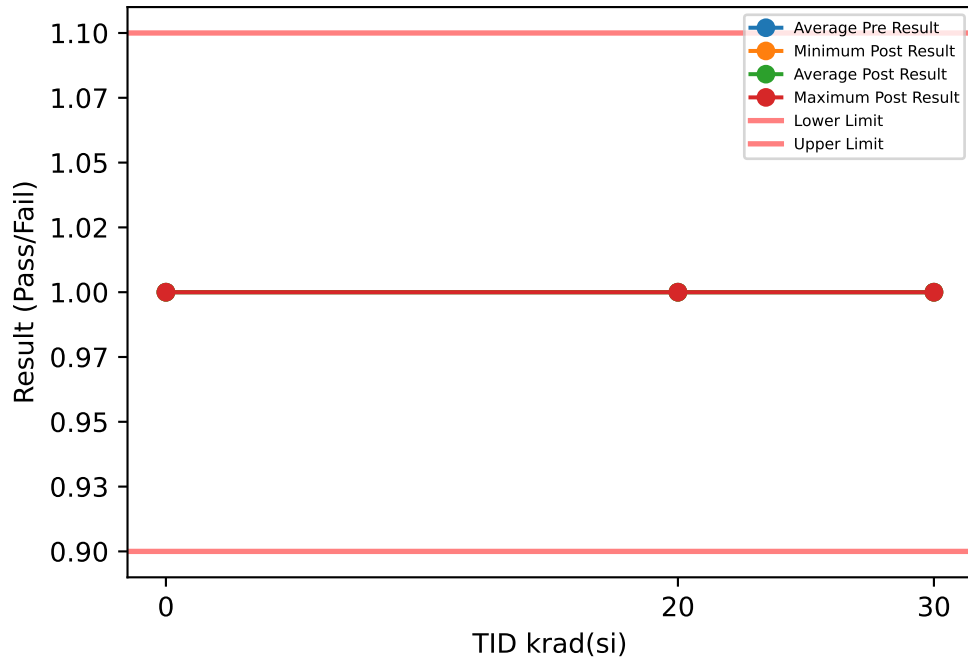

Test Results (Lower Limit = 0.9, Upper Limit = 1.1 (Pass/Fail))

Serial #	krad(si)	Exposure Conditions	Pre Result	Post Result	Delta
1	20	HDR unbiased	1	1	0
2	20	HDR unbiased	1	1	0
3	20	HDR unbiased	1	1	0
4	20	HDR unbiased	1	1	0
5	20	HDR unbiased	1	1	0
6	20	HDR biased	1	1	0
7	20	HDR biased	1	1	0
8	20	HDR biased	1	1	0
9	20	HDR biased	1	1	0
10	20	HDR biased	1	1	0
11	30	HDR unbiased	1	1	0
12	30	HDR unbiased	1	1	0
13	30	HDR unbiased	1	1	0
14	30	HDR unbiased	1	1	0
15	30	HDR unbiased	1	1	0
16	30	HDR biased	1	1	0
17	30	HDR biased	1	1	0
18	30	HDR biased	1	1	0
19	30	HDR biased	1	1	0
20	30	HDR biased	1	1	0
21	0	correlation	1	1	0
22	0	correlation	1	1	0
23	0	correlation	1	1	0
24	0	correlation	1	1	0
25	0	correlation	1	1	0

TID vs Post - Pre Exposure Delta

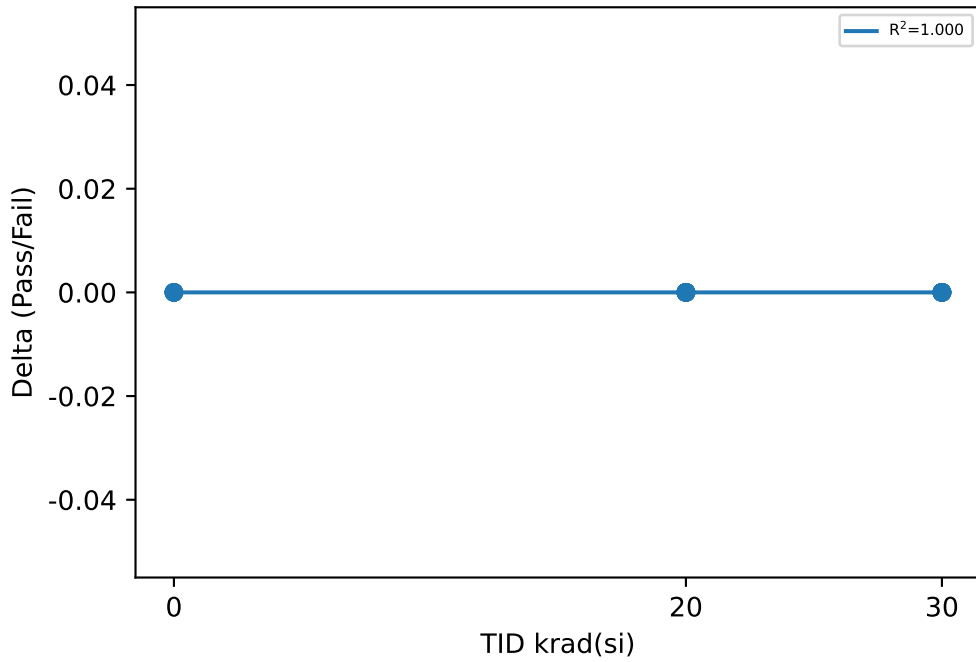

Test Statistics (Pass/Fail)

krad(si)	Pre Exposure Min	Pre Exposure Avg	Pre Exposure Max	Pre Exposure Std	Post Exposure Min	Post Exposure Avg	Post Exposure Max	Post Exposure Std	Min Delta	Avg Delta	Max Delta	Std Delta
0	1	1	1	0	1	1	1	0	0	0	0	0
20	1	1	1	0	1	1	1	0	0	0	0	0
30	1	1	1	0	1	1	1	0	0	0	0	0

Device Test: 7.161 UJTCWZ(SEH_Logic_High_Go-No-Go_UJTCWZ)

TID vs Result Stats

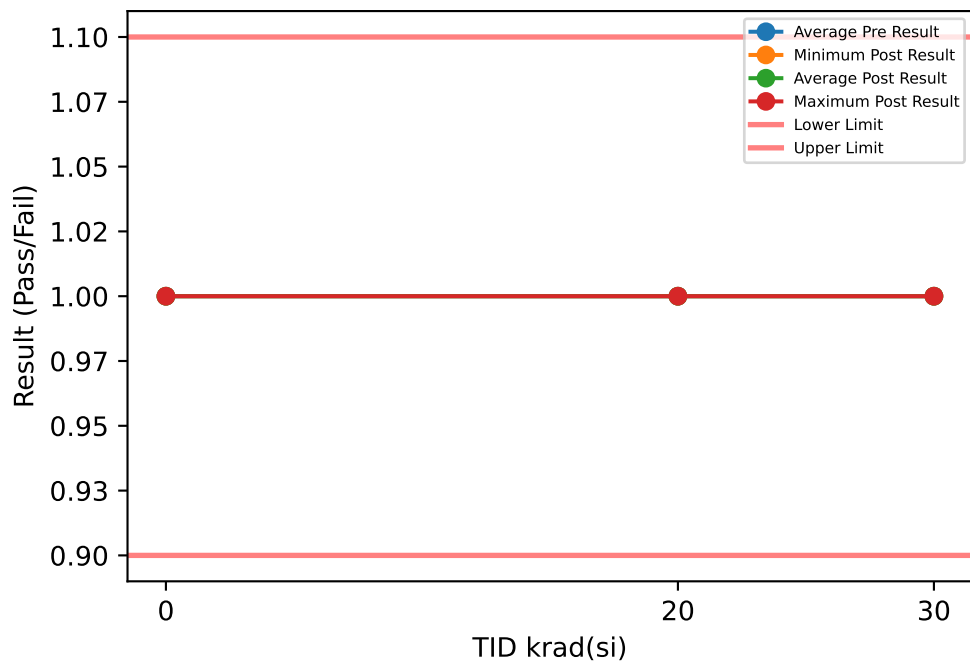

Test Results (Lower Limit = 0.9, Upper Limit = 1.1 (Pass/Fail))

Serial #	krad(si)	Exposure Conditions	Pre Result	Post Result	Delta
1	20	HDR unbiased	1	1	0
2	20	HDR unbiased	1	1	0
3	20	HDR unbiased	1	1	0
4	20	HDR unbiased	1	1	0
5	20	HDR unbiased	1	1	0
6	20	HDR biased	1	1	0
7	20	HDR biased	1	1	0
8	20	HDR biased	1	1	0
9	20	HDR biased	1	1	0
10	20	HDR biased	1	1	0
11	30	HDR unbiased	1	1	0
12	30	HDR unbiased	1	1	0
13	30	HDR unbiased	1	1	0
14	30	HDR unbiased	1	1	0
15	30	HDR unbiased	1	1	0
16	30	HDR biased	1	1	0
17	30	HDR biased	1	1	0
18	30	HDR biased	1	1	0
19	30	HDR biased	1	1	0
20	30	HDR biased	1	1	0
21	0	correlation	1	1	0
22	0	correlation	1	1	0
23	0	correlation	1	1	0
24	0	correlation	1	1	0
25	0	correlation	1	1	0

TID vs Post - Pre Exposure Delta

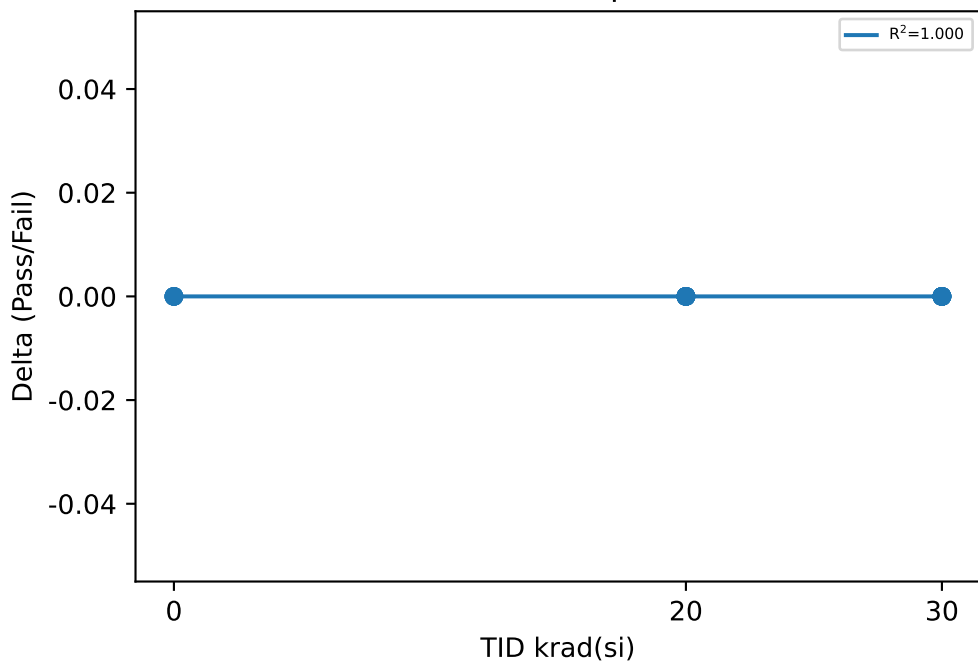

Test Statistics (Pass/Fail)

krad(si)	Pre Exposure Min	Pre Exposure Avg	Pre Exposure Max	Pre Exposure Std	Post Exposure Min	Post Exposure Avg	Post Exposure Max	Post Exposure Std	Min Delta	Avg Delta	Max Delta	Std Delta
0	1	1	1	0	1	1	1	0	0	0	0	0
20	1	1	1	0	1	1	1	0	0	0	0	0
30	1	1	1	0	1	1	1	0	0	0	0	0

Device Test: 7.171 UJVVXI(SEH_Logic_Low_Go-No-Go_UJVVXI)

TID vs Result Stats

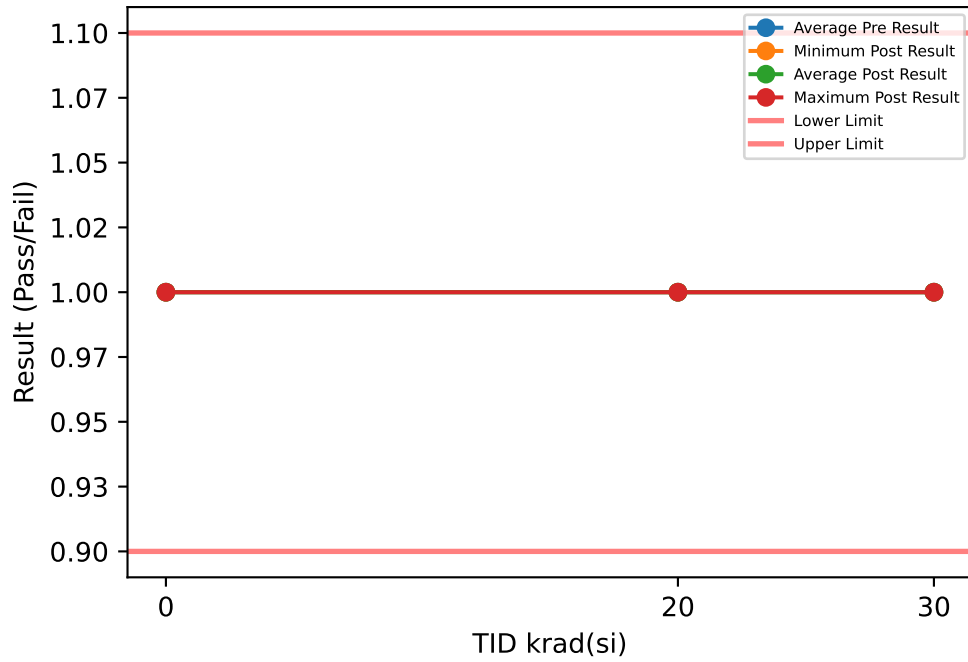

Test Results (Lower Limit = 0.9, Upper Limit = 1.1 (Pass/Fail))

Serial #	krad(si)	Exposure Conditions	Pre Result	Post Result	Delta
1	20	HDR unbiased	1	1	0
2	20	HDR unbiased	1	1	0
3	20	HDR unbiased	1	1	0
4	20	HDR unbiased	1	1	0
5	20	HDR unbiased	1	1	0
6	20	HDR biased	1	1	0
7	20	HDR biased	1	1	0
8	20	HDR biased	1	1	0
9	20	HDR biased	1	1	0
10	20	HDR biased	1	1	0
11	30	HDR unbiased	1	1	0
12	30	HDR unbiased	1	1	0
13	30	HDR unbiased	1	1	0
14	30	HDR unbiased	1	1	0
15	30	HDR unbiased	1	1	0
16	30	HDR biased	1	1	0
17	30	HDR biased	1	1	0
18	30	HDR biased	1	1	0
19	30	HDR biased	1	1	0
20	30	HDR biased	1	1	0
21	0	correlation	1	1	0
22	0	correlation	1	1	0
23	0	correlation	1	1	0
24	0	correlation	1	1	0
25	0	correlation	1	1	0

TID vs Post - Pre Exposure Delta

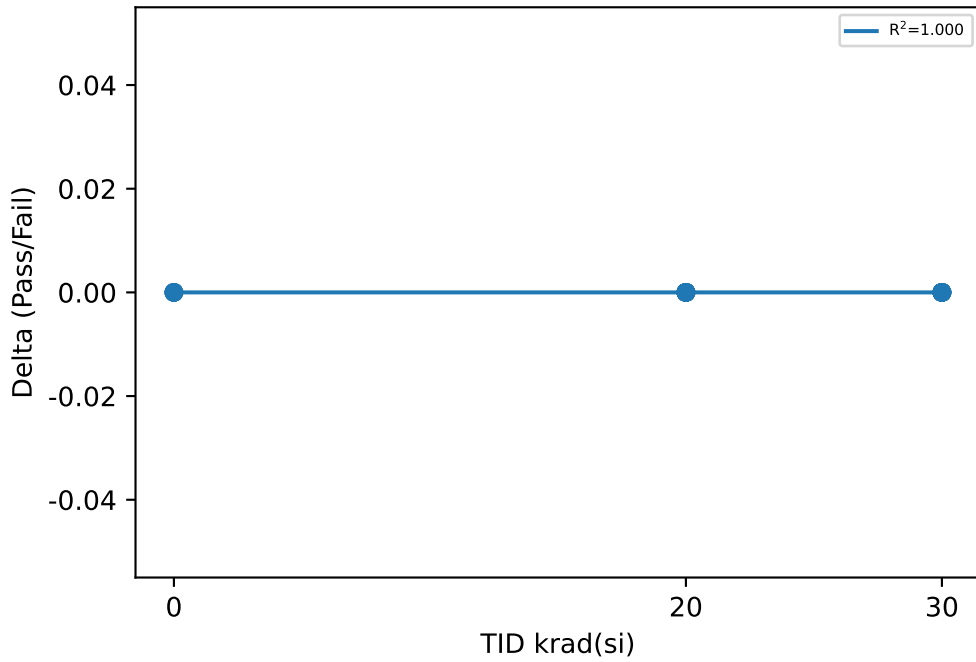

Test Statistics (Pass/Fail)

krad(si)	Pre Exposure Min	Pre Exposure Avg	Pre Exposure Max	Pre Exposure Std	Post Exposure Min	Post Exposure Avg	Post Exposure Max	Post Exposure Std	Min Delta	Avg Delta	Max Delta	Std Delta
0	1	1	1	0	1	1	1	0	0	0	0	0
20	1	1	1	0	1	1	1	0	0	0	0	0
30	1	1	1	0	1	1	1	0	0	0	0	0

Device Test: 7.191 UJTCWZ(SEL_Logic_High_Go-No-Go_UJTCWZ)

TID vs Result Stats

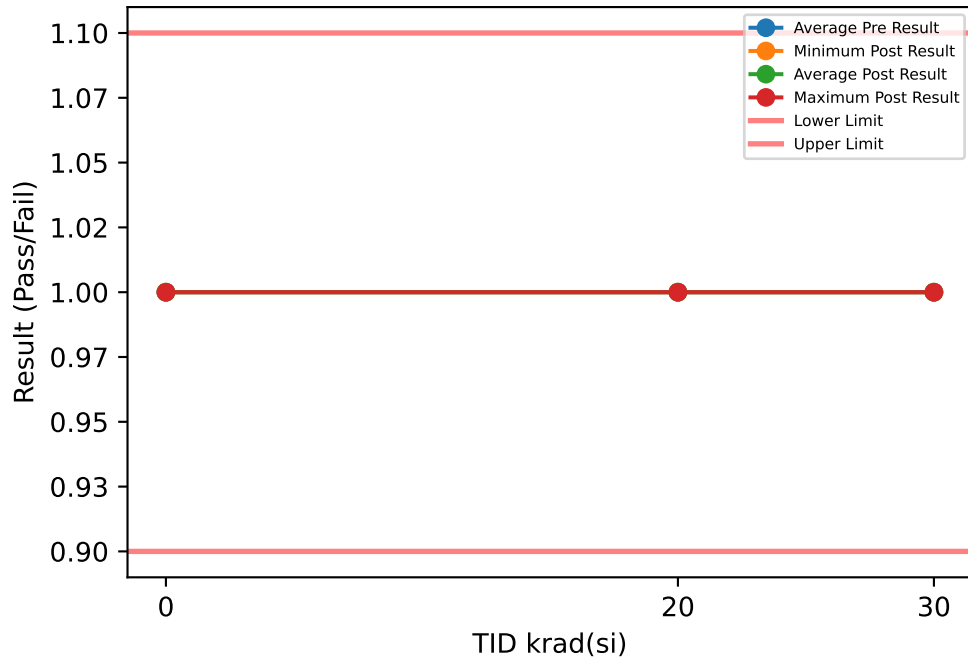

Test Results (Lower Limit = 0.9, Upper Limit = 1.1 (Pass/Fail))

Serial #	krad(si)	Exposure Conditions	Pre Result	Post Result	Delta
1	20	HDR unbiased	1	1	0
2	20	HDR unbiased	1	1	0
3	20	HDR unbiased	1	1	0
4	20	HDR unbiased	1	1	0
5	20	HDR unbiased	1	1	0
6	20	HDR biased	1	1	0
7	20	HDR biased	1	1	0
8	20	HDR biased	1	1	0
9	20	HDR biased	1	1	0
10	20	HDR biased	1	1	0
11	30	HDR unbiased	1	1	0
12	30	HDR unbiased	1	1	0
13	30	HDR unbiased	1	1	0
14	30	HDR unbiased	1	1	0
15	30	HDR unbiased	1	1	0
16	30	HDR biased	1	1	0
17	30	HDR biased	1	1	0
18	30	HDR biased	1	1	0
19	30	HDR biased	1	1	0
20	30	HDR biased	1	1	0
21	0	correlation	1	1	0
22	0	correlation	1	1	0
23	0	correlation	1	1	0
24	0	correlation	1	1	0
25	0	correlation	1	1	0

TID vs Post - Pre Exposure Delta

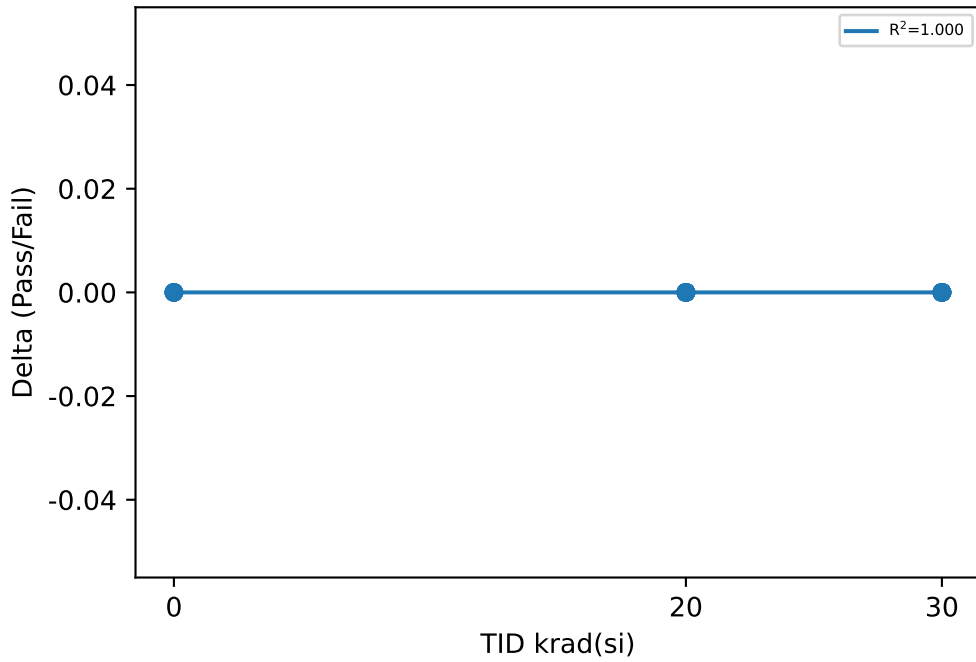

Test Statistics (Pass/Fail)

krad(si)	Pre Exposure Min	Pre Exposure Avg	Pre Exposure Max	Pre Exposure Std	Post Exposure Min	Post Exposure Avg	Post Exposure Max	Post Exposure Std	Min Delta	Avg Delta	Max Delta	Std Delta
0	1	1	1	0	1	1	1	0	0	0	0	0
20	1	1	1	0	1	1	1	0	0	0	0	0
30	1	1	1	0	1	1	1	0	0	0	0	0

Device Test: 7.2001 UJVVXI(SEL_Logic_Low_Go-No-Go_UJVVXI)

TID vs Result Stats

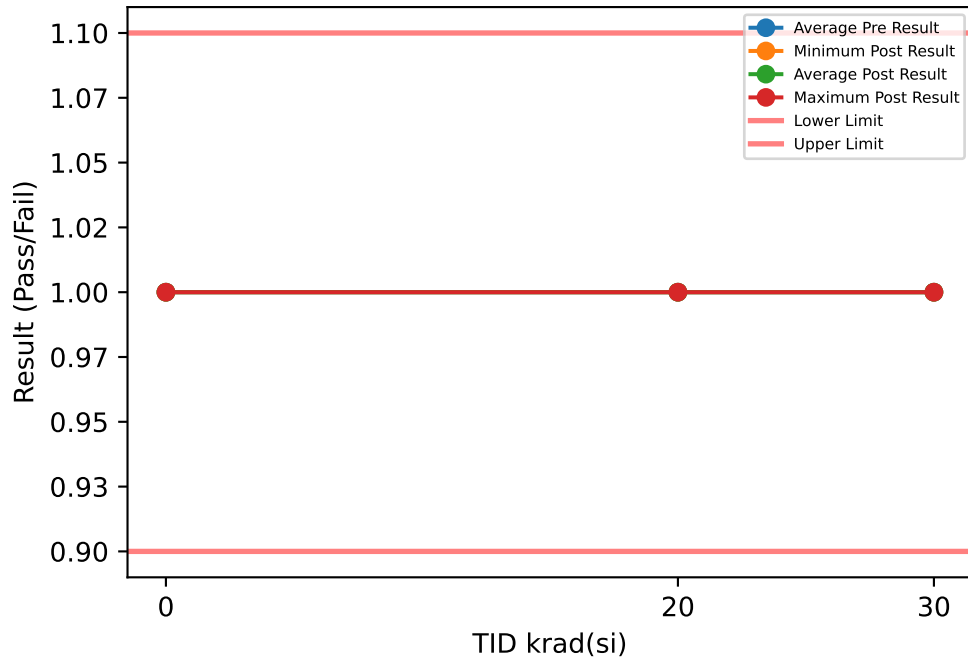

TID vs Post - Pre Exposure Delta

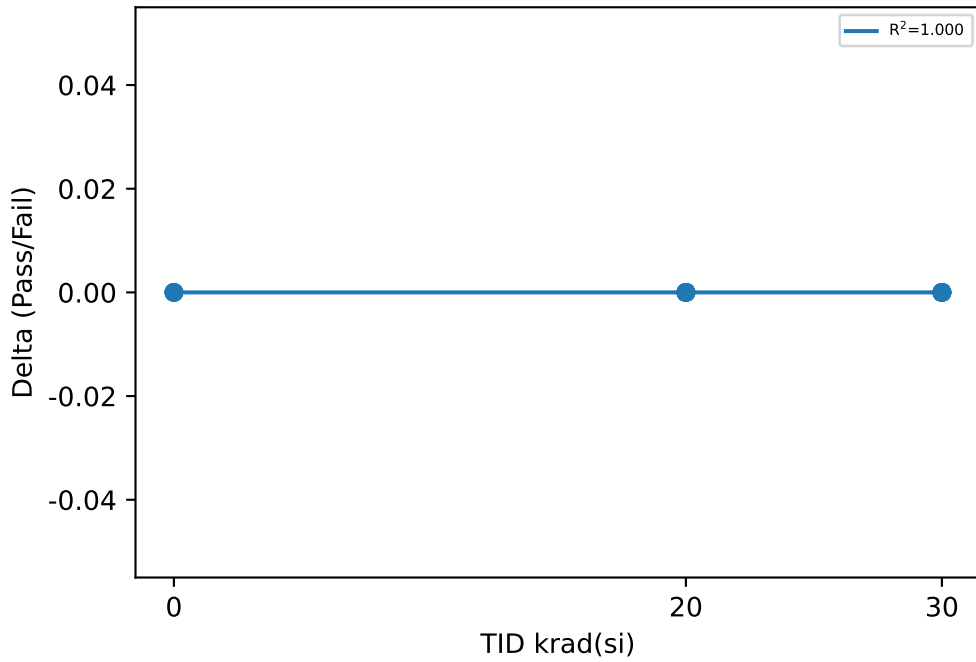

Test Results (Lower Limit = 0.9, Upper Limit = 1.1 (Pass/Fail))

Serial #	krad(si)	Exposure Conditions	Pre Result	Post Result	Delta
1	20	HDR unbiased	1	1	0
2	20	HDR unbiased	1	1	0
3	20	HDR unbiased	1	1	0
4	20	HDR unbiased	1	1	0
5	20	HDR unbiased	1	1	0
6	20	HDR biased	1	1	0
7	20	HDR biased	1	1	0
8	20	HDR biased	1	1	0
9	20	HDR biased	1	1	0
10	20	HDR biased	1	1	0
11	30	HDR unbiased	1	1	0
12	30	HDR unbiased	1	1	0
13	30	HDR unbiased	1	1	0
14	30	HDR unbiased	1	1	0
15	30	HDR unbiased	1	1	0
16	30	HDR biased	1	1	0
17	30	HDR biased	1	1	0
18	30	HDR biased	1	1	0
19	30	HDR biased	1	1	0
20	30	HDR biased	1	1	0
21	0	correlation	1	1	0
22	0	correlation	1	1	0
23	0	correlation	1	1	0
24	0	correlation	1	1	0
25	0	correlation	1	1	0

Test Statistics (Pass/Fail)

krad(si)	Pre Exposure Min	Pre Exposure Avg	Pre Exposure Max	Pre Exposure Std	Post Exposure Min	Post Exposure Avg	Post Exposure Max	Post Exposure Std	Min Delta	Avg Delta	Max Delta	Std Delta
0	1	1	1	0	1	1	1	0	0	0	0	0
20	1	1	1	0	1	1	1	0	0	0	0	0
30	1	1	1	0	1	1	1	0	0	0	0	0

Device Test: 7.201 UJVVXI(EN1_Logic_Low_Go-No-Go_UJVVXI)

TID vs Result Stats

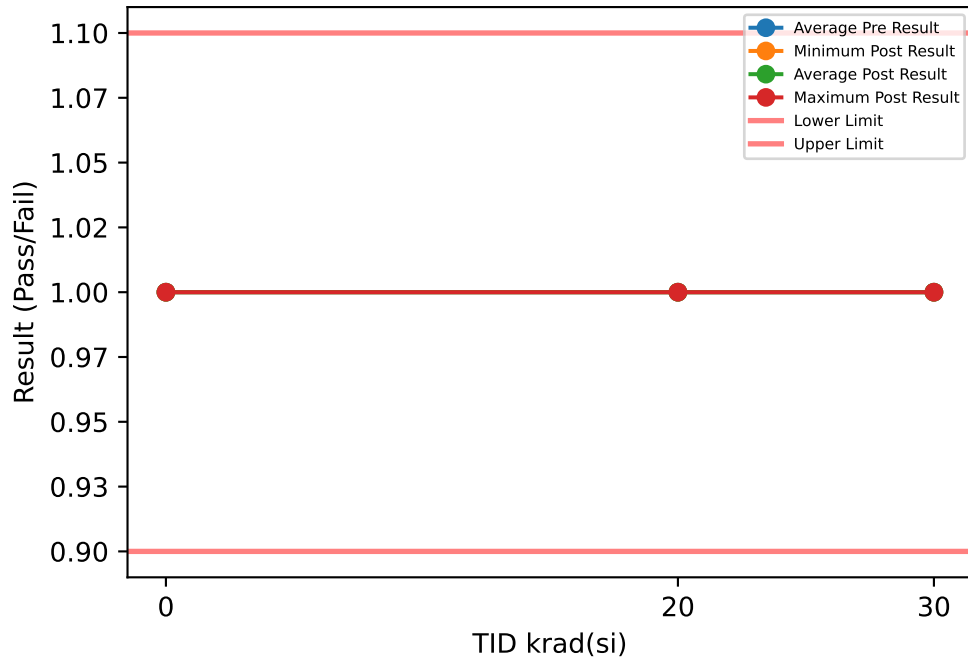

TID vs Post - Pre Exposure Delta

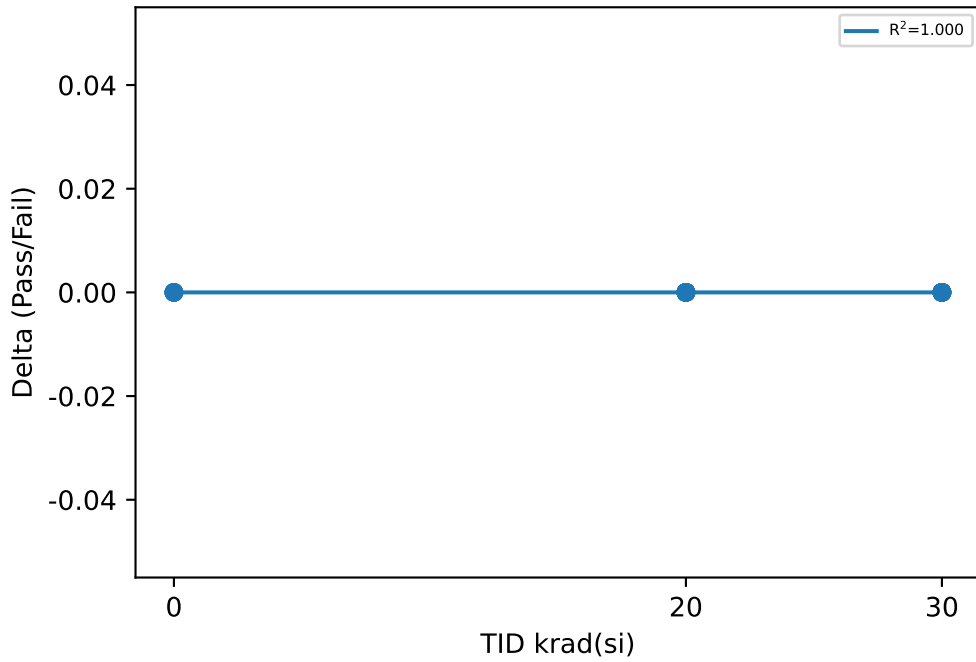

Test Results (Lower Limit = 0.9, Upper Limit = 1.1 (Pass/Fail))

Serial #	krad(si)	Exposure Conditions	Pre Result	Post Result	Delta
1	20	HDR unbiased	1	1	0
2	20	HDR unbiased	1	1	0
3	20	HDR unbiased	1	1	0
4	20	HDR unbiased	1	1	0
5	20	HDR unbiased	1	1	0
6	20	HDR biased	1	1	0
7	20	HDR biased	1	1	0
8	20	HDR biased	1	1	0
9	20	HDR biased	1	1	0
10	20	HDR biased	1	1	0
11	30	HDR unbiased	1	1	0
12	30	HDR unbiased	1	1	0
13	30	HDR unbiased	1	1	0
14	30	HDR unbiased	1	1	0
15	30	HDR unbiased	1	1	0
16	30	HDR biased	1	1	0
17	30	HDR biased	1	1	0
18	30	HDR biased	1	1	0
19	30	HDR biased	1	1	0
20	30	HDR biased	1	1	0
21	0	correlation	1	1	0
22	0	correlation	1	1	0
23	0	correlation	1	1	0
24	0	correlation	1	1	0
25	0	correlation	1	1	0

Test Statistics (Pass/Fail)

krad(si)	Pre Exposure Min	Pre Exposure Avg	Pre Exposure Max	Pre Exposure Std	Post Exposure Min	Post Exposure Avg	Post Exposure Max	Post Exposure Std	Min Delta	Avg Delta	Max Delta	Std Delta
0	1	1	1	0	1	1	1	0	0	0	0	0
20	1	1	1	0	1	1	1	0	0	0	0	0
30	1	1	1	0	1	1	1	0	0	0	0	0

Device Test: 7.22 UJQE20(EN1_Pulldown_Resistor_UJQE20)

TID vs Result Stats

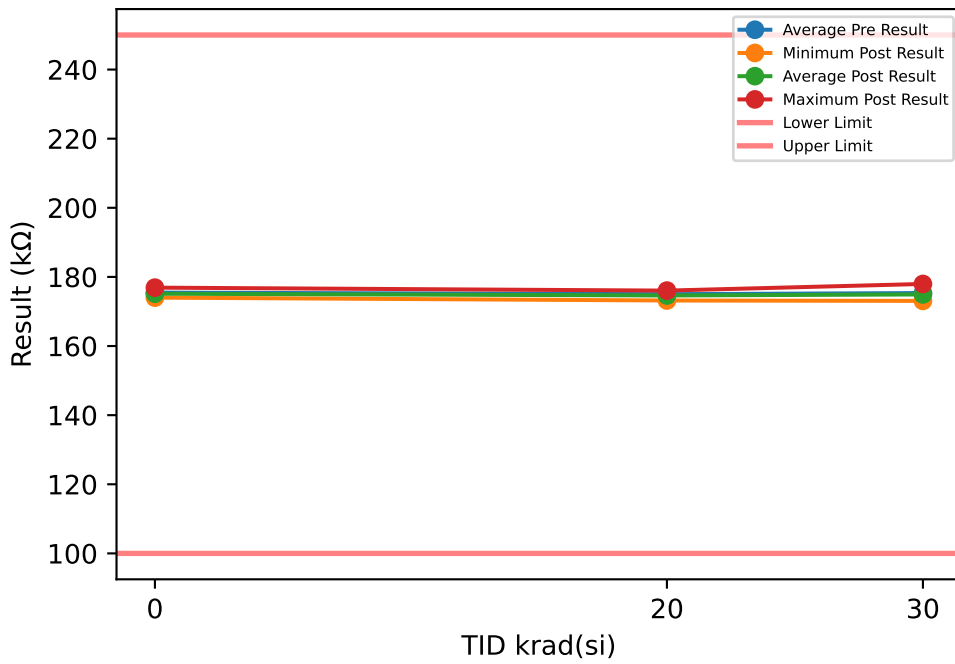

Test Results (Lower Limit = 100.0, Upper Limit = 250.0 (kΩ))

Serial #	krad(si)	Exposure Conditions	Pre Result	Post Result	Delta
1	20	HDR unbiased	173.33	173.18	-0.1467
2	20	HDR unbiased	174.92	174.68	-0.2449
3	20	HDR unbiased	176.22	176.04	-0.1751
4	20	HDR unbiased	175.27	174.87	-0.402
5	20	HDR unbiased	174.39	174.09	-0.3032
6	20	HDR biased	174.27	175.29	1.0149
7	20	HDR biased	175.15	174.81	-0.3415
8	20	HDR biased	175.26	174.74	-0.522
9	20	HDR biased	175.44	174.84	-0.5951
10	20	HDR biased	175.78	173.76	-2.0201
11	30	HDR unbiased	178.38	177.96	-0.4154
12	30	HDR unbiased	175.23	174.9	-0.3298
13	30	HDR unbiased	175.55	175.16	-0.3912
14	30	HDR unbiased	175.87	174.44	-1.4385
15	30	HDR unbiased	175.22	174.86	-0.3658
16	30	HDR biased	173.5	173.06	-0.4416
17	30	HDR biased	175.25	174.81	-0.4379
18	30	HDR biased	173.82	173.64	-0.183
19	30	HDR biased	174.79	175.47	0.6818
20	30	HDR biased	175.68	175.05	-0.6327
21	0	correlation	174.41	174.01	-0.3984
22	0	correlation	175.55	175.28	-0.2706
23	0	correlation	175.29	174.89	-0.4022
24	0	correlation	174.8	174.62	-0.1847
25	0	correlation	177.26	176.9	-0.3615

TID vs Post - Pre Exposure Delta

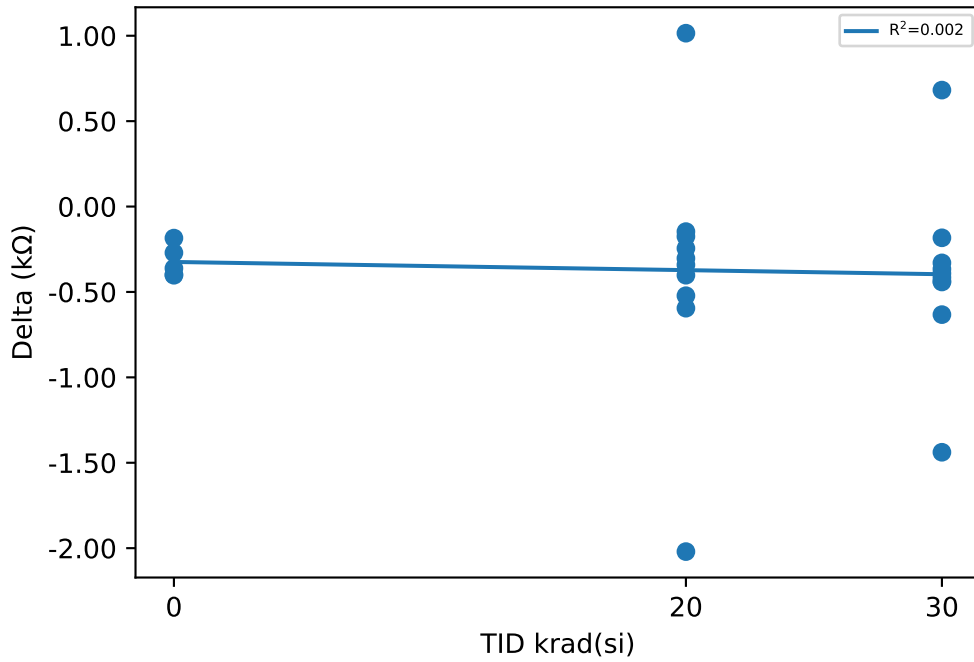

Test Statistics (kΩ)

krad(si)	Pre Exposure Min	Pre Exposure Avg	Pre Exposure Max	Pre Exposure Std	Post Exposure Min	Post Exposure Avg	Post Exposure Max	Post Exposure Std	Min Delta	Avg Delta	Max Delta	Std Delta
0	174.41	175.46	177.26	1.0973	174.01	175.14	176.9	1.0869	-0.4022	-0.32348	-0.1847	0.093957
20	173.33	175	176.22	0.82612	173.18	174.63	176.04	0.7979	-2.0201	-0.37357	1.0149	0.73214
30	173.5	175.33	178.38	1.3199	173.06	174.93	177.96	1.2895	-1.4385	-0.39541	0.6818	0.51201

Device Test: 7.23 UJQE20(EN2_Pulldown_Resistor_UJQE20)

TID vs Result Stats

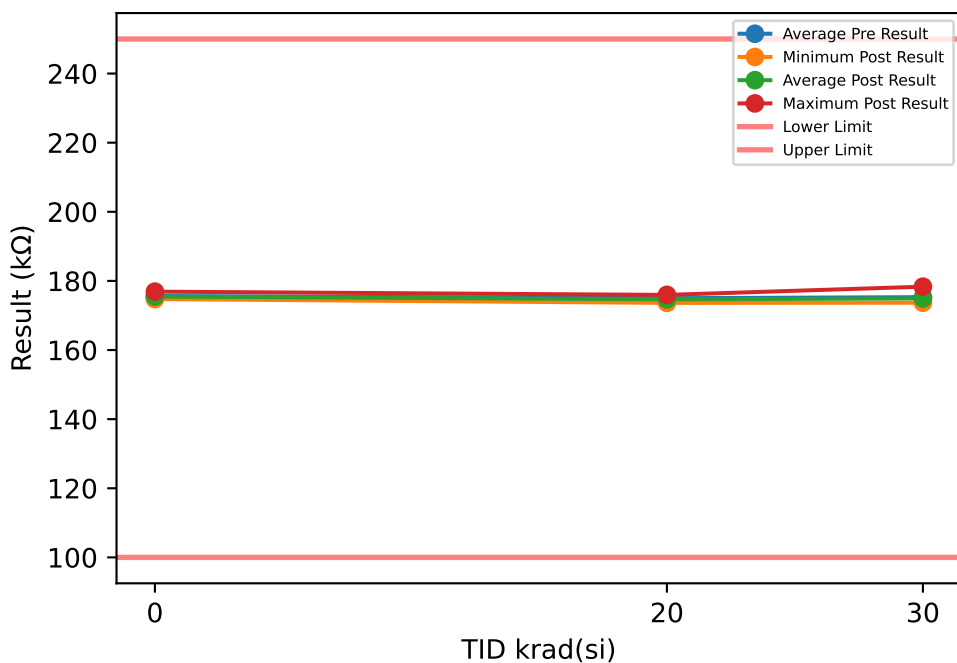

Test Results (Lower Limit = 100.0, Upper Limit = 250.0 (kΩ))

Serial #	krad(si)	Exposure Conditions	Pre Result	Post Result	Delta
1	20	HDR unbiased	173.69	173.64	-0.0473
2	20	HDR unbiased	175.2	174.95	-0.2525
3	20	HDR unbiased	176.2	175.95	-0.2432
4	20	HDR unbiased	175	174.83	-0.168
5	20	HDR unbiased	174.3	174.09	-0.2143
6	20	HDR biased	174.33	175.12	0.7915
7	20	HDR biased	175.38	174.99	-0.3975
8	20	HDR biased	175.16	174.58	-0.5762
9	20	HDR biased	175.22	174.74	-0.4807
10	20	HDR biased	175.54	173.79	-1.7491
11	30	HDR unbiased	178.6	178.33	-0.2621
12	30	HDR unbiased	174.84	174.59	-0.2515
13	30	HDR unbiased	175.47	175.29	-0.181
14	30	HDR unbiased	175.82	174.64	-1.1815
15	30	HDR unbiased	175.04	174.76	-0.2761
16	30	HDR biased	174.08	173.69	-0.3917
17	30	HDR biased	174.83	173.92	-0.9074
18	30	HDR biased	173.89	173.71	-0.1778
19	30	HDR biased	175	175.35	0.3498
20	30	HDR biased	175.45	175.01	-0.4339
21	0	correlation	175.74	175.45	-0.2903
22	0	correlation	175.58	175.4	-0.1812
23	0	correlation	174.9	174.75	-0.1558
24	0	correlation	174.88	174.86	-0.0238
25	0	correlation	177.1	176.9	-0.2088

TID vs Post - Pre Exposure Delta

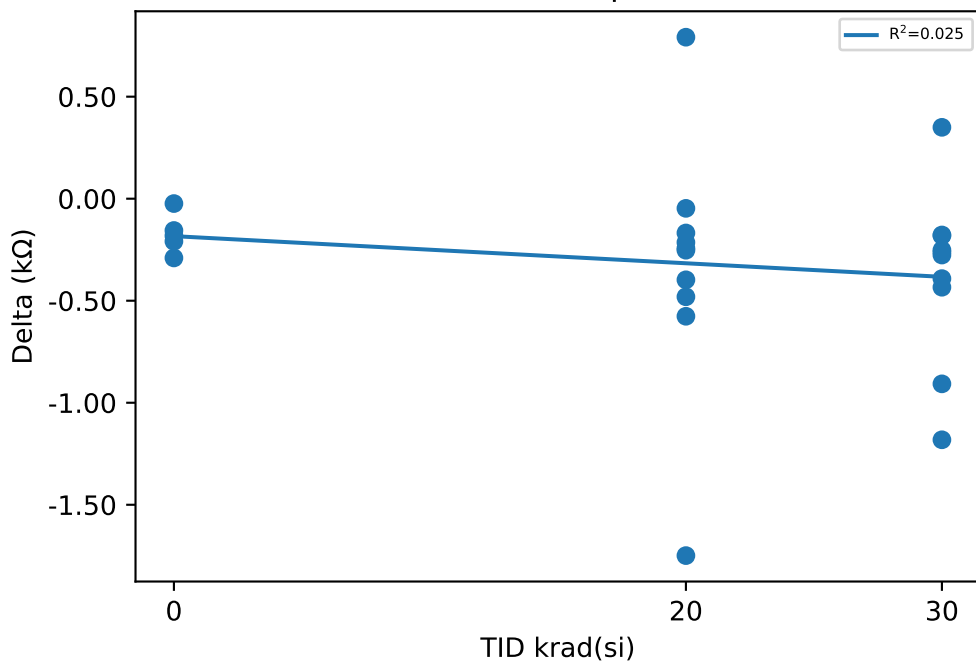

Test Statistics (kΩ)

krad(si)	Pre Exposure Min	Pre Exposure Avg	Pre Exposure Max	Pre Exposure Std	Post Exposure Min	Post Exposure Avg	Post Exposure Max	Post Exposure Std	Min Delta	Avg Delta	Max Delta	Std Delta
0	174.88	175.64	177.1	0.90571	174.75	175.47	176.9	0.85733	-0.2903	-0.17198	-0.0238	0.09703
20	173.69	175	176.2	0.71888	173.64	174.67	175.95	0.6864	-1.7491	-0.33373	0.7915	0.62294
30	173.89	175.3	178.6	1.3021	173.69	174.93	178.33	1.3404	-1.1815	-0.37132	0.3498	0.41861

Device Test: 7.24 UJQE20(EN3_Pulldown_Resistor_UJQE20)

TID vs Result Stats

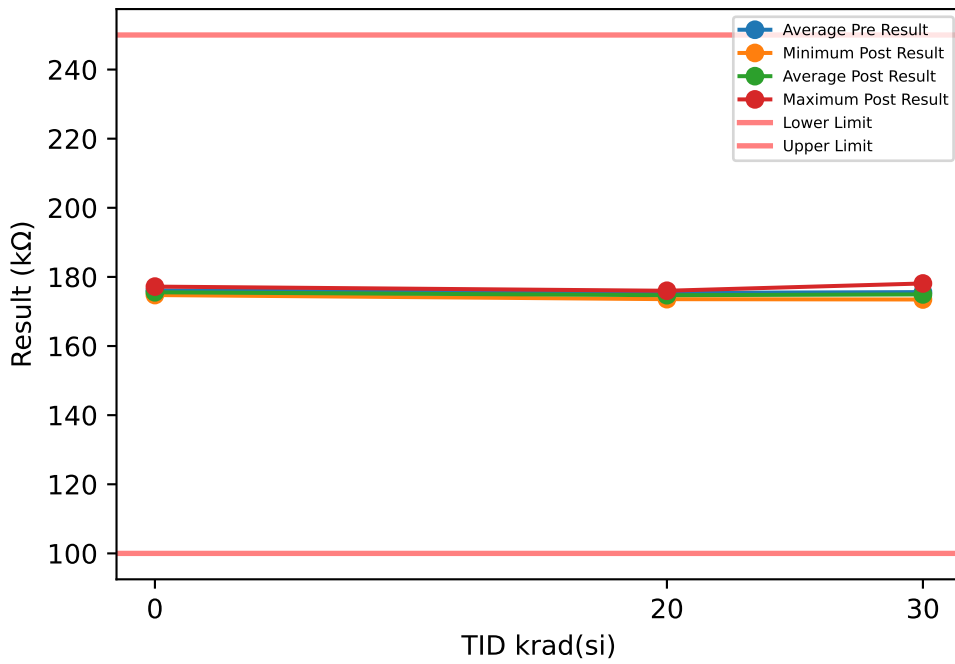

TID vs Post - Pre Exposure Delta

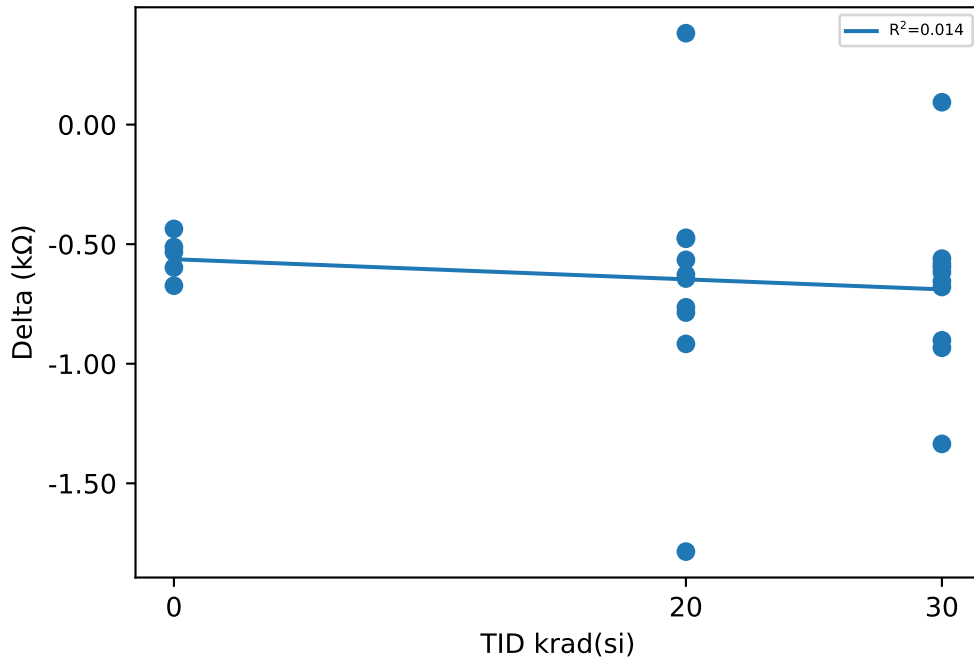

Test Results (Lower Limit = 100.0, Upper Limit = 250.0 (kΩ))

Serial #	krad(si)	Exposure Conditions	Pre Result	Post Result	Delta
1	20	HDR unbiased	174.04	173.56	-0.4774
2	20	HDR unbiased	175.36	174.88	-0.4733
3	20	HDR unbiased	176.62	176	-0.627
4	20	HDR unbiased	175.66	175.02	-0.6437
5	20	HDR unbiased	174.83	174.26	-0.5657
6	20	HDR biased	174.83	175.21	0.3822
7	20	HDR biased	175.65	174.88	-0.7639
8	20	HDR biased	175.37	174.45	-0.917
9	20	HDR biased	175.44	174.66	-0.786
10	20	HDR biased	175.93	174.14	-1.7855
11	30	HDR unbiased	178.76	178.1	-0.6556
12	30	HDR unbiased	175.33	174.72	-0.6172
13	30	HDR unbiased	175.81	175.25	-0.5604
14	30	HDR unbiased	176.17	174.84	-1.3352
15	30	HDR unbiased	175.38	174.8	-0.5815
16	30	HDR biased	174.67	173.74	-0.9332
17	30	HDR biased	175.56	174.88	-0.679
18	30	HDR biased	174.06	173.47	-0.5959
19	30	HDR biased	175.28	175.38	0.0935
20	30	HDR biased	175.07	174.17	-0.9019
21	0	correlation	176.37	175.69	-0.6735
22	0	correlation	175.95	175.35	-0.5977
23	0	correlation	175.19	174.75	-0.4362
24	0	correlation	175.3	174.76	-0.5329
25	0	correlation	177.71	177.2	-0.5118

Test Statistics (kΩ)

krad(si)	Pre Exposure Min	Pre Exposure Avg	Pre Exposure Max	Pre Exposure Std	Post Exposure Min	Post Exposure Avg	Post Exposure Max	Post Exposure Std	Min Delta	Avg Delta	Max Delta	Std Delta
0	175.19	176.1	177.71	1.0199	174.75	175.55	177.2	1.0037	-0.6735	-0.55042	-0.4362	0.089762
20	174.04	175.37	176.62	0.70042	173.56	174.71	176	0.66461	-1.7855	-0.66573	0.3822	0.52955
30	174.06	175.61	178.76	1.2509	173.47	174.93	178.1	1.2735	-1.3352	-0.67664	0.0935	0.36155

Device Test: 7.25 UJQE20(EN4_Pulldown_Resistor_UJQE20)

TID vs Result Stats

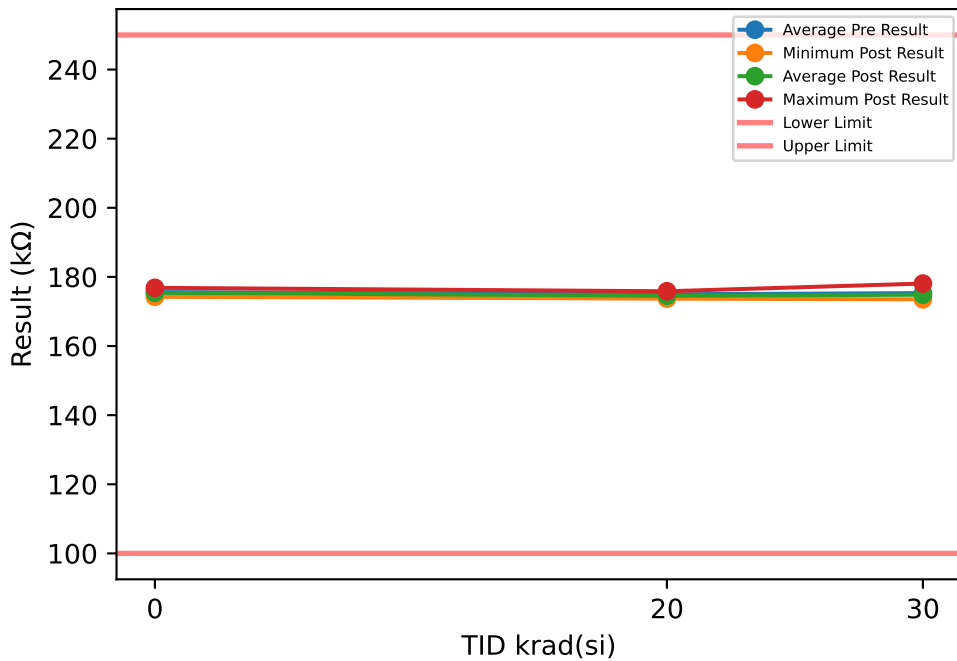

TID vs Post - Pre Exposure Delta

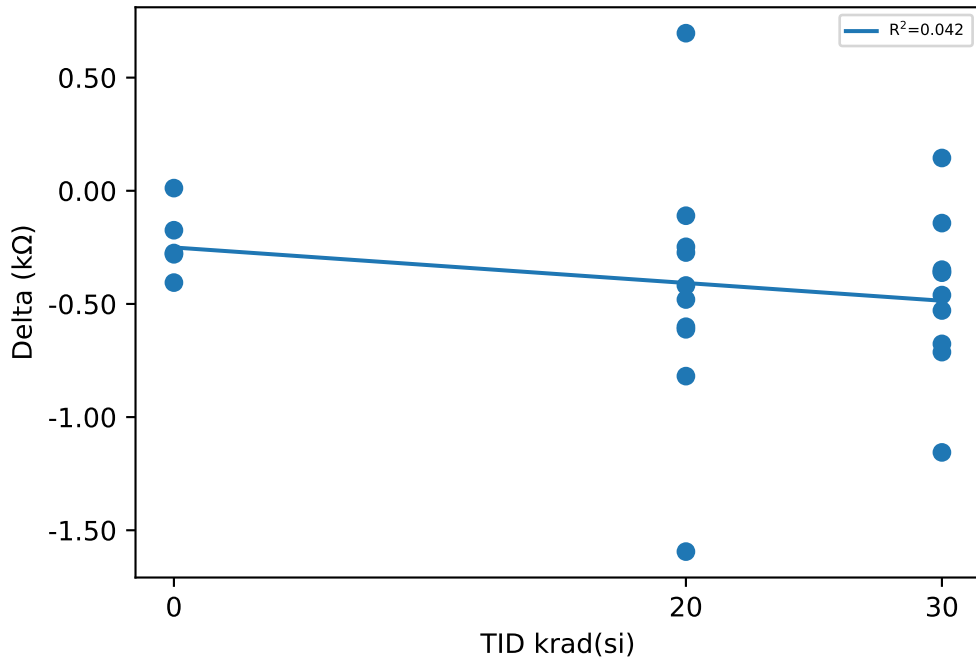

Test Results (Lower Limit = 100.0, Upper Limit = 250.0 (kΩ))

Serial #	krad(si)	Exposure Conditions	Pre Result	Post Result	Delta
1	20	HDR unbiased	173.96	173.71	-0.2476
2	20	HDR unbiased	174.8	174.38	-0.4185
3	20	HDR unbiased	175.96	175.85	-0.1102
4	20	HDR unbiased	175.15	174.67	-0.4805
5	20	HDR unbiased	174.32	174.05	-0.2729
6	20	HDR biased	174.33	175.03	0.6963
7	20	HDR biased	175.12	174.51	-0.6121
8	20	HDR biased	175.2	174.6	-0.6007
9	20	HDR biased	175.49	174.67	-0.819
10	20	HDR biased	175.48	173.88	-1.5943
11	30	HDR unbiased	178.61	178.08	-0.529
12	30	HDR unbiased	174.62	174.48	-0.1428
13	30	HDR unbiased	175.4	175.04	-0.3619
14	30	HDR unbiased	175.63	174.48	-1.156
15	30	HDR unbiased	175.15	174.8	-0.3486
16	30	HDR biased	174.32	173.64	-0.6765
17	30	HDR biased	174.73	174.37	-0.3583
18	30	HDR biased	173.99	173.53	-0.4609
19	30	HDR biased	174.98	175.12	0.1449
20	30	HDR biased	175.68	174.97	-0.7129
21	0	correlation	176.07	175.79	-0.2807
22	0	correlation	175.54	175.55	0.0118
23	0	correlation	174.66	174.25	-0.4057
24	0	correlation	174.81	174.54	-0.275
25	0	correlation	177.01	176.84	-0.1743

Test Statistics (kΩ)

krad(si)	Pre Exposure Min	Pre Exposure Avg	Pre Exposure Max	Pre Exposure Std	Post Exposure Min	Post Exposure Avg	Post Exposure Max	Post Exposure Std	Min Delta	Avg Delta	Max Delta	Std Delta
0	174.66	175.62	177.01	0.96673	174.25	175.39	176.84	1.0387	-0.4057	-0.22478	0.0118	0.15564
20	173.96	174.98	175.96	0.62221	173.71	174.53	175.85	0.61251	-1.5943	-0.44595	0.6963	0.57717
30	173.99	175.31	178.61	1.2822	173.53	174.85	178.08	1.2588	-1.156	-0.4602	0.1449	0.34943

Device Test: 7.26 UJQE20(SEH_Pulldown_Resistor_UJQE20)

TID vs Result Stats

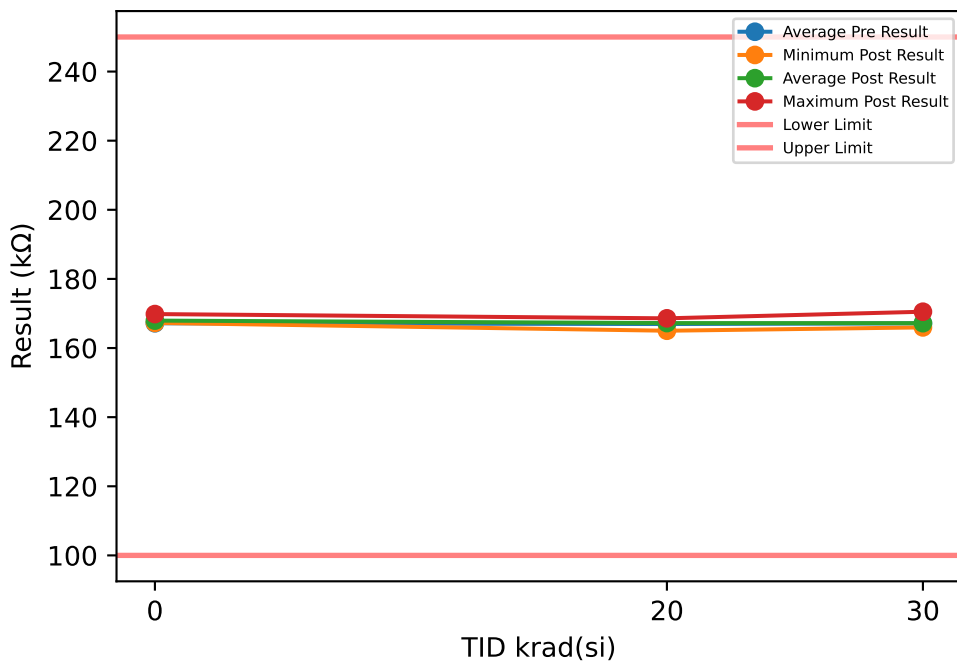

Test Results (Lower Limit = 100.0, Upper Limit = 250.0 (kΩ))

Serial #	krad(si)	Exposure Conditions	Pre Result	Post Result	Delta
1	20	HDR unbiased	165.23	165.01	-0.2255
2	20	HDR unbiased	167.4	167.82	0.4269
3	20	HDR unbiased	168.94	168.6	-0.3459
4	20	HDR unbiased	167.83	168.26	0.4292
5	20	HDR unbiased	165.45	167.06	1.6076
6	20	HDR biased	165.98	167.82	1.838
7	20	HDR biased	166.52	166.51	-0.0123
8	20	HDR biased	166.74	167.49	0.7516
9	20	HDR biased	168.28	166.84	-1.4382
10	20	HDR biased	167.07	166.84	-0.2301
11	30	HDR unbiased	171.66	170.51	-1.1555
12	30	HDR unbiased	167.18	166.4	-0.7732
13	30	HDR unbiased	166.52	168.04	1.5185
14	30	HDR unbiased	167.18	166.51	-0.6649
15	30	HDR unbiased	166.85	167.82	0.9725
16	30	HDR biased	167.07	166.19	-0.8802
17	30	HDR biased	167.18	166.51	-0.6649
18	30	HDR biased	164.6	166.73	2.1322
19	30	HDR biased	165.77	167.27	1.5045
20	30	HDR biased	167.4	165.97	-1.4235
21	0	correlation	167.94	167.49	-0.4518
22	0	correlation	167.72	167.6	-0.122
23	0	correlation	165.23	167.27	2.0396
24	0	correlation	166.52	167.49	0.9686
25	0	correlation	168.39	169.83	1.4406

TID vs Post - Pre Exposure Delta

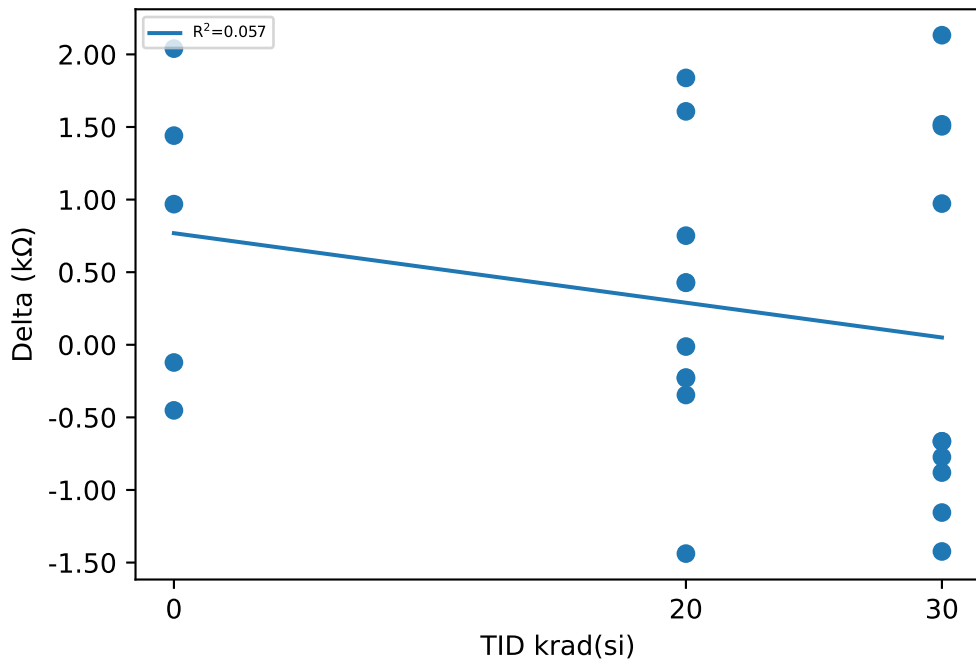

Test Statistics (kΩ)

krad(si)	Pre Exposure Min	Pre Exposure Avg	Pre Exposure Max	Pre Exposure Std	Post Exposure Min	Post Exposure Avg	Post Exposure Max	Post Exposure Std	Min Delta	Avg Delta	Max Delta	Std Delta
0	165.23	167.16	168.39	1.2798	167.27	167.94	169.83	1.0629	-0.4518	0.775	2.0396	1.0475
20	165.23	166.94	168.94	1.2055	165.01	167.23	168.6	1.0271	-1.4382	0.28013	1.838	0.96616
30	164.6	167.14	171.66	1.8052	165.97	167.2	170.51	1.3486	-1.4235	0.05655	2.1322	1.3186

Device Test: 7.27 UJQE20(SEL_Pulldown_Resistor_UJQE20)

TID vs Result Stats

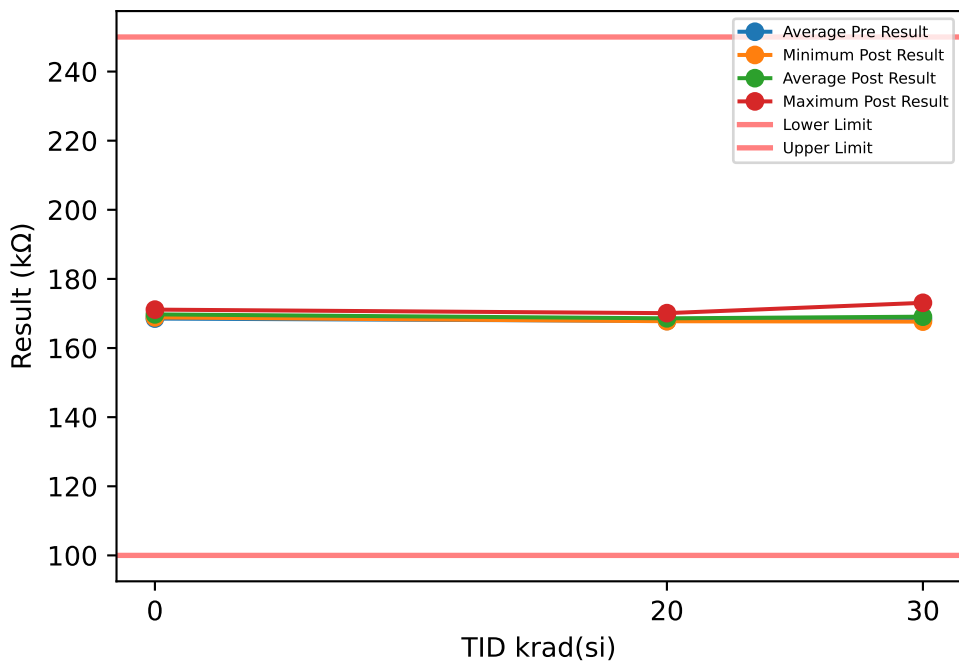

Test Results (Lower Limit = 100.0, Upper Limit = 250.0 (kΩ))

Serial #	krad(si)	Exposure Conditions	Pre Result	Post Result	Delta
1	20	HDR unbiased	165.81	167.75	1.9437
2	20	HDR unbiased	168.32	169.53	1.2131
3	20	HDR unbiased	168.54	170.09	1.5547
4	20	HDR unbiased	167.11	167.75	0.6447
5	20	HDR unbiased	166.35	168.3	1.9562
6	20	HDR biased	167.22	169.19	1.9766
7	20	HDR biased	168.87	168.86	-0.0129
8	20	HDR biased	168.43	167.86	-0.5649
9	20	HDR biased	167.88	168.64	0.7614
10	20	HDR biased	169.99	167.97	-2.0207
11	30	HDR unbiased	170.67	173.08	2.4092
12	30	HDR unbiased	168.65	169.08	0.4326
13	30	HDR unbiased	169.1	170.09	0.998
14	30	HDR unbiased	169.32	167.64	-1.676
15	30	HDR unbiased	168.1	168.41	0.3191
16	30	HDR biased	167.99	168.41	0.4294
17	30	HDR biased	167.33	167.97	0.6463
18	30	HDR biased	166.56	168.08	1.5188
19	30	HDR biased	166.78	169.19	2.4125
20	30	HDR biased	168.43	168.75	0.3203
21	0	correlation	168.76	169.42	0.6571
22	0	correlation	168.65	170.21	1.5567
23	0	correlation	167.66	168.86	1.2038
24	0	correlation	167.99	169.08	1.0967
25	0	correlation	169.54	171.12	1.5732

TID vs Post - Pre Exposure Delta

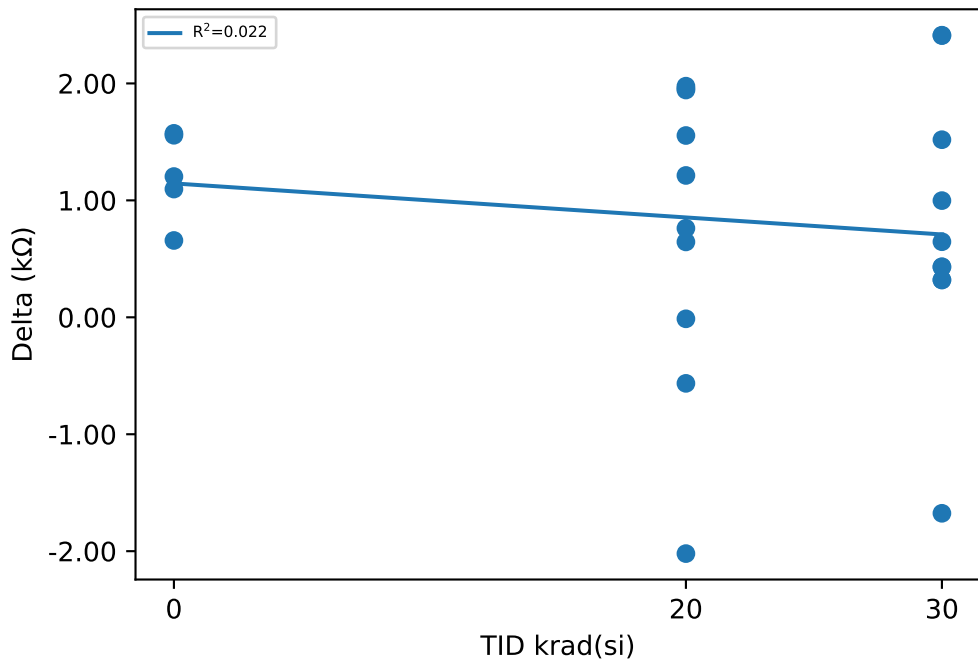

Test Statistics (kΩ)

krad(si)	Pre Exposure Min	Pre Exposure Avg	Pre Exposure Max	Pre Exposure Std	Post Exposure Min	Post Exposure Avg	Post Exposure Max	Post Exposure Std	Min Delta	Avg Delta	Max Delta	Std Delta
0	167.66	168.52	169.54	0.73399	168.86	169.74	171.12	0.92522	0.6571	1.2175	1.5732	0.37763
20	165.81	167.85	169.99	1.2489	167.75	168.6	170.09	0.81483	-2.0207	0.74519	1.9766	1.3015
30	166.56	168.29	170.67	1.2405	167.64	169.07	173.08	1.5756	-1.676	0.78102	2.4125	1.1846

Device Test: 7.28 UJQE20(THER_Pulldown_Resistor_UJQE20)

TID vs Result Stats

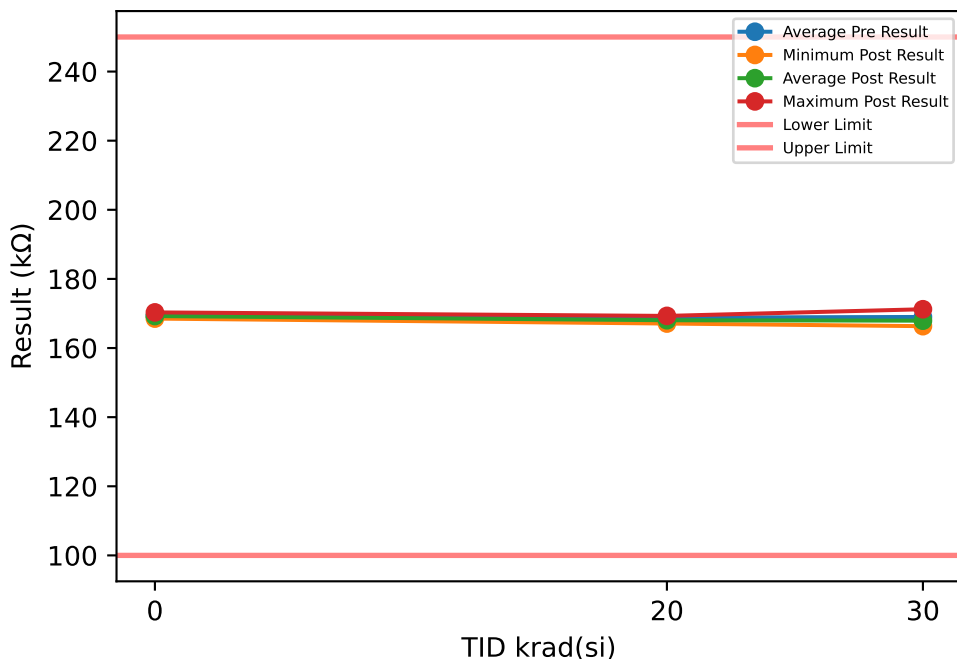

TID vs Post - Pre Exposure Delta

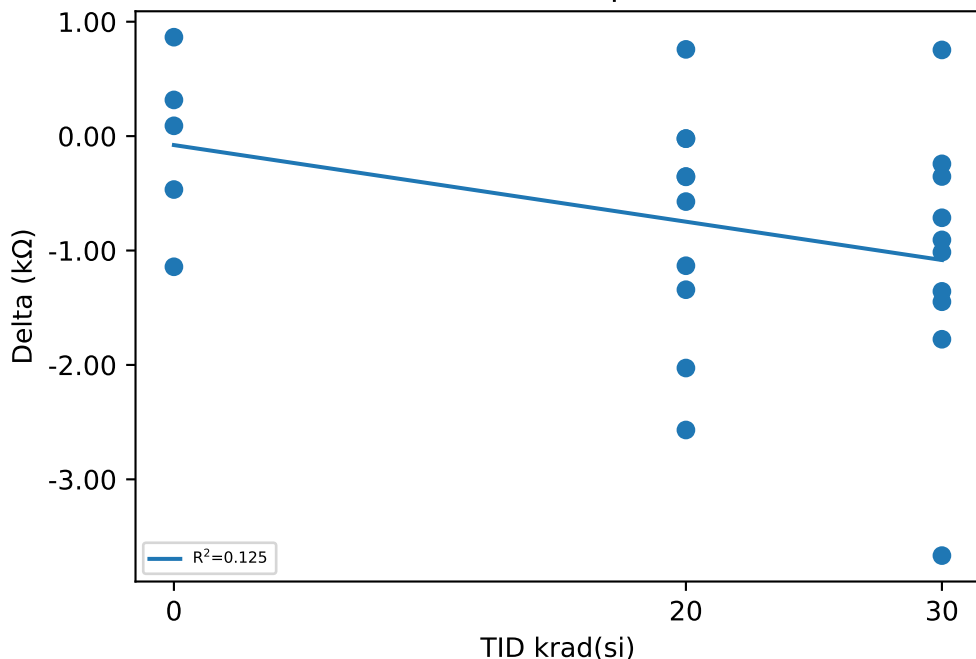

Test Results (Lower Limit = 100.0, Upper Limit = 250.0 (kΩ))

Serial #	krad(si)	Exposure Conditions	Pre Result	Post Result	Delta
1	20	HDR unbiased	168.54	167.2	-1.3424
2	20	HDR unbiased	168.99	168.63	-0.3559
3	20	HDR unbiased	169.21	169.19	-0.0223
4	20	HDR unbiased	169.21	168.08	-1.1329
5	20	HDR unbiased	167.55	167.53	-0.0213
6	20	HDR biased	168.54	169.3	0.7582
7	20	HDR biased	168.21	167.64	-0.5722
8	20	HDR biased	169.66	167.09	-2.5687
9	20	HDR biased	168.32	167.97	-0.353
10	20	HDR biased	169.88	167.86	-2.0271
11	30	HDR unbiased	171.94	171.22	-0.7137
12	30	HDR unbiased	168.76	167.86	-0.907
13	30	HDR unbiased	169.43	168.08	-1.3569
14	30	HDR unbiased	170	166.33	-3.6666
15	30	HDR unbiased	168.32	166.87	-1.4477
16	30	HDR biased	168.21	167.97	-0.2423
17	30	HDR biased	168.32	167.97	-0.353
18	30	HDR biased	168.43	166.65	-1.7756
19	30	HDR biased	167.99	168.74	0.7534
20	30	HDR biased	168.54	167.53	-1.0142
21	0	correlation	169.88	168.74	-1.1421
22	0	correlation	169.77	169.86	0.0901
23	0	correlation	167.99	168.85	0.8647
24	0	correlation	168.99	168.52	-0.4669
25	0	correlation	170	170.31	0.3164

Test Statistics (kΩ)

krad(si)	Pre Exposure Min	Pre Exposure Avg	Pre Exposure Max	Pre Exposure Std	Post Exposure Min	Post Exposure Avg	Post Exposure Max	Post Exposure Std	Min Delta	Avg Delta	Max Delta	Std Delta
0	167.99	169.32	170	0.84614	168.52	169.26	170.31	0.78309	-1.1421	-0.06756	0.8647	0.76738
20	167.55	168.81	169.88	0.71191	167.09	168.05	169.3	0.76941	-2.5687	-0.76376	0.7582	1.0063
30	167.99	168.99	171.94	1.2008	166.33	167.92	171.22	1.3747	-3.6666	-1.0724	0.7534	1.1617

Device Test: 7.29 UJCQ9J(DIAG_Pulldown_Resistor_UJCQ9J)

TID vs Result Stats

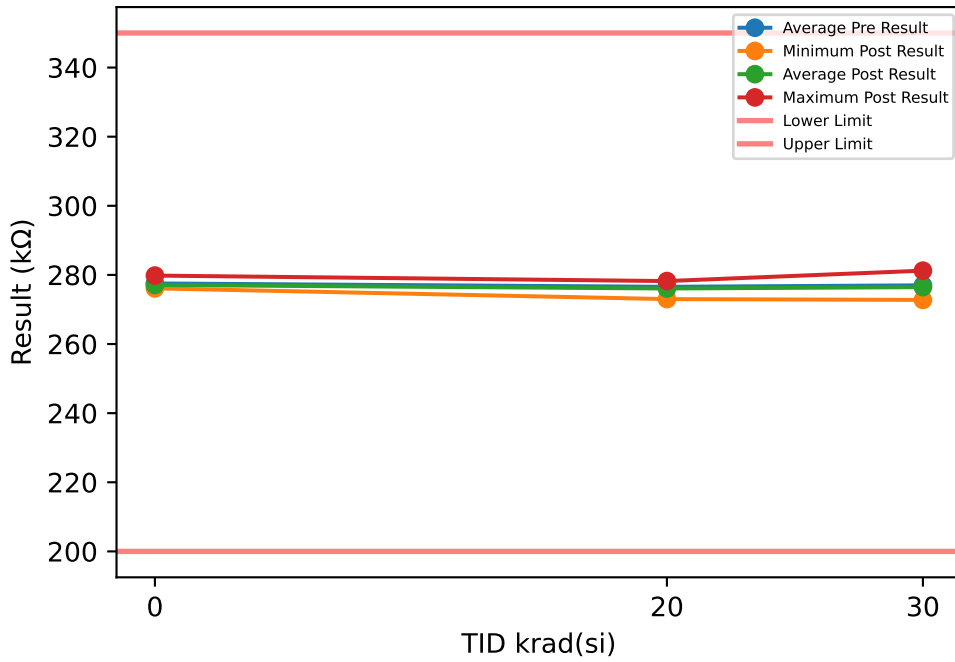

Test Results (Lower Limit = 200.0, Upper Limit = 350.0 (kΩ))

Serial #	krad(si)	Exposure Conditions	Pre Result	Post Result	Delta
1	20	HDR unbiased	274.09	273	-1.0905
2	20	HDR unbiased	277.02	276.92	-0.0954
3	20	HDR unbiased	278.14	278.22	0.0855
4	20	HDR unbiased	277.38	277.07	-0.307
5	20	HDR unbiased	275.16	275.24	0.0851
6	20	HDR biased	276.23	276.83	0.5958
7	20	HDR biased	276.74	275.96	-0.7845
8	20	HDR biased	276.59	276.05	-0.5444
9	20	HDR biased	276.87	276.29	-0.5756
10	20	HDR biased	277.35	275.13	-2.2221
11	30	HDR unbiased	281.55	281.23	-0.3185
12	30	HDR unbiased	276.26	276.08	-0.1843
13	30	HDR unbiased	278.14	277.92	-0.2181
14	30	HDR unbiased	278.17	276.2	-1.9663
15	30	HDR unbiased	277.62	276.86	-0.7598
16	30	HDR biased	274.89	274.5	-0.3891
17	30	HDR biased	276.77	275.9	-0.8744
18	30	HDR biased	273.59	272.77	-0.8236
19	30	HDR biased	276.11	277.28	1.1676
20	30	HDR biased	276.77	275.87	-0.9042
21	0	correlation	276.96	276.17	-0.7857
22	0	correlation	277.05	276.32	-0.7264
23	0	correlation	276.56	276.11	-0.4545
24	0	correlation	277.26	277.01	-0.2465
25	0	correlation	279.82	279.81	-0.0066

TID vs Post - Pre Exposure Delta

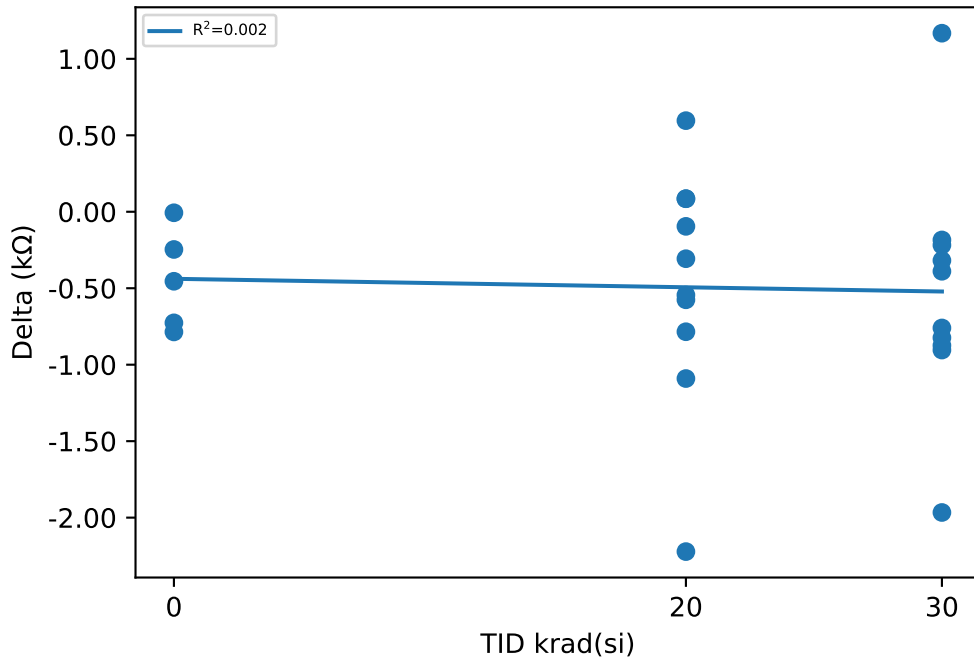

Test Statistics (kΩ)

krad(si)	Pre Exposure Min	Pre Exposure Avg	Pre Exposure Max	Pre Exposure Std	Post Exposure Min	Post Exposure Avg	Post Exposure Max	Post Exposure Std	Min Delta	Avg Delta	Max Delta	Std Delta
0	276.56	277.53	279.82	1.304	276.11	277.08	279.81	1.5659	-0.7857	-0.44394	-0.0066	0.3267
20	274.09	276.56	278.14	1.1672	273	276.07	278.22	1.4132	-2.2221	-0.48531	0.5958	0.78086
30	273.59	276.99	281.55	2.14	272.77	276.46	281.23	2.2125	-1.9663	-0.52707	1.1676	0.79048

Device Test: 7.401 UJTCWZ(EN2_Logic_High_Go-No-Go_UJTCWZ)

TID vs Result Stats

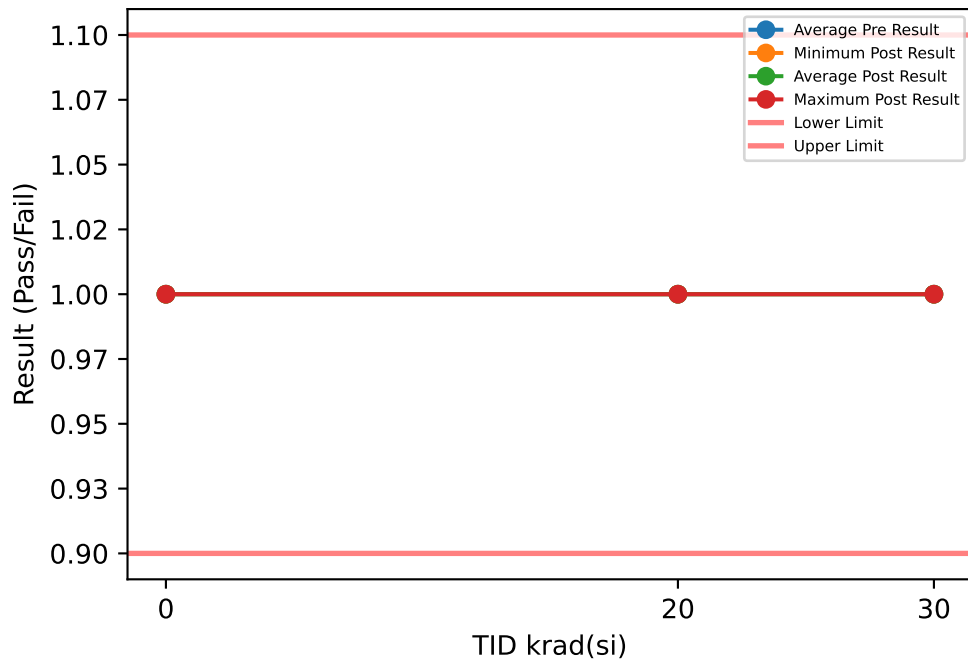

Test Results (Lower Limit = 0.9, Upper Limit = 1.1 (Pass/Fail))

Serial #	krad(si)	Exposure Conditions	Pre Result	Post Result	Delta
1	20	HDR unbiased	1	1	0
2	20	HDR unbiased	1	1	0
3	20	HDR unbiased	1	1	0
4	20	HDR unbiased	1	1	0
5	20	HDR unbiased	1	1	0
6	20	HDR biased	1	1	0
7	20	HDR biased	1	1	0
8	20	HDR biased	1	1	0
9	20	HDR biased	1	1	0
10	20	HDR biased	1	1	0
11	30	HDR unbiased	1	1	0
12	30	HDR unbiased	1	1	0
13	30	HDR unbiased	1	1	0
14	30	HDR unbiased	1	1	0
15	30	HDR unbiased	1	1	0
16	30	HDR biased	1	1	0
17	30	HDR biased	1	1	0
18	30	HDR biased	1	1	0
19	30	HDR biased	1	1	0
20	30	HDR biased	1	1	0
21	0	correlation	1	1	0
22	0	correlation	1	1	0
23	0	correlation	1	1	0
24	0	correlation	1	1	0
25	0	correlation	1	1	0

TID vs Post - Pre Exposure Delta

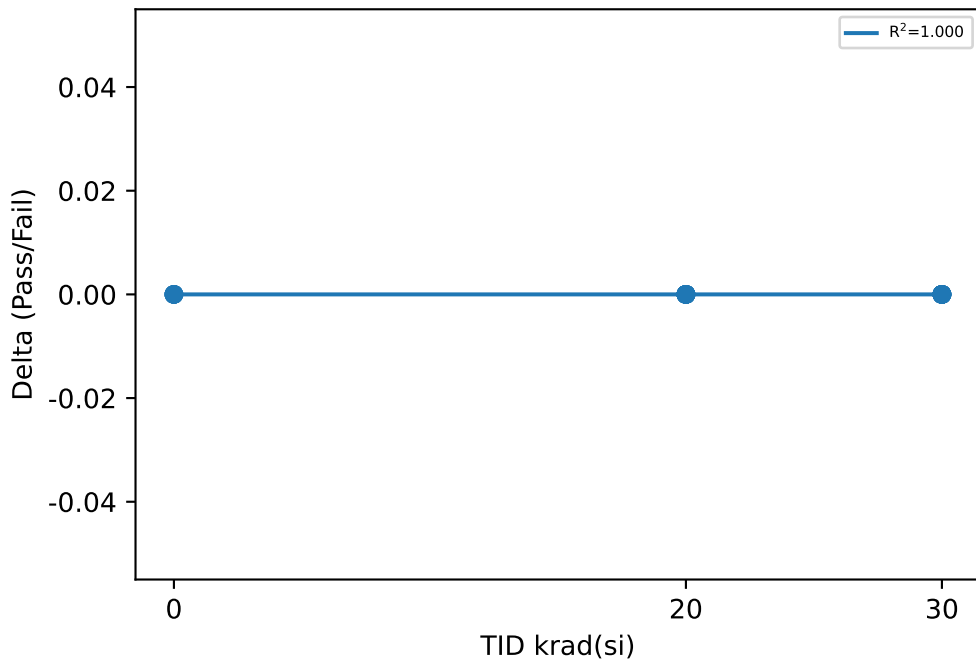

Test Statistics (Pass/Fail)

krad(si)	Pre Exposure Min	Pre Exposure Avg	Pre Exposure Max	Pre Exposure Std	Post Exposure Min	Post Exposure Avg	Post Exposure Max	Post Exposure Std	Min Delta	Avg Delta	Max Delta	Std Delta
0	1	1	1	0	1	1	1	0	0	0	0	0
20	1	1	1	0	1	1	1	0	0	0	0	0
30	1	1	1	0	1	1	1	0	0	0	0	0

Device Test: 7.501 UJVVXI(EN2_Logic_Low_Go-No-Go_UJVVXI)

TID vs Result Stats

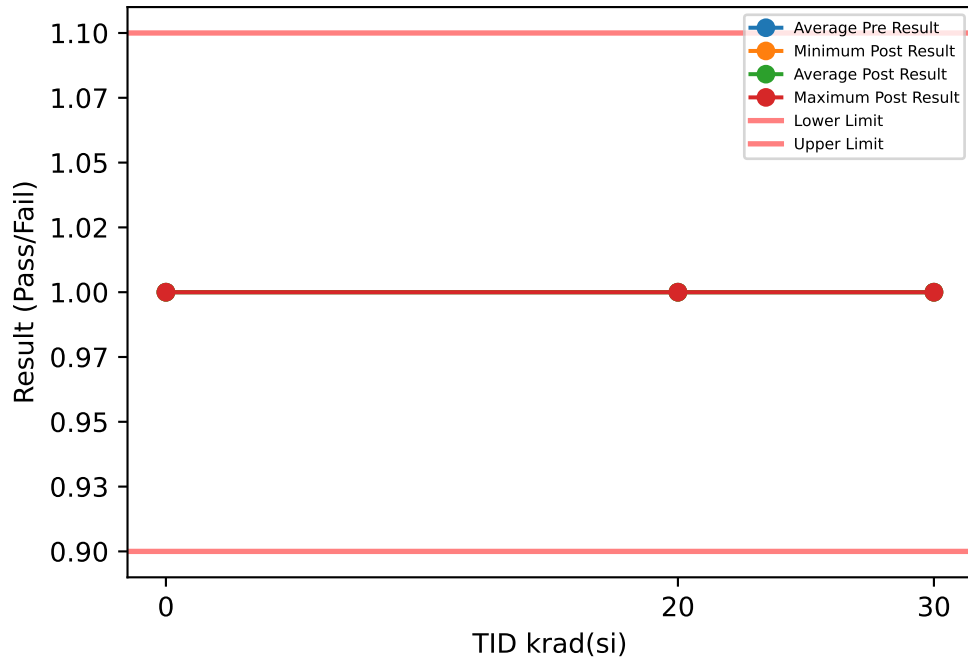

TID vs Post - Pre Exposure Delta

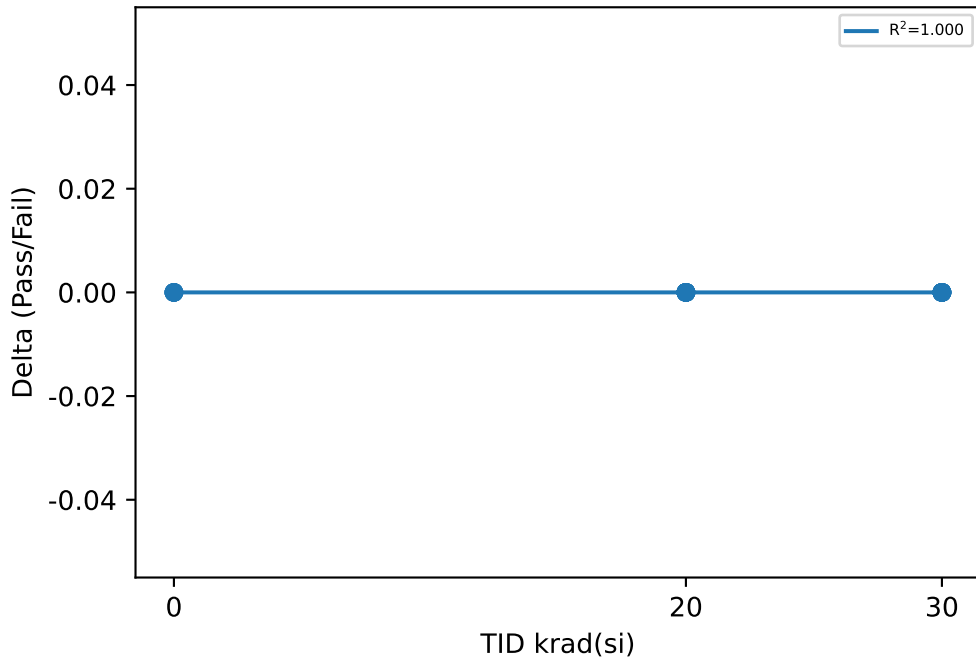

Test Results (Lower Limit = 0.9, Upper Limit = 1.1 (Pass/Fail))

Serial #	krad(si)	Exposure Conditions	Pre Result	Post Result	Delta
1	20	HDR unbiased	1	1	0
2	20	HDR unbiased	1	1	0
3	20	HDR unbiased	1	1	0
4	20	HDR unbiased	1	1	0
5	20	HDR unbiased	1	1	0
6	20	HDR biased	1	1	0
7	20	HDR biased	1	1	0
8	20	HDR biased	1	1	0
9	20	HDR biased	1	1	0
10	20	HDR biased	1	1	0
11	30	HDR unbiased	1	1	0
12	30	HDR unbiased	1	1	0
13	30	HDR unbiased	1	1	0
14	30	HDR unbiased	1	1	0
15	30	HDR unbiased	1	1	0
16	30	HDR biased	1	1	0
17	30	HDR biased	1	1	0
18	30	HDR biased	1	1	0
19	30	HDR biased	1	1	0
20	30	HDR biased	1	1	0
21	0	correlation	1	1	0
22	0	correlation	1	1	0
23	0	correlation	1	1	0
24	0	correlation	1	1	0
25	0	correlation	1	1	0

Test Statistics (Pass/Fail)

krad(si)	Pre Exposure Min	Pre Exposure Avg	Pre Exposure Max	Pre Exposure Std	Post Exposure Min	Post Exposure Avg	Post Exposure Max	Post Exposure Std	Min Delta	Avg Delta	Max Delta	Std Delta
0	1	1	1	0	1	1	1	0	0	0	0	0
20	1	1	1	0	1	1	1	0	0	0	0	0
30	1	1	1	0	1	1	1	0	0	0	0	0

Device Test: 7.701 UJTCWZ(EN3_Logic_High_Go-No-Go_UJTCWZ)

TID vs Result Stats

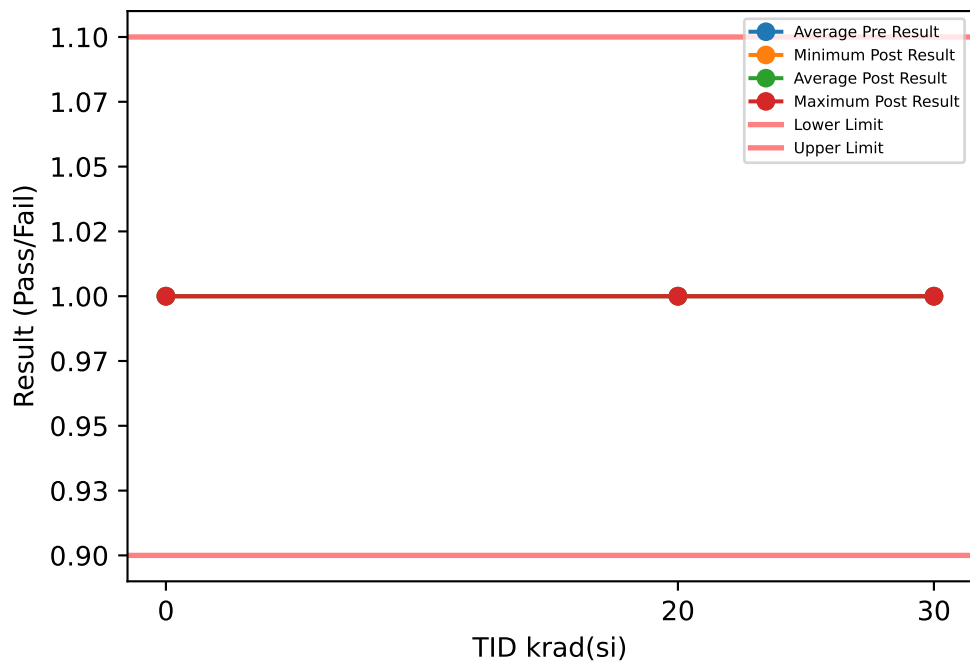

TID vs Post - Pre Exposure Delta

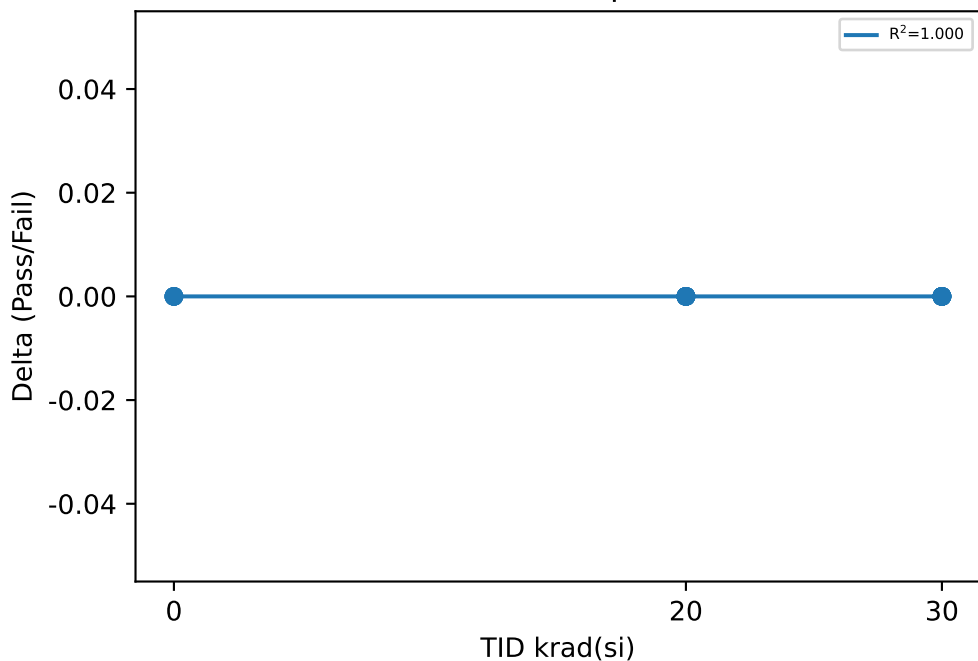

Test Results (Lower Limit = 0.9, Upper Limit = 1.1 (Pass/Fail))

Serial #	krad(si)	Exposure Conditions	Pre Result	Post Result	Delta
1	20	HDR unbiased	1	1	0
2	20	HDR unbiased	1	1	0
3	20	HDR unbiased	1	1	0
4	20	HDR unbiased	1	1	0
5	20	HDR unbiased	1	1	0
6	20	HDR biased	1	1	0
7	20	HDR biased	1	1	0
8	20	HDR biased	1	1	0
9	20	HDR biased	1	1	0
10	20	HDR biased	1	1	0
11	30	HDR unbiased	1	1	0
12	30	HDR unbiased	1	1	0
13	30	HDR unbiased	1	1	0
14	30	HDR unbiased	1	1	0
15	30	HDR unbiased	1	1	0
16	30	HDR biased	1	1	0
17	30	HDR biased	1	1	0
18	30	HDR biased	1	1	0
19	30	HDR biased	1	1	0
20	30	HDR biased	1	1	0
21	0	correlation	1	1	0
22	0	correlation	1	1	0
23	0	correlation	1	1	0
24	0	correlation	1	1	0
25	0	correlation	1	1	0

Test Statistics (Pass/Fail)

krad(si)	Pre Exposure Min	Pre Exposure Avg	Pre Exposure Max	Pre Exposure Std	Post Exposure Min	Post Exposure Avg	Post Exposure Max	Post Exposure Std	Min Delta	Avg Delta	Max Delta	Std Delta
0	1	1	1	0	1	1	1	0	0	0	0	0
20	1	1	1	0	1	1	1	0	0	0	0	0
30	1	1	1	0	1	1	1	0	0	0	0	0

Device Test: 7.801 UJVVXI(EN3_Logic_Low_Go-No-Go_UJVVXI)

TID vs Result Stats

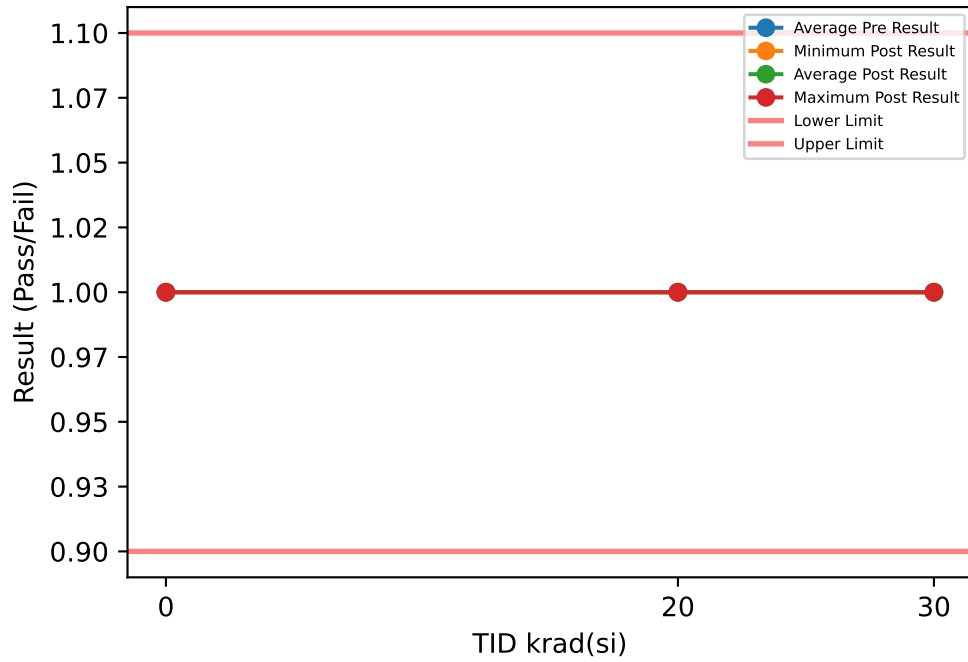

TID vs Post - Pre Exposure Delta

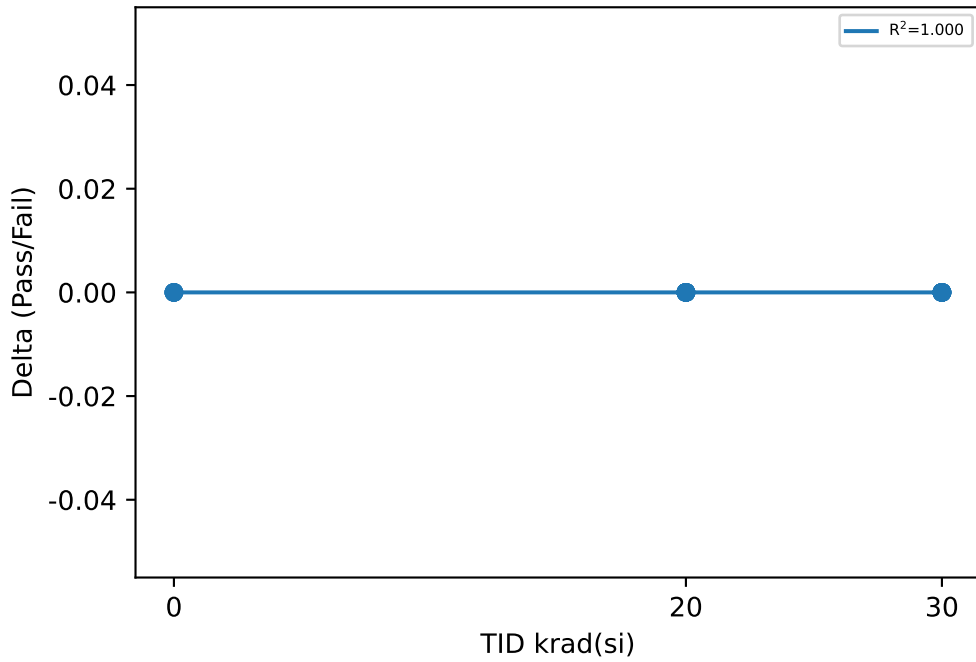

Test Results (Lower Limit = 0.9, Upper Limit = 1.1 (Pass/Fail))

Serial #	krad(si)	Exposure Conditions	Pre Result	Post Result	Delta
1	20	HDR unbiased	1	1	0
2	20	HDR unbiased	1	1	0
3	20	HDR unbiased	1	1	0
4	20	HDR unbiased	1	1	0
5	20	HDR unbiased	1	1	0
6	20	HDR biased	1	1	0
7	20	HDR biased	1	1	0
8	20	HDR biased	1	1	0
9	20	HDR biased	1	1	0
10	20	HDR biased	1	1	0
11	30	HDR unbiased	1	1	0
12	30	HDR unbiased	1	1	0
13	30	HDR unbiased	1	1	0
14	30	HDR unbiased	1	1	0
15	30	HDR unbiased	1	1	0
16	30	HDR biased	1	1	0
17	30	HDR biased	1	1	0
18	30	HDR biased	1	1	0
19	30	HDR biased	1	1	0
20	30	HDR biased	1	1	0
21	0	correlation	1	1	0
22	0	correlation	1	1	0
23	0	correlation	1	1	0
24	0	correlation	1	1	0
25	0	correlation	1	1	0

Test Statistics (Pass/Fail)

krad(si)	Pre Exposure Min	Pre Exposure Avg	Pre Exposure Max	Pre Exposure Std	Post Exposure Min	Post Exposure Avg	Post Exposure Max	Post Exposure Std	Min Delta	Avg Delta	Max Delta	Std Delta
0	1	1	1	0	1	1	1	0	0	0	0	0
20	1	1	1	0	1	1	1	0	0	0	0	0
30	1	1	1	0	1	1	1	0	0	0	0	0

Device Test: 8.1 UJEU7X(IOUT1_GroundLoss_UJEU7X)

TID vs Result Stats

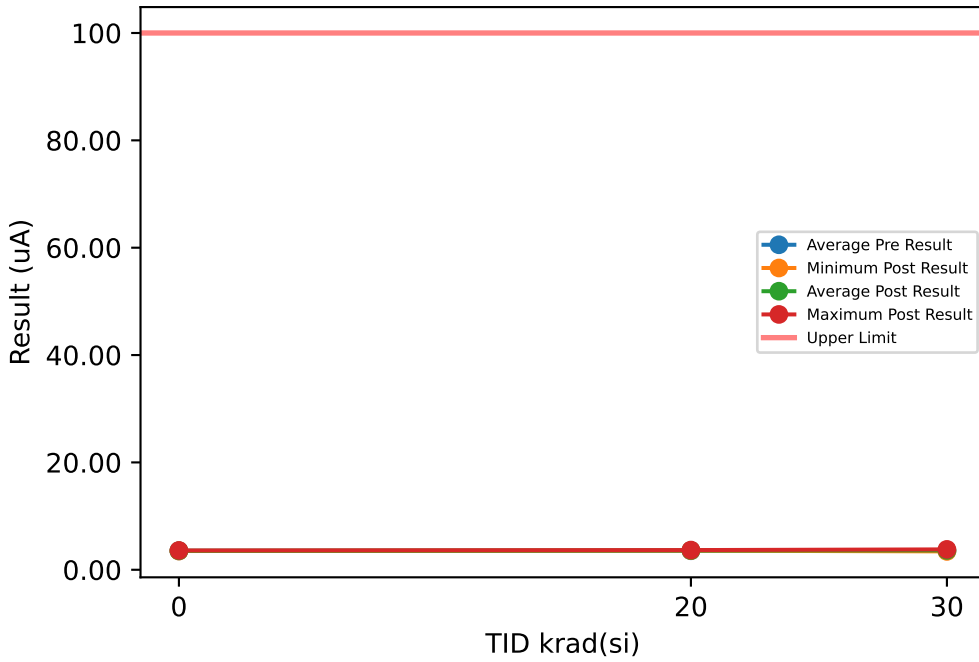

Test Results (Upper Limit = 100.0 (uA))

Serial #	krad(si)	Exposure Conditions	Pre Result	Post Result	Delta
1	20	HDR unbiased	3.6262	3.6698	0.0436
2	20	HDR unbiased	3.5614	3.6168	0.0554
3	20	HDR unbiased	3.5083	3.5696	0.0613
4	20	HDR unbiased	3.5064	3.5696	0.0632
5	20	HDR unbiased	3.5496	3.6168	0.0672
6	20	HDR biased	3.5633	3.5598	-0.0035
7	20	HDR biased	3.524	3.5932	0.0692
8	20	HDR biased	3.5024	3.5912	0.0888
9	20	HDR biased	3.5378	3.6168	0.079
10	20	HDR biased	3.4926	3.6266	0.134
11	30	HDR unbiased	3.3767	3.4223	0.0456
12	30	HDR unbiased	3.528	3.6128	0.0848
13	30	HDR unbiased	3.5142	3.5834	0.0692
14	30	HDR unbiased	3.4985	3.5952	0.0967
15	30	HDR unbiased	3.5221	3.6148	0.0927
16	30	HDR biased	3.5692	3.6443	0.0751
17	30	HDR biased	3.5358	3.605	0.0692
18	30	HDR biased	3.689	3.7975	0.1085
19	30	HDR biased	3.5417	3.5893	0.0476
20	30	HDR biased	3.5496	3.6246	0.075
21	0	correlation	3.5437	3.5421	-0.0016
22	0	correlation	3.4985	3.5264	0.0279
23	0	correlation	3.5515	3.6011	0.0496
24	0	correlation	3.5221	3.5421	0.02
25	0	correlation	3.4435	3.4911	0.0476

TID vs Post - Pre Exposure Delta

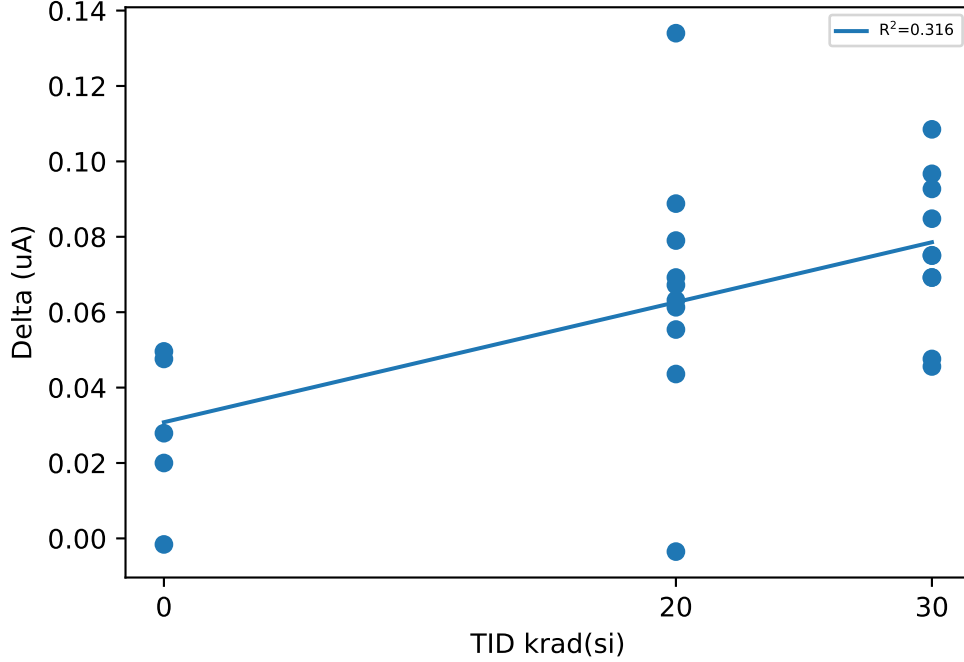

Test Statistics (uA)

krad(si)	Pre Exposure Min	Pre Exposure Avg	Pre Exposure Max	Pre Exposure Std	Post Exposure Min	Post Exposure Avg	Post Exposure Max	Post Exposure Std	Min Delta	Avg Delta	Max Delta	Std Delta
0	3.4435	3.5119	3.5515	0.043421	3.4911	3.5406	3.6011	0.039739	-0.0016	0.0287	0.0496	0.021145
20	3.4926	3.5372	3.6262	0.040139	3.5598	3.603	3.6698	0.033205	-0.0035	0.06582	0.134	0.034639
30	3.3767	3.5325	3.689	0.076099	3.4223	3.6089	3.7975	0.090171	0.0456	0.07644	0.1085	0.020177

Device Test: 8.2 UJEU7X(IOUT2_GroundLoss_UJEU7X)

TID vs Result Stats

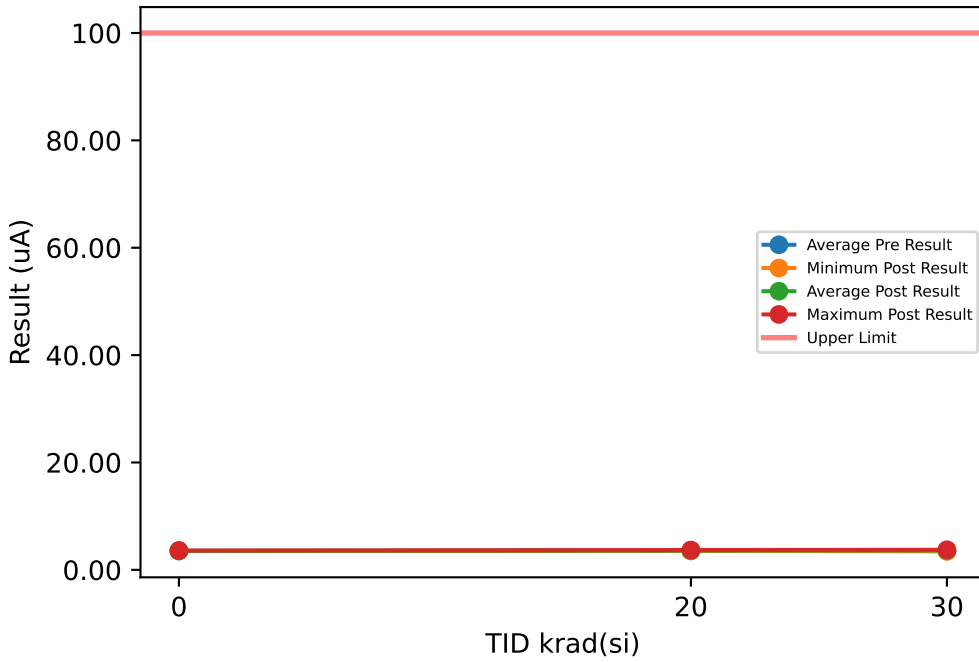

TID vs Post - Pre Exposure Delta

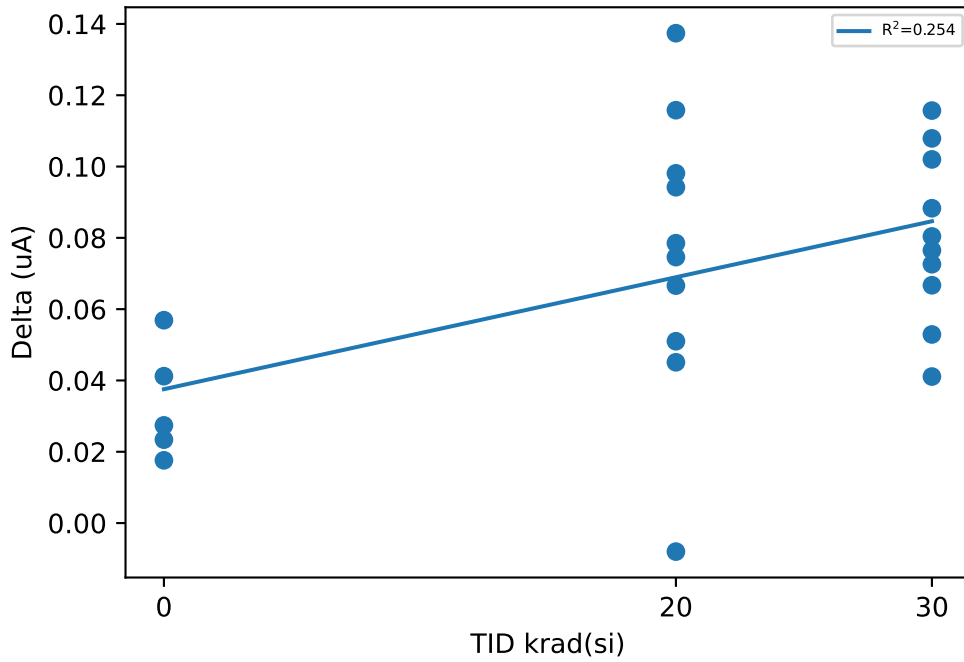

Test Results (Upper Limit = 100.0 (uA))

Serial #	krad(si)	Exposure Conditions	Pre Result	Post Result	Delta
1	20	HDR unbiased	3.6439	3.689	0.0451
2	20	HDR unbiased	3.5438	3.6104	0.0666
3	20	HDR unbiased	3.5123	3.5869	0.0746
4	20	HDR unbiased	3.532	3.583	0.051
5	20	HDR unbiased	3.5575	3.6517	0.0942
6	20	HDR biased	3.5595	3.5515	-0.008
7	20	HDR biased	3.5182	3.6163	0.0981
8	20	HDR biased	3.5104	3.6262	0.1158
9	20	HDR biased	3.5359	3.6144	0.0785
10	20	HDR biased	3.4927	3.6301	0.1374
11	30	HDR unbiased	3.3965	3.4376	0.0411
12	30	HDR unbiased	3.5261	3.6281	0.102
13	30	HDR unbiased	3.5104	3.5633	0.0529
14	30	HDR unbiased	3.5202	3.5869	0.0667
15	30	HDR unbiased	3.5222	3.6026	0.0804
16	30	HDR biased	3.5654	3.6811	0.1157
17	30	HDR biased	3.5438	3.6203	0.0765
18	30	HDR biased	3.6302	3.7381	0.1079
19	30	HDR biased	3.5418	3.6301	0.0883
20	30	HDR biased	3.5575	3.6301	0.0726
21	0	correlation	3.5202	3.5614	0.0412
22	0	correlation	3.5222	3.5496	0.0274
23	0	correlation	3.5752	3.5928	0.0176
24	0	correlation	3.5438	3.5672	0.0234
25	0	correlation	3.4475	3.5044	0.0569

Test Statistics (uA)

krad(si)	Pre Exposure Min	Pre Exposure Avg	Pre Exposure Max	Pre Exposure Std	Post Exposure Min	Post Exposure Avg	Post Exposure Max	Post Exposure Std	Min Delta	Avg Delta	Max Delta	Std Delta
0	3.4475	3.5218	3.5752	0.047061	3.5044	3.5551	3.5928	0.032435	0.0176	0.0333	0.0569	0.015801
20	3.4927	3.5406	3.6439	0.04207	3.5515	3.616	3.689	0.038059	-0.008	0.07533	0.1374	0.040691
30	3.3965	3.5314	3.6302	0.058441	3.4376	3.6118	3.7381	0.07829	0.0411	0.08041	0.1157	0.023795

Device Test: 8.4 UJEU7X(IOUT4_GroundLoss_UJEU7X)

TID vs Result Stats

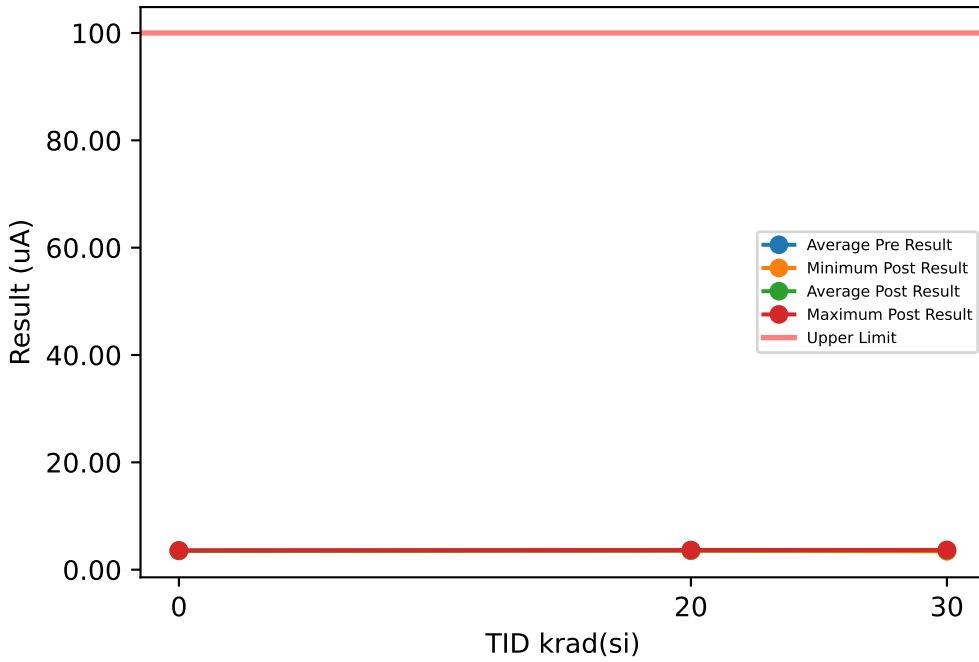

TID vs Post - Pre Exposure Delta

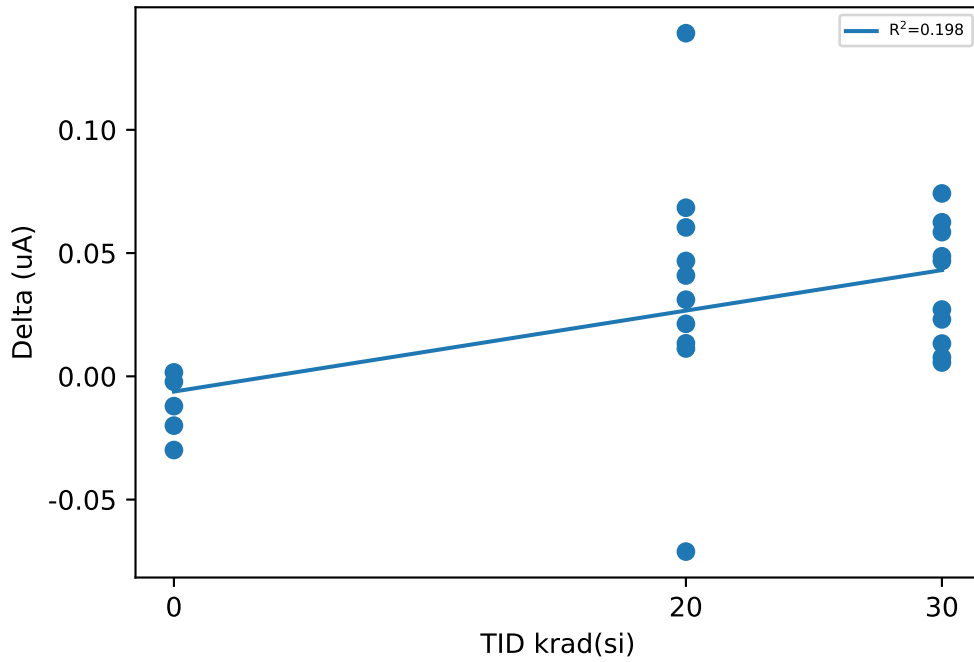

Test Results (Upper Limit = 100.0 (uA))

Serial #	krad(si)	Exposure Conditions	Pre Result	Post Result	Delta
1	20	HDR unbiased	3.6434	3.6547	0.0113
2	20	HDR unbiased	3.5962	3.6096	0.0134
3	20	HDR unbiased	3.551	3.5723	0.0213
4	20	HDR unbiased	3.5451	3.5762	0.0311
5	20	HDR unbiased	3.6002	3.6606	0.0604
6	20	HDR biased	3.5923	3.5212	-0.0711
7	20	HDR biased	3.5608	3.6076	0.0468
8	20	HDR biased	3.5392	3.6076	0.0684
9	20	HDR biased	3.5608	3.6017	0.0409
10	20	HDR biased	3.49	3.6292	0.1392
11	30	HDR unbiased	3.3996	3.4073	0.0077
12	30	HDR unbiased	3.5884	3.6469	0.0585
13	30	HDR unbiased	3.549	3.5546	0.0056
14	30	HDR unbiased	3.5333	3.5958	0.0625
15	30	HDR unbiased	3.5628	3.6096	0.0468
16	30	HDR biased	3.5982	3.6213	0.0231
17	30	HDR biased	3.5982	3.6253	0.0271
18	30	HDR biased	3.6041	3.6783	0.0742
19	30	HDR biased	3.5884	3.6017	0.0133
20	30	HDR biased	3.5746	3.6233	0.0487
21	0	correlation	3.549	3.5369	-0.0121
22	0	correlation	3.5549	3.5349	-0.02
23	0	correlation	3.6198	3.5899	-0.0299
24	0	correlation	3.5667	3.5683	0.0016
25	0	correlation	3.4822	3.48	-0.0022

Test Statistics (uA)

krad(si)	Pre Exposure Min	Pre Exposure Avg	Pre Exposure Max	Pre Exposure Std	Post Exposure Min	Post Exposure Avg	Post Exposure Max	Post Exposure Std	Min Delta	Avg Delta	Max Delta	Std Delta
0	3.4822	3.5545	3.6198	0.04917	3.48	3.542	3.5899	0.041553	-0.0299	-0.01252	0.0016	0.012885
20	3.49	3.5679	3.6434	0.042082	3.5212	3.6041	3.6606	0.040968	-0.0711	0.03617	0.1392	0.052985
30	3.3996	3.5597	3.6041	0.06079	3.4073	3.5964	3.6783	0.073896	0.0056	0.03675	0.0742	0.024554

Device Test: 8.5 UJ4X6M(VDIODE_OUT1_UJ4X6M)

TID vs Result Stats

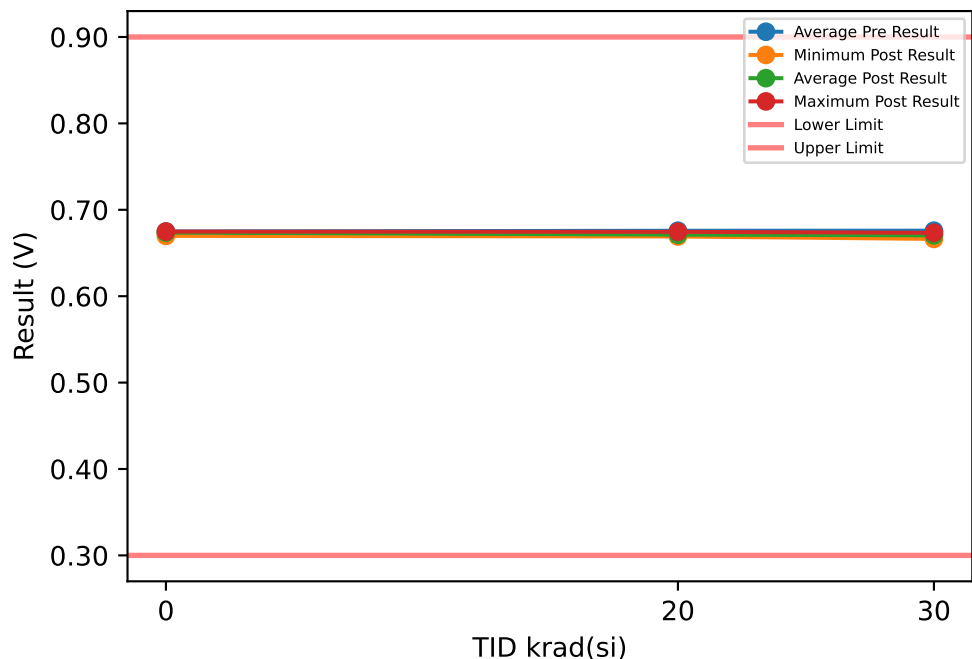

Test Results (Lower Limit = 0.3, Upper Limit = 0.9 (V))

Serial #	krad(si)	Exposure Conditions	Pre Result	Post Result	Delta
1	20	HDR unbiased	0.6737	0.6703	-0.0034
2	20	HDR unbiased	0.6779	0.6745	-0.0034
3	20	HDR unbiased	0.6731	0.6695	-0.0036
4	20	HDR unbiased	0.6759	0.6722	-0.0037
5	20	HDR unbiased	0.676	0.6722	-0.0038
6	20	HDR biased	0.6763	0.6709	-0.0054
7	20	HDR biased	0.6745	0.6691	-0.0054
8	20	HDR biased	0.6781	0.6725	-0.0056
9	20	HDR biased	0.6759	0.6703	-0.0056
10	20	HDR biased	0.6762	0.6706	-0.0056
11	30	HDR unbiased	0.677	0.6726	-0.0044
12	30	HDR unbiased	0.676	0.6713	-0.0047
13	30	HDR unbiased	0.6763	0.6717	-0.0046
14	30	HDR unbiased	0.677	0.6708	-0.0062
15	30	HDR unbiased	0.6781	0.6734	-0.0047
16	30	HDR biased	0.6728	0.6667	-0.0061
17	30	HDR biased	0.6764	0.6703	-0.0061
18	30	HDR biased	0.6727	0.6663	-0.0064
19	30	HDR biased	0.6755	0.6707	-0.0048
20	30	HDR biased	0.6765	0.6701	-0.0064
21	0	correlation	0.6712	0.6698	-0.0014
22	0	correlation	0.6761	0.6747	-0.0014
23	0	correlation	0.6753	0.6741	-0.0012
24	0	correlation	0.676	0.6746	-0.0014
25	0	correlation	0.6759	0.6748	-0.0011

TID vs Post - Pre Exposure Delta

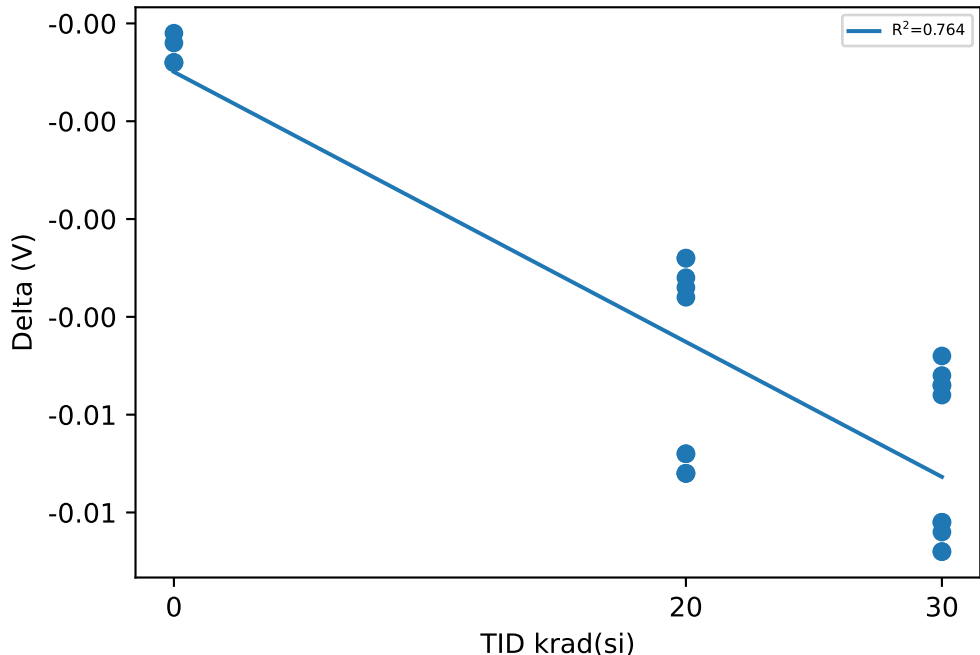

Device Test: 8.6 UJ4X6M(VDIODE_OUT2_UJ4X6M)

TID vs Result Stats

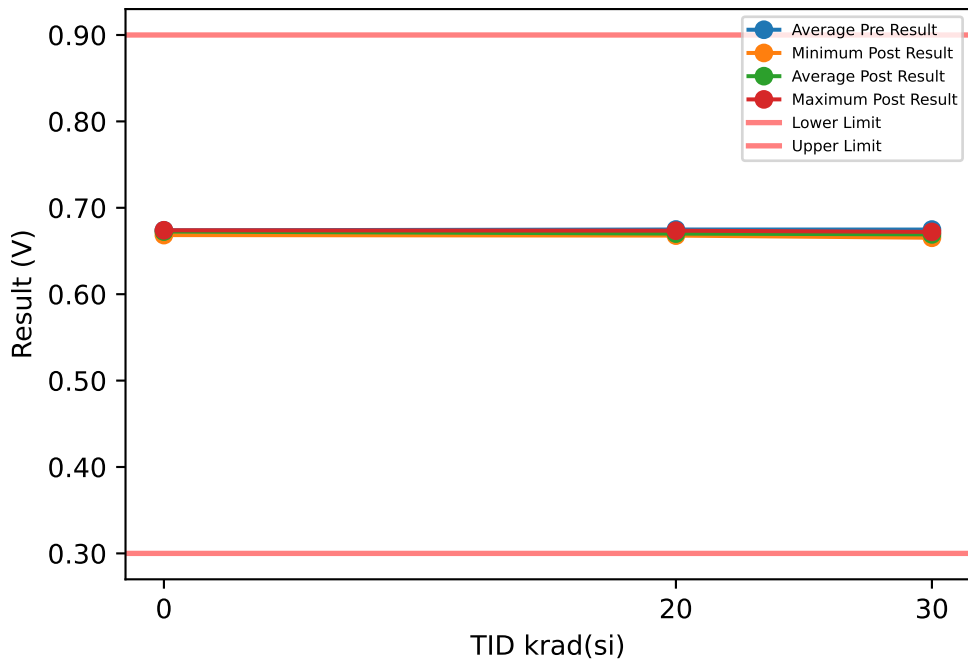

Test Results (Lower Limit = 0.3, Upper Limit = 0.9 (V))

Serial #	krad(si)	Exposure Conditions	Pre Result	Post Result	Delta
1	20	HDR unbiased	0.673	0.6693	-0.0037
2	20	HDR unbiased	0.6772	0.6735	-0.0037
3	20	HDR unbiased	0.672	0.6682	-0.0038
4	20	HDR unbiased	0.6752	0.6713	-0.0039
5	20	HDR unbiased	0.6752	0.6712	-0.004
6	20	HDR biased	0.6753	0.6698	-0.0055
7	20	HDR biased	0.6735	0.6678	-0.0057
8	20	HDR biased	0.6773	0.6715	-0.0058
9	20	HDR biased	0.675	0.6692	-0.0058
10	20	HDR biased	0.6752	0.6695	-0.0057
11	30	HDR unbiased	0.6756	0.6711	-0.0045
12	30	HDR unbiased	0.6752	0.6702	-0.005
13	30	HDR unbiased	0.6752	0.6704	-0.0048
14	30	HDR unbiased	0.6761	0.6699	-0.0062
15	30	HDR unbiased	0.677	0.6721	-0.0049
16	30	HDR biased	0.6718	0.6656	-0.0062
17	30	HDR biased	0.6751	0.6688	-0.0063
18	30	HDR biased	0.6718	0.6653	-0.0065
19	30	HDR biased	0.6747	0.6696	-0.0051
20	30	HDR biased	0.6758	0.6693	-0.0065
21	0	correlation	0.67	0.6684	-0.0016
22	0	correlation	0.6755	0.674	-0.0015
23	0	correlation	0.6744	0.6731	-0.0013
24	0	correlation	0.6748	0.6733	-0.0015
25	0	correlation	0.675	0.6737	-0.0013

TID vs Post - Pre Exposure Delta

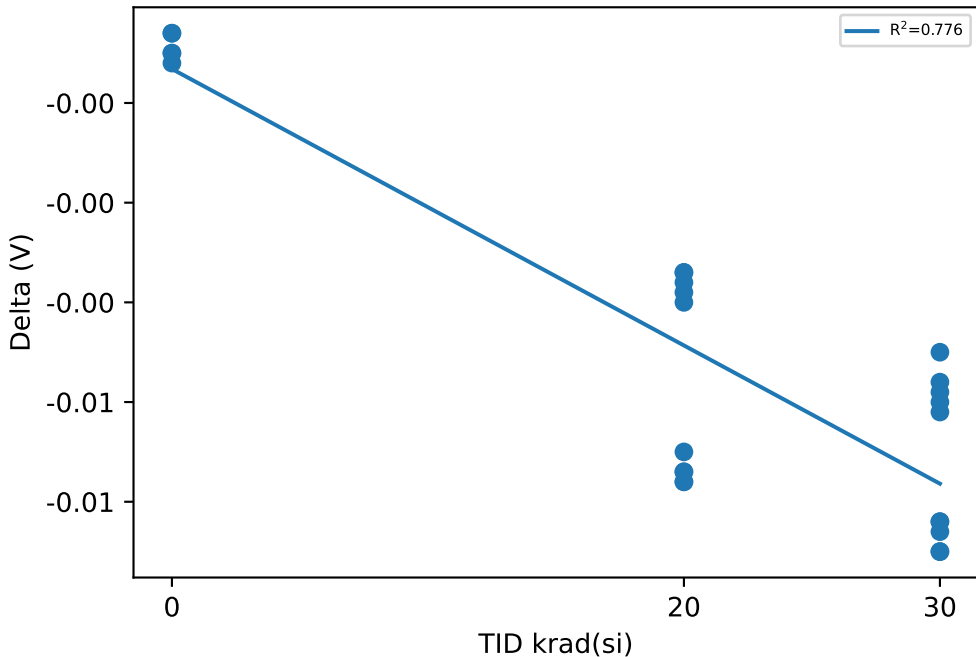

Device Test: 8.7 UJ4X6M(VDIODE_OUT3_UJ4X6M)

TID vs Result Stats

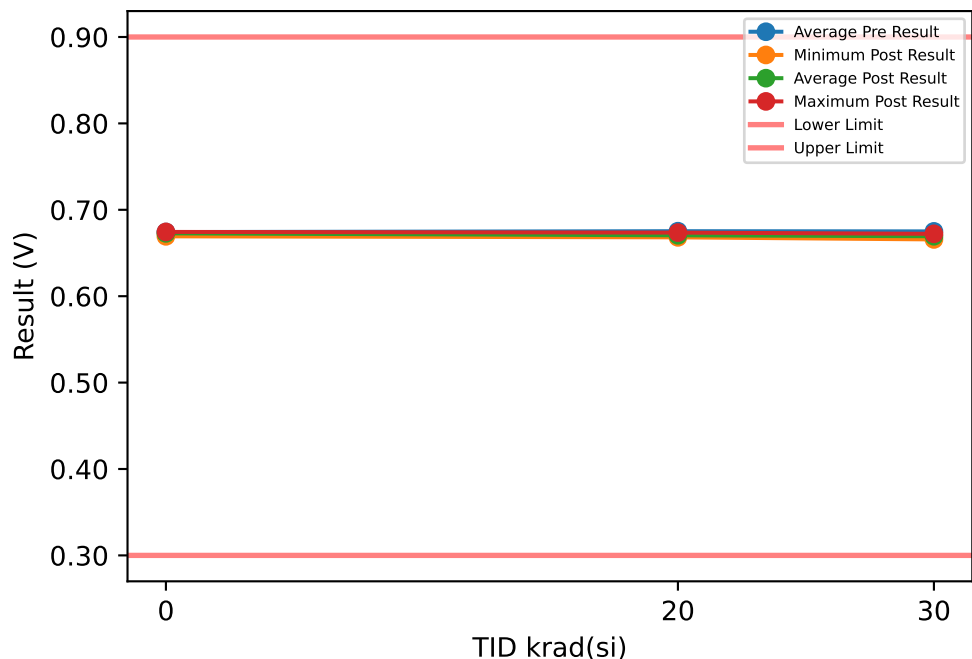

TID vs Post - Pre Exposure Delta

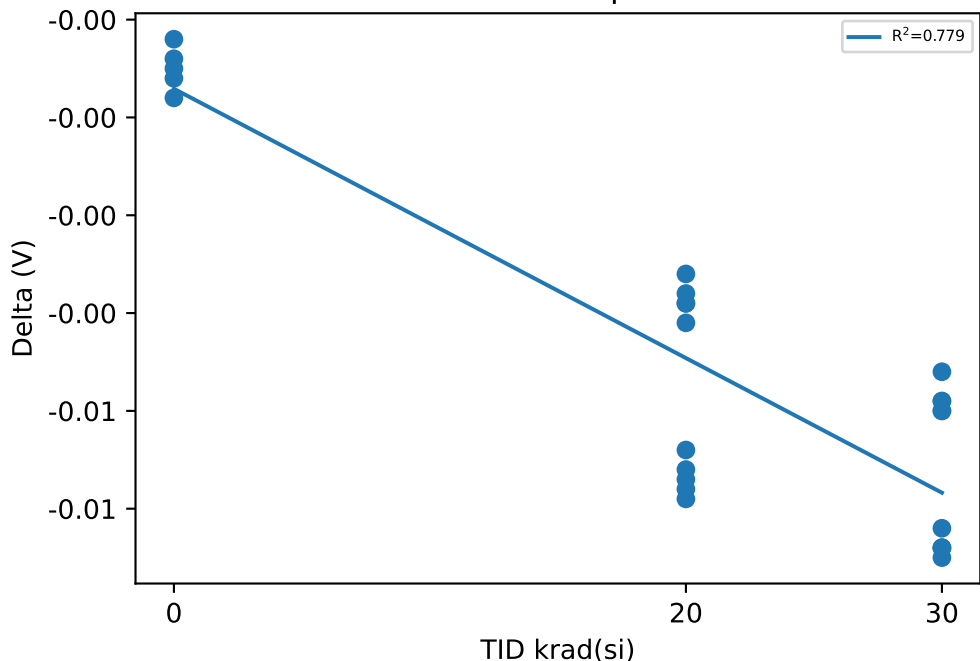

Test Results (Lower Limit = 0.3, Upper Limit = 0.9 (V))

Serial #	krad(si)	Exposure Conditions	Pre Result	Post Result	Delta
1	20	HDR unbiased	0.6735	0.6699	-0.0036
2	20	HDR unbiased	0.6774	0.6736	-0.0038
3	20	HDR unbiased	0.6728	0.6689	-0.0039
4	20	HDR unbiased	0.6763	0.6724	-0.0039
5	20	HDR unbiased	0.6746	0.6705	-0.0041
6	20	HDR biased	0.6764	0.671	-0.0054
7	20	HDR biased	0.6739	0.6682	-0.0057
8	20	HDR biased	0.6772	0.6716	-0.0056
9	20	HDR biased	0.674	0.6681	-0.0059
10	20	HDR biased	0.6763	0.6705	-0.0058
11	30	HDR unbiased	0.6768	0.6722	-0.0046
12	30	HDR unbiased	0.6762	0.6712	-0.005
13	30	HDR unbiased	0.6751	0.6701	-0.005
14	30	HDR unbiased	0.6754	0.669	-0.0064
15	30	HDR unbiased	0.677	0.6721	-0.0049
16	30	HDR biased	0.6721	0.6659	-0.0062
17	30	HDR biased	0.6755	0.669	-0.0065
18	30	HDR biased	0.6721	0.6657	-0.0064
19	30	HDR biased	0.6739	0.669	-0.0049
20	30	HDR biased	0.6761	0.6697	-0.0064
21	0	correlation	0.6711	0.6693	-0.0018
22	0	correlation	0.6759	0.6743	-0.0016
23	0	correlation	0.6737	0.6723	-0.0014
24	0	correlation	0.6759	0.6744	-0.0015
25	0	correlation	0.6746	0.6734	-0.0012

Test Statistics (V)

krad(si)	Pre Exposure Min	Pre Exposure Avg	Pre Exposure Max	Pre Exposure Std	Post Exposure Min	Post Exposure Avg	Post Exposure Max	Post Exposure Std	Min Delta	Avg Delta	Max Delta	Std Delta
0	0.6711	0.67424	0.6759	0.001987	0.6693	0.67274	0.6744	0.0021007	-0.0018	-0.0015	-0.0012	0.00022361
20	0.6728	0.67524	0.6774	0.0016608	0.6681	0.67047	0.6736	0.0017839	-0.0059	-0.00477	-0.0036	0.00097531
30	0.6721	0.67502	0.677	0.0017744	0.6657	0.66939	0.6722	0.0022452	-0.0065	-0.00563	-0.0046	0.00080146

Device Test: 8.8 UJ4X6M(VDIODE_OUT4_UJ4X6M)

TID vs Result Stats

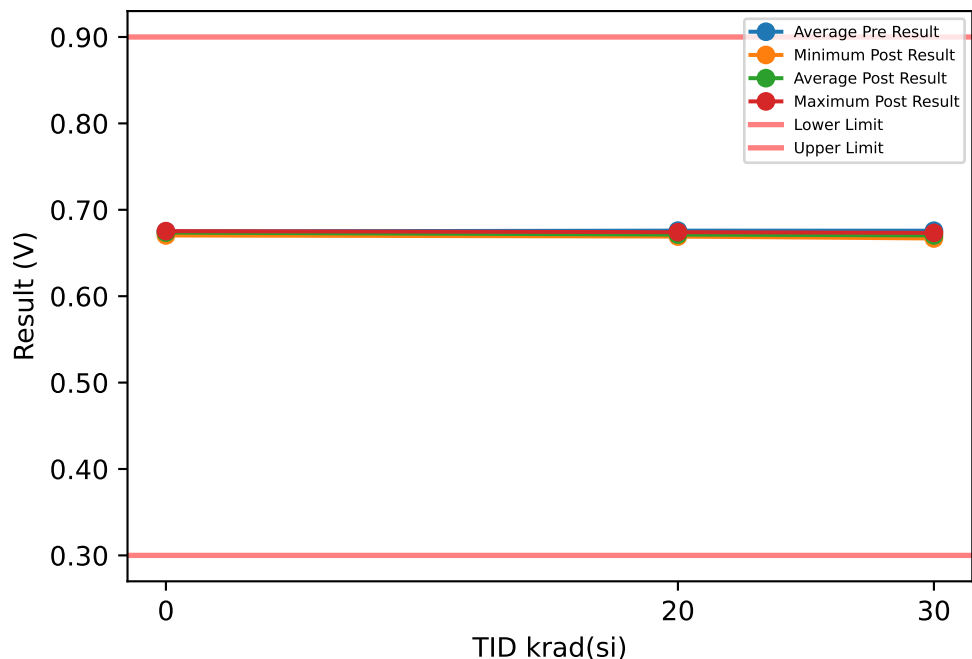

Test Results (Lower Limit = 0.3, Upper Limit = 0.9 (V))

Serial #	krad(si)	Exposure Conditions	Pre Result	Post Result	Delta
1	20	HDR unbiased	0.6741	0.6706	-0.0035
2	20	HDR unbiased	0.6777	0.6741	-0.0036
3	20	HDR unbiased	0.6735	0.6698	-0.0037
4	20	HDR unbiased	0.6768	0.673	-0.0038
5	20	HDR unbiased	0.6753	0.6714	-0.0039
6	20	HDR biased	0.6771	0.6719	-0.0052
7	20	HDR biased	0.6748	0.6692	-0.0056
8	20	HDR biased	0.6779	0.6724	-0.0055
9	20	HDR biased	0.6747	0.669	-0.0057
10	20	HDR biased	0.677	0.6714	-0.0056
11	30	HDR unbiased	0.6776	0.6733	-0.0043
12	30	HDR unbiased	0.6771	0.672	-0.0051
13	30	HDR unbiased	0.6759	0.6711	-0.0048
14	30	HDR unbiased	0.6761	0.6698	-0.0063
15	30	HDR unbiased	0.6778	0.6732	-0.0046
16	30	HDR biased	0.6731	0.6669	-0.0062
17	30	HDR biased	0.6764	0.6702	-0.0062
18	30	HDR biased	0.6731	0.6668	-0.0063
19	30	HDR biased	0.6745	0.6698	-0.0047
20	30	HDR biased	0.6764	0.6701	-0.0063
21	0	correlation	0.672	0.6703	-0.0017
22	0	correlation	0.6763	0.6747	-0.0016
23	0	correlation	0.6745	0.6731	-0.0014
24	0	correlation	0.6766	0.6753	-0.0013
25	0	correlation	0.6754	0.6744	-0.001

TID vs Post - Pre Exposure Delta

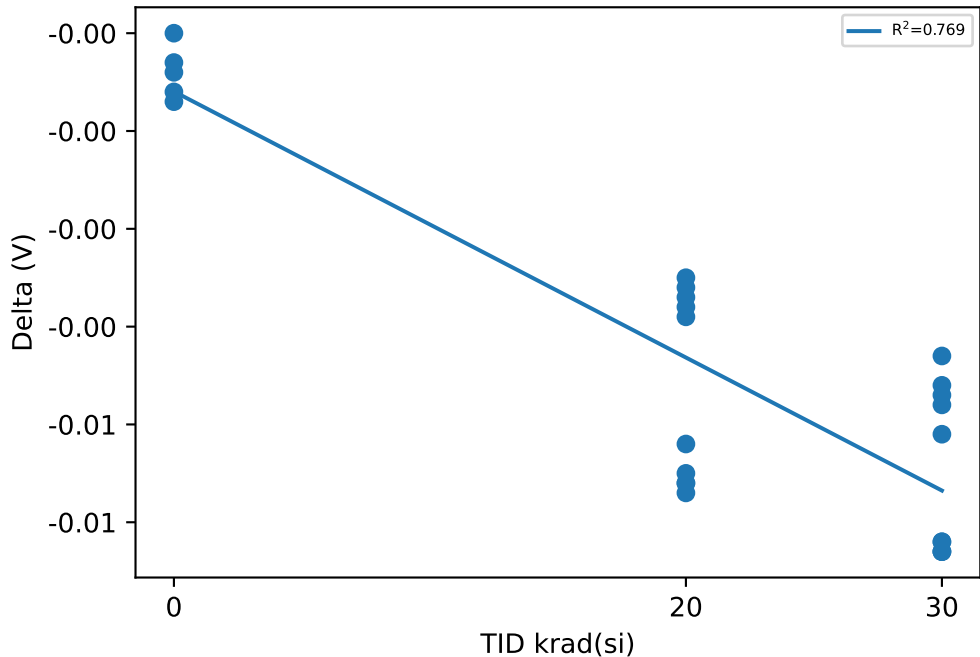

Test Statistics (V)

krad(si)	Pre Exposure Min	Pre Exposure Avg	Pre Exposure Max	Pre Exposure Std	Post Exposure Min	Post Exposure Avg	Post Exposure Max	Post Exposure Std	Min Delta	Avg Delta	Max Delta	Std Delta
0	0.672	0.67496	0.6766	0.0018474	0.6703	0.67356	0.6753	0.001992	-0.0017	-0.0014	-0.001	0.00027386
20	0.6735	0.67589	0.6779	0.0015885	0.669	0.67128	0.6741	0.0016585	-0.0057	-0.00461	-0.0035	0.00097348
30	0.6731	0.6758	0.6778	0.0017003	0.6668	0.67032	0.6733	0.0022434	-0.0063	-0.00548	-0.0043	0.00084564

Device Test: 9.1 UJ9MO5(VOL_OFF_UJ9MO5)

TID vs Result Stats

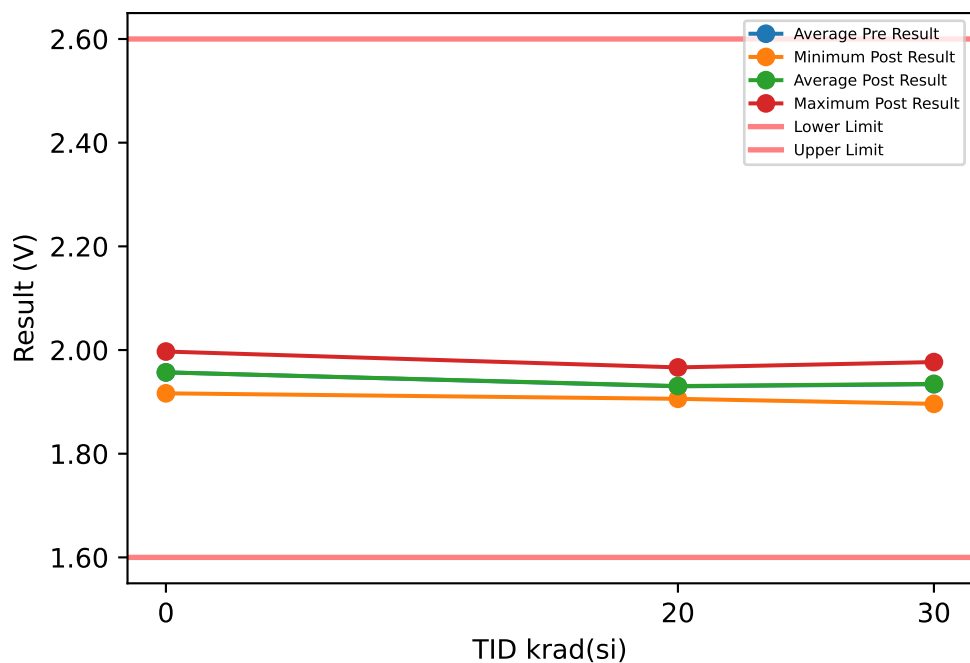

Test Results (Lower Limit = 1.6, Upper Limit = 2.6 (V))

Serial #	krad(si)	Exposure Conditions	Pre Result	Post Result	Delta
1	20	HDR unbiased	1.9169	1.9162	-0.0007
2	20	HDR unbiased	1.9069	1.9062	-0.0007
3	20	HDR unbiased	1.9471	1.9468	-0.0003
4	20	HDR unbiased	1.9475	1.9468	-0.0007
5	20	HDR unbiased	1.9265	1.9268	0.0003
6	20	HDR biased	1.9072	1.9665	0.0593
7	20	HDR biased	1.9069	1.9162	0.0093
8	20	HDR biased	1.9268	1.9274	0.0006
9	20	HDR biased	1.9471	1.9468	-0.0003
10	20	HDR biased	1.9668	1.9059	-0.0609
11	30	HDR unbiased	1.9265	1.9268	0.0003
12	30	HDR unbiased	1.9774	1.9765	-0.0009
13	30	HDR unbiased	1.9172	1.9165	-0.0007
14	30	HDR unbiased	1.9375	1.9768	0.0393
15	30	HDR unbiased	1.9471	1.9465	-0.0006
16	30	HDR biased	1.8966	1.9068	0.0102
17	30	HDR biased	1.8975	1.8962	-0.0013
18	30	HDR biased	1.9165	1.9171	0.0006
19	30	HDR biased	1.9771	1.9374	-0.0397
20	30	HDR biased	1.9465	1.9468	0.0003
21	0	correlation	1.9169	1.9165	-0.0004
22	0	correlation	1.9465	1.9474	0.0009
23	0	correlation	1.9668	1.9665	-0.0003
24	0	correlation	1.9571	1.9571	0
25	0	correlation	1.9974	1.9971	-0.0003

TID vs Post - Pre Exposure Delta

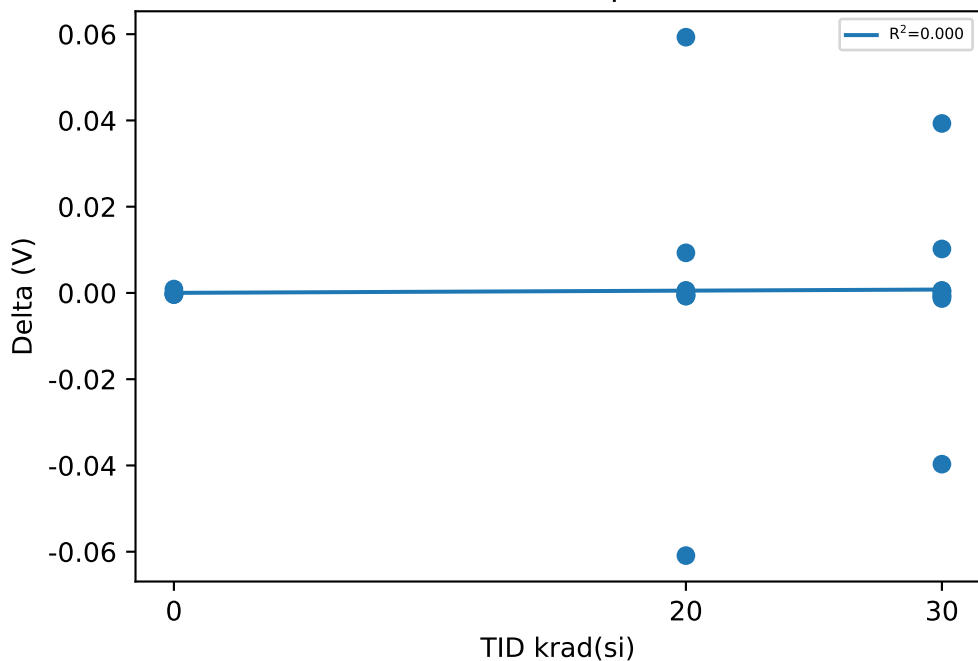

Test Statistics (V)

krad(si)	Pre Exposure Min	Pre Exposure Avg	Pre Exposure Max	Pre Exposure Std	Post Exposure Min	Post Exposure Avg	Post Exposure Max	Post Exposure Std	Min Delta	Avg Delta	Max Delta	Std Delta
0	1.9169	1.9569	1.9974	0.029353	1.9165	1.9569	1.9971	0.029286	-0.0004	-2e-05	0.0009	0.00053572
20	1.9069	1.93	1.9668	0.021151	1.9059	1.9306	1.9665	0.020333	-0.0609	0.00059	0.0593	0.0285
30	1.8966	1.934	1.9774	0.028785	1.8962	1.9347	1.9768	0.02744	-0.0397	0.00075	0.0393	0.018923

Device Test: 9.10 UJUQE8(V_FAULT_OL_UJUQE8)

TID vs Result Stats

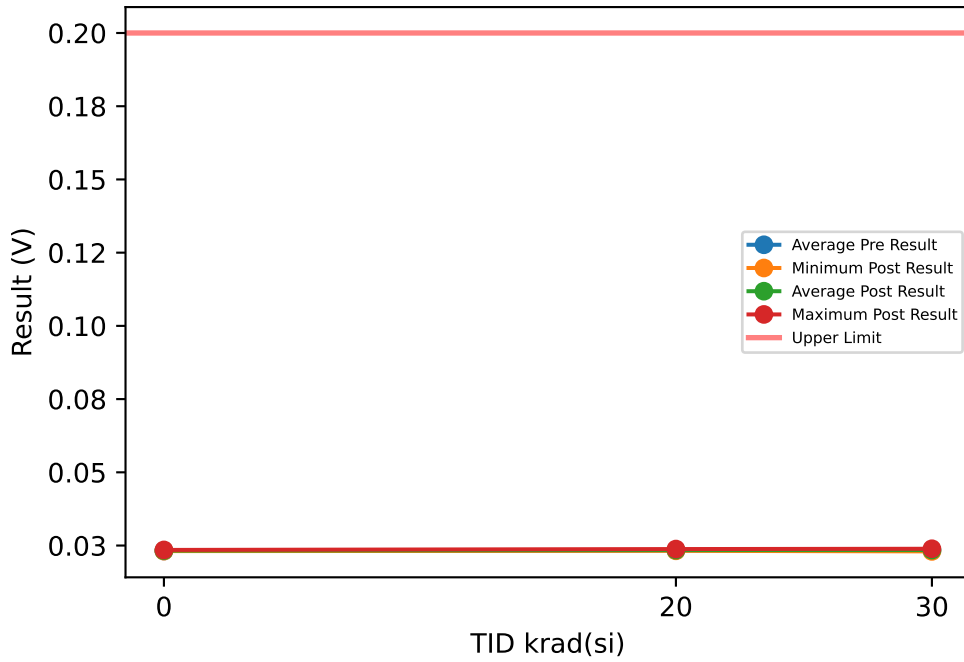

Test Results (Upper Limit = 0.2 (V))

Serial #	krad(si)	Exposure Conditions	Pre Result	Post Result	Delta
1	20	HDR unbiased	0.0233	0.0234	0.0001
2	20	HDR unbiased	0.0235	0.0235	0
3	20	HDR unbiased	0.0234	0.0234	0
4	20	HDR unbiased	0.0232	0.0232	0
5	20	HDR unbiased	0.0234	0.0236	0.0002
6	20	HDR biased	0.023	0.0238	0.0008
7	20	HDR biased	0.0235	0.0236	0.0001
8	20	HDR biased	0.0231	0.0233	0.0002
9	20	HDR biased	0.0232	0.0235	0.0003
10	20	HDR biased	0.0236	0.0232	-0.0004
11	30	HDR unbiased	0.0235	0.0236	0.0001
12	30	HDR unbiased	0.0237	0.0236	-0.0001
13	30	HDR unbiased	0.0233	0.0236	0.0003
14	30	HDR unbiased	0.0233	0.023	-0.0003
15	30	HDR unbiased	0.0229	0.023	0.0001
16	30	HDR biased	0.0237	0.0239	0.0002
17	30	HDR biased	0.0234	0.0237	0.0003
18	30	HDR biased	0.0232	0.0232	0
19	30	HDR biased	0.023	0.0235	0.0005
20	30	HDR biased	0.0233	0.0234	0.0001
21	0	correlation	0.023	0.0231	0.0001
22	0	correlation	0.0231	0.0233	0.0002
23	0	correlation	0.0231	0.0232	0.0001
24	0	correlation	0.0234	0.0235	0.0001
25	0	correlation	0.0231	0.0233	0.0002

TID vs Post - Pre Exposure Delta

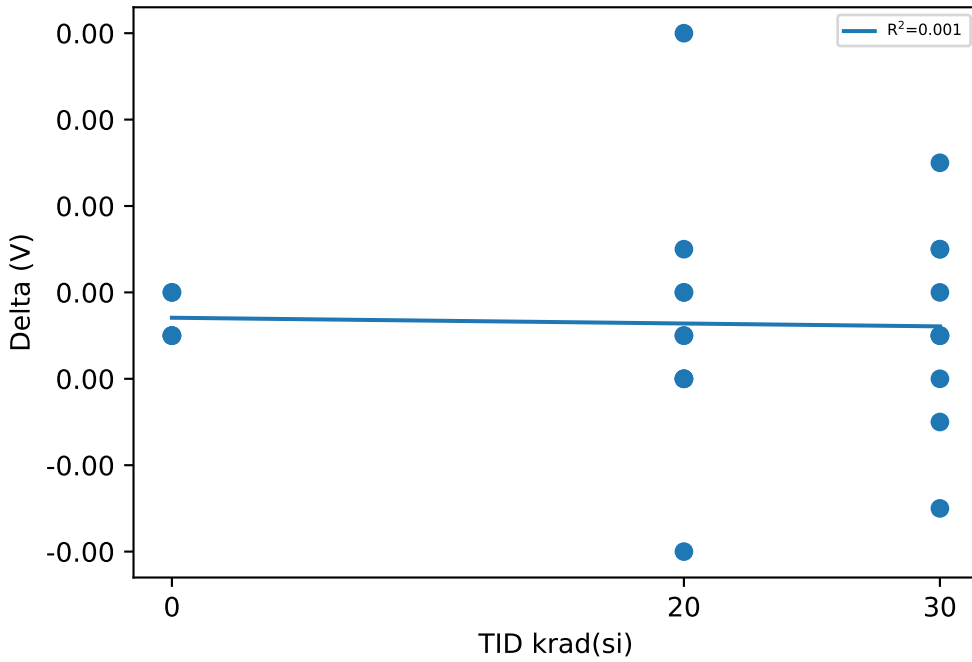

Test Statistics (V)

krad(si)	Pre Exposure Min	Pre Exposure Avg	Pre Exposure Max	Pre Exposure Std	Post Exposure Min	Post Exposure Avg	Post Exposure Max	Post Exposure Std	Min Delta	Avg Delta	Max Delta	Std Delta
0	0.023	0.02314	0.0234	0.00015166	0.0231	0.02328	0.0235	0.00014832	0.0001	0.00014	0.0002	5.4772e-05
20	0.023	0.02332	0.0236	0.00019322	0.0232	0.02345	0.0238	0.00019003	-0.0004	0.00013	0.0008	0.00030203
30	0.0229	0.02333	0.0237	0.00026268	0.023	0.02345	0.0239	0.00029907	-0.0003	0.00012	0.0005	0.00022509

Device Test: 9.11 UJWCB3(TOL_OFF_UJWCB3)

TID vs Result Stats

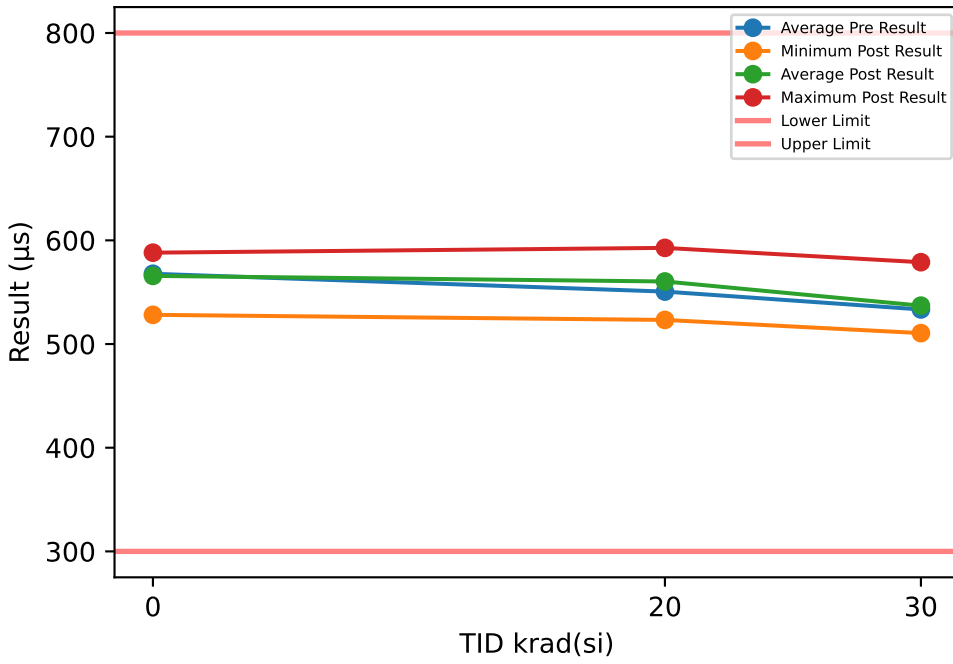

TID vs Post - Pre Exposure Delta

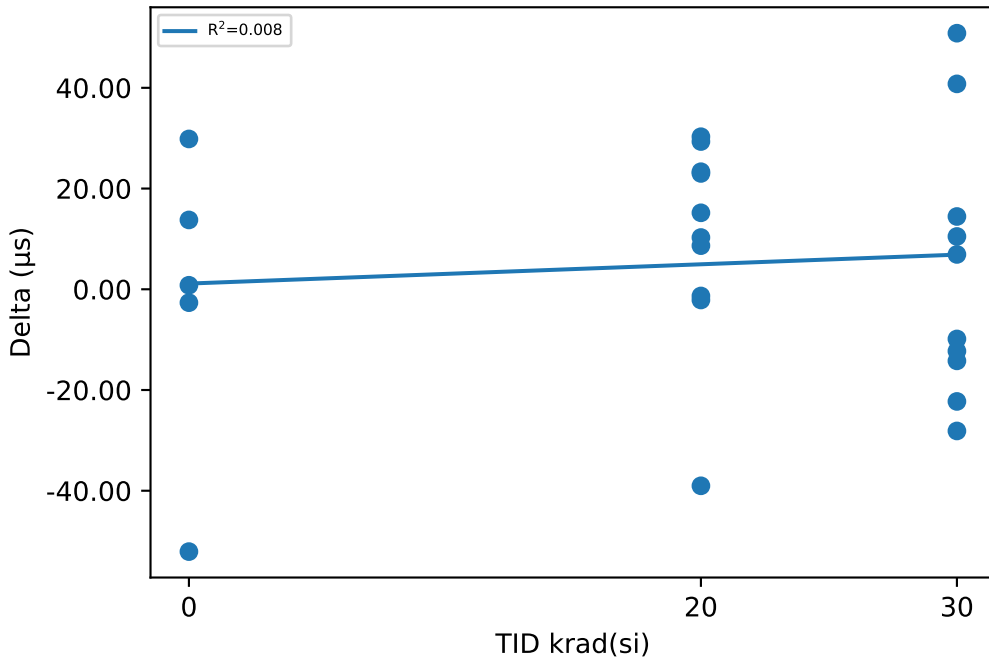

Test Results (Lower Limit = 300.0, Upper Limit = 800.0 (µs))

Serial #	krad(si)	Exposure Conditions	Pre Result	Post Result	Delta
1	20	HDR unbiased	508.07	523.26	15.184
2	20	HDR unbiased	567.17	565.05	-2.1245
3	20	HDR unbiased	578.5	539.48	-39.021
4	20	HDR unbiased	563.41	592.74	29.336
5	20	HDR unbiased	518.86	529.14	10.277
6	20	HDR biased	555.65	585.94	30.29
7	20	HDR biased	568.46	591.46	23
8	20	HDR biased	548.38	557.04	8.6629
9	20	HDR biased	545.7	544.37	-1.329
10	20	HDR biased	551.65	574.99	23.341
11	30	HDR unbiased	513.59	520.51	6.918
12	30	HDR unbiased	586.41	564.14	-22.268
13	30	HDR unbiased	523.53	537.98	14.451
14	30	HDR unbiased	528.69	516.42	-12.274
15	30	HDR unbiased	495.09	535.87	40.783
16	30	HDR biased	509	519.48	10.487
17	30	HDR biased	536.43	526.56	-9.8634
18	30	HDR biased	528.09	578.94	50.845
19	30	HDR biased	573.98	559.77	-14.213
20	30	HDR biased	538.66	510.53	-28.129
21	0	correlation	574.36	588.13	13.768
22	0	correlation	568.67	569.47	0.7989
23	0	correlation	580.25	528.17	-52.084
24	0	correlation	575.42	572.76	-2.6597
25	0	correlation	540.21	570.06	29.848

Test Statistics (µs)

krad(si)	Pre Exposure Min	Pre Exposure Avg	Pre Exposure Max	Pre Exposure Std	Post Exposure Min	Post Exposure Avg	Post Exposure Max	Post Exposure Std	Min Delta	Avg Delta	Max Delta	Std Delta
0	540.21	567.78	580.25	15.954	528.17	565.72	588.13	22.332	-52.084	-2.0658	29.848	30.739
20	508.07	550.59	578.5	22.13	523.26	560.35	592.74	25.734	-39.021	9.7616	30.29	20.654
30	495.09	533.35	586.41	28.081	510.53	537.02	578.94	23.161	-28.129	3.6737	50.845	26.283

Device Test: 9.12 UJBGA6(VCSH_UJBGA6)

TID vs Result Stats

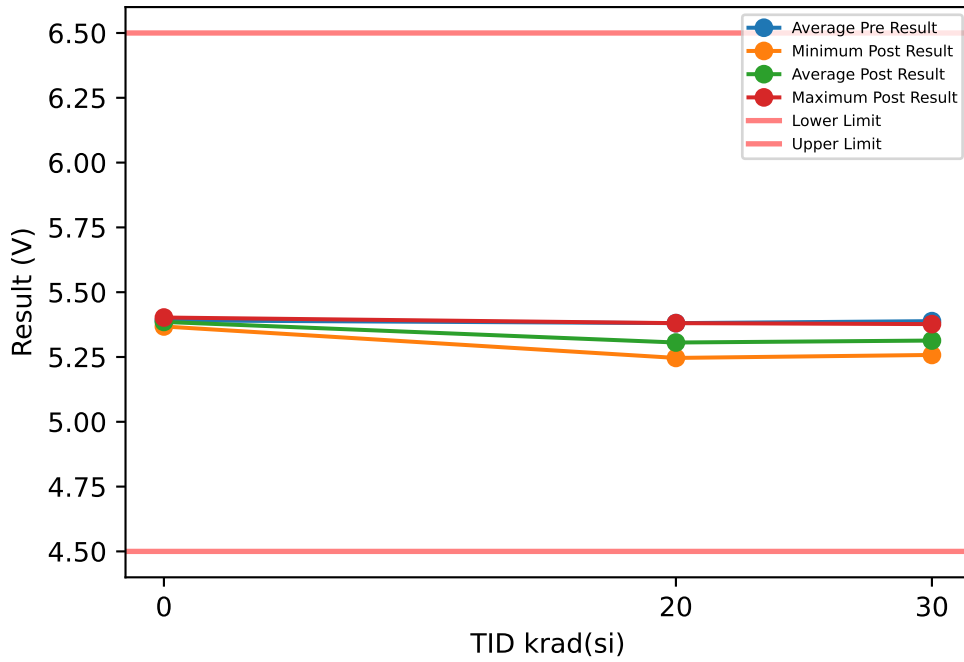

Test Results (Lower Limit = 4.5, Upper Limit = 6.5 (V))

Serial #	krad(si)	Exposure Conditions	Pre Result	Post Result	Delta
1	20	HDR unbiased	5.355	5.3268	-0.0282
2	20	HDR unbiased	5.3874	5.3585	-0.0289
3	20	HDR unbiased	5.4041	5.3806	-0.0235
4	20	HDR unbiased	5.3783	5.3505	-0.0278
5	20	HDR unbiased	5.3858	5.3539	-0.0319
6	20	HDR biased	5.3779	5.2552	-0.1227
7	20	HDR biased	5.3906	5.2655	-0.1251
8	20	HDR biased	5.3857	5.2589	-0.1268
9	20	HDR biased	5.3728	5.2464	-0.1264
10	20	HDR biased	5.3685	5.2625	-0.106
11	30	HDR unbiased	5.4086	5.3769	-0.0317
12	30	HDR unbiased	5.3813	5.3425	-0.0388
13	30	HDR unbiased	5.3796	5.3442	-0.0354
14	30	HDR unbiased	5.379	5.3315	-0.0475
15	30	HDR unbiased	5.3845	5.348	-0.0365
16	30	HDR biased	5.3818	5.2579	-0.1239
17	30	HDR biased	5.3938	5.2785	-0.1153
18	30	HDR biased	5.4125	5.3211	-0.0914
19	30	HDR biased	5.3687	5.2588	-0.1099
20	30	HDR biased	5.3935	5.275	-0.1185
21	0	correlation	5.4092	5.4023	-0.0069
22	0	correlation	5.3728	5.3678	-0.005
23	0	correlation	5.3826	5.376	-0.0066
24	0	correlation	5.3924	5.3857	-0.0067
25	0	correlation	5.3997	5.395	-0.0047

TID vs Post - Pre Exposure Delta

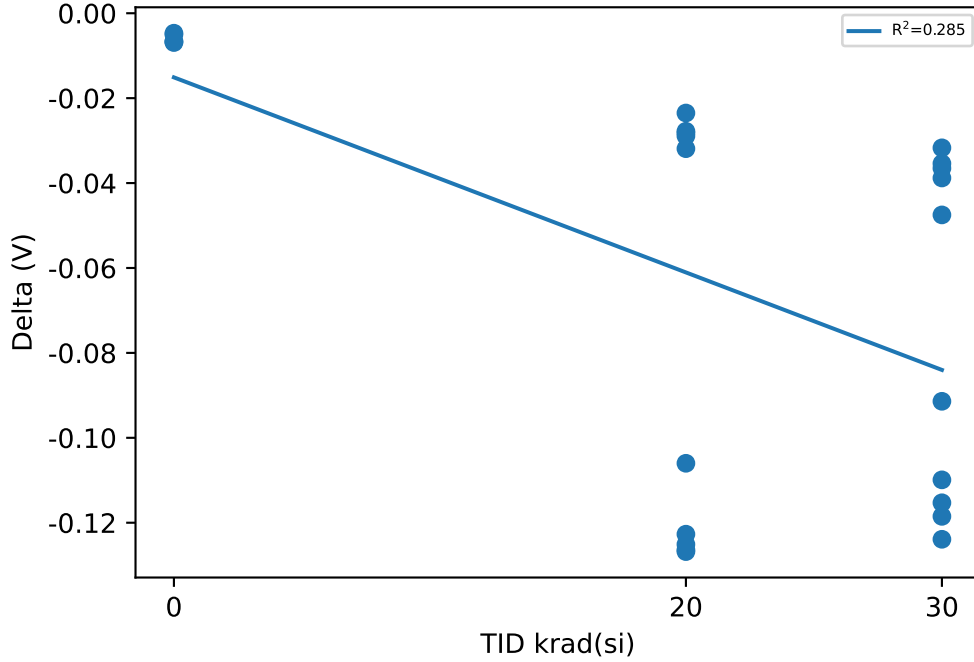

Test Statistics (V)

krad(si)	Pre Exposure Min	Pre Exposure Avg	Pre Exposure Max	Pre Exposure Std	Post Exposure Min	Post Exposure Avg	Post Exposure Max	Post Exposure Std	Min Delta	Avg Delta	Max Delta	Std Delta
0	5.3728	5.3913	5.4092	0.014231	5.3678	5.3854	5.4023	0.013928	-0.0069	-0.00598	-0.0047	0.0010426
20	5.355	5.3806	5.4041	0.013444	5.2464	5.3059	5.3806	0.052612	-0.1268	-0.07473	-0.0235	0.04958
30	5.3687	5.3883	5.4125	0.013772	5.2579	5.3134	5.3769	0.042382	-0.1239	-0.07489	-0.0317	0.039981

Device Test: 9.13 UJP7QA(ICSH_UJP7QA)

TID vs Result Stats

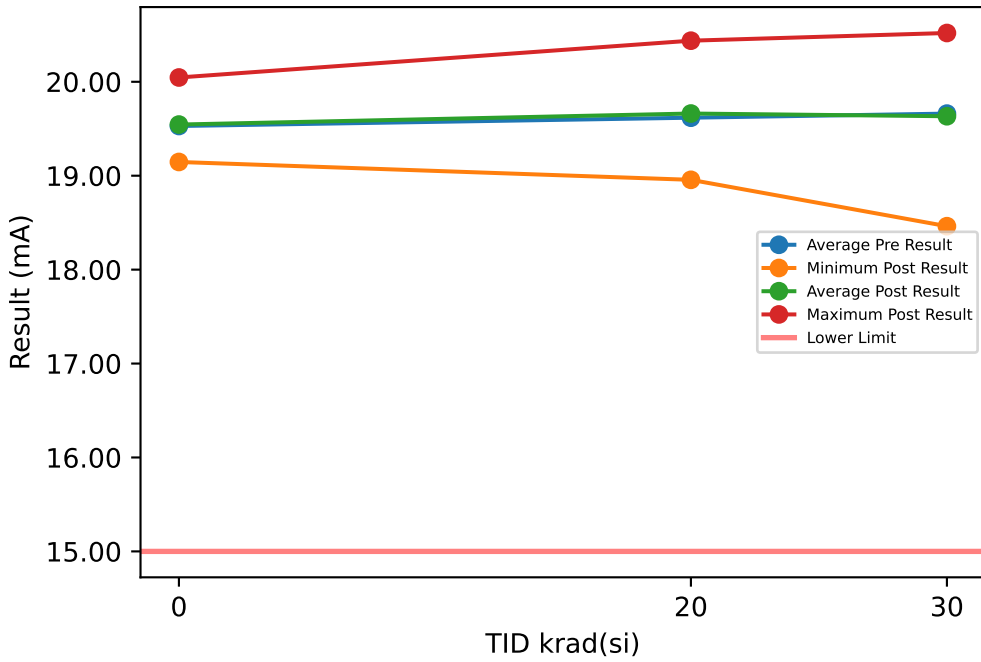

TID vs Post - Pre Exposure Delta

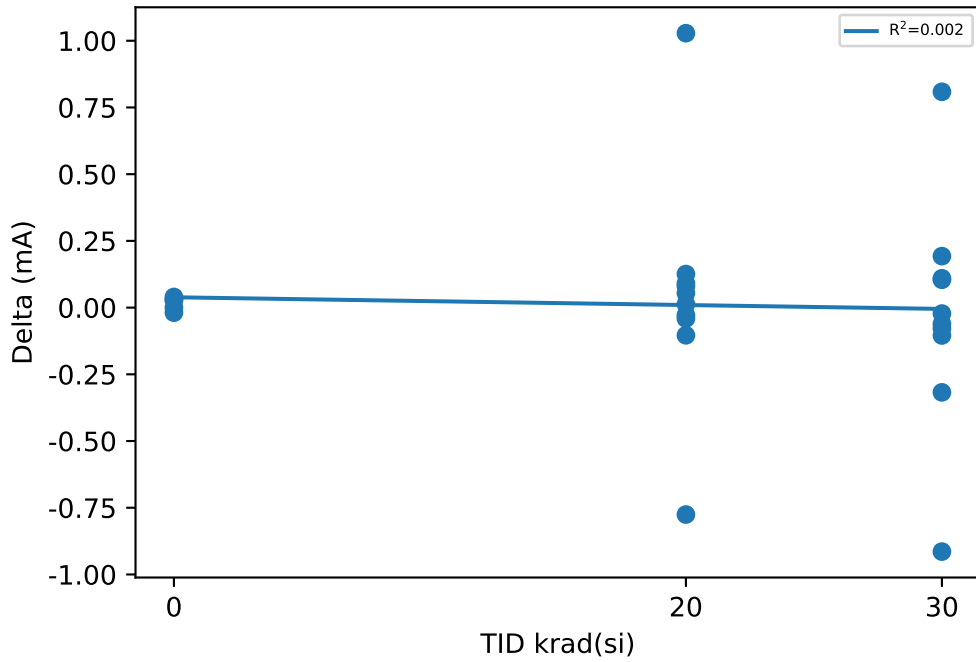

Test Results (Lower Limit = 15.0 (mA))

Serial #	krad(si)	Exposure Conditions	Pre Result	Post Result	Delta
1	20	HDR unbiased	18.902	18.956	0.0544
2	20	HDR unbiased	20.421	20.38	-0.0409
3	20	HDR unbiased	19.679	19.692	0.0129
4	20	HDR unbiased	19.018	18.99	-0.0281
5	20	HDR unbiased	20.541	20.438	-0.1038
6	20	HDR biased	18.992	20.02	1.0283
7	20	HDR biased	20.27	20.395	0.1257
8	20	HDR biased	19.334	19.415	0.0808
9	20	HDR biased	19.124	19.215	0.0911
10	20	HDR biased	19.896	19.12	-0.7754
11	30	HDR unbiased	20.076	19.999	-0.0774
12	30	HDR unbiased	20.404	20.087	-0.3176
13	30	HDR unbiased	19.486	19.59	0.1044
14	30	HDR unbiased	19.377	18.462	-0.9143
15	30	HDR unbiased	18.607	18.546	-0.0608
16	30	HDR biased	20.196	20.305	0.1098
17	30	HDR biased	20.327	20.52	0.1929
18	30	HDR biased	19.321	19.298	-0.0223
19	30	HDR biased	18.609	19.418	0.8087
20	30	HDR biased	20.21	20.105	-0.1044
21	0	correlation	19.119	19.146	0.027
22	0	correlation	19.512	19.494	-0.019
23	0	correlation	19.404	19.404	-0.0001
24	0	correlation	20.016	20.046	0.0298
25	0	correlation	19.594	19.634	0.0399

Test Statistics (mA)

krad(si)	Pre Exposure Min	Pre Exposure Avg	Pre Exposure Max	Pre Exposure Std	Post Exposure Min	Post Exposure Avg	Post Exposure Max	Post Exposure Std	Min Delta	Avg Delta	Max Delta	Std Delta
0	19.119	19.529	20.016	0.32602	19.146	19.545	20.046	0.33176	-0.019	0.01552	0.0399	0.024319
20	18.902	19.618	20.541	0.63178	18.956	19.662	20.438	0.60437	-0.7754	0.0445	1.0283	0.4328
30	18.607	19.661	20.404	0.68311	18.462	19.633	20.52	0.70805	-0.9143	-0.0281	0.8087	0.43001

Device Test: 9.2 UJ5EAX(IOL_OFF_OUT1_UJ5EAX)

TID vs Result Stats

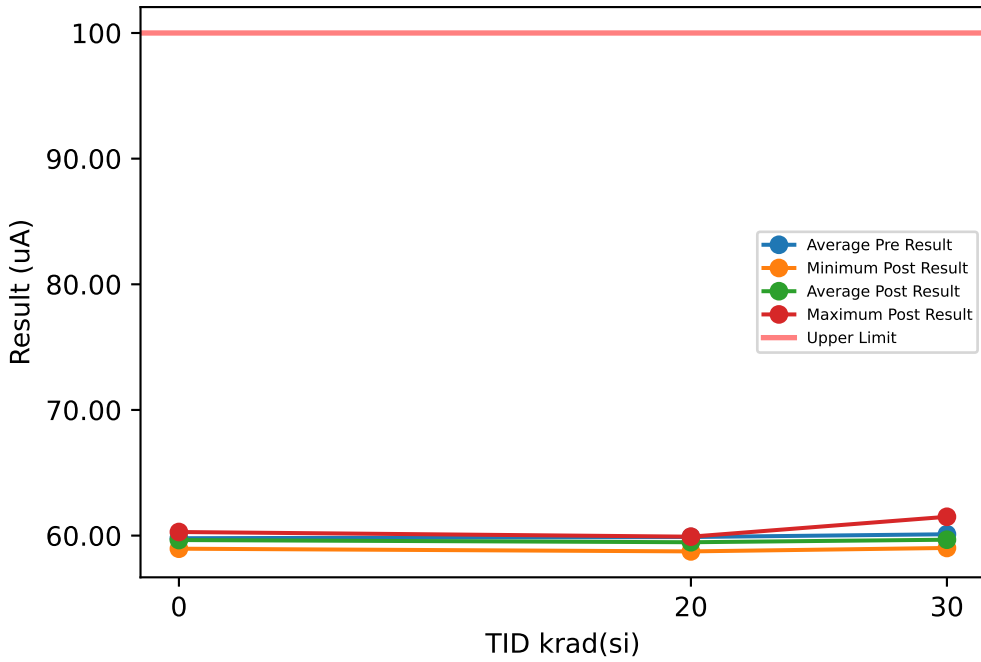

Test Results (Upper Limit = 100.0 (uA))

Serial #	krad(si)	Exposure Conditions	Pre Result	Post Result	Delta
1	20	HDR unbiased	59.678	59.466	-0.212
2	20	HDR unbiased	59.756	59.309	-0.4464
3	20	HDR unbiased	59.248	58.743	-0.5051
4	20	HDR unbiased	60.029	59.446	-0.5831
5	20	HDR unbiased	60.049	59.681	-0.3682
6	20	HDR biased	59.951	59.407	-0.544
7	20	HDR biased	60.166	59.856	-0.3096
8	20	HDR biased	60.166	59.915	-0.251
9	20	HDR biased	60.068	59.251	-0.8175
10	20	HDR biased	59.756	59.642	-0.1143
11	30	HDR unbiased	59.502	59.329	-0.1729
12	30	HDR unbiased	60.01	59.427	-0.5831
13	30	HDR unbiased	59.56	59.016	-0.5441
14	30	HDR unbiased	60.439	60.013	-0.4267
15	30	HDR unbiased	59.795	59.212	-0.5831
16	30	HDR biased	59.756	59.349	-0.4073
17	30	HDR biased	59.717	59.329	-0.3878
18	30	HDR biased	61.826	61.497	-0.3289
19	30	HDR biased	60.439	59.974	-0.4658
20	30	HDR biased	60.029	59.583	-0.4464
21	0	correlation	59.346	58.958	-0.3879
22	0	correlation	59.756	59.505	-0.251
23	0	correlation	60.244	60.13	-0.1142
24	0	correlation	60.205	60.286	0.0811
25	0	correlation	59.404	59.349	-0.0557

TID vs Post - Pre Exposure Delta

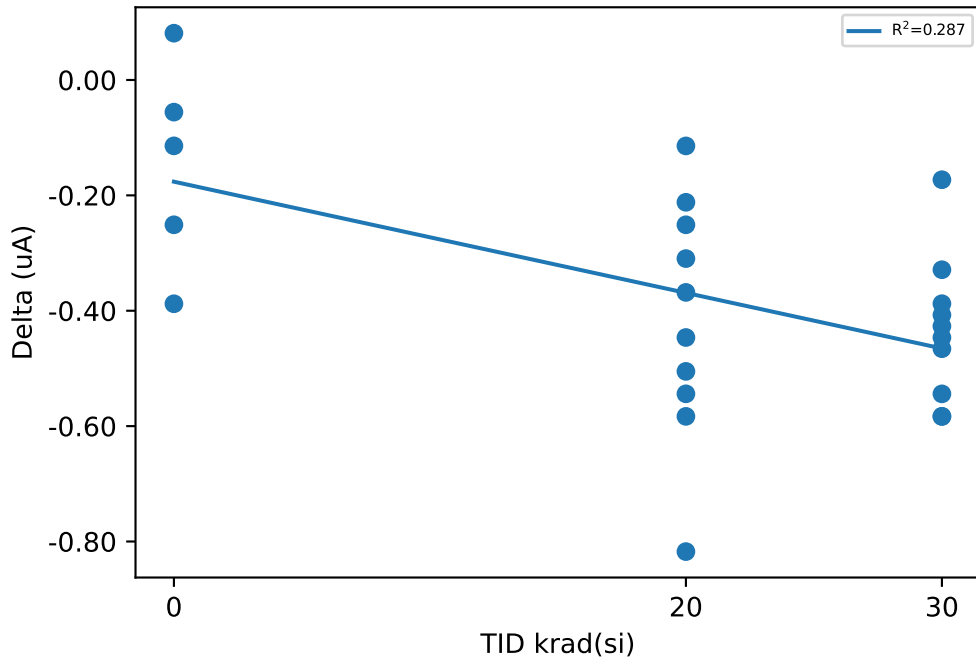

Test Statistics (uA)

krad(si)	Pre Exposure Min	Pre Exposure Avg	Pre Exposure Max	Pre Exposure Std	Post Exposure Min	Post Exposure Avg	Post Exposure Max	Post Exposure Std	Min Delta	Avg Delta	Max Delta	Std Delta
0	59.346	59.791	60.244	0.42601	58.958	59.645	60.286	0.55364	-0.3879	-0.14554	0.0811	0.18047
20	59.248	59.887	60.166	0.28395	58.743	59.472	59.915	0.33799	-0.8175	-0.41512	-0.1143	0.20759
30	59.502	60.107	61.826	0.68556	59.016	59.673	61.497	0.71402	-0.5831	-0.43461	-0.1729	0.12466

Device Test: 9.3 UJ5EAX(IOL_OFF_OUT2_UJ5EAX)

TID vs Result Stats

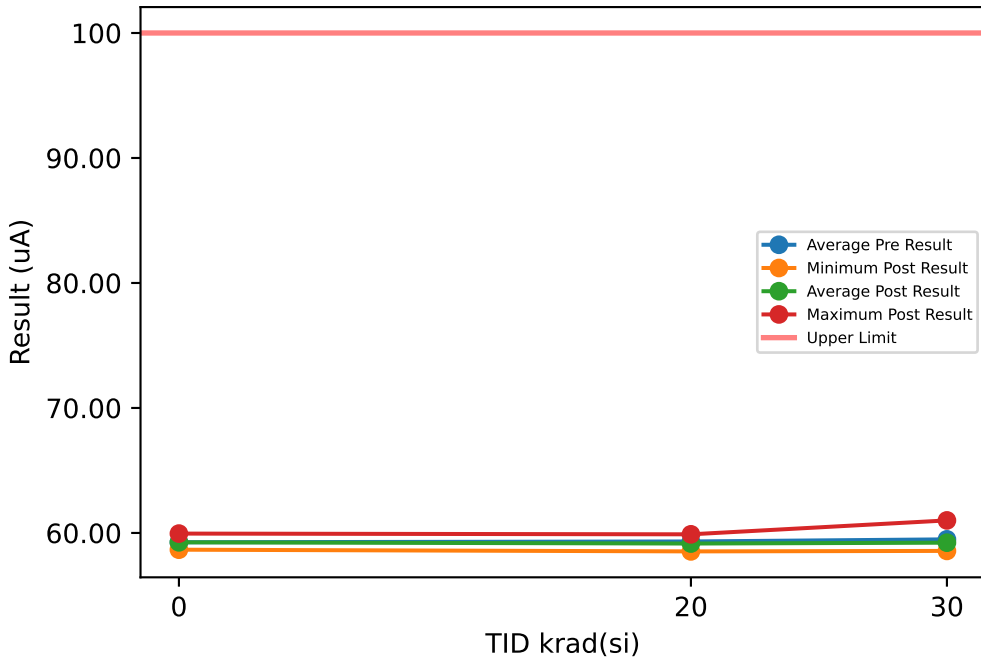

Test Results (Upper Limit = 100.0 (uA))

Serial #	krad(si)	Exposure Conditions	Pre Result	Post Result	Delta
1	20	HDR unbiased	58.97	58.524	-0.4456
2	20	HDR unbiased	59.693	59.403	-0.2901
3	20	HDR unbiased	59.204	58.758	-0.4459
4	20	HDR unbiased	59.126	59.032	-0.0944
5	20	HDR unbiased	60.005	59.891	-0.1146
6	20	HDR biased	59.282	59.071	-0.2116
7	20	HDR biased	58.892	59.051	0.1595
8	20	HDR biased	59.654	59.539	-0.1143
9	20	HDR biased	59.263	58.993	-0.2702
10	20	HDR biased	59.107	59.266	0.1594
11	30	HDR unbiased	58.872	58.563	-0.3089
12	30	HDR unbiased	58.814	58.622	-0.1917
13	30	HDR unbiased	59.204	59.012	-0.1921
14	30	HDR unbiased	59.908	59.442	-0.4659
15	30	HDR unbiased	58.95	58.797	-0.1528
16	30	HDR biased	59.126	58.876	-0.2505
17	30	HDR biased	59.497	59.344	-0.1532
18	30	HDR biased	61.334	61.003	-0.3304
19	30	HDR biased	59.927	59.52	-0.4073
20	30	HDR biased	59.243	59.032	-0.2116
21	0	correlation	59.048	59.09	0.0423
22	0	correlation	58.989	59.012	0.0228
23	0	correlation	59.536	59.539	0.0029
24	0	correlation	59.751	59.949	0.198
25	0	correlation	58.95	58.661	-0.2895

TID vs Post - Pre Exposure Delta

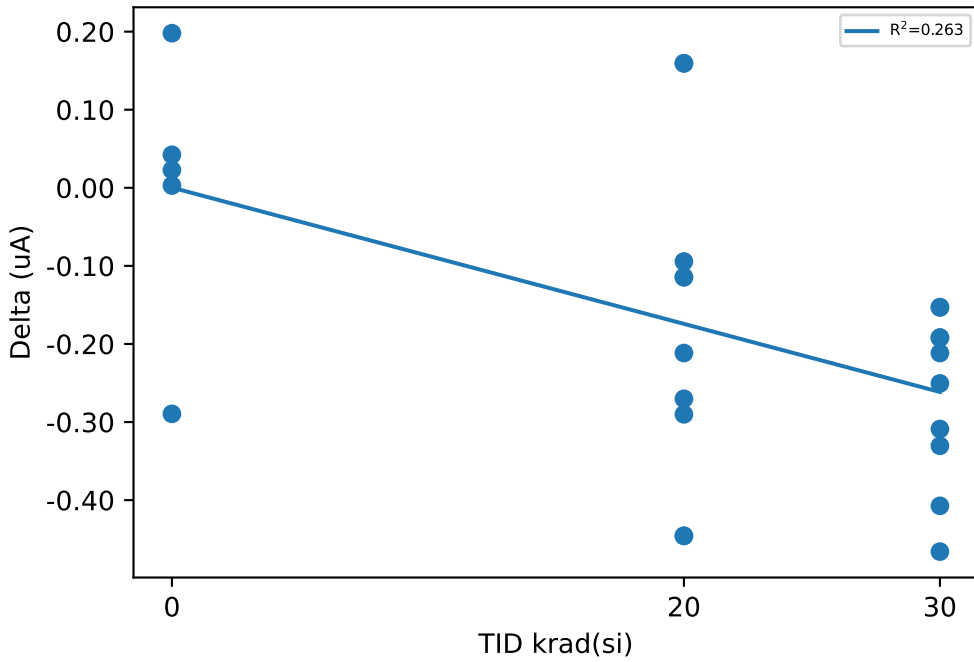

Test Statistics (uA)

krad(si)	Pre Exposure Min	Pre Exposure Avg	Pre Exposure Max	Pre Exposure Std	Post Exposure Min	Post Exposure Avg	Post Exposure Max	Post Exposure Std	Min Delta	Avg Delta	Max Delta	Std Delta
0	58.95	59.255	59.751	0.3646	58.661	59.25	59.949	0.50048	-0.2895	-0.0047	0.198	0.17693
20	58.892	59.32	60.005	0.35388	58.524	59.153	59.891	0.39117	-0.4459	-0.16678	0.1595	0.21269
30	58.814	59.488	61.334	0.75797	58.563	59.221	61.003	0.7071	-0.4659	-0.26644	-0.1528	0.10834

Device Test: 9.4 UJ5EAX(IOL_OFF_OUT3_UJ5EAX)

TID vs Result Stats

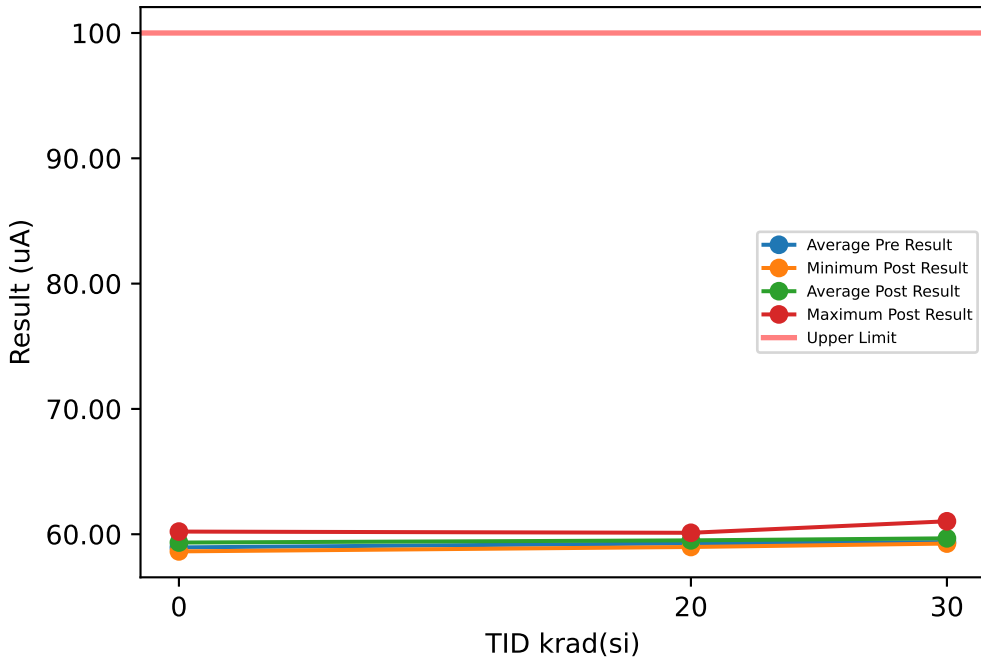

Test Results (Upper Limit = 100.0 (uA))

Serial #	krad(si)	Exposure Conditions	Pre Result	Post Result	Delta
1	20	HDR unbiased	59.168	59.704	0.5361
2	20	HDR unbiased	59.344	59.568	0.2236
3	20	HDR unbiased	59.071	58.982	-0.0888
4	20	HDR unbiased	59.012	59.216	0.2042
5	20	HDR unbiased	59.676	59.626	-0.0499
6	20	HDR biased	59.344	59.021	-0.3233
7	20	HDR biased	59.325	59.275	-0.0499
8	20	HDR biased	59.481	60.115	0.6338
9	20	HDR biased	59.325	59.88	0.5556
10	20	HDR biased	58.973	59.724	0.7511
11	30	HDR unbiased	59.52	59.646	0.1259
12	30	HDR unbiased	59.325	59.529	0.204
13	30	HDR unbiased	59.168	59.353	0.1846
14	30	HDR unbiased	59.305	59.841	0.5361
15	30	HDR unbiased	58.817	59.412	0.5949
16	30	HDR biased	58.778	59.255	0.4777
17	30	HDR biased	59.364	59.509	0.1455
18	30	HDR biased	60.888	61.033	0.145
19	30	HDR biased	59.247	59.704	0.458
20	30	HDR biased	59.305	59.451	0.1455
21	0	correlation	58.582	59.119	0.5363
22	0	correlation	58.426	59.099	0.6731
23	0	correlation	59.5	59.626	0.1259
24	0	correlation	59.696	60.212	0.5164
25	0	correlation	58.543	58.63	0.0871

TID vs Post - Pre Exposure Delta

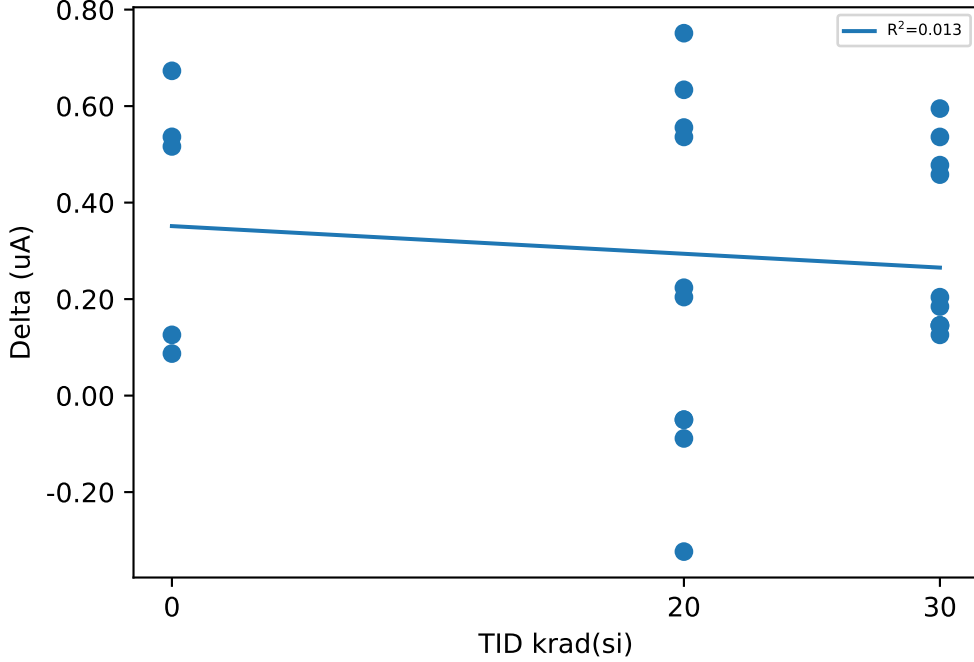

Test Statistics (uA)

krad(si)	Pre Exposure Min	Pre Exposure Avg	Pre Exposure Max	Pre Exposure Std	Post Exposure Min	Post Exposure Avg	Post Exposure Max	Post Exposure Std	Min Delta	Avg Delta	Max Delta	Std Delta
0	58.426	58.95	59.696	0.59889	58.63	59.337	60.212	0.60283	0.0871	0.38776	0.6731	0.2641
20	58.973	59.272	59.676	0.21891	58.982	59.511	60.115	0.37461	-0.3233	0.23925	0.7511	0.36494
30	58.778	59.372	60.888	0.58205	59.255	59.673	61.033	0.50781	0.1259	0.30172	0.5949	0.18969

Device Test: 9.5 UJ5EAX(IOL_OFF_OUT4_UJ5EAX)

TID vs Result Stats

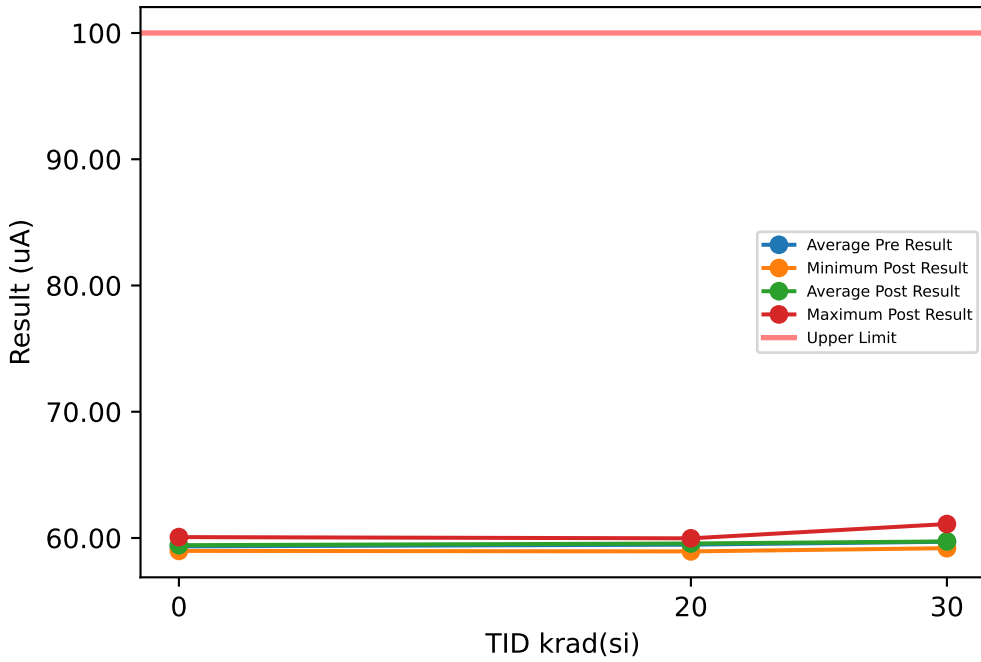

Test Results (Upper Limit = 100.0 (uA))

Serial #	krad(si)	Exposure Conditions	Pre Result	Post Result	Delta
1	20	HDR unbiased	60.058	59.914	-0.144
2	20	HDR unbiased	59.1	59.055	-0.0454
3	20	HDR unbiased	59.511	59.445	-0.0653
4	20	HDR unbiased	59.354	59.66	0.3058
5	20	HDR unbiased	59.745	59.973	0.2273
6	20	HDR biased	59.55	58.938	-0.612
7	20	HDR biased	59.745	59.855	0.1101
8	20	HDR biased	59.804	59.973	0.1687
9	20	HDR biased	58.866	59.114	0.2477
10	20	HDR biased	58.983	59.719	0.7357
11	30	HDR unbiased	59.667	59.523	-0.1435
12	30	HDR unbiased	59.315	59.465	0.1497
13	30	HDR unbiased	59.706	59.484	-0.2217
14	30	HDR unbiased	59.823	59.875	0.0515
15	30	HDR unbiased	59.726	59.738	0.0125
16	30	HDR biased	58.963	59.27	0.3062
17	30	HDR biased	59.745	59.582	-0.1632
18	30	HDR biased	61.035	61.105	0.0698
19	30	HDR biased	59.96	60.051	0.0904
20	30	HDR biased	59.081	59.192	0.1109
21	0	correlation	58.69	58.996	0.3065
22	0	correlation	59.022	59.094	0.0719
23	0	correlation	60.136	60.011	-0.1246
24	0	correlation	60.038	60.07	0.0318
25	0	correlation	58.788	58.977	0.1892

TID vs Post - Pre Exposure Delta

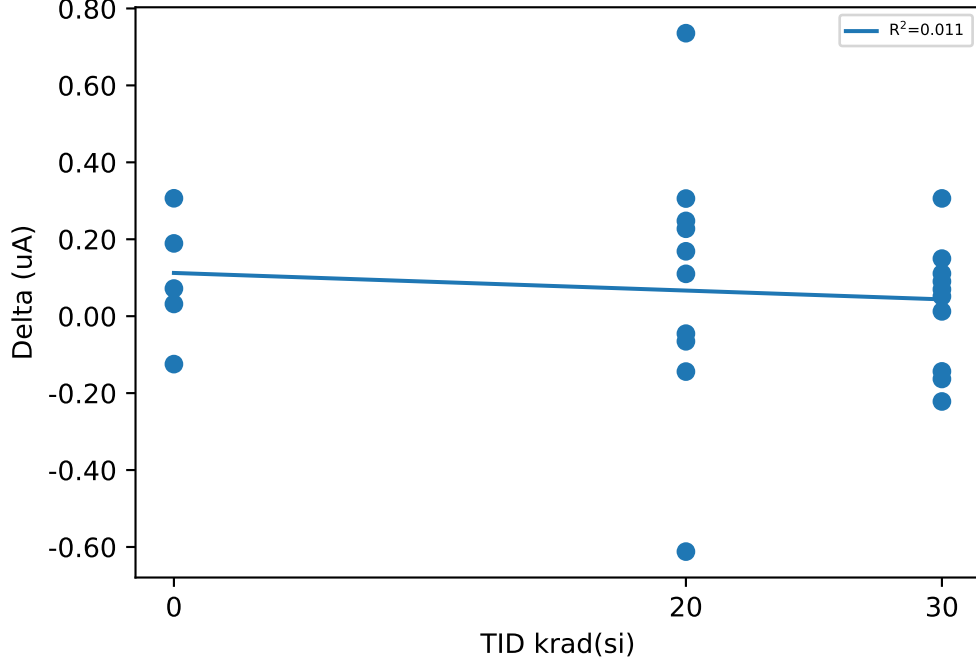

Test Statistics (uA)

krad(si)	Pre Exposure Min	Pre Exposure Avg	Pre Exposure Max	Pre Exposure Std	Post Exposure Min	Post Exposure Avg	Post Exposure Max	Post Exposure Std	Min Delta	Avg Delta	Max Delta	Std Delta
0	58.69	59.335	60.136	0.69823	58.977	59.43	60.07	0.55995	-0.1246	0.09496	0.3065	0.16306
20	58.866	59.472	60.058	0.38999	58.938	59.564	59.973	0.40035	-0.612	0.09286	0.7357	0.3502
30	58.963	59.702	61.035	0.57184	59.192	59.728	61.105	0.54882	-0.2217	0.02626	0.3062	0.16118

Device Test: 10.1 UJR405(dCSR_5mA_CH1_UJR405)

TID vs Result Stats

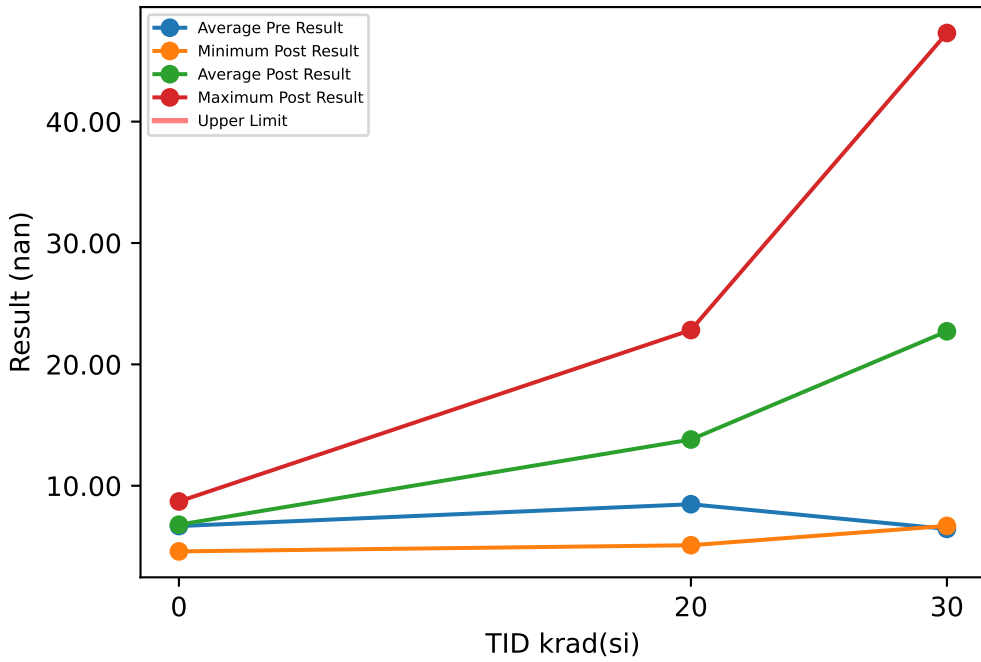

Test Results (No Limits Specified (nan))

Serial #	krad(si)	Exposure Conditions	Pre Result	Post Result	Delta
1	20	HDR unbiased	13.26	9.323	-3.937
2	20	HDR unbiased	9.797	7.178	-2.619
3	20	HDR unbiased	8.485	7.543	-0.942
4	20	HDR unbiased	4.774	5.101	0.327
5	20	HDR unbiased	10.039	10.106	0.067
6	20	HDR biased	7.793	17.628	9.835
7	20	HDR biased	6.434	22.829	16.395
8	20	HDR biased	7.984	22.112	14.128
9	20	HDR biased	8.189	16.723	8.534
10	20	HDR biased	8.024	19.548	11.524
11	30	HDR unbiased	6.925	8.777	1.852
12	30	HDR unbiased	2.53	10.289	7.759
13	30	HDR unbiased	5.86	6.693	0.833
14	30	HDR unbiased	5.286	11.075	5.789
15	30	HDR unbiased	7.965	7.185	-0.78
16	30	HDR biased	6.267	35.603	29.336
17	30	HDR biased	7.984	31.591	23.607
18	30	HDR biased	7.402	33.312	25.91
19	30	HDR biased	7.367	47.302	39.935
20	30	HDR biased	6.859	35.419	28.56
21	0	correlation	7.841	5.423	-2.418
22	0	correlation	4.33	4.593	0.263
23	0	correlation	8.871	8.706	-0.165
24	0	correlation	6.397	7.867	1.47
25	0	correlation	5.962	7.378	1.416

TID vs Post - Pre Exposure Delta

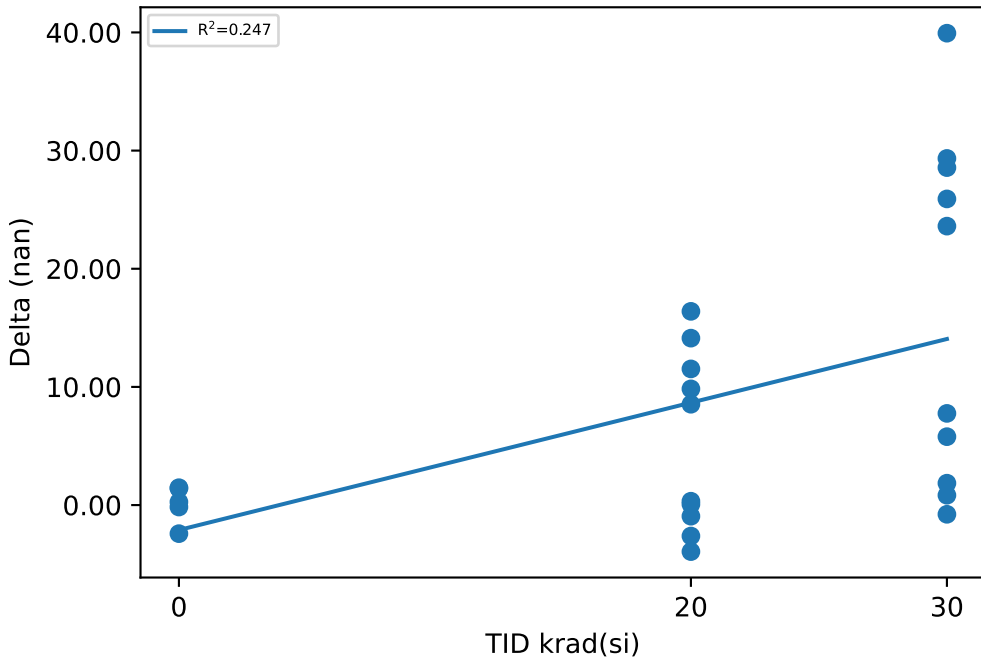

Test Statistics (nan)

krad(si)	Pre Exposure Min	Pre Exposure Avg	Pre Exposure Max	Pre Exposure Std	Post Exposure Min	Post Exposure Avg	Post Exposure Max	Post Exposure Std	Min Delta	Avg Delta	Max Delta	Std Delta
0	4.33	6.6802	8.871	1.7512	4.593	6.7934	8.706	1.7228	-2.418	0.1132	1.47	1.5847
20	4.774	8.4779	13.26	2.2594	5.101	13.809	22.829	6.6601	-3.937	5.3312	16.395	7.527
30	2.53	6.4445	7.984	1.6293	6.693	22.725	47.302	15.294	-0.78	16.28	39.935	14.711

Device Test: 10.12 UJA0RR(dCSR_500mA_CH2_UJA0RR)

TID vs Result Stats

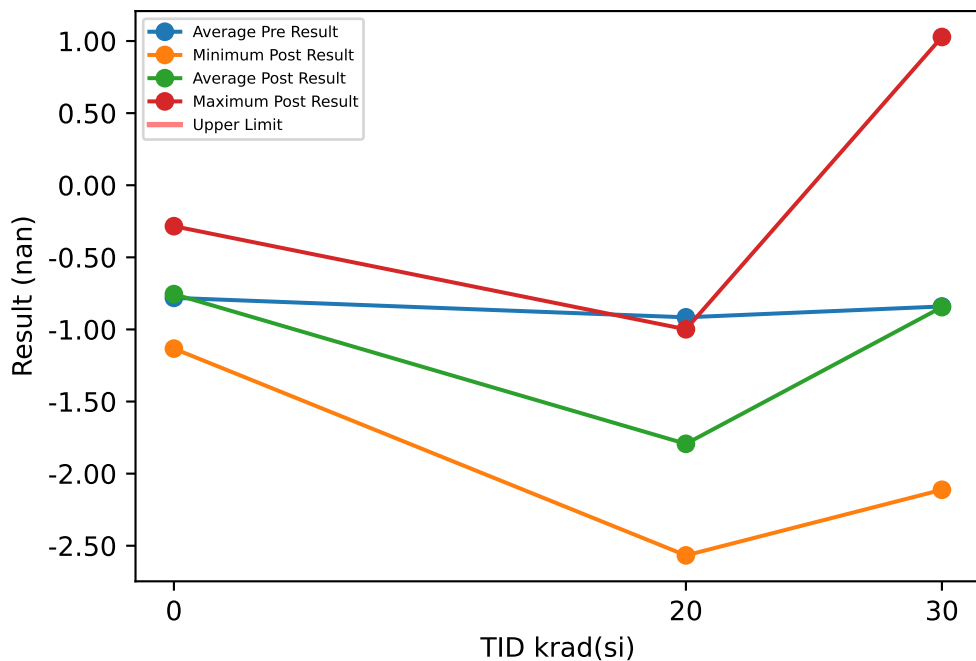

Test Results (No Limits Specified (nan))

Serial #	krad(si)	Exposure Conditions	Pre Result	Post Result	Delta
1	20	HDR unbiased	-1.21	-1.735	-0.525
2	20	HDR unbiased	-0.468	-0.999	-0.531
3	20	HDR unbiased	-0.52	-1.178	-0.658
4	20	HDR unbiased	-1.175	-1.742	-0.567
5	20	HDR unbiased	-1.173	-1.62	-0.447
6	20	HDR biased	-1.137	-2.147	-1.01
7	20	HDR biased	-0.637	-1.925	-1.288
8	20	HDR biased	-1.342	-2.567	-1.225
9	20	HDR biased	-0.512	-1.534	-1.022
10	20	HDR biased	-0.986	-2.486	-1.5
11	30	HDR unbiased	-0.939	-1.252	-0.313
12	30	HDR unbiased	-1.328	-2.112	-0.784
13	30	HDR unbiased	-1.159	-1.798	-0.639
14	30	HDR unbiased	-0.667	-0.734	-0.067
15	30	HDR unbiased	-1.08	-2.033	-0.953
16	30	HDR biased	-0.666	-0.346	0.32
17	30	HDR biased	-0.898	-0.477	0.421
18	30	HDR biased	-0.449	-0.04	0.409
19	30	HDR biased	-0.362	1.028	1.39
20	30	HDR biased	-0.859	-0.69	0.169
21	0	correlation	-0.36	-0.361	-0.001
22	0	correlation	-0.311	-0.284	0.027
23	0	correlation	-1.098	-1.133	-0.035
24	0	correlation	-1.151	-1.076	0.075
25	0	correlation	-0.985	-0.922	0.063

TID vs Post - Pre Exposure Delta

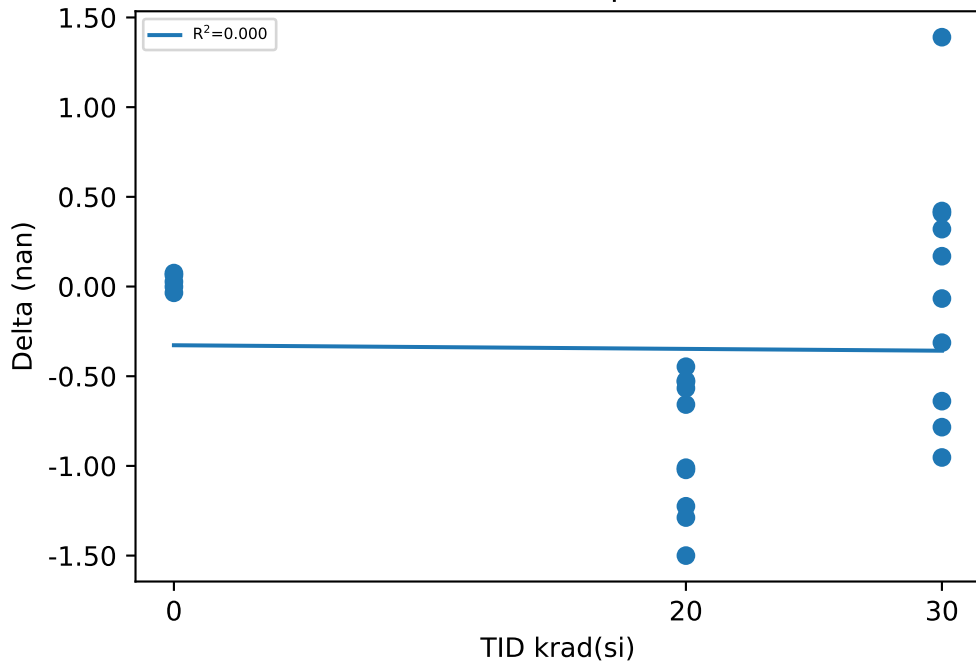

Test Statistics (nan)

krad(si)	Pre Exposure Min	Pre Exposure Avg	Pre Exposure Max	Pre Exposure Std	Post Exposure Min	Post Exposure Avg	Post Exposure Max	Post Exposure Std	Min Delta	Avg Delta	Max Delta	Std Delta
0	-1.151	-0.781	-0.311	0.41144	-1.133	-0.7552	-0.284	0.40339	-0.035	0.0258	0.075	0.045334
20	-1.342	-0.916	-0.468	0.34211	-2.567	-1.7933	-0.999	0.50922	-1.5	-0.8773	-0.447	0.37851
30	-1.328	-0.8407	-0.362	0.30779	-2.112	-0.8454	1.028	0.98135	-0.953	-0.0047	1.39	0.70246

Device Test: 10.13 UJR405(dCSR_5mA_CH3_UJR405)

TID vs Result Stats

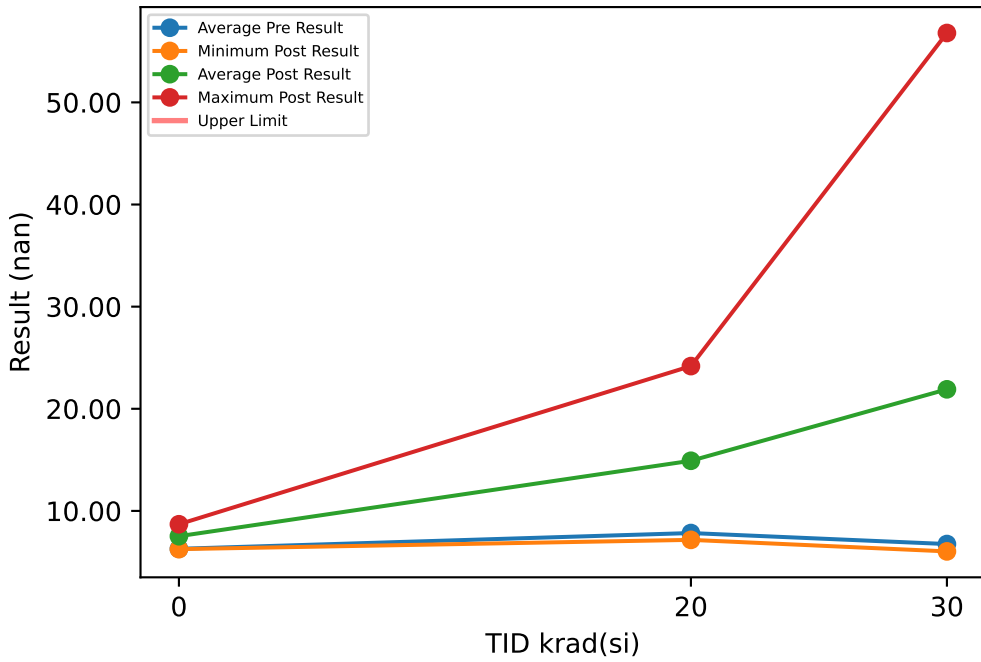

Test Results (No Limits Specified (nan))

Serial #	krad(si)	Exposure Conditions	Pre Result	Post Result	Delta
1	20	HDR unbiased	8.174	11.924	3.75
2	20	HDR unbiased	9.551	10.295	0.744
3	20	HDR unbiased	10.626	7.165	-3.461
4	20	HDR unbiased	2.545	7.553	5.008
5	20	HDR unbiased	9.596	10.849	1.253
6	20	HDR biased	8.294	22.598	14.304
7	20	HDR biased	10.673	19.261	8.588
8	20	HDR biased	6.487	24.18	17.693
9	20	HDR biased	7.22	17.134	9.914
10	20	HDR biased	5.165	18.136	12.971
11	30	HDR unbiased	5.659	10.008	4.349
12	30	HDR unbiased	8.914	7.22	-1.694
13	30	HDR unbiased	6.151	6.036	-0.115
14	30	HDR unbiased	7.85	9.24	1.39
15	30	HDR unbiased	5.144	7.153	2.009
16	30	HDR biased	4.606	32.543	27.937
17	30	HDR biased	8.1	29.766	21.666
18	30	HDR biased	4.024	25.534	21.51
19	30	HDR biased	7.737	56.794	49.057
20	30	HDR biased	9.37	34.764	25.394
21	0	correlation	5.349	8.3	2.951
22	0	correlation	4.271	6.257	1.986
23	0	correlation	7.996	8.693	0.697
24	0	correlation	5.943	6.619	0.676
25	0	correlation	7.891	7.748	-0.143

TID vs Post - Pre Exposure Delta

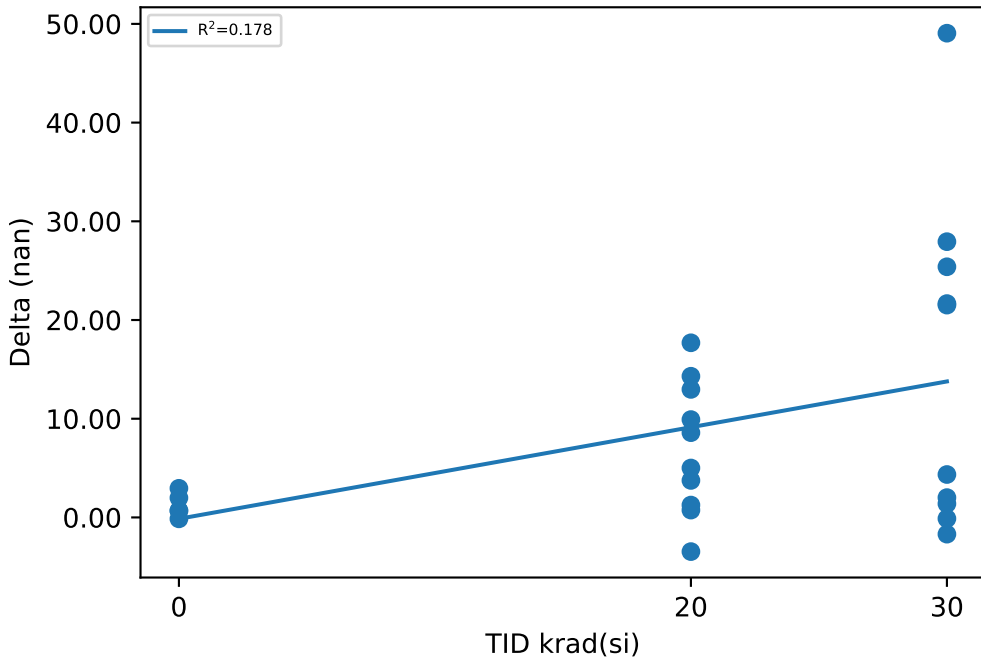

Test Statistics (nan)

krad(si)	Pre Exposure Min	Pre Exposure Avg	Pre Exposure Max	Pre Exposure Std	Post Exposure Min	Post Exposure Avg	Post Exposure Max	Post Exposure Std	Min Delta	Avg Delta	Max Delta	Std Delta
0	4.271	6.29	7.996	1.6245	6.257	7.5234	8.693	1.0539	-0.143	1.2334	2.951	1.2257
20	2.545	7.8331	10.673	2.5717	7.165	14.909	24.18	6.1476	-3.461	7.0764	17.693	6.753
30	4.024	6.7555	9.37	1.877	6.036	21.906	56.794	16.858	-1.694	15.15	49.057	16.655

Device Test: 10.14 UJFZSP(dCSR_25mA_CH3_UJFZSP)

TID vs Result Stats

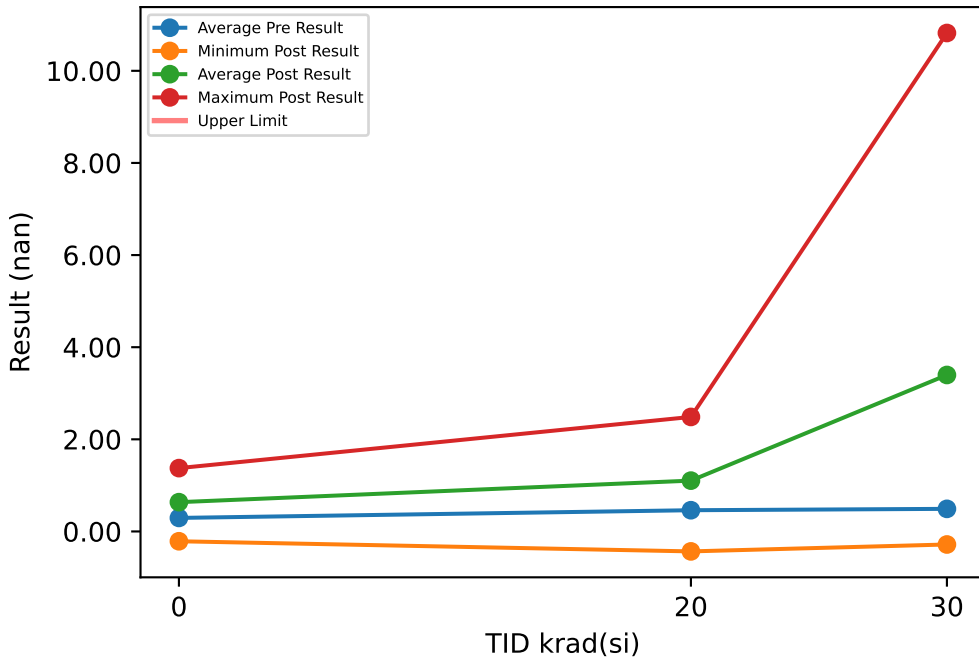

Test Results (No Limits Specified (nan))

Serial #	krad(si)	Exposure Conditions	Pre Result	Post Result	Delta
1	20	HDR unbiased	0.846	1.319	0.473
2	20	HDR unbiased	0.664	0.452	-0.212
3	20	HDR unbiased	1.182	1.094	-0.088
4	20	HDR unbiased	0.004	-0.433	-0.437
5	20	HDR unbiased	0.259	0.587	0.328
6	20	HDR biased	0.213	1.677	1.464
7	20	HDR biased	0.44	1.138	0.698
8	20	HDR biased	-0.327	2.486	2.813
9	20	HDR biased	0.724	1.16	0.436
10	20	HDR biased	0.604	1.553	0.949
11	30	HDR unbiased	0.15	-0.156	-0.306
12	30	HDR unbiased	0.006	-0.148	-0.154
13	30	HDR unbiased	-0.125	-0.283	-0.158
14	30	HDR unbiased	1.399	0.237	-1.162
15	30	HDR unbiased	0.406	0.194	-0.212
16	30	HDR biased	0.385	5.45	5.065
17	30	HDR biased	0.967	6.34	5.373
18	30	HDR biased	-0.016	5.581	5.597
19	30	HDR biased	0.006	10.821	10.815
20	30	HDR biased	1.727	5.934	4.207
21	0	correlation	0.43	-0.213	-0.643
22	0	correlation	0.032	0.272	0.24
23	0	correlation	0.343	1.375	1.032
24	0	correlation	-0.058	0.515	0.573
25	0	correlation	0.722	1.229	0.507

TID vs Post - Pre Exposure Delta

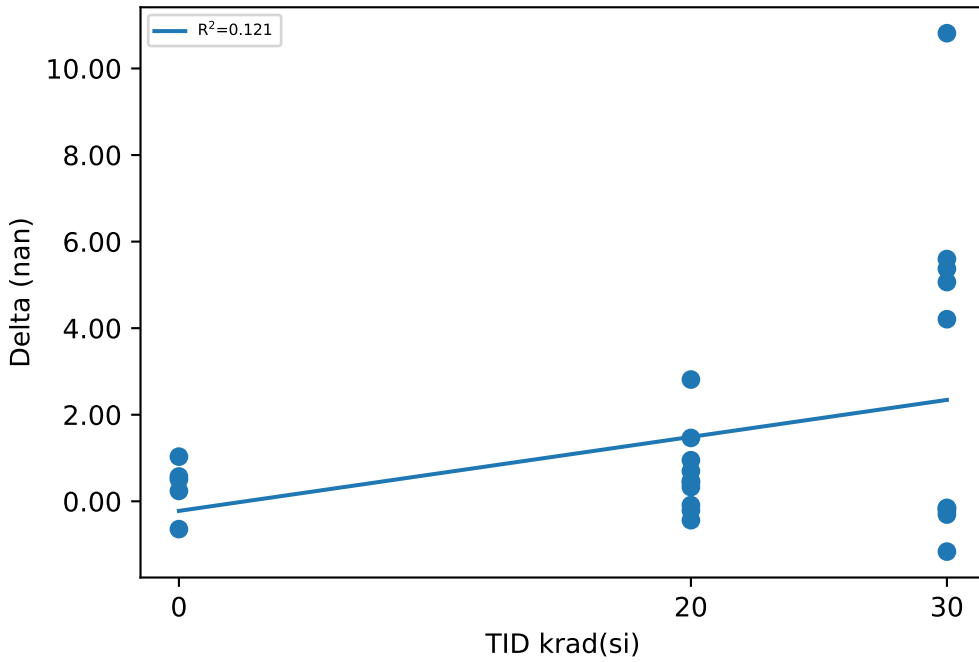

Test Statistics (nan)

krad(si)	Pre Exposure Min	Pre Exposure Avg	Pre Exposure Max	Pre Exposure Std	Post Exposure Min	Post Exposure Avg	Post Exposure Max	Post Exposure Std	Min Delta	Avg Delta	Max Delta	Std Delta
0	-0.058	0.2938	0.722	0.31489	-0.213	0.6356	1.375	0.6644	-0.643	0.3418	1.032	0.61994
20	-0.327	0.4609	1.182	0.43861	-0.433	1.1033	2.486	0.78494	-0.437	0.6424	2.813	0.94765
30	-0.125	0.4905	1.727	0.65153	-0.283	3.397	10.821	3.9183	-1.162	2.9065	10.815	3.9097

Device Test: 10.15 UJF0T(dCSR_50mA_CH3_UJF0T)

TID vs Result Stats

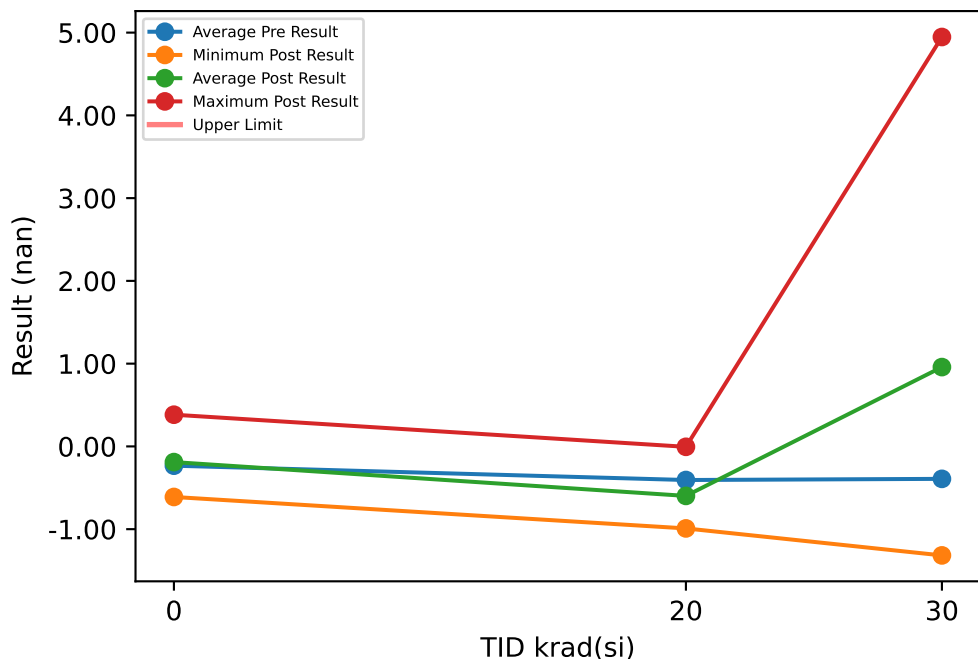

Test Results (No Limits Specified (nan))

Serial #	krad(si)	Exposure Conditions	Pre Result	Post Result	Delta
1	20	HDR unbiased	-0.573	-0.991	-0.418
2	20	HDR unbiased	-0.316	-0.549	-0.233
3	20	HDR unbiased	0.334	-0.039	-0.373
4	20	HDR unbiased	-0.554	-0.865	-0.311
5	20	HDR unbiased	-0.335	-0.918	-0.583
6	20	HDR biased	-0.445	-0.005	0.44
7	20	HDR biased	-0.802	-0.497	0.305
8	20	HDR biased	-0.804	-0.549	0.255
9	20	HDR biased	-0.442	-0.768	-0.326
10	20	HDR biased	-0.124	-0.8	-0.676
11	30	HDR unbiased	-0.642	-0.544	0.098
12	30	HDR unbiased	-0.824	-1.317	-0.493
13	30	HDR unbiased	-0.585	-1.054	-0.469
14	30	HDR unbiased	0.135	-1.128	-1.263
15	30	HDR unbiased	0.212	-0.713	-0.925
16	30	HDR biased	-0.727	1.991	2.718
17	30	HDR biased	-0.639	2.644	3.283
18	30	HDR biased	-0.492	1.858	2.35
19	30	HDR biased	-0.605	4.947	5.552
20	30	HDR biased	0.245	2.9	2.655
21	0	correlation	-0.388	-0.348	0.04
22	0	correlation	-0.627	-0.611	0.016
23	0	correlation	-0.185	0.012	0.197
24	0	correlation	-0.344	-0.384	-0.04
25	0	correlation	0.379	0.383	0.004

TID vs Post - Pre Exposure Delta

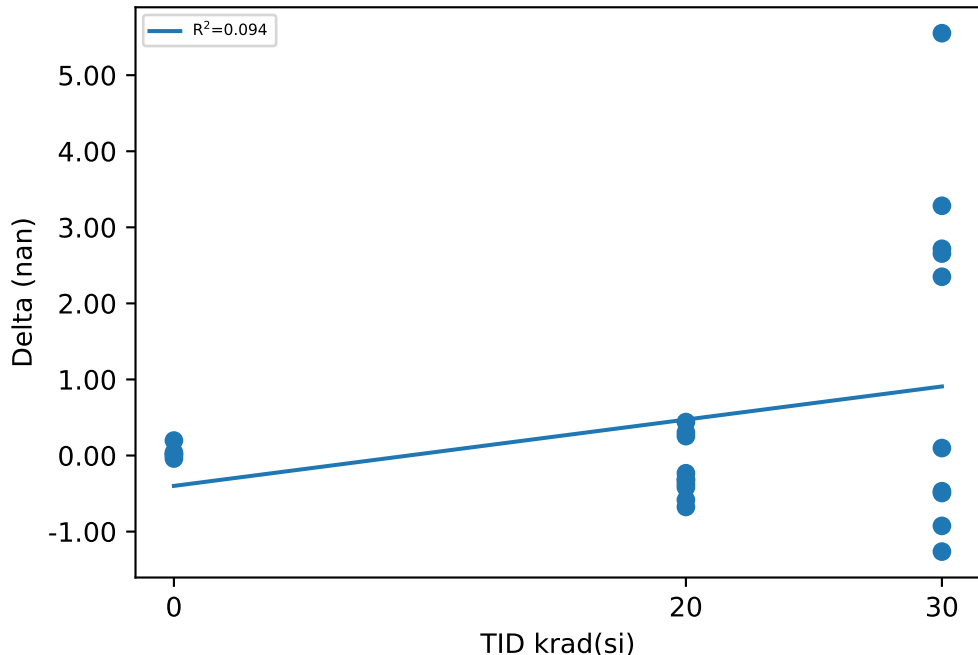

Test Statistics (nan)

krad(si)	Pre Exposure Min	Pre Exposure Avg	Pre Exposure Max	Pre Exposure Std	Post Exposure Min	Post Exposure Avg	Post Exposure Max	Post Exposure Std	Min Delta	Avg Delta	Max Delta	Std Delta
0	-0.627	-0.233	0.379	0.37697	-0.611	-0.1896	0.383	0.39018	-0.04	0.0434	0.197	0.090641
20	-0.804	-0.4061	0.334	0.33468	-0.991	-0.5981	-0.005	0.34592	-0.676	-0.192	0.44	0.38744
30	-0.824	-0.3922	0.245	0.41677	-1.317	0.9584	4.947	2.1865	-1.263	1.3506	5.552	2.2668

Device Test: 10.16 UJ74P3(dCSR_100mA_CH3_UJ74P3)

TID vs Result Stats

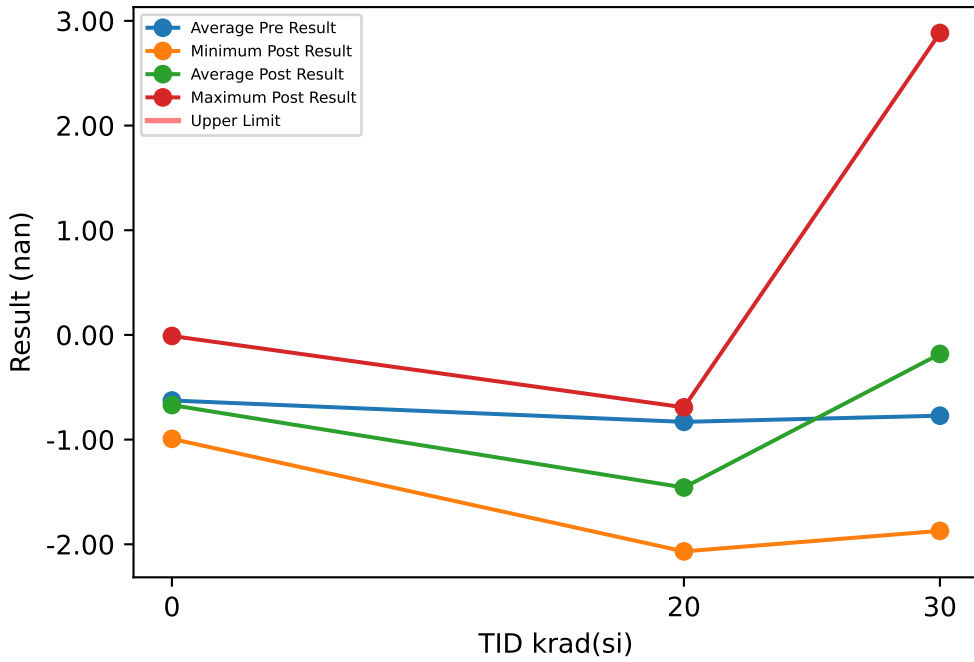

Test Results (No Limits Specified (nan))

Serial #	krad(si)	Exposure Conditions	Pre Result	Post Result	Delta
1	20	HDR unbiased	-0.851	-1.381	-0.53
2	20	HDR unbiased	-0.958	-1.262	-0.304
3	20	HDR unbiased	-0.279	-0.692	-0.413
4	20	HDR unbiased	-0.904	-1.302	-0.398
5	20	HDR unbiased	-0.88	-1.025	-0.145
6	20	HDR biased	-0.798	-1.225	-0.427
7	20	HDR biased	-1.039	-1.748	-0.709
8	20	HDR biased	-1.149	-2.068	-0.919
9	20	HDR biased	-0.954	-1.888	-0.934
10	20	HDR biased	-0.495	-1.986	-1.491
11	30	HDR unbiased	-0.759	-1.185	-0.426
12	30	HDR unbiased	-1.137	-1.688	-0.551
13	30	HDR unbiased	-1.079	-1.872	-0.793
14	30	HDR unbiased	-0.374	-1.322	-0.948
15	30	HDR unbiased	-0.25	-1.125	-0.875
16	30	HDR biased	-1.097	-0.175	0.922
17	30	HDR biased	-0.95	0.77	1.72
18	30	HDR biased	-0.843	0.433	1.276
19	30	HDR biased	-0.97	2.884	3.854
20	30	HDR biased	-0.259	1.462	1.721
21	0	correlation	-0.888	-0.909	-0.021
22	0	correlation	-0.985	-0.993	-0.008
23	0	correlation	-0.511	-0.631	-0.12
24	0	correlation	-0.618	-0.808	-0.19
25	0	correlation	-0.13	-0.01	0.12

TID vs Post - Pre Exposure Delta

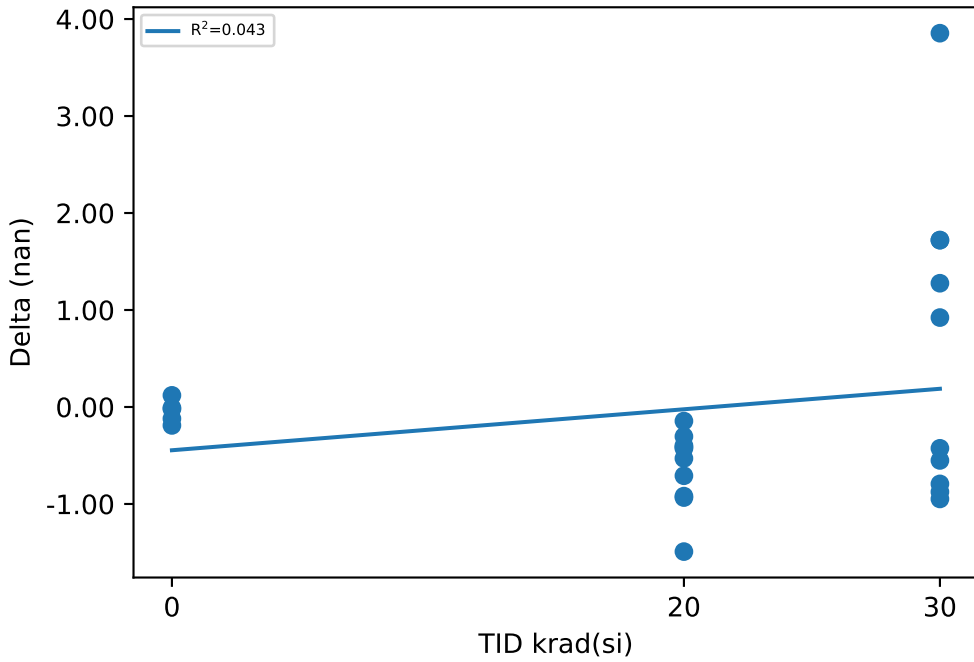

Test Statistics (nan)

krad(si)	Pre Exposure Min	Pre Exposure Avg	Pre Exposure Max	Pre Exposure Std	Post Exposure Min	Post Exposure Avg	Post Exposure Max	Post Exposure Std	Min Delta	Avg Delta	Max Delta	Std Delta
0	-0.985	-0.6264	-0.13	0.33795	-0.993	-0.6702	-0.01	0.39294	-0.19	-0.0438	0.12	0.11812
20	-1.149	-0.8307	-0.279	0.25873	-2.068	-1.4577	-0.692	0.44933	-1.491	-0.627	-0.145	0.3968
30	-1.137	-0.7718	-0.25	0.35012	-1.872	-0.1818	2.884	1.553	-0.948	0.59	3.854	1.5829

Device Test: 10.18 UJA0RR(dCSR_500mA_CH3_UJA0RR)

TID vs Result Stats

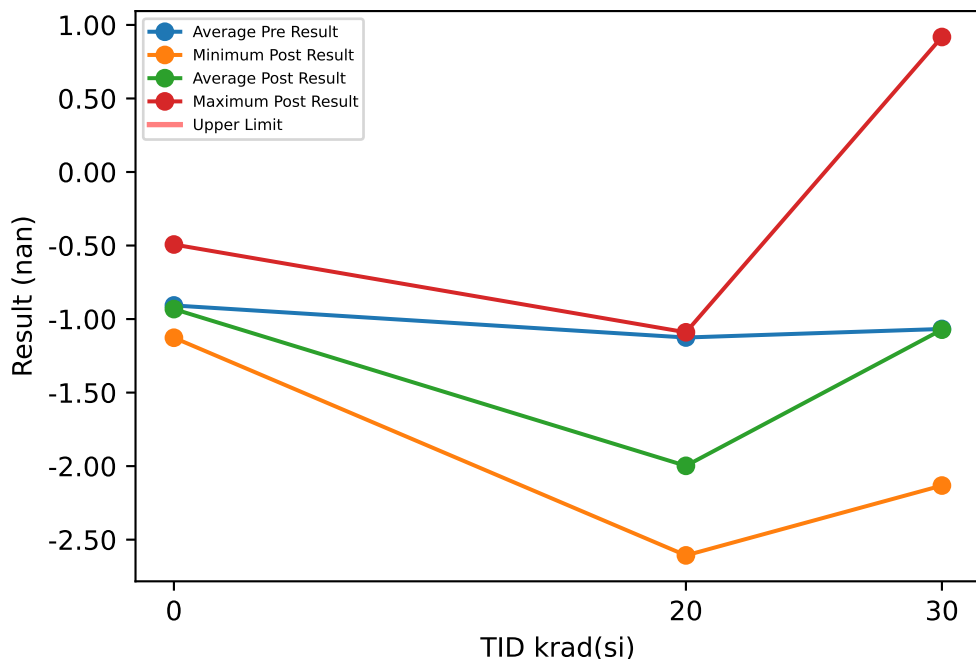

Test Results (No Limits Specified (nan))

Serial #	krad(si)	Exposure Conditions	Pre Result	Post Result	Delta
1	20	HDR unbiased	-1.33	-1.823	-0.493
2	20	HDR unbiased	-1.214	-1.747	-0.533
3	20	HDR unbiased	-0.479	-1.09	-0.611
4	20	HDR unbiased	-1.01	-1.602	-0.592
5	20	HDR unbiased	-1.18	-1.639	-0.459
6	20	HDR biased	-1.053	-2.137	-1.084
7	20	HDR biased	-1.381	-2.474	-1.093
8	20	HDR biased	-1.368	-2.592	-1.224
9	20	HDR biased	-1.323	-2.269	-0.946
10	20	HDR biased	-0.917	-2.607	-1.69
11	30	HDR unbiased	-1.207	-1.641	-0.434
12	30	HDR unbiased	-1.322	-2.132	-0.81
13	30	HDR unbiased	-1.385	-2.067	-0.682
14	30	HDR unbiased	-0.603	-1.611	-1.008
15	30	HDR unbiased	-0.595	-1.371	-0.776
16	30	HDR biased	-1.31	-1.062	0.248
17	30	HDR biased	-1.418	-0.83	0.588
18	30	HDR biased	-1.171	-0.871	0.3
19	30	HDR biased	-1.164	0.918	2.082
20	30	HDR biased	-0.498	-0.054	0.444
21	0	correlation	-1.175	-1.127	0.048
22	0	correlation	-1.13	-1.101	0.029
23	0	correlation	-0.846	-0.901	-0.055
24	0	correlation	-1.013	-1.039	-0.026
25	0	correlation	-0.373	-0.493	-0.12

TID vs Post - Pre Exposure Delta

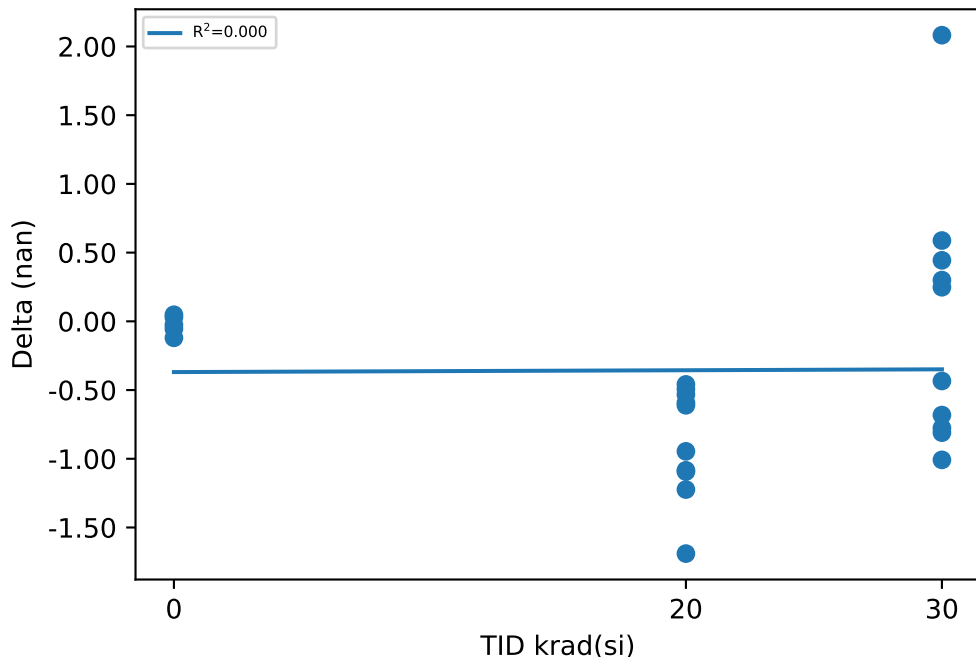

Test Statistics (nan)

krad(si)	Pre Exposure Min	Pre Exposure Avg	Pre Exposure Max	Pre Exposure Std	Post Exposure Min	Post Exposure Avg	Post Exposure Max	Post Exposure Std	Min Delta	Avg Delta	Max Delta	Std Delta
0	-1.175	-0.9074	-0.373	0.32468	-1.127	-0.9322	-0.493	0.26063	-0.12	-0.0248	0.048	0.0674
20	-1.381	-1.1255	-0.479	0.27804	-2.607	-1.998	-1.09	0.49965	-1.69	-0.8725	-0.459	0.40386
30	-1.418	-1.0673	-0.498	0.35747	-2.132	-1.0721	0.918	0.93766	-1.008	-0.0048	2.082	0.94025

Device Test: 10.19 UJR405(dCSR_5mA_CH4_UJR405)

TID vs Result Stats

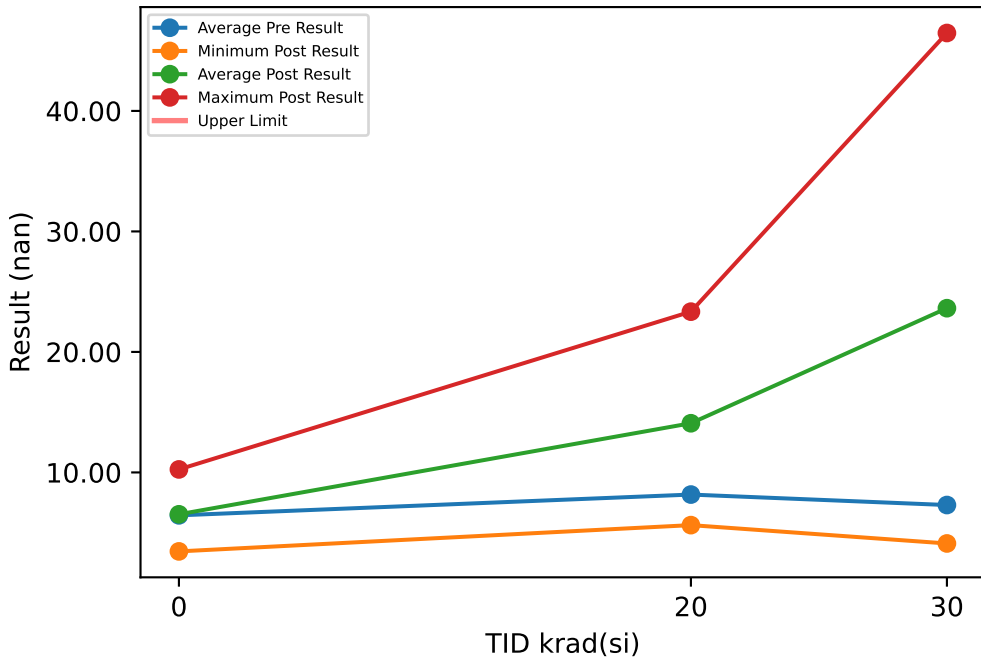

Test Results (No Limits Specified (nan))

Serial #	krad(si)	Exposure Conditions	Pre Result	Post Result	Delta
1	20	HDR unbiased	6.762	9.463	2.701
2	20	HDR unbiased	7.032	8.666	1.634
3	20	HDR unbiased	10.217	6.783	-3.434
4	20	HDR unbiased	9.429	5.627	-3.802
5	20	HDR unbiased	9.377	9.283	-0.094
6	20	HDR biased	6.08	19.339	13.259
7	20	HDR biased	9.202	21.683	12.481
8	20	HDR biased	9.222	23.342	14.12
9	20	HDR biased	8.24	17.945	9.705
10	20	HDR biased	6.075	18.681	12.606
11	30	HDR unbiased	6.433	8.856	2.423
12	30	HDR unbiased	8.537	7.998	-0.539
13	30	HDR unbiased	10.706	10.211	-0.495
14	30	HDR unbiased	7.726	10.977	3.251
15	30	HDR unbiased	4.789	4.106	-0.683
16	30	HDR biased	6.526	35.459	28.933
17	30	HDR biased	7.99	36.598	28.608
18	30	HDR biased	8.3	30.587	22.287
19	30	HDR biased	6.751	46.467	39.716
20	30	HDR biased	5.194	45.035	39.841
21	0	correlation	7.48	4.285	-3.195
22	0	correlation	3.729	3.447	-0.282
23	0	correlation	9.677	10.25	0.573
24	0	correlation	3.44	7.754	4.314
25	0	correlation	7.869	6.891	-0.978

TID vs Post - Pre Exposure Delta

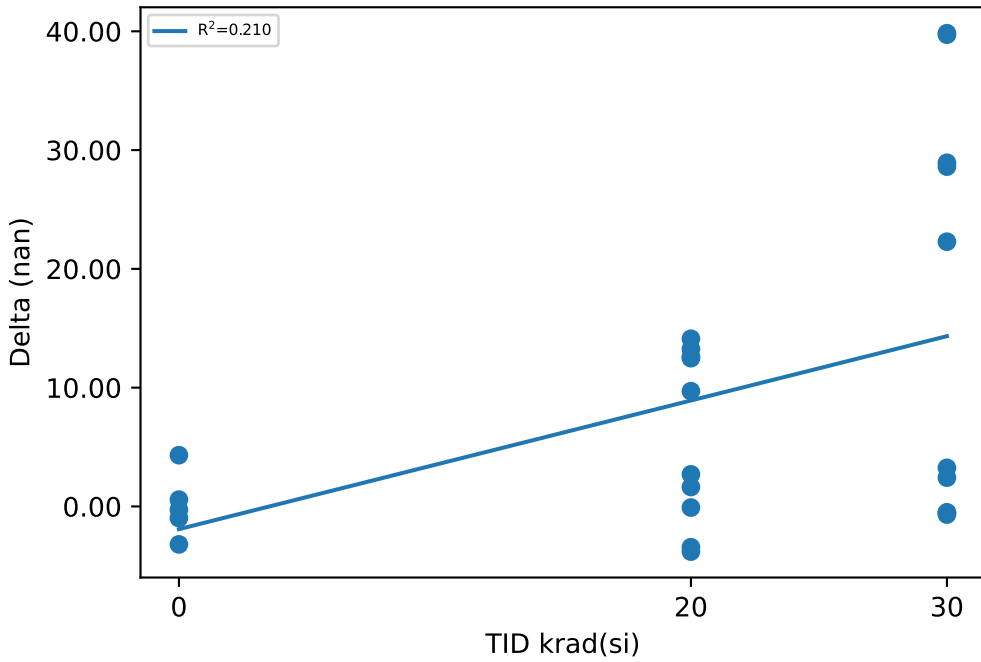

Test Statistics (nan)

krad(si)	Pre Exposure Min	Pre Exposure Avg	Pre Exposure Max	Pre Exposure Std	Post Exposure Min	Post Exposure Avg	Post Exposure Max	Post Exposure Std	Min Delta	Avg Delta	Max Delta	Std Delta
0	3.44	6.439	9.677	2.7364	3.447	6.5254	10.25	2.7391	-3.195	0.0864	4.314	2.7453
20	6.075	8.1636	10.217	1.5436	5.627	14.081	23.342	6.7139	-3.802	5.9176	14.12	7.2272
30	4.789	7.2952	10.706	1.7378	4.106	23.629	46.467	16.734	-0.683	16.334	39.841	17.212

Device Test: 10.2 UJFZSP(dCSR_25mA_CH1_UJFZSP)

TID vs Result Stats

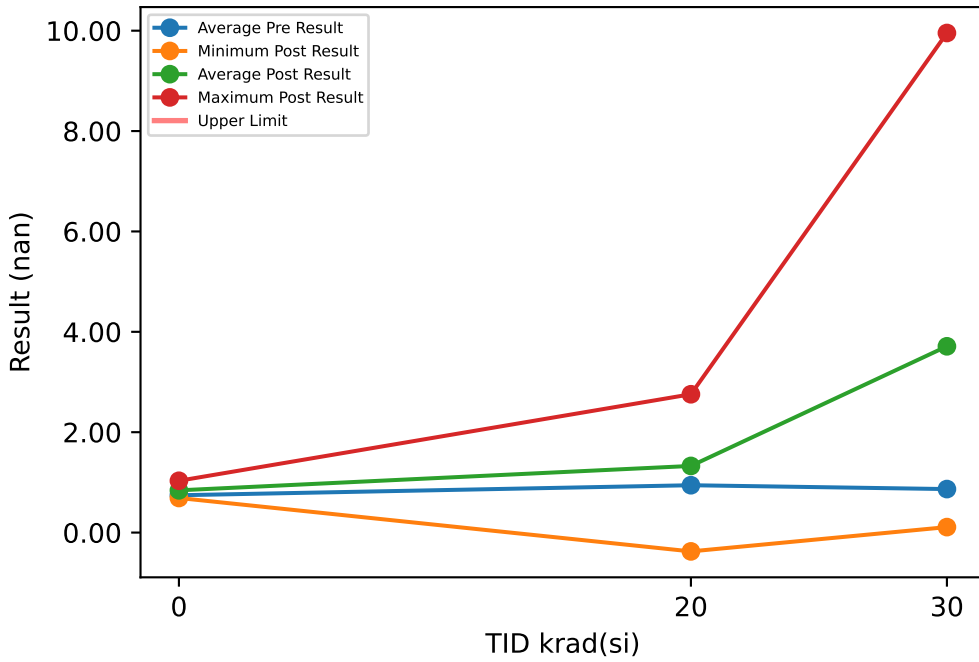

Test Results (No Limits Specified (nan))

Serial #	krad(si)	Exposure Conditions	Pre Result	Post Result	Delta
1	20	HDR unbiased	1.414	0.955	-0.459
2	20	HDR unbiased	0.935	0.555	-0.38
3	20	HDR unbiased	0.695	-0.375	-1.07
4	20	HDR unbiased	1.026	0.506	-0.52
5	20	HDR unbiased	0.735	1.157	0.422
6	20	HDR biased	0.827	1.922	1.095
7	20	HDR biased	1.007	1.92	0.913
8	20	HDR biased	0.591	2.756	2.165
9	20	HDR biased	1.11	1.562	0.452
10	20	HDR biased	1.094	2.319	1.225
11	30	HDR unbiased	1.171	1.332	0.161
12	30	HDR unbiased	0.643	0.109	-0.534
13	30	HDR unbiased	0.722	0.545	-0.177
14	30	HDR unbiased	1.064	0.588	-0.476
15	30	HDR unbiased	0.008	0.332	0.324
16	30	HDR biased	0.596	6.678	6.082
17	30	HDR biased	1.62	7.353	5.733
18	30	HDR biased	0.415	4.421	4.006
19	30	HDR biased	1.204	9.954	8.75
20	30	HDR biased	1.226	5.803	4.577
21	0	correlation	0.789	0.814	0.025
22	0	correlation	0.609	0.689	0.08
23	0	correlation	1.34	1.032	-0.308
24	0	correlation	0.804	0.693	-0.111
25	0	correlation	0.176	0.98	0.804

TID vs Post - Pre Exposure Delta

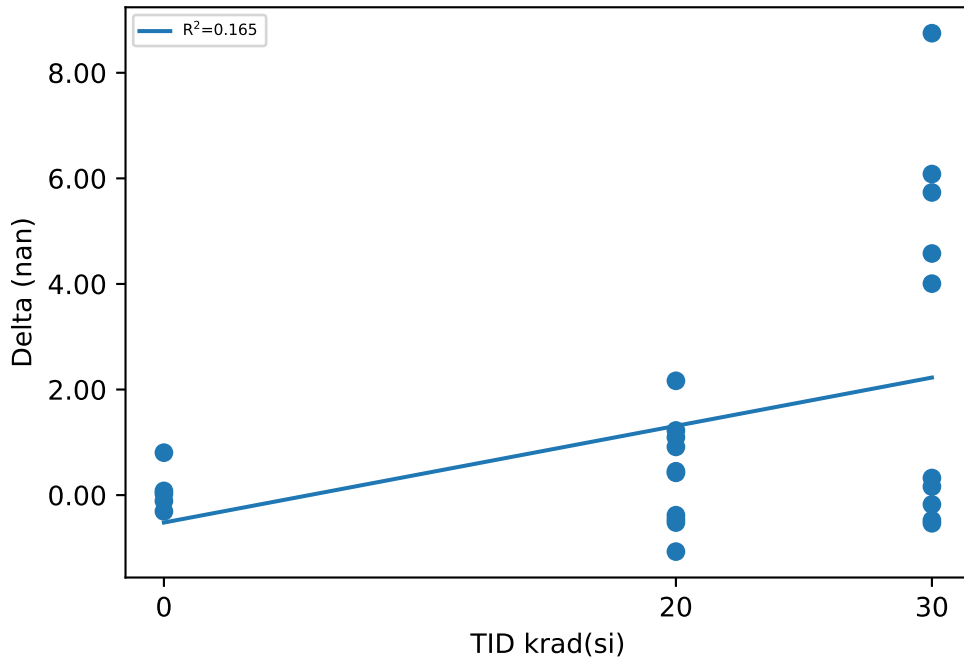

Test Statistics (nan)

krad(si)	Pre Exposure Min	Pre Exposure Avg	Pre Exposure Max	Pre Exposure Std	Post Exposure Min	Post Exposure Avg	Post Exposure Max	Post Exposure Std	Min Delta	Avg Delta	Max Delta	Std Delta
0	0.176	0.7436	1.34	0.41883	0.689	0.8416	1.032	0.15932	-0.308	0.098	0.804	0.42208
20	0.591	0.9434	1.414	0.24169	-0.375	1.3277	2.756	0.94992	-1.07	0.3843	2.165	0.99422
30	0.008	0.8669	1.62	0.47464	0.109	3.7115	9.954	3.5863	-0.534	2.8446	8.75	3.3858

Device Test: 10.20 UJFZSP(dCSR_25mA_CH4_UJFZSP)

TID vs Result Stats

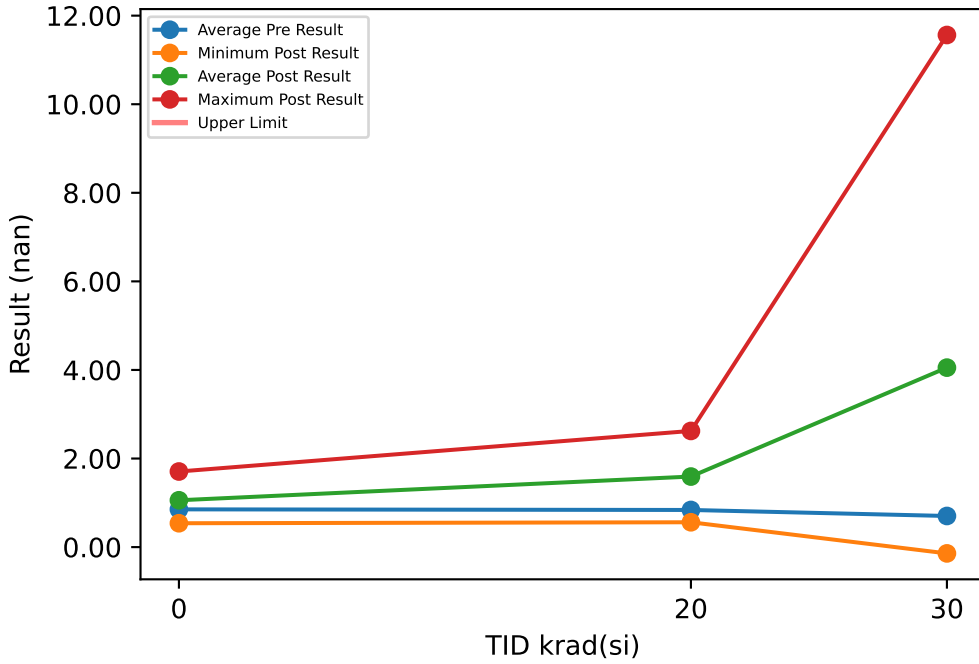

Test Results (No Limits Specified (nan))

Serial #	krad(si)	Exposure Conditions	Pre Result	Post Result	Delta
1	20	HDR unbiased	0.903	0.9	-0.003
2	20	HDR unbiased	1.011	0.666	-0.345
3	20	HDR unbiased	0.69	0.561	-0.129
4	20	HDR unbiased	0.789	0.765	-0.024
5	20	HDR unbiased	0.794	1.085	0.291
6	20	HDR biased	1.369	2.623	1.254
7	20	HDR biased	0.702	2.587	1.885
8	20	HDR biased	0.039	2.312	2.273
9	20	HDR biased	0.69	2.057	1.367
10	20	HDR biased	1.399	2.374	0.975
11	30	HDR unbiased	0.37	0.913	0.543
12	30	HDR unbiased	0.615	1.524	0.909
13	30	HDR unbiased	0.148	-0.142	-0.29
14	30	HDR unbiased	1.773	1.272	-0.501
15	30	HDR unbiased	0.002	0.055	0.053
16	30	HDR biased	-0.152	7.305	7.457
17	30	HDR biased	0.78	7.064	6.284
18	30	HDR biased	0.786	4.637	3.851
19	30	HDR biased	1.513	11.563	10.05
20	30	HDR biased	1.194	6.334	5.14
21	0	correlation	0.843	0.539	-0.304
22	0	correlation	-0.187	0.612	0.799
23	0	correlation	1.009	1.35	0.341
24	0	correlation	1.198	1.079	-0.119
25	0	correlation	1.399	1.707	0.308

TID vs Post - Pre Exposure Delta

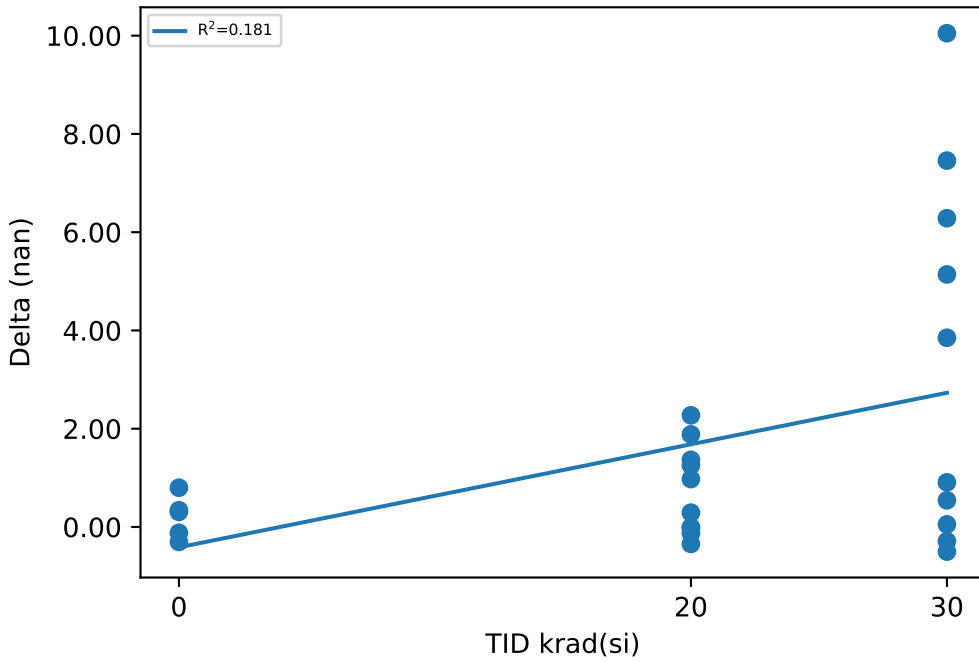

Test Statistics (nan)

krad(si)	Pre Exposure Min	Pre Exposure Avg	Pre Exposure Max	Pre Exposure Std	Post Exposure Min	Post Exposure Avg	Post Exposure Max	Post Exposure Std	Min Delta	Avg Delta	Max Delta	Std Delta
0	-0.187	0.8524	1.399	0.61708	0.539	1.0574	1.707	0.49376	-0.304	0.205	0.799	0.43186
20	0.039	0.8386	1.399	0.38527	0.561	1.593	2.623	0.86535	-0.345	0.7544	2.273	0.92143
30	-0.152	0.7029	1.773	0.64152	-0.142	4.0525	11.563	3.9322	-0.501	3.3496	10.05	3.7507

Device Test: 10.22 UJ74P3(dCSR_100mA_CH4_UJ74P3)

TID vs Result Stats

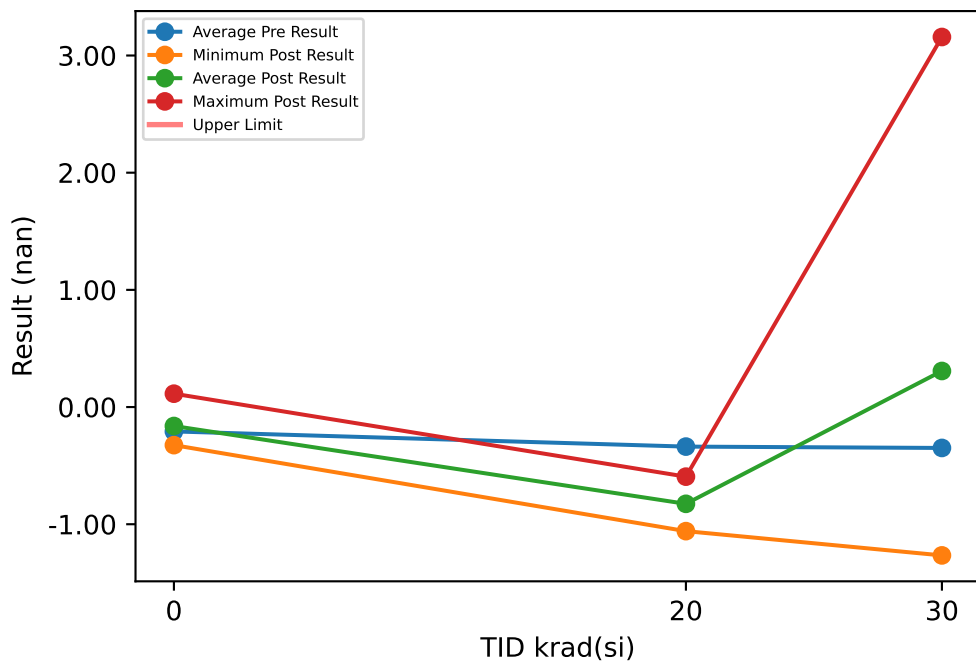

Test Results (No Limits Specified (nan))

Serial #	krad(si)	Exposure Conditions	Pre Result	Post Result	Delta
1	20	HDR unbiased	-0.147	-0.616	-0.469
2	20	HDR unbiased	-0.273	-0.903	-0.63
3	20	HDR unbiased	-0.476	-1.059	-0.583
4	20	HDR unbiased	-0.358	-0.709	-0.351
5	20	HDR unbiased	-0.077	-0.594	-0.517
6	20	HDR biased	-0.041	-0.639	-0.598
7	20	HDR biased	-0.509	-1.025	-0.516
8	20	HDR biased	-0.597	-0.825	-0.228
9	20	HDR biased	-0.711	-1.029	-0.318
10	20	HDR biased	-0.186	-0.86	-0.674
11	30	HDR unbiased	-0.307	-0.602	-0.295
12	30	HDR unbiased	-0.283	-1.266	-0.983
13	30	HDR unbiased	-0.711	-0.984	-0.273
14	30	HDR unbiased	-0.041	-0.287	-0.246
15	30	HDR unbiased	-0.728	-1.234	-0.506
16	30	HDR biased	-0.546	1.117	1.663
17	30	HDR biased	-0.263	1.339	1.602
18	30	HDR biased	-0.536	0.603	1.139
19	30	HDR biased	0.156	3.158	3.002
20	30	HDR biased	-0.231	1.234	1.465
21	0	correlation	-0.301	-0.163	0.138
22	0	correlation	-0.373	-0.325	0.048
23	0	correlation	-0.316	-0.222	0.094
24	0	correlation	-0.152	-0.213	-0.061
25	0	correlation	0.102	0.114	0.012

TID vs Post - Pre Exposure Delta

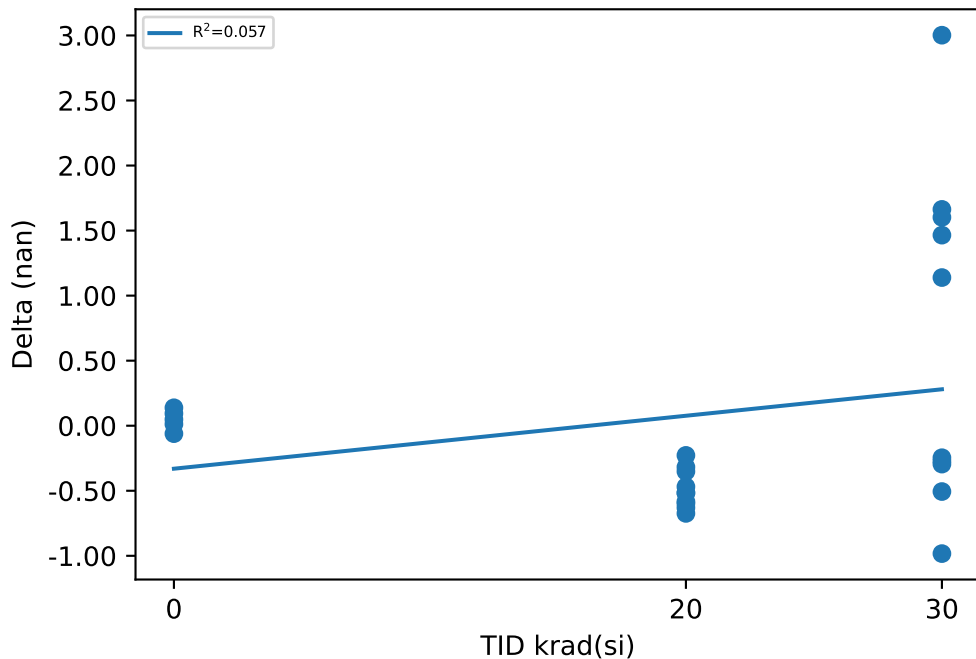

Test Statistics (nan)

krad(si)	Pre Exposure Min	Pre Exposure Avg	Pre Exposure Max	Pre Exposure Std	Post Exposure Min	Post Exposure Avg	Post Exposure Max	Post Exposure Std	Min Delta	Avg Delta	Max Delta	Std Delta
0	-0.373	-0.208	0.102	0.19156	-0.325	-0.1618	0.114	0.16504	-0.061	0.0462	0.138	0.076447
20	-0.711	-0.3375	-0.041	0.22974	-1.059	-0.8259	-0.594	0.17912	-0.674	-0.4884	-0.228	0.14649
30	-0.728	-0.349	0.156	0.28398	-1.266	0.3078	3.158	1.4334	-0.983	0.6568	3.002	1.2875

Device Test: 10.24 UJA0RR(dCSR_500mA_CH4_UJA0RR)

TID vs Result Stats

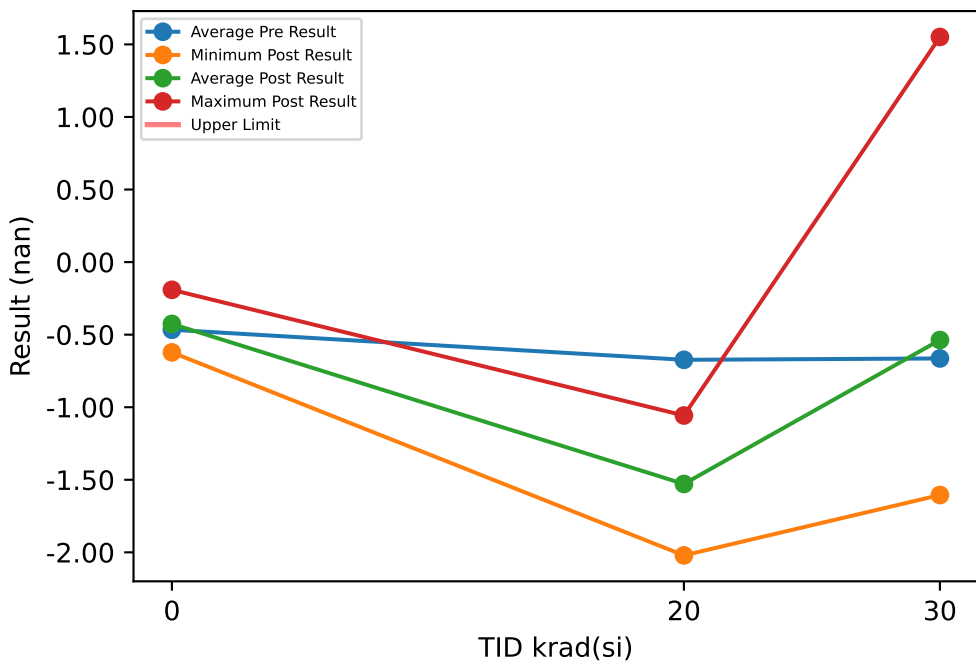

Test Results (No Limits Specified (nan))

Serial #	krad(si)	Exposure Conditions	Pre Result	Post Result	Delta
1	20	HDR unbiased	-0.687	-1.226	-0.539
2	20	HDR unbiased	-0.684	-1.279	-0.595
3	20	HDR unbiased	-0.805	-1.536	-0.731
4	20	HDR unbiased	-0.48	-1.057	-0.577
5	20	HDR unbiased	-0.536	-1.104	-0.568
6	20	HDR biased	-0.356	-1.657	-1.301
7	20	HDR biased	-0.903	-2.021	-1.118
8	20	HDR biased	-0.824	-1.823	-0.999
9	20	HDR biased	-0.943	-1.951	-1.008
10	20	HDR biased	-0.515	-1.634	-1.119
11	30	HDR unbiased	-0.604	-0.852	-0.248
12	30	HDR unbiased	-0.699	-1.605	-0.906
13	30	HDR unbiased	-0.847	-1.49	-0.643
14	30	HDR unbiased	-0.472	-0.622	-0.15
15	30	HDR unbiased	-1.073	-1.469	-0.396
16	30	HDR biased	-0.909	-0.263	0.646
17	30	HDR biased	-0.666	-0.279	0.387
18	30	HDR biased	-0.705	-0.098	0.607
19	30	HDR biased	-0.122	1.551	1.673
20	30	HDR biased	-0.543	-0.241	0.302
21	0	correlation	-0.517	-0.469	0.048
22	0	correlation	-0.604	-0.622	-0.018
23	0	correlation	-0.544	-0.565	-0.021
24	0	correlation	-0.419	-0.283	0.136
25	0	correlation	-0.247	-0.191	0.056

TID vs Post - Pre Exposure Delta

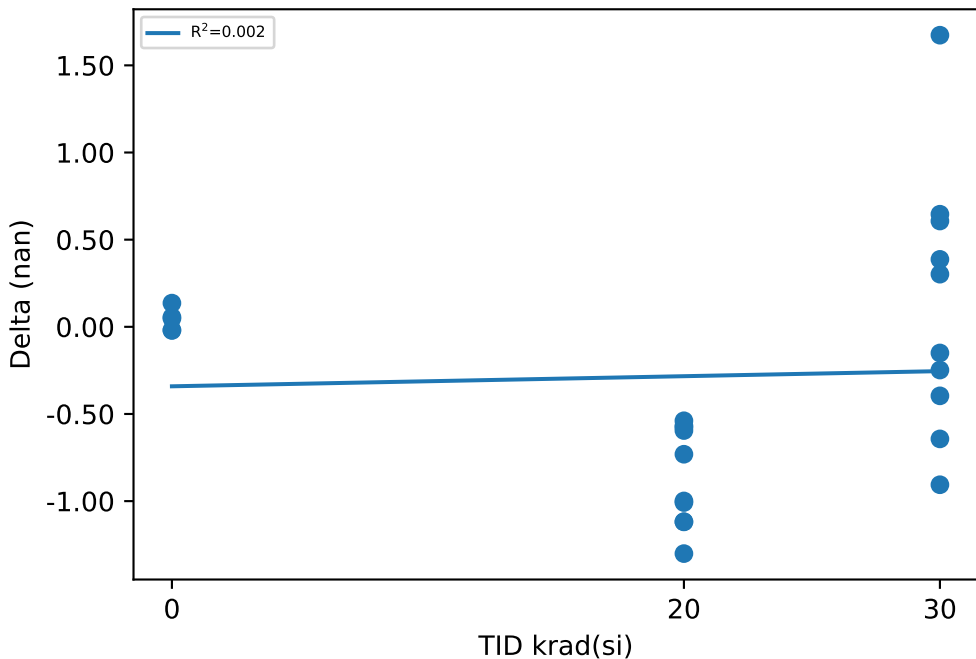

Test Statistics (nan)

krad(si)	Pre Exposure Min	Pre Exposure Avg	Pre Exposure Max	Pre Exposure Std	Post Exposure Min	Post Exposure Avg	Post Exposure Max	Post Exposure Std	Min Delta	Avg Delta	Max Delta	Std Delta
0	-0.604	-0.4662	-0.247	0.13955	-0.622	-0.426	-0.191	0.18389	-0.021	0.0402	0.136	0.064461
20	-0.943	-0.6733	-0.356	0.19659	-2.021	-1.5288	-1.057	0.34829	-1.301	-0.8555	-0.539	0.28371
30	-1.073	-0.664	-0.122	0.26089	-1.605	-0.5368	1.551	0.93129	-0.906	0.1272	1.673	0.75564

Device Test: 10.25 UJXOZU(Kcs_5mA_CH1_UJXOZU)

TID vs Result Stats

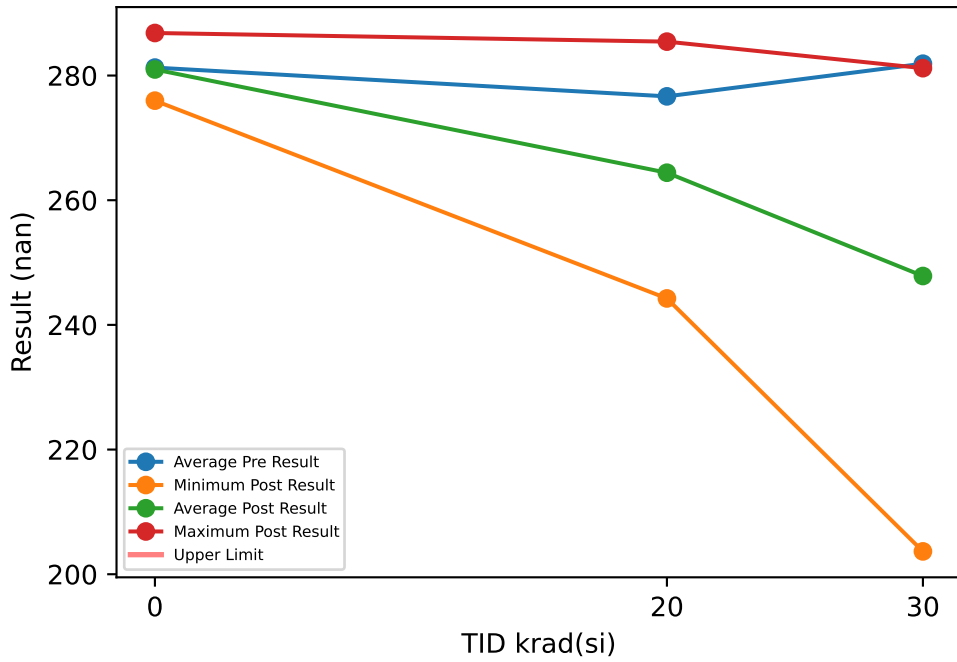

Test Results (No Limits Specified (nan))

Serial #	krad(si)	Exposure Conditions	Pre Result	Post Result	Delta
1	20	HDR unbiased	264.88	274.42	9.54
2	20	HDR unbiased	273.23	279.91	6.677
3	20	HDR unbiased	276.54	278.96	2.422
4	20	HDR unbiased	286.33	285.44	-0.89
5	20	HDR unbiased	272.63	272.46	-0.167
6	20	HDR biased	278.31	255.04	-23.268
7	20	HDR biased	281.87	244.24	-37.622
8	20	HDR biased	277.82	245.68	-32.143
9	20	HDR biased	277.29	257.02	-20.273
10	20	HDR biased	277.72	250.94	-26.772
11	30	HDR unbiased	280.57	275.79	-4.777
12	30	HDR unbiased	292.6	272.01	-20.583
13	30	HDR unbiased	283.39	281.18	-2.212
14	30	HDR unbiased	284.94	270.09	-14.852
15	30	HDR unbiased	277.87	279.89	2.023
16	30	HDR biased	282.31	221.23	-61.073
17	30	HDR biased	277.82	227.98	-49.84
18	30	HDR biased	279.32	225.04	-54.287
19	30	HDR biased	279.42	203.66	-75.752
20	30	HDR biased	280.74	221.53	-59.21
21	0	correlation	278.19	284.57	6.381
22	0	correlation	287.55	286.82	-0.723
23	0	correlation	275.56	275.97	0.417
24	0	correlation	281.96	278.12	-3.843
25	0	correlation	283.12	279.39	-3.734

TID vs Post - Pre Exposure Delta

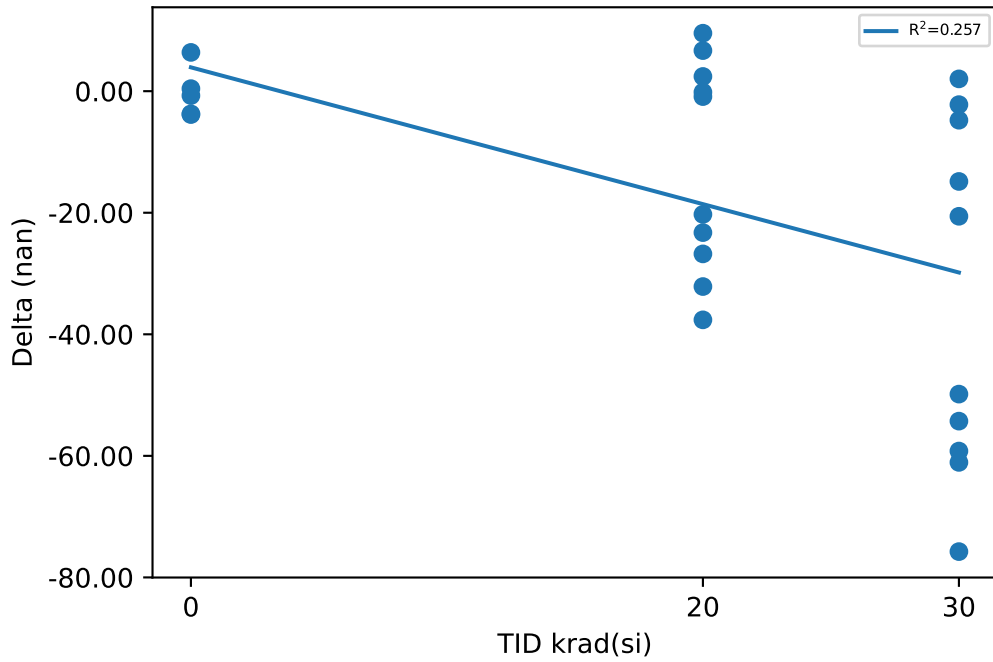

Test Statistics (nan)

krad(si)	Pre Exposure Min	Pre Exposure Avg	Pre Exposure Max	Pre Exposure Std	Post Exposure Min	Post Exposure Avg	Post Exposure Max	Post Exposure Std	Min Delta	Avg Delta	Max Delta	Std Delta
0	275.56	281.27	287.55	4.6227	275.97	280.97	286.82	4.5503	-3.843	-0.3004	6.381	4.1735
20	264.88	276.66	286.33	5.7063	244.24	264.41	285.44	15.421	-37.622	-12.25	9.54	17.51
30	277.82	281.9	292.6	4.4083	203.66	247.84	281.18	30.305	-75.752	-34.056	2.023	28.835

Device Test: 10.26 UJXOZU(Kcs_25mA_CH1_UJXOZU)

TID vs Result Stats

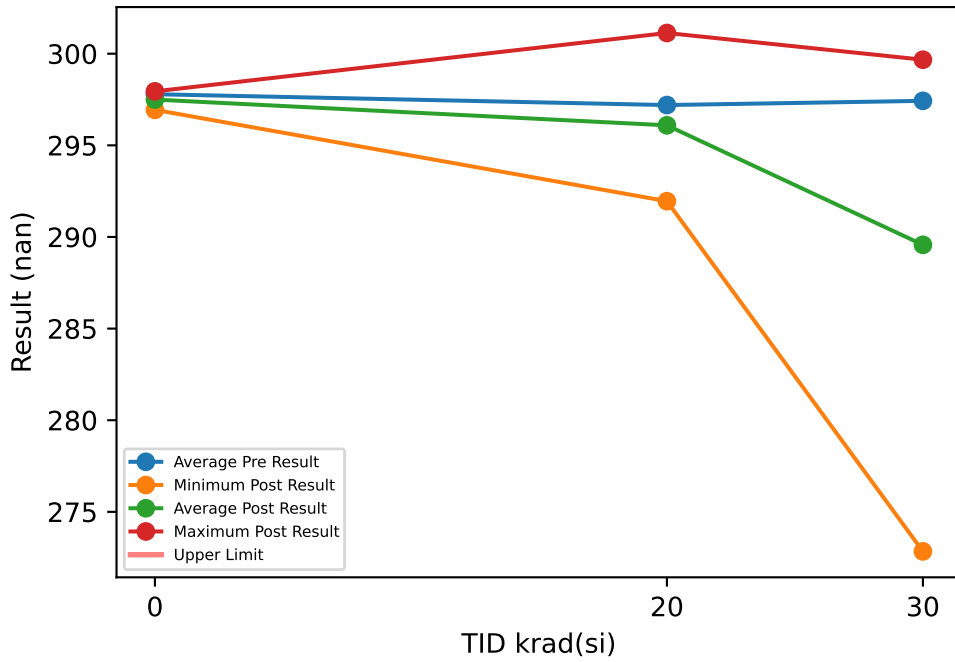

Test Results (No Limits Specified (nan))

Serial #	krad(si)	Exposure Conditions	Pre Result	Post Result	Delta
1	20	HDR unbiased	295.82	297.16	1.344
2	20	HDR unbiased	297.22	298.34	1.122
3	20	HDR unbiased	297.93	301.13	3.2
4	20	HDR unbiased	296.95	298.49	1.534
5	20	HDR unbiased	297.81	296.57	-1.243
6	20	HDR biased	297.54	294.34	-3.198
7	20	HDR biased	297.01	294.35	-2.658
8	20	HDR biased	298.24	291.95	-6.284
9	20	HDR biased	296.71	295.39	-1.321
10	20	HDR biased	296.75	293.2	-3.552
11	30	HDR unbiased	296.53	296.06	-0.47
12	30	HDR unbiased	298.08	299.67	1.588
13	30	HDR unbiased	297.85	298.38	0.525
14	30	HDR unbiased	296.84	298.25	1.406
15	30	HDR unbiased	299.98	299.01	-0.971
16	30	HDR biased	298.22	281.22	-17.003
17	30	HDR biased	295.22	279.45	-15.767
18	30	HDR biased	298.76	287.3	-11.463
19	30	HDR biased	296.43	272.84	-23.588
20	30	HDR biased	296.37	283.55	-12.82
21	0	correlation	297.65	297.58	-0.074
22	0	correlation	298.18	297.95	-0.238
23	0	correlation	296.03	296.94	0.905
24	0	correlation	297.61	297.94	0.327
25	0	correlation	299.47	297.09	-2.386

TID vs Post - Pre Exposure Delta

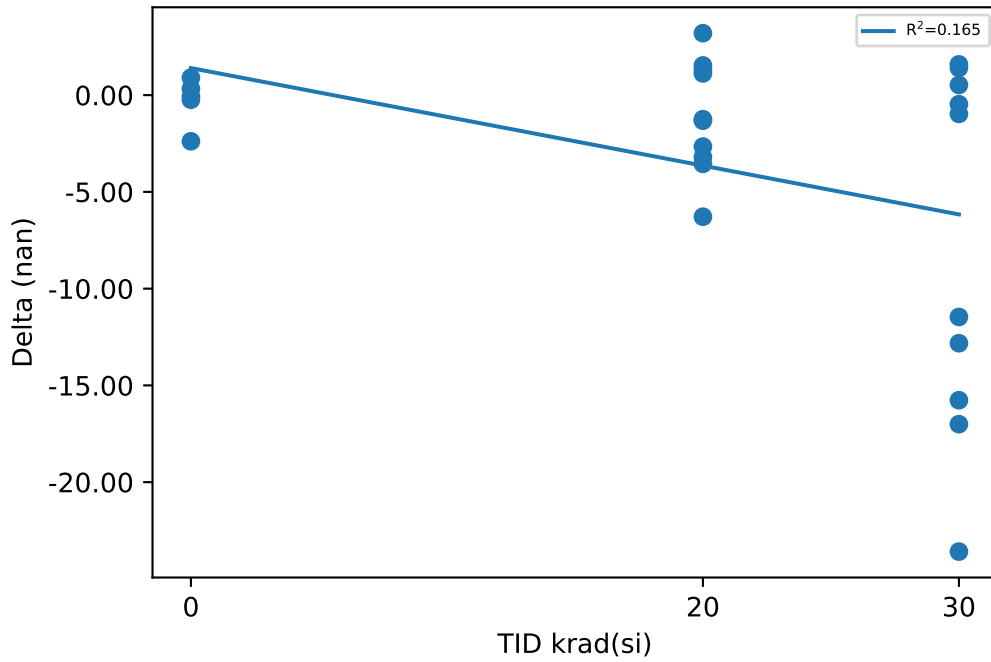

Test Statistics (nan)

krad(si)	Pre Exposure Min	Pre Exposure Avg	Pre Exposure Max	Pre Exposure Std	Post Exposure Min	Post Exposure Avg	Post Exposure Max	Post Exposure Std	Min Delta	Avg Delta	Max Delta	Std Delta
0	296.03	297.79	299.47	1.238	296.94	297.5	297.95	0.4695	-2.386	-0.2932	0.905	1.2501
20	295.82	297.2	298.24	0.71119	291.95	296.09	301.13	2.782	-6.284	-1.1056	3.2	2.9083
30	295.22	297.43	299.98	1.4015	272.84	289.57	299.67	9.885	-23.588	-7.8563	1.588	9.301

Device Test: 10.27 UJXOZU(Kcs_50mA_CH1_UJXOZU)

TID vs Result Stats

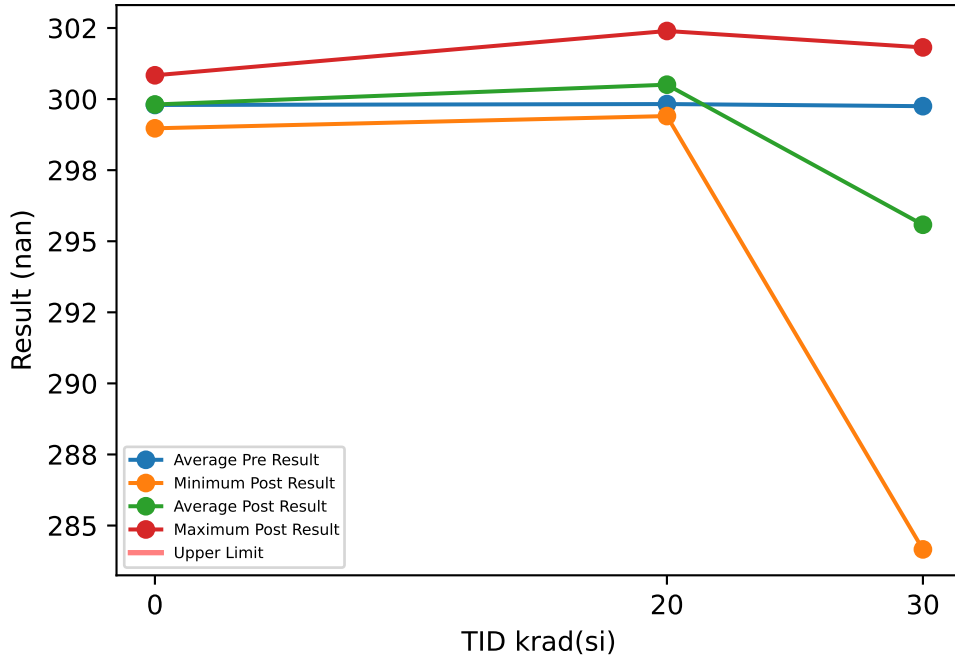

Test Results (No Limits Specified (nan))

Serial #	krad(si)	Exposure Conditions	Pre Result	Post Result	Delta
1	20	HDR unbiased	299.1	299.52	0.425
2	20	HDR unbiased	298.66	299.98	1.322
3	20	HDR unbiased	300.39	301.18	0.794
4	20	HDR unbiased	300.74	302.39	1.654
5	20	HDR unbiased	299.36	300.5	1.14
6	20	HDR biased	300.64	300.04	-0.599
7	20	HDR biased	299.49	300.71	1.221
8	20	HDR biased	300.1	299.4	-0.696
9	20	HDR biased	300.89	300.09	-0.802
10	20	HDR biased	298.89	301.24	2.352
11	30	HDR unbiased	298.99	299.1	0.117
12	30	HDR unbiased	300.88	301.82	0.938
13	30	HDR unbiased	299.25	301.25	2.003
14	30	HDR unbiased	300.48	299.98	-0.499
15	30	HDR unbiased	300.38	301.57	1.197
16	30	HDR biased	299.25	293.73	-5.521
17	30	HDR biased	299.12	290.12	-9
18	30	HDR biased	299.8	292.83	-6.968
19	30	HDR biased	299.66	284.16	-15.503
20	30	HDR biased	299.7	291.23	-8.471
21	0	correlation	299.76	300.45	0.695
22	0	correlation	300.87	300.84	-0.032
23	0	correlation	299.32	298.97	-0.349
24	0	correlation	299.74	299.41	-0.334
25	0	correlation	299.27	299.38	0.105

TID vs Post - Pre Exposure Delta

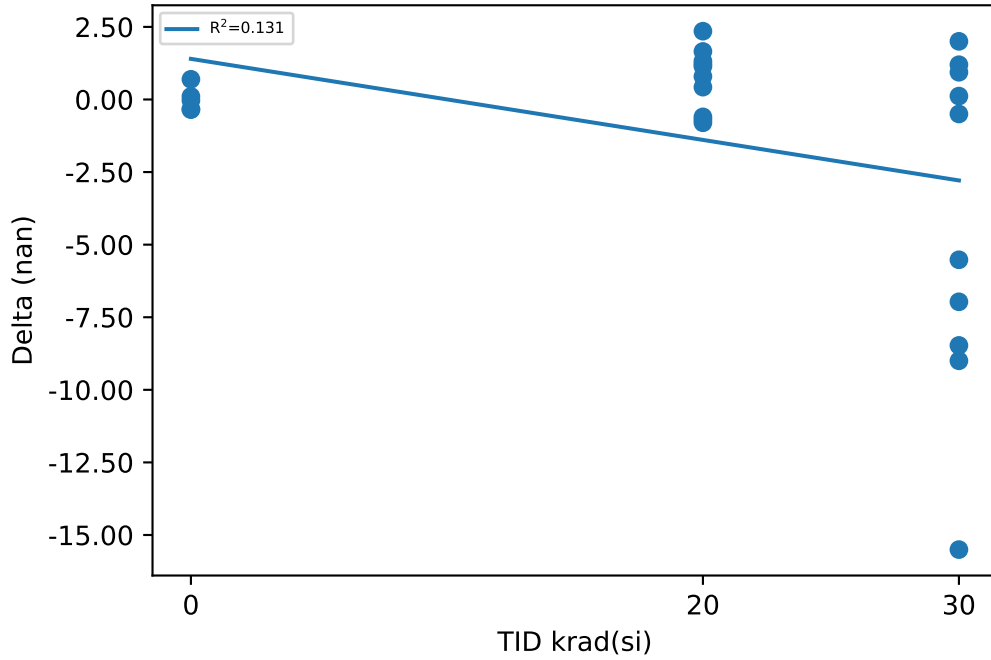

Test Statistics (nan)

krad(si)	Pre Exposure Min	Pre Exposure Avg	Pre Exposure Max	Pre Exposure Std	Post Exposure Min	Post Exposure Avg	Post Exposure Max	Post Exposure Std	Min Delta	Avg Delta	Max Delta	Std Delta
0	299.27	299.79	300.87	0.64337	298.97	299.81	300.84	0.79405	-0.349	0.017	0.695	0.42632
20	298.66	299.83	300.89	0.82518	299.4	300.51	302.39	0.90947	-0.802	0.6811	2.352	1.0783
30	298.99	299.75	300.88	0.6409	284.16	295.58	301.82	6.0456	-15.503	-4.1707	2.003	5.8193

Device Test: 10.28 UJXOZU(Kcs_100mA_CH1_UJXOZU)

TID vs Result Stats

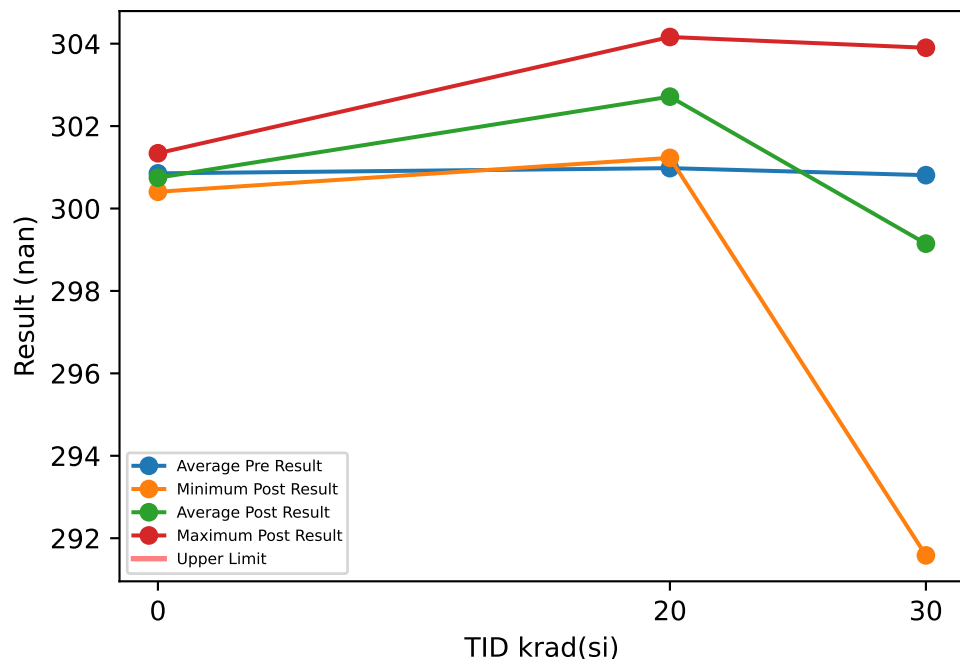

Test Results (No Limits Specified (nan))

Serial #	krad(si)	Exposure Conditions	Pre Result	Post Result	Delta
1	20	HDR unbiased	301.06	301.8	0.733
2	20	HDR unbiased	300.42	301.23	0.81
3	20	HDR unbiased	301.14	302.76	1.62
4	20	HDR unbiased	300.87	302.8	1.933
5	20	HDR unbiased	300.7	301.91	1.213
6	20	HDR biased	301.05	302.8	1.748
7	20	HDR biased	301.21	302.94	1.729
8	20	HDR biased	301.27	303.04	1.764
9	20	HDR biased	301.64	303.71	2.071
10	20	HDR biased	300.44	304.16	3.723
11	30	HDR unbiased	299.17	300.33	1.157
12	30	HDR unbiased	302.49	303.9	1.412
13	30	HDR unbiased	300.99	302.83	1.832
14	30	HDR unbiased	300.74	301.3	0.569
15	30	HDR unbiased	300.46	303.22	2.766
16	30	HDR biased	300.69	296.33	-4.353
17	30	HDR biased	301.3	297.39	-3.913
18	30	HDR biased	300.48	297.69	-2.792
19	30	HDR biased	300.55	291.58	-8.964
20	30	HDR biased	301.23	296.9	-4.333
21	0	correlation	301.58	301.34	-0.24
22	0	correlation	300.96	300.94	-0.025
23	0	correlation	300.22	300.41	0.185
24	0	correlation	300.83	300.61	-0.227
25	0	correlation	300.67	300.44	-0.224

TID vs Post - Pre Exposure Delta

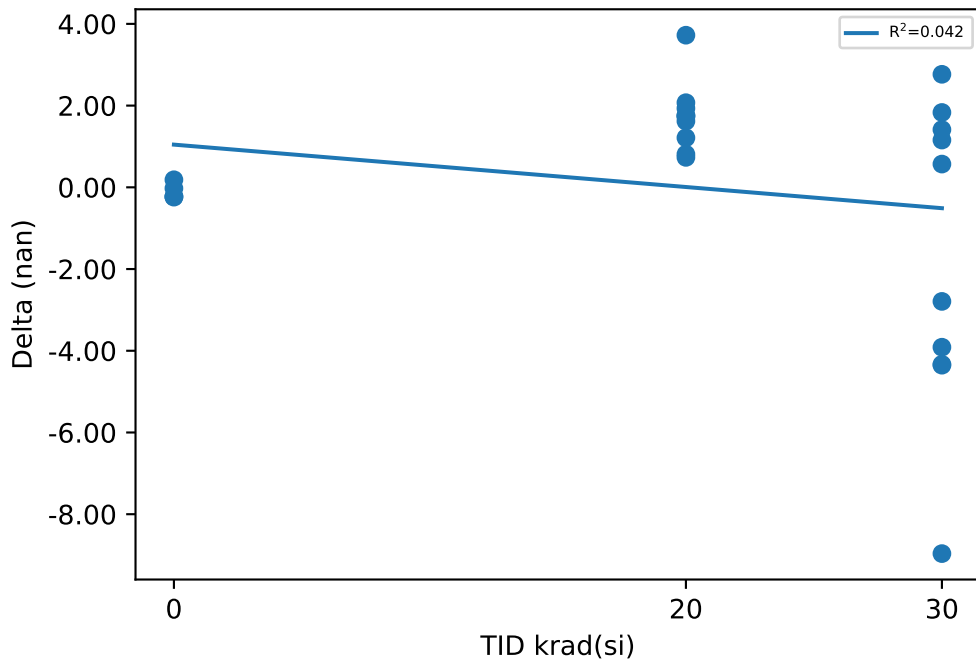

Test Statistics (nan)

krad(si)	Pre Exposure Min	Pre Exposure Avg	Pre Exposure Max	Pre Exposure Std	Post Exposure Min	Post Exposure Avg	Post Exposure Max	Post Exposure Std	Min Delta	Avg Delta	Max Delta	Std Delta
0	300.22	300.85	301.58	0.4943	300.41	300.75	301.34	0.39347	-0.24	-0.1062	0.185	0.18558
20	300.42	300.98	301.64	0.38166	301.23	302.71	304.16	0.87891	0.733	1.7344	3.723	0.83337
30	299.17	300.81	302.49	0.83476	291.58	299.15	303.9	3.862	-8.964	-1.6619	2.766	3.7746

Device Test: 10.29 UJXOZU(Kcs_250mA_CH1_UJXOZU)

TID vs Result Stats

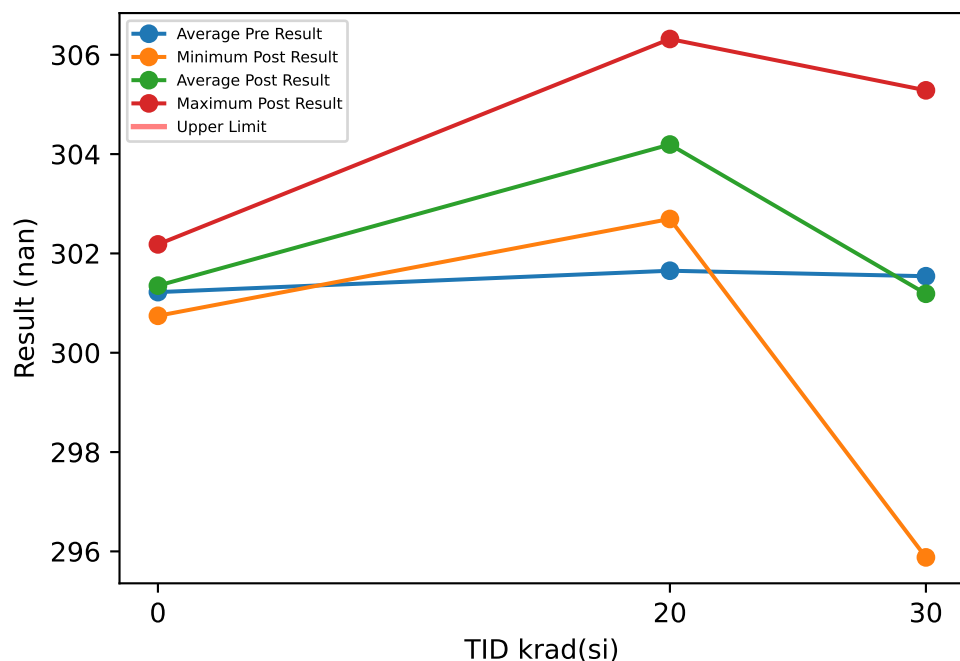

Test Results (No Limits Specified (nan))

Serial #	krad(si)	Exposure Conditions	Pre Result	Post Result	Delta
1	20	HDR unbiased	301.6	303.08	1.483
2	20	HDR unbiased	300.8	302.98	2.179
3	20	HDR unbiased	301.39	303.78	2.386
4	20	HDR unbiased	301.44	303.67	2.237
5	20	HDR unbiased	301.43	302.69	1.262
6	20	HDR biased	301.79	304.9	3.107
7	20	HDR biased	302.06	304.61	2.544
8	20	HDR biased	302.21	304.7	2.483
9	20	HDR biased	302.4	305.21	2.81
10	20	HDR biased	301.39	306.32	4.926
11	30	HDR unbiased	300.39	300.56	0.169
12	30	HDR unbiased	302.46	305.28	2.823
13	30	HDR unbiased	301.33	303.58	2.25
14	30	HDR unbiased	302.08	302.28	0.195
15	30	HDR unbiased	301.42	304.24	2.824
16	30	HDR biased	301.75	299.71	-2.036
17	30	HDR biased	301.56	300.89	-0.666
18	30	HDR biased	301.34	299.37	-1.967
19	30	HDR biased	301.06	295.88	-5.178
20	30	HDR biased	302.04	300.09	-1.95
21	0	correlation	301.8	302.18	0.378
22	0	correlation	301.33	301.43	0.106
23	0	correlation	300.53	300.74	0.211
24	0	correlation	300.87	301.15	0.273
25	0	correlation	301.57	301.25	-0.317

TID vs Post - Pre Exposure Delta

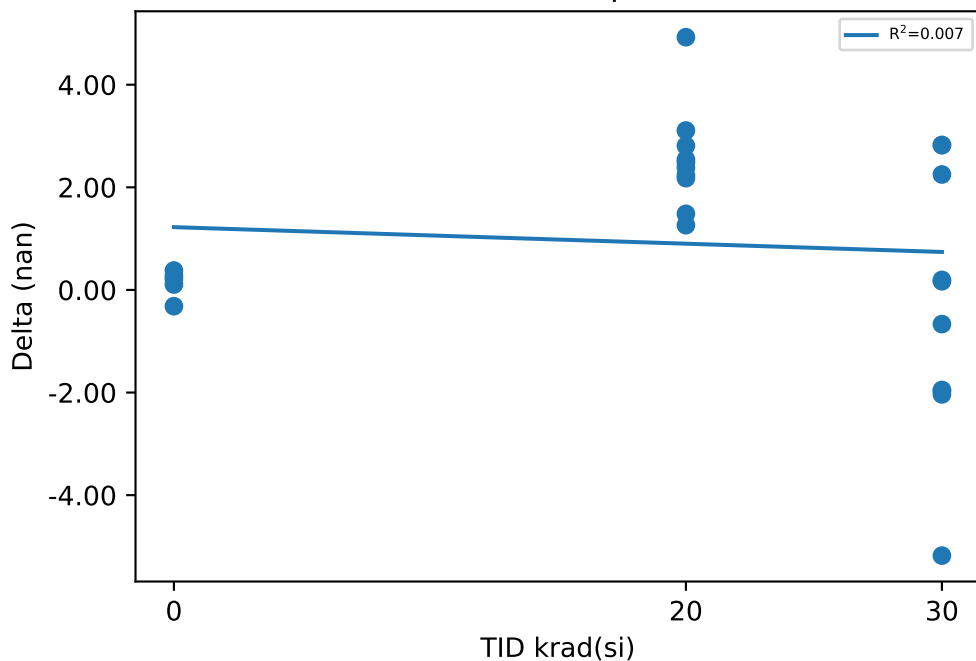

Test Statistics (nan)

krad(si)	Pre Exposure Min	Pre Exposure Avg	Pre Exposure Max	Pre Exposure Std	Post Exposure Min	Post Exposure Avg	Post Exposure Max	Post Exposure Std	Min Delta	Avg Delta	Max Delta	Std Delta
0	300.53	301.22	301.8	0.51584	300.74	301.35	302.18	0.52853	-0.317	0.1302	0.378	0.26875
20	300.8	301.65	302.4	0.47488	302.69	304.19	306.32	1.1489	1.262	2.5417	4.926	1.0048
30	300.39	301.54	302.46	0.58644	295.88	301.19	305.28	2.756	-5.178	-0.3536	2.824	2.5581

Device Test: 10.30 UJXOZU(Kcs_500mA_CH1_UJXOZU)

TID vs Result Stats

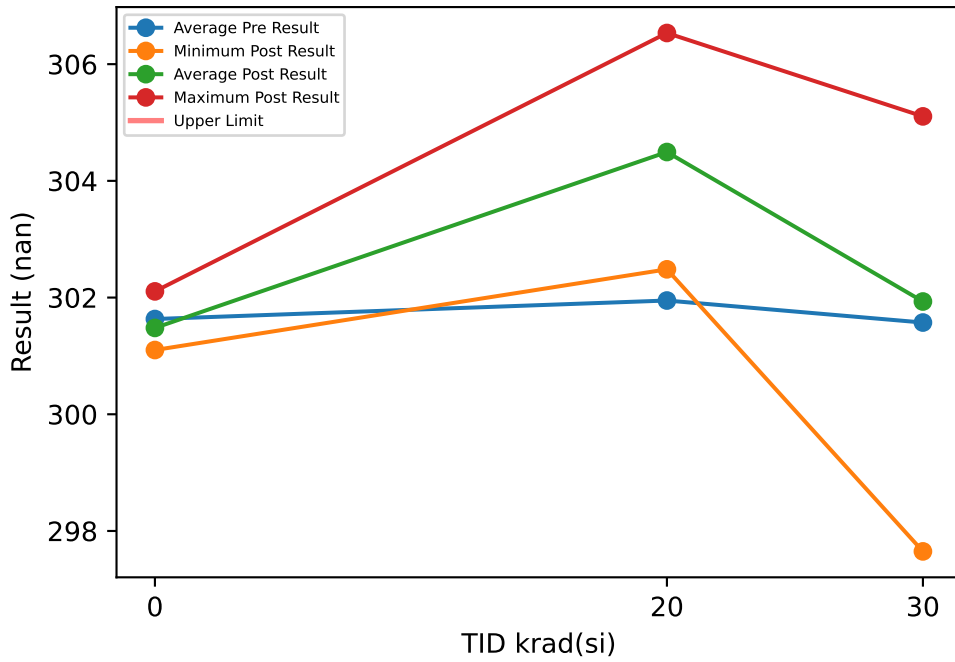

Test Results (No Limits Specified (nan))

Serial #	krad(si)	Exposure Conditions	Pre Result	Post Result	Delta
1	20	HDR unbiased	301.85	303.27	1.42
2	20	HDR unbiased	301.06	302.48	1.427
3	20	HDR unbiased	302.12	304.18	2.056
4	20	HDR unbiased	301.92	303.53	1.611
5	20	HDR unbiased	301.63	303.04	1.404
6	20	HDR biased	301.87	305.7	3.826
7	20	HDR biased	302.19	304.9	2.716
8	20	HDR biased	302.51	305.66	3.148
9	20	HDR biased	302.48	305.65	3.172
10	20	HDR biased	301.87	306.53	4.669
11	30	HDR unbiased	300.23	301.2	0.975
12	30	HDR unbiased	302.71	305.11	2.398
13	30	HDR unbiased	301.6	303.84	2.241
14	30	HDR unbiased	301.81	302.69	0.872
15	30	HDR unbiased	301.59	303.92	2.327
16	30	HDR biased	301.67	301.28	-0.39
17	30	HDR biased	301.86	301.02	-0.835
18	30	HDR biased	301.39	301.36	-0.033
19	30	HDR biased	301.08	297.65	-3.426
20	30	HDR biased	301.79	301.26	-0.526
21	0	correlation	302.39	302.11	-0.287
22	0	correlation	301.71	301.45	-0.259
23	0	correlation	301.55	301.37	-0.176
24	0	correlation	301.29	301.1	-0.19
25	0	correlation	301.22	301.37	0.15

TID vs Post - Pre Exposure Delta

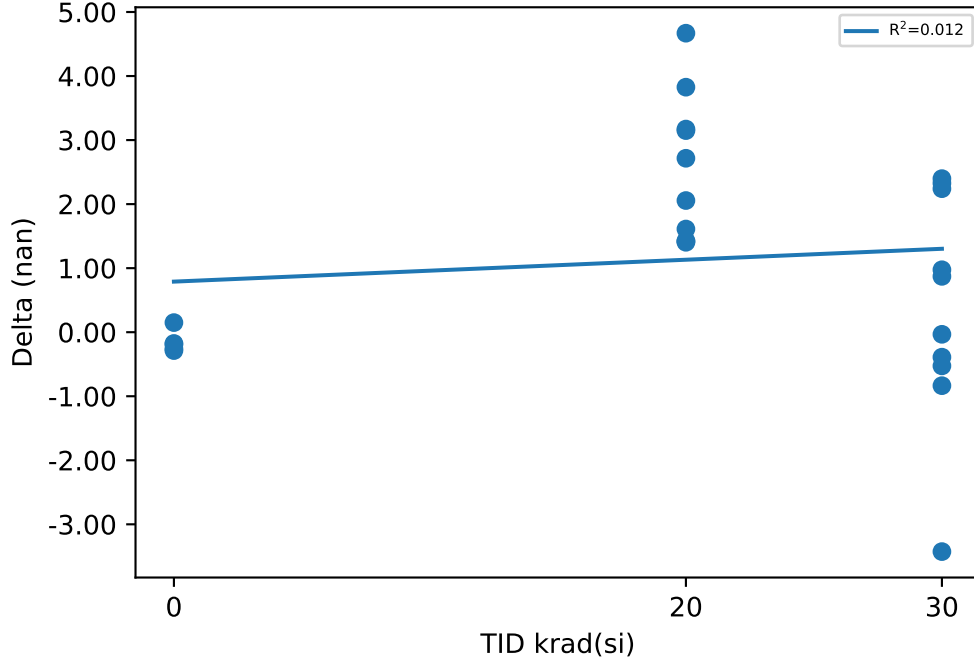

Test Statistics (nan)

krad(si)	Pre Exposure Min	Pre Exposure Avg	Pre Exposure Max	Pre Exposure Std	Post Exposure Min	Post Exposure Avg	Post Exposure Max	Post Exposure Std	Min Delta	Avg Delta	Max Delta	Std Delta
0	301.22	301.63	302.39	0.46794	301.1	301.48	302.11	0.37417	-0.287	-0.1524	0.15	0.17528
20	301.06	301.95	302.51	0.42202	302.48	304.49	306.53	1.3811	1.404	2.5449	4.669	1.1483
30	300.23	301.57	302.71	0.62964	297.65	301.93	305.11	2.0839	-3.426	0.3603	2.398	1.8094

Device Test: 10.3 UJF0T(dCSR_50mA_CH1_UJF0T)

TID vs Result Stats

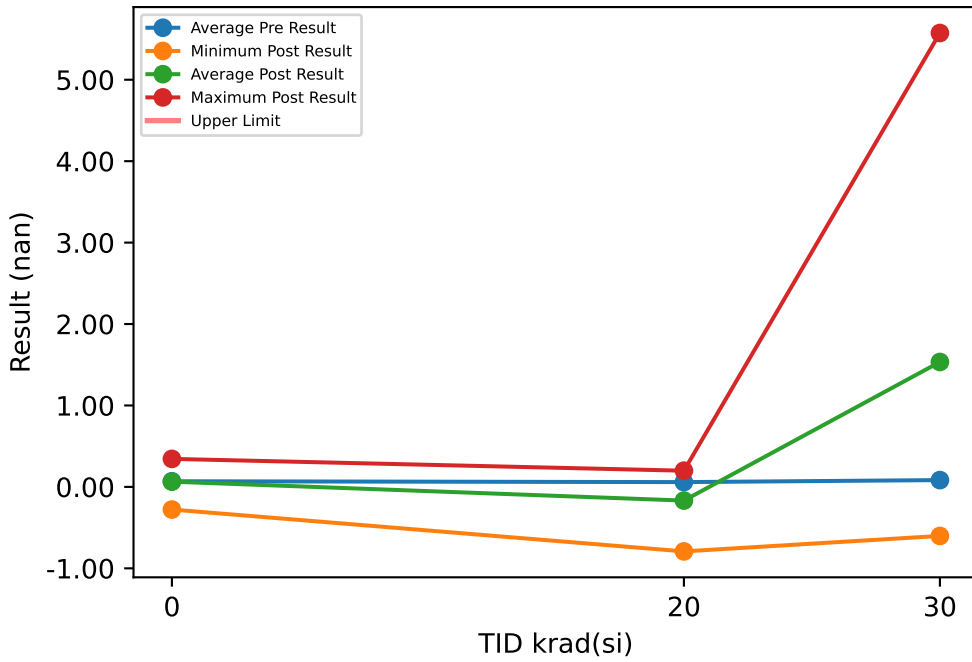

Test Results (No Limits Specified (nan))

Serial #	krad(si)	Exposure Conditions	Pre Result	Post Result	Delta
1	20	HDR unbiased	0.302	0.159	-0.143
2	20	HDR unbiased	0.448	0.005	-0.443
3	20	HDR unbiased	-0.129	-0.392	-0.263
4	20	HDR unbiased	-0.246	-0.792	-0.546
5	20	HDR unbiased	0.214	-0.166	-0.38
6	20	HDR biased	-0.214	-0.015	0.199
7	20	HDR biased	0.171	-0.236	-0.407
8	20	HDR biased	-0.033	0.199	0.232
9	20	HDR biased	-0.296	-0.03	0.266
10	20	HDR biased	0.373	-0.411	-0.784
11	30	HDR unbiased	0.339	0.3	-0.039
12	30	HDR unbiased	-0.292	-0.602	-0.31
13	30	HDR unbiased	0.25	-0.416	-0.666
14	30	HDR unbiased	-0.16	0.006	0.166
15	30	HDR unbiased	-0.126	-0.522	-0.396
16	30	HDR biased	0.251	2.135	1.884
17	30	HDR biased	0.293	3.405	3.112
18	30	HDR biased	0.067	2.448	2.381
19	30	HDR biased	0.112	5.574	5.462
20	30	HDR biased	0.101	3.013	2.912
21	0	correlation	0.08	-0.151	-0.231
22	0	correlation	-0.289	-0.278	0.011
23	0	correlation	0.227	0.344	0.117
24	0	correlation	0.086	0.198	0.112
25	0	correlation	0.243	0.208	-0.035

TID vs Post - Pre Exposure Delta

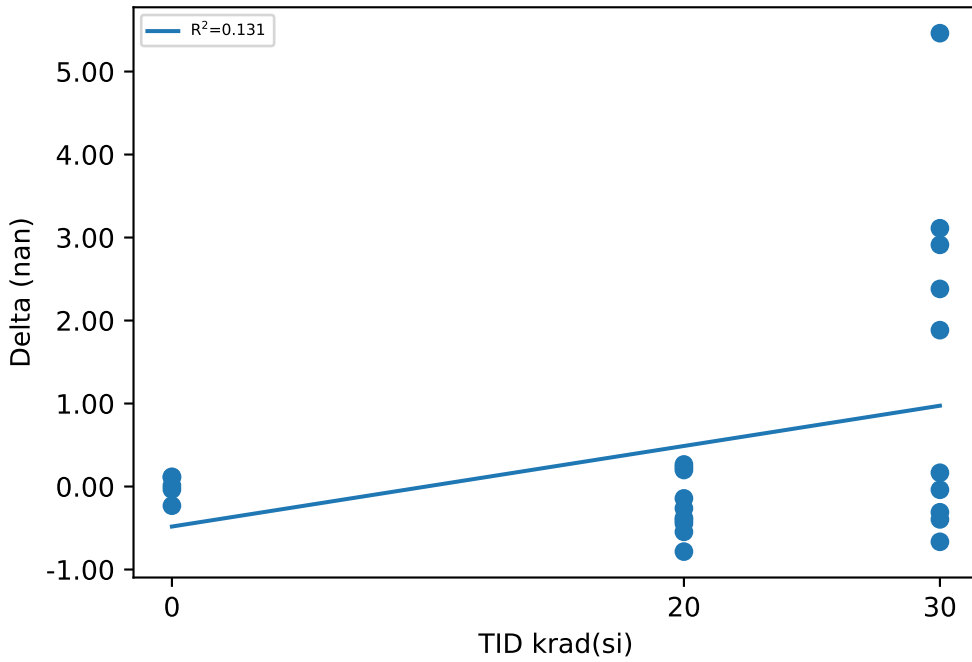

Test Statistics (nan)

krad(si)	Pre Exposure Min	Pre Exposure Avg	Pre Exposure Max	Pre Exposure Std	Post Exposure Min	Post Exposure Avg	Post Exposure Max	Post Exposure Std	Min Delta	Avg Delta	Max Delta	Std Delta
0	-0.289	0.0694	0.243	0.21437	-0.278	0.0642	0.344	0.26471	-0.231	-0.0052	0.117	0.14213
20	-0.296	0.059	0.448	0.27546	-0.792	-0.1679	0.199	0.30134	-0.784	-0.2269	0.266	0.35871
30	-0.292	0.0835	0.339	0.21357	-0.602	1.5341	5.574	2.0991	-0.666	1.4506	5.462	2.0248

Device Test: 10.31 UJXOZU(Kcs_5mA_CH2_UJXOZU)

TID vs Result Stats

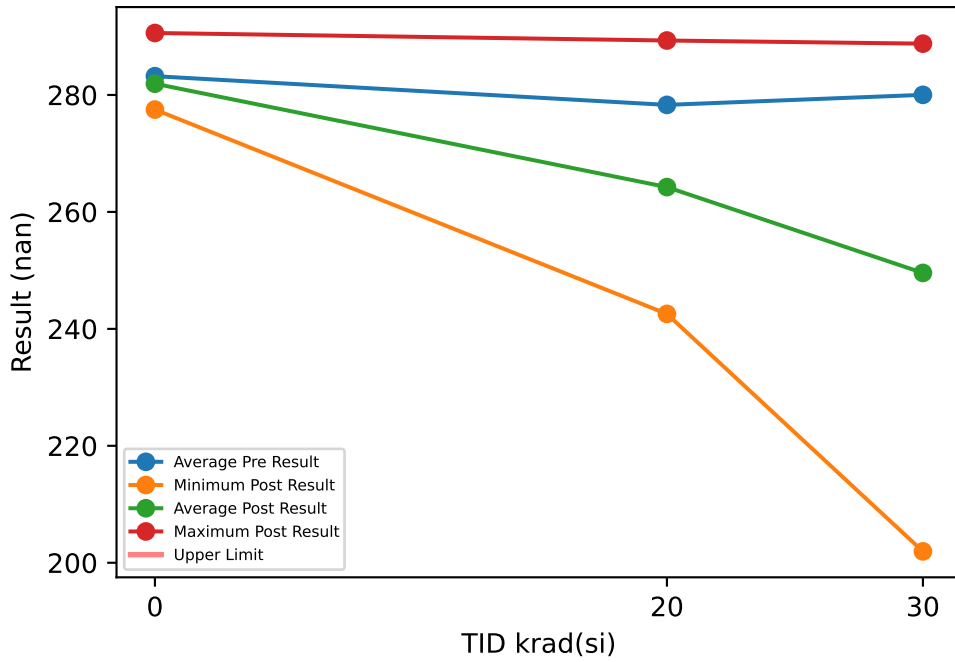

Test Results (No Limits Specified (nan))

Serial #	krad(si)	Exposure Conditions	Pre Result	Post Result	Delta
1	20	HDR unbiased	272.37	271.98	-0.391
2	20	HDR unbiased	271.93	273.04	1.108
3	20	HDR unbiased	282.71	271.72	-10.986
4	20	HDR unbiased	281.38	289.31	7.932
5	20	HDR unbiased	282.42	280.43	-1.991
6	20	HDR biased	281.22	252.96	-28.26
7	20	HDR biased	274.71	242.56	-32.157
8	20	HDR biased	289.2	252.44	-36.764
9	20	HDR biased	273.57	250.32	-23.244
10	20	HDR biased	273.52	257.7	-15.816
11	30	HDR unbiased	285.81	278.11	-7.703
12	30	HDR unbiased	276.74	275.56	-1.173
13	30	HDR unbiased	286.02	275.8	-10.22
14	30	HDR unbiased	271.16	282.18	11.015
15	30	HDR unbiased	294.44	288.78	-5.665
16	30	HDR biased	271.23	220.53	-50.698
17	30	HDR biased	273.73	215	-58.729
18	30	HDR biased	282.52	227.71	-54.808
19	30	HDR biased	275.12	201.94	-73.175
20	30	HDR biased	283.43	230.06	-53.366
21	0	correlation	276.05	278.65	2.6
22	0	correlation	286.21	290.6	4.387
23	0	correlation	282.6	281.13	-1.46
24	0	correlation	287.58	277.5	-10.076
25	0	correlation	283.62	281.74	-1.882

TID vs Post - Pre Exposure Delta

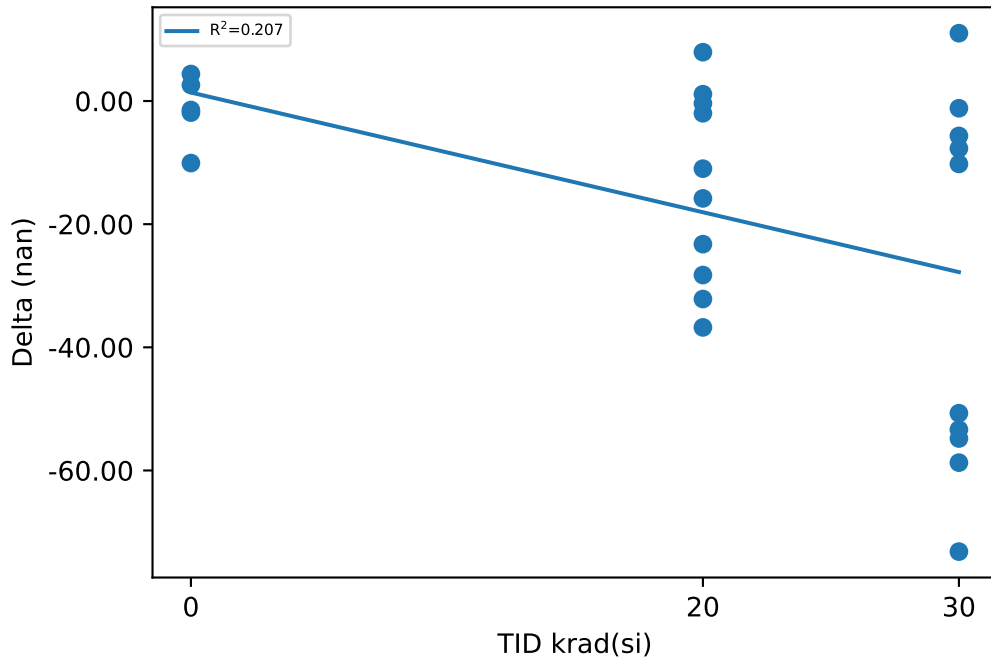

Test Statistics (nan)

krad(si)	Pre Exposure Min	Pre Exposure Avg	Pre Exposure Max	Pre Exposure Std	Post Exposure Min	Post Exposure Avg	Post Exposure Max	Post Exposure Std	Min Delta	Avg Delta	Max Delta	Std Delta
0	276.05	283.21	287.58	4.4694	277.5	281.93	290.6	5.1513	-10.076	-1.2862	4.387	5.5887
20	271.93	278.3	289.2	5.8411	242.56	264.25	289.31	15.119	-36.764	-14.057	7.932	15.591
30	271.16	280.02	294.44	7.6417	201.94	249.57	288.78	33.24	-73.175	-30.452	11.015	30.315

Device Test: 10.32 UJXOZU(Kcs_25mA_CH2_UJXOZU)

TID vs Result Stats

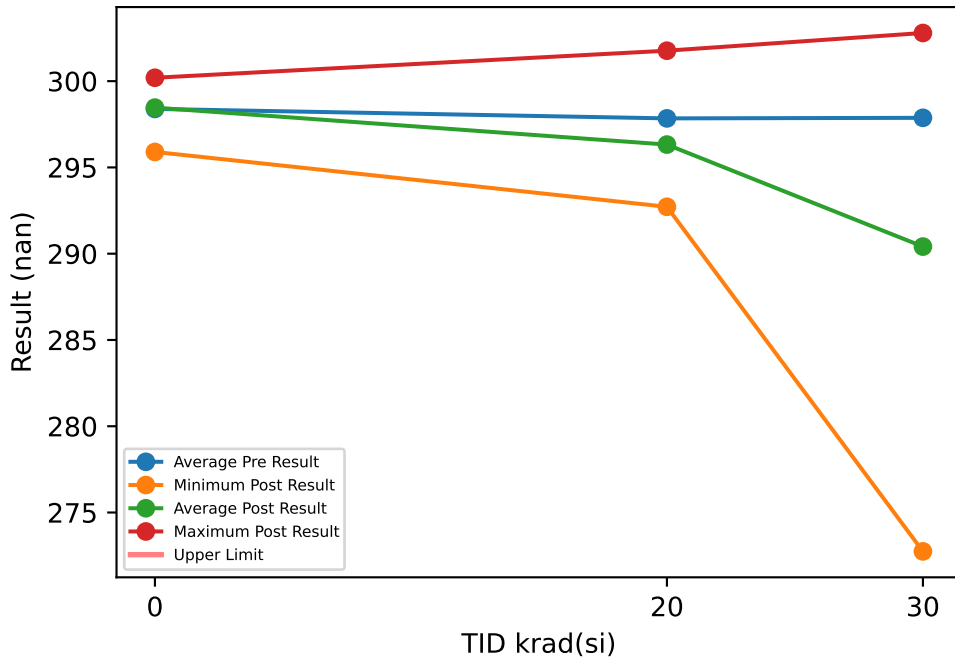

TID vs Post - Pre Exposure Delta

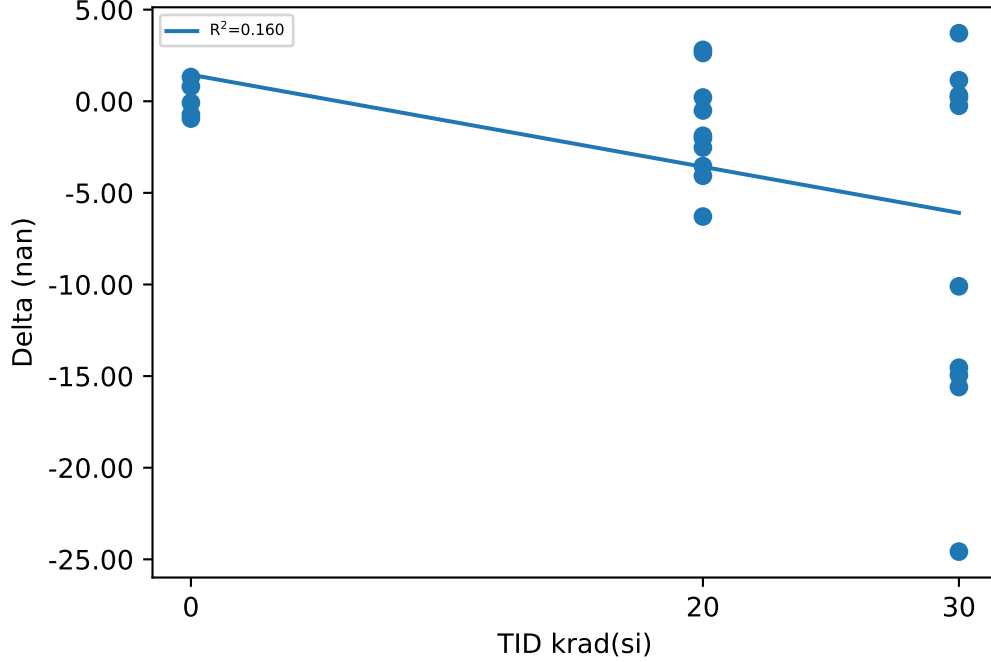

Test Results (No Limits Specified (nan))

Serial #	krad(si)	Exposure Conditions	Pre Result	Post Result	Delta
1	20	HDR unbiased	297.69	295.68	-2.015
2	20	HDR unbiased	296.47	299.11	2.635
3	20	HDR unbiased	297.9	298.1	0.206
4	20	HDR unbiased	298.96	301.76	2.806
5	20	HDR unbiased	298.96	298.46	-0.503
6	20	HDR biased	299.87	293.57	-6.291
7	20	HDR biased	297.06	293	-4.067
8	20	HDR biased	298.76	295.22	-3.537
9	20	HDR biased	295.24	292.72	-2.524
10	20	HDR biased	297.51	295.62	-1.884
11	30	HDR unbiased	297.8	298.95	1.149
12	30	HDR unbiased	301.38	301.14	-0.245
13	30	HDR unbiased	299.32	299.53	0.205
14	30	HDR unbiased	296.03	296.35	0.321
15	30	HDR unbiased	299.08	302.79	3.715
16	30	HDR biased	297.78	282.18	-15.597
17	30	HDR biased	295.89	285.79	-10.099
18	30	HDR biased	297.38	282.83	-14.542
19	30	HDR biased	297.32	272.75	-24.578
20	30	HDR biased	296.77	281.82	-14.951
21	0	correlation	296.84	295.9	-0.946
22	0	correlation	298.63	297.91	-0.726
23	0	correlation	299.06	299.87	0.805
24	0	correlation	298.88	300.2	1.321
25	0	correlation	298.54	298.46	-0.081

Test Statistics (nan)

krad(si)	Pre Exposure Min	Pre Exposure Avg	Pre Exposure Max	Pre Exposure Std	Post Exposure Min	Post Exposure Avg	Post Exposure Max	Post Exposure Std	Min Delta	Avg Delta	Max Delta	Std Delta
0	296.84	298.39	299.06	0.88901	295.9	298.47	300.2	1.7225	-0.946	0.0746	1.321	0.97388
20	295.24	297.84	299.87	1.3672	292.72	296.32	301.76	2.9596	-6.291	-1.5174	2.806	2.8809
30	295.89	297.87	301.38	1.6659	272.75	290.41	302.79	10.498	-24.578	-7.4622	3.715	9.6771

Device Test: 10.33 UJXOZU(Kcs_50mA_CH2_UJXOZU)

TID vs Result Stats

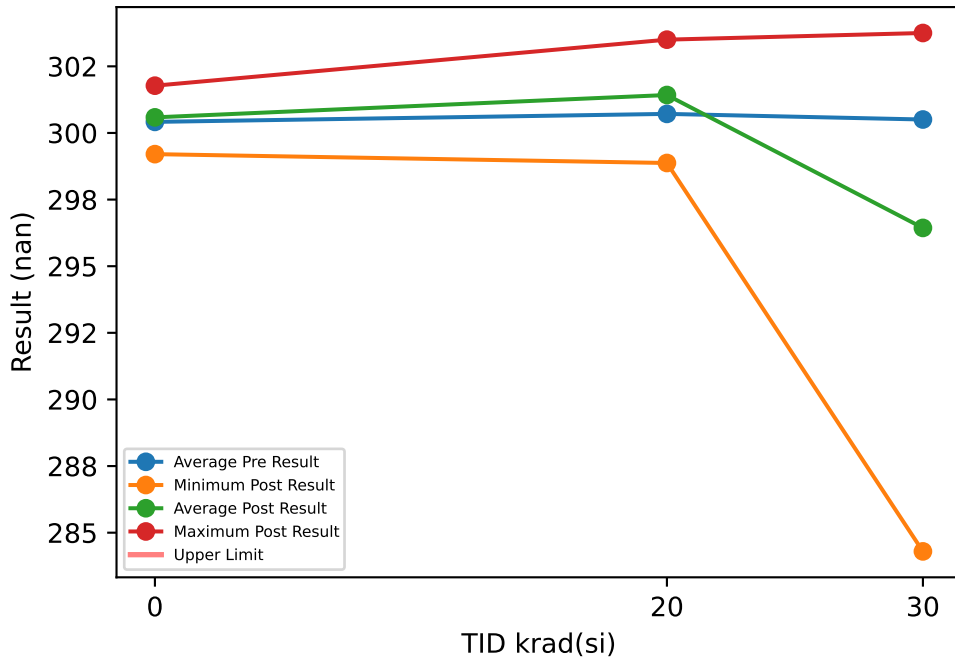

Test Results (No Limits Specified (nan))

Serial #	krad(si)	Exposure Conditions	Pre Result	Post Result	Delta
1	20	HDR unbiased	301.9	302.13	0.227
2	20	HDR unbiased	299.38	299.94	0.562
3	20	HDR unbiased	299.96	301.39	1.439
4	20	HDR unbiased	301.94	303.5	1.563
5	20	HDR unbiased	301.46	302.25	0.798
6	20	HDR biased	300.33	301.28	0.946
7	20	HDR biased	299.76	298.87	-0.883
8	20	HDR biased	301.94	301.24	-0.703
9	20	HDR biased	298.77	300.32	1.549
10	20	HDR biased	301.72	303.31	1.587
11	30	HDR unbiased	300.88	300.96	0.083
12	30	HDR unbiased	301.82	302.86	1.04
13	30	HDR unbiased	301.81	303.11	1.297
14	30	HDR unbiased	299.95	298.96	-0.992
15	30	HDR unbiased	301.34	303.75	2.407
16	30	HDR biased	300.67	293.25	-7.419
17	30	HDR biased	299.46	293.12	-6.345
18	30	HDR biased	299.3	291	-8.297
19	30	HDR biased	298.63	284.3	-14.329
20	30	HDR biased	301.19	293.06	-8.129
21	0	correlation	299.93	299.2	-0.723
22	0	correlation	298.96	299.76	0.801
23	0	correlation	301.77	301.34	-0.426
24	0	correlation	300.96	300.84	-0.119
25	0	correlation	300.46	301.77	1.315

TID vs Post - Pre Exposure Delta

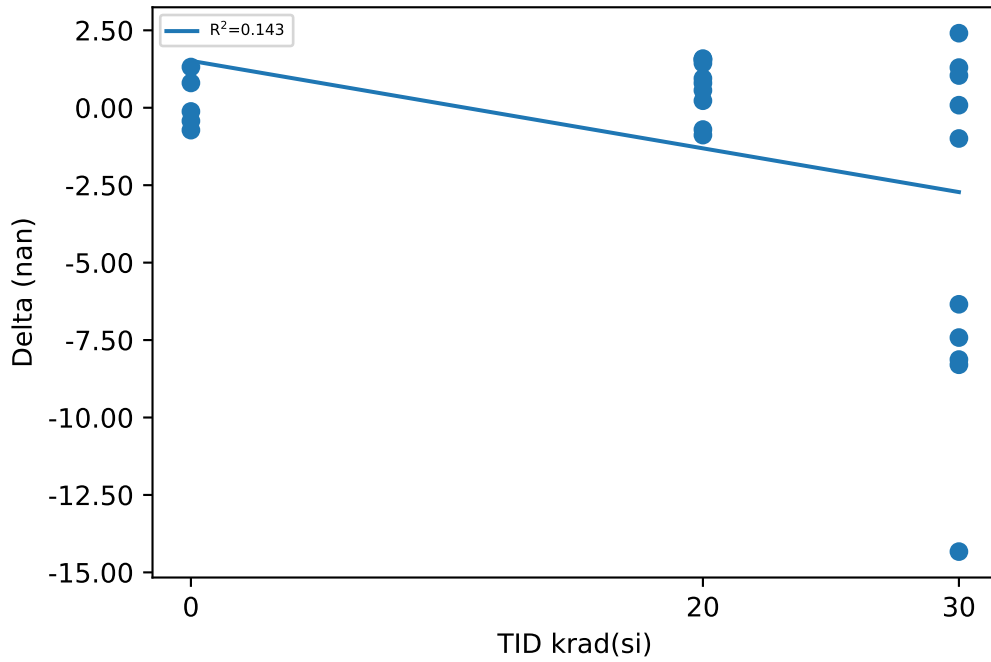

Test Statistics (nan)

krad(si)	Pre Exposure Min	Pre Exposure Avg	Pre Exposure Max	Pre Exposure Std	Post Exposure Min	Post Exposure Avg	Post Exposure Max	Post Exposure Std	Min Delta	Avg Delta	Max Delta	Std Delta
0	298.96	300.42	301.77	1.0584	299.2	300.58	301.77	1.0764	-0.723	0.1696	1.315	0.8581
20	298.77	300.72	301.94	1.2097	298.87	301.42	303.5	1.4542	-0.883	0.7085	1.587	0.91802
30	298.63	300.5	301.82	1.1131	284.3	296.44	303.75	6.4605	-14.329	-4.0684	2.407	5.5735

Device Test: 10.34 UJXOZU(Kcs_100mA_CH2_UJXOZU)

TID vs Result Stats

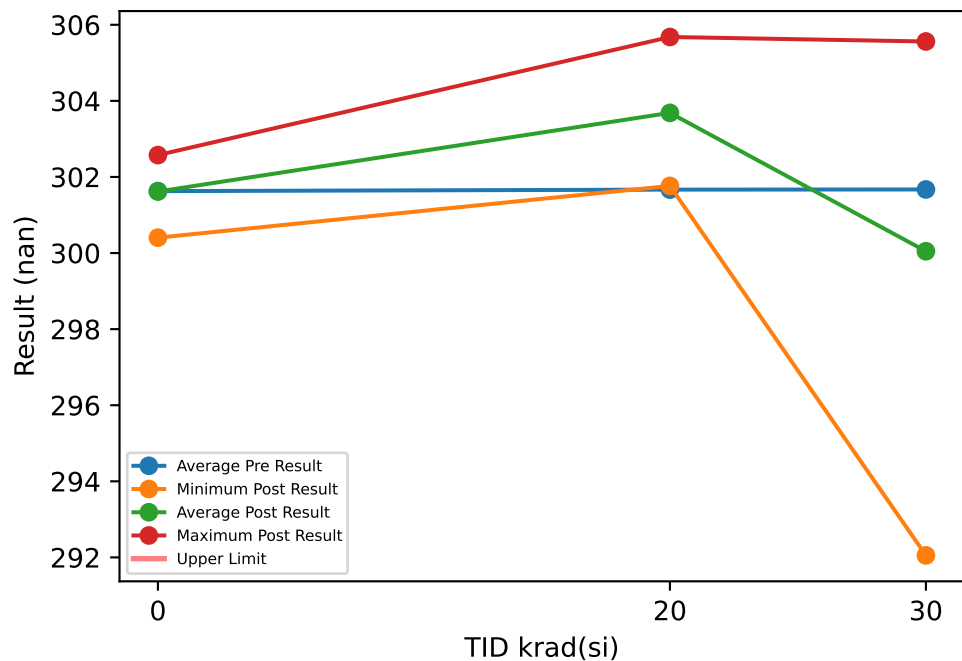

Test Results (No Limits Specified (nan))

Serial #	krad(si)	Exposure Conditions	Pre Result	Post Result	Delta
1	20	HDR unbiased	302.76	303.6	0.84
2	20	HDR unbiased	300.12	301.76	1.645
3	20	HDR unbiased	300.19	302.65	2.457
4	20	HDR unbiased	303.23	304.26	1.03
5	20	HDR unbiased	302.15	303.96	1.808
6	20	HDR biased	302.1	304.74	2.641
7	20	HDR biased	300.84	302.97	2.13
8	20	HDR biased	303.28	304.83	1.55
9	20	HDR biased	300.46	302.39	1.936
10	20	HDR biased	301.55	305.68	4.134
11	30	HDR unbiased	302.14	302.81	0.676
12	30	HDR unbiased	303.38	305.18	1.794
13	30	HDR unbiased	303.08	303.93	0.845
14	30	HDR unbiased	301.04	301.69	0.657
15	30	HDR unbiased	302.53	305.56	3.028
16	30	HDR biased	301.02	295.93	-5.092
17	30	HDR biased	301.82	298.34	-3.481
18	30	HDR biased	300.1	297.42	-2.681
19	30	HDR biased	299.76	292.05	-7.711
20	30	HDR biased	301.83	297.56	-4.271
21	0	correlation	300.95	300.69	-0.26
22	0	correlation	300.29	300.4	0.119
23	0	correlation	302.74	302.57	-0.164
24	0	correlation	302.48	302.31	-0.167
25	0	correlation	301.69	302.11	0.419

TID vs Post - Pre Exposure Delta

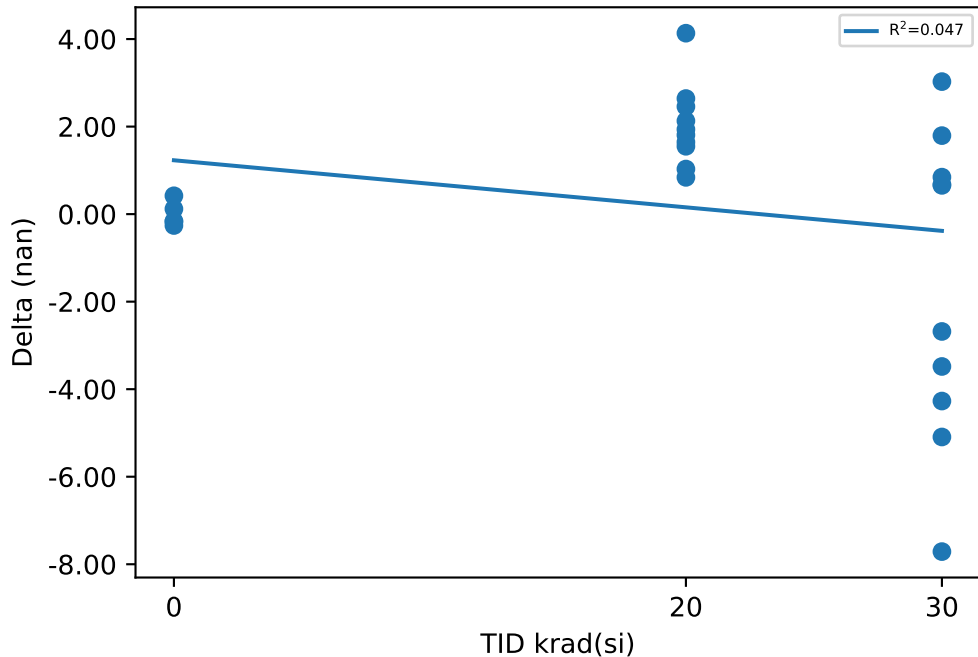

Test Statistics (nan)

krad(si)	Pre Exposure Min	Pre Exposure Avg	Pre Exposure Max	Pre Exposure Std	Post Exposure Min	Post Exposure Avg	Post Exposure Max	Post Exposure Std	Min Delta	Avg Delta	Max Delta	Std Delta
0	300.29	301.63	302.74	1.0288	300.4	301.62	302.57	0.99759	-0.26	-0.0106	0.419	0.27908
20	300.12	301.67	303.28	1.2202	301.76	303.68	305.68	1.2365	0.84	2.0171	4.134	0.93355
30	299.76	301.67	303.38	1.196	292.05	300.05	305.56	4.4603	-7.711	-1.6236	3.028	3.505

Device Test: 10.35 UJXOZU(Kcs_250mA_CH2_UJXOZU)

TID vs Result Stats

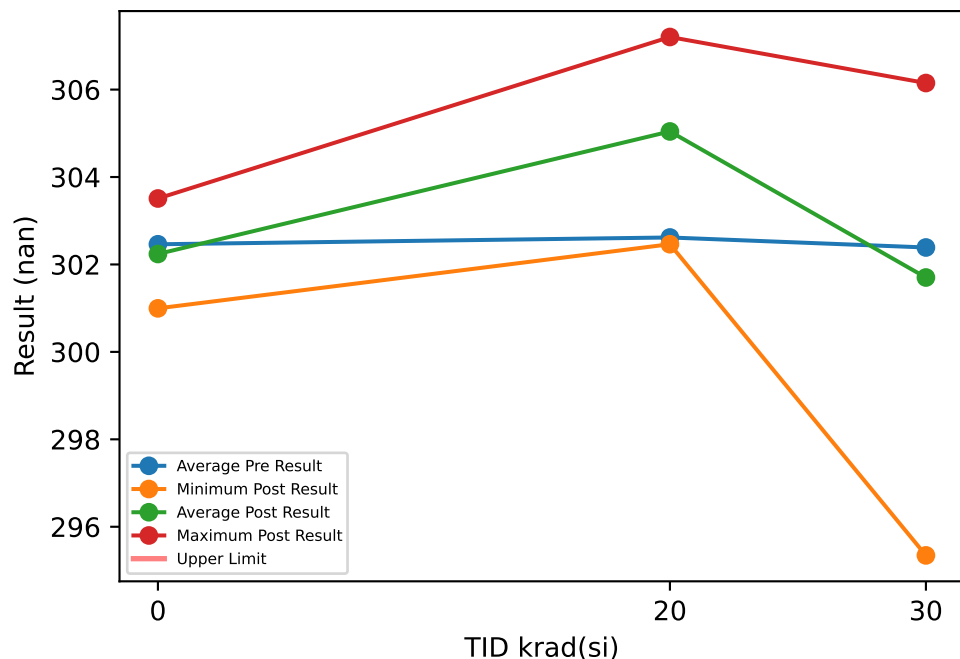

Test Results (No Limits Specified (nan))

Serial #	krad(si)	Exposure Conditions	Pre Result	Post Result	Delta
1	20	HDR unbiased	303.33	304.38	1.054
2	20	HDR unbiased	300.94	302.46	1.525
3	20	HDR unbiased	301.56	303.5	1.944
4	20	HDR unbiased	303.52	305.42	1.895
5	20	HDR unbiased	303.3	304.46	1.157
6	20	HDR biased	303.3	306.4	3.104
7	20	HDR biased	301.79	304.4	2.616
8	20	HDR biased	304.13	307.15	3.022
9	20	HDR biased	301.36	305.05	3.69
10	20	HDR biased	302.96	307.2	4.246
11	30	HDR unbiased	303.03	303.25	0.221
12	30	HDR unbiased	303.64	306.15	2.51
13	30	HDR unbiased	303.23	305.16	1.933
14	30	HDR unbiased	301.99	302.15	0.168
15	30	HDR unbiased	303.63	305.4	1.765
16	30	HDR biased	301.67	300.36	-1.309
17	30	HDR biased	301.84	300.6	-1.242
18	30	HDR biased	301.07	299.17	-1.903
19	30	HDR biased	301.02	295.35	-5.671
20	30	HDR biased	302.77	299.43	-3.338
21	0	correlation	301.27	301.39	0.121
22	0	correlation	301.19	301	-0.192
23	0	correlation	303.64	303.51	-0.129
24	0	correlation	303.06	302.44	-0.611
25	0	correlation	303.16	302.86	-0.3

TID vs Post - Pre Exposure Delta

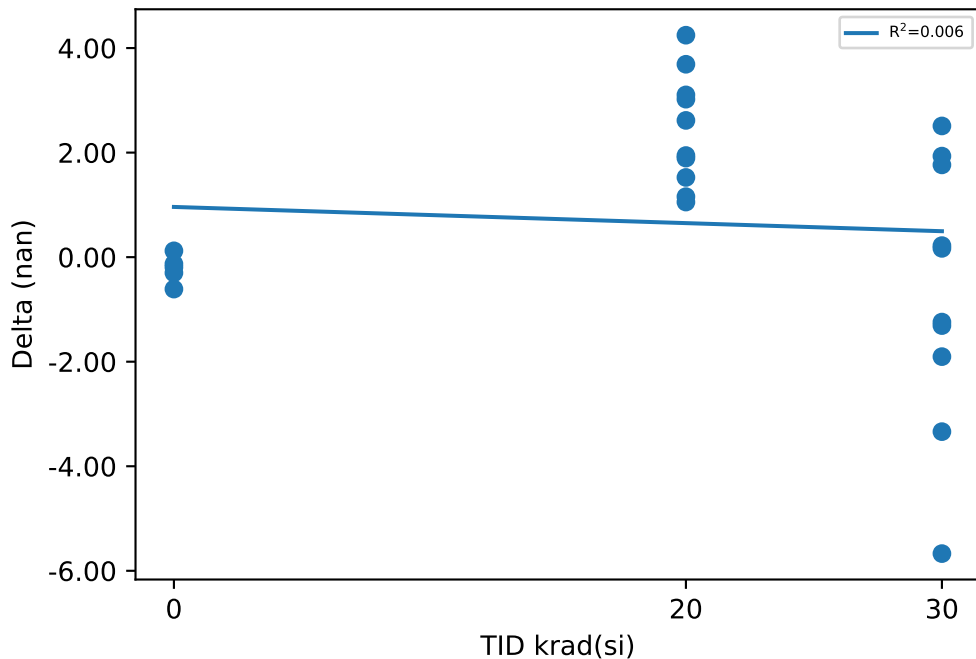

Test Statistics (nan)

krad(si)	Pre Exposure Min	Pre Exposure Avg	Pre Exposure Max	Pre Exposure Std	Post Exposure Min	Post Exposure Avg	Post Exposure Max	Post Exposure Std	Min Delta	Avg Delta	Max Delta	Std Delta
0	301.19	302.46	303.64	1.1486	301	302.24	303.51	1.0384	-0.611	-0.2222	0.121	0.26674
20	300.94	302.62	304.13	1.0995	302.46	305.04	307.2	1.5398	1.054	2.4253	4.246	1.0842
30	301.02	302.39	303.64	0.99842	295.35	301.7	306.15	3.3831	-5.671	-0.6866	2.51	2.5537

Device Test: 10.37 UJXOZU(Kcs_5mA_CH3_UJXOZU)

TID vs Result Stats

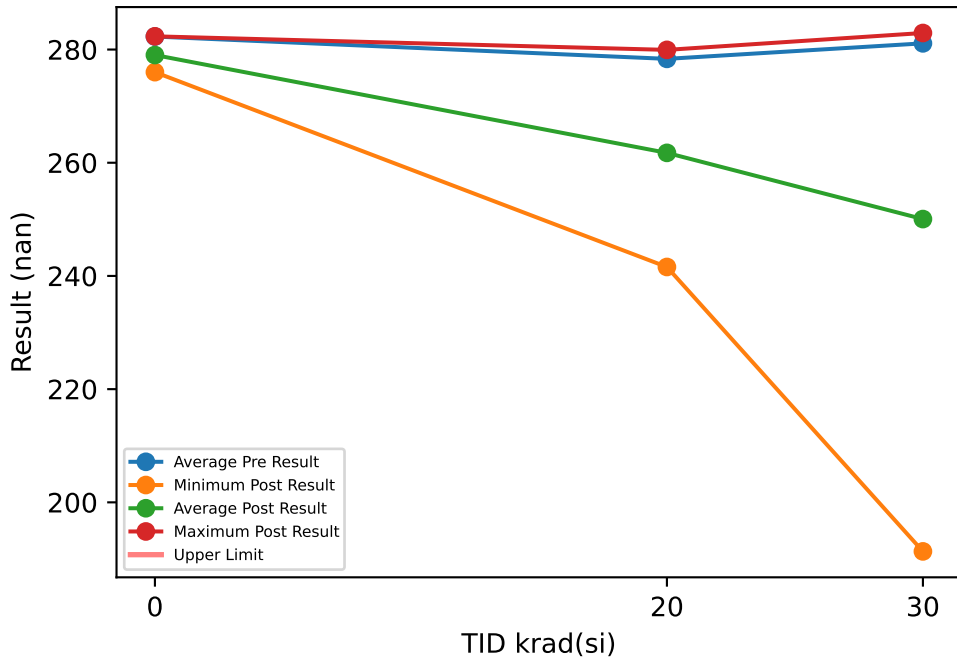

Test Results (No Limits Specified (nan))

Serial #	krad(si)	Exposure Conditions	Pre Result	Post Result	Delta
1	20	HDR unbiased	277.33	268.04	-9.292
2	20	HDR unbiased	273.85	272	-1.848
3	20	HDR unbiased	271.18	279.94	8.757
4	20	HDR unbiased	292.55	278.93	-13.621
5	20	HDR unbiased	273.73	270.64	-3.095
6	20	HDR biased	277.02	244.7	-32.321
7	20	HDR biased	271.07	251.55	-19.52
8	20	HDR biased	281.72	241.59	-40.139
9	20	HDR biased	279.8	256.12	-23.683
10	20	HDR biased	285.27	253.94	-31.322
11	30	HDR unbiased	283.93	272.71	-11.223
12	30	HDR unbiased	275.45	279.8	4.351
13	30	HDR unbiased	282.62	282.92	0.306
14	30	HDR unbiased	278.17	274.63	-3.539
15	30	HDR unbiased	285.32	279.97	-5.348
16	30	HDR biased	286.79	226.34	-60.448
17	30	HDR biased	277.52	231.19	-46.334
18	30	HDR biased	288.4	238.98	-49.417
19	30	HDR biased	278.46	191.33	-87.122
20	30	HDR biased	274.3	222.61	-51.687
21	0	correlation	284.77	277.01	-7.759
22	0	correlation	287.71	282.33	-5.378
23	0	correlation	277.79	276.01	-1.781
24	0	correlation	283.17	281.38	-1.795
25	0	correlation	278.06	278.43	0.369

TID vs Post - Pre Exposure Delta

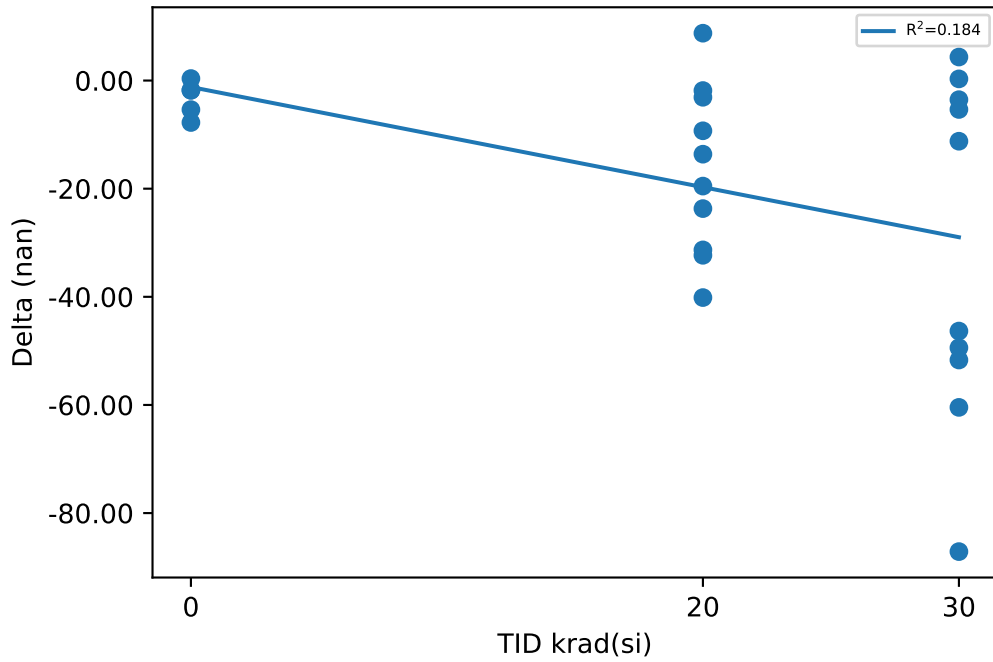

Test Statistics (nan)

krad(si)	Pre Exposure Min	Pre Exposure Avg	Pre Exposure Max	Pre Exposure Std	Post Exposure Min	Post Exposure Avg	Post Exposure Max	Post Exposure Std	Min Delta	Avg Delta	Max Delta	Std Delta
0	277.79	282.3	287.71	4.3159	276.01	279.03	282.33	2.7397	-7.759	-3.2688	0.369	3.2492
20	271.07	278.35	292.55	6.7645	241.59	261.74	279.94	13.919	-40.139	-16.608	8.757	15.57
30	274.3	281.09	288.4	4.9484	191.33	250.05	282.92	32.006	-87.122	-31.046	4.351	31.714

Device Test: 10.38 UJXOZU(Kcs_25mA_CH3_UJXOZU)

TID vs Result Stats

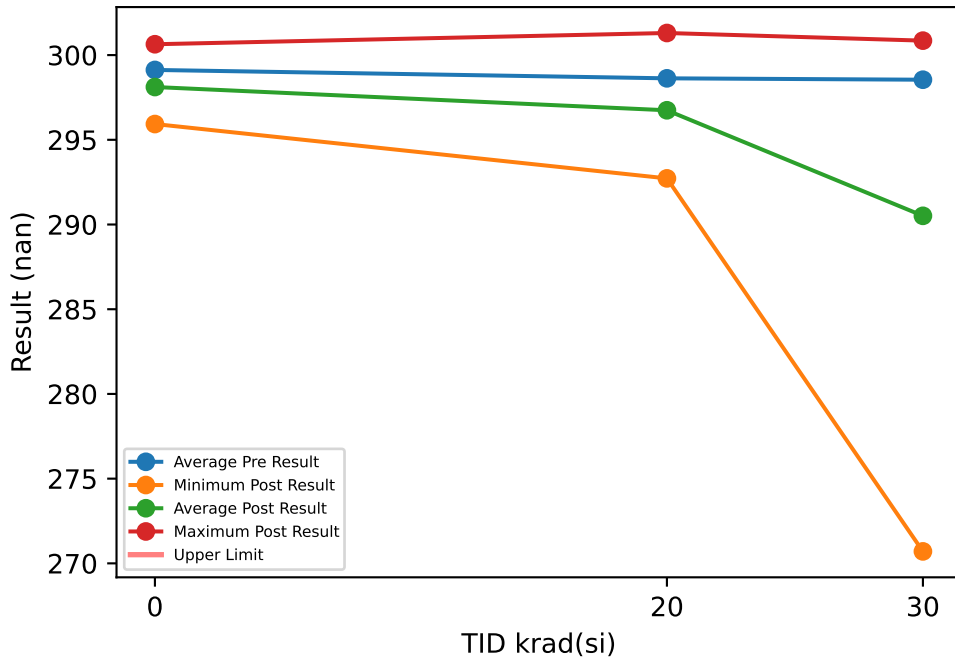

TID vs Post - Pre Exposure Delta

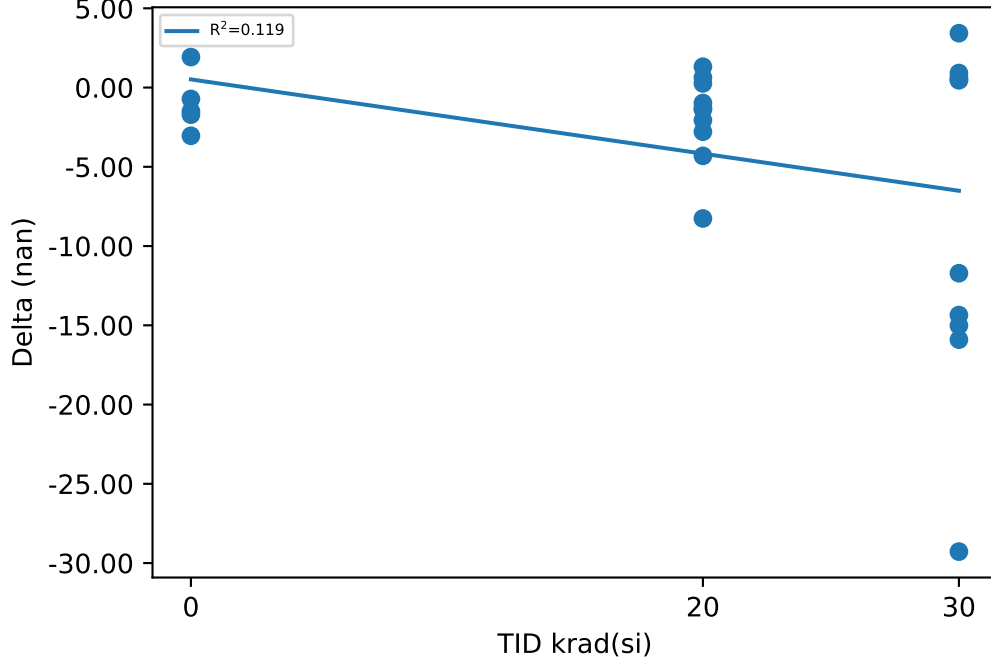

Test Results (No Limits Specified (nan))

Serial #	krad(si)	Exposure Conditions	Pre Result	Post Result	Delta
1	20	HDR unbiased	297.48	296.1	-1.387
2	20	HDR unbiased	298.02	298.65	0.631
3	20	HDR unbiased	296.49	296.75	0.261
4	20	HDR unbiased	299.99	301.3	1.315
5	20	HDR unbiased	299.23	298.25	-0.976
6	20	HDR biased	299.36	295.05	-4.31
7	20	HDR biased	298.69	296.62	-2.062
8	20	HDR biased	300.98	292.72	-8.26
9	20	HDR biased	297.84	296.56	-1.284
10	20	HDR biased	298.2	295.41	-2.786
11	30	HDR unbiased	299.55	300.47	0.916
12	30	HDR unbiased	299.98	300.44	0.462
13	30	HDR unbiased	300.37	300.85	0.479
14	30	HDR unbiased	295.86	299.29	3.429
15	30	HDR unbiased	298.79	299.42	0.633
16	30	HDR biased	298.85	284.49	-14.354
17	30	HDR biased	297.13	282.11	-15.012
18	30	HDR biased	300.05	284.14	-15.905
19	30	HDR biased	299.98	270.71	-29.276
20	30	HDR biased	294.91	283.19	-11.714
21	0	correlation	298.72	300.64	1.924
22	0	correlation	299.9	299.19	-0.718
23	0	correlation	298.98	295.93	-3.045
24	0	correlation	300.18	298.46	-1.711
25	0	correlation	297.85	296.36	-1.492

Test Statistics (nan)

krad(si)	Pre Exposure Min	Pre Exposure Avg	Pre Exposure Max	Pre Exposure Std	Post Exposure Min	Post Exposure Avg	Post Exposure Max	Post Exposure Std	Min Delta	Avg Delta	Max Delta	Std Delta
0	297.85	299.12	300.18	0.93885	295.93	298.12	300.64	1.969	-3.045	-1.0084	1.924	1.8411
20	296.49	298.63	300.98	1.3054	292.72	296.74	301.3	2.3086	-8.26	-1.8858	1.315	2.7884
30	294.91	298.55	300.37	1.9246	270.71	290.51	300.85	10.823	-29.276	-8.0342	3.429	10.784

Device Test: 10.39 UJXOZU(Kcs_50mA_CH3_UJXOZU)

TID vs Result Stats

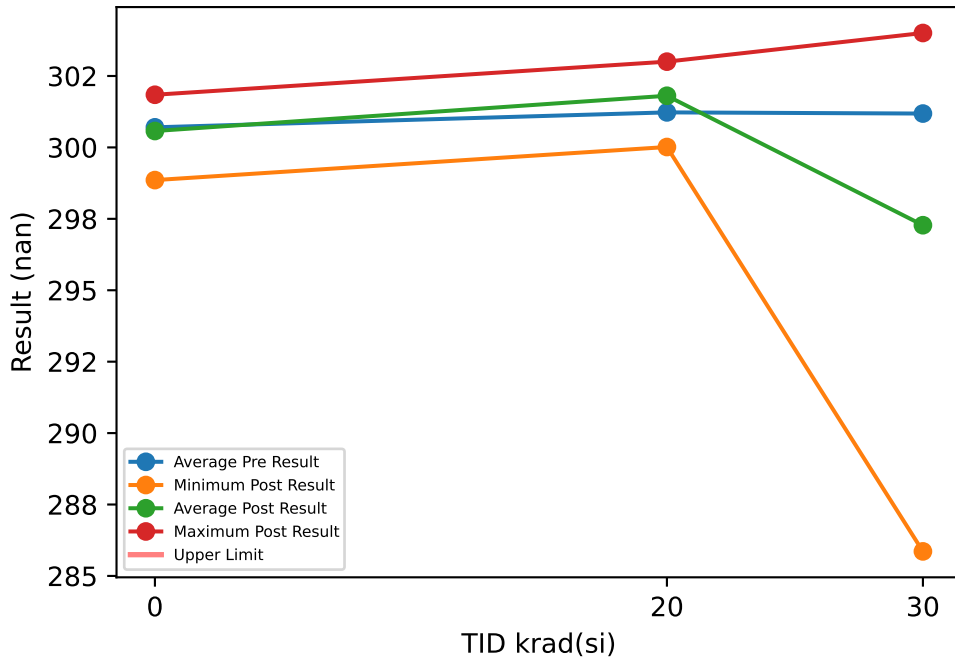

Test Results (No Limits Specified (nan))

Serial #	krad(si)	Exposure Conditions	Pre Result	Post Result	Delta
1	20	HDR unbiased	301.73	303	1.274
2	20	HDR unbiased	300.95	301.66	0.705
3	20	HDR unbiased	299	300.12	1.116
4	20	HDR unbiased	301.67	302.62	0.946
5	20	HDR unbiased	301.01	302.78	1.772
6	20	HDR biased	301.34	300.01	-1.326
7	20	HDR biased	302.43	301.5	-0.928
8	20	HDR biased	302.43	301.65	-0.778
9	20	HDR biased	301.33	302.32	0.992
10	20	HDR biased	300.37	302.42	2.047
11	30	HDR unbiased	301.94	301.64	-0.296
12	30	HDR unbiased	302.49	304	1.514
13	30	HDR unbiased	301.76	303.2	1.432
14	30	HDR unbiased	299.6	303.42	3.828
15	30	HDR unbiased	299.37	302.15	2.789
16	30	HDR biased	302.19	294.14	-8.053
17	30	HDR biased	301.93	292.27	-9.659
18	30	HDR biased	301.48	294.53	-6.955
19	30	HDR biased	301.83	285.86	-15.967
20	30	HDR biased	299.27	291.55	-7.721
21	0	correlation	301.17	301.05	-0.119
22	0	correlation	301.89	301.84	-0.049
23	0	correlation	300.56	299.96	-0.591
24	0	correlation	301.04	301.16	0.123
25	0	correlation	298.87	298.86	-0.011

TID vs Post - Pre Exposure Delta

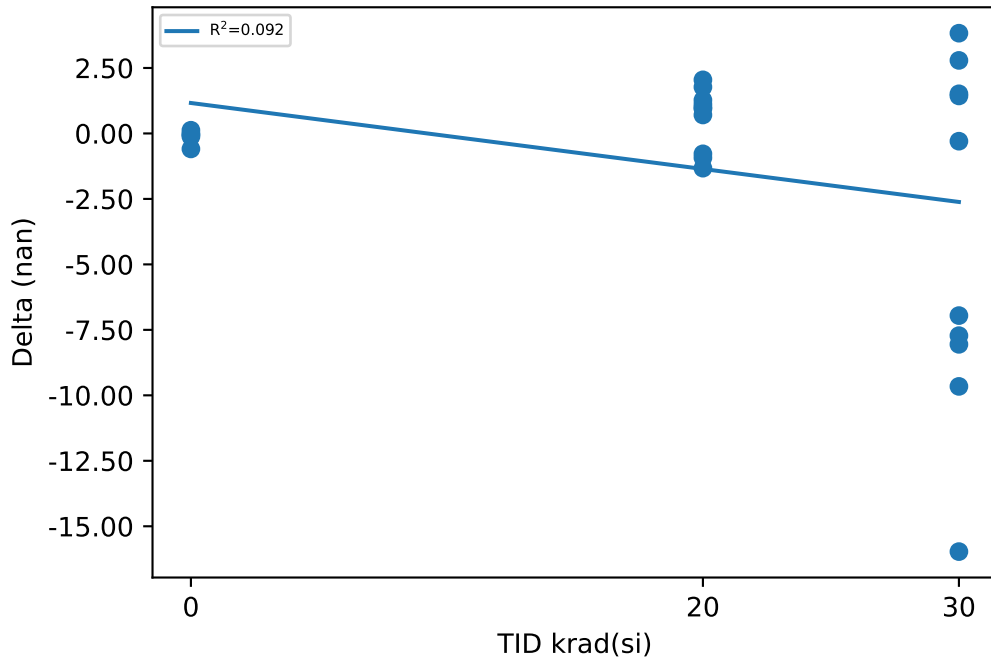

Test Statistics (nan)

krad(si)	Pre Exposure Min	Pre Exposure Avg	Pre Exposure Max	Pre Exposure Std	Post Exposure Min	Post Exposure Avg	Post Exposure Max	Post Exposure Std	Min Delta	Avg Delta	Max Delta	Std Delta
0	298.87	300.7	301.89	1.1328	298.86	300.57	301.84	1.1727	-0.591	-0.1294	0.123	0.27266
20	299	301.23	302.43	1.0098	300.01	301.81	303	1.0483	-1.326	0.582	2.047	1.1744
30	299.27	301.19	302.49	1.2559	285.86	297.28	304	6.3821	-15.967	-3.9088	3.828	6.6262

Device Test: 10.40 UJXOZU(Kcs_100mA_CH3_UJXOZU)

TID vs Result Stats

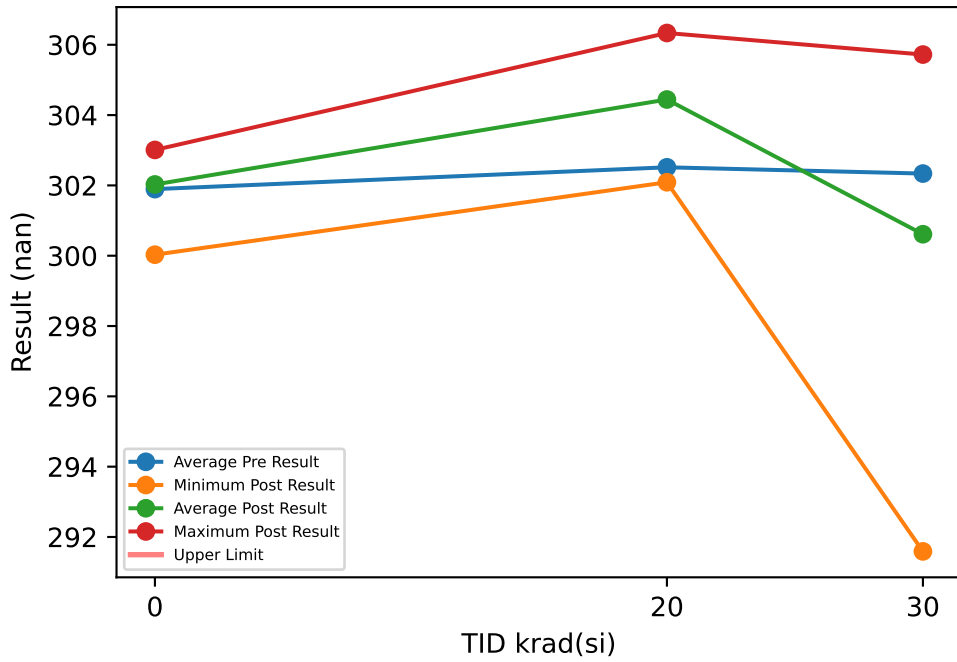

Test Results (No Limits Specified (nan))

Serial #	krad(si)	Exposure Conditions	Pre Result	Post Result	Delta
1	20	HDR unbiased	302.57	304.2	1.625
2	20	HDR unbiased	302.9	303.83	0.931
3	20	HDR unbiased	300.84	302.09	1.25
4	20	HDR unbiased	302.74	303.96	1.22
5	20	HDR unbiased	302.66	303.11	0.445
6	20	HDR biased	302.42	303.72	1.306
7	20	HDR biased	303.15	305.34	2.191
8	20	HDR biased	303.49	306.33	2.848
9	20	HDR biased	302.89	305.77	2.881
10	20	HDR biased	301.49	306.08	4.585
11	30	HDR unbiased	302.3	303.6	1.303
12	30	HDR unbiased	303.45	305.15	1.698
13	30	HDR unbiased	303.27	305.72	2.45
14	30	HDR unbiased	301.12	304.02	2.893
15	30	HDR unbiased	300.75	303.41	2.66
16	30	HDR biased	303.33	300.53	-2.803
17	30	HDR biased	302.88	297.71	-5.168
18	30	HDR biased	302.55	298.71	-3.842
19	30	HDR biased	302.94	291.59	-11.348
20	30	HDR biased	300.78	295.68	-5.103
21	0	correlation	302.69	302.75	0.063
22	0	correlation	302.99	303.01	0.024
23	0	correlation	301.54	301.9	0.363
24	0	correlation	301.87	302.44	0.576
25	0	correlation	300.39	300.03	-0.362

TID vs Post - Pre Exposure Delta

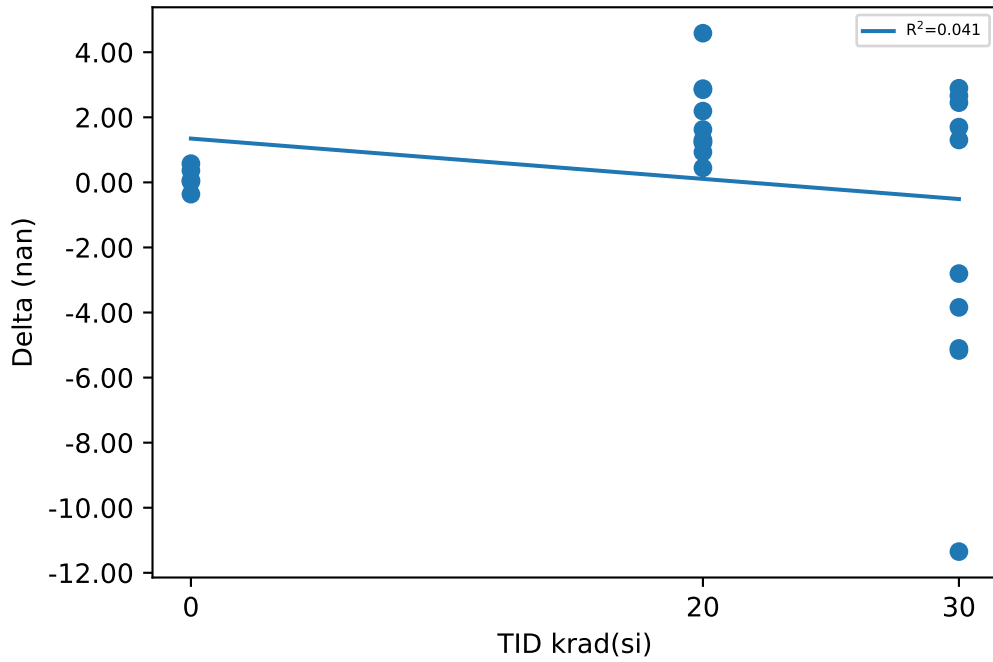

Test Statistics (nan)

krad(si)	Pre Exposure Min	Pre Exposure Avg	Pre Exposure Max	Pre Exposure Std	Post Exposure Min	Post Exposure Avg	Post Exposure Max	Post Exposure Std	Min Delta	Avg Delta	Max Delta	Std Delta
0	300.39	301.89	302.99	1.0253	300.03	302.03	303.01	1.1905	-0.362	0.1328	0.576	0.35741
20	300.84	302.52	303.49	0.78681	302.09	304.44	306.33	1.3877	0.445	1.9282	4.585	1.2255
30	300.75	302.34	303.45	1.0651	291.59	300.61	305.72	4.6294	-11.348	-1.726	2.893	4.7185

Device Test: 10.4 UJ74P3(dCSR_100mA_CH1_UJ74P3)

TID vs Result Stats

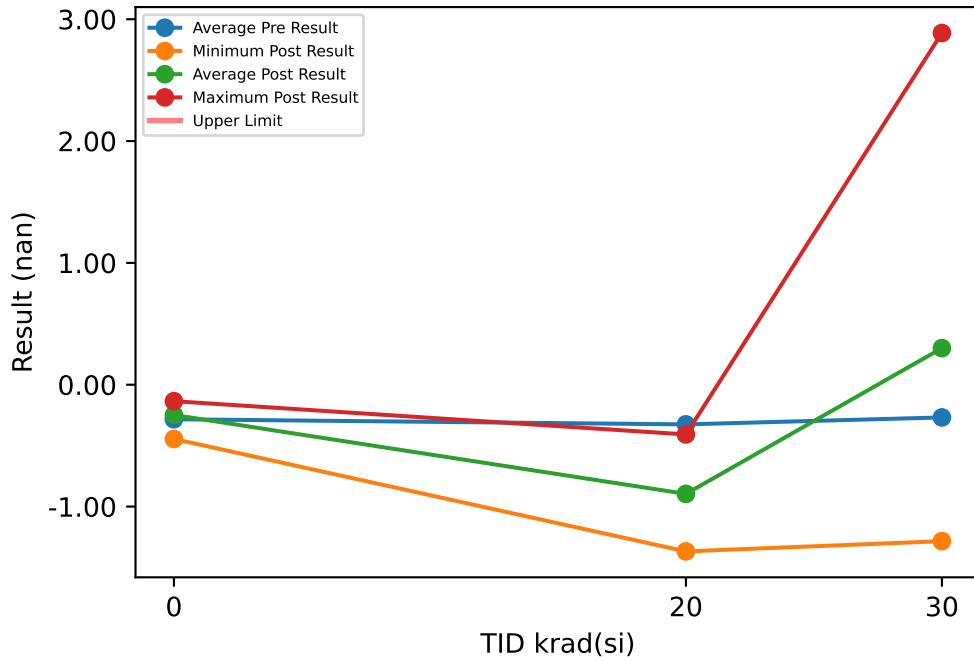

Test Results (No Limits Specified (nan))

Serial #	krad(si)	Exposure Conditions	Pre Result	Post Result	Delta
1	20	HDR unbiased	-0.353	-0.595	-0.242
2	20	HDR unbiased	-0.14	-0.408	-0.268
3	20	HDR unbiased	-0.378	-0.912	-0.534
4	20	HDR unbiased	-0.288	-0.925	-0.637
5	20	HDR unbiased	-0.233	-0.634	-0.401
6	20	HDR biased	-0.348	-0.923	-0.575
7	20	HDR biased	-0.402	-0.97	-0.568
8	20	HDR biased	-0.423	-1.003	-0.58
9	20	HDR biased	-0.544	-1.222	-0.678
10	20	HDR biased	-0.146	-1.368	-1.222
11	30	HDR unbiased	0.276	-0.11	-0.386
12	30	HDR unbiased	-0.823	-1.284	-0.461
13	30	HDR unbiased	-0.33	-0.933	-0.603
14	30	HDR unbiased	-0.244	-0.433	-0.189
15	30	HDR unbiased	-0.152	-1.063	-0.911
16	30	HDR biased	-0.229	1.237	1.466
17	30	HDR biased	-0.432	0.879	1.311
18	30	HDR biased	-0.159	0.778	0.937
19	30	HDR biased	-0.182	2.887	3.069
20	30	HDR biased	-0.409	1.045	1.454
21	0	correlation	-0.524	-0.445	0.079
22	0	correlation	-0.321	-0.312	0.009
23	0	correlation	-0.073	-0.135	-0.062
24	0	correlation	-0.277	-0.202	0.075
25	0	correlation	-0.222	-0.147	0.075

TID vs Post - Pre Exposure Delta

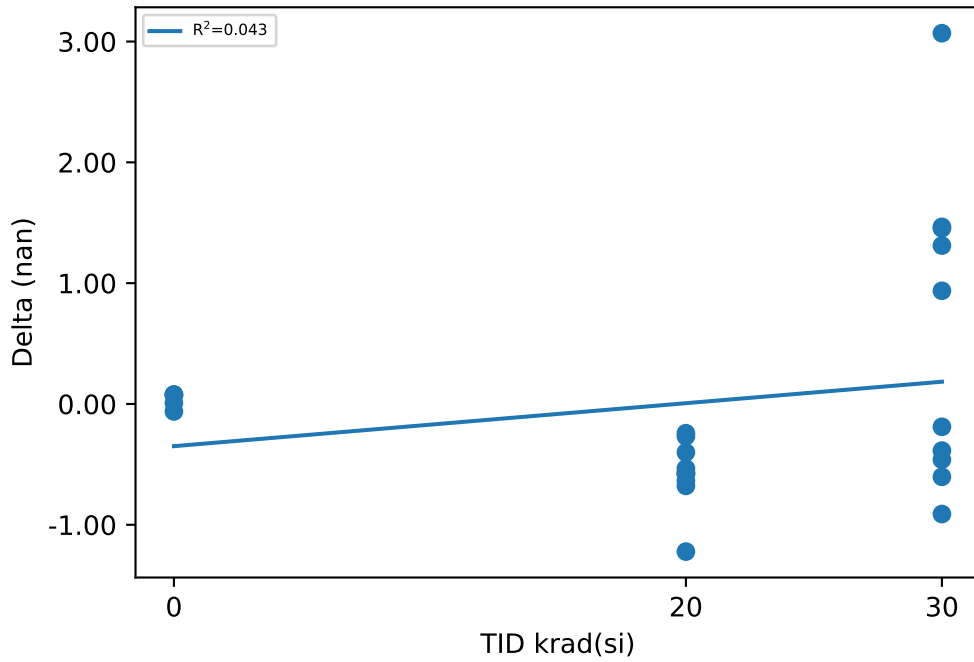

Test Statistics (nan)

krad(si)	Pre Exposure Min	Pre Exposure Avg	Pre Exposure Max	Pre Exposure Std	Post Exposure Min	Post Exposure Avg	Post Exposure Max	Post Exposure Std	Min Delta	Avg Delta	Max Delta	Std Delta
0	-0.524	-0.2834	-0.073	0.16385	-0.445	-0.2482	-0.135	0.13038	-0.062	0.0352	0.079	0.061686
20	-0.544	-0.3255	-0.14	0.12636	-1.368	-0.896	-0.408	0.28775	-1.222	-0.5705	-0.242	0.27285
30	-0.823	-0.2684	0.276	0.27677	-1.284	0.3003	2.887	1.3031	-0.911	0.5687	3.069	1.2752

Device Test: 10.41 UJXOZU(Kcs_250mA_CH3_UJXOZU)

TID vs Result Stats

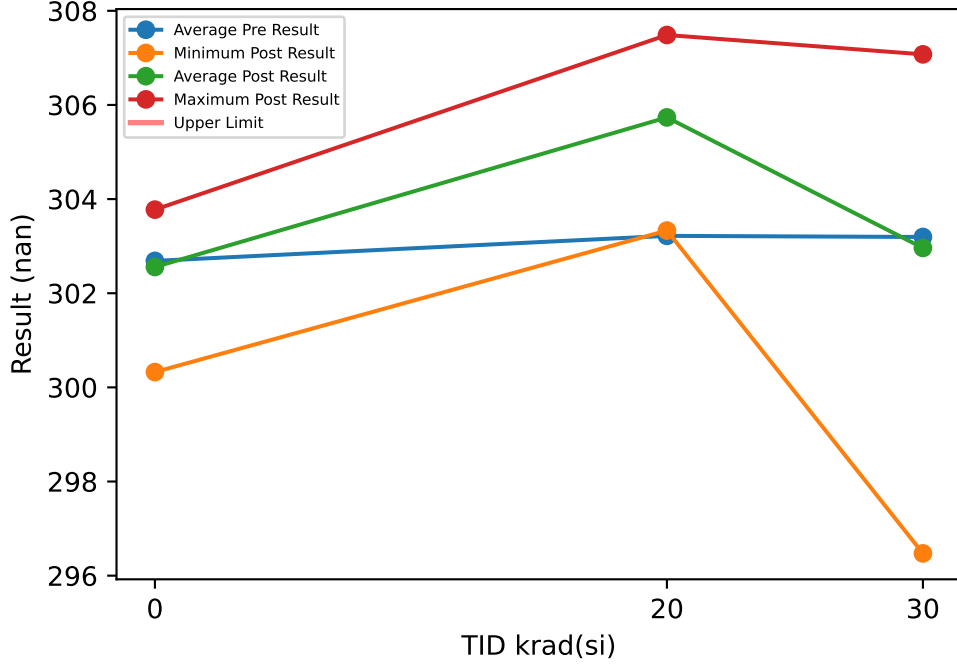

Test Results (No Limits Specified (nan))

Serial #	krad(si)	Exposure Conditions	Pre Result	Post Result	Delta
1	20	HDR unbiased	303.93	305.58	1.656
2	20	HDR unbiased	303.01	305.52	2.512
3	20	HDR unbiased	301.34	303.33	1.99
4	20	HDR unbiased	303.09	304.43	1.339
5	20	HDR unbiased	303.36	304.72	1.358
6	20	HDR biased	303.27	305.32	2.047
7	20	HDR biased	304.04	307.37	3.331
8	20	HDR biased	303.89	307.49	3.595
9	20	HDR biased	303.83	306.13	2.308
10	20	HDR biased	302.43	307.46	5.03
11	30	HDR unbiased	303.13	304.33	1.202
12	30	HDR unbiased	304.05	307.07	3.023
13	30	HDR unbiased	303.99	306.34	2.353
14	30	HDR unbiased	302.21	305.06	2.849
15	30	HDR unbiased	301.8	303.88	2.081
16	30	HDR biased	303.79	302.41	-1.384
17	30	HDR biased	304.07	302.64	-1.43
18	30	HDR biased	303.62	301.64	-1.98
19	30	HDR biased	303.69	296.47	-7.22
20	30	HDR biased	301.59	299.76	-1.826
21	0	correlation	302.93	303.78	0.85
22	0	correlation	303.4	303.45	0.044
23	0	correlation	302.45	302.27	-0.181
24	0	correlation	302.84	302.97	0.129
25	0	correlation	301.82	300.32	-1.491

TID vs Post - Pre Exposure Delta

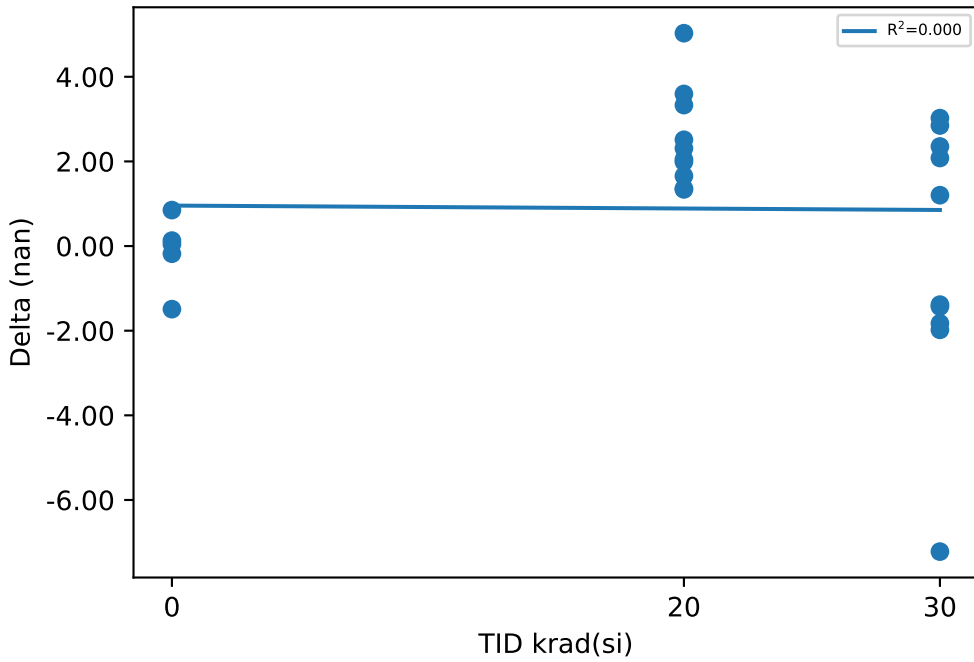

Test Statistics (nan)

krad(si)	Pre Exposure Min	Pre Exposure Avg	Pre Exposure Max	Pre Exposure Std	Post Exposure Min	Post Exposure Avg	Post Exposure Max	Post Exposure Std	Min Delta	Avg Delta	Max Delta	Std Delta
0	301.82	302.69	303.4	0.5932	300.32	302.56	303.78	1.3704	-1.491	-0.1298	0.85	0.85333
20	301.34	303.22	304.04	0.8318	303.33	305.74	307.49	1.3984	1.339	2.5166	5.03	1.1621
30	301.59	303.2	304.07	0.96671	296.47	302.96	307.07	3.1619	-7.22	-0.2332	3.023	3.1862

Device Test: 10.42 UJXOZU(Kcs_500mA_CH3_UJXOZU)

TID vs Result Stats

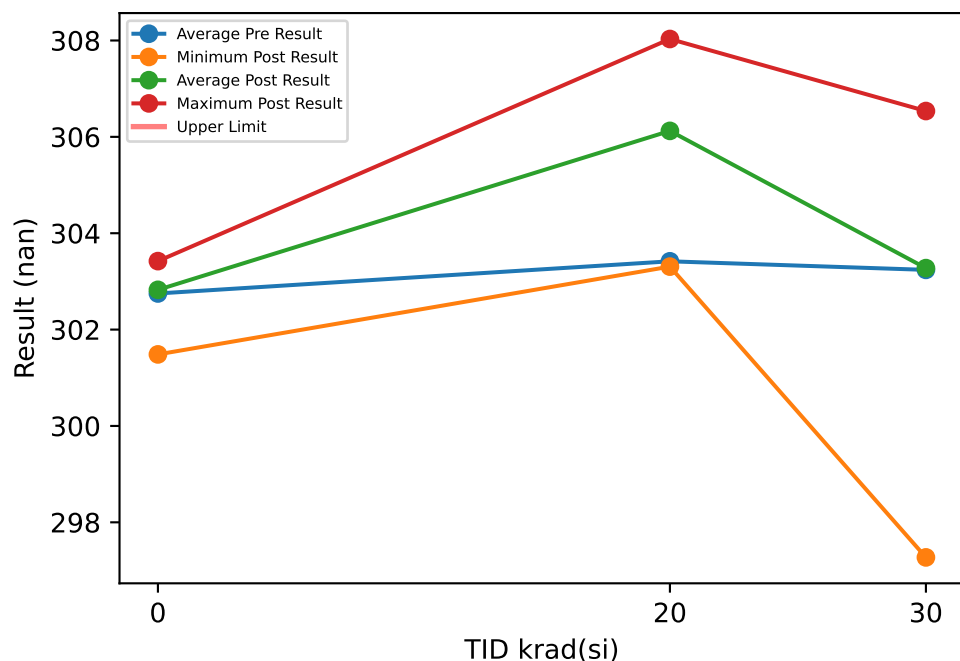

Test Results (No Limits Specified (nan))

Serial #	krad(si)	Exposure Conditions	Pre Result	Post Result	Delta
1	20	HDR unbiased	304.04	305.57	1.528
2	20	HDR unbiased	303.69	305.33	1.646
3	20	HDR unbiased	301.44	303.31	1.864
4	20	HDR unbiased	303.06	304.88	1.825
5	20	HDR unbiased	303.58	305	1.417
6	20	HDR biased	303.19	306.55	3.359
7	20	HDR biased	304.2	307.61	3.409
8	20	HDR biased	304.16	307.98	3.822
9	20	HDR biased	304.02	306.97	2.942
10	20	HDR biased	302.78	308.03	5.255
11	30	HDR unbiased	303.67	305	1.339
12	30	HDR unbiased	304.02	306.54	2.517
13	30	HDR unbiased	304.21	306.33	2.118
14	30	HDR unbiased	301.82	304.91	3.094
15	30	HDR unbiased	301.8	304.17	2.375
16	30	HDR biased	303.98	303.22	-0.762
17	30	HDR biased	304.31	302.51	-1.804
18	30	HDR biased	303.55	302.64	-0.916
19	30	HDR biased	303.53	297.27	-6.262
20	30	HDR biased	301.5	300.16	-1.338
21	0	correlation	303.57	303.42	-0.146
22	0	correlation	303.43	303.34	-0.088
23	0	correlation	302.56	302.73	0.169
24	0	correlation	303.07	303.15	0.081
25	0	correlation	301.12	301.49	0.361

TID vs Post - Pre Exposure Delta

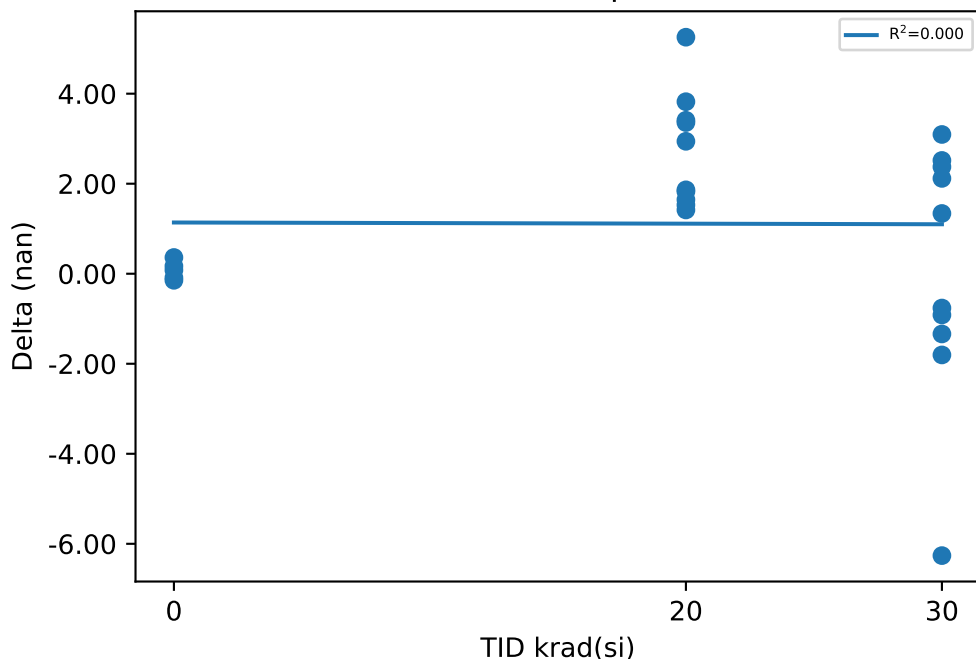

Test Statistics (nan)

krad(si)	Pre Exposure Min	Pre Exposure Avg	Pre Exposure Max	Pre Exposure Std	Post Exposure Min	Post Exposure Avg	Post Exposure Max	Post Exposure Std	Min Delta	Avg Delta	Max Delta	Std Delta
0	301.12	302.75	303.57	0.98868	301.49	302.82	303.42	0.79557	-0.146	0.0754	0.361	0.20376
20	301.44	303.42	304.2	0.85097	303.31	306.12	308.03	1.5586	1.417	2.7067	5.255	1.2639
30	301.5	303.24	304.31	1.0932	297.27	303.28	306.54	2.8512	-6.262	0.0361	3.094	2.8576

Device Test: 10.43 UJXOZU(Kcs_5mA_CH4_UJXOZU)

TID vs Result Stats

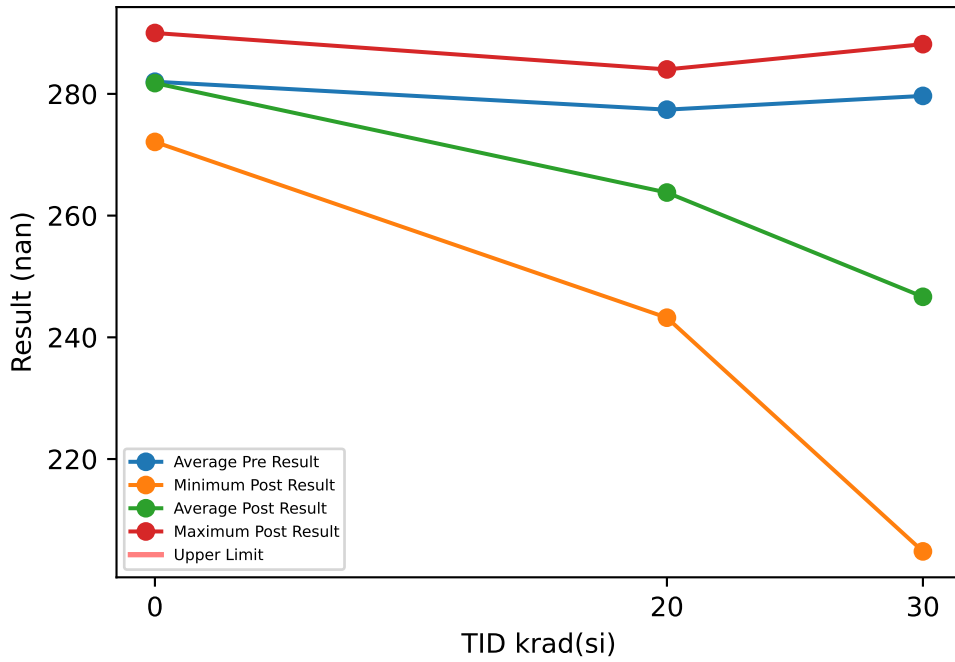

Test Results (No Limits Specified (nan))

Serial #	krad(si)	Exposure Conditions	Pre Result	Post Result	Delta
1	20	HDR unbiased	281	274.06	-6.934
2	20	HDR unbiased	280.29	276.08	-4.214
3	20	HDR unbiased	272.19	280.94	8.752
4	20	HDR unbiased	274.15	284.02	9.868
5	20	HDR unbiased	274.28	274.52	0.235
6	20	HDR biased	282.81	251.38	-31.422
7	20	HDR biased	274.72	246.54	-28.178
8	20	HDR biased	274.67	243.22	-31.445
9	20	HDR biased	277.16	254.35	-22.808
10	20	HDR biased	282.82	252.78	-30.041
11	30	HDR unbiased	281.87	275.59	-6.273
12	30	HDR unbiased	276.4	277.78	1.38
13	30	HDR unbiased	270.99	272.2	1.218
14	30	HDR unbiased	278.48	270.33	-8.158
15	30	HDR unbiased	286.29	288.17	1.878
16	30	HDR biased	281.62	221.47	-60.154
17	30	HDR biased	277.8	219.62	-58.181
18	30	HDR biased	277.01	229.73	-47.277
19	30	HDR biased	281.03	204.82	-76.203
20	30	HDR biased	285.19	206.85	-78.34
21	0	correlation	279.12	287.67	8.553
22	0	correlation	289.22	290	0.789
23	0	correlation	273.53	272.11	-1.421
24	0	correlation	290.02	278.41	-11.611
25	0	correlation	278.12	280.66	2.544

TID vs Post - Pre Exposure Delta

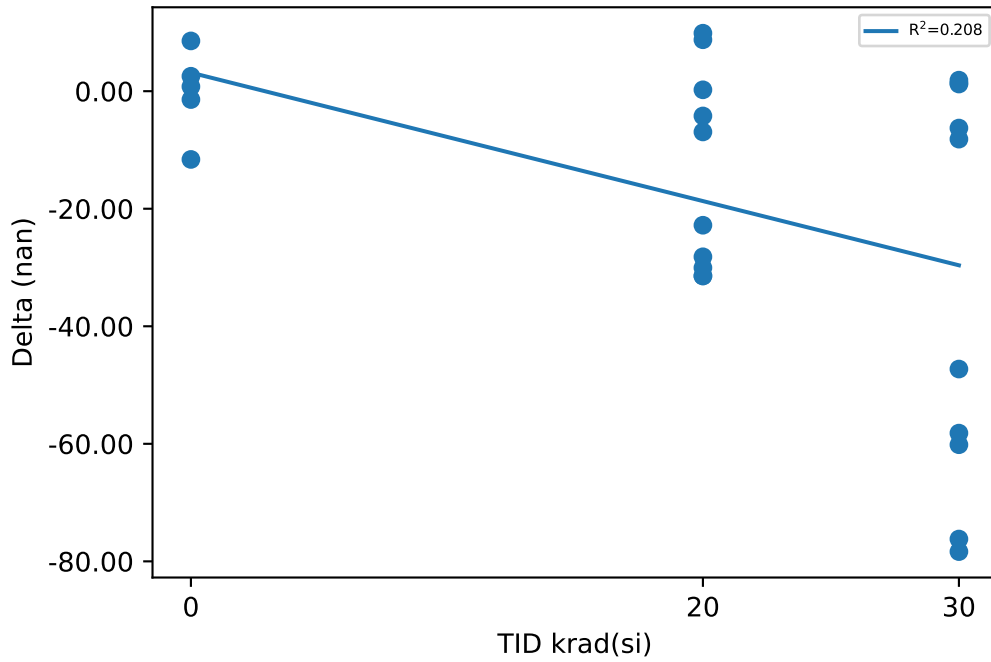

Test Statistics (nan)

krad(si)	Pre Exposure Min	Pre Exposure Avg	Pre Exposure Max	Pre Exposure Std	Post Exposure Min	Post Exposure Avg	Post Exposure Max	Post Exposure Std	Min Delta	Avg Delta	Max Delta	Std Delta
0	273.53	282	290.02	7.2727	272.11	281.77	290	7.2204	-11.611	-0.2292	8.553	7.3624
20	272.19	277.41	282.82	3.9722	243.22	263.79	284.02	15.49	-31.445	-13.619	9.868	16.925
30	270.99	279.67	286.29	4.5068	204.82	246.66	288.17	32.878	-78.34	-33.011	1.878	33.991

Device Test: 10.44 UJXOZU(Kcs_25mA_CH4_UJXOZU)

TID vs Result Stats

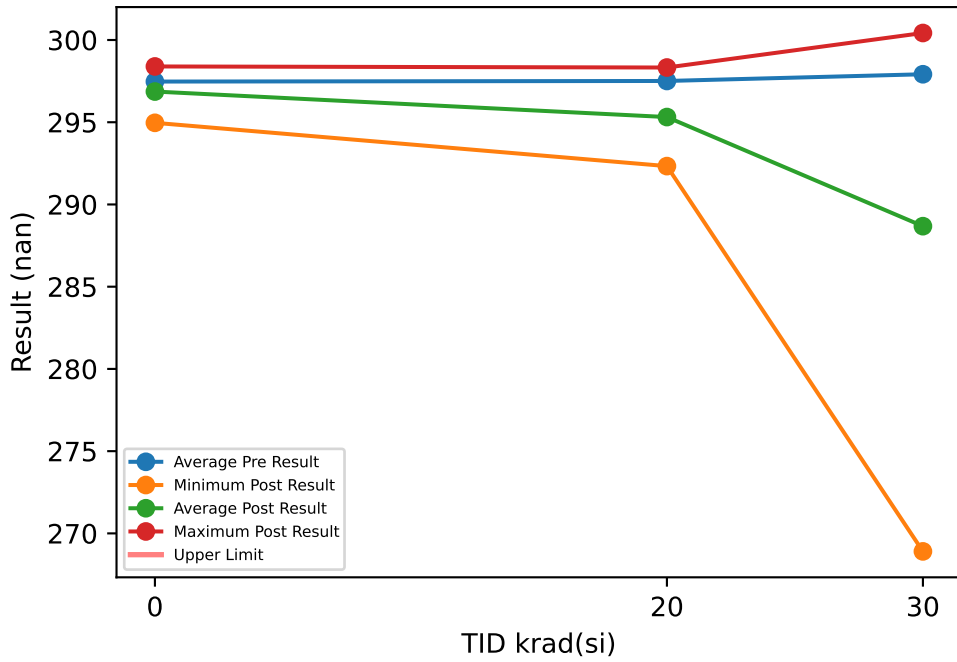

Test Results (No Limits Specified (nan))

Serial #	krad(si)	Exposure Conditions	Pre Result	Post Result	Delta
1	20	HDR unbiased	297.31	297.32	0.008
2	20	HDR unbiased	297	298.01	1.017
3	20	HDR unbiased	297.94	298.33	0.384
4	20	HDR unbiased	297.65	297.72	0.072
5	20	HDR unbiased	297.64	296.78	-0.856
6	20	HDR biased	295.95	292.33	-3.615
7	20	HDR biased	297.91	292.44	-5.473
8	20	HDR biased	299.88	293.22	-6.662
9	20	HDR biased	297.94	293.95	-3.991
10	20	HDR biased	295.86	293.04	-2.819
11	30	HDR unbiased	298.89	297.29	-1.609
12	30	HDR unbiased	298.17	295.5	-2.669
13	30	HDR unbiased	299.56	300.43	0.87
14	30	HDR unbiased	294.77	296.23	1.458
15	30	HDR unbiased	300	299.84	-0.159
16	30	HDR biased	300.46	279.58	-20.881
17	30	HDR biased	297.68	280.21	-17.472
18	30	HDR biased	297.66	286.71	-10.956
19	30	HDR biased	295.53	268.9	-26.625
20	30	HDR biased	296.46	282.13	-14.331
21	0	correlation	297.49	298.39	0.9
22	0	correlation	300.56	298.18	-2.386
23	0	correlation	297	296	-0.998
24	0	correlation	296.45	296.8	0.348
25	0	correlation	295.86	294.96	-0.898

TID vs Post - Pre Exposure Delta

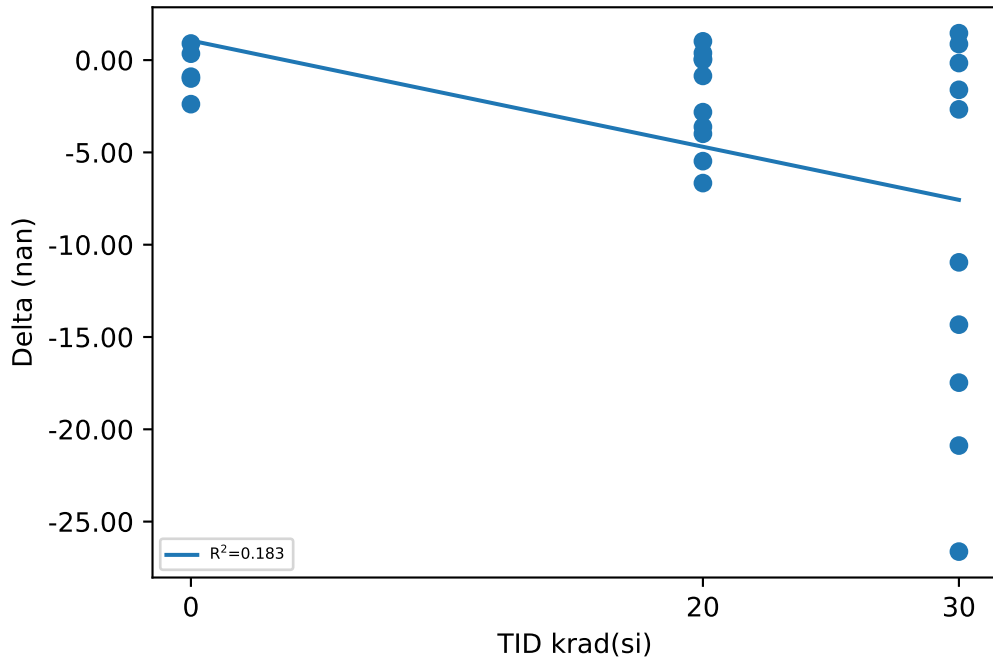

Test Statistics (nan)

krad(si)	Pre Exposure Min	Pre Exposure Avg	Pre Exposure Max	Pre Exposure Std	Post Exposure Min	Post Exposure Avg	Post Exposure Max	Post Exposure Std	Min Delta	Avg Delta	Max Delta	Std Delta
0	295.86	297.47	300.56	1.8306	294.96	296.87	298.39	1.4498	-2.386	-0.6068	0.9	1.2831
20	295.86	297.51	299.88	1.1387	292.33	295.32	298.33	2.5149	-6.662	-2.1935	1.017	2.6892
30	294.77	297.92	300.46	1.8946	268.9	288.68	300.43	10.711	-26.625	-9.2374	1.458	10.192

Device Test: 10.45 UJXOZU(Kcs_50mA_CH4_UJXOZU)

TID vs Result Stats

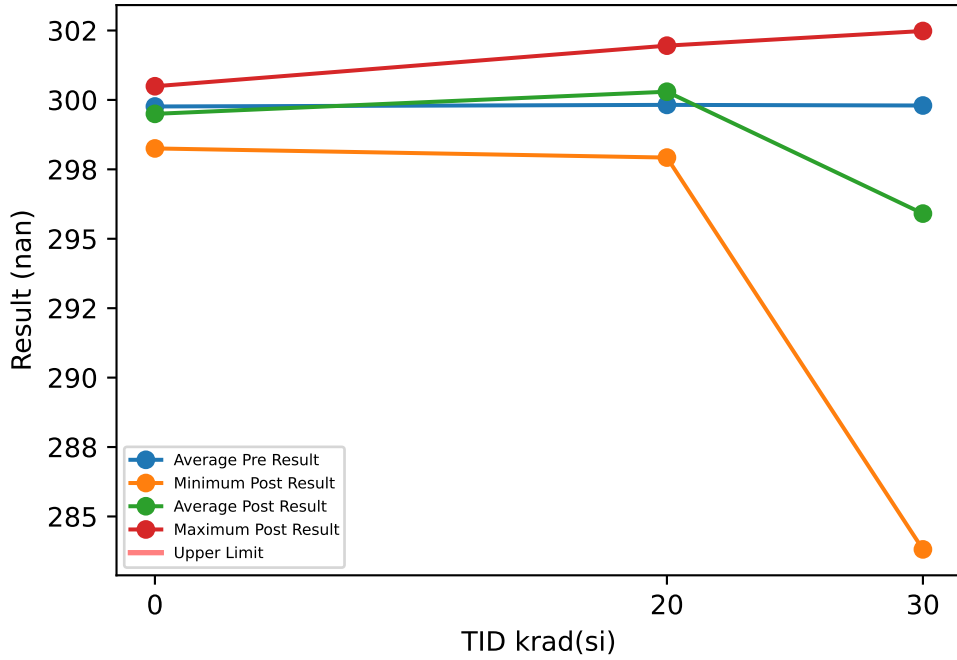

Test Results (No Limits Specified (nan))

Serial #	krad(si)	Exposure Conditions	Pre Result	Post Result	Delta
1	20	HDR unbiased	298.53	300.33	1.804
2	20	HDR unbiased	299.92	300.64	0.723
3	20	HDR unbiased	300.2	301.95	1.754
4	20	HDR unbiased	300.34	301.38	1.039
5	20	HDR unbiased	299.59	299.53	-0.058
6	20	HDR biased	299.17	300.8	1.634
7	20	HDR biased	300.53	297.92	-2.609
8	20	HDR biased	300.19	300.06	-0.128
9	20	HDR biased	300.15	300.57	0.422
10	20	HDR biased	299.6	299.76	0.163
11	30	HDR unbiased	300.29	300.2	-0.091
12	30	HDR unbiased	299.98	302.18	2.201
13	30	HDR unbiased	300.38	302.34	1.961
14	30	HDR unbiased	298.53	299.68	1.156
15	30	HDR unbiased	300.69	302.48	1.789
16	30	HDR biased	301.24	291.72	-9.512
17	30	HDR biased	299.54	291.48	-8.065
18	30	HDR biased	300.52	294.08	-6.437
19	30	HDR biased	298.29	283.81	-14.48
20	30	HDR biased	298.53	291.08	-7.447
21	0	correlation	300.21	299.98	-0.229
22	0	correlation	300.62	300.49	-0.127
23	0	correlation	300.23	299.3	-0.931
24	0	correlation	299.64	299.47	-0.174
25	0	correlation	298.12	298.25	0.131

TID vs Post - Pre Exposure Delta

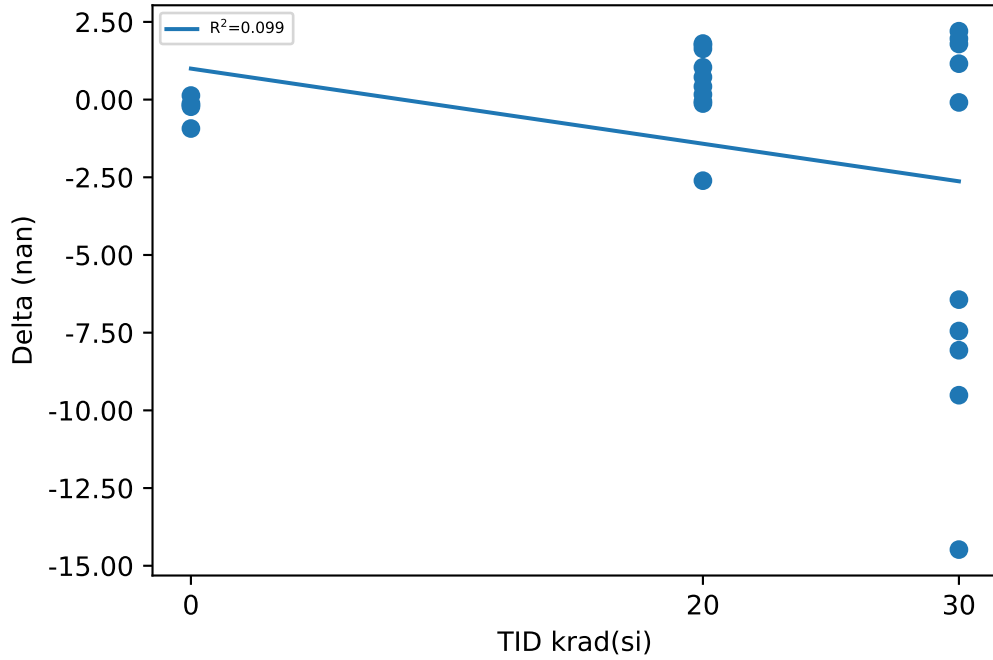

Test Statistics (nan)

krad(si)	Pre Exposure Min	Pre Exposure Avg	Pre Exposure Max	Pre Exposure Std	Post Exposure Min	Post Exposure Avg	Post Exposure Max	Post Exposure Std	Min Delta	Avg Delta	Max Delta	Std Delta
0	298.12	299.76	300.62	0.98188	298.25	299.5	300.49	0.83814	-0.931	-0.266	0.131	0.39654
20	298.53	299.82	300.53	0.61242	297.92	300.3	301.95	1.1018	-2.609	0.4744	1.804	1.3074
30	298.29	299.8	301.24	1.0298	283.81	295.91	302.48	6.3824	-14.48	-3.8925	2.201	5.9982

Device Test: 10.46 UJXOZU(Kcs_100mA_CH4_UJXOZU)

TID vs Result Stats

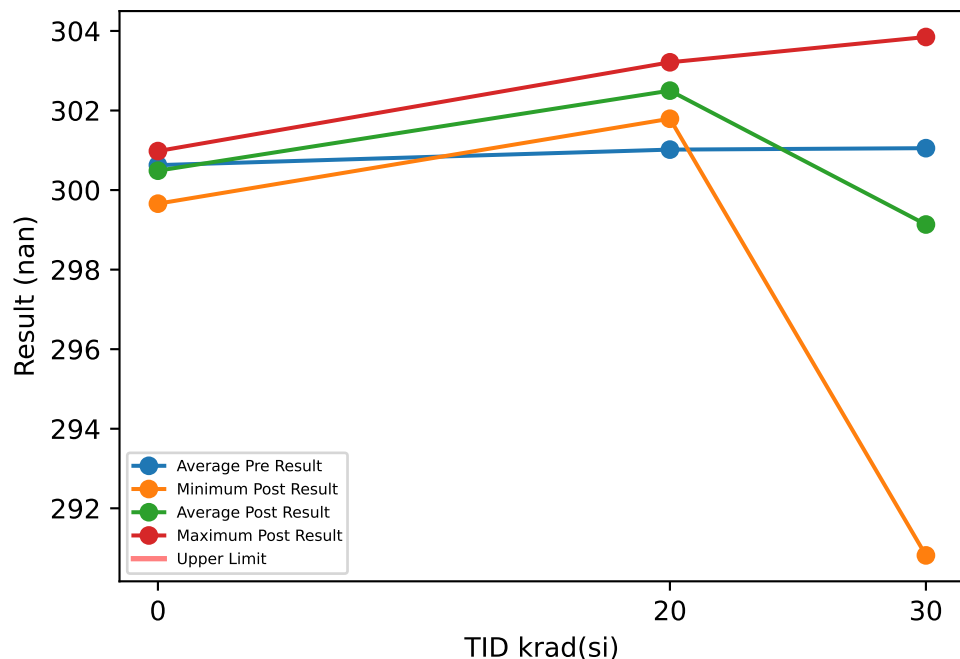

Test Results (No Limits Specified (nan))

Serial #	krad(si)	Exposure Conditions	Pre Result	Post Result	Delta
1	20	HDR unbiased	300.44	301.86	1.418
2	20	HDR unbiased	300.82	302.73	1.913
3	20	HDR unbiased	301.44	303.21	1.776
4	20	HDR unbiased	301.08	302.14	1.066
5	20	HDR unbiased	300.23	301.79	1.561
6	20	HDR biased	300.12	301.93	1.807
7	20	HDR biased	301.53	303.11	1.573
8	20	HDR biased	301.8	302.5	0.694
9	20	HDR biased	302.15	303.12	0.973
10	20	HDR biased	300.56	302.6	2.044
11	30	HDR unbiased	300.93	301.82	0.893
12	30	HDR unbiased	300.85	303.85	2.998
13	30	HDR unbiased	302.15	302.98	0.832
14	30	HDR unbiased	300.12	300.86	0.74
15	30	HDR unbiased	302.2	303.75	1.548
16	30	HDR biased	301.65	296.69	-4.962
17	30	HDR biased	300.79	296.04	-4.755
18	30	HDR biased	301.62	298.2	-3.413
19	30	HDR biased	299.53	290.82	-8.716
20	30	HDR biased	300.69	296.34	-4.353
21	0	correlation	300.91	300.49	-0.418
22	0	correlation	301.12	300.98	-0.143
23	0	correlation	300.95	300.67	-0.282
24	0	correlation	300.46	300.64	0.181
25	0	correlation	299.69	299.66	-0.036

TID vs Post - Pre Exposure Delta

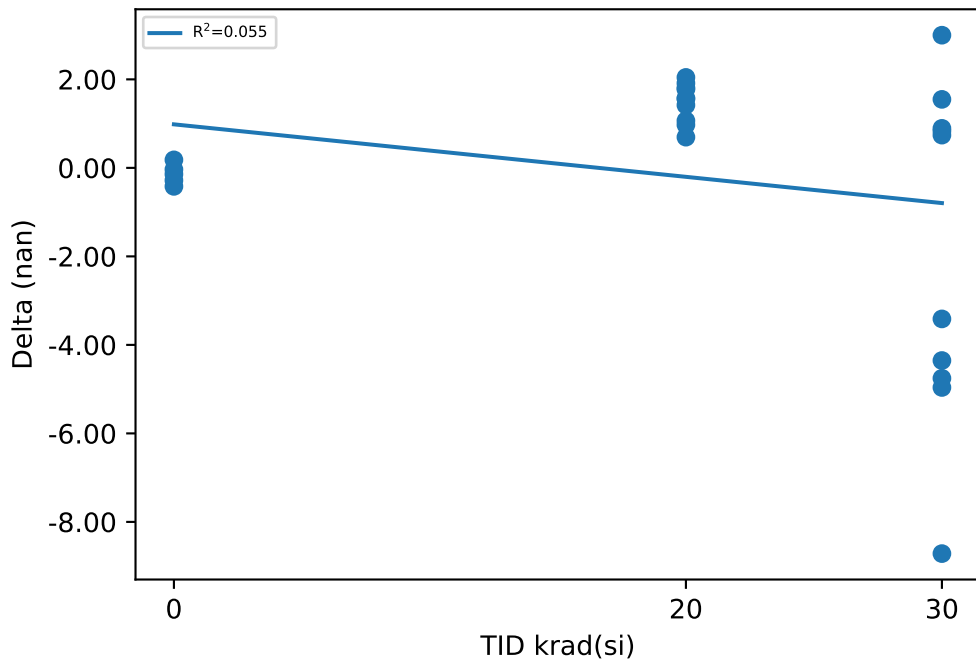

Test Statistics (nan)

krad(si)	Pre Exposure Min	Pre Exposure Avg	Pre Exposure Max	Pre Exposure Std	Post Exposure Min	Post Exposure Avg	Post Exposure Max	Post Exposure Std	Min Delta	Avg Delta	Max Delta	Std Delta
0	299.69	300.63	301.12	0.57629	299.66	300.49	300.98	0.49662	-0.418	-0.1396	0.181	0.22984
20	300.12	301.02	302.15	0.69404	301.79	302.5	303.21	0.54665	0.694	1.4825	2.044	0.44289
30	299.53	301.05	302.2	0.85764	290.82	299.13	303.85	4.2421	-8.716	-1.9188	2.998	3.8064

Device Test: 10.47 UJXOZU(Kcs_250mA_CH4_UJXOZU)

TID vs Result Stats

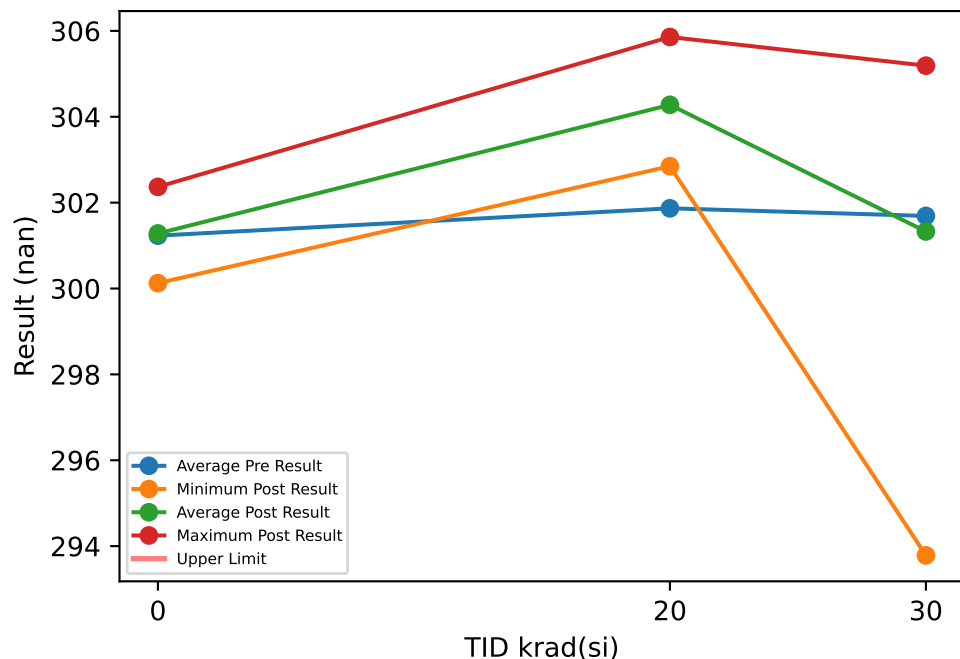

Test Results (No Limits Specified (nan))

Serial #	krad(si)	Exposure Conditions	Pre Result	Post Result	Delta
1	20	HDR unbiased	301.42	303.41	1.986
2	20	HDR unbiased	301.69	303.45	1.759
3	20	HDR unbiased	302.27	304	1.729
4	20	HDR unbiased	301.28	303.74	2.461
5	20	HDR unbiased	301.61	302.85	1.237
6	20	HDR biased	301.18	303.77	2.587
7	20	HDR biased	302.89	305.45	2.568
8	20	HDR biased	302.09	305.86	3.766
9	20	HDR biased	302.99	305.36	2.366
10	20	HDR biased	301.27	304.91	3.643
11	30	HDR unbiased	301.71	303.1	1.388
12	30	HDR unbiased	302.12	304.54	2.426
13	30	HDR unbiased	302.1	304.57	2.474
14	30	HDR unbiased	300.81	302.04	1.226
15	30	HDR unbiased	303.04	305.19	2.154
16	30	HDR biased	302.51	300.64	-1.875
17	30	HDR biased	301.24	299.19	-2.048
18	30	HDR biased	301.92	300.57	-1.349
19	30	HDR biased	300.19	293.78	-6.401
20	30	HDR biased	301.27	299.65	-1.619
21	0	correlation	301.89	301.27	-0.618
22	0	correlation	301.75	302.37	0.622
23	0	correlation	301.3	301.35	0.048
24	0	correlation	301.12	301.3	0.176
25	0	correlation	300.1	300.12	0.027

TID vs Post - Pre Exposure Delta

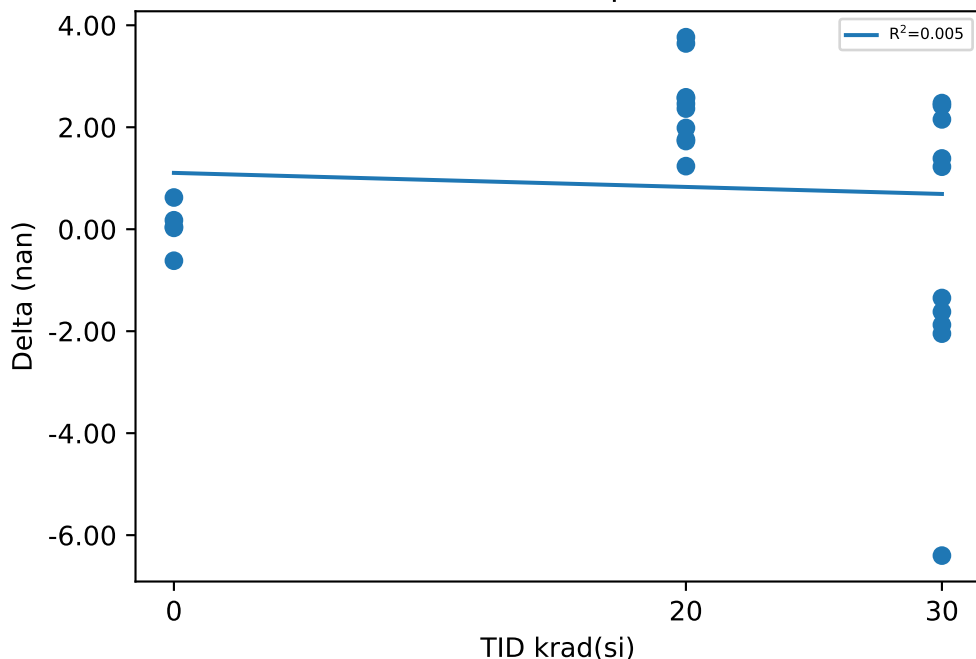

Test Statistics (nan)

krad(si)	Pre Exposure Min	Pre Exposure Avg	Pre Exposure Max	Pre Exposure Std	Post Exposure Min	Post Exposure Avg	Post Exposure Max	Post Exposure Std	Min Delta	Avg Delta	Max Delta	Std Delta
0	300.1	301.23	301.89	0.7063	300.12	301.28	302.37	0.79391	-0.618	0.051	0.622	0.44436
20	301.18	301.87	302.99	0.66615	302.85	304.28	305.86	1.0311	1.237	2.4102	3.766	0.80713
30	300.19	301.69	303.04	0.83693	293.78	301.33	305.19	3.4118	-6.401	-0.3624	2.474	2.8262

Device Test: 10.48 UJXOZU(Kcs_500mA_CH4_UJXOZU)

TID vs Result Stats

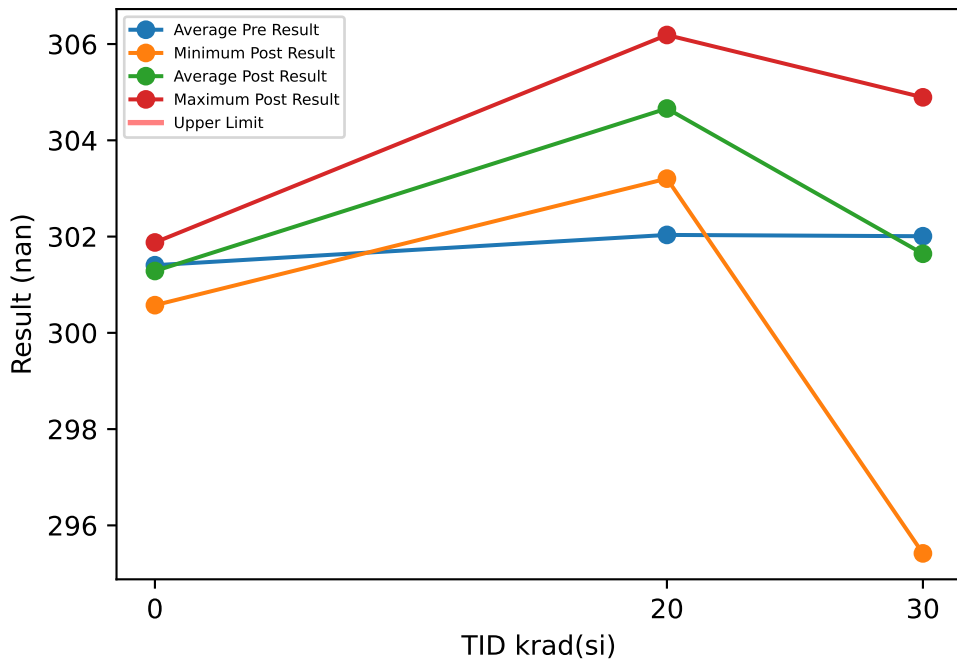

Test Results (No Limits Specified (nan))

Serial #	krad(si)	Exposure Conditions	Pre Result	Post Result	Delta
1	20	HDR unbiased	302.07	303.72	1.648
2	20	HDR unbiased	302.07	303.89	1.821
3	20	HDR unbiased	302.44	304.68	2.244
4	20	HDR unbiased	301.45	303.2	1.758
5	20	HDR unbiased	301.62	303.35	1.731
6	20	HDR biased	301.07	305.06	3.985
7	20	HDR biased	302.73	306.19	3.454
8	20	HDR biased	302.49	305.57	3.078
9	20	HDR biased	302.86	305.97	3.113
10	20	HDR biased	301.55	304.99	3.432
11	30	HDR unbiased	301.82	302.58	0.755
12	30	HDR unbiased	302.11	304.89	2.78
13	30	HDR unbiased	302.56	304.54	1.976
14	30	HDR unbiased	301.42	301.88	0.454
15	30	HDR unbiased	303.25	304.47	1.217
16	30	HDR biased	302.75	300.79	-1.959
17	30	HDR biased	302.01	300.84	-1.17
18	30	HDR biased	302.13	300.3	-1.836
19	30	HDR biased	300.37	295.42	-4.949
20	30	HDR biased	301.64	300.73	-0.912
21	0	correlation	301.56	301.41	-0.144
22	0	correlation	301.82	301.88	0.054
23	0	correlation	301.64	301.7	0.063
24	0	correlation	301.26	300.85	-0.409
25	0	correlation	300.74	300.57	-0.166

TID vs Post - Pre Exposure Delta

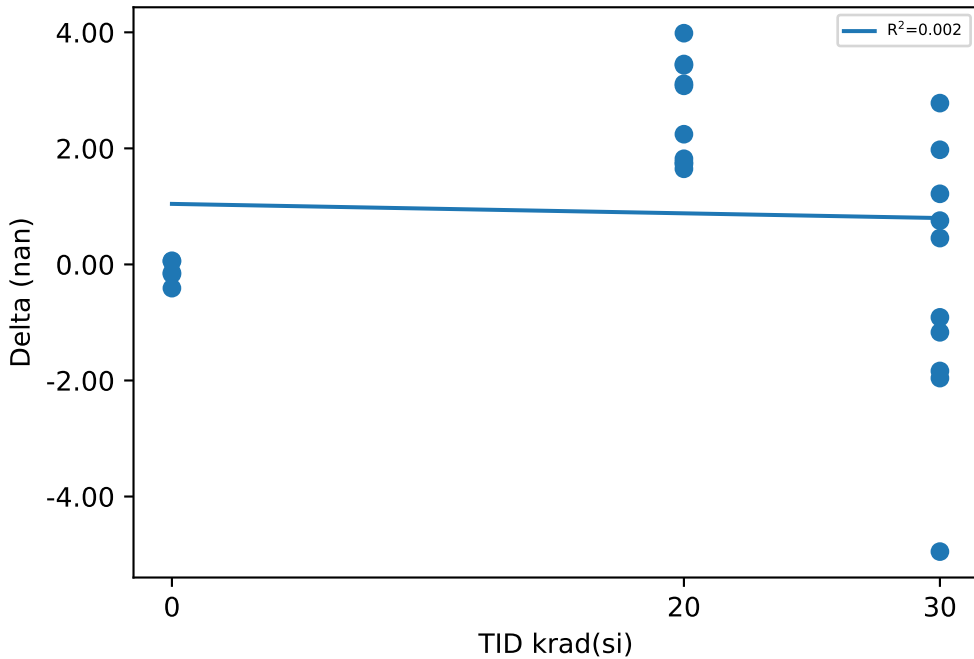

Test Statistics (nan)

krad(si)	Pre Exposure Min	Pre Exposure Avg	Pre Exposure Max	Pre Exposure Std	Post Exposure Min	Post Exposure Avg	Post Exposure Max	Post Exposure Std	Min Delta	Avg Delta	Max Delta	Std Delta
0	300.74	301.41	301.82	0.42331	300.57	301.28	301.88	0.55594	-0.409	-0.1204	0.063	0.19363
20	301.07	302.03	302.86	0.59782	303.2	304.66	306.19	1.0777	1.648	2.6264	3.985	0.8774
30	300.37	302.01	303.25	0.79212	295.42	301.64	304.89	2.802	-4.949	-0.3644	2.78	2.2722

Device Test: 10.6 UJA0RR(dCSR_500mA_CH1_UJA0RR)

TID vs Result Stats

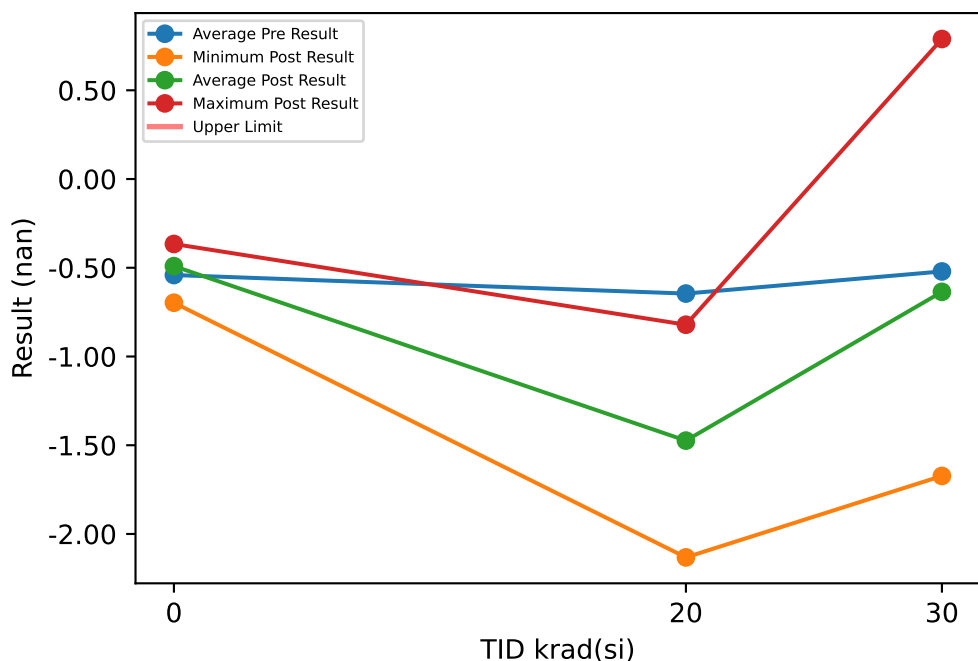

Test Results (No Limits Specified (nan))

Serial #	krad(si)	Exposure Conditions	Pre Result	Post Result	Delta
1	20	HDR unbiased	-0.614	-1.08	-0.466
2	20	HDR unbiased	-0.351	-0.821	-0.47
3	20	HDR unbiased	-0.702	-1.373	-0.671
4	20	HDR unbiased	-0.635	-1.162	-0.527
5	20	HDR unbiased	-0.541	-1.001	-0.46
6	20	HDR biased	-0.62	-1.864	-1.244
7	20	HDR biased	-0.723	-1.607	-0.884
8	20	HDR biased	-0.83	-1.851	-1.021
9	20	HDR biased	-0.82	-1.849	-1.029
10	20	HDR biased	-0.618	-2.132	-1.514
11	30	HDR unbiased	-0.077	-0.4	-0.323
12	30	HDR unbiased	-0.894	-1.673	-0.779
13	30	HDR unbiased	-0.529	-1.263	-0.734
14	30	HDR unbiased	-0.601	-0.888	-0.287
15	30	HDR unbiased	-0.526	-1.288	-0.762
16	30	HDR biased	-0.554	-0.426	0.128
17	30	HDR biased	-0.616	-0.34	0.276
18	30	HDR biased	-0.461	-0.45	0.011
19	30	HDR biased	-0.357	0.789	1.146
20	30	HDR biased	-0.593	-0.419	0.174
21	0	correlation	-0.792	-0.697	0.095
22	0	correlation	-0.566	-0.481	0.085
23	0	correlation	-0.513	-0.455	0.058
24	0	correlation	-0.428	-0.366	0.062
25	0	correlation	-0.406	-0.455	-0.049

TID vs Post - Pre Exposure Delta

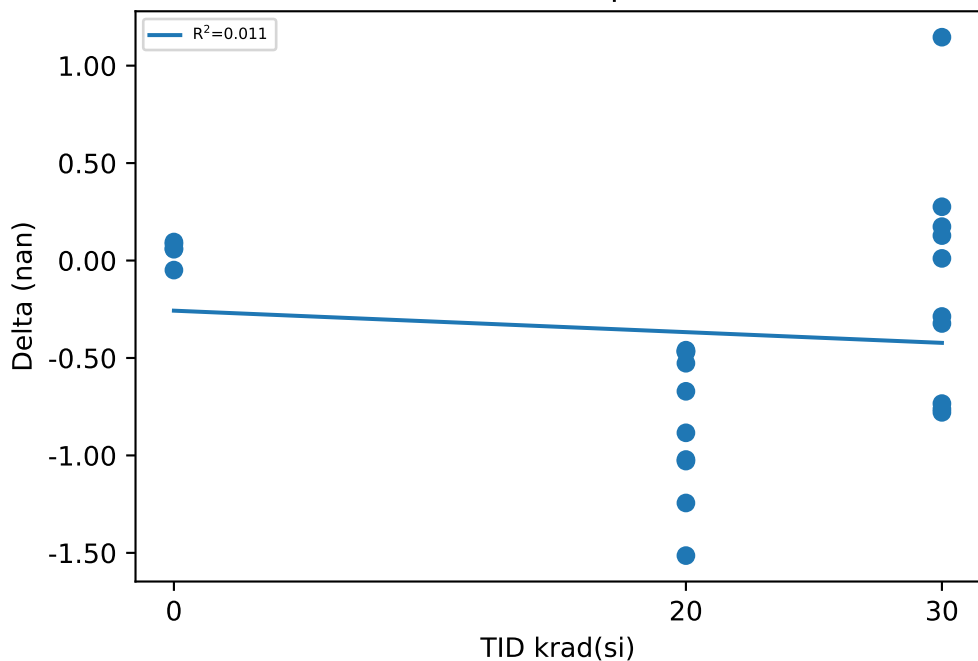

Test Statistics (nan)

krad(si)	Pre Exposure Min	Pre Exposure Avg	Pre Exposure Max	Pre Exposure Std	Post Exposure Min	Post Exposure Avg	Post Exposure Max	Post Exposure Std	Min Delta	Avg Delta	Max Delta	Std Delta
0	-0.792	-0.541	-0.406	0.15444	-0.697	-0.4908	-0.366	0.12324	-0.049	0.0502	0.095	0.057573
20	-0.83	-0.6454	-0.351	0.13898	-2.132	-1.474	-0.821	0.44702	-1.514	-0.8286	-0.46	0.37033
30	-0.894	-0.5208	-0.077	0.20778	-1.673	-0.6358	0.789	0.68774	-0.779	-0.115	1.146	0.59786

Device Test: 10.7 UJR405(dCSR_5mA_CH2_UJR405)

TID vs Result Stats

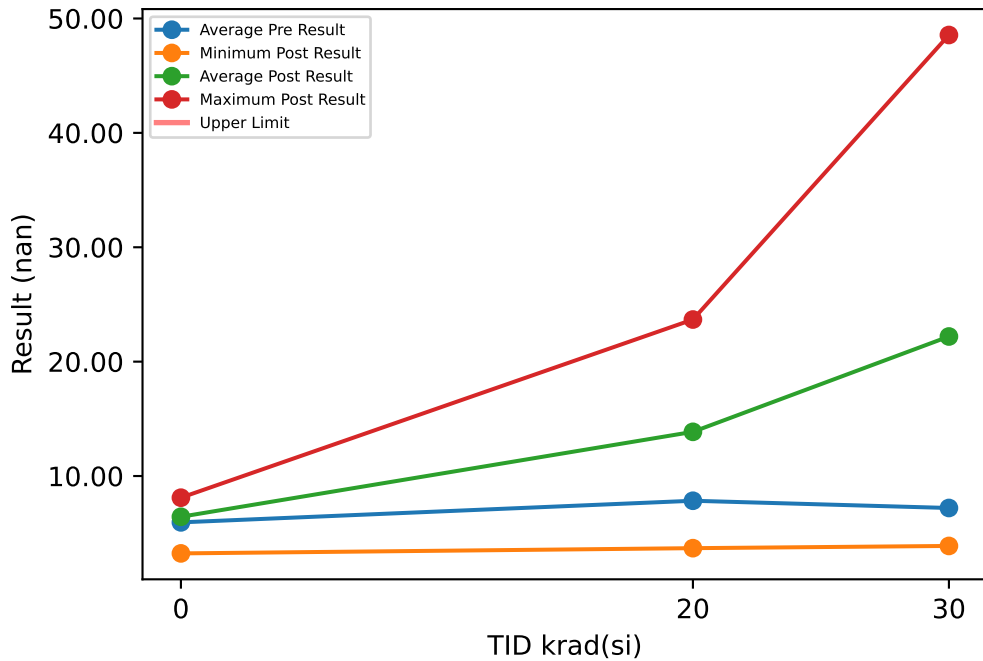

Test Results (No Limits Specified (nan))

Serial #	krad(si)	Exposure Conditions	Pre Result	Post Result	Delta
1	20	HDR unbiased	10.144	10.302	0.158
2	20	HDR unbiased	10.321	9.873	-0.448
3	20	HDR unbiased	6.116	10.406	4.29
4	20	HDR unbiased	6.617	3.693	-2.924
5	20	HDR unbiased	6.225	6.979	0.754
6	20	HDR biased	6.678	18.596	11.918
7	20	HDR biased	9.204	23.682	14.478
8	20	HDR biased	3.734	18.842	15.108
9	20	HDR biased	9.662	19.845	10.183
10	20	HDR biased	9.682	16.414	6.732
11	30	HDR unbiased	4.963	7.87	2.907
12	30	HDR unbiased	8.406	8.867	0.461
13	30	HDR unbiased	4.887	8.774	3.887
14	30	HDR unbiased	10.634	6.316	-4.318
15	30	HDR unbiased	1.888	3.887	1.999
16	30	HDR biased	10.609	36.037	25.428
17	30	HDR biased	9.597	39.534	29.937
18	30	HDR biased	6.187	31.746	25.559
19	30	HDR biased	9.044	48.557	39.513
20	30	HDR biased	5.847	30.399	24.552
21	0	correlation	8.675	7.661	-1.014
22	0	correlation	4.818	3.236	-1.582
23	0	correlation	6.159	6.71	0.551
24	0	correlation	4.319	8.106	3.787
25	0	correlation	5.774	6.481	0.707

TID vs Post - Pre Exposure Delta

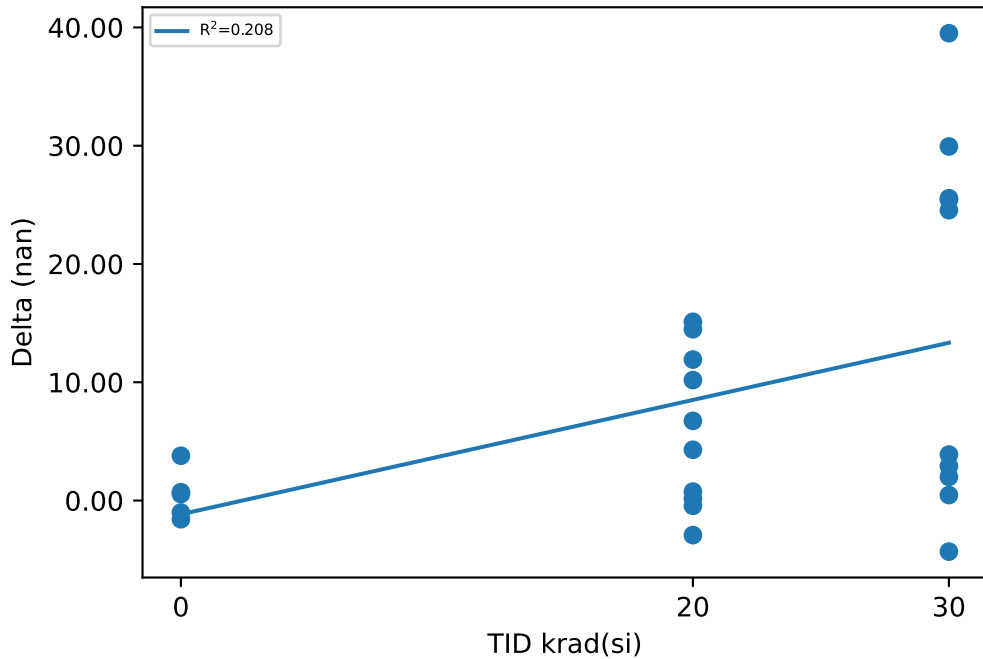

Test Statistics (nan)

krad(si)	Pre Exposure Min	Pre Exposure Avg	Pre Exposure Max	Pre Exposure Std	Post Exposure Min	Post Exposure Avg	Post Exposure Max	Post Exposure Std	Min Delta	Avg Delta	Max Delta	Std Delta
0	4.319	5.949	8.675	1.6913	3.236	6.4388	8.106	1.9109	-1.582	0.4898	3.787	2.0902
20	3.734	7.8383	10.321	2.2441	3.693	13.863	23.682	6.4744	-2.924	6.0249	15.108	6.6137
30	1.888	7.2062	10.634	2.8952	3.887	22.199	48.557	16.653	-4.318	14.993	39.513	15.488

Device Test: 10.761 UJQY9R(VCS_LINEAR_6p5V_Go-No-Go_UJQY9R)

TID vs Result Stats

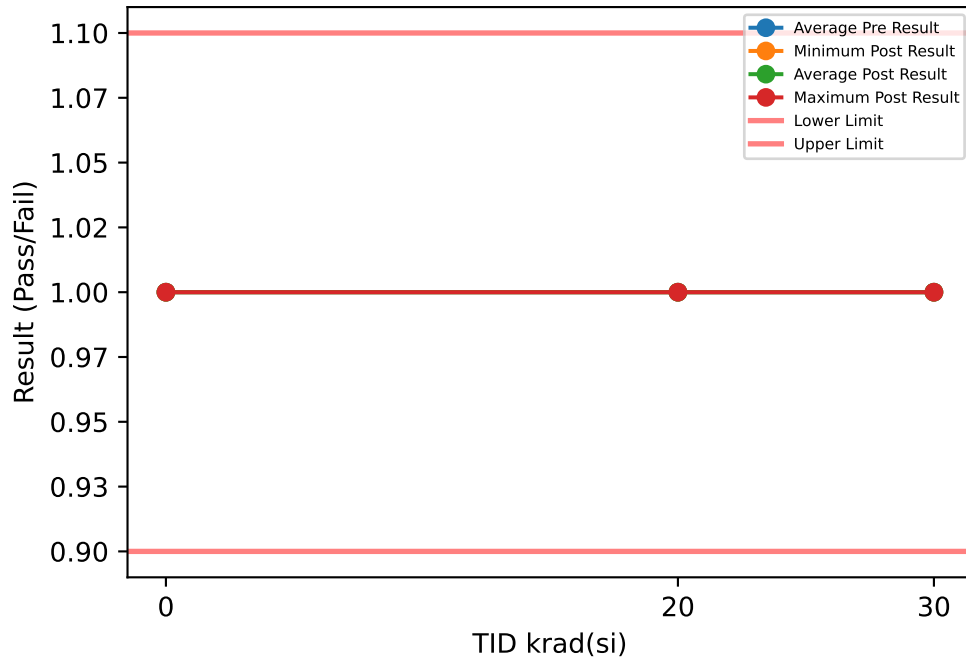

Test Results (Lower Limit = 0.9, Upper Limit = 1.1 (Pass/Fail))

Serial #	krad(si)	Exposure Conditions	Pre Result	Post Result	Delta
1	20	HDR unbiased	1	1	0
2	20	HDR unbiased	1	1	0
3	20	HDR unbiased	1	1	0
4	20	HDR unbiased	1	1	0
5	20	HDR unbiased	1	1	0
6	20	HDR biased	1	1	0
7	20	HDR biased	1	1	0
8	20	HDR biased	1	1	0
9	20	HDR biased	1	1	0
10	20	HDR biased	1	1	0
11	30	HDR unbiased	1	1	0
12	30	HDR unbiased	1	1	0
13	30	HDR unbiased	1	1	0
14	30	HDR unbiased	1	1	0
15	30	HDR unbiased	1	1	0
16	30	HDR biased	1	1	0
17	30	HDR biased	1	1	0
18	30	HDR biased	1	1	0
19	30	HDR biased	1	1	0
20	30	HDR biased	1	1	0
21	0	correlation	1	1	0
22	0	correlation	1	1	0
23	0	correlation	1	1	0
24	0	correlation	1	1	0
25	0	correlation	1	1	0

TID vs Post - Pre Exposure Delta

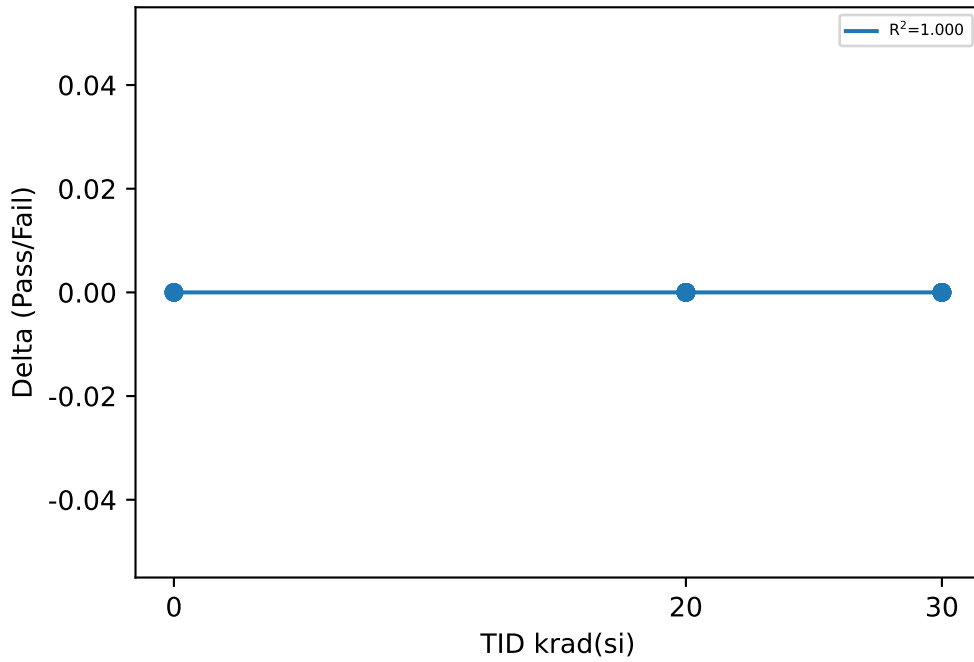

Test Statistics (Pass/Fail)

krad(si)	Pre Exposure Min	Pre Exposure Avg	Pre Exposure Max	Pre Exposure Std	Post Exposure Min	Post Exposure Avg	Post Exposure Max	Post Exposure Std	Min Delta	Avg Delta	Max Delta	Std Delta
0	1	1	1	0	1	1	1	0	0	0	0	0
20	1	1	1	0	1	1	1	0	0	0	0	0
30	1	1	1	0	1	1	1	0	0	0	0	0

Device Test: 10.791 UJWB0Y(VCS_LINEAR_5V_Go-No-Go_UJWB0Y)

TID vs Result Stats

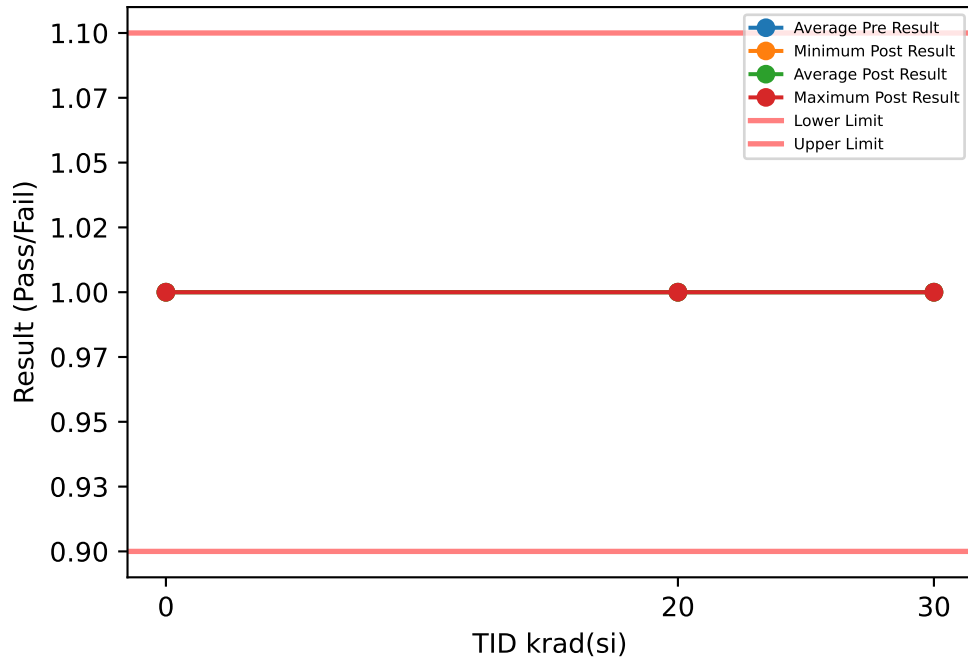

TID vs Post - Pre Exposure Delta

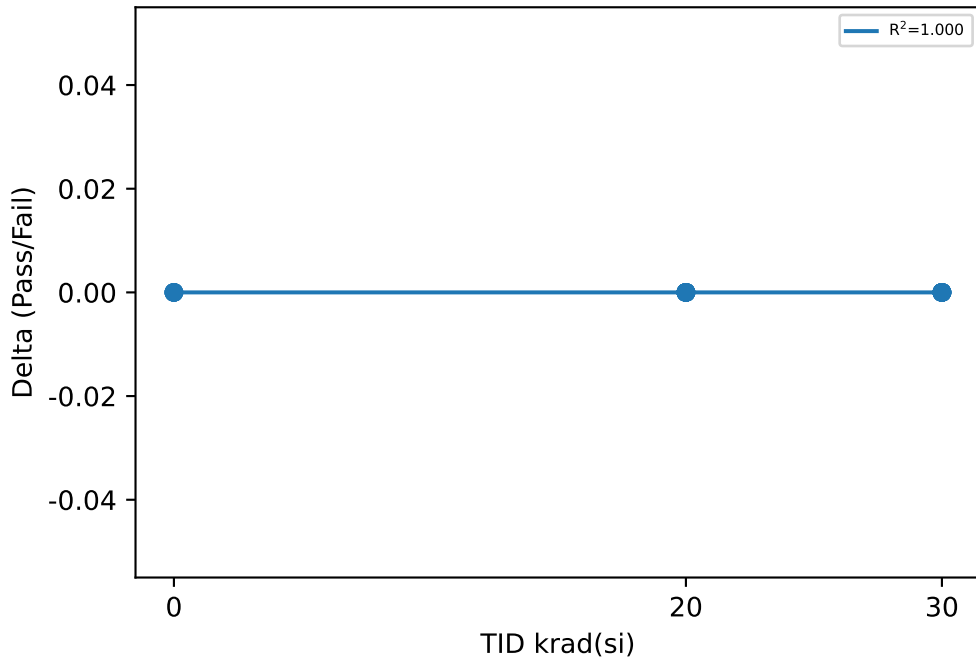

Test Results (Lower Limit = 0.9, Upper Limit = 1.1 (Pass/Fail))

Serial #	krad(si)	Exposure Conditions	Pre Result	Post Result	Delta
1	20	HDR unbiased	1	1	0
2	20	HDR unbiased	1	1	0
3	20	HDR unbiased	1	1	0
4	20	HDR unbiased	1	1	0
5	20	HDR unbiased	1	1	0
6	20	HDR biased	1	1	0
7	20	HDR biased	1	1	0
8	20	HDR biased	1	1	0
9	20	HDR biased	1	1	0
10	20	HDR biased	1	1	0
11	30	HDR unbiased	1	1	0
12	30	HDR unbiased	1	1	0
13	30	HDR unbiased	1	1	0
14	30	HDR unbiased	1	1	0
15	30	HDR unbiased	1	1	0
16	30	HDR biased	1	1	0
17	30	HDR biased	1	1	0
18	30	HDR biased	1	1	0
19	30	HDR biased	1	1	0
20	30	HDR biased	1	1	0
21	0	correlation	1	1	0
22	0	correlation	1	1	0
23	0	correlation	1	1	0
24	0	correlation	1	1	0
25	0	correlation	1	1	0

Test Statistics (Pass/Fail)

krad(si)	Pre Exposure Min	Pre Exposure Avg	Pre Exposure Max	Pre Exposure Std	Post Exposure Min	Post Exposure Avg	Post Exposure Max	Post Exposure Std	Min Delta	Avg Delta	Max Delta	Std Delta
0	1	1	1	0	1	1	1	0	0	0	0	0
20	1	1	1	0	1	1	1	0	0	0	0	0
30	1	1	1	0	1	1	1	0	0	0	0	0

Device Test: 10.8 UJFZSP(dCSR_25mA_CH2_UJFZSP)

TID vs Result Stats

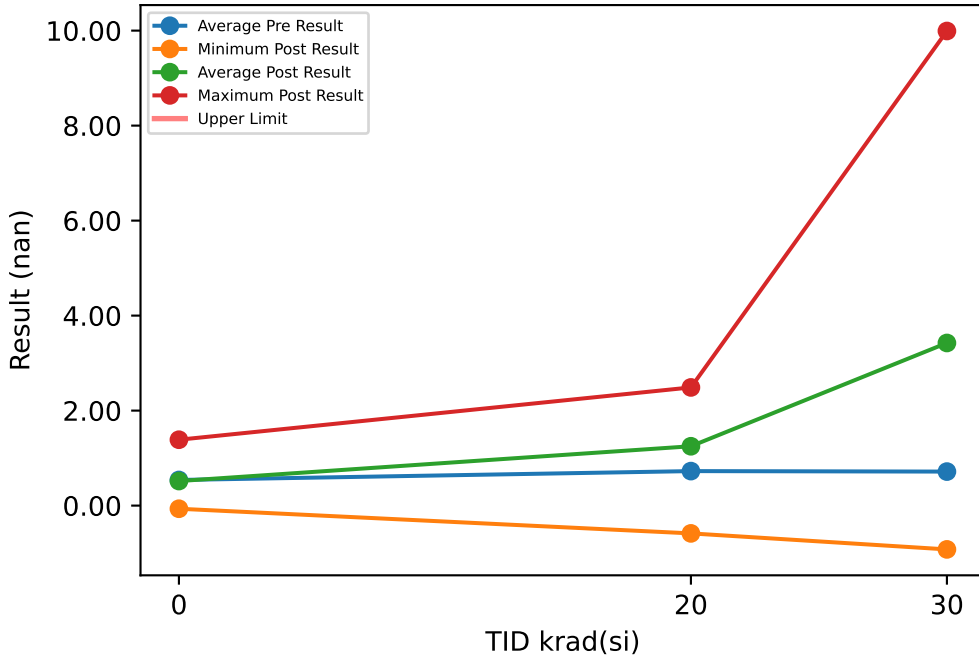

Test Results (No Limits Specified (nan))

Serial #	krad(si)	Exposure Conditions	Pre Result	Post Result	Delta
1	20	HDR unbiased	0.774	1.461	0.687
2	20	HDR unbiased	1.19	0.299	-0.891
3	20	HDR unbiased	0.706	0.637	-0.069
4	20	HDR unbiased	0.348	-0.585	-0.933
5	20	HDR unbiased	0.347	0.516	0.169
6	20	HDR biased	0.045	2.189	2.144
7	20	HDR biased	0.989	2.39	1.401
8	20	HDR biased	0.415	1.618	1.203
9	20	HDR biased	1.611	2.488	0.877
10	20	HDR biased	0.838	1.481	0.643
11	30	HDR unbiased	0.739	0.352	-0.387
12	30	HDR unbiased	-0.459	-0.378	0.081
13	30	HDR unbiased	0.226	0.157	-0.069
14	30	HDR unbiased	1.342	1.232	-0.11
15	30	HDR unbiased	0.309	-0.922	-1.231
16	30	HDR biased	0.746	6.314	5.568
17	30	HDR biased	1.389	4.972	3.583
18	30	HDR biased	0.882	6.069	5.187
19	30	HDR biased	0.9	9.992	9.092
20	30	HDR biased	1.088	6.451	5.363
21	0	correlation	1.063	1.387	0.324
22	0	correlation	0.457	0.702	0.245
23	0	correlation	0.314	0.045	-0.269
24	0	correlation	0.376	-0.066	-0.442
25	0	correlation	0.489	0.517	0.028

TID vs Post - Pre Exposure Delta

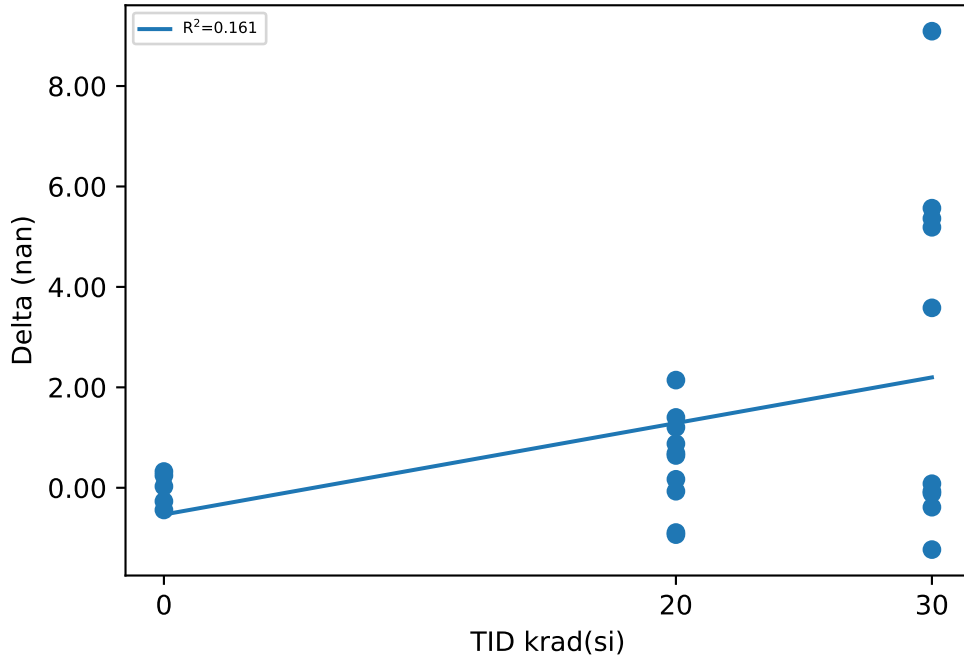

Test Statistics (nan)

krad(si)	Pre Exposure Min	Pre Exposure Avg	Pre Exposure Max	Pre Exposure Std	Post Exposure Min	Post Exposure Avg	Post Exposure Max	Post Exposure Std	Min Delta	Avg Delta	Max Delta	Std Delta
0	0.314	0.5398	1.063	0.30041	-0.066	0.517	1.387	0.58176	-0.442	-0.0228	0.324	0.32822
20	0.045	0.7263	1.611	0.46307	-0.585	1.2494	2.488	1.0074	-0.933	0.5231	2.144	0.97881
30	-0.459	0.7162	1.389	0.56099	-0.922	3.4239	9.992	3.7757	-1.231	2.7077	9.092	3.5047

Device Test: 10.9 UJF0T(dCSR_50mA_CH2_UJF0T)

TID vs Result Stats

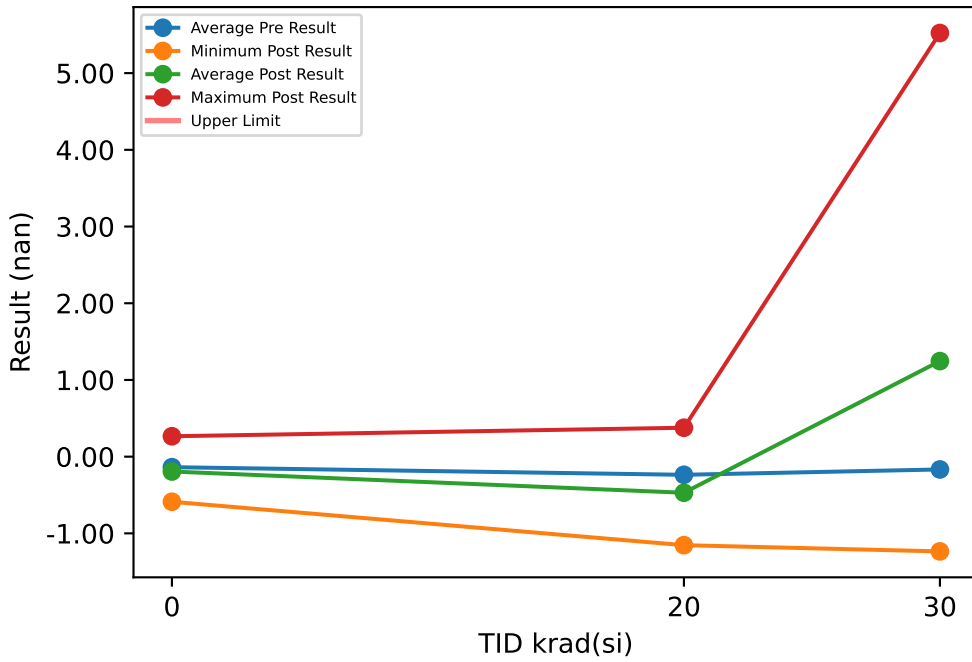

Test Results (No Limits Specified (nan))

Serial #	krad(si)	Exposure Conditions	Pre Result	Post Result	Delta
1	20	HDR unbiased	-0.63	-0.705	-0.075
2	20	HDR unbiased	0.206	0.018	-0.188
3	20	HDR unbiased	0.015	-0.463	-0.478
4	20	HDR unbiased	-0.642	-1.154	-0.512
5	20	HDR unbiased	-0.483	-0.746	-0.263
6	20	HDR biased	-0.11	-0.424	-0.314
7	20	HDR biased	0.081	0.377	0.296
8	20	HDR biased	-0.642	-0.41	0.232
9	20	HDR biased	0.412	-0.106	-0.518
10	20	HDR biased	-0.571	-1.091	-0.52
11	30	HDR unbiased	-0.293	-0.321	-0.028
12	30	HDR unbiased	-0.604	-0.945	-0.341
13	30	HDR unbiased	-0.6	-1.025	-0.425
14	30	HDR unbiased	0.016	0.348	0.332
15	30	HDR unbiased	-0.446	-1.235	-0.789
16	30	HDR biased	-0.221	2.303	2.524
17	30	HDR biased	0.179	2.348	2.169
18	30	HDR biased	0.235	3.093	2.858
19	30	HDR biased	0.46	5.523	5.063
20	30	HDR biased	-0.394	2.369	2.763
21	0	correlation	0.024	0.266	0.242
22	0	correlation	0.347	0.079	-0.268
23	0	correlation	-0.586	-0.446	0.14
24	0	correlation	-0.318	-0.279	0.039
25	0	correlation	-0.153	-0.588	-0.435

TID vs Post - Pre Exposure Delta

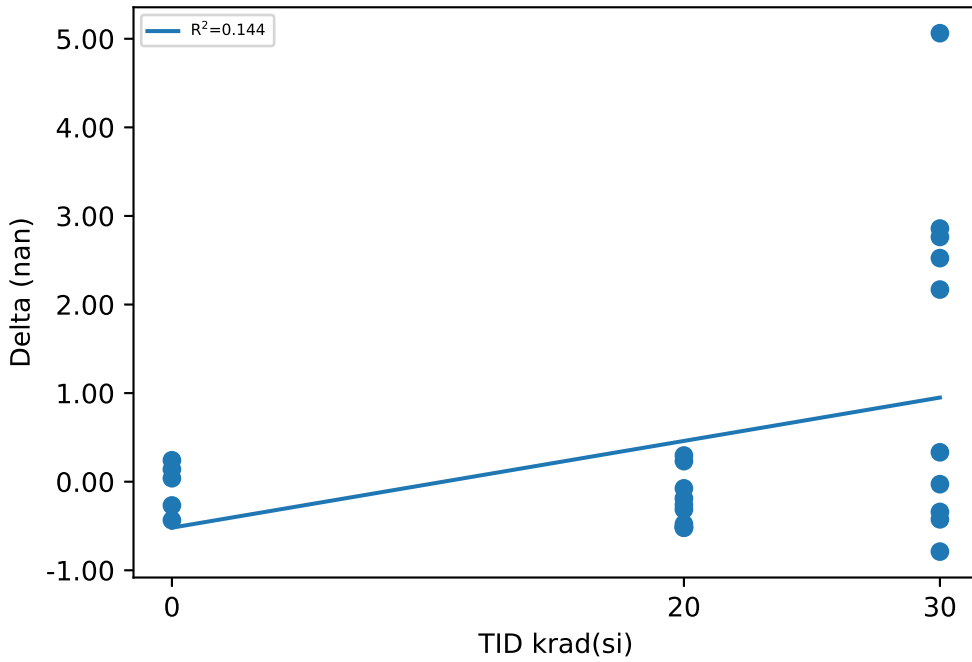

Test Statistics (nan)

krad(si)	Pre Exposure Min	Pre Exposure Avg	Pre Exposure Max	Pre Exposure Std	Post Exposure Min	Post Exposure Avg	Post Exposure Max	Post Exposure Std	Min Delta	Avg Delta	Max Delta	Std Delta
0	-0.586	-0.1372	0.347	0.35171	-0.588	-0.1936	0.266	0.3578	-0.435	-0.0564	0.242	0.28497
20	-0.642	-0.2364	0.412	0.40177	-1.154	-0.4704	0.377	0.48059	-0.52	-0.234	0.296	0.30404
30	-0.604	-0.1668	0.46	0.37037	-1.235	1.2458	5.523	2.2279	-0.789	1.4126	5.063	1.9318

Device Test: 11.10 UJQ28B(Delta_dCLR_P5A_CH1CH3_UJQ28B)

TID vs Result Stats

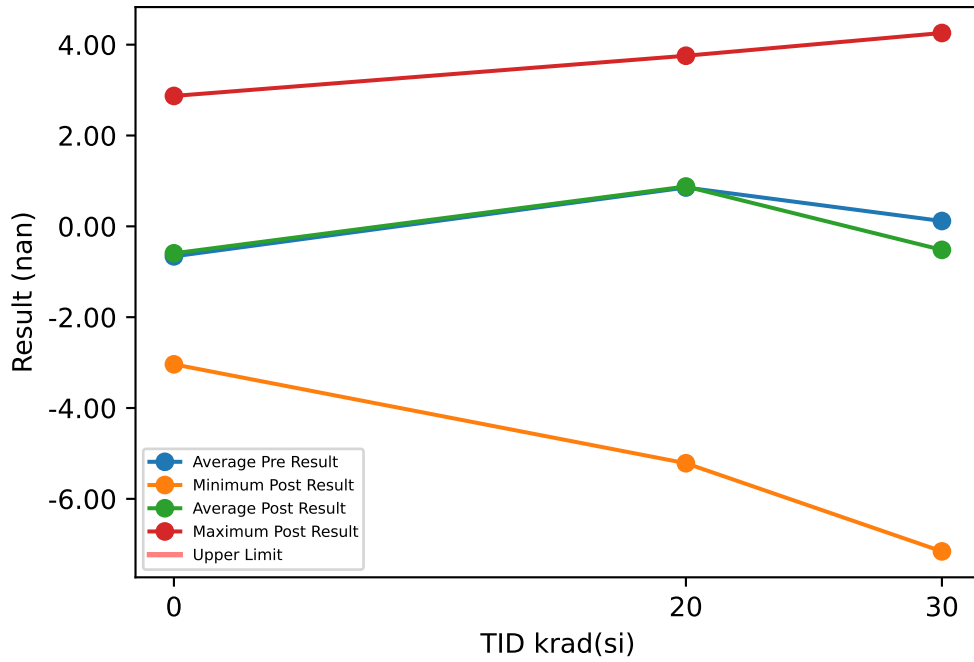

Test Results (No Limits Specified (nan))

Serial #	krad(si)	Exposure Conditions	Pre Result	Post Result	Delta
1	20	HDR unbiased	-4.962	-5.216	-0.254
2	20	HDR unbiased	0.089	1.266	1.177
3	20	HDR unbiased	2.833	3.298	0.465
4	20	HDR unbiased	-1.474	-2.147	-0.673
5	20	HDR unbiased	1.92	3.756	1.836
6	20	HDR biased	0.572	2.921	2.349
7	20	HDR biased	2.857	2.173	-0.684
8	20	HDR biased	0.344	-0.395	-0.739
9	20	HDR biased	2.689	3.32	0.631
10	20	HDR biased	3.681	-0.204	-3.885
11	30	HDR unbiased	-0.077	-0.943	-0.866
12	30	HDR unbiased	-0.447	-1.91	-1.463
13	30	HDR unbiased	-1.146	-1.034	0.112
14	30	HDR unbiased	3.84	-0.521	-4.361
15	30	HDR unbiased	1.396	0.567	-0.829
16	30	HDR biased	0.89	1.921	1.031
17	30	HDR biased	-3.023	-7.157	-4.134
18	30	HDR biased	-0.248	-0.635	-0.387
19	30	HDR biased	-1.254	4.257	5.511
20	30	HDR biased	1.241	0.274	-0.967
21	0	correlation	1.247	1.328	0.081
22	0	correlation	-2.686	-2.871	-0.185
23	0	correlation	-3.187	-3.038	0.149
24	0	correlation	2.769	2.871	0.102
25	0	correlation	-1.447	-1.259	0.188

TID vs Post - Pre Exposure Delta

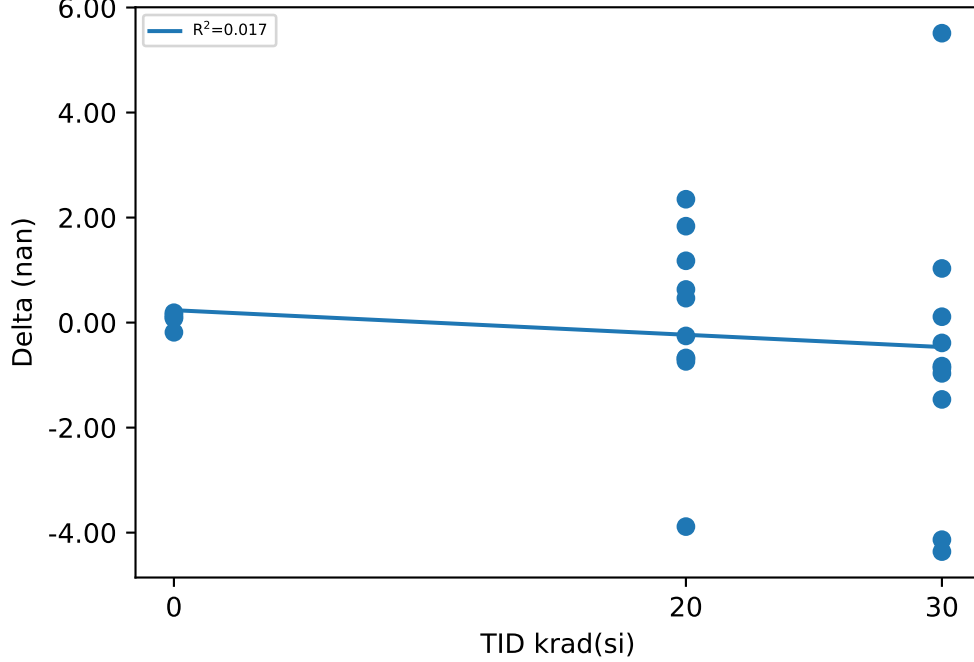

Test Statistics (nan)

krad(si)	Pre Exposure Min	Pre Exposure Avg	Pre Exposure Max	Pre Exposure Std	Post Exposure Min	Post Exposure Avg	Post Exposure Max	Post Exposure Std	Min Delta	Avg Delta	Max Delta	Std Delta
0	-3.187	-0.6608	2.769	2.5741	-3.038	-0.5938	2.871	2.6125	-0.185	0.067	0.188	0.14688
20	-4.962	0.8549	3.681	2.5947	-5.216	0.8772	3.756	2.8903	-3.885	0.0223	2.349	1.7483
30	-3.023	0.1172	3.84	1.8613	-7.157	-0.5181	4.257	2.9255	-4.361	-0.6353	5.511	2.7524

Device Test: 11.1 UJ9ZQ5(dCLR_P25A_CH1_UJ9ZQ5)

TID vs Result Stats

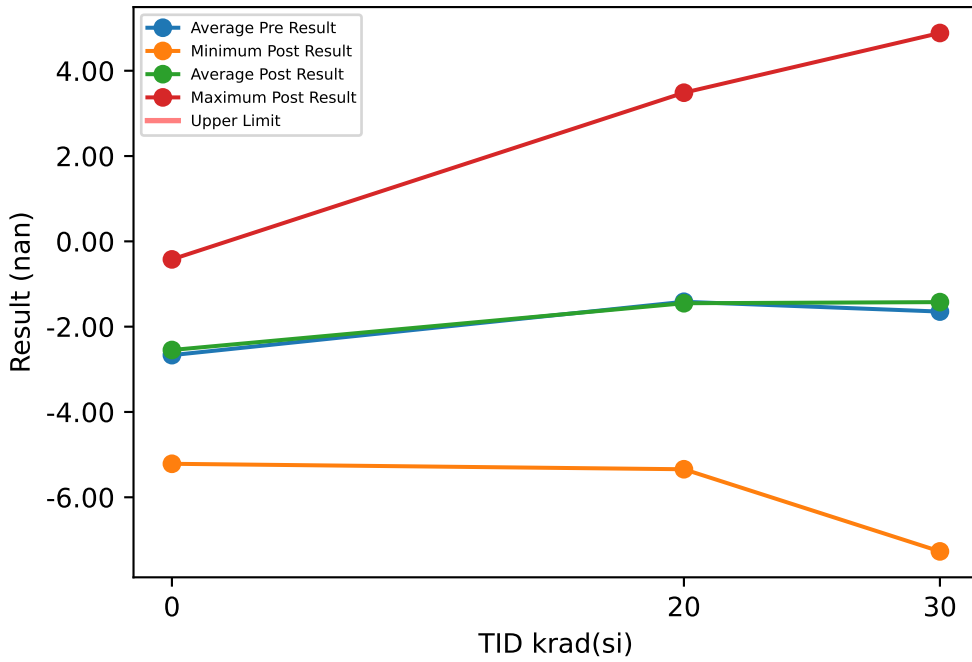

Test Results (No Limits Specified (nan))

Serial #	krad(si)	Exposure Conditions	Pre Result	Post Result	Delta
1	20	HDR unbiased	-4.224	-5.343	-1.119
2	20	HDR unbiased	-2.677	-2.053	0.624
3	20	HDR unbiased	-0.91	-0.027	0.883
4	20	HDR unbiased	-3.23	-1.776	1.454
5	20	HDR unbiased	1.073	3.485	2.412
6	20	HDR biased	-0.389	-0.259	0.13
7	20	HDR biased	-2.103	-2.345	-0.242
8	20	HDR biased	1.737	-0.044	-1.781
9	20	HDR biased	-3.784	-4.265	-0.481
10	20	HDR biased	0.344	-1.882	-2.226
11	30	HDR unbiased	2.263	1.028	-1.235
12	30	HDR unbiased	-2.149	-3.983	-1.834
13	30	HDR unbiased	-5.512	-3.794	1.718
14	30	HDR unbiased	1.196	-3.716	-4.912
15	30	HDR unbiased	-1.219	-0.931	0.288
16	30	HDR biased	-0.282	1.261	1.543
17	30	HDR biased	-3.825	-7.269	-3.444
18	30	HDR biased	-0.826	0.906	1.732
19	30	HDR biased	-3.765	4.885	8.65
20	30	HDR biased	-2.344	-2.634	-0.29
21	0	correlation	-0.649	-0.423	0.226
22	0	correlation	-1.995	-2.071	-0.076
23	0	correlation	-1.752	-1.886	-0.134
24	0	correlation	-3.622	-3.141	0.481
25	0	correlation	-5.32	-5.215	0.105

TID vs Post - Pre Exposure Delta

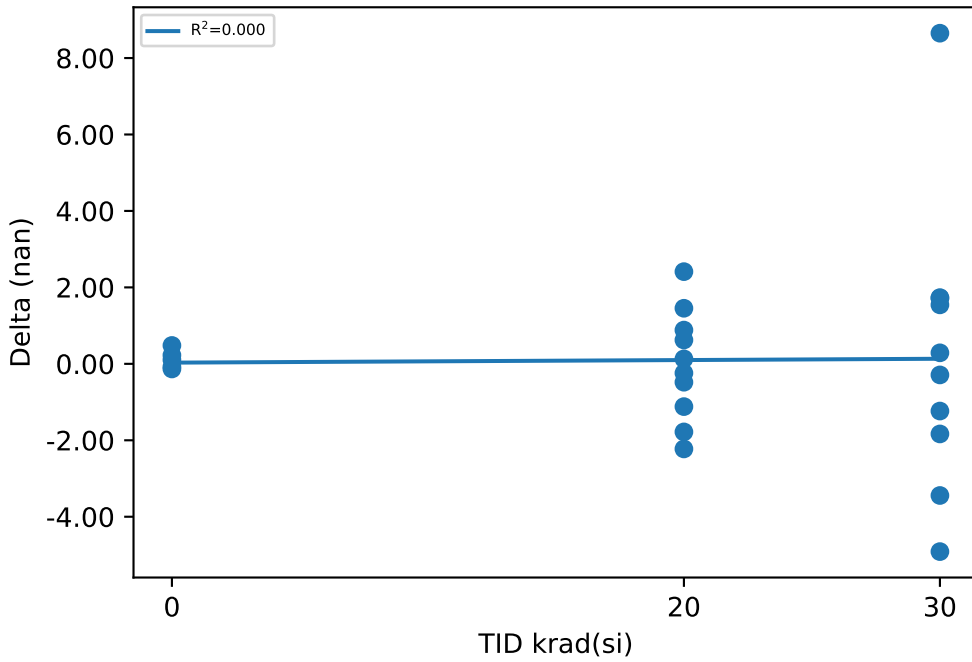

Test Statistics (nan)

krad(si)	Pre Exposure Min	Pre Exposure Avg	Pre Exposure Max	Pre Exposure Std	Post Exposure Min	Post Exposure Avg	Post Exposure Max	Post Exposure Std	Min Delta	Avg Delta	Max Delta	Std Delta
0	-5.32	-2.6676	-0.649	1.8243	-5.215	-2.5472	-0.423	1.7781	-0.134	0.1204	0.481	0.24734
20	-4.224	-1.4163	1.737	2.092	-5.343	-1.4509	3.485	2.4565	-2.226	-0.0346	2.412	1.4443
30	-5.512	-1.6463	2.263	2.3804	-7.269	-1.4247	4.885	3.5236	-4.912	0.2216	8.65	3.7075

Device Test: 11.11 UJ8ROM(Delta_dCLR_P5A_CH1CH4_UJ8ROM)

TID vs Result Stats

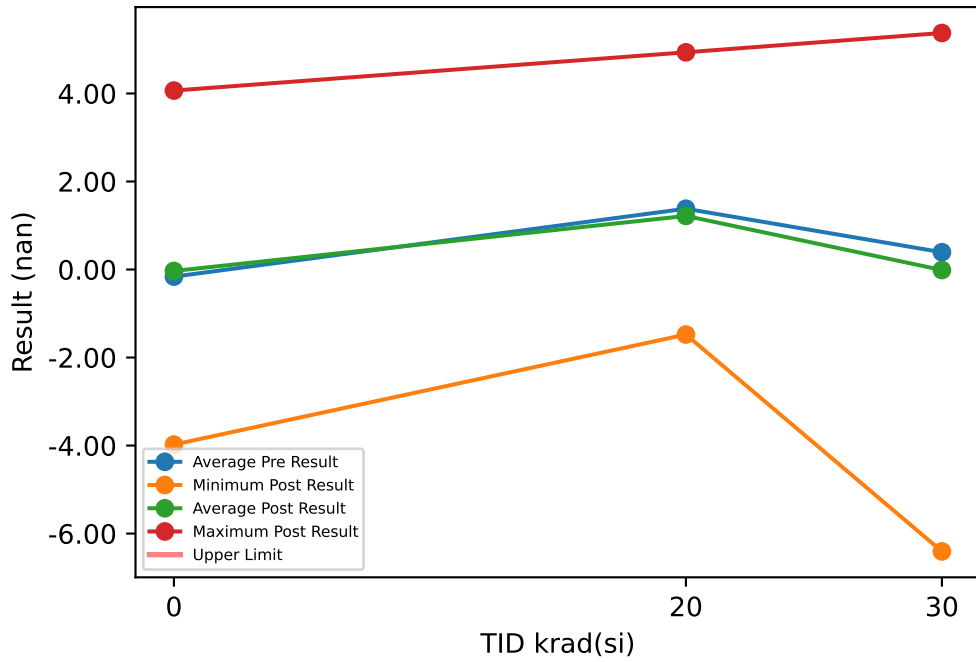

Test Results (No Limits Specified (nan))

Serial #	krad(si)	Exposure Conditions	Pre Result	Post Result	Delta
1	20	HDR unbiased	-1.793	-1.478	0.315
2	20	HDR unbiased	4.052	4.903	0.851
3	20	HDR unbiased	1.271	1.59	0.319
4	20	HDR unbiased	-0.383	0.278	0.661
5	20	HDR unbiased	3.653	4.935	1.282
6	20	HDR biased	1.526	2.892	1.366
7	20	HDR biased	0.41	-0.139	-0.549
8	20	HDR biased	0.389	-0.84	-1.229
9	20	HDR biased	1.069	-0.105	-1.174
10	20	HDR biased	3.617	0.144	-3.473
11	30	HDR unbiased	0.868	-0.101	-0.969
12	30	HDR unbiased	-0.095	-0.743	-0.648
13	30	HDR unbiased	-0.839	-0.26	0.579
14	30	HDR unbiased	3.856	-0.575	-4.431
15	30	HDR unbiased	3.669	3.442	-0.227
16	30	HDR biased	0.053	0.189	0.136
17	30	HDR biased	-4.035	-6.405	-2.37
18	30	HDR biased	1.471	1.408	-0.063
19	30	HDR biased	-0.171	5.374	5.545
20	30	HDR biased	-0.852	-2.446	-1.594
21	0	correlation	1.197	1.36	0.163
22	0	correlation	-1.415	-1.421	-0.006
23	0	correlation	-3.87	-3.978	-0.108
24	0	correlation	3.644	4.066	0.422
25	0	correlation	-0.362	-0.192	0.17

TID vs Post - Pre Exposure Delta

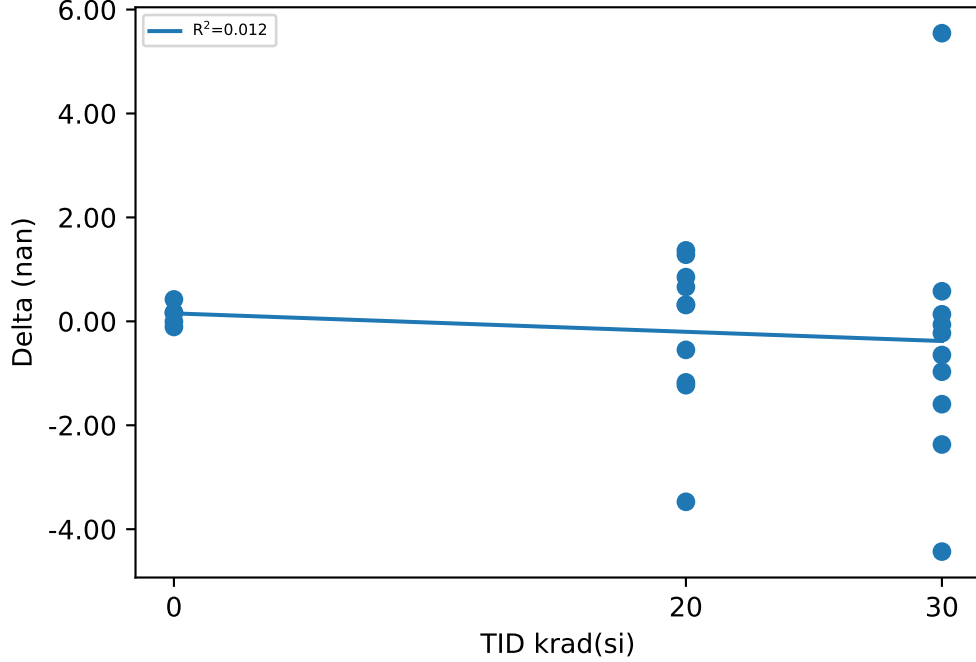

Test Statistics (nan)

krad(si)	Pre Exposure Min	Pre Exposure Avg	Pre Exposure Max	Pre Exposure Std	Post Exposure Min	Post Exposure Avg	Post Exposure Max	Post Exposure Std	Min Delta	Avg Delta	Max Delta	Std Delta
0	-3.87	-0.1612	3.644	2.8148	-3.978	-0.033	4.066	3.0107	-0.108	0.1282	0.422	0.20191
20	-1.793	1.3811	4.052	1.9014	-1.478	1.218	4.935	2.2966	-3.473	-0.1631	1.366	1.4854
30	-4.035	0.3925	3.856	2.2964	-6.405	-0.0117	5.374	3.1748	-4.431	-0.4042	5.545	2.5533

Device Test: 11.12 UJ2PYL(Delta_dCLR_P5A_CH2CH3_UJ2PYL)

TID vs Result Stats

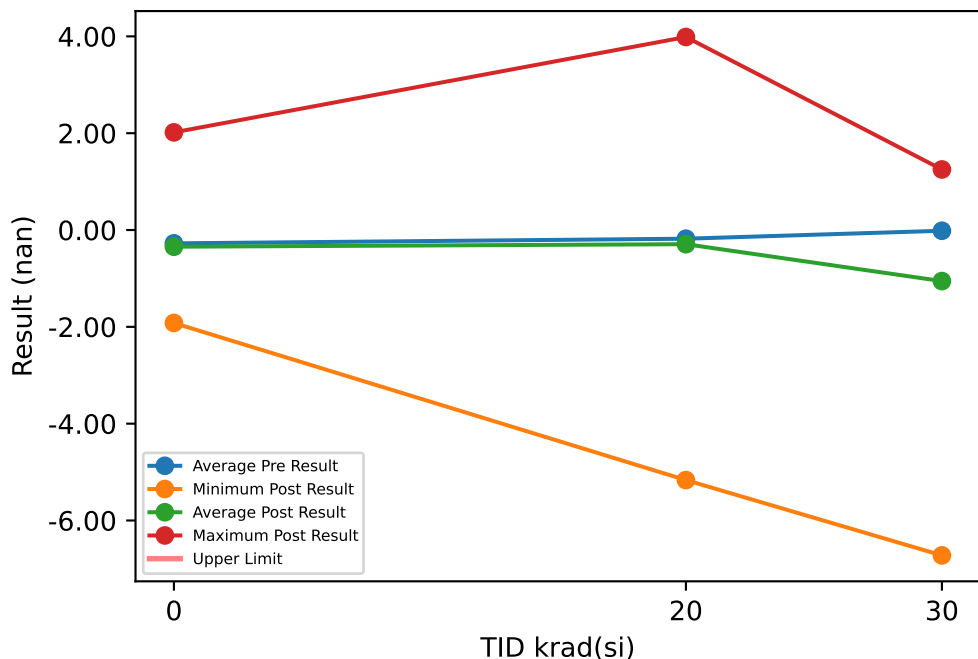

Test Results (No Limits Specified (nan))

Serial #	krad(si)	Exposure Conditions	Pre Result	Post Result	Delta
1	20	HDR unbiased	-2.28	-2.184	0.096
2	20	HDR unbiased	-2.3	-0.866	1.434
3	20	HDR unbiased	2.155	1.5	-0.655
4	20	HDR unbiased	-3.491	-5.165	-1.674
5	20	HDR unbiased	-3.095	-2.65	0.445
6	20	HDR biased	1.537	1.438	-0.099
7	20	HDR biased	-0.581	-2.198	-1.617
8	20	HDR biased	0.832	0.592	-0.24
9	20	HDR biased	3.705	3.987	0.282
10	20	HDR biased	1.724	2.618	0.894
11	30	HDR unbiased	-0.648	-1.295	-0.647
12	30	HDR unbiased	0.498	-0.974	-1.472
13	30	HDR unbiased	-0.318	0.446	0.764
14	30	HDR unbiased	2.231	0.063	-2.168
15	30	HDR unbiased	-0.281	-1.707	-1.426
16	30	HDR biased	1.076	0.798	-0.278
17	30	HDR biased	-3.045	-6.721	-3.676
18	30	HDR biased	-0.626	-2.367	-1.741
19	30	HDR biased	-0.965	1.251	2.216
20	30	HDR biased	1.923	-0.042	-1.965
21	0	correlation	-1.985	-1.92	0.065
22	0	correlation	-1.349	-1.615	-0.266
23	0	correlation	0.675	0.707	0.032
24	0	correlation	2.239	2.017	-0.222
25	0	correlation	-0.957	-0.913	0.044

TID vs Post - Pre Exposure Delta

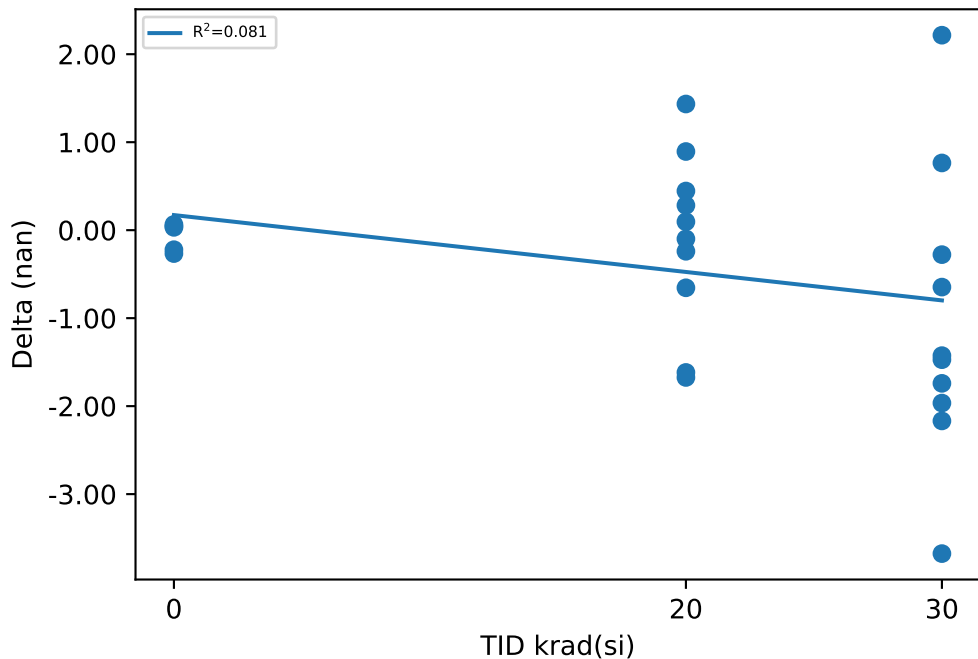

Test Statistics (nan)

krad(si)	Pre Exposure Min	Pre Exposure Avg	Pre Exposure Max	Pre Exposure Std	Post Exposure Min	Post Exposure Avg	Post Exposure Max	Post Exposure Std	Min Delta	Avg Delta	Max Delta	Std Delta
0	-1.985	-0.2754	2.239	1.715	-1.92	-0.3448	2.017	1.666	-0.266	-0.0694	0.065	0.16058
20	-3.491	-0.1794	3.705	2.5093	-5.165	-0.2928	3.987	2.801	-1.674	-0.1134	1.434	0.99594
30	-3.045	-0.0155	2.231	1.5375	-6.721	-1.0548	1.251	2.2996	-3.676	-1.0393	2.216	1.6497

Device Test: 11.15 UJET8J(KCL_P25A_CH1_UJET8J)

TID vs Result Stats

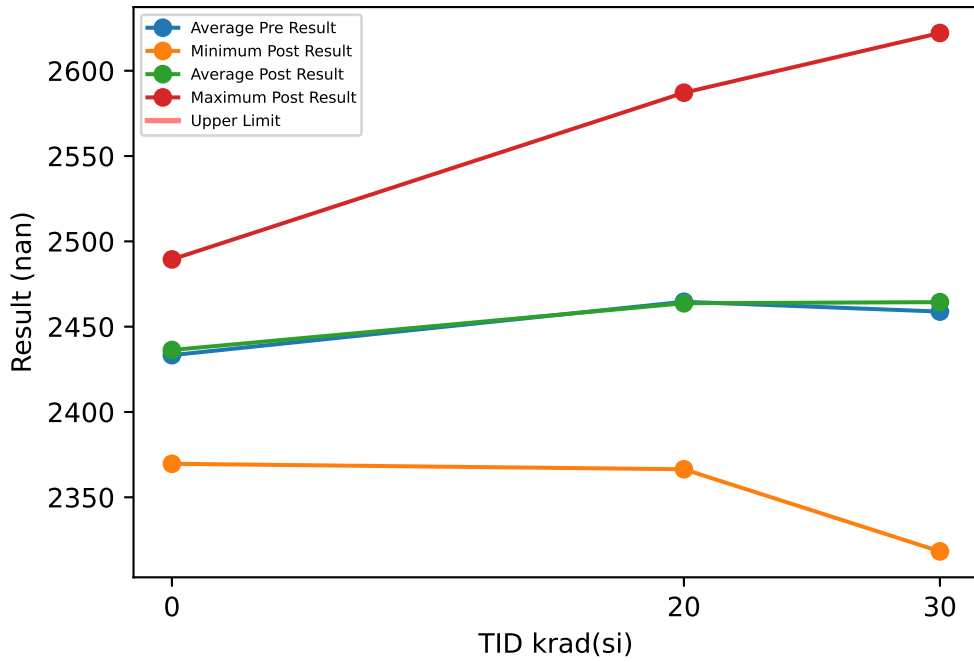

Test Results (No Limits Specified (nan))

Serial #	krad(si)	Exposure Conditions	Pre Result	Post Result	Delta
1	20	HDR unbiased	2394.4	2366.4	-27.978
2	20	HDR unbiased	2433.1	2448.7	15.59
3	20	HDR unbiased	2477.3	2499.3	22.065
4	20	HDR unbiased	2419.3	2455.6	36.341
5	20	HDR unbiased	2526.8	2587.1	60.308
6	20	HDR biased	2490.3	2493.5	3.236
7	20	HDR biased	2447.4	2441.4	-6.061
8	20	HDR biased	2543.4	2498.9	-44.53
9	20	HDR biased	2405.4	2393.4	-12.041
10	20	HDR biased	2508.6	2452.9	-55.645
11	30	HDR unbiased	2556.6	2525.7	-30.878
12	30	HDR unbiased	2446.3	2400.4	-45.853
13	30	HDR unbiased	2362.2	2405.2	42.941
14	30	HDR unbiased	2529.9	2407.1	-122.81
15	30	HDR unbiased	2469.5	2476.7	7.215
16	30	HDR biased	2493	2531.5	38.573
17	30	HDR biased	2404.4	2318.3	-86.098
18	30	HDR biased	2479.3	2522.7	43.306
19	30	HDR biased	2405.9	2622.1	216.25
20	30	HDR biased	2441.4	2434.2	-7.244
21	0	correlation	2483.8	2489.4	5.658
22	0	correlation	2450.1	2448.2	-1.899
23	0	correlation	2456.2	2452.8	-3.355
24	0	correlation	2409.5	2421.5	12.026
25	0	correlation	2367	2369.6	2.647

TID vs Post - Pre Exposure Delta

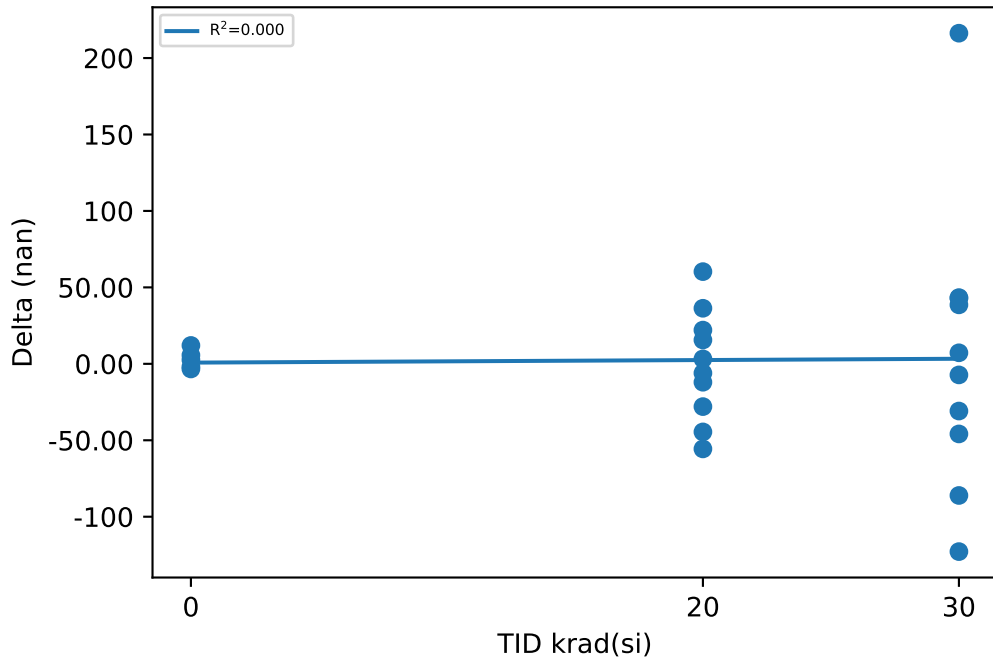

Test Statistics (nan)

krad(si)	Pre Exposure Min	Pre Exposure Avg	Pre Exposure Max	Pre Exposure Std	Post Exposure Min	Post Exposure Avg	Post Exposure Max	Post Exposure Std	Min Delta	Avg Delta	Max Delta	Std Delta
0	2367	2433.3	2483.8	45.608	2369.6	2436.3	2489.4	44.447	-3.355	3.0154	12.026	6.1855
20	2394.4	2464.6	2543.4	52.299	2366.4	2463.7	2587.1	61.416	-55.645	-0.8715	60.308	36.108
30	2362.2	2458.8	2556.6	59.507	2318.3	2464.4	2622.1	88.09	-122.81	5.5403	216.25	92.689

Device Test: 11.16 UJET8J(KCL_P5A_CH1_UJET8J)

TID vs Result Stats

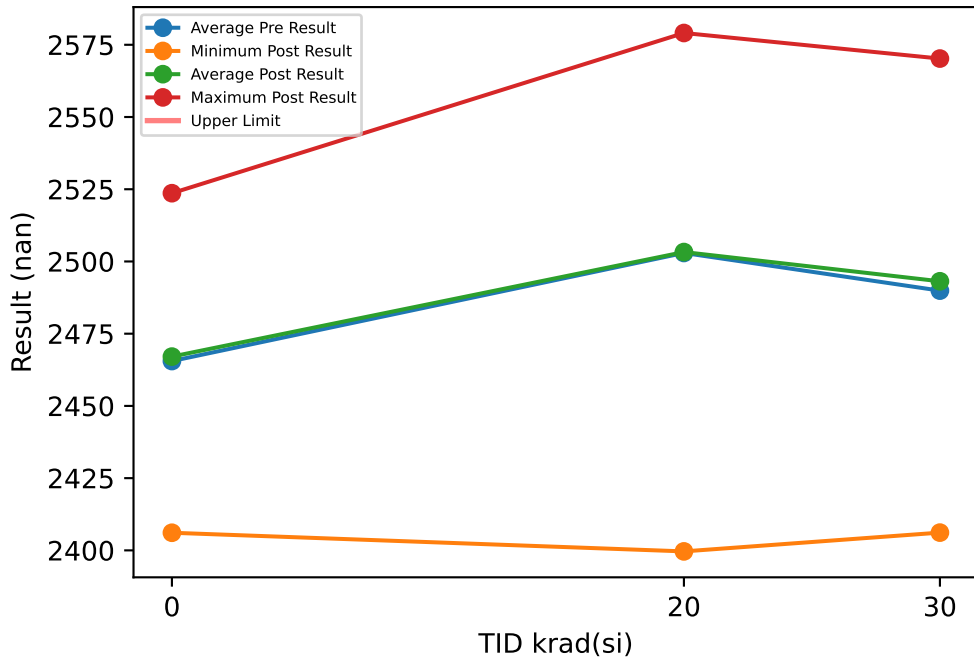

Test Results (No Limits Specified (nan))

Serial #	krad(si)	Exposure Conditions	Pre Result	Post Result	Delta
1	20	HDR unbiased	2416.3	2399.6	-16.639
2	20	HDR unbiased	2512.9	2525.1	12.156
3	20	HDR unbiased	2516.4	2533.1	16.664
4	20	HDR unbiased	2483.2	2503.5	20.22
5	20	HDR unbiased	2547.7	2579.1	31.407
6	20	HDR biased	2469.7	2520.6	50.866
7	20	HDR biased	2524.1	2518.9	-5.247
8	20	HDR biased	2512.9	2489.1	-23.808
9	20	HDR biased	2515.8	2510.4	-5.407
10	20	HDR biased	2530.3	2453.3	-77.012
11	30	HDR unbiased	2521	2505.5	-15.418
12	30	HDR unbiased	2527.8	2505.5	-22.289
13	30	HDR unbiased	2439.4	2457.2	17.847
14	30	HDR unbiased	2520.7	2455	-65.632
15	30	HDR unbiased	2522.4	2529.4	6.966
16	30	HDR biased	2502.1	2520.8	18.73
17	30	HDR biased	2446.6	2406.1	-40.459
18	30	HDR biased	2500.7	2520.8	20.076
19	30	HDR biased	2453.4	2570.2	116.88
20	30	HDR biased	2465.2	2460.8	-4.378
21	0	correlation	2521.1	2523.6	2.505
22	0	correlation	2463.1	2460.2	-2.862
23	0	correlation	2435.1	2435.7	0.584
24	0	correlation	2503.8	2509.8	5.983
25	0	correlation	2404.6	2406.1	1.499

TID vs Post - Pre Exposure Delta

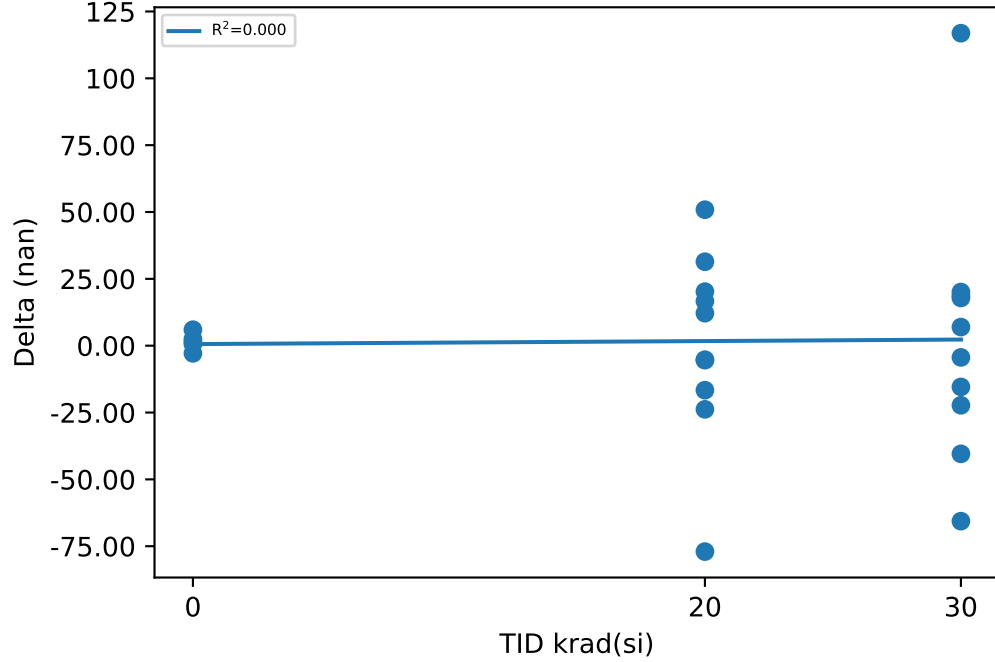

Test Statistics (nan)

krad(si)	Pre Exposure Min	Pre Exposure Avg	Pre Exposure Max	Pre Exposure Std	Post Exposure Min	Post Exposure Avg	Post Exposure Max	Post Exposure Std	Min Delta	Avg Delta	Max Delta	Std Delta
0	2404.6	2465.5	2521.1	47.954	2406.1	2467.1	2523.6	49.425	-2.862	1.5418	5.983	3.2002
20	2416.3	2502.9	2547.7	37.629	2399.6	2503.3	2579.1	48.472	-77.012	0.32	50.866	35.337
30	2439.4	2489.9	2527.8	35.033	2406.1	2493.1	2570.2	47.67	-65.632	3.2321	116.88	48.734

Device Test: 11.17 UJET8J(KCL_P25A_CH2_UJET8J)

TID vs Result Stats

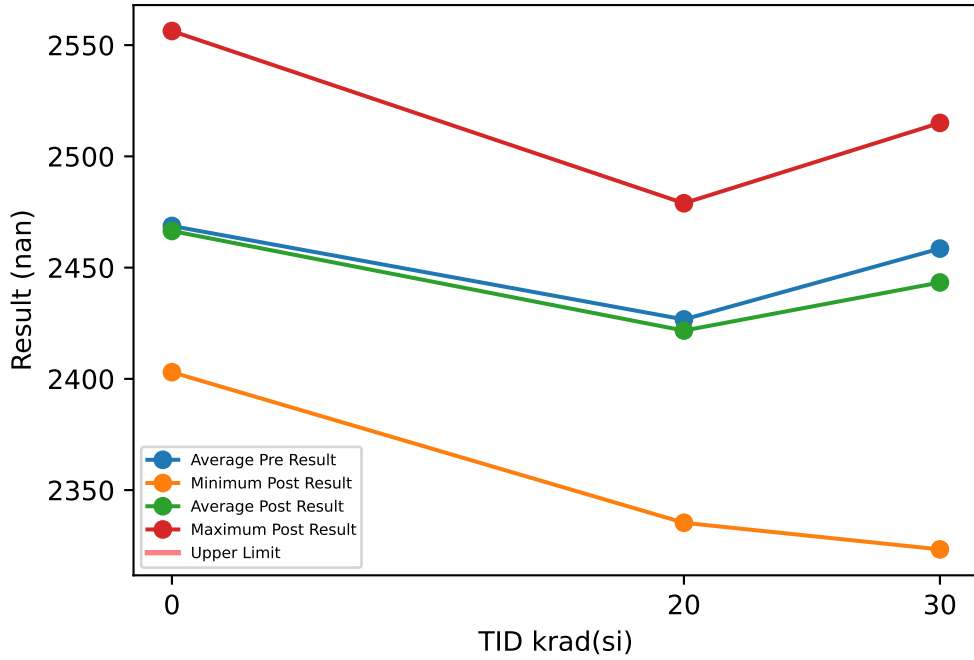

Test Results (No Limits Specified (nan))

Serial #	krad(si)	Exposure Conditions	Pre Result	Post Result	Delta
1	20	HDR unbiased	2464.3	2449.4	-14.948
2	20	HDR unbiased	2409.6	2441.1	31.483
3	20	HDR unbiased	2384.1	2371.6	-12.583
4	20	HDR unbiased	2459.8	2449.1	-10.69
5	20	HDR unbiased	2338.8	2335.3	-3.471
6	20	HDR biased	2397.1	2478.9	81.851
7	20	HDR biased	2414.1	2359.1	-54.996
8	20	HDR biased	2473.9	2456	-17.983
9	20	HDR biased	2448.9	2418.6	-30.357
10	20	HDR biased	2476.4	2458	-18.44
11	30	HDR unbiased	2526.4	2504	-22.406
12	30	HDR unbiased	2426.4	2383.5	-42.833
13	30	HDR unbiased	2456.4	2515	58.649
14	30	HDR unbiased	2482.4	2430.6	-51.745
15	30	HDR unbiased	2458.7	2445.4	-13.272
16	30	HDR biased	2450	2422.1	-27.894
17	30	HDR biased	2374.2	2323.3	-50.858
18	30	HDR biased	2487.4	2461.6	-25.792
19	30	HDR biased	2421.5	2504.6	83.016
20	30	HDR biased	2502.2	2443.1	-59.093
21	0	correlation	2455	2449.1	-5.837
22	0	correlation	2558.6	2556.4	-2.275
23	0	correlation	2499.4	2499.4	-0.055
24	0	correlation	2423.4	2424.5	1.1
25	0	correlation	2407.1	2403	-4.147

TID vs Post - Pre Exposure Delta

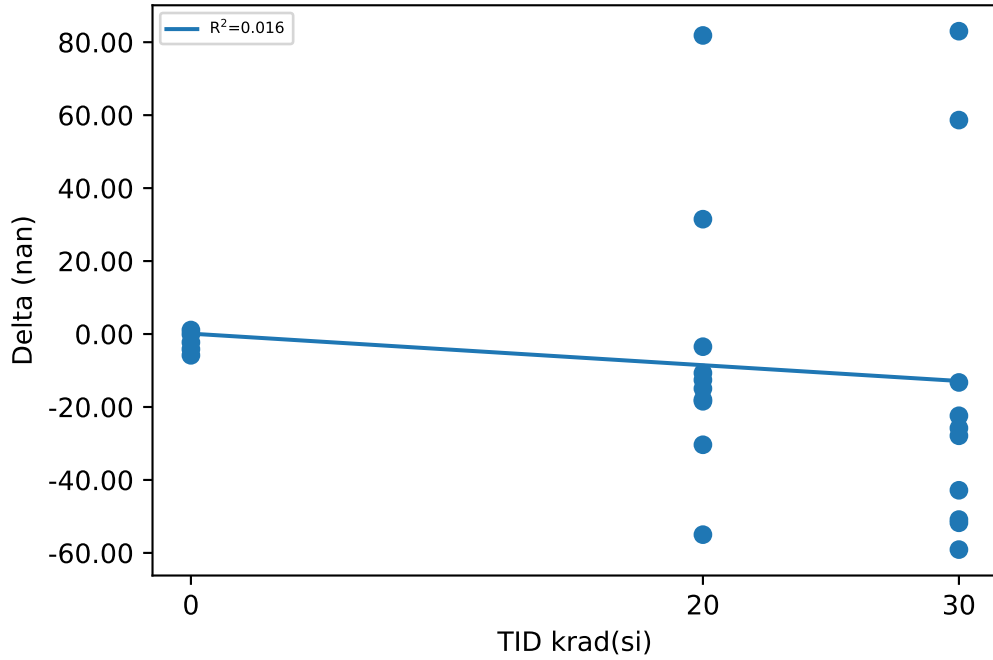

Test Statistics (nan)

krad(si)	Pre Exposure Min	Pre Exposure Avg	Pre Exposure Max	Pre Exposure Std	Post Exposure Min	Post Exposure Avg	Post Exposure Max	Post Exposure Std	Min Delta	Avg Delta	Max Delta	Std Delta
0	2407.1	2468.7	2558.6	61.359	2403	2466.5	2556.4	61.748	-5.837	-2.2428	1.1	2.8507
20	2338.8	2426.7	2476.4	45.434	2335.3	2421.7	2478.9	48.948	-54.996	-5.0134	81.851	37.353
30	2374.2	2458.6	2526.4	44.094	2323.3	2443.3	2515	59.152	-59.093	-15.223	83.016	47.989

Device Test: 11.18 UJET8J(KCL_P5A_CH2_UJET8J)

TID vs Result Stats

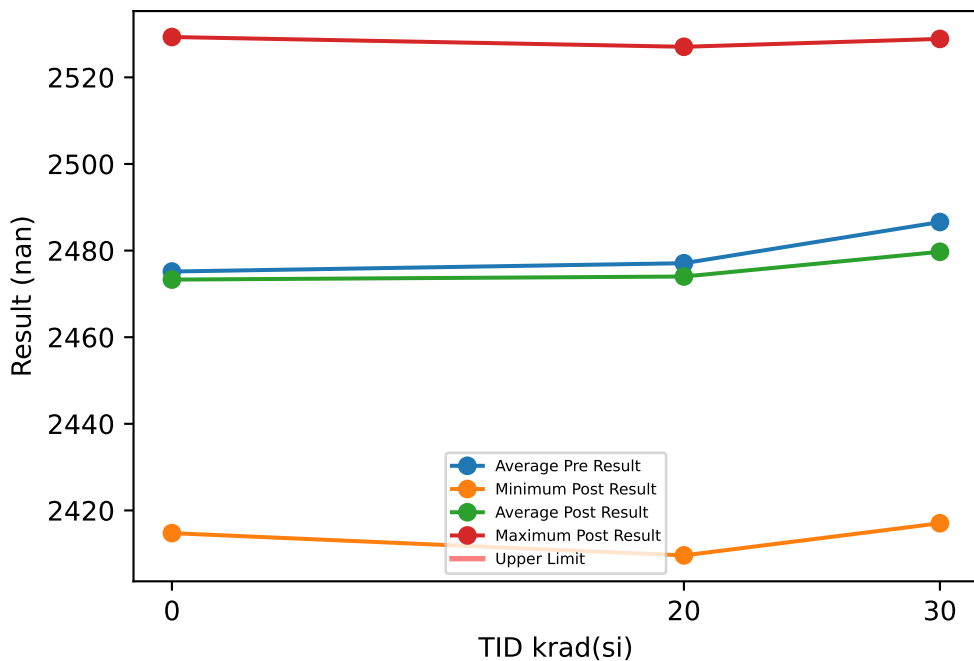

Test Results (No Limits Specified (nan))

Serial #	krad(si)	Exposure Conditions	Pre Result	Post Result	Delta
1	20	HDR unbiased	2483.4	2475.5	-7.892
2	20	HDR unbiased	2453.2	2471.8	18.584
3	20	HDR unbiased	2499.5	2488.1	-11.335
4	20	HDR unbiased	2432.8	2428	-4.787
5	20	HDR unbiased	2422.3	2418.9	-3.359
6	20	HDR biased	2493.9	2483.5	-10.36
7	20	HDR biased	2438.2	2409.6	-28.568
8	20	HDR biased	2525.1	2513.8	-11.317
9	20	HDR biased	2541.2	2527.1	-14.146
10	20	HDR biased	2481.4	2523.8	42.44
11	30	HDR unbiased	2506.7	2496.8	-9.912
12	30	HDR unbiased	2551.4	2528.9	-22.527
13	30	HDR unbiased	2460.1	2494.2	34.14
14	30	HDR unbiased	2480.5	2469.6	-10.822
15	30	HDR unbiased	2480.5	2472.6	-7.964
16	30	HDR biased	2506.7	2492.7	-14.013
17	30	HDR biased	2446	2417	-28.997
18	30	HDR biased	2491.2	2477.5	-13.776
19	30	HDR biased	2460.6	2495.1	34.485
20	30	HDR biased	2482.2	2452.9	-29.327
21	0	correlation	2440.3	2442.4	2.104
22	0	correlation	2496.5	2491.6	-4.869
23	0	correlation	2531.6	2529.3	-2.329
24	0	correlation	2490.5	2488.4	-2.139
25	0	correlation	2416.8	2414.8	-2.075

TID vs Post - Pre Exposure Delta

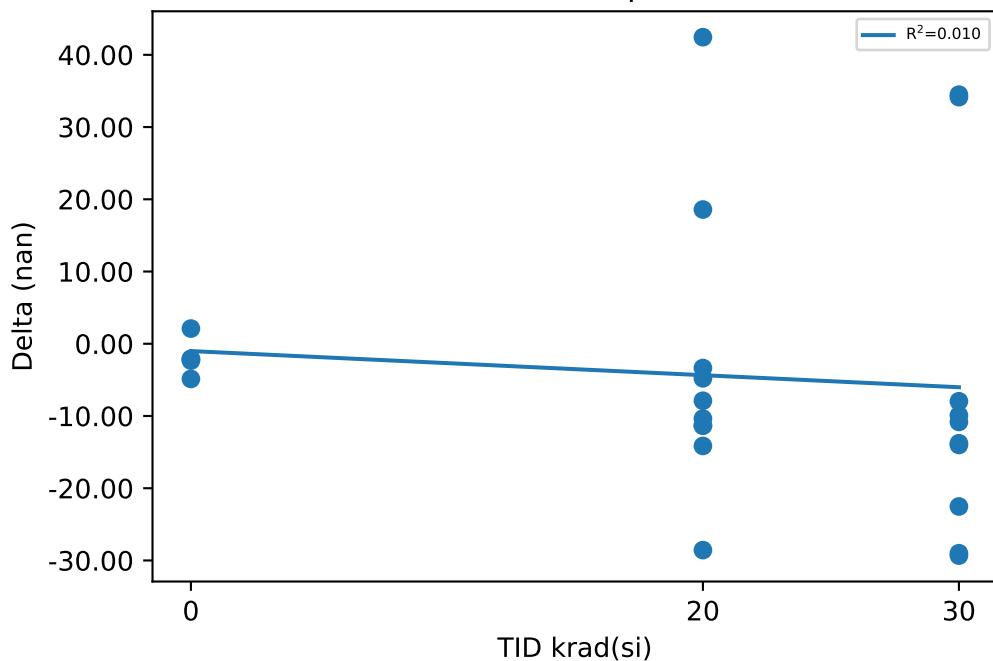

Test Statistics (nan)

krad(si)	Pre Exposure Min	Pre Exposure Avg	Pre Exposure Max	Pre Exposure Std	Post Exposure Min	Post Exposure Avg	Post Exposure Max	Post Exposure Std	Min Delta	Avg Delta	Max Delta	Std Delta
0	2416.8	2475.2	2531.6	46.087	2414.8	2473.3	2529.3	44.945	-4.869	-1.8616	2.104	2.5056
20	2422.3	2477.1	2541.2	39.862	2409.6	2474	2527.1	42.772	-28.568	-3.074	42.44	19.801
30	2446	2486.6	2551.4	30.09	2417	2479.7	2528.9	30.05	-29.327	-6.8713	34.485	22.988

Device Test: 11.19 UJET8J(KCL_P25A_CH3_UJET8J)

TID vs Result Stats

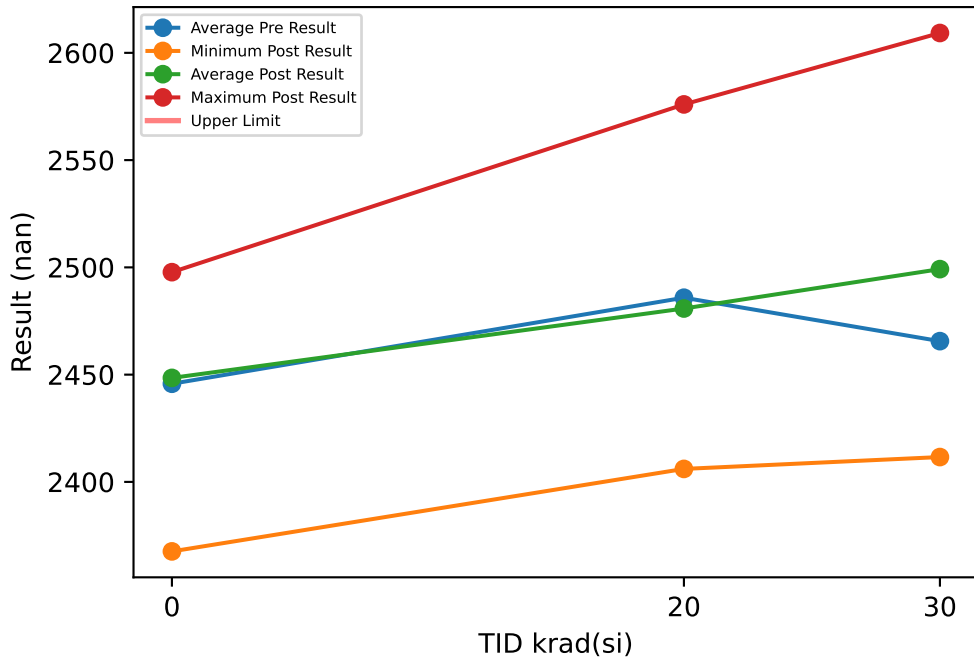

Test Results (No Limits Specified (nan))

Serial #	krad(si)	Exposure Conditions	Pre Result	Post Result	Delta
1	20	HDR unbiased	2557.6	2530.5	-27.099
2	20	HDR unbiased	2510.2	2488	-22.2
3	20	HDR unbiased	2502.3	2501.8	-0.483
4	20	HDR unbiased	2506.8	2576	69.161
5	20	HDR unbiased	2508.1	2482.6	-25.555
6	20	HDR biased	2417.9	2455.4	37.407
7	20	HDR biased	2426.1	2442.8	16.681
8	20	HDR biased	2499.3	2482.1	-17.253
9	20	HDR biased	2486.4	2443.2	-43.201
10	20	HDR biased	2443.8	2406.1	-37.729
11	30	HDR unbiased	2519.9	2530.6	10.668
12	30	HDR unbiased	2555.1	2571.5	16.396
13	30	HDR unbiased	2411.8	2435.8	24.034
14	30	HDR unbiased	2419.5	2424.4	4.875
15	30	HDR unbiased	2462.4	2505.6	43.225
16	30	HDR biased	2423.5	2411.6	-11.943
17	30	HDR biased	2495.3	2609.3	113.92
18	30	HDR biased	2466	2530.1	64.13
19	30	HDR biased	2456.7	2494.2	37.579
20	30	HDR biased	2446	2478.8	32.803
21	0	correlation	2480.2	2484.6	4.395
22	0	correlation	2447.1	2456.1	8.989
23	0	correlation	2500.1	2497.8	-2.354
24	0	correlation	2363.2	2367.6	4.372
25	0	correlation	2438	2436.3	-1.783

TID vs Post - Pre Exposure Delta

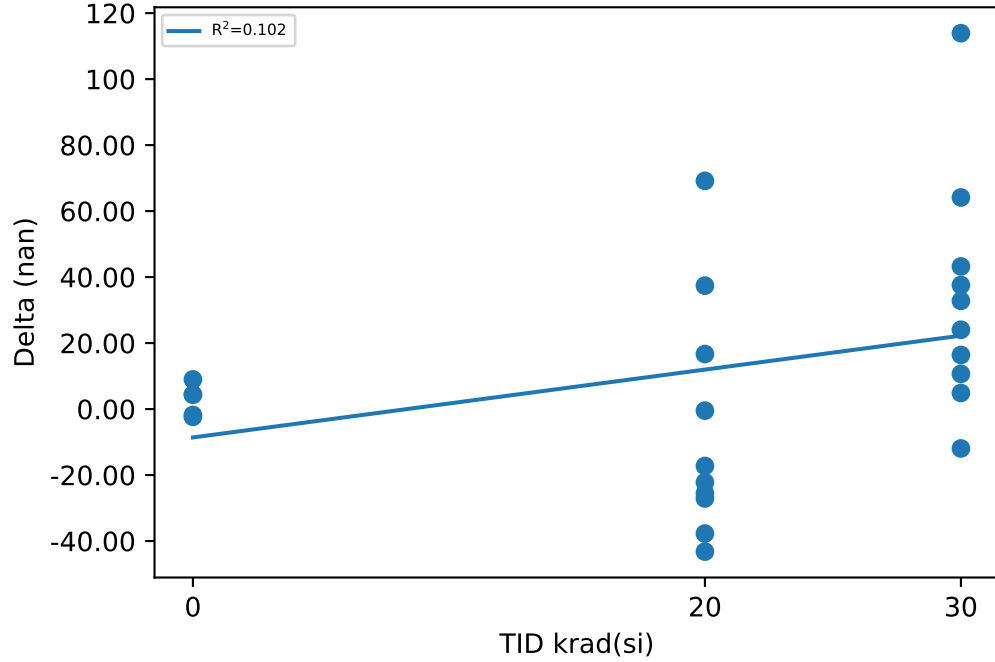

Test Statistics (nan)

krad(si)	Pre Exposure Min	Pre Exposure Avg	Pre Exposure Max	Pre Exposure Std	Post Exposure Min	Post Exposure Avg	Post Exposure Max	Post Exposure Std	Min Delta	Avg Delta	Max Delta	Std Delta
0	2363.2	2445.8	2500.1	52.476	2367.6	2448.5	2497.8	51.195	-2.354	2.7238	8.989	4.766
20	2417.9	2485.9	2557.6	43.569	2406.1	2480.8	2576	48.448	-43.201	-5.0271	69.161	36.019
30	2411.8	2465.6	2555.1	46.091	2411.6	2499.2	2609.3	64.172	-11.943	33.568	113.92	35.441

Device Test: 11.20 UJET8J(K CL_P5A_CH3_UJET8J)

TID vs Result Stats

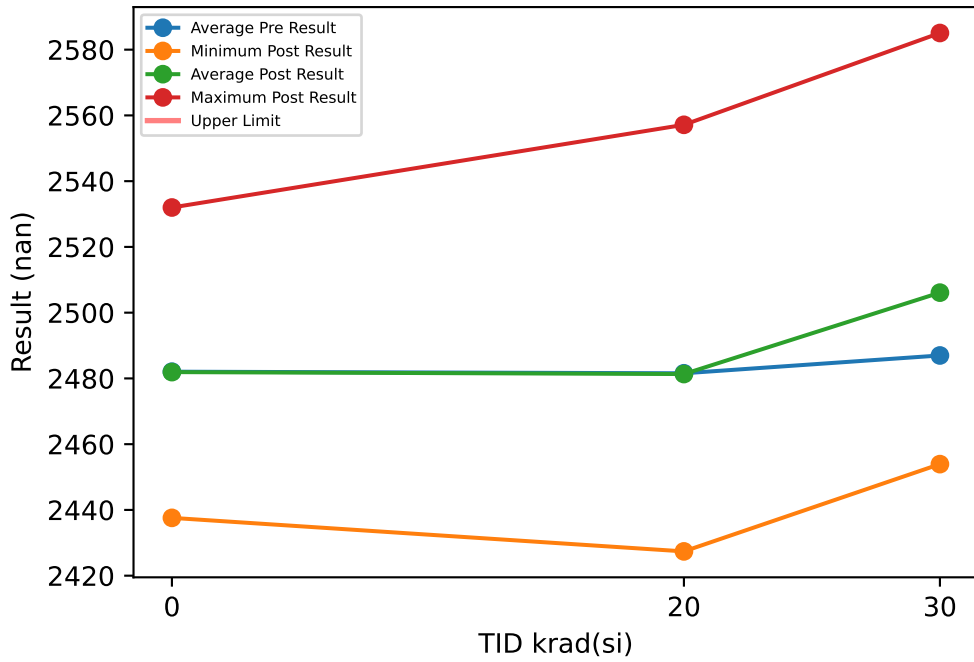

Test Results (No Limits Specified (nan))

Serial #	krad(si)	Exposure Conditions	Pre Result	Post Result	Delta
1	20	HDR unbiased	2540.3	2530.1	-10.29
2	20	HDR unbiased	2510.7	2493.4	-17.27
3	20	HDR unbiased	2445.6	2450.6	5.047
4	20	HDR unbiased	2520.1	2557.1	37.06
5	20	HDR unbiased	2499.7	2485.2	-14.471
6	20	HDR biased	2455.4	2447.6	-7.866
7	20	HDR biased	2452.7	2464.6	11.855
8	20	HDR biased	2504.3	2499	-5.326
9	20	HDR biased	2448.6	2427.4	-21.198
10	20	HDR biased	2438.3	2458.4	20.107
11	30	HDR unbiased	2522.9	2529.1	6.245
12	30	HDR unbiased	2538.9	2553.2	14.285
13	30	HDR unbiased	2468	2483	15.032
14	30	HDR unbiased	2424.7	2468.1	43.394
15	30	HDR unbiased	2487.6	2515.2	27.678
16	30	HDR biased	2479.8	2472.8	-7.066
17	30	HDR biased	2522.2	2585.1	62.899
18	30	HDR biased	2506.9	2536.6	29.751
19	30	HDR biased	2484.7	2463.8	-20.904
20	30	HDR biased	2434.1	2453.9	19.782
21	0	correlation	2489.9	2490.4	0.482
22	0	correlation	2530.2	2532	1.771
23	0	correlation	2514.8	2511.6	-3.142
24	0	correlation	2434.6	2438	3.416
25	0	correlation	2440.8	2437.6	-3.184

TID vs Post - Pre Exposure Delta

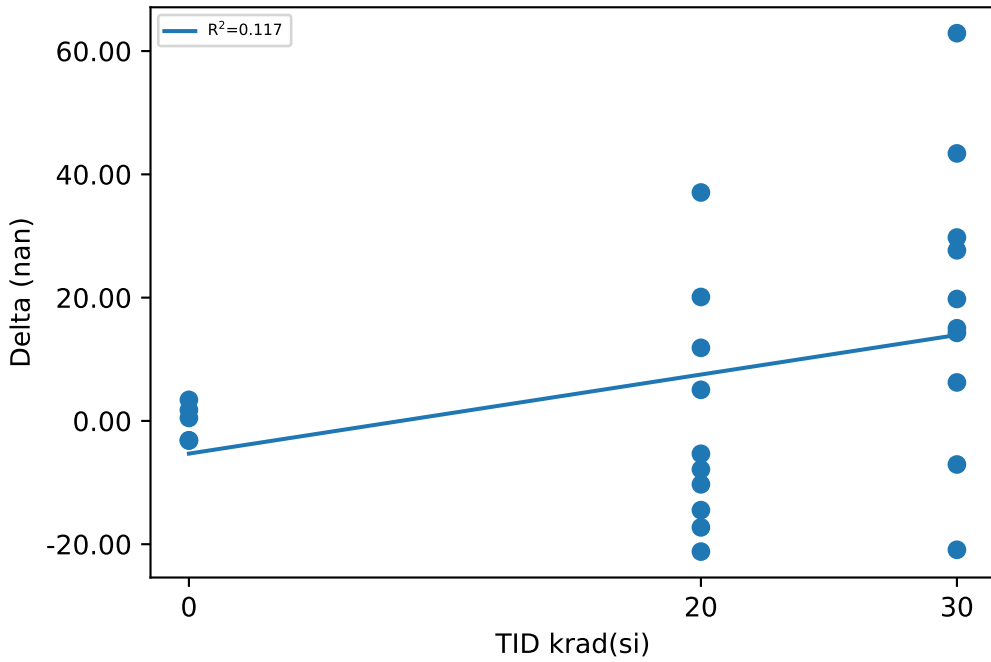

Test Statistics (nan)

krad(si)	Pre Exposure Min	Pre Exposure Avg	Pre Exposure Max	Pre Exposure Std	Post Exposure Min	Post Exposure Avg	Post Exposure Max	Post Exposure Std	Min Delta	Avg Delta	Max Delta	Std Delta
0	2434.6	2482.1	2530.2	43.05	2437.6	2481.9	2532	42.892	-3.184	-0.1314	3.416	2.9564
20	2438.3	2481.6	2540.3	37.121	2427.4	2481.3	2557.1	39.989	-21.198	-0.2352	37.06	18.548
30	2424.7	2487	2538.9	37.583	2453.9	2506.1	2585.1	44.222	-20.904	19.11	62.899	24.005

Device Test: 11.2 UJSYNT(dCLR_P5A_CH1_UJSYNT)

TID vs Result Stats

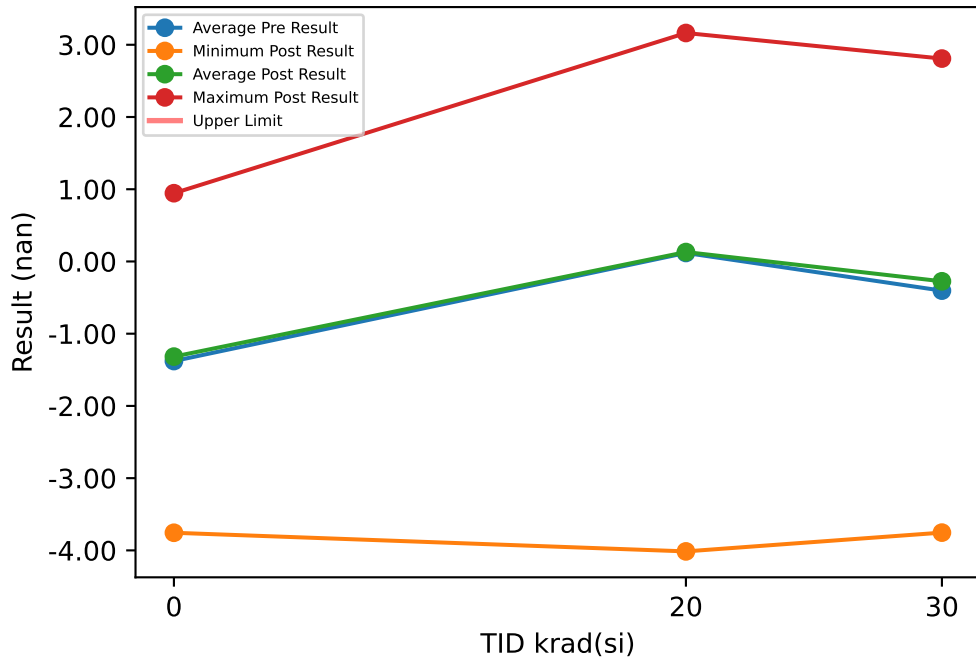

Test Results (No Limits Specified (nan))

Serial #	krad(si)	Exposure Conditions	Pre Result	Post Result	Delta
1	20	HDR unbiased	-3.349	-4.014	-0.665
2	20	HDR unbiased	0.517	1.003	0.486
3	20	HDR unbiased	0.657	1.323	0.666
4	20	HDR unbiased	-0.67	0.138	0.808
5	20	HDR unbiased	1.907	3.163	1.256
6	20	HDR biased	-1.211	0.824	2.035
7	20	HDR biased	0.966	0.756	-0.21
8	20	HDR biased	0.516	-0.437	-0.953
9	20	HDR biased	0.632	0.416	-0.216
10	20	HDR biased	1.211	-1.869	-3.08
11	30	HDR unbiased	0.838	0.222	-0.616
12	30	HDR unbiased	1.111	0.219	-0.892
13	30	HDR unbiased	-2.426	-1.712	0.714
14	30	HDR unbiased	0.827	-1.799	-2.626
15	30	HDR unbiased	0.898	1.177	0.279
16	30	HDR biased	0.083	0.832	0.749
17	30	HDR biased	-2.136	-3.754	-1.618
18	30	HDR biased	0.027	0.83	0.803
19	30	HDR biased	-1.866	2.809	4.675
20	30	HDR biased	-1.394	-1.569	-0.175
21	0	correlation	0.845	0.945	0.1
22	0	correlation	-1.477	-1.592	-0.115
23	0	correlation	-2.597	-2.573	0.024
24	0	correlation	0.151	0.39	0.239
25	0	correlation	-3.816	-3.756	0.06

TID vs Post - Pre Exposure Delta

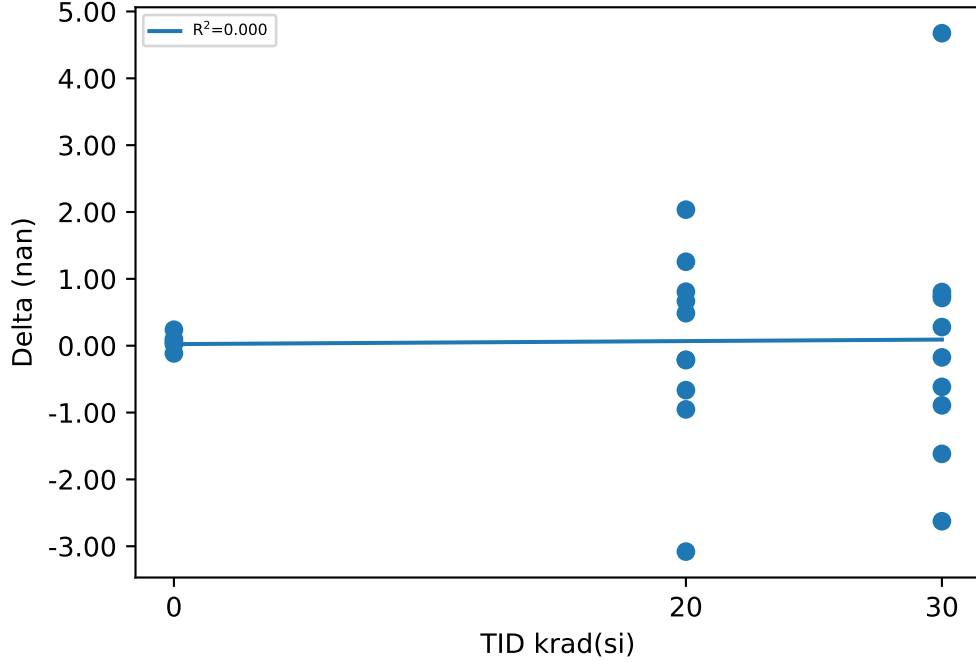

Test Statistics (nan)

krad(si)	Pre Exposure Min	Pre Exposure Avg	Pre Exposure Max	Pre Exposure Std	Post Exposure Min	Post Exposure Avg	Post Exposure Max	Post Exposure Std	Min Delta	Avg Delta	Max Delta	Std Delta
0	-3.816	-1.3788	0.845	1.9183	-3.756	-1.3172	0.945	1.9769	-0.115	0.0616	0.239	0.12801
20	-3.349	0.1176	1.907	1.5053	-4.014	0.1303	3.163	1.9388	-3.08	0.0127	2.035	1.4133
30	-2.426	-0.4038	1.111	1.4015	-3.754	-0.2745	2.809	1.9068	-2.626	0.1293	4.675	1.9494

Device Test: 11.21 UJET8J(KCL_P25A_CH4_UJET8J)

TID vs Result Stats

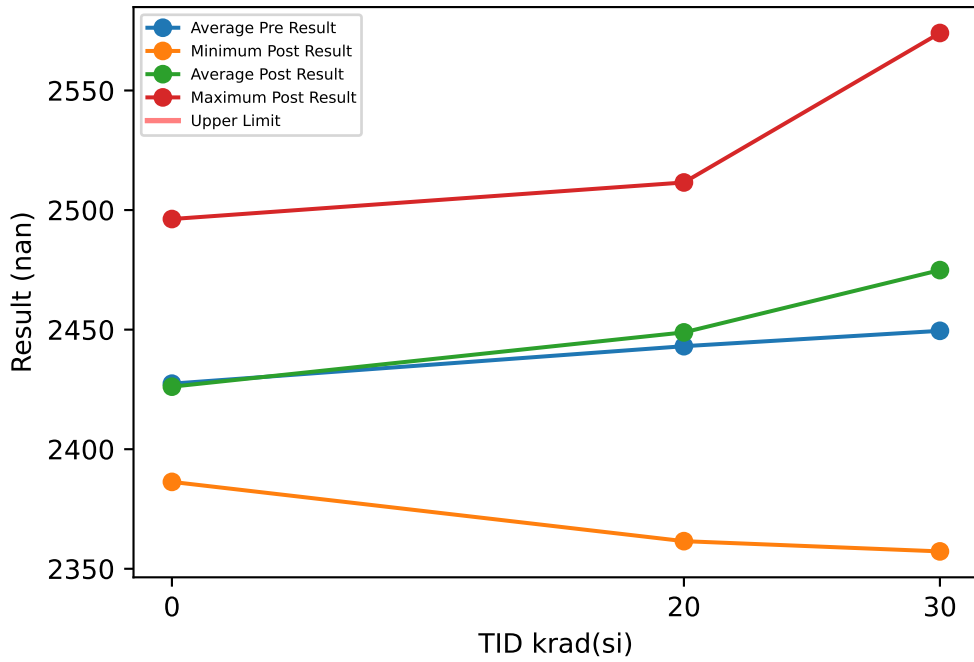

Test Results (No Limits Specified (nan))

Serial #	krad(si)	Exposure Conditions	Pre Result	Post Result	Delta
1	20	HDR unbiased	2454.3	2409.3	-45.075
2	20	HDR unbiased	2374.6	2361.5	-13.028
3	20	HDR unbiased	2486.6	2498	11.403
4	20	HDR unbiased	2516.6	2511.5	-5.062
5	20	HDR unbiased	2469.5	2462.9	-6.639
6	20	HDR biased	2403.2	2426.8	23.613
7	20	HDR biased	2459.7	2477.6	17.962
8	20	HDR biased	2440.4	2452.8	12.441
9	20	HDR biased	2408.3	2457.4	49.072
10	20	HDR biased	2417.6	2430.7	13.078
11	30	HDR unbiased	2454.4	2474.3	19.927
12	30	HDR unbiased	2554.3	2538.7	-15.671
13	30	HDR unbiased	2349.4	2357.3	7.866
14	30	HDR unbiased	2377.6	2460.5	82.916
15	30	HDR unbiased	2425.5	2443.6	18.126
16	30	HDR biased	2503.3	2527.4	24.038
17	30	HDR biased	2524.5	2574	49.524
18	30	HDR biased	2357.3	2398.3	40.964
19	30	HDR biased	2442.1	2402.2	-39.842
20	30	HDR biased	2506.6	2572.6	66.059
21	0	correlation	2450.6	2448.5	-2.076
22	0	correlation	2391.5	2389.6	-1.902
23	0	correlation	2492.7	2496.2	3.529
24	0	correlation	2390.4	2386.3	-4.098
25	0	correlation	2411.8	2410.1	-1.726

TID vs Post - Pre Exposure Delta

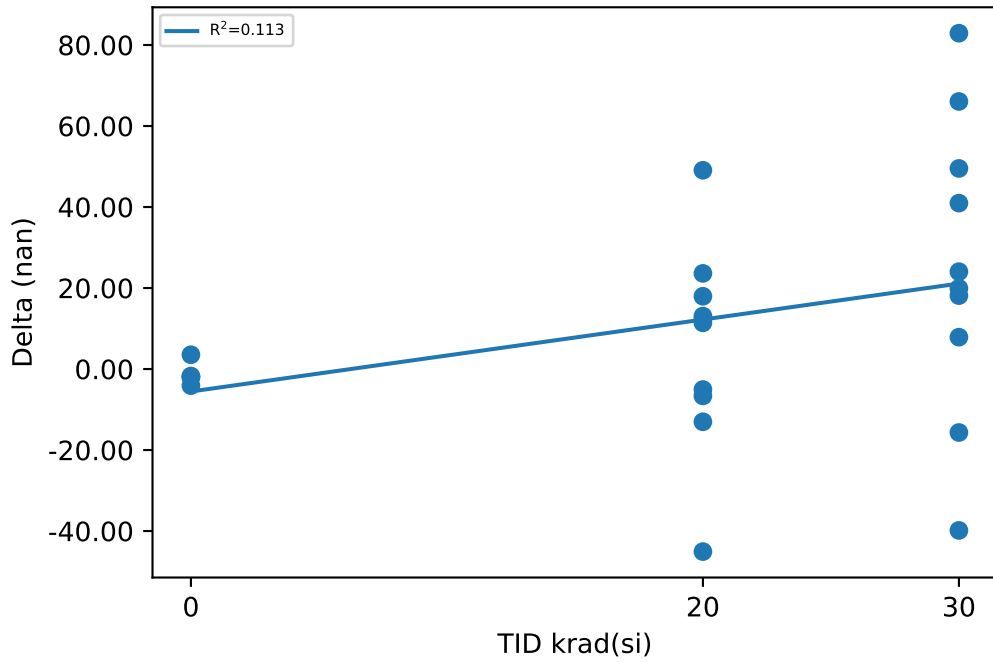

Test Statistics (nan)

krad(si)	Pre Exposure Min	Pre Exposure Avg	Pre Exposure Max	Pre Exposure Std	Post Exposure Min	Post Exposure Avg	Post Exposure Max	Post Exposure Std	Min Delta	Avg Delta	Max Delta	Std Delta
0	2390.4	2427.4	2492.7	43.881	2386.3	2426.1	2496.2	46.348	-4.098	-1.2546	3.529	2.8409
20	2374.6	2443.1	2516.6	42.877	2361.5	2448.8	2511.5	44.047	-45.075	5.7765	49.072	25.125
30	2349.4	2449.5	2554.3	72.353	2357.3	2474.9	2574	76.285	-39.842	25.391	82.916	36.698

Device Test: 11.23 UJP0M9(dCLR_2A_CH1_UJP0M9)

TID vs Result Stats

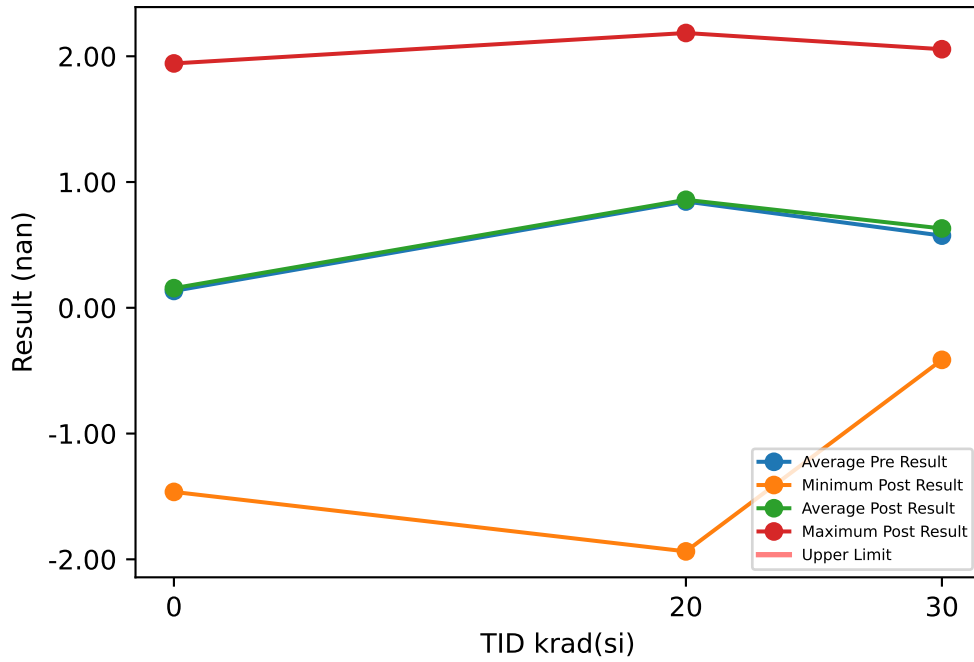

Test Results (No Limits Specified (nan))

Serial #	krad(si)	Exposure Conditions	Pre Result	Post Result	Delta
1	20	HDR unbiased	-1.772	-1.937	-0.165
2	20	HDR unbiased	1.71	1.93	0.22
3	20	HDR unbiased	1.288	1.523	0.235
4	20	HDR unbiased	0.639	0.957	0.318
5	20	HDR unbiased	1.397	1.765	0.368
6	20	HDR biased	-0.791	1.559	2.35
7	20	HDR biased	1.971	1.971	0
8	20	HDR biased	-0.057	-0.335	-0.278
9	20	HDR biased	2.327	2.185	-0.142
10	20	HDR biased	1.739	-1.031	-2.77
11	30	HDR unbiased	0.004	-0.292	-0.296
12	30	HDR unbiased	2.062	1.874	-0.188
13	30	HDR unbiased	0.261	0.435	0.174
14	30	HDR unbiased	0.703	-0.019	-0.722
15	30	HDR unbiased	1.92	2.056	0.136
16	30	HDR biased	0.184	0.405	0.221
17	30	HDR biased	-0.023	-0.414	-0.391
18	30	HDR biased	0.534	0.785	0.251
19	30	HDR biased	0.022	1.383	1.361
20	30	HDR biased	0.071	0.094	0.023
21	0	correlation	1.315	1.32	0.005
22	0	correlation	-0.064	-0.032	0.032
23	0	correlation	-0.972	-0.987	-0.015
24	0	correlation	1.787	1.943	0.156
25	0	correlation	-1.396	-1.464	-0.068

TID vs Post - Pre Exposure Delta

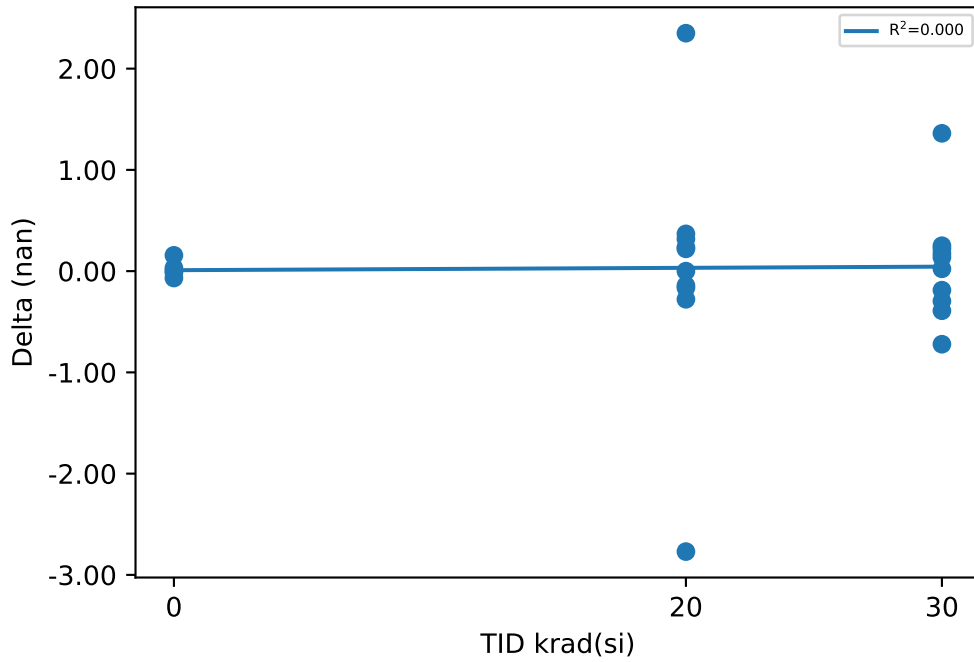

Test Statistics (nan)

krad(si)	Pre Exposure Min	Pre Exposure Avg	Pre Exposure Max	Pre Exposure Std	Post Exposure Min	Post Exposure Avg	Post Exposure Max	Post Exposure Std	Min Delta	Avg Delta	Max Delta	Std Delta
0	-1.396	0.134	1.787	1.3902	-1.464	0.156	1.943	1.459	-0.068	0.022	0.156	0.083388
20	-1.772	0.8451	2.327	1.3289	-1.937	0.8587	2.185	1.4422	-2.77	0.0136	2.35	1.2319
30	-0.023	0.5738	2.062	0.78409	-0.414	0.6307	2.056	0.87618	-0.722	0.0569	1.361	0.5556

Device Test: 11.24 UJP0M9(dCLR_2A_CH2_UJP0M9)

TID vs Result Stats

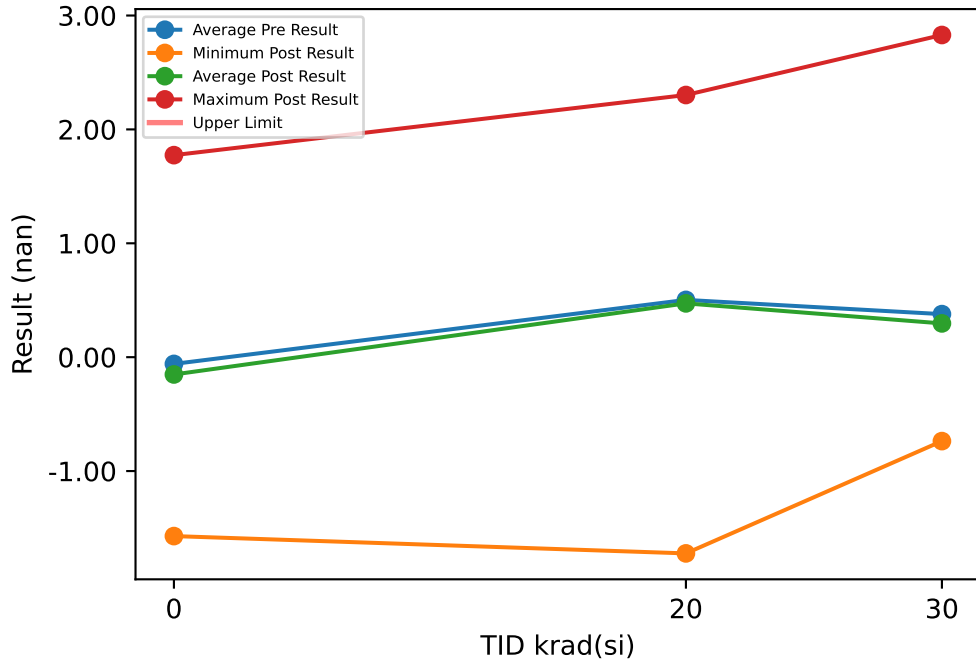

Test Results (No Limits Specified (nan))

Serial #	krad(si)	Exposure Conditions	Pre Result	Post Result	Delta
1	20	HDR unbiased	-0.007	-0.01	-0.003
2	20	HDR unbiased	0.128	0.353	0.225
3	20	HDR unbiased	1.608	1.476	-0.132
4	20	HDR unbiased	-1.736	-1.723	0.013
5	20	HDR unbiased	-0.366	-0.473	-0.107
6	20	HDR biased	1.834	0.155	-1.679
7	20	HDR biased	-0.719	-0.958	-0.239
8	20	HDR biased	1.609	1.489	-0.12
9	20	HDR biased	2.539	2.302	-0.237
10	20	HDR biased	0.139	2.113	1.974
11	30	HDR unbiased	0.285	0.175	-0.11
12	30	HDR unbiased	3.152	2.829	-0.323
13	30	HDR unbiased	-0.138	0.198	0.336
14	30	HDR unbiased	-0.613	0.13	0.743
15	30	HDR unbiased	0.595	0.469	-0.126
16	30	HDR biased	1.167	0.991	-0.176
17	30	HDR biased	-0.377	-0.737	-0.36
18	30	HDR biased	-0.034	-0.274	-0.24
19	30	HDR biased	-0.098	-0.38	-0.282
20	30	HDR biased	-0.159	-0.435	-0.276
21	0	correlation	-1.177	-1.295	-0.118
22	0	correlation	-0.834	-0.895	-0.061
23	0	correlation	1.847	1.774	-0.073
24	0	correlation	1.32	1.228	-0.092
25	0	correlation	-1.452	-1.571	-0.119

TID vs Post - Pre Exposure Delta

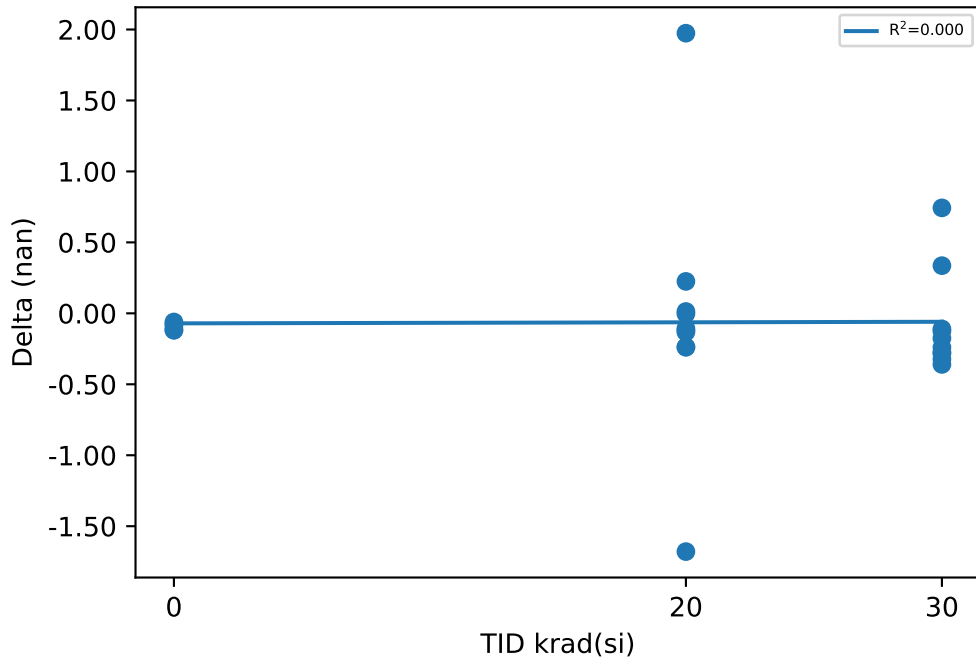

Test Statistics (nan)

krad(si)	Pre Exposure Min	Pre Exposure Avg	Pre Exposure Max	Pre Exposure Std	Post Exposure Min	Post Exposure Avg	Post Exposure Max	Post Exposure Std	Min Delta	Avg Delta	Max Delta	Std Delta
0	-1.452	-0.0592	1.847	1.5269	-1.571	-0.1518	1.774	1.54	-0.119	-0.0926	-0.061	0.026102
20	-1.736	0.5029	2.539	1.3398	-1.723	0.4724	2.302	1.3411	-1.679	-0.0305	1.974	0.87647
30	-0.613	0.378	3.152	1.0993	-0.737	0.2966	2.829	1.02	-0.36	-0.0814	0.743	0.35038

Device Test: 11.25 UJP0M9(dCLR_2A_CH3_UJP0M9)

TID vs Result Stats

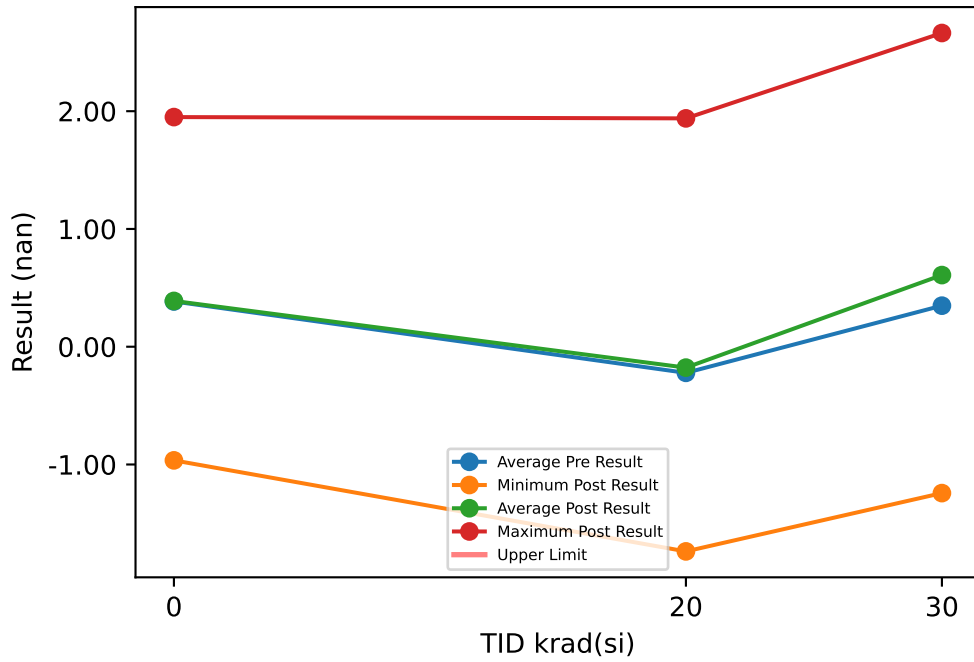

Test Results (No Limits Specified (nan))

Serial #	krad(si)	Exposure Conditions	Pre Result	Post Result	Delta
1	20	HDR unbiased	0.484	0.428	-0.056
2	20	HDR unbiased	0.536	0.29	-0.246
3	20	HDR unbiased	-1.924	-1.729	0.195
4	20	HDR unbiased	1.534	1.939	0.405
5	20	HDR unbiased	0.277	0.13	-0.147
6	20	HDR biased	-0.294	-0.695	-0.401
7	20	HDR biased	-0.77	-0.597	0.173
8	20	HDR biased	0.439	0.392	-0.047
9	20	HDR biased	-1.594	-1.738	-0.144
10	20	HDR biased	-0.906	-0.195	0.711
11	30	HDR unbiased	1.191	1.397	0.206
12	30	HDR unbiased	0.587	0.909	0.322
13	30	HDR unbiased	0.261	0.491	0.23
14	30	HDR unbiased	-1.347	-0.102	1.245
15	30	HDR unbiased	0.987	1.435	0.448
16	30	HDR biased	0.22	0.209	-0.011
17	30	HDR biased	1.98	2.664	0.684
18	30	HDR biased	0.925	1.153	0.228
19	30	HDR biased	0.17	-0.829	-0.999
20	30	HDR biased	-1.488	-1.243	0.245
21	0	correlation	0.009	0.019	0.01
22	0	correlation	1.87	1.95	0.08
23	0	correlation	1.277	1.241	-0.036
24	0	correlation	-0.33	-0.301	0.029
25	0	correlation	-0.905	-0.965	-0.06

TID vs Post - Pre Exposure Delta

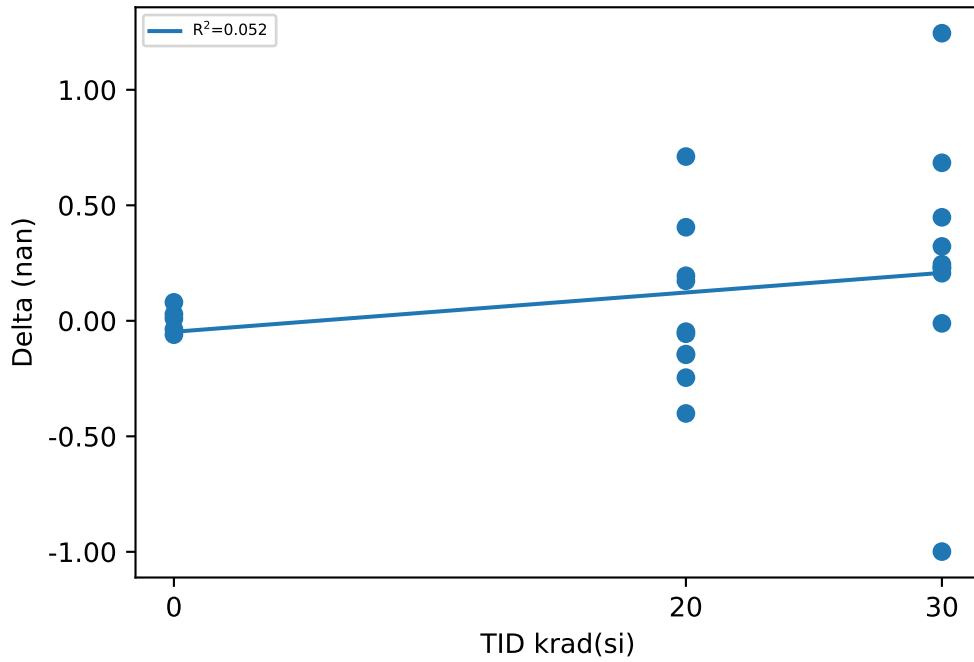

Test Statistics (nan)

krad(si)	Pre Exposure Min	Pre Exposure Avg	Pre Exposure Max	Pre Exposure Std	Post Exposure Min	Post Exposure Avg	Post Exposure Max	Post Exposure Std	Min Delta	Avg Delta	Max Delta	Std Delta
0	-0.905	0.3842	1.87	1.153	-0.965	0.3888	1.95	1.1842	-0.06	0.0046	0.08	0.055071
20	-1.924	-0.2218	1.534	1.0747	-1.738	-0.1775	1.939	1.0939	-0.401	0.0443	0.711	0.33114
30	-1.488	0.3486	1.98	1.0787	-1.243	0.6084	2.664	1.159	-0.999	0.2598	1.245	0.56301

Device Test: 11.26 UJP0M9(dCLR_2A_CH4_UJP0M9)

TID vs Result Stats

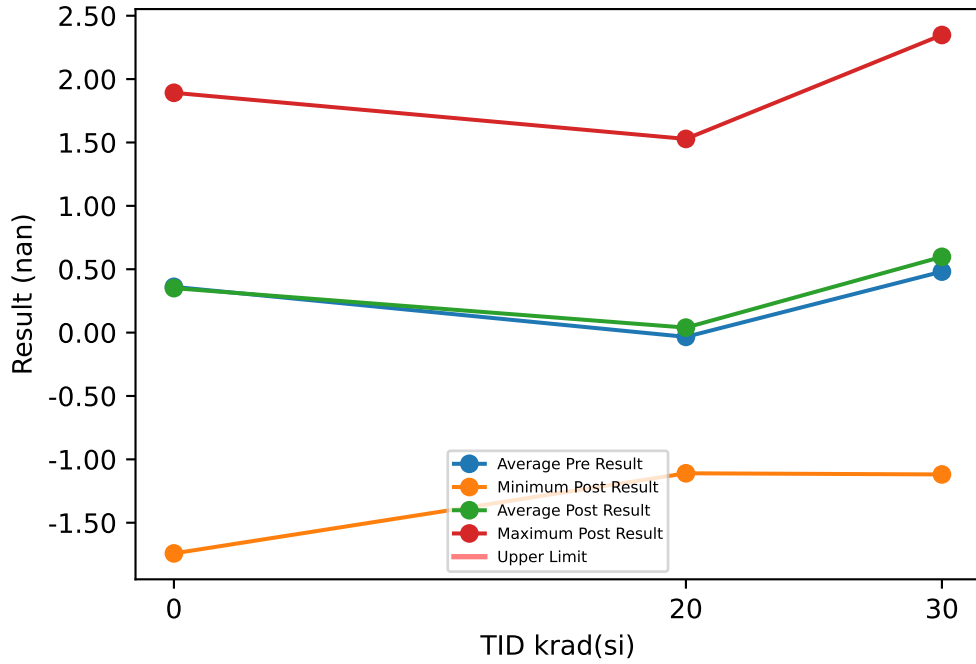

Test Results (No Limits Specified (nan))

Serial #	krad(si)	Exposure Conditions	Pre Result	Post Result	Delta
1	20	HDR unbiased	-0.706	-0.935	-0.229
2	20	HDR unbiased	-0.776	-0.922	-0.146
3	20	HDR unbiased	-0.068	0.024	0.092
4	20	HDR unbiased	0.146	0.275	0.129
5	20	HDR unbiased	-1.189	-1.11	0.079
6	20	HDR biased	-0.992	-0.303	0.689
7	20	HDR biased	1.41	1.528	0.118
8	20	HDR biased	1.365	1.516	0.151
9	20	HDR biased	0.916	1.153	0.237
10	20	HDR biased	-0.443	-0.832	-0.389
11	30	HDR unbiased	1.173	1.266	0.093
12	30	HDR unbiased	0.79	0.796	0.006
13	30	HDR unbiased	1.061	1.133	0.072
14	30	HDR unbiased	-0.719	-0.252	0.467
15	30	HDR unbiased	-1.208	-1.119	0.089
16	30	HDR biased	0.637	0.774	0.137
17	30	HDR biased	2.401	2.348	-0.053
18	30	HDR biased	1.25	1.469	0.219
19	30	HDR biased	-0.408	-0.626	-0.218
20	30	HDR biased	-0.165	0.189	0.354
21	0	correlation	0.872	0.86	-0.012
22	0	correlation	1.915	1.892	-0.023
23	0	correlation	1.879	1.883	0.004
24	0	correlation	-1.215	-1.139	0.076
25	0	correlation	-1.646	-1.742	-0.096

TID vs Post - Pre Exposure Delta

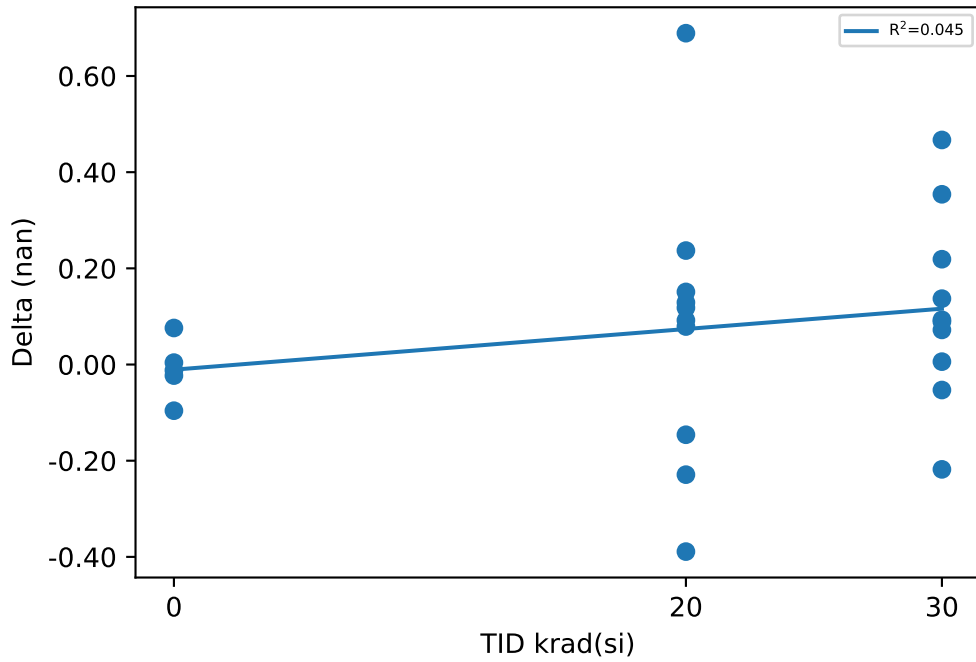

Test Statistics (nan)

krad(si)	Pre Exposure Min	Pre Exposure Avg	Pre Exposure Max	Pre Exposure Std	Post Exposure Min	Post Exposure Avg	Post Exposure Max	Post Exposure Std	Min Delta	Avg Delta	Max Delta	Std Delta
0	-1.646	0.361	1.915	1.695	-1.742	0.3508	1.892	1.7016	-0.096	-0.0102	0.076	0.061565
20	-1.189	-0.0337	1.41	0.96607	-1.11	0.0394	1.528	1.0416	-0.389	0.0731	0.689	0.29261
30	-1.208	0.4812	2.401	1.091	-1.119	0.5978	2.348	1.052	-0.218	0.1166	0.467	0.19616

Device Test: 11.27 UJP0M9(dCLR_3A_CH1_UJP0M9)

TID vs Result Stats

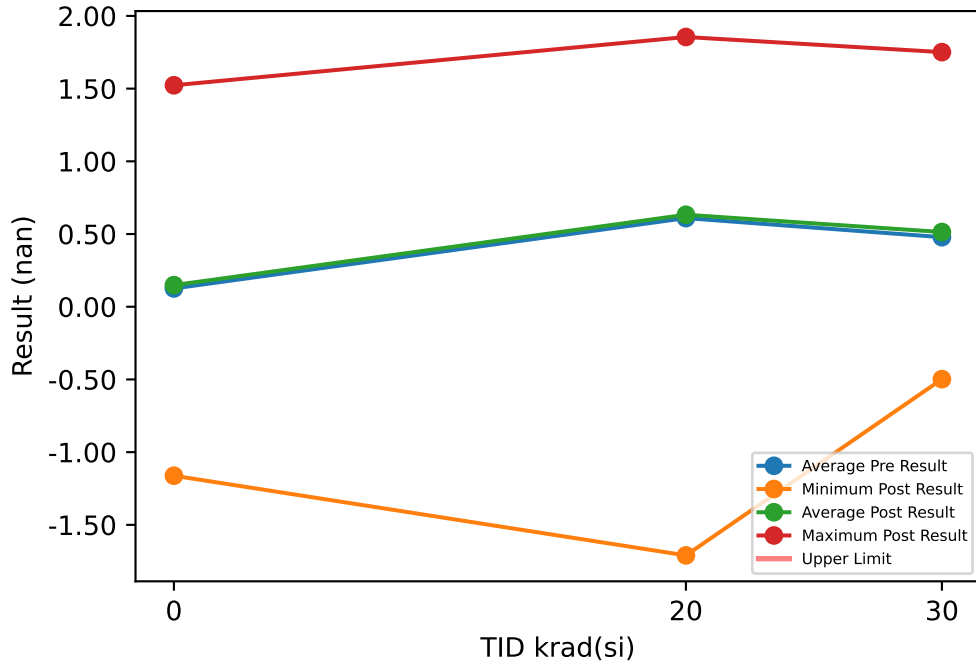

Test Results (No Limits Specified (nan))

Serial #	krad(si)	Exposure Conditions	Pre Result	Post Result	Delta
1	20	HDR unbiased	-1.598	-1.71	-0.112
2	20	HDR unbiased	1.276	1.464	0.188
3	20	HDR unbiased	0.978	1.148	0.17
4	20	HDR unbiased	0.416	0.73	0.314
5	20	HDR unbiased	0.881	1.112	0.231
6	20	HDR biased	-0.69	1.321	2.011
7	20	HDR biased	1.654	1.63	-0.024
8	20	HDR biased	-0.201	-0.355	-0.154
9	20	HDR biased	1.954	1.855	-0.099
10	20	HDR biased	1.425	-0.868	-2.293
11	30	HDR unbiased	-0.315	-0.498	-0.183
12	30	HDR unbiased	1.662	1.534	-0.128
13	30	HDR unbiased	0.396	0.442	0.046
14	30	HDR unbiased	0.615	0.184	-0.431
15	30	HDR unbiased	1.579	1.751	0.172
16	30	HDR biased	-0.052	0.067	0.119
17	30	HDR biased	0.155	-0.109	-0.264
18	30	HDR biased	0.417	0.597	0.18
19	30	HDR biased	0.183	1.006	0.823
20	30	HDR biased	0.144	0.164	0.02
21	0	correlation	0.923	0.923	0
22	0	correlation	0.033	0.08	0.047
23	0	correlation	-0.635	-0.62	0.015
24	0	correlation	1.451	1.523	0.072
25	0	correlation	-1.142	-1.162	-0.02

TID vs Post - Pre Exposure Delta

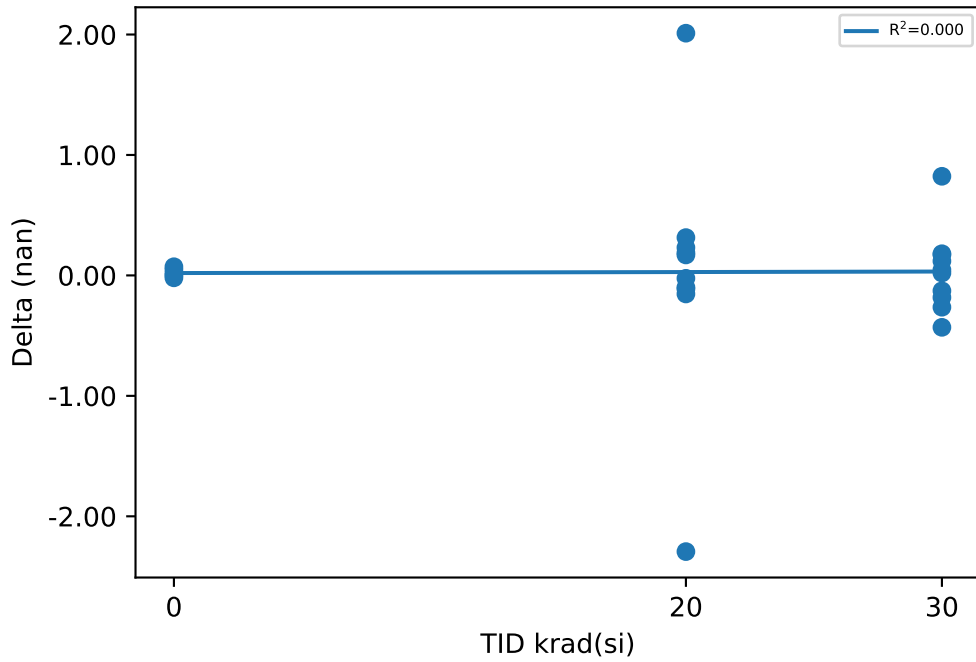

Test Statistics (nan)

krad(si)	Pre Exposure Min	Pre Exposure Avg	Pre Exposure Max	Pre Exposure Std	Post Exposure Min	Post Exposure Avg	Post Exposure Max	Post Exposure Std	Min Delta	Avg Delta	Max Delta	Std Delta
0	-1.142	0.126	1.451	1.0708	-1.162	0.1488	1.523	1.0956	-0.02	0.0228	0.072	0.036806
20	-1.598	0.6095	1.954	1.1291	-1.71	0.6327	1.855	1.196	-2.293	0.0232	2.011	1.0306
30	-0.315	0.4784	1.662	0.65455	-0.498	0.5138	1.751	0.7202	-0.431	0.0354	0.823	0.34137

Device Test: 11.28 UJP0M9(dCLR_3A_CH2_UJP0M9)

TID vs Result Stats

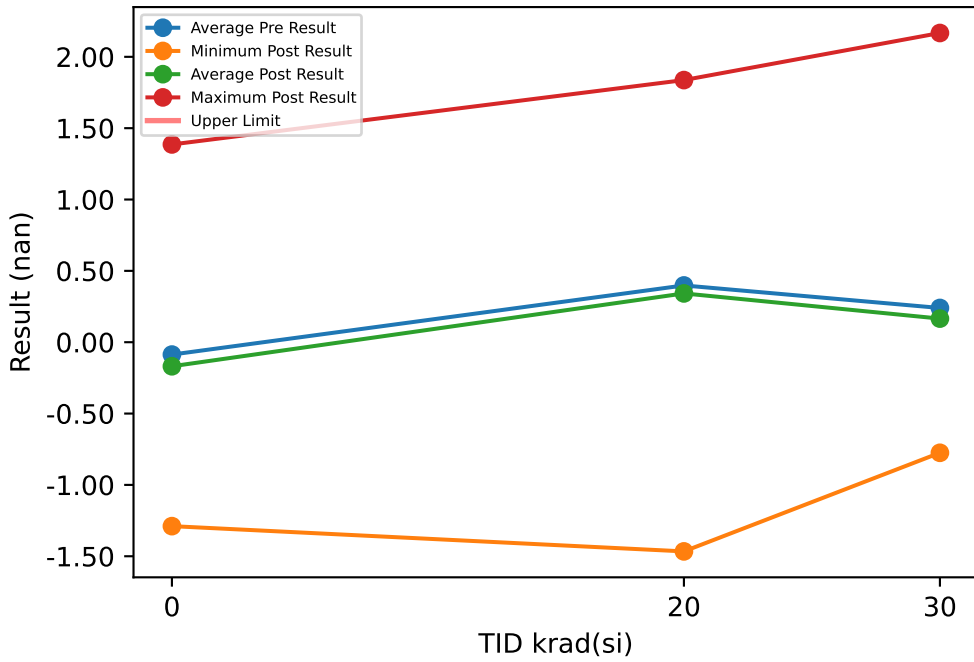

Test Results (No Limits Specified (nan))

Serial #	krad(si)	Exposure Conditions	Pre Result	Post Result	Delta
1	20	HDR unbiased	-0.095	-0.125	-0.03
2	20	HDR unbiased	0.182	0.36	0.178
3	20	HDR unbiased	1.172	1.004	-0.168
4	20	HDR unbiased	-1.46	-1.466	-0.006
5	20	HDR unbiased	-0.264	-0.383	-0.119
6	20	HDR biased	1.574	0.065	-1.509
7	20	HDR biased	-0.541	-0.735	-0.194
8	20	HDR biased	1.271	1.132	-0.139
9	20	HDR biased	2.003	1.837	-0.166
10	20	HDR biased	0.136	1.73	1.594
11	30	HDR unbiased	0.205	0.087	-0.118
12	30	HDR unbiased	2.439	2.167	-0.272
13	30	HDR unbiased	-0.078	0.157	0.235
14	30	HDR unbiased	-0.673	0.045	0.718
15	30	HDR unbiased	0.607	0.492	-0.115
16	30	HDR biased	0.853	0.695	-0.158
17	30	HDR biased	-0.481	-0.775	-0.294
18	30	HDR biased	-0.23	-0.389	-0.159
19	30	HDR biased	-0.09	-0.487	-0.397
20	30	HDR biased	-0.152	-0.337	-0.185
21	0	correlation	-1.099	-1.168	-0.069
22	0	correlation	-0.808	-0.9	-0.092
23	0	correlation	1.471	1.386	-0.085
24	0	correlation	1.238	1.128	-0.11
25	0	correlation	-1.235	-1.289	-0.054

TID vs Post - Pre Exposure Delta

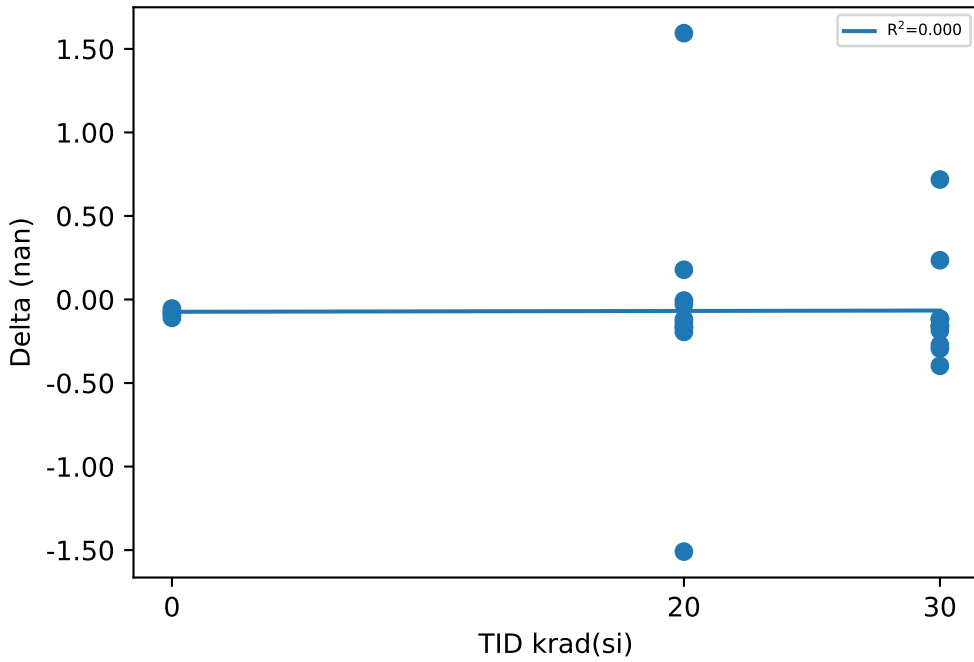

Test Statistics (nan)

krad(si)	Pre Exposure Min	Pre Exposure Avg	Pre Exposure Max	Pre Exposure Std	Post Exposure Min	Post Exposure Avg	Post Exposure Max	Post Exposure Std	Min Delta	Avg Delta	Max Delta	Std Delta
0	-1.235	-0.0866	1.471	1.3271	-1.289	-0.1686	1.386	1.3122	-0.11	-0.082	-0.054	0.021483
20	-1.46	0.3978	2.003	1.0776	-1.466	0.3419	1.837	1.0788	-1.509	-0.0559	1.594	0.74133
30	-0.673	0.24	2.439	0.89971	-0.775	0.1655	2.167	0.8356	-0.397	-0.0745	0.718	0.32402

Device Test: 11.29 UJP0M9(dCLR_3A_CH3_UJP0M9)

TID vs Result Stats

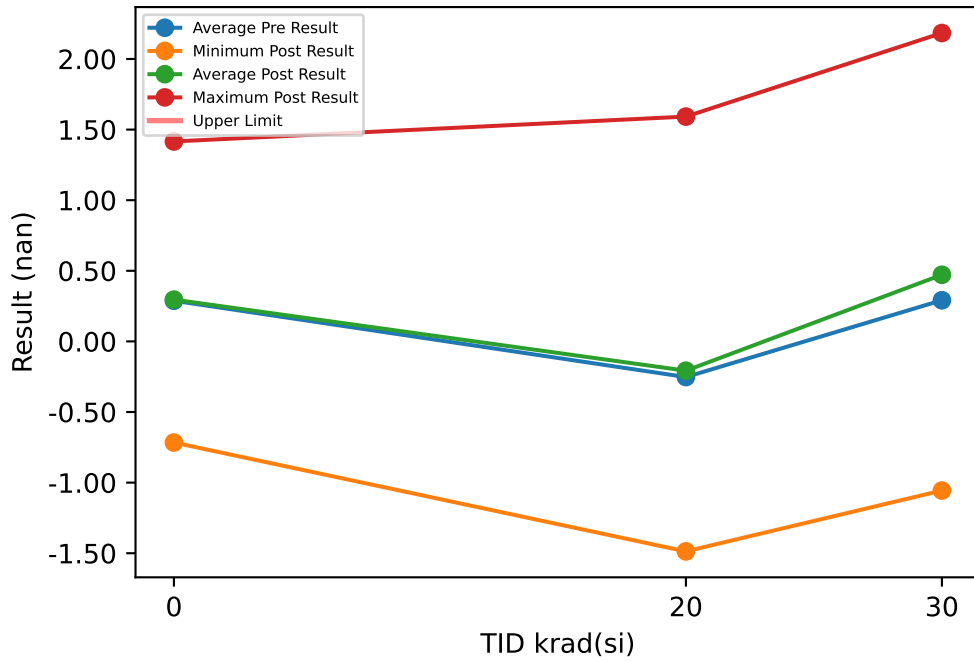

Test Results (No Limits Specified (nan))

Serial #	krad(si)	Exposure Conditions	Pre Result	Post Result	Delta
1	20	HDR unbiased	0.043	0.014	-0.029
2	20	HDR unbiased	0.339	0.183	-0.156
3	20	HDR unbiased	-1.702	-1.487	0.215
4	20	HDR unbiased	1.305	1.592	0.287
5	20	HDR unbiased	0.249	0.14	-0.109
6	20	HDR biased	-0.27	-0.45	-0.18
7	20	HDR biased	-0.762	-0.635	0.127
8	20	HDR biased	0.243	0.19	-0.053
9	20	HDR biased	-1.371	-1.446	-0.075
10	20	HDR biased	-0.598	-0.175	0.423
11	30	HDR unbiased	1.064	1.223	0.159
12	30	HDR unbiased	0.302	0.524	0.222
13	30	HDR unbiased	0.231	0.391	0.16
14	30	HDR unbiased	-1.033	-0.065	0.968
15	30	HDR unbiased	0.962	1.295	0.333
16	30	HDR biased	0.077	0.069	-0.008
17	30	HDR biased	1.737	2.184	0.447
18	30	HDR biased	0.707	0.816	0.109
19	30	HDR biased	0.116	-0.662	-0.778
20	30	HDR biased	-1.248	-1.056	0.192
21	0	correlation	-0.151	-0.138	0.013
22	0	correlation	1.443	1.416	-0.027
23	0	correlation	1.168	1.173	0.005
24	0	correlation	-0.324	-0.256	0.068
25	0	correlation	-0.696	-0.716	-0.02

TID vs Post - Pre Exposure Delta

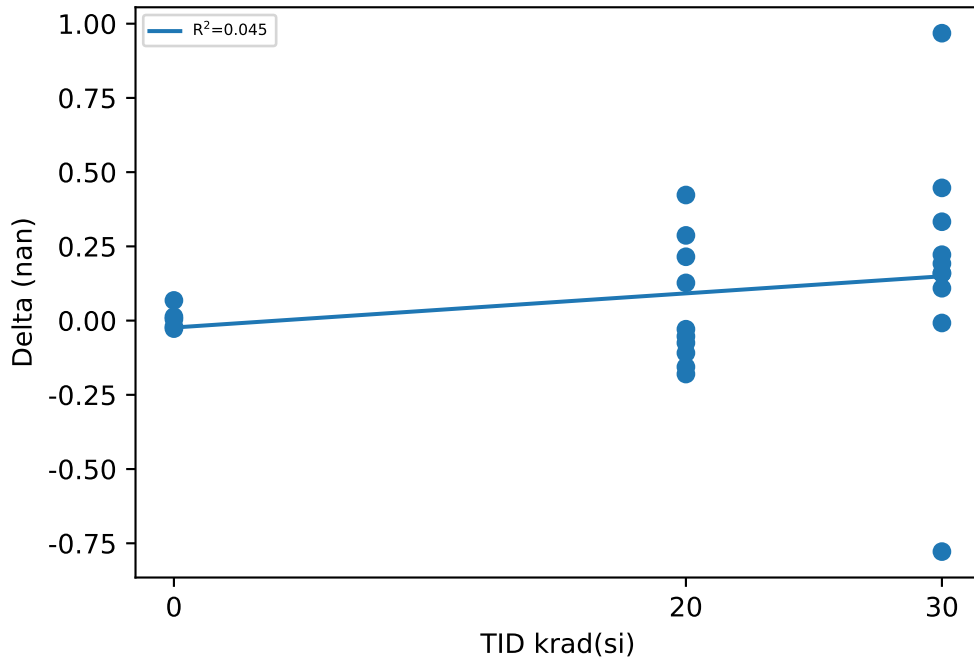

Test Statistics (nan)

krad(si)	Pre Exposure Min	Pre Exposure Avg	Pre Exposure Max	Pre Exposure Std	Post Exposure Min	Post Exposure Avg	Post Exposure Max	Post Exposure Std	Min Delta	Avg Delta	Max Delta	Std Delta
0	-0.696	0.288	1.443	0.95446	-0.716	0.2958	1.416	0.94084	-0.027	0.0078	0.068	0.037559
20	-1.702	-0.2524	1.305	0.88765	-1.487	-0.2074	1.592	0.8902	-0.18	0.045	0.423	0.20583
30	-1.248	0.2915	1.737	0.91368	-1.056	0.4719	2.184	0.96445	-0.778	0.1804	0.968	0.4316

Device Test: 11.30 UJP0M9(dCLR_3A_CH4_UJP0M9)

TID vs Result Stats

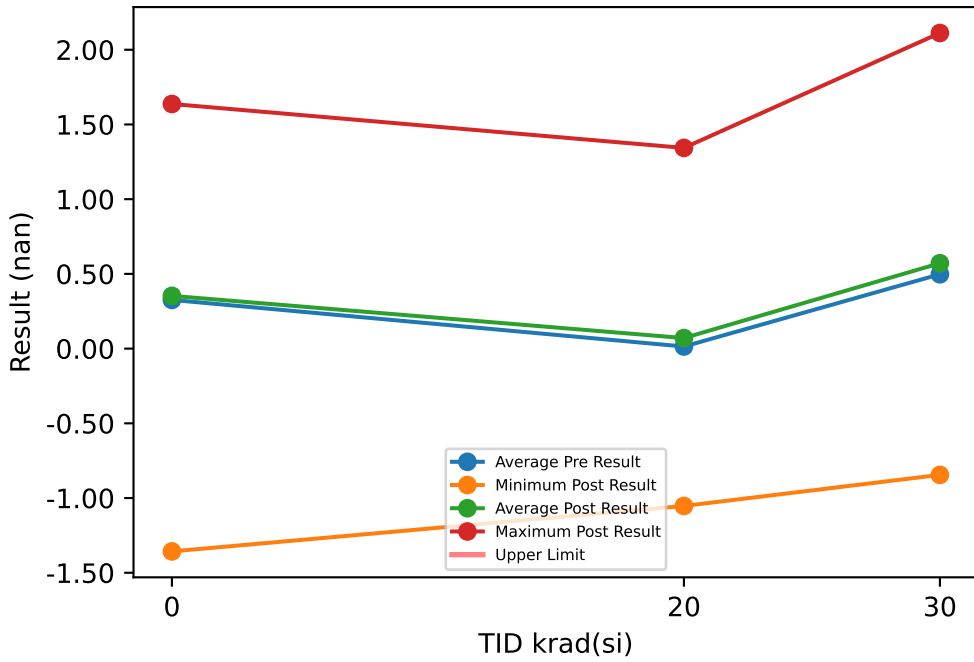

Test Results (No Limits Specified (nan))

Serial #	krad(si)	Exposure Conditions	Pre Result	Post Result	Delta
1	20	HDR unbiased	-0.641	-0.842	-0.201
2	20	HDR unbiased	-0.43	-0.499	-0.069
3	20	HDR unbiased	-0.088	-0.013	0.075
4	20	HDR unbiased	0.254	0.409	0.155
5	20	HDR unbiased	-1.111	-1.053	0.058
6	20	HDR biased	-0.851	-0.032	0.819
7	20	HDR biased	1.151	1.224	0.073
8	20	HDR biased	1.227	1.343	0.116
9	20	HDR biased	0.761	0.931	0.17
10	20	HDR biased	-0.132	-0.762	-0.63
11	30	HDR unbiased	1.127	1.183	0.056
12	30	HDR unbiased	0.571	0.55	-0.021
13	30	HDR unbiased	1.005	1.024	0.019
14	30	HDR unbiased	-0.432	-0.071	0.361
15	30	HDR unbiased	-0.908	-0.845	0.063
16	30	HDR biased	0.527	0.641	0.114
17	30	HDR biased	2.134	2.112	-0.022
18	30	HDR biased	1.216	1.401	0.185
19	30	HDR biased	-0.158	-0.432	-0.274
20	30	HDR biased	-0.107	0.152	0.259
21	0	correlation	0.653	0.677	0.024
22	0	correlation	1.639	1.637	-0.002
23	0	correlation	1.546	1.616	0.07
24	0	correlation	-0.843	-0.808	0.035
25	0	correlation	-1.366	-1.357	0.009

TID vs Post - Pre Exposure Delta

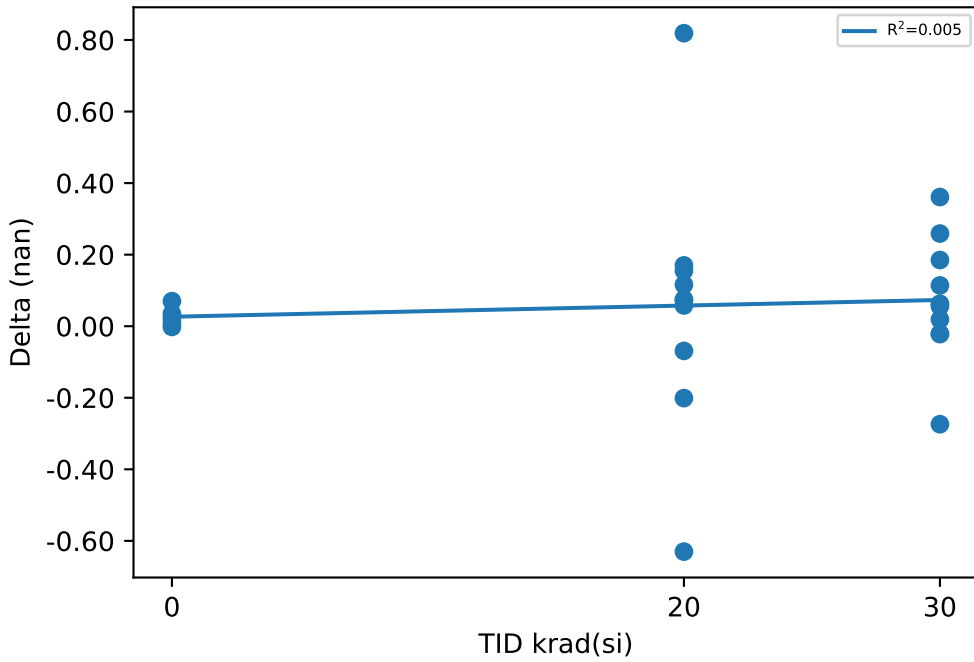

Test Statistics (nan)

krad(si)	Pre Exposure Min	Pre Exposure Avg	Pre Exposure Max	Pre Exposure Std	Post Exposure Min	Post Exposure Avg	Post Exposure Max	Post Exposure Std	Min Delta	Avg Delta	Max Delta	Std Delta
0	-1.366	0.3258	1.639	1.3737	-1.357	0.353	1.637	1.3803	-0.002	0.0272	0.07	0.027779
20	-1.111	0.014	1.227	0.81999	-1.053	0.0706	1.343	0.87779	-0.63	0.0566	0.819	0.35924
30	-0.908	0.4975	2.134	0.9122	-0.845	0.5715	2.112	0.89737	-0.274	0.074	0.361	0.17427

Device Test: 11.3 UJ9ZQ5(dCLR_P25A_CH2_UJ9ZQ5)

TID vs Result Stats

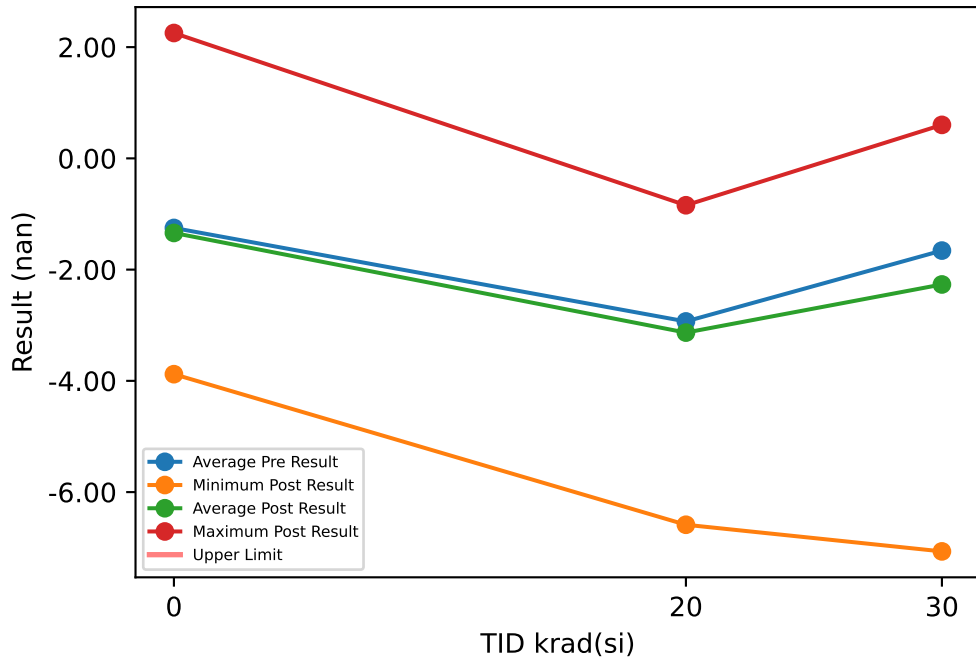

Test Results (No Limits Specified (nan))

Serial #	krad(si)	Exposure Conditions	Pre Result	Post Result	Delta
1	20	HDR unbiased	-1.427	-2.025	-0.598
2	20	HDR unbiased	-3.617	-2.358	1.259
3	20	HDR unbiased	-4.634	-5.138	-0.504
4	20	HDR unbiased	-1.608	-2.036	-0.428
5	20	HDR unbiased	-6.449	-6.587	-0.138
6	20	HDR biased	-4.117	-0.843	3.274
7	20	HDR biased	-3.436	-5.636	-2.2
8	20	HDR biased	-1.042	-1.762	-0.72
9	20	HDR biased	-2.044	-3.258	-1.214
10	20	HDR biased	-0.943	-1.681	-0.738
11	30	HDR unbiased	1.055	0.159	-0.896
12	30	HDR unbiased	-2.945	-4.659	-1.714
13	30	HDR unbiased	-1.744	0.602	2.346
14	30	HDR unbiased	-0.705	-2.775	-2.07
15	30	HDR unbiased	-1.651	-2.182	-0.531
16	30	HDR biased	-2	-3.116	-1.116
17	30	HDR biased	-5.032	-7.066	-2.034
18	30	HDR biased	-0.505	-1.537	-1.032
19	30	HDR biased	-3.138	0.182	3.32
20	30	HDR biased	0.087	-2.277	-2.364
21	0	correlation	-1.801	-2.034	-0.233
22	0	correlation	2.345	2.254	-0.091
23	0	correlation	-0.022	-0.025	-0.003
24	0	correlation	-3.063	-3.019	0.044
25	0	correlation	-3.714	-3.88	-0.166

TID vs Post - Pre Exposure Delta

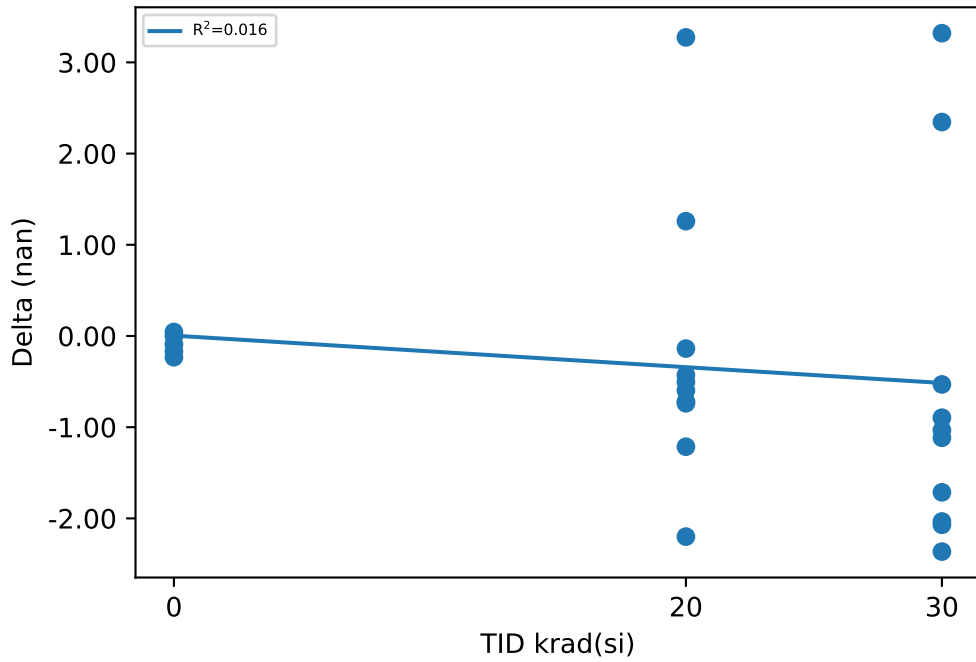

Test Statistics (nan)

krad(si)	Pre Exposure Min	Pre Exposure Avg	Pre Exposure Max	Pre Exposure Std	Post Exposure Min	Post Exposure Avg	Post Exposure Max	Post Exposure Std	Min Delta	Avg Delta	Max Delta	Std Delta
0	-3.714	-1.251	2.345	2.4543	-3.88	-1.3408	2.254	2.4697	-0.233	-0.0898	0.044	0.11374
20	-6.449	-2.9317	-0.943	1.8175	-6.587	-3.1324	-0.843	1.9577	-2.2	-0.2007	3.274	1.4941
30	-5.032	-1.6578	1.055	1.7638	-7.066	-2.2669	0.602	2.3661	-2.364	-0.6091	3.32	1.9195

Device Test: 11.31 UJP0M9(dCLR_4A_CH1_UJP0M9)

TID vs Result Stats

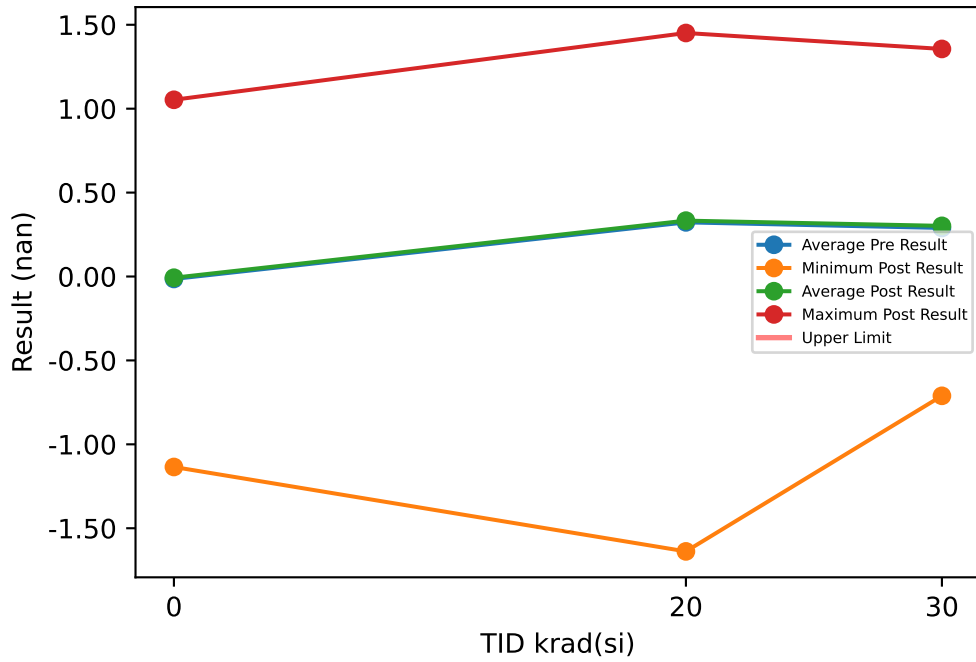

Test Results (No Limits Specified (nan))

Serial #	krad(si)	Exposure Conditions	Pre Result	Post Result	Delta
1	20	HDR unbiased	-1.578	-1.638	-0.06
2	20	HDR unbiased	0.82	1.001	0.181
3	20	HDR unbiased	0.619	0.738	0.119
4	20	HDR unbiased	0.173	0.388	0.215
5	20	HDR unbiased	0.407	0.574	0.167
6	20	HDR biased	-0.731	0.946	1.677
7	20	HDR biased	1.297	1.264	-0.033
8	20	HDR biased	-0.378	-0.509	-0.131
9	20	HDR biased	1.538	1.451	-0.087
10	20	HDR biased	1.059	-0.885	-1.944
11	30	HDR unbiased	-0.589	-0.711	-0.122
12	30	HDR unbiased	1.238	1.139	-0.099
13	30	HDR unbiased	0.309	0.303	-0.006
14	30	HDR unbiased	0.444	0.115	-0.329
15	30	HDR unbiased	1.261	1.356	0.095
16	30	HDR biased	-0.339	-0.256	0.083
17	30	HDR biased	0.115	-0.078	-0.193
18	30	HDR biased	0.236	0.355	0.119
19	30	HDR biased	0.167	0.752	0.585
20	30	HDR biased	0.051	0.043	-0.008
21	0	correlation	0.499	0.522	0.023
22	0	correlation	0.049	0.052	0.003
23	0	correlation	-0.556	-0.528	0.028
24	0	correlation	1.026	1.053	0.027
25	0	correlation	-1.091	-1.135	-0.044

TID vs Post - Pre Exposure Delta

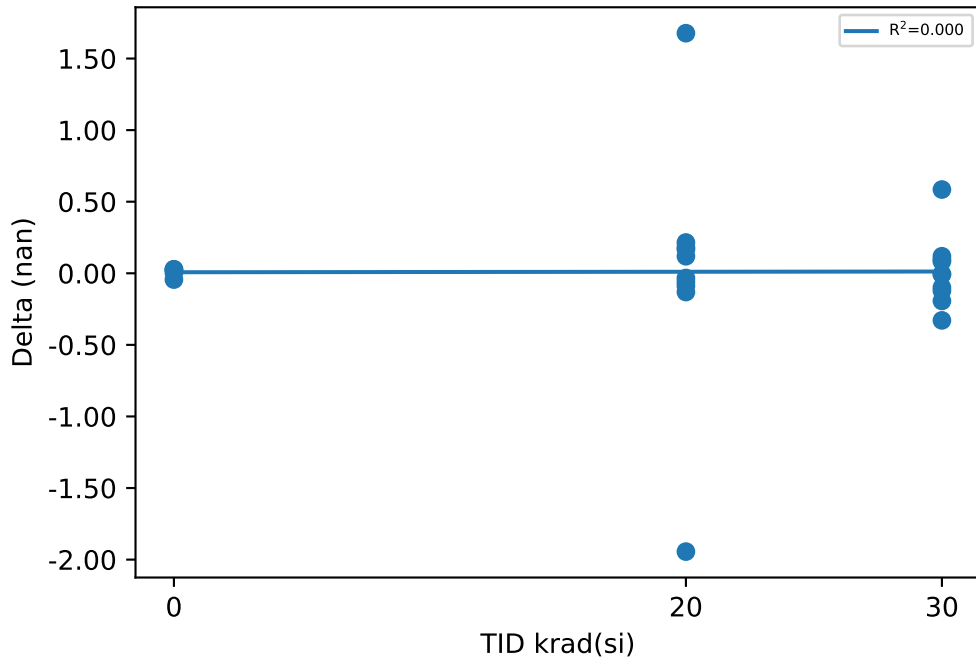

Test Statistics (nan)

krad(si)	Pre Exposure Min	Pre Exposure Avg	Pre Exposure Max	Pre Exposure Std	Post Exposure Min	Post Exposure Avg	Post Exposure Max	Post Exposure Std	Min Delta	Avg Delta	Max Delta	Std Delta
0	-1.091	-0.0146	1.026	0.83702	-1.135	-0.0072	1.053	0.85889	-0.044	0.0074	0.028	0.030468
20	-1.578	0.3226	1.538	0.9745	-1.638	0.333	1.451	1.0133	-1.944	0.0104	1.677	0.86544
30	-0.589	0.2893	1.261	0.59064	-0.711	0.3018	1.356	0.63252	-0.329	0.0125	0.585	0.24518

Device Test: 11.32 UJP0M9(dCLR_4A_CH2_UJP0M9)

TID vs Result Stats

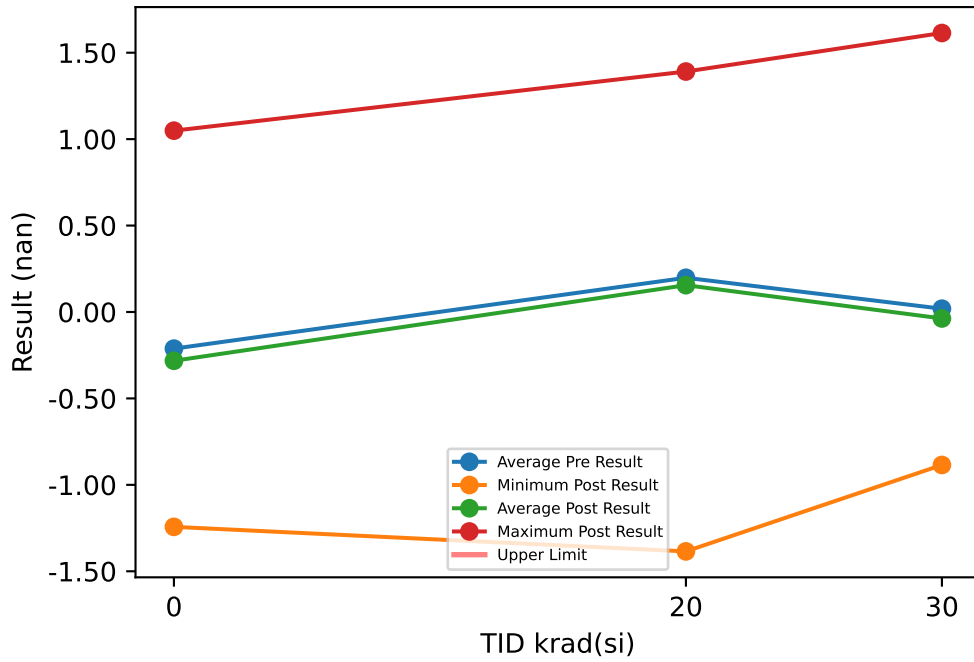

Test Results (No Limits Specified (nan))

Serial #	krad(si)	Exposure Conditions	Pre Result	Post Result	Delta
1	20	HDR unbiased	-0.265	-0.275	-0.01
2	20	HDR unbiased	0.08	0.214	0.134
3	20	HDR unbiased	0.775	0.656	-0.119
4	20	HDR unbiased	-1.387	-1.385	0.002
5	20	HDR unbiased	-0.341	-0.438	-0.097
6	20	HDR biased	1.241	-0.048	-1.289
7	20	HDR biased	-0.551	-0.686	-0.135
8	20	HDR biased	0.912	0.794	-0.118
9	20	HDR biased	1.549	1.391	-0.158
10	20	HDR biased	-0.034	1.328	1.362
11	30	HDR unbiased	0.02	-0.077	-0.097
12	30	HDR unbiased	1.802	1.614	-0.188
13	30	HDR unbiased	-0.146	0.001	0.147
14	30	HDR unbiased	-0.819	-0.147	0.672
15	30	HDR unbiased	0.441	0.383	-0.058
16	30	HDR biased	0.468	0.345	-0.123
17	30	HDR biased	-0.684	-0.885	-0.201
18	30	HDR biased	-0.431	-0.587	-0.156
19	30	HDR biased	-0.214	-0.647	-0.433
20	30	HDR biased	-0.247	-0.374	-0.127
21	0	correlation	-1.137	-1.24	-0.103
22	0	correlation	-0.853	-0.891	-0.038
23	0	correlation	1.096	1.049	-0.047
24	0	correlation	1.019	0.914	-0.105
25	0	correlation	-1.185	-1.243	-0.058

TID vs Post - Pre Exposure Delta

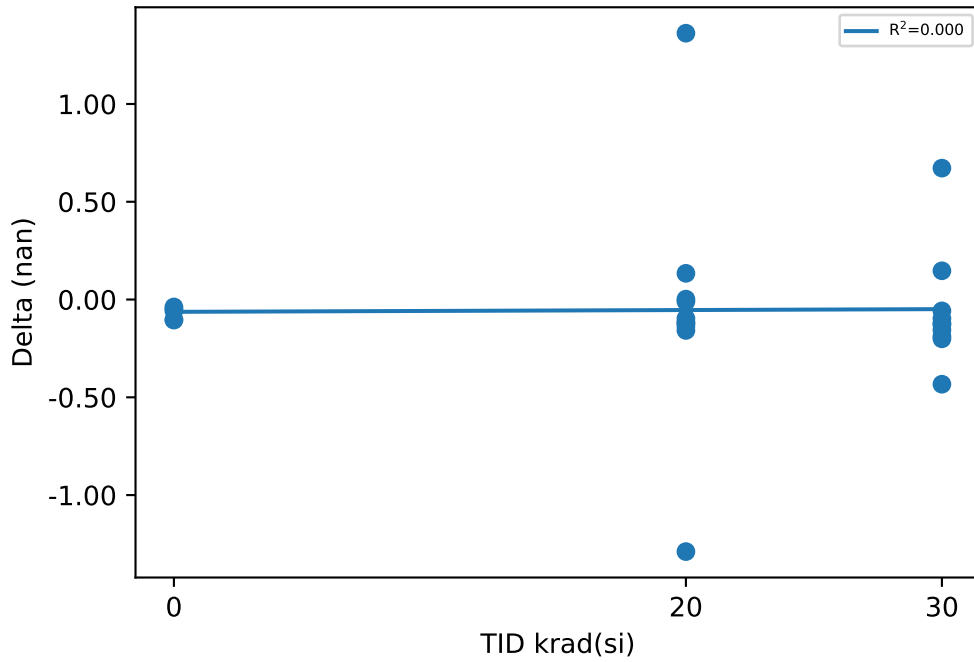

Test Statistics (nan)

krad(si)	Pre Exposure Min	Pre Exposure Avg	Pre Exposure Max	Pre Exposure Std	Post Exposure Min	Post Exposure Avg	Post Exposure Max	Post Exposure Std	Min Delta	Avg Delta	Max Delta	Std Delta
0	-1.185	-0.212	1.096	1.1661	-1.243	-0.2822	1.049	1.1634	-0.105	-0.0702	-0.038	0.031665
20	-1.387	0.1979	1.549	0.90687	-1.385	0.1551	1.391	0.89586	-1.289	-0.0428	1.362	0.63219
30	-0.819	0.019	1.802	0.75351	-0.885	-0.0374	1.614	0.71263	-0.433	-0.0564	0.672	0.29307

Device Test: 11.33 UJP0M9(dCLR_4A_CH3_UJP0M9)

TID vs Result Stats

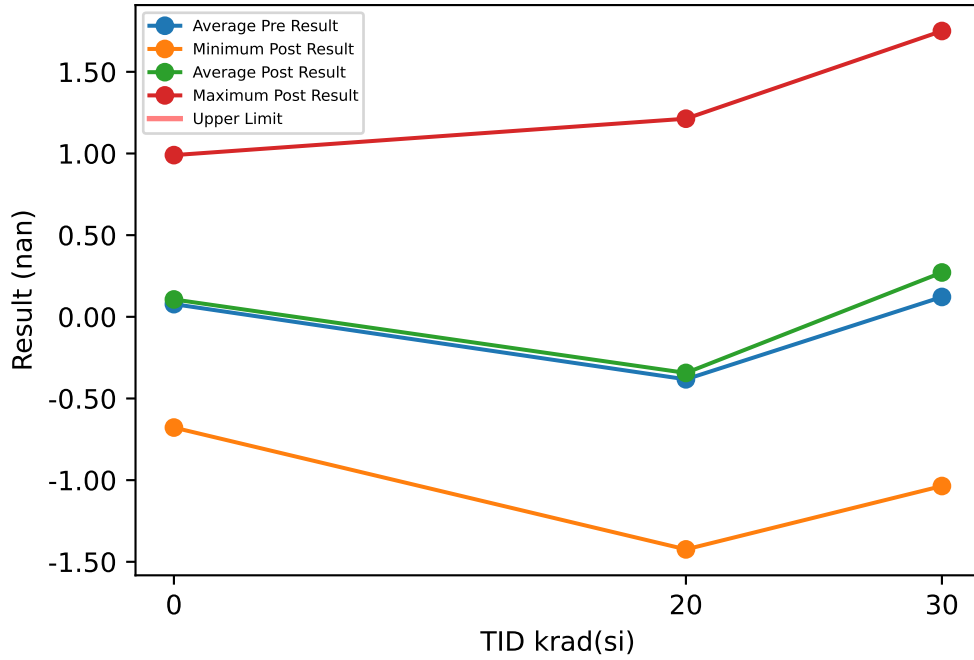

Test Results (No Limits Specified (nan))

Serial #	krad(si)	Exposure Conditions	Pre Result	Post Result	Delta
1	20	HDR unbiased	-0.341	-0.357	-0.016
2	20	HDR unbiased	0.122	0.006	-0.116
3	20	HDR unbiased	-1.569	-1.424	0.145
4	20	HDR unbiased	0.961	1.213	0.252
5	20	HDR unbiased	0.141	0.04	-0.101
6	20	HDR biased	-0.413	-0.436	-0.023
7	20	HDR biased	-0.891	-0.793	0.098
8	20	HDR biased	-0.01	-0.003	0.007
9	20	HDR biased	-1.276	-1.35	-0.074
10	20	HDR biased	-0.551	-0.331	0.22
11	30	HDR unbiased	0.827	1.021	0.194
12	30	HDR unbiased	0.053	0.218	0.165
13	30	HDR unbiased	0.103	0.221	0.118
14	30	HDR unbiased	-0.961	-0.149	0.812
15	30	HDR unbiased	0.792	1.034	0.242
16	30	HDR biased	-0.166	-0.17	-0.004
17	30	HDR biased	1.407	1.75	0.343
18	30	HDR biased	0.408	0.491	0.083
19	30	HDR biased	-0.061	-0.665	-0.604
20	30	HDR biased	-1.186	-1.036	0.15
21	0	correlation	-0.383	-0.325	0.058
22	0	correlation	0.954	0.981	0.027
23	0	correlation	0.969	0.99	0.021
24	0	correlation	-0.472	-0.436	0.036
25	0	correlation	-0.68	-0.678	0.002

TID vs Post - Pre Exposure Delta

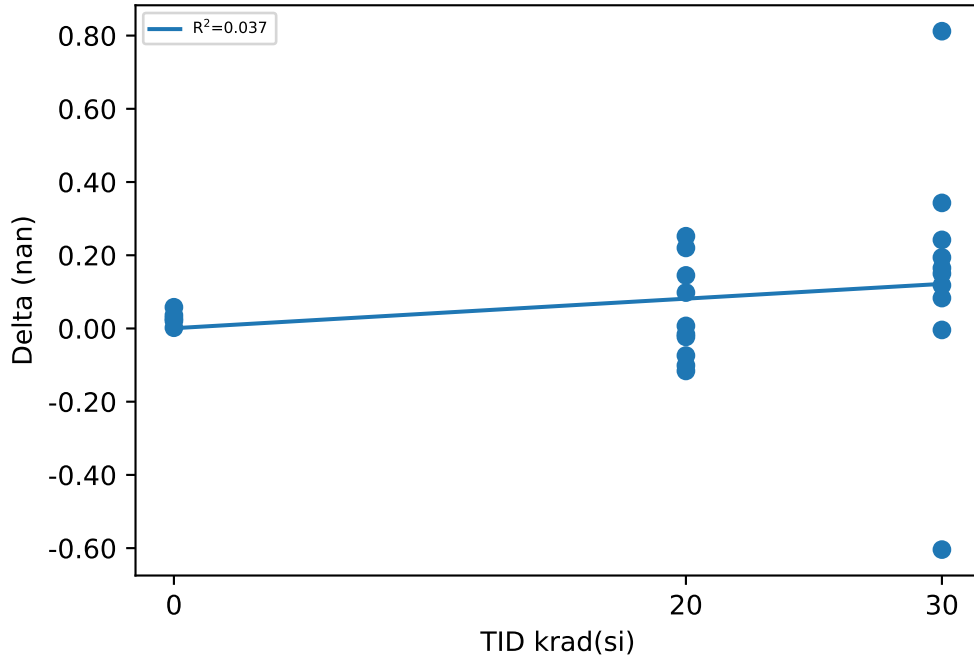

Test Statistics (nan)

krad(si)	Pre Exposure Min	Pre Exposure Avg	Pre Exposure Max	Pre Exposure Std	Post Exposure Min	Post Exposure Avg	Post Exposure Max	Post Exposure Std	Min Delta	Avg Delta	Max Delta	Std Delta
0	-0.68	0.0776	0.969	0.81407	-0.678	0.1064	0.99	0.8126	0.002	0.0288	0.058	0.020535
20	-1.569	-0.3827	0.961	0.74297	-1.424	-0.3435	1.213	0.76007	-0.116	0.0392	0.252	0.13213
30	-1.186	0.1216	1.407	0.79472	-1.036	0.2715	1.75	0.83938	-0.604	0.1499	0.812	0.34703

Device Test: 11.34 UJP0M9(dCLR_4A_CH4_UJP0M9)

TID vs Result Stats

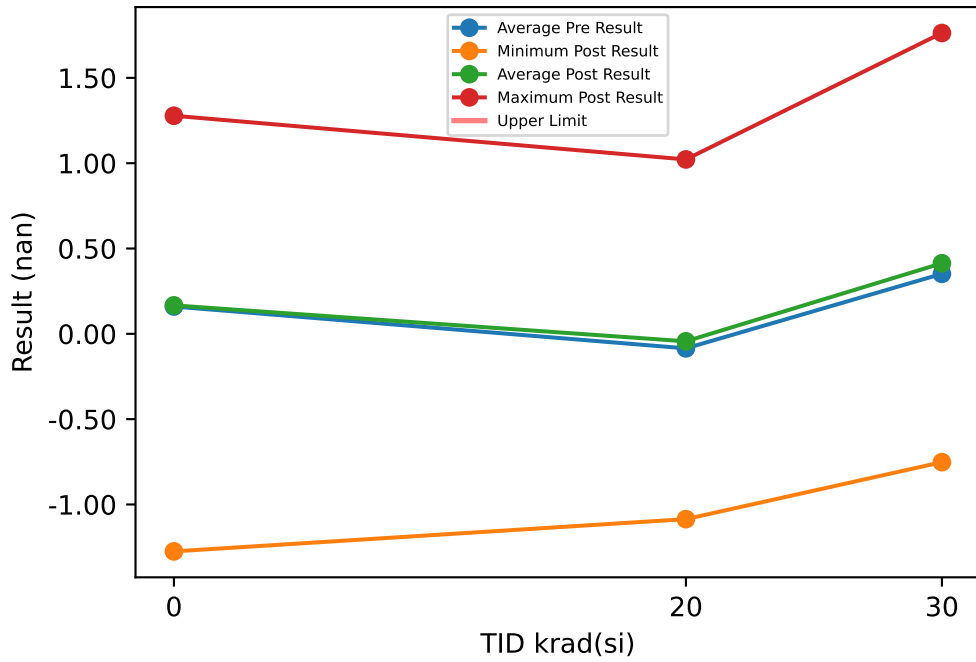

Test Results (No Limits Specified (nan))

Serial #	krad(si)	Exposure Conditions	Pre Result	Post Result	Delta
1	20	HDR unbiased	-0.706	-0.841	-0.135
2	20	HDR unbiased	-0.396	-0.443	-0.047
3	20	HDR unbiased	-0.208	-0.121	0.087
4	20	HDR unbiased	0.224	0.328	0.104
5	20	HDR unbiased	-1.158	-1.086	0.072
6	20	HDR biased	-0.857	0.011	0.868
7	20	HDR biased	0.84	0.9	0.06
8	20	HDR biased	0.992	1.022	0.03
9	20	HDR biased	0.486	0.587	0.101
10	20	HDR biased	-0.068	-0.795	-0.727
11	30	HDR unbiased	0.942	0.977	0.035
12	30	HDR unbiased	0.251	0.285	0.034
13	30	HDR unbiased	0.753	0.773	0.02
14	30	HDR unbiased	-0.491	-0.027	0.464
15	30	HDR unbiased	-0.815	-0.752	0.063
16	30	HDR biased	0.361	0.437	0.076
17	30	HDR biased	1.807	1.763	-0.044
18	30	HDR biased	1.01	1.126	0.116
19	30	HDR biased	-0.124	-0.476	-0.352
20	30	HDR biased	-0.178	0.03	0.208
21	0	correlation	0.341	0.35	0.009
22	0	correlation	1.281	1.278	-0.003
23	0	correlation	1.188	1.242	0.054
24	0	correlation	-0.763	-0.761	0.002
25	0	correlation	-1.247	-1.275	-0.028

TID vs Post - Pre Exposure Delta

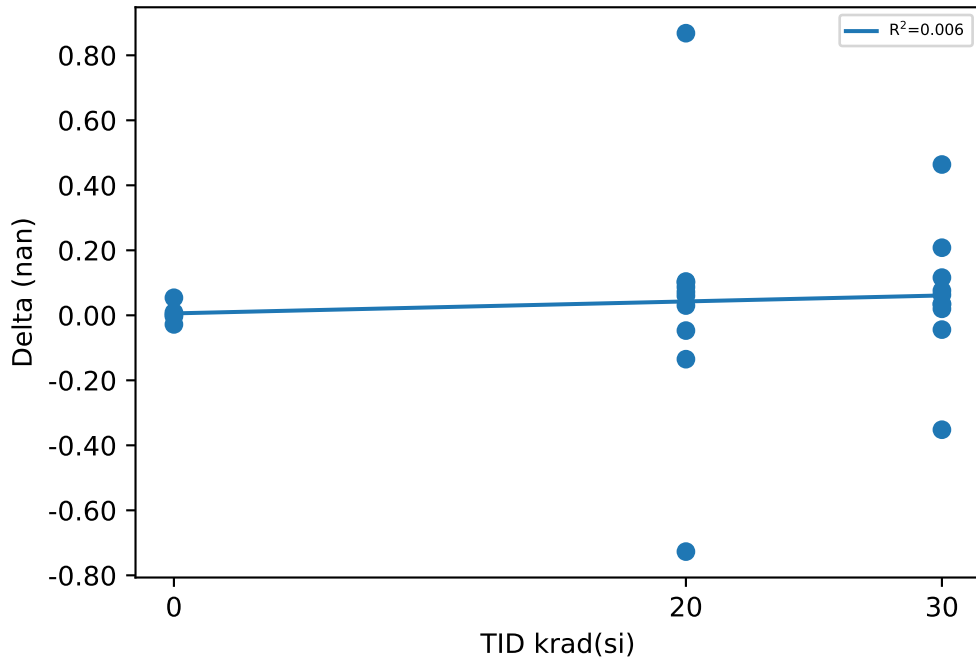

Test Statistics (nan)

krad(si)	Pre Exposure Min	Pre Exposure Avg	Pre Exposure Max	Pre Exposure Std	Post Exposure Min	Post Exposure Avg	Post Exposure Max	Post Exposure Std	Min Delta	Avg Delta	Max Delta	Std Delta
0	-1.247	0.16	1.281	1.1377	-1.275	0.1668	1.278	1.158	-0.028	0.0068	0.054	0.029845
20	-1.158	-0.0851	0.992	0.72128	-1.086	-0.0438	1.022	0.74663	-0.727	0.0413	0.868	0.38349
30	-0.815	0.3516	1.807	0.79227	-0.752	0.4136	1.763	0.76619	-0.352	0.062	0.464	0.20329

Device Test: 11.39 UJET8J(KCL_2A_CH1_UJET8J)

TID vs Result Stats

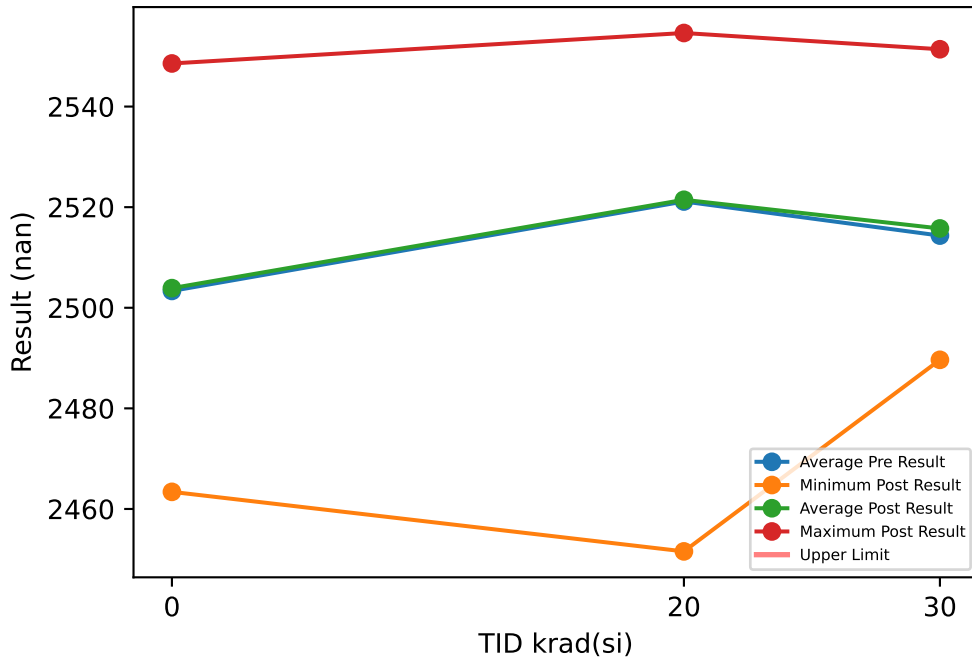

Test Results (No Limits Specified (nan))

Serial #	krad(si)	Exposure Conditions	Pre Result	Post Result	Delta
1	20	HDR unbiased	2455.7	2451.6	-4.124
2	20	HDR unbiased	2542.8	2548.3	5.501
3	20	HDR unbiased	2532.2	2538.1	5.876
4	20	HDR unbiased	2516	2523.9	7.968
5	20	HDR unbiased	2534.9	2544.1	9.195
6	20	HDR biased	2480.2	2539	58.732
7	20	HDR biased	2549.3	2549.3	0.016
8	20	HDR biased	2498.6	2491.6	-6.941
9	20	HDR biased	2558.2	2554.6	-3.543
10	20	HDR biased	2543.5	2474.2	-69.258
11	30	HDR unbiased	2500.1	2492.7	-7.396
12	30	HDR unbiased	2551.6	2546.9	-4.698
13	30	HDR unbiased	2506.5	2510.9	4.346
14	30	HDR unbiased	2517.6	2499.5	-18.06
15	30	HDR unbiased	2548	2551.4	3.383
16	30	HDR biased	2504.6	2510.1	5.519
17	30	HDR biased	2499.4	2489.7	-9.783
18	30	HDR biased	2513.4	2519.6	6.268
19	30	HDR biased	2500.6	2534.6	34.014
20	30	HDR biased	2501.8	2502.3	0.58
21	0	correlation	2532.9	2533	0.132
22	0	correlation	2498.4	2499.2	0.817
23	0	correlation	2475.7	2475.3	-0.364
24	0	correlation	2544.7	2548.6	3.882
25	0	correlation	2465.1	2463.4	-1.687

TID vs Post - Pre Exposure Delta

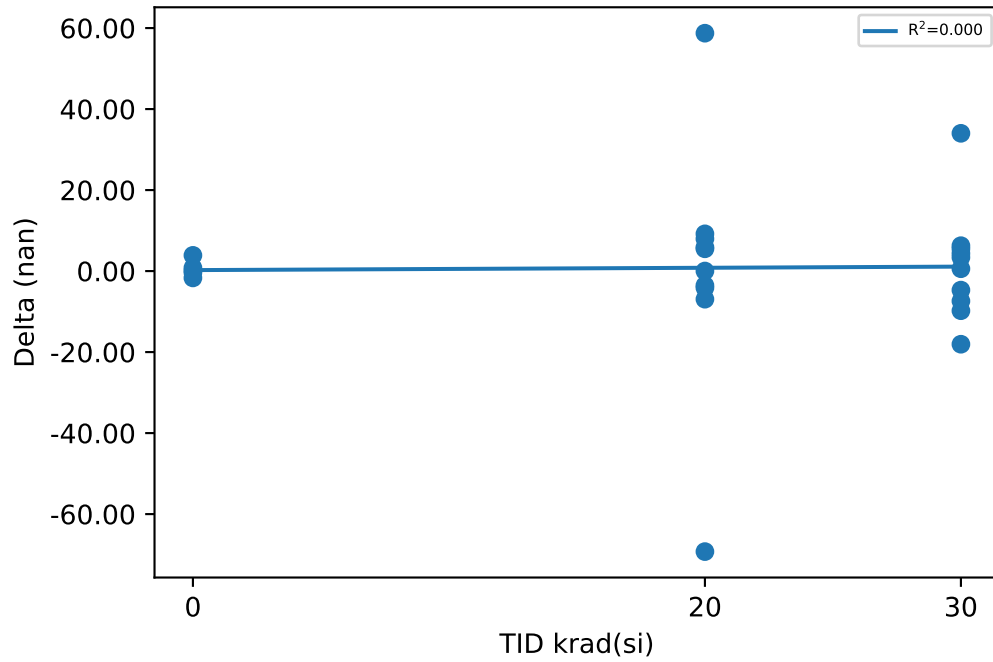

Test Statistics (nan)

krad(si)	Pre Exposure Min	Pre Exposure Avg	Pre Exposure Max	Pre Exposure Std	Post Exposure Min	Post Exposure Avg	Post Exposure Max	Post Exposure Std	Min Delta	Avg Delta	Max Delta	Std Delta
0	2465.1	2503.3	2544.7	34.76	2463.4	2503.9	2548.6	36.47	-1.687	0.556	3.882	2.0729
20	2455.7	2521.1	2558.2	33.223	2451.6	2521.5	2554.6	36.058	-69.258	0.3422	58.732	30.796
30	2499.4	2514.3	2551.6	19.606	2489.7	2515.8	2551.4	21.904	-18.06	1.4173	34.014	13.888

Device Test: 11.40 UJET8J(K CL_2A_CH2_UJET8J)

TID vs Result Stats

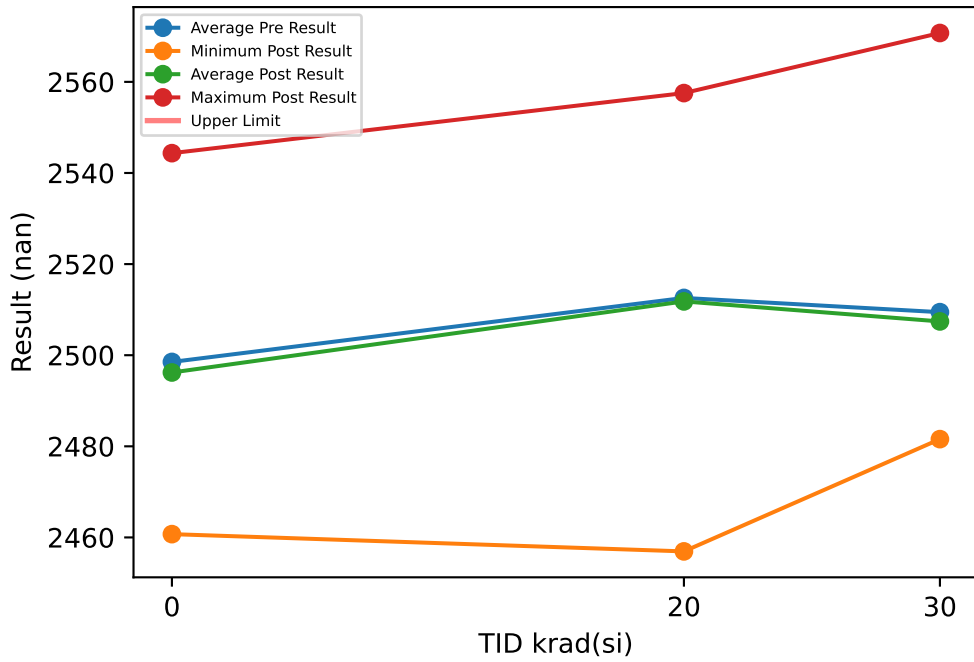

Test Results (No Limits Specified (nan))

Serial #	krad(si)	Exposure Conditions	Pre Result	Post Result	Delta
1	20	HDR unbiased	2499.8	2499.7	-0.079
2	20	HDR unbiased	2503.2	2508.8	5.614
3	20	HDR unbiased	2540.2	2536.9	-3.29
4	20	HDR unbiased	2456.6	2456.9	0.33
5	20	HDR unbiased	2490.8	2488.2	-2.674
6	20	HDR biased	2545.9	2503.9	-41.979
7	20	HDR biased	2482	2476.1	-5.974
8	20	HDR biased	2540.2	2537.2	-3.02
9	20	HDR biased	2563.5	2557.5	-5.935
10	20	HDR biased	2503.5	2552.8	49.363
11	30	HDR unbiased	2507.1	2504.4	-2.743
12	30	HDR unbiased	2578.8	2570.7	-8.068
13	30	HDR unbiased	2496.6	2505	8.401
14	30	HDR unbiased	2484.7	2503.2	18.561
15	30	HDR unbiased	2514.9	2511.7	-3.157
16	30	HDR biased	2529.2	2524.8	-4.393
17	30	HDR biased	2490.6	2481.6	-8.997
18	30	HDR biased	2499.2	2493.2	-6.007
19	30	HDR biased	2497.5	2490.5	-7.033
20	30	HDR biased	2496	2489.1	-6.899
21	0	correlation	2470.6	2467.6	-2.946
22	0	correlation	2479.2	2477.6	-1.527
23	0	correlation	2546.2	2544.4	-1.816
24	0	correlation	2533	2530.7	-2.291
25	0	correlation	2463.7	2460.7	-2.988

TID vs Post - Pre Exposure Delta

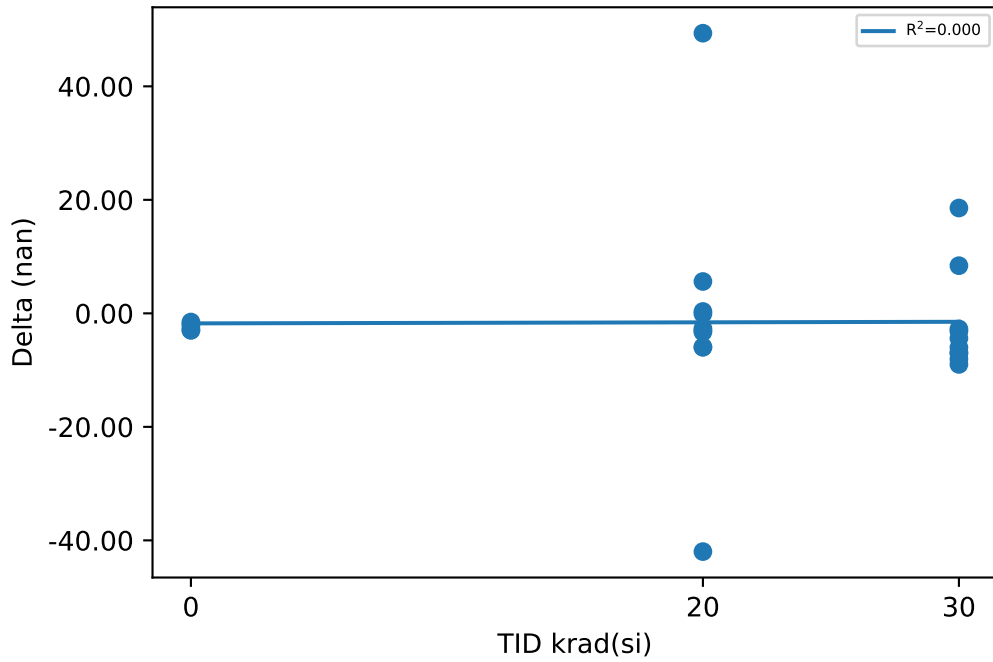

Test Statistics (nan)

krad(si)	Pre Exposure Min	Pre Exposure Avg	Pre Exposure Max	Pre Exposure Std	Post Exposure Min	Post Exposure Avg	Post Exposure Max	Post Exposure Std	Min Delta	Avg Delta	Max Delta	Std Delta
0	2463.7	2498.5	2546.2	38.167	2460.7	2496.2	2544.4	38.501	-2.988	-2.3136	-1.527	0.65605
20	2456.6	2512.6	2563.5	33.496	2456.9	2511.8	2557.5	33.525	-41.979	-0.7644	49.363	21.916
30	2484.7	2509.5	2578.8	27.482	2481.6	2507.4	2570.7	25.503	-8.997	-2.0335	18.561	8.7541

Device Test: 11.4 UJSYNT(dCLR_P5A_CH2_UJSYNT)

TID vs Result Stats

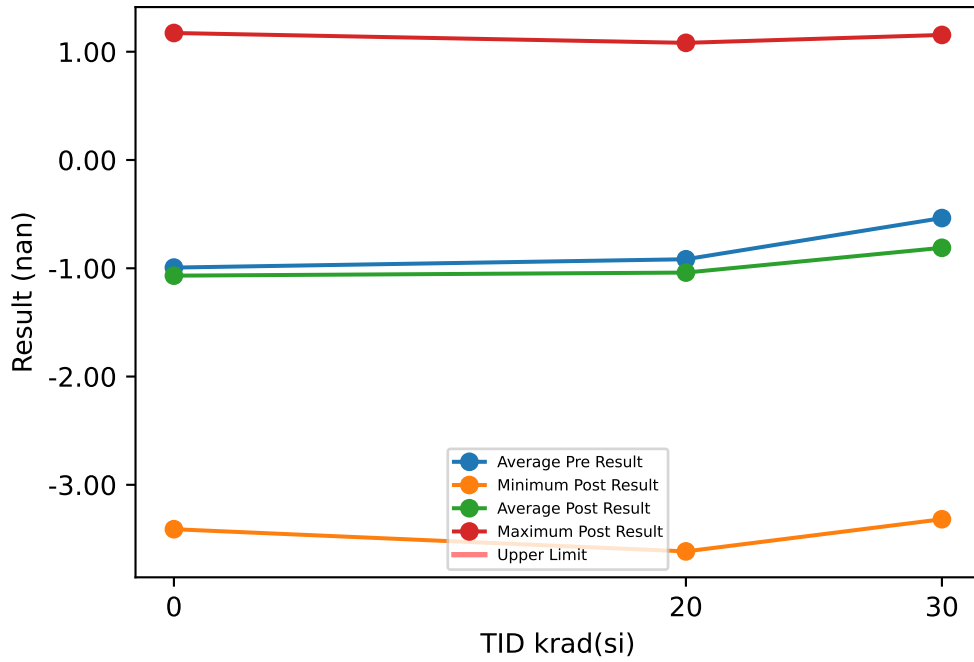

Test Results (No Limits Specified (nan))

Serial #	krad(si)	Exposure Conditions	Pre Result	Post Result	Delta
1	20	HDR unbiased	-0.666	-0.982	-0.316
2	20	HDR unbiased	-1.872	-1.129	0.743
3	20	HDR unbiased	-0.021	-0.475	-0.454
4	20	HDR unbiased	-2.688	-2.879	-0.191
5	20	HDR unbiased	-3.108	-3.243	-0.135
6	20	HDR biased	-0.245	-0.659	-0.414
7	20	HDR biased	-2.473	-3.615	-1.142
8	20	HDR biased	1.003	0.55	-0.453
9	20	HDR biased	1.648	1.082	-0.566
10	20	HDR biased	-0.745	0.952	1.697
11	30	HDR unbiased	0.267	-0.13	-0.397
12	30	HDR unbiased	2.056	1.155	-0.901
13	30	HDR unbiased	-1.598	-0.232	1.366
14	30	HDR unbiased	-0.782	-1.214	-0.432
15	30	HDR unbiased	-0.779	-1.097	-0.318
16	30	HDR biased	0.269	-0.291	-0.56
17	30	HDR biased	-2.158	-3.318	-1.16
18	30	HDR biased	-0.351	-0.902	-0.551
19	30	HDR biased	-1.576	-0.197	1.379
20	30	HDR biased	-0.711	-1.885	-1.174
21	0	correlation	-2.387	-2.303	0.084
22	0	correlation	-0.141	-0.336	-0.195
23	0	correlation	1.266	1.173	-0.093
24	0	correlation	-0.379	-0.465	-0.086
25	0	correlation	-3.327	-3.41	-0.083

TID vs Post - Pre Exposure Delta

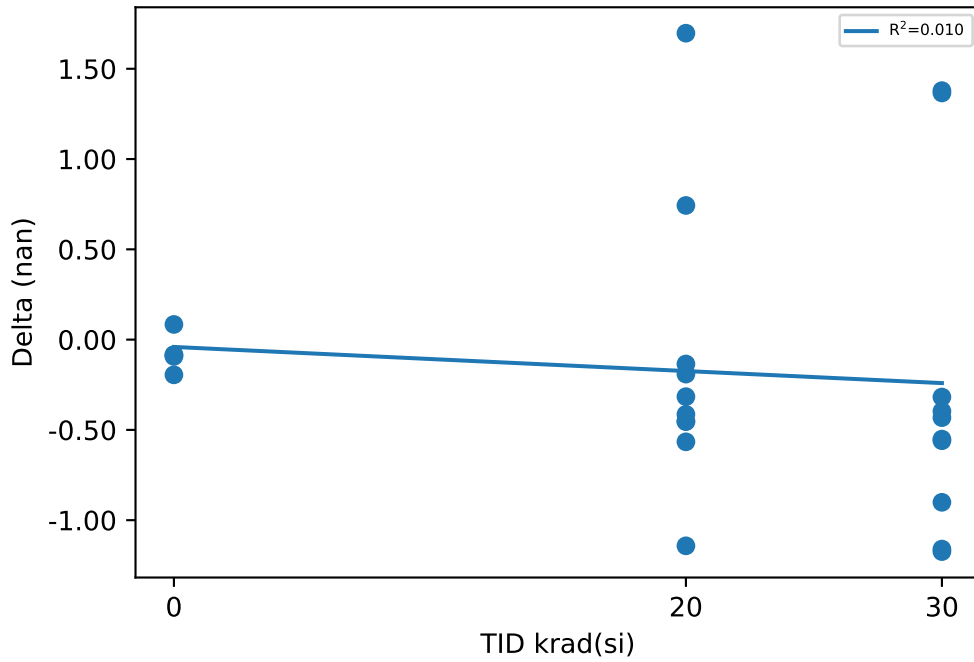

Test Statistics (nan)

krad(si)	Pre Exposure Min	Pre Exposure Avg	Pre Exposure Max	Pre Exposure Std	Post Exposure Min	Post Exposure Avg	Post Exposure Max	Post Exposure Std	Min Delta	Avg Delta	Max Delta	Std Delta
0	-3.327	-0.9936	1.266	1.8437	-3.41	-1.0682	1.173	1.798	-0.195	-0.0746	0.084	0.10024
20	-3.108	-0.9167	1.648	1.5945	-3.615	-1.0398	1.082	1.7108	-1.142	-0.1231	1.697	0.79177
30	-2.158	-0.5363	2.056	1.2035	-3.318	-0.8111	1.155	1.202	-1.174	-0.2748	1.379	0.91958

Device Test: 11.41 UJET8J(KCL_2A_CH3_UJET8J)

TID vs Result Stats

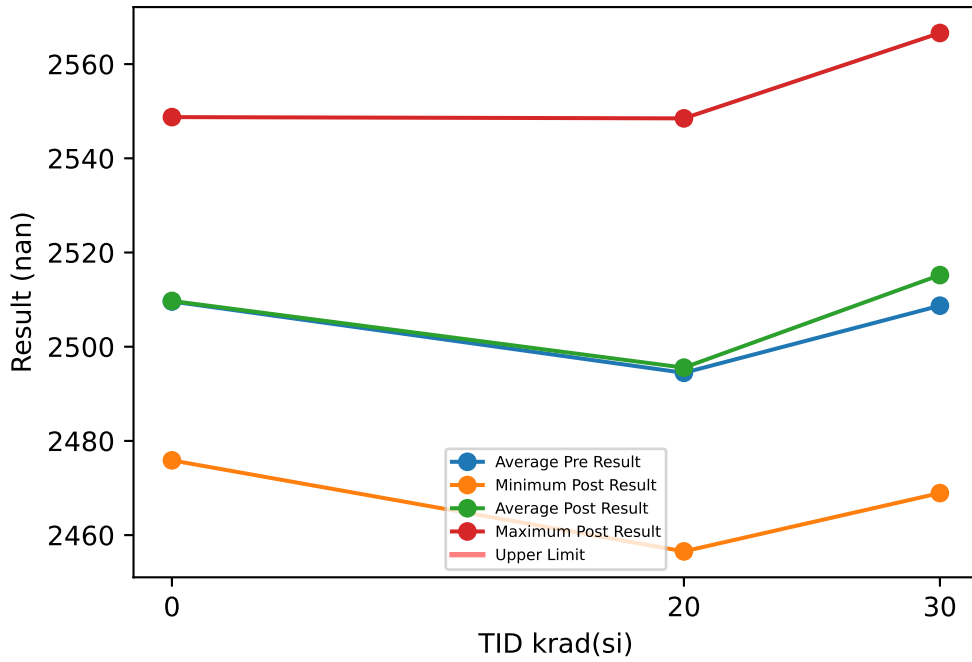

Test Results (No Limits Specified (nan))

Serial #	krad(si)	Exposure Conditions	Pre Result	Post Result	Delta
1	20	HDR unbiased	2512.1	2510.7	-1.403
2	20	HDR unbiased	2513.4	2507.2	-6.162
3	20	HDR unbiased	2451.9	2456.8	4.874
4	20	HDR unbiased	2538.3	2548.5	10.131
5	20	HDR unbiased	2506.9	2503.2	-3.683
6	20	HDR biased	2492.6	2482.6	-10.027
7	20	HDR biased	2480.7	2485.1	4.333
8	20	HDR biased	2511.0	2509.8	-1.178
9	20	HDR biased	2460.2	2456.5	-3.611
10	20	HDR biased	2477.4	2495.1	17.772
11	30	HDR unbiased	2529.8	2534.9	5.163
12	30	HDR unbiased	2514.7	2522.7	8.058
13	30	HDR unbiased	2506.5	2512.3	5.741
14	30	HDR unbiased	2466.3	2497.5	31.147
15	30	HDR unbiased	2524.7	2535.9	11.183
16	30	HDR biased	2505.5	2505.2	-0.274
17	30	HDR biased	2549.5	2566.6	17.113
18	30	HDR biased	2523.1	2528.8	5.712
19	30	HDR biased	2504.2	2479.3	-24.956
20	30	HDR biased	2462.8	2468.9	6.123
21	0	correlation	2500.2	2500.5	0.233
22	0	correlation	2546.8	2548.7	1.997
23	0	correlation	2531.9	2531.0	-0.898
24	0	correlation	2491.7	2492.5	0.739
25	0	correlation	2477.4	2475.9	-1.492

TID vs Post - Pre Exposure Delta

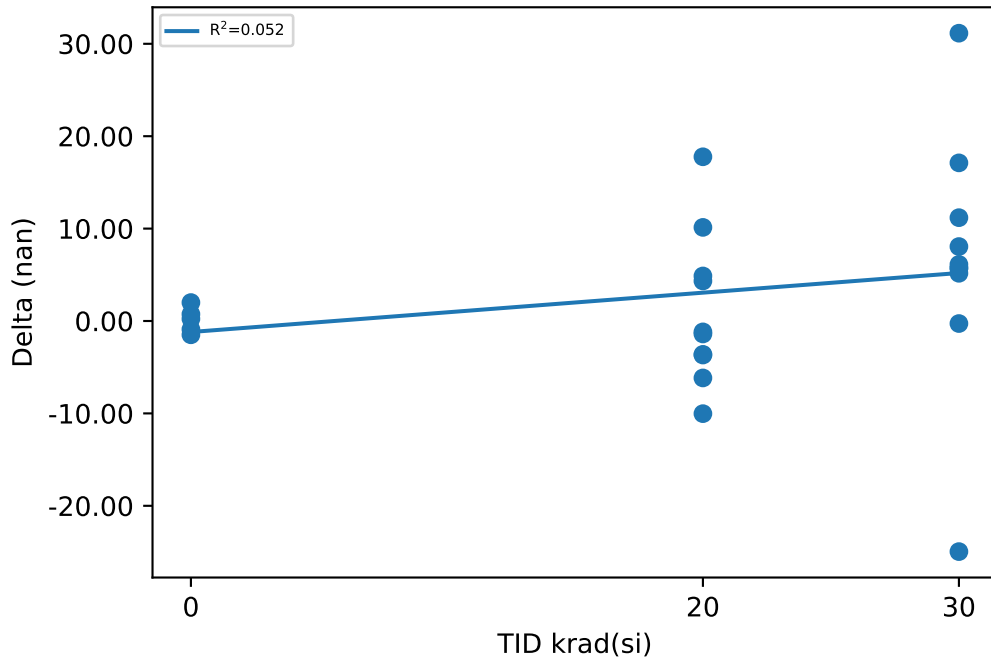

Test Statistics (nan)

krad(si)	Pre Exposure Min	Pre Exposure Avg	Pre Exposure Max	Pre Exposure Std	Post Exposure Min	Post Exposure Avg	Post Exposure Max	Post Exposure Std	Min Delta	Avg Delta	Max Delta	Std Delta
0	2477.4	2509.6	2546.8	28.828	2475.9	2509.7	2548.7	29.604	-1.492	0.1158	1.997	1.3742
20	2451.9	2494.5	2538.3	26.869	2456.5	2495.6	2548.5	27.352	-10.027	1.1046	17.772	8.2817
30	2462.8	2508.7	2549.5	26.967	2468.9	2515.2	2566.6	28.974	-24.956	6.501	31.147	14.075

Device Test: 11.42 UJET8J(KCL_2A_CH4_UJET8J)

TID vs Result Stats

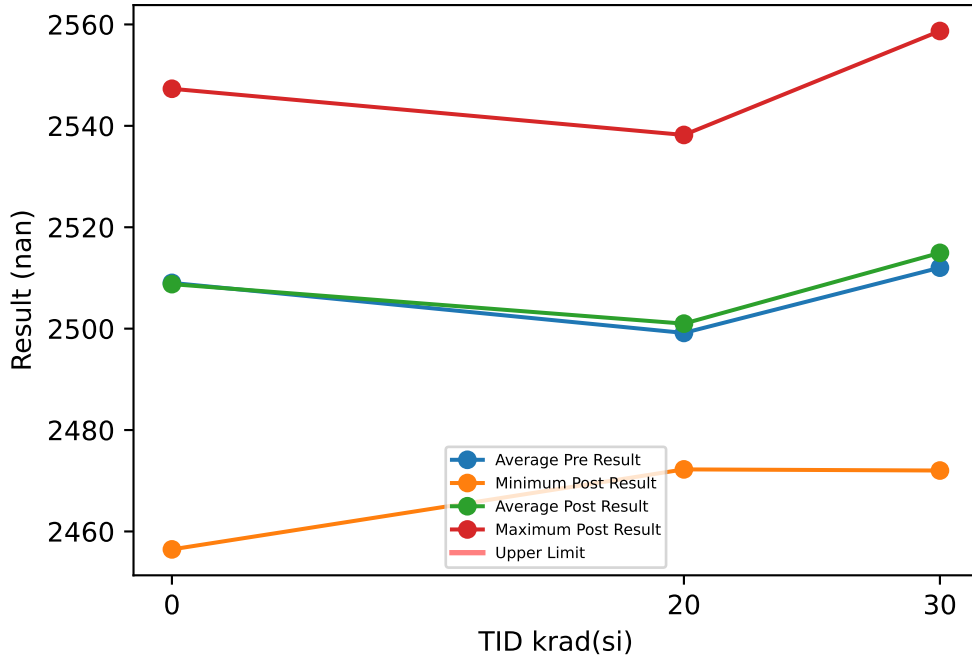

Test Results (No Limits Specified (nan))

Serial #	krad(si)	Exposure Conditions	Pre Result	Post Result	Delta
1	20	HDR unbiased	2482.4	2476.6	-5.719
2	20	HDR unbiased	2480.6	2477	-3.64
3	20	HDR unbiased	2498.3	2500.6	2.298
4	20	HDR unbiased	2503.7	2506.9	3.234
5	20	HDR unbiased	2470.3	2472.2	1.978
6	20	HDR biased	2475.2	2492.4	17.222
7	20	HDR biased	2535.2	2538.2	2.956
8	20	HDR biased	2534.1	2537.9	3.766
9	20	HDR biased	2522.9	2528.8	5.938
10	20	HDR biased	2488.9	2479.2	-9.717
11	30	HDR unbiased	2529.3	2531.7	2.337
12	30	HDR unbiased	2519.7	2519.9	0.155
13	30	HDR unbiased	2526.5	2528.3	1.803
14	30	HDR unbiased	2482	2493.7	11.659
15	30	HDR unbiased	2469.8	2472	2.217
16	30	HDR biased	2515.9	2519.4	3.435
17	30	HDR biased	2560	2558.7	-1.309
18	30	HDR biased	2531.2	2536.7	5.474
19	30	HDR biased	2489.8	2484.4	-5.448
20	30	HDR biased	2495.9	2504.7	8.852
21	0	correlation	2521.8	2521.5	-0.299
22	0	correlation	2547.9	2547.3	-0.566
23	0	correlation	2547	2547.1	0.107
24	0	correlation	2469.6	2471.5	1.906
25	0	correlation	2458.8	2456.5	-2.38

TID vs Post - Pre Exposure Delta

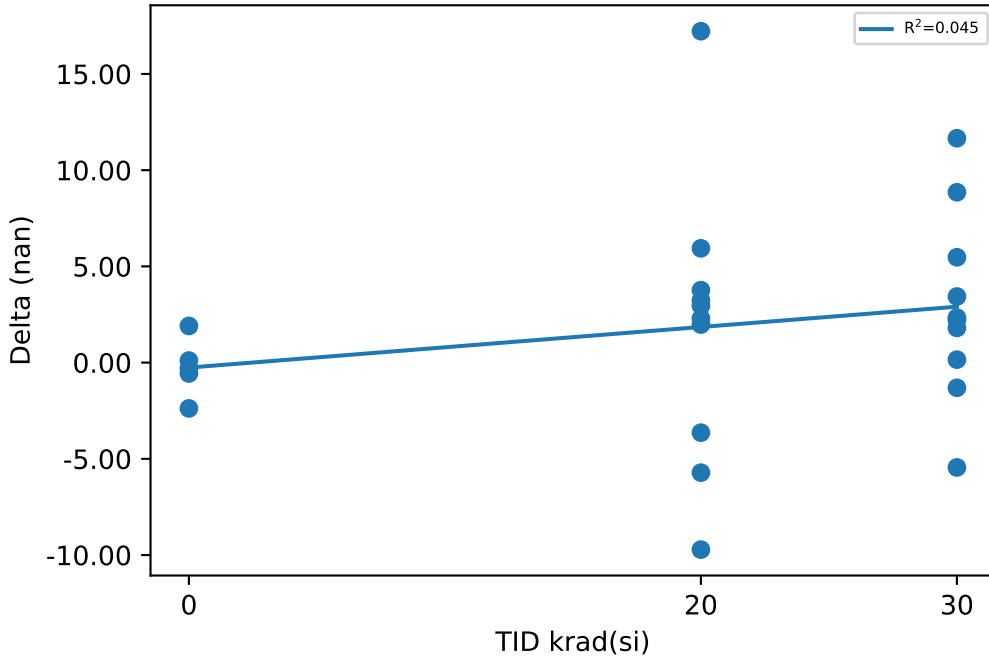

Test Statistics (nan)

krad(si)	Pre Exposure Min	Pre Exposure Avg	Pre Exposure Max	Pre Exposure Std	Post Exposure Min	Post Exposure Avg	Post Exposure Max	Post Exposure Std	Min Delta	Avg Delta	Max Delta	Std Delta
0	2458.8	2509	2547.9	42.381	2456.5	2508.8	2547.3	42.541	-2.38	-0.2464	1.906	1.5342
20	2470.3	2499.2	2535.2	24.15	2472.2	2501	2538.2	26.037	-9.717	1.8316	17.222	7.3125
30	2469.8	2512	2560	27.271	2472	2514.9	2558.7	26.301	-5.448	2.9175	11.659	4.8988

Device Test: 11.43 UJET8J(KCL_3A_CH1_UJET8J)

TID vs Result Stats

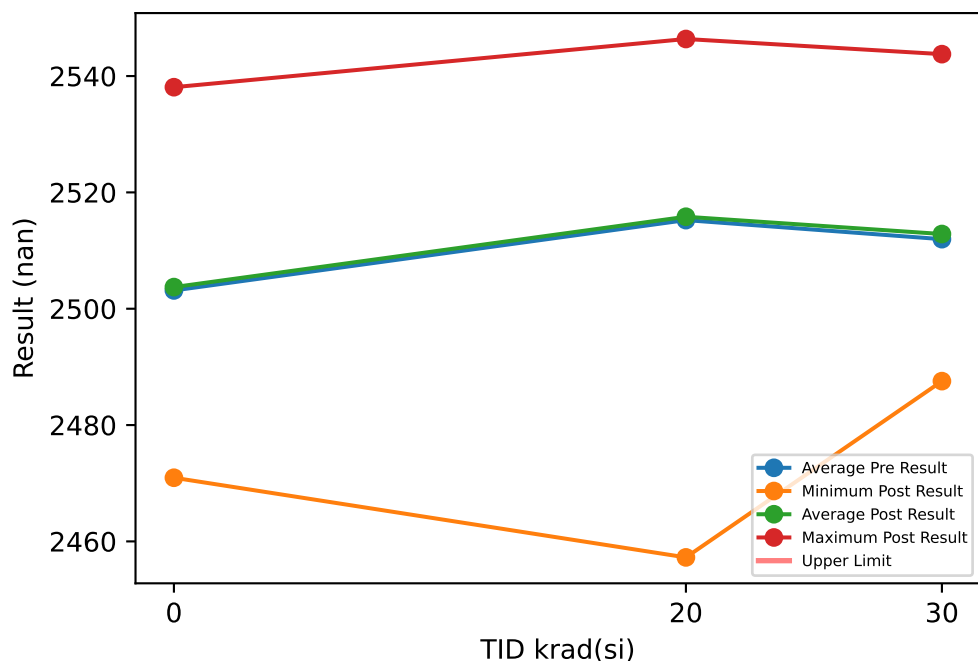

Test Results (No Limits Specified (nan))

Serial #	krad(si)	Exposure Conditions	Pre Result	Post Result	Delta
1	20	HDR unbiased	2460.1	2457.2	-2.804
2	20	HDR unbiased	2531.9	2536.6	4.687
3	20	HDR unbiased	2524.4	2528.7	4.249
4	20	HDR unbiased	2510.4	2518.2	7.857
5	20	HDR unbiased	2522	2527.8	5.778
6	20	HDR biased	2482.7	2533	50.289
7	20	HDR biased	2541.3	2540.7	-0.593
8	20	HDR biased	2495	2491.1	-3.874
9	20	HDR biased	2548.9	2546.4	-2.489
10	20	HDR biased	2535.6	2478.3	-57.306
11	30	HDR unbiased	2492.1	2487.6	-4.562
12	30	HDR unbiased	2541.5	2538.4	-3.194
13	30	HDR unbiased	2509.9	2511	1.127
14	30	HDR unbiased	2515.4	2504.6	-10.76
15	30	HDR unbiased	2539.5	2543.8	4.286
16	30	HDR biased	2498.7	2501.7	2.965
17	30	HDR biased	2503.9	2497.3	-6.611
18	30	HDR biased	2510.4	2514.9	4.506
19	30	HDR biased	2504.6	2525.2	20.581
20	30	HDR biased	2503.6	2504.1	0.508
21	0	correlation	2523.1	2523.1	0.001
22	0	correlation	2500.8	2502	1.17
23	0	correlation	2484.1	2484.5	0.388
24	0	correlation	2536.3	2538.1	1.808
25	0	correlation	2471.4	2470.9	-0.496

TID vs Post - Pre Exposure Delta

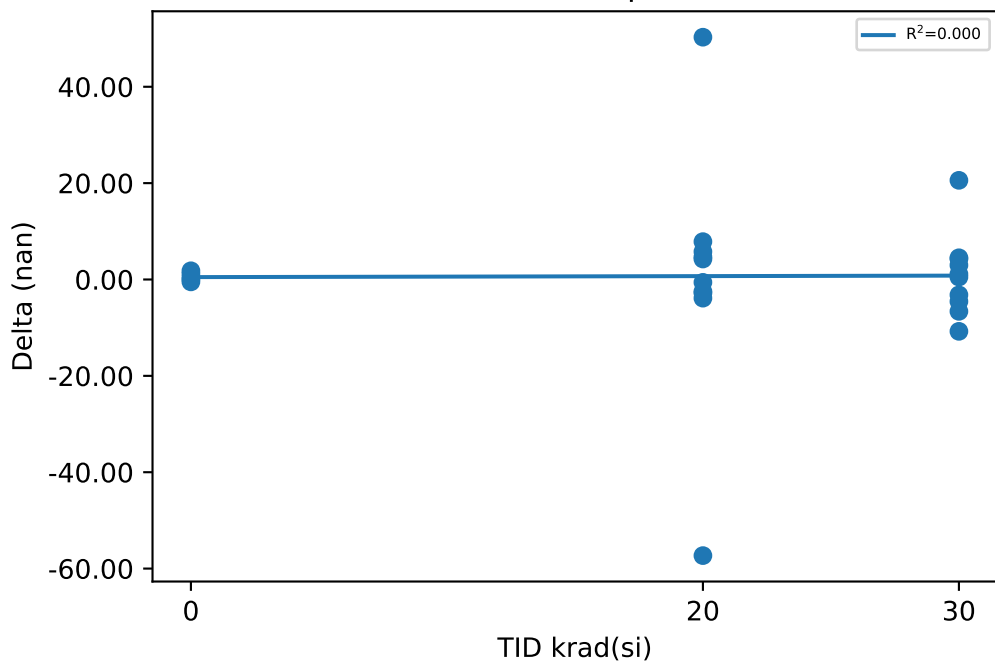

Test Statistics (nan)

krad(si)	Pre Exposure Min	Pre Exposure Avg	Pre Exposure Max	Pre Exposure Std	Post Exposure Min	Post Exposure Avg	Post Exposure Max	Post Exposure Std	Min Delta	Avg Delta	Max Delta	Std Delta
0	2471.4	2503.1	2536.3	26.773	2470.9	2503.7	2538.1	27.394	-0.496	0.5742	1.808	0.92003
20	2460.1	2515.2	2548.9	28.226	2457.2	2515.8	2546.4	29.898	-57.306	0.5794	50.289	25.764
30	2492.1	2512	2541.5	16.365	2487.6	2512.8	2543.8	18.005	-10.76	0.8846	20.581	8.5326

Device Test: 11.44 UJET8J(KCL_3A_CH2_UJET8J)

TID vs Result Stats

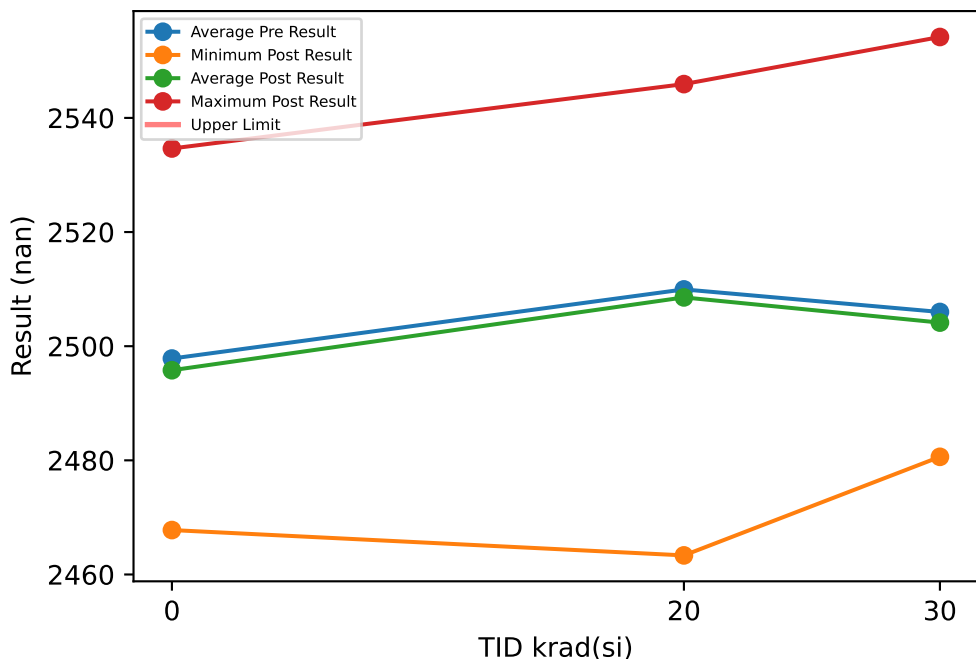

Test Results (No Limits Specified (nan))

Serial #	krad(si)	Exposure Conditions	Pre Result	Post Result	Delta
1	20	HDR unbiased	2497.6	2496.9	-0.743
2	20	HDR unbiased	2504.5	2509	4.459
3	20	HDR unbiased	2529.3	2525.1	-4.195
4	20	HDR unbiased	2463.5	2463.3	-0.157
5	20	HDR unbiased	2493.4	2490.4	-2.974
6	20	HDR biased	2539.4	2501.6	-37.747
7	20	HDR biased	2486.5	2481.6	-4.854
8	20	HDR biased	2531.8	2528.3	-3.481
9	20	HDR biased	2550.1	2545.9	-4.162
10	20	HDR biased	2503.4	2543.3	39.851
11	30	HDR unbiased	2505.1	2502.2	-2.934
12	30	HDR unbiased	2561	2554.2	-6.786
13	30	HDR unbiased	2498	2503.9	5.87
14	30	HDR unbiased	2483.2	2501.1	17.949
15	30	HDR unbiased	2515.2	2512.3	-2.887
16	30	HDR biased	2521.3	2517.4	-3.945
17	30	HDR biased	2488	2480.6	-7.359
18	30	HDR biased	2494.2	2490.3	-3.965
19	30	HDR biased	2497.7	2487.8	-9.931
20	30	HDR biased	2496.2	2491.6	-4.628
21	0	correlation	2472.5	2470.8	-1.724
22	0	correlation	2479.8	2477.5	-2.307
23	0	correlation	2536.8	2534.6	-2.142
24	0	correlation	2530.9	2528.2	-2.732
25	0	correlation	2469.1	2467.8	-1.347

TID vs Post - Pre Exposure Delta

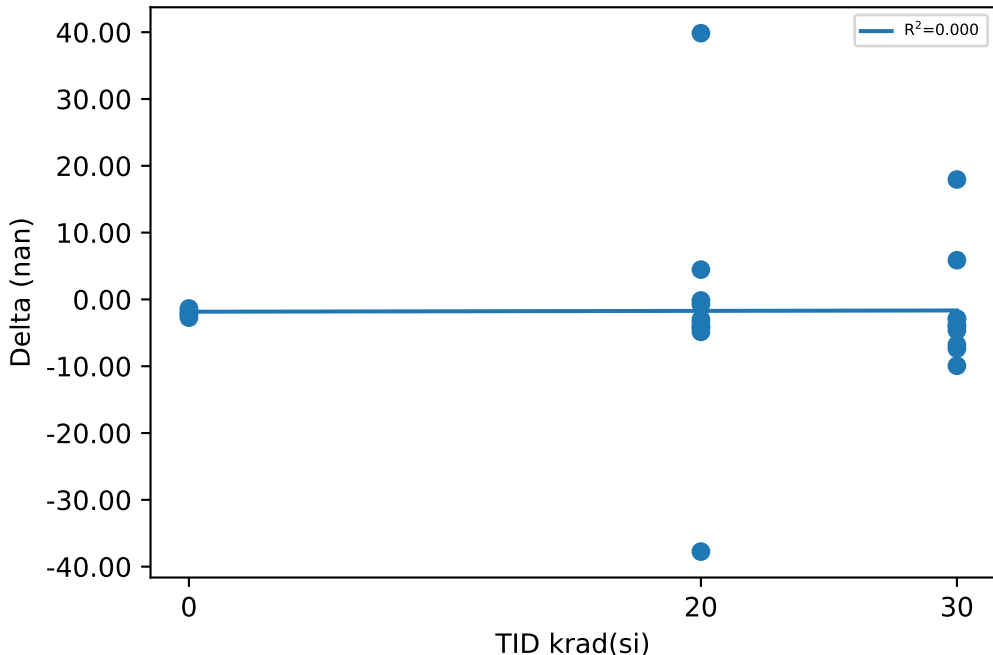

Test Statistics (nan)

krad(si)	Pre Exposure Min	Pre Exposure Avg	Pre Exposure Max	Pre Exposure Std	Post Exposure Min	Post Exposure Avg	Post Exposure Max	Post Exposure Std	Min Delta	Avg Delta	Max Delta	Std Delta
0	2469.1	2497.8	2536.8	33.177	2467.8	2495.8	2534.6	32.803	-2.732	-2.0504	-1.347	0.53388
20	2463.5	2509.9	2550.1	26.941	2463.3	2508.5	2545.9	26.97	-37.747	-1.4003	39.851	18.539
30	2483.2	2506	2561	22.49	2480.6	2504.1	2554.2	20.893	-9.931	-1.8616	17.949	8.0997

Device Test: 11.45 UJET8J(KCL_3A_CH3_UJET8J)

TID vs Result Stats

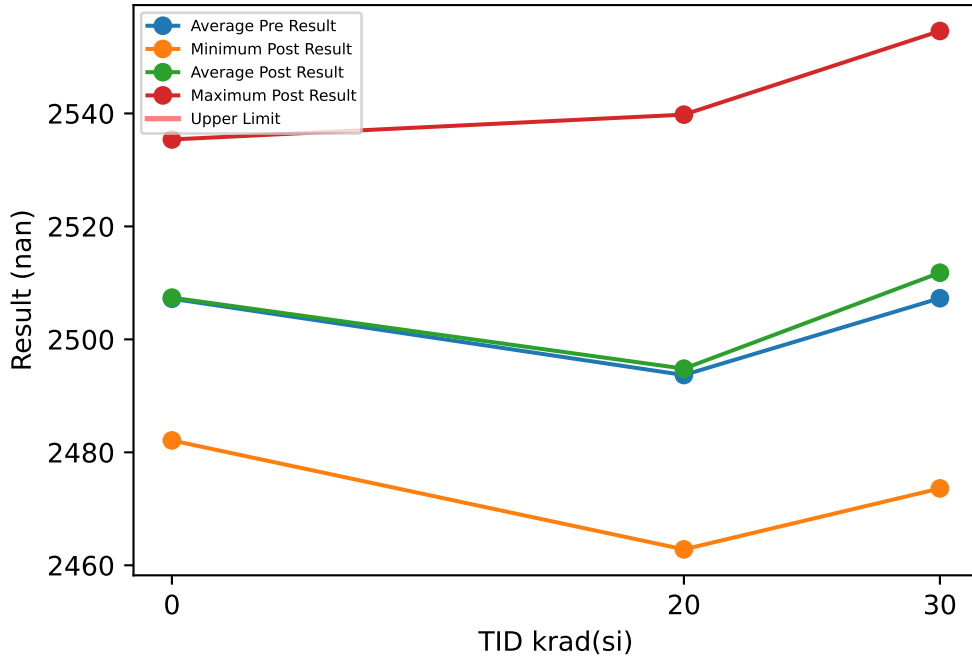

Test Results (No Limits Specified (nan))

Serial #	krad(si)	Exposure Conditions	Pre Result	Post Result	Delta
1	20	HDR unbiased	2501.1	2500.4	-0.716
2	20	HDR unbiased	2508.5	2504.6	-3.899
3	20	HDR unbiased	2457.4	2462.8	5.367
4	20	HDR unbiased	2532.6	2539.8	7.17
5	20	HDR unbiased	2506.2	2503.5	-2.723
6	20	HDR biased	2493.3	2488.7	-4.504
7	20	HDR biased	2481	2484.1	3.151
8	20	HDR biased	2506.1	2504.8	-1.316
9	20	HDR biased	2465.7	2463.9	-1.859
10	20	HDR biased	2485	2495.6	10.585
11	30	HDR unbiased	2526.6	2530.6	3.975
12	30	HDR unbiased	2507.5	2513.1	5.557
13	30	HDR unbiased	2505.8	2509.8	4.004
14	30	HDR unbiased	2474.2	2498.4	24.215
15	30	HDR unbiased	2524.1	2532.4	8.318
16	30	HDR biased	2501.9	2501.7	-0.182
17	30	HDR biased	2543.4	2554.6	11.162
18	30	HDR biased	2517.7	2520.4	2.732
19	30	HDR biased	2502.9	2483.5	-19.446
20	30	HDR biased	2468.8	2473.6	4.806
21	0	correlation	2496.2	2496.6	0.338
22	0	correlation	2536.1	2535.4	-0.674
23	0	correlation	2529.2	2529.3	0.113
24	0	correlation	2491.9	2493.6	1.685
25	0	correlation	2482.6	2482.1	-0.48

TID vs Post - Pre Exposure Delta

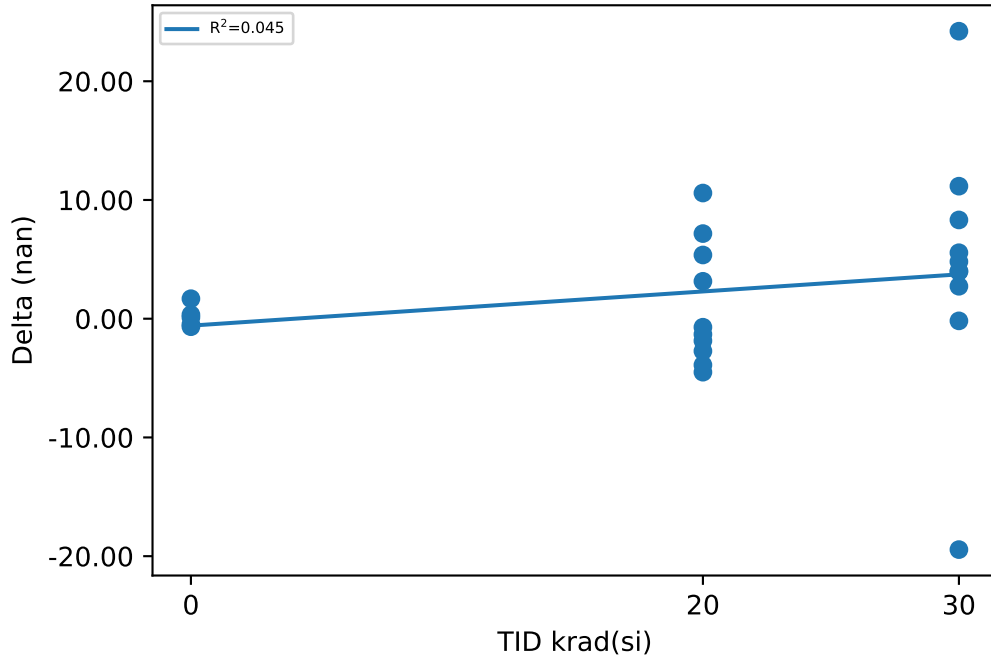

Test Statistics (nan)

krad(si)	Pre Exposure Min	Pre Exposure Avg	Pre Exposure Max	Pre Exposure Std	Post Exposure Min	Post Exposure Avg	Post Exposure Max	Post Exposure Std	Min Delta	Avg Delta	Max Delta	Std Delta
0	2482.6	2507.2	2536.1	23.863	2482.1	2507.4	2535.4	23.515	-0.674	0.1964	1.685	0.92979
20	2457.4	2493.7	2532.6	22.191	2462.8	2494.8	2539.8	22.254	-4.504	1.1256	10.585	5.1437
30	2468.8	2507.3	2543.4	22.845	2473.6	2511.8	2554.6	24.107	-19.446	4.5141	24.215	10.79

Device Test: 11.46 UJET8J(KCL_3A_CH4_UJET8J)

TID vs Result Stats

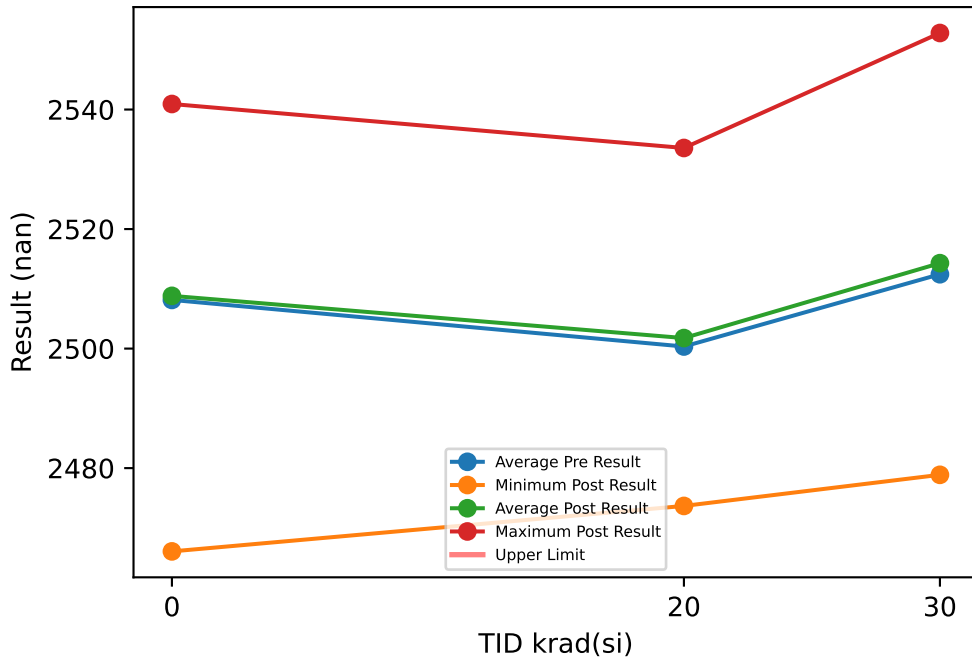

Test Results (No Limits Specified (nan))

Serial #	krad(si)	Exposure Conditions	Pre Result	Post Result	Delta
1	20	HDR unbiased	2484	2478.9	-5.028
2	20	HDR unbiased	2489.2	2487.5	-1.718
3	20	HDR unbiased	2497.8	2499.7	1.864
4	20	HDR unbiased	2506.3	2510.2	3.883
5	20	HDR unbiased	2472.2	2473.7	1.45
6	20	HDR biased	2478.7	2499.2	20.465
7	20	HDR biased	2528.8	2530.6	1.818
8	20	HDR biased	2530.7	2533.6	2.894
9	20	HDR biased	2519	2523.3	4.255
10	20	HDR biased	2496.7	2480.9	-15.759
11	30	HDR unbiased	2528.2	2529.6	1.401
12	30	HDR unbiased	2514.3	2513.8	-0.523
13	30	HDR unbiased	2525.1	2525.6	0.477
14	30	HDR unbiased	2489.2	2498.2	9.021
15	30	HDR unbiased	2477.3	2478.9	1.584
16	30	HDR biased	2513.2	2516	2.857
17	30	HDR biased	2553.3	2552.8	-0.544
18	30	HDR biased	2530.4	2535	4.63
19	30	HDR biased	2496	2489.2	-6.841
20	30	HDR biased	2497.3	2503.8	6.471
21	0	correlation	2516.3	2516.9	0.609
22	0	correlation	2541	2540.9	-0.054
23	0	correlation	2538.6	2540.4	1.749
24	0	correlation	2478.9	2479.8	0.872
25	0	correlation	2465.8	2466.1	0.227

TID vs Post - Pre Exposure Delta

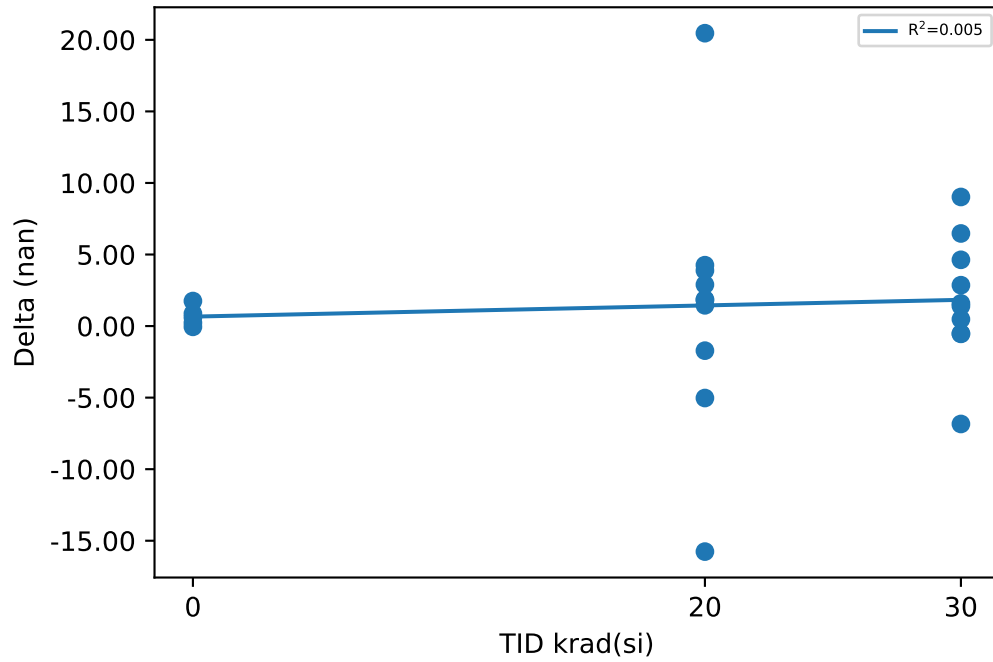

Test Statistics (nan)

krad(si)	Pre Exposure Min	Pre Exposure Avg	Pre Exposure Max	Pre Exposure Std	Post Exposure Min	Post Exposure Avg	Post Exposure Max	Post Exposure Std	Min Delta	Avg Delta	Max Delta	Std Delta
0	2465.8	2508.1	2541	34.345	2466.1	2508.8	2540.9	34.508	-0.054	0.6806	1.749	0.69438
20	2472.2	2500.3	2530.7	20.502	2473.7	2501.8	2533.6	21.947	-15.759	1.4124	20.465	8.9808
30	2477.3	2512.4	2553.3	22.807	2478.9	2514.3	2552.8	22.437	-6.841	1.8533	9.021	4.3534

Device Test: 11.47 UJET8J(KCL_4A_CH1_UJET8J)

TID vs Result Stats

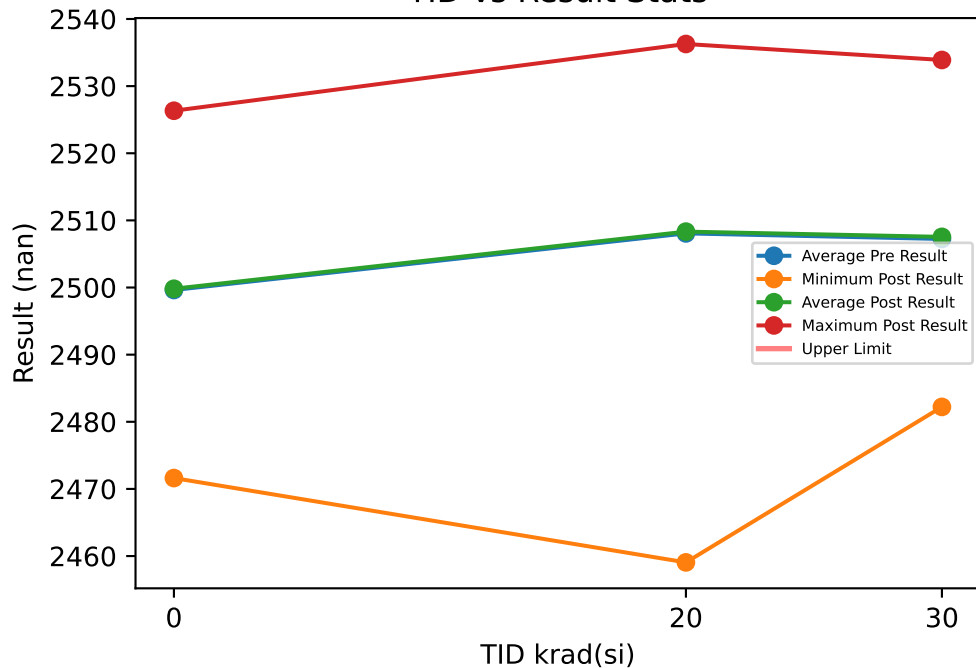

Test Results (No Limits Specified (nan))

Serial #	krad(si)	Exposure Conditions	Pre Result	Post Result	Delta
1	20	HDR unbiased	2460.5	2459.1	-1.493
2	20	HDR unbiased	2520.5	2525	4.533
3	20	HDR unbiased	2515.5	2518.5	2.991
4	20	HDR unbiased	2504.3	2509.7	5.385
5	20	HDR unbiased	2510.2	2514.3	4.187
6	20	HDR biased	2481.7	2523.6	41.905
7	20	HDR biased	2532.4	2531.6	-0.824
8	20	HDR biased	2490.5	2487.3	-3.28
9	20	HDR biased	2538.5	2536.3	-2.178
10	20	HDR biased	2526.5	2477.9	-48.591
11	30	HDR unbiased	2485.3	2482.2	-3.055
12	30	HDR unbiased	2530.9	2528.5	-2.46
13	30	HDR unbiased	2507.7	2507.6	-0.164
14	30	HDR unbiased	2511.1	2502.9	-8.226
15	30	HDR unbiased	2531.5	2533.9	2.364
16	30	HDR biased	2491.5	2493.6	2.074
17	30	HDR biased	2502.9	2498.1	-4.827
18	30	HDR biased	2505.9	2508.9	2.981
19	30	HDR biased	2504.2	2518.8	14.607
20	30	HDR biased	2501.3	2501.1	-0.18
21	0	correlation	2512.5	2513	0.572
22	0	correlation	2501.2	2501.3	0.072
23	0	correlation	2486.1	2486.8	0.697
24	0	correlation	2525.6	2526.3	0.689
25	0	correlation	2472.7	2471.6	-1.101

TID vs Post - Pre Exposure Delta

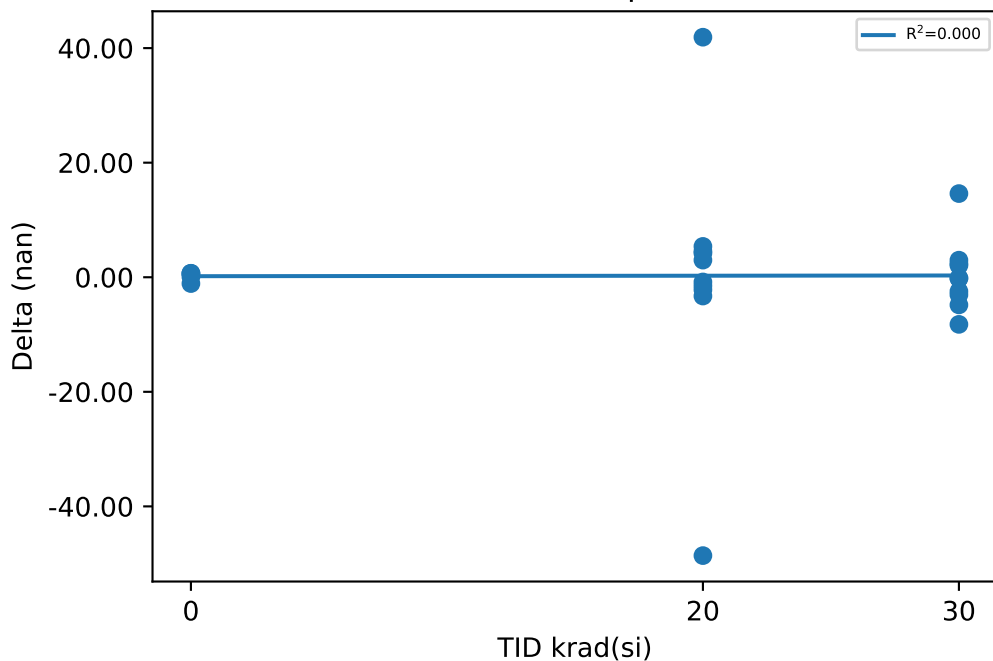

Test Statistics (nan)

krad(si)	Pre Exposure Min	Pre Exposure Avg	Pre Exposure Max	Pre Exposure Std	Post Exposure Min	Post Exposure Avg	Post Exposure Max	Post Exposure Std	Min Delta	Avg Delta	Max Delta	Std Delta
0	2472.7	2499.6	2525.6	20.926	2471.6	2499.8	2526.3	21.477	-1.101	0.1858	0.697	0.76362
20	2460.5	2508.1	2538.5	24.362	2459.1	2508.3	2536.3	25.332	-48.591	0.2635	41.905	21.63
30	2485.3	2507.2	2531.5	14.769	2482.2	2507.5	2533.9	15.815	-8.226	0.3114	14.607	6.1245

Device Test: 11.48 UJET8J(KCL_4A_CH2_UJET8J)

TID vs Result Stats

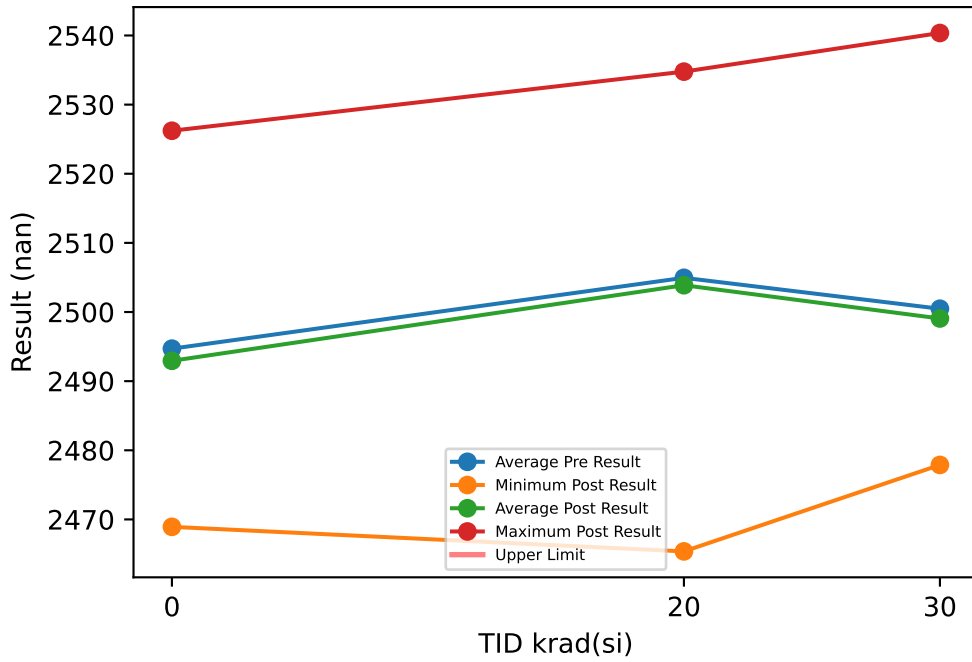

Test Results (No Limits Specified (nan))

Serial #	krad(si)	Exposure Conditions	Pre Result	Post Result	Delta
1	20	HDR unbiased	2493.4	2493.1	-0.254
2	20	HDR unbiased	2502	2505.4	3.345
3	20	HDR unbiased	2519.4	2516.4	-2.984
4	20	HDR unbiased	2465.3	2465.4	0.04
5	20	HDR unbiased	2491.5	2489.1	-2.428
6	20	HDR biased	2531	2498.8	-32.216
7	20	HDR biased	2486.2	2482.8	-3.37
8	20	HDR biased	2522.8	2519.8	-2.942
9	20	HDR biased	2538.7	2534.8	-3.952
10	20	HDR biased	2499.2	2533.2	34.049
11	30	HDR unbiased	2500.5	2498.1	-2.42
12	30	HDR unbiased	2545.1	2540.4	-4.698
13	30	HDR unbiased	2496.3	2500	3.689
14	30	HDR unbiased	2479.5	2496.3	16.811
15	30	HDR unbiased	2511	2509.6	-1.447
16	30	HDR biased	2511.7	2508.6	-3.062
17	30	HDR biased	2482.9	2477.9	-5.026
18	30	HDR biased	2489.2	2485.3	-3.905
19	30	HDR biased	2494.7	2483.8	-10.829
20	30	HDR biased	2493.8	2490.7	-3.174
21	0	correlation	2471.6	2469	-2.588
22	0	correlation	2478.7	2477.7	-0.956
23	0	correlation	2527.4	2526.2	-1.176
24	0	correlation	2525.5	2522.9	-2.611
25	0	correlation	2470.4	2468.9	-1.442

TID vs Post - Pre Exposure Delta

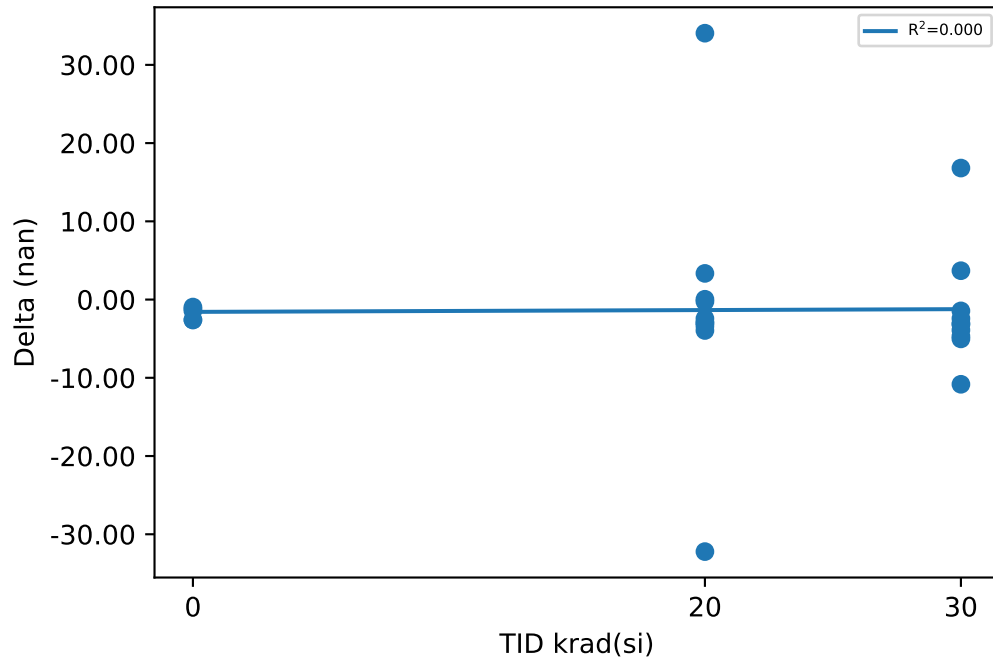

Test Statistics (nan)

krad(si)	Pre Exposure Min	Pre Exposure Avg	Pre Exposure Max	Pre Exposure Std	Post Exposure Min	Post Exposure Avg	Post Exposure Max	Post Exposure Std	Min Delta	Avg Delta	Max Delta	Std Delta
0	2470.4	2494.7	2527.4	29.148	2468.9	2492.9	2526.2	29.085	-2.611	-1.7546	-0.956	0.79029
20	2465.3	2504.9	2538.7	22.667	2465.4	2503.9	2534.8	22.395	-32.216	-1.0712	34.049	15.802
30	2479.5	2500.5	2545.1	18.839	2477.9	2499.1	2540.4	17.817	-10.829	-1.4061	16.811	7.331

Device Test: 11.49 UJET8J(KCL_4A_CH3_UJET8J)

TID vs Result Stats

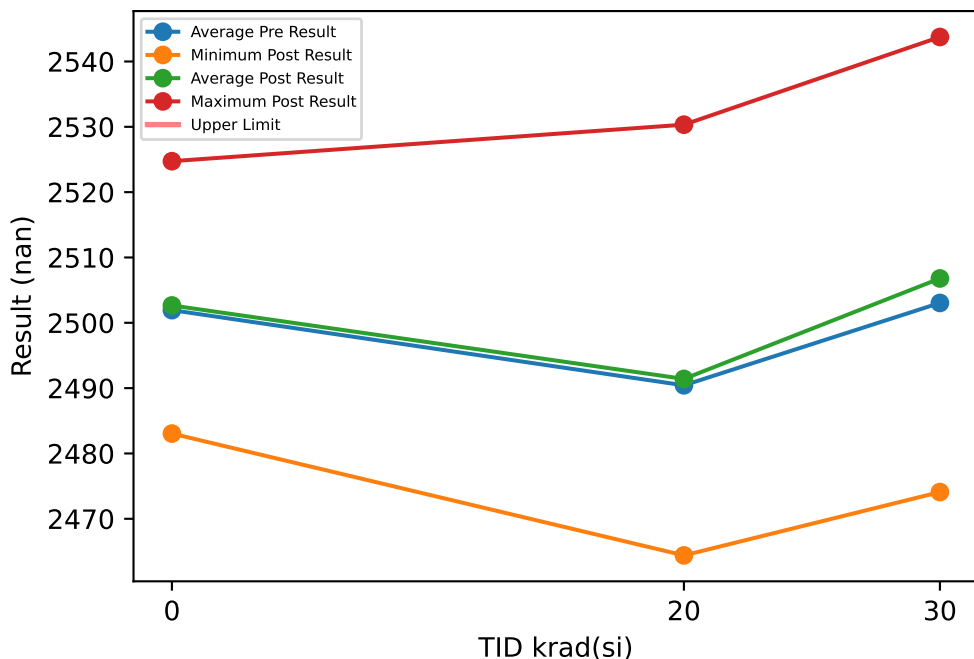

Test Results (No Limits Specified (nan))

Serial #	krad(si)	Exposure Conditions	Pre Result	Post Result	Delta
1	20	HDR unbiased	2491.5	2491.1	-0.393
2	20	HDR unbiased	2503	2500.1	-2.896
3	20	HDR unbiased	2460.8	2464.4	3.619
4	20	HDR unbiased	2524	2530.3	6.301
5	20	HDR unbiased	2503.5	2501	-2.538
6	20	HDR biased	2489.7	2489.1	-0.568
7	20	HDR biased	2477.7	2480.2	2.436
8	20	HDR biased	2499.8	2499.9	0.163
9	20	HDR biased	2468.1	2466.3	-1.842
10	20	HDR biased	2486.2	2491.7	5.515
11	30	HDR unbiased	2520.7	2525.5	4.847
12	30	HDR unbiased	2501.3	2505.4	4.109
13	30	HDR unbiased	2502.6	2505.5	2.962
14	30	HDR unbiased	2476	2496.3	20.321
15	30	HDR unbiased	2519.8	2525.9	6.058
16	30	HDR biased	2495.8	2495.7	-0.102
17	30	HDR biased	2535.2	2543.7	8.578
18	30	HDR biased	2510.2	2512.3	2.056
19	30	HDR biased	2498.5	2483.4	-15.101
20	30	HDR biased	2470.3	2474.1	3.743
21	0	correlation	2490.4	2491.9	1.469
22	0	correlation	2523.8	2524.5	0.669
23	0	correlation	2524.2	2524.7	0.51
24	0	correlation	2488.2	2489.1	0.897
25	0	correlation	2483	2483	0.051

TID vs Post - Pre Exposure Delta

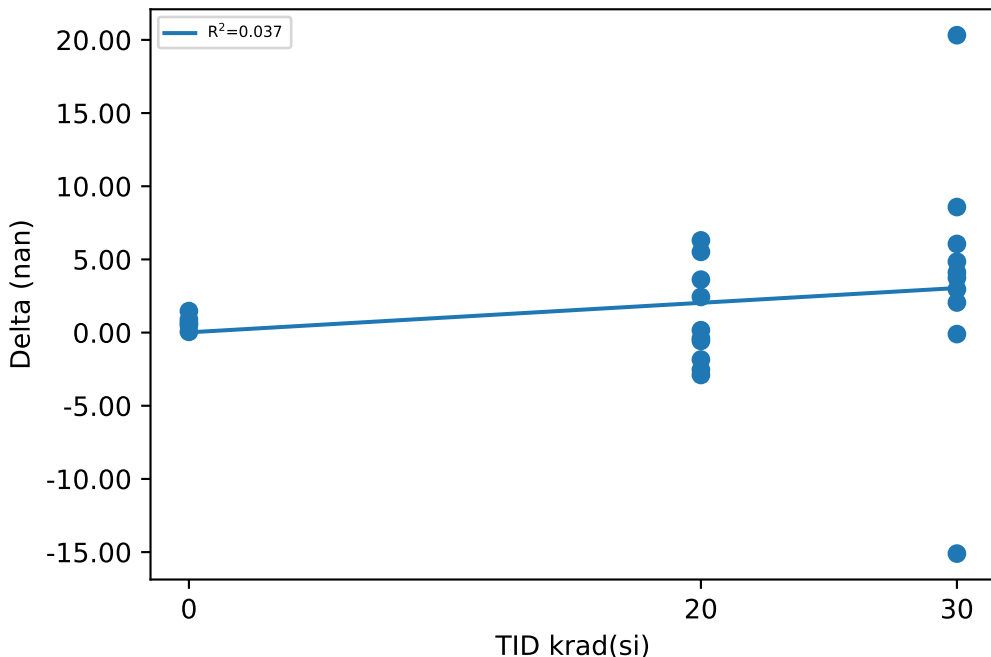

Test Statistics (nan)

krad(si)	Pre Exposure Min	Pre Exposure Avg	Pre Exposure Max	Pre Exposure Std	Post Exposure Min	Post Exposure Avg	Post Exposure Max	Post Exposure Std	Min Delta	Avg Delta	Max Delta	Std Delta
0	2483	2501.9	2524.2	20.353	2483	2502.7	2524.7	20.308	0.051	0.7192	1.469	0.5212
20	2460.8	2490.4	2524	18.574	2464.4	2491.4	2530.3	19.001	-2.896	0.9797	6.301	3.3045
30	2470.3	2503	2535.2	19.87	2474.1	2506.8	2543.7	20.986	-15.101	3.7471	20.321	8.6811

Device Test: 11.50 UJET8J(K CL_4A_CH4_UJET8J)

TID vs Result Stats

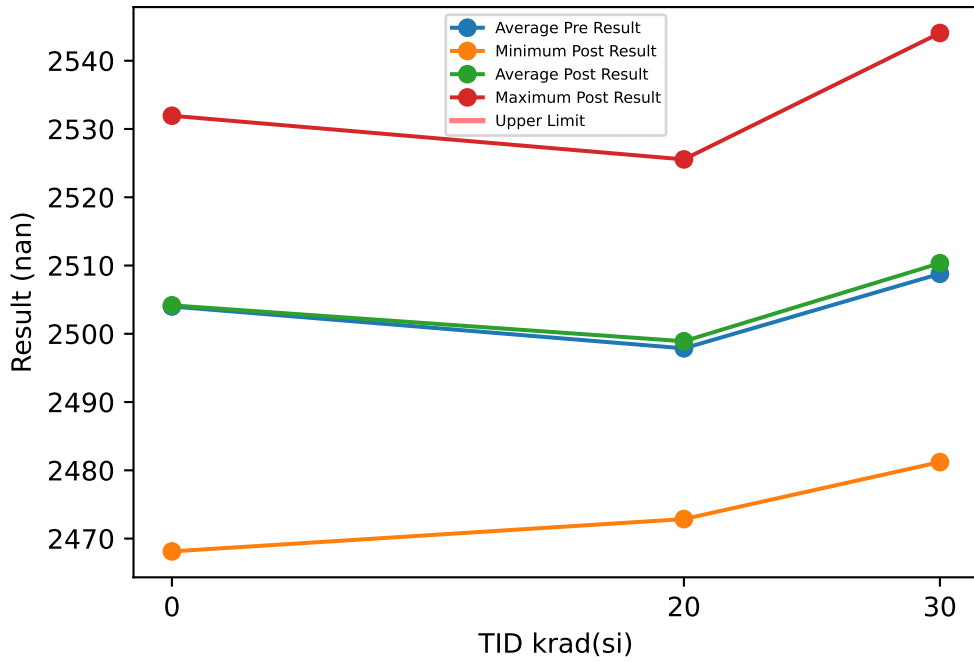

Test Results (No Limits Specified (nan))

Serial #	krad(si)	Exposure Conditions	Pre Result	Post Result	Delta
1	20	HDR unbiased	2482.3	2479	-3.362
2	20	HDR unbiased	2490.1	2488.9	-1.176
3	20	HDR unbiased	2494.8	2497	2.183
4	20	HDR unbiased	2505.6	2508.2	2.598
5	20	HDR unbiased	2471	2472.9	1.812
6	20	HDR biased	2478.6	2500.3	21.711
7	20	HDR biased	2521	2522.5	1.502
8	20	HDR biased	2524.8	2525.5	0.756
9	20	HDR biased	2512.1	2514.7	2.547
10	20	HDR biased	2498.3	2480.1	-18.168
11	30	HDR unbiased	2523.6	2524.4	0.87
12	30	HDR unbiased	2506.3	2507.1	0.848
13	30	HDR unbiased	2518.8	2519.3	0.496
14	30	HDR unbiased	2487.7	2499.3	11.621
15	30	HDR unbiased	2479.6	2481.2	1.58
16	30	HDR biased	2509	2510.9	1.898
17	30	HDR biased	2545.2	2544.1	-1.108
18	30	HDR biased	2525.2	2528.2	2.91
19	30	HDR biased	2496.9	2488.1	-8.809
20	30	HDR biased	2495.6	2500.8	5.192
21	0	correlation	2508.5	2508.8	0.238
22	0	correlation	2532	2531.9	-0.084
23	0	correlation	2529.7	2531	1.356
24	0	correlation	2480.9	2481	0.051
25	0	correlation	2468.8	2468.1	-0.697

TID vs Post - Pre Exposure Delta

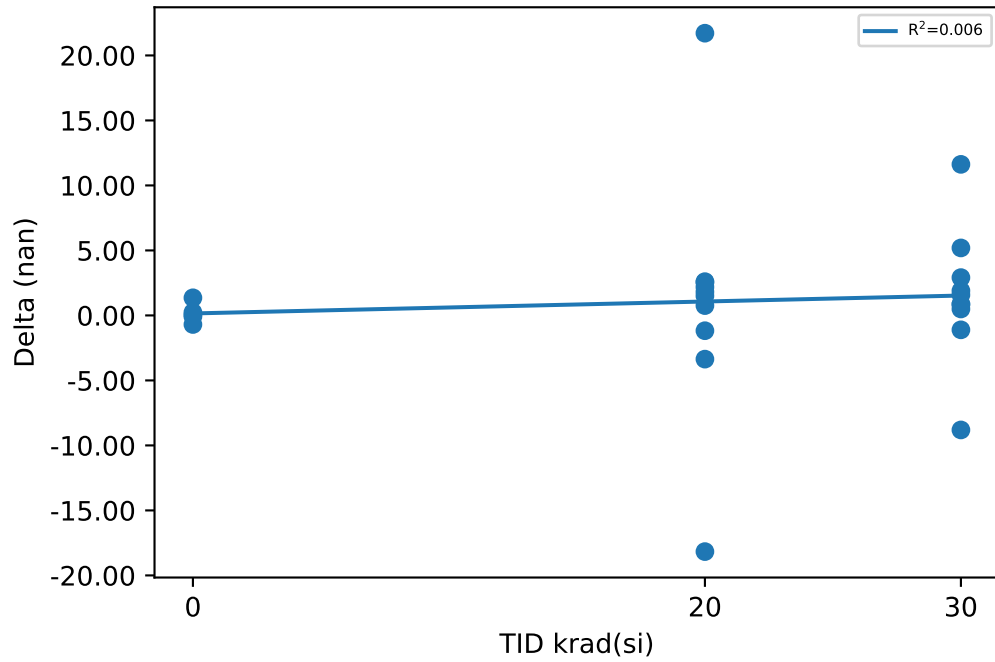

Test Statistics (nan)

krad(si)	Pre Exposure Min	Pre Exposure Avg	Pre Exposure Max	Pre Exposure Std	Post Exposure Min	Post Exposure Avg	Post Exposure Max	Post Exposure Std	Min Delta	Avg Delta	Max Delta	Std Delta
0	2468.8	2504	2532	28.441	2468.1	2504.2	2531.9	28.947	-0.697	0.1728	1.356	0.74859
20	2471	2497.9	2524.8	18.031	2472.9	2498.9	2525.5	18.664	-18.168	1.0403	21.711	9.5883
30	2479.6	2508.8	2545.2	19.806	2481.2	2510.3	2544.1	19.152	-8.809	1.5498	11.621	5.0892

Device Test: 11.5 UJ9ZQ5(dCLR_P25A_CH3_UJ9ZQ5)

TID vs Result Stats

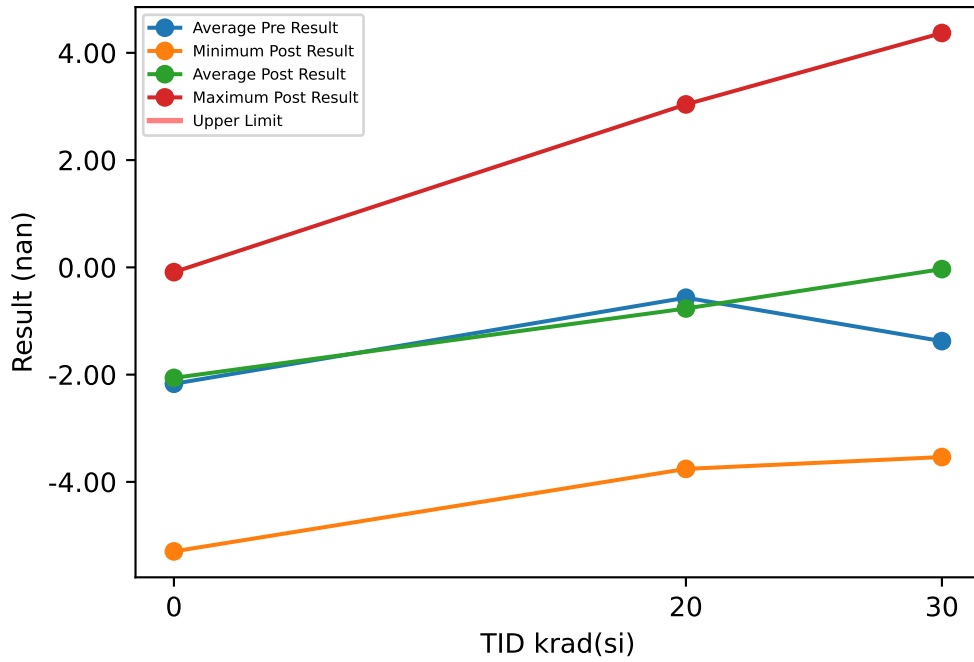

Test Results (No Limits Specified (nan))

Serial #	krad(si)	Exposure Conditions	Pre Result	Post Result	Delta
1	20	HDR unbiased	2.305	1.221	-1.084
2	20	HDR unbiased	0.407	-0.481	-0.888
3	20	HDR unbiased	0.093	0.074	-0.019
4	20	HDR unbiased	0.272	3.038	2.766
5	20	HDR unbiased	0.325	-0.697	-1.022
6	20	HDR biased	-3.282	-1.786	1.496
7	20	HDR biased	-2.957	-2.289	0.668
8	20	HDR biased	-0.027	-0.717	-0.69
9	20	HDR biased	-0.545	-2.273	-1.728
10	20	HDR biased	-2.249	-3.758	-1.509
11	30	HDR unbiased	0.795	1.222	0.427
12	30	HDR unbiased	2.206	2.862	0.656
13	30	HDR unbiased	-3.53	-2.569	0.961
14	30	HDR unbiased	-3.221	-3.026	0.195
15	30	HDR unbiased	-1.505	0.224	1.729
16	30	HDR biased	-3.059	-3.537	-0.478
17	30	HDR biased	-0.187	4.37	4.557
18	30	HDR biased	-1.362	1.203	2.565
19	30	HDR biased	-1.734	-0.231	1.503
20	30	HDR biased	-2.158	-0.846	1.312
21	0	correlation	-0.791	-0.615	0.176
22	0	correlation	-2.115	-1.755	0.36
23	0	correlation	0.005	-0.089	-0.094
24	0	correlation	-5.471	-5.296	0.175
25	0	correlation	-2.478	-2.549	-0.071

TID vs Post - Pre Exposure Delta

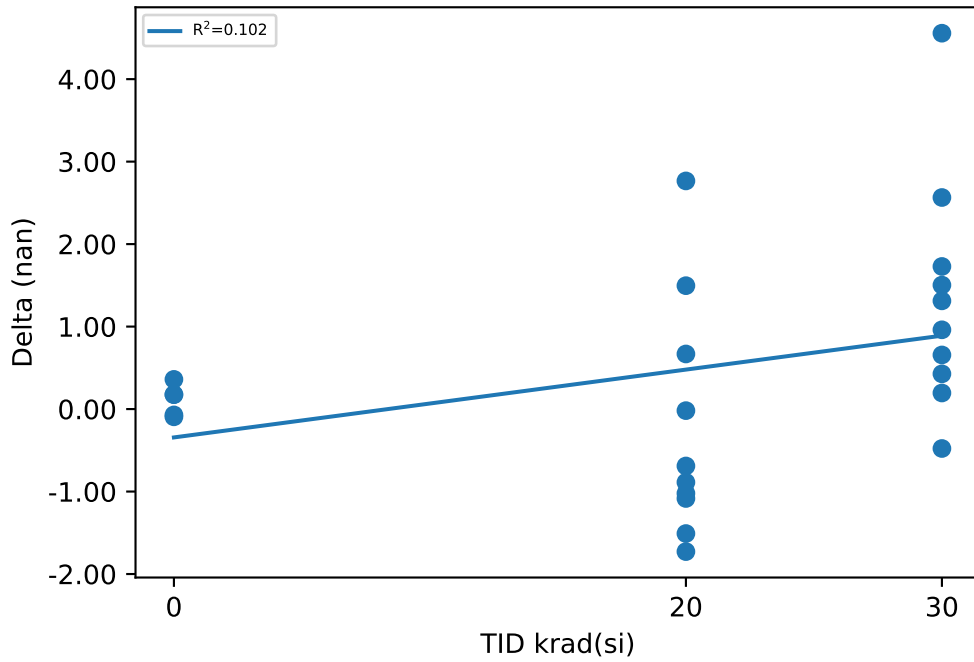

Test Statistics (nan)

krad(si)	Pre Exposure Min	Pre Exposure Avg	Pre Exposure Max	Pre Exposure Std	Post Exposure Min	Post Exposure Avg	Post Exposure Max	Post Exposure Std	Min Delta	Avg Delta	Max Delta	Std Delta
0	-5.471	-2.17	0.005	2.0992	-5.296	-2.0608	-0.089	2.048	-0.094	0.1092	0.36	0.19069
20	-3.282	-0.5658	2.305	1.7428	-3.758	-0.7668	3.038	1.9378	-1.728	-0.201	2.766	1.4406
30	-3.53	-1.3755	2.206	1.8436	-3.537	-0.0328	4.37	2.567	-0.478	1.3427	4.557	1.4177

Device Test: 11.6 UJSYNT(dCLR_P5A_CH3_UJSYNT)

TID vs Result Stats

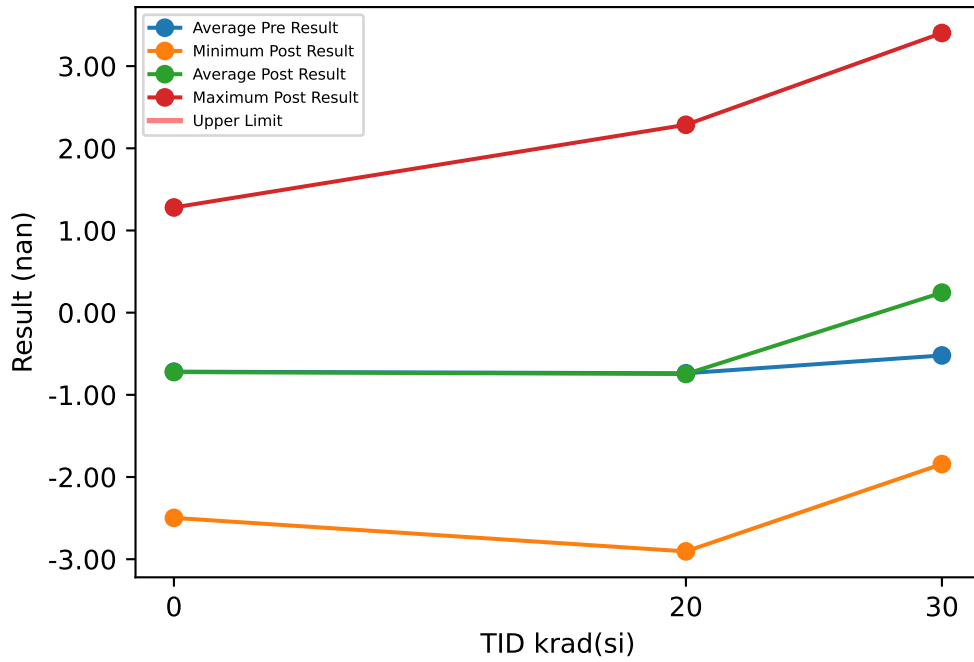

Test Results (No Limits Specified (nan))

Serial #	krad(si)	Exposure Conditions	Pre Result	Post Result	Delta
1	20	HDR unbiased	1.614	1.202	-0.412
2	20	HDR unbiased	0.428	-0.263	-0.691
3	20	HDR unbiased	-2.176	-1.974	0.202
4	20	HDR unbiased	0.803	2.286	1.483
5	20	HDR unbiased	-0.014	-0.592	-0.578
6	20	HDR biased	-1.782	-2.097	-0.315
7	20	HDR biased	-1.891	-1.417	0.474
8	20	HDR biased	0.171	-0.042	-0.213
9	20	HDR biased	-2.057	-2.905	-0.848
10	20	HDR biased	-2.47	-1.665	0.805
11	30	HDR unbiased	0.915	1.165	0.25
12	30	HDR unbiased	1.558	2.129	0.571
13	30	HDR unbiased	-1.28	-0.678	0.602
14	30	HDR unbiased	-3.013	-1.277	1.736
15	30	HDR unbiased	-0.498	0.609	1.107
16	30	HDR biased	-0.806	-1.089	-0.283
17	30	HDR biased	0.887	3.403	2.516
18	30	HDR biased	0.275	1.465	1.19
19	30	HDR biased	-0.611	-1.447	-0.836
20	30	HDR biased	-2.634	-1.843	0.791
21	0	correlation	-0.402	-0.383	0.019
22	0	correlation	1.209	1.28	0.071
23	0	correlation	0.591	0.465	-0.126
24	0	correlation	-2.618	-2.481	0.137
25	0	correlation	-2.369	-2.497	-0.128

TID vs Post - Pre Exposure Delta

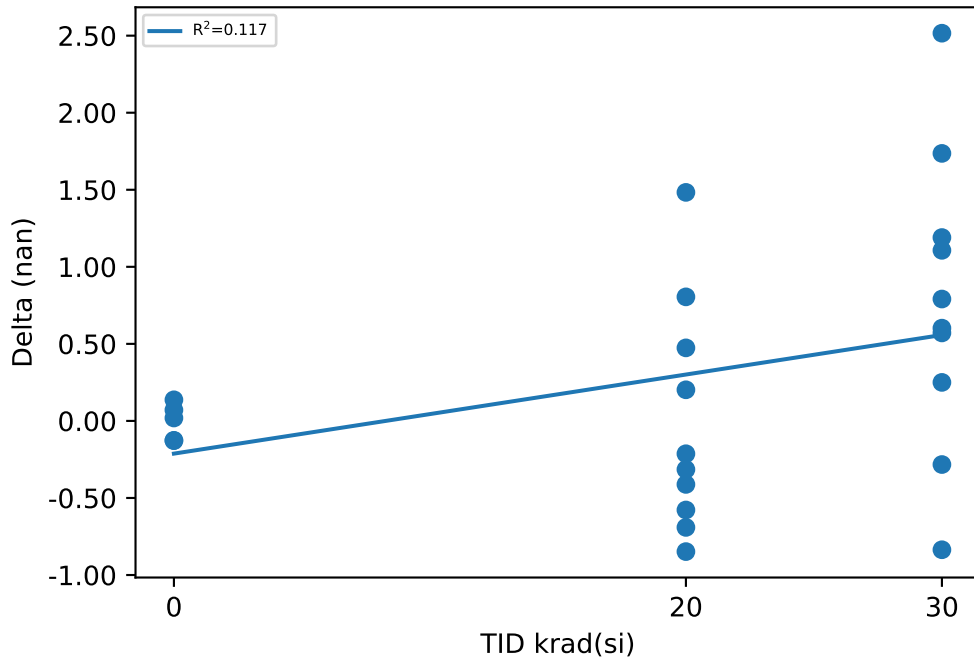

Test Statistics (nan)

krad(si)	Pre Exposure Min	Pre Exposure Avg	Pre Exposure Max	Pre Exposure Std	Post Exposure Min	Post Exposure Avg	Post Exposure Max	Post Exposure Std	Min Delta	Avg Delta	Max Delta	Std Delta
0	-2.618	-0.7178	1.209	1.7221	-2.497	-0.7232	1.28	1.7159	-0.128	-0.0054	0.137	0.11862
20	-2.47	-0.7374	1.614	1.4849	-2.905	-0.7467	2.286	1.5996	-0.848	-0.0093	1.483	0.74214
30	-3.013	-0.5207	1.558	1.5034	-1.843	0.2437	3.403	1.7689	-0.836	0.7644	2.516	0.96021

Device Test: 11.7 UJ9ZQ5(dCLR_P25A_CH4_UJ9ZQ5)

TID vs Result Stats

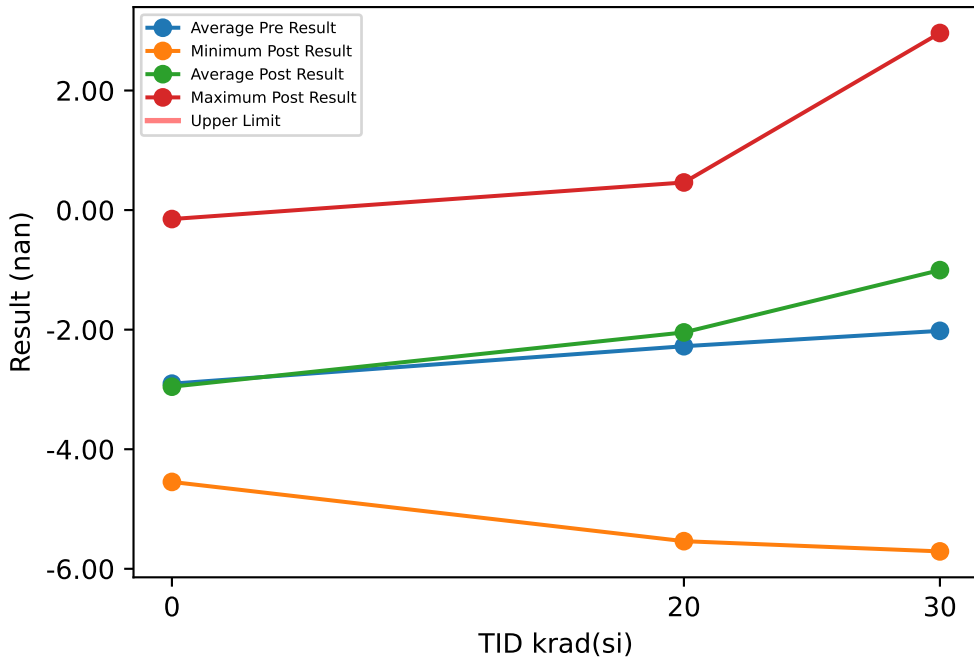

Test Results (No Limits Specified (nan))

Serial #	krad(si)	Exposure Conditions	Pre Result	Post Result	Delta
1	20	HDR unbiased	-1.826	-3.629	-1.803
2	20	HDR unbiased	-5.017	-5.538	-0.521
3	20	HDR unbiased	-0.538	-0.082	0.456
4	20	HDR unbiased	0.664	0.462	-0.202
5	20	HDR unbiased	-1.22	-1.486	-0.266
6	20	HDR biased	-3.874	-2.929	0.945
7	20	HDR biased	-1.613	-0.895	0.718
8	20	HDR biased	-2.385	-1.888	0.497
9	20	HDR biased	-3.667	-1.704	1.963
10	20	HDR biased	-3.296	-2.773	0.523
11	30	HDR unbiased	-1.824	-1.027	0.797
12	30	HDR unbiased	2.173	1.546	-0.627
13	30	HDR unbiased	-6.024	-5.709	0.315
14	30	HDR unbiased	-4.896	-1.579	3.317
15	30	HDR unbiased	-2.981	-2.255	0.726
16	30	HDR biased	0.134	1.095	0.961
17	30	HDR biased	0.981	2.962	1.981
18	30	HDR biased	-5.707	-4.069	1.638
19	30	HDR biased	-2.318	-3.912	-1.594
20	30	HDR biased	0.262	2.905	2.643
21	0	correlation	-1.977	-2.061	-0.084
22	0	correlation	-4.34	-4.416	-0.076
23	0	correlation	-0.291	-0.15	0.141
24	0	correlation	-4.383	-4.547	-0.164
25	0	correlation	-3.527	-3.596	-0.069

TID vs Post - Pre Exposure Delta

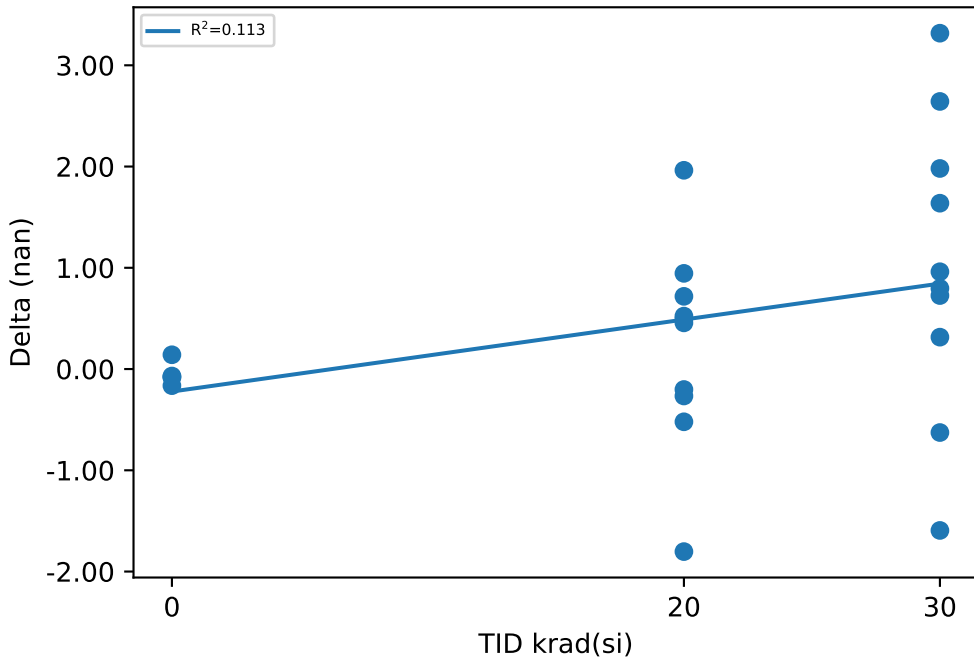

Test Statistics (nan)

krad(si)	Pre Exposure Min	Pre Exposure Avg	Pre Exposure Max	Pre Exposure Std	Post Exposure Min	Post Exposure Avg	Post Exposure Max	Post Exposure Std	Min Delta	Avg Delta	Max Delta	Std Delta
0	-4.383	-2.9036	-0.291	1.7553	-4.547	-2.954	-0.15	1.8539	-0.164	-0.0504	0.141	0.11365
20	-5.017	-2.2772	0.664	1.7151	-5.538	-2.0462	0.462	1.7618	-1.803	0.231	1.963	1.005
30	-6.024	-2.02	2.173	2.8941	-5.709	-1.0043	2.962	3.0514	-1.594	1.0157	3.317	1.4681

Device Test: 11.8 UJSYNT(dCLR_P5A_CH4_UJSYNT)

TID vs Result Stats

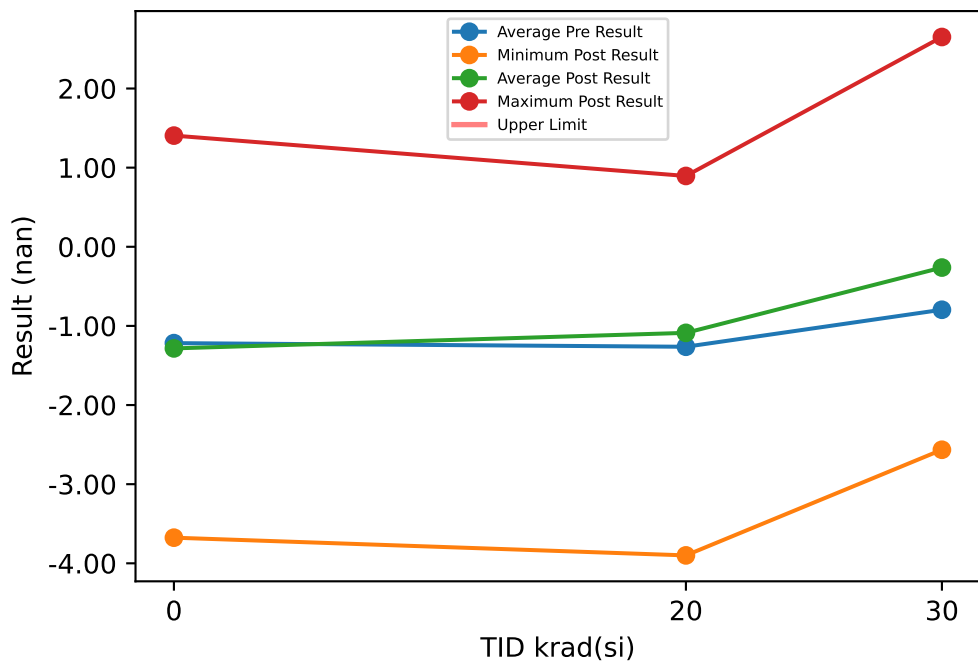

Test Results (No Limits Specified (nan))

Serial #	krad(si)	Exposure Conditions	Pre Result	Post Result	Delta
1	20	HDR unbiased	-1.556	-2.536	-0.98
2	20	HDR unbiased	-3.535	-3.9	-0.365
3	20	HDR unbiased	-0.614	-0.267	0.347
4	20	HDR unbiased	-0.287	-0.14	0.147
5	20	HDR unbiased	-1.746	-1.772	-0.026
6	20	HDR biased	-2.736	-2.068	0.668
7	20	HDR biased	0.556	0.895	0.339
8	20	HDR biased	0.126	0.403	0.277
9	20	HDR biased	-0.437	0.52	0.957
10	20	HDR biased	-2.405	-2.013	0.392
11	30	HDR unbiased	-0.029	0.323	0.352
12	30	HDR unbiased	1.206	0.962	-0.244
13	30	HDR unbiased	-1.586	-1.452	0.134
14	30	HDR unbiased	-3.03	-1.223	1.807
15	30	HDR unbiased	-2.771	-2.265	0.506
16	30	HDR biased	0.031	0.643	0.612
17	30	HDR biased	1.9	2.651	0.751
18	30	HDR biased	-1.444	-0.577	0.867
19	30	HDR biased	-1.694	-2.565	-0.871
20	30	HDR biased	-0.541	0.877	1.418
21	0	correlation	-0.352	-0.415	-0.063
22	0	correlation	-0.063	-0.171	-0.108
23	0	correlation	1.274	1.405	0.131
24	0	correlation	-3.493	-3.676	-0.183
25	0	correlation	-3.454	-3.564	-0.11

TID vs Post - Pre Exposure Delta

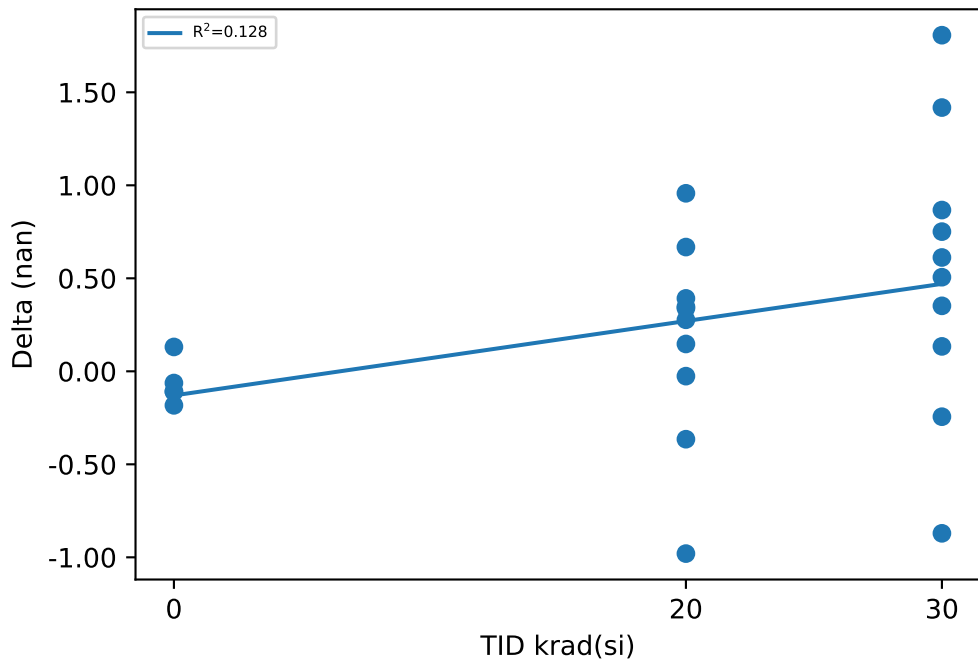

Test Statistics (nan)

krad(si)	Pre Exposure Min	Pre Exposure Avg	Pre Exposure Max	Pre Exposure Std	Post Exposure Min	Post Exposure Avg	Post Exposure Max	Post Exposure Std	Min Delta	Avg Delta	Max Delta	Std Delta
0	-3.493	-1.2176	1.274	2.1488	-3.676	-1.2842	1.405	2.2441	-0.183	-0.0666	0.131	0.11854
20	-3.535	-1.2634	0.556	1.3437	-3.9	-1.0878	0.895	1.5847	-0.98	0.1756	0.957	0.54113
30	-3.03	-0.7958	1.9	1.6109	-2.565	-0.2626	2.651	1.6397	-0.871	0.5332	1.807	0.77023

Device Test: 11.9 UJPX6I(Delta_dCLR_P5A_CH1CH2_UJPX6I)

TID vs Result Stats

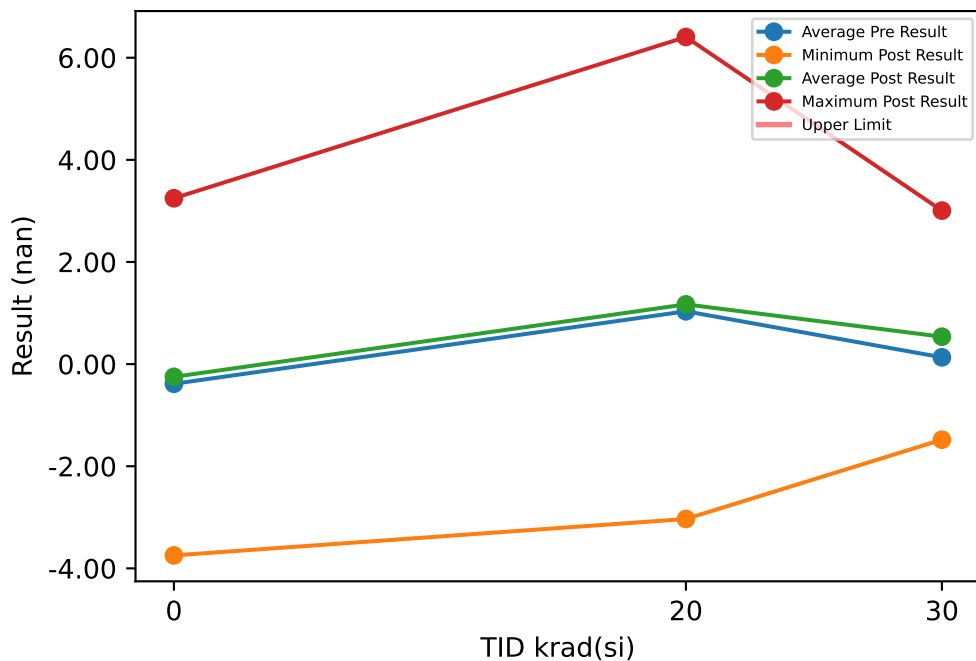

Test Results (No Limits Specified (nan))

Serial #	krad(si)	Exposure Conditions	Pre Result	Post Result	Delta
1	20	HDR unbiased	-2.683	-3.033	-0.35
2	20	HDR unbiased	2.389	2.132	-0.257
3	20	HDR unbiased	0.678	1.798	1.12
4	20	HDR unbiased	2.017	3.018	1.001
5	20	HDR unbiased	5.015	6.406	1.391
6	20	HDR biased	-0.966	1.483	2.449
7	20	HDR biased	3.438	4.371	0.933
8	20	HDR biased	-0.487	-0.987	-0.5
9	20	HDR biased	-1.016	-0.667	0.349
10	20	HDR biased	1.957	-2.822	-4.779
11	30	HDR unbiased	0.572	0.352	-0.22
12	30	HDR unbiased	-0.945	-0.936	0.009
13	30	HDR unbiased	-0.828	-1.48	-0.652
14	30	HDR unbiased	1.608	-0.584	-2.192
15	30	HDR unbiased	1.677	2.274	0.597
16	30	HDR biased	-0.186	1.124	1.31
17	30	HDR biased	0.023	-0.436	-0.459
18	30	HDR biased	0.378	1.732	1.354
19	30	HDR biased	-0.289	3.006	3.295
20	30	HDR biased	-0.682	0.316	0.998
21	0	correlation	3.232	3.248	0.016
22	0	correlation	-1.337	-1.256	0.081
23	0	correlation	-3.862	-3.746	0.116
24	0	correlation	0.53	0.855	0.325
25	0	correlation	-0.489	-0.346	0.143

TID vs Post - Pre Exposure Delta

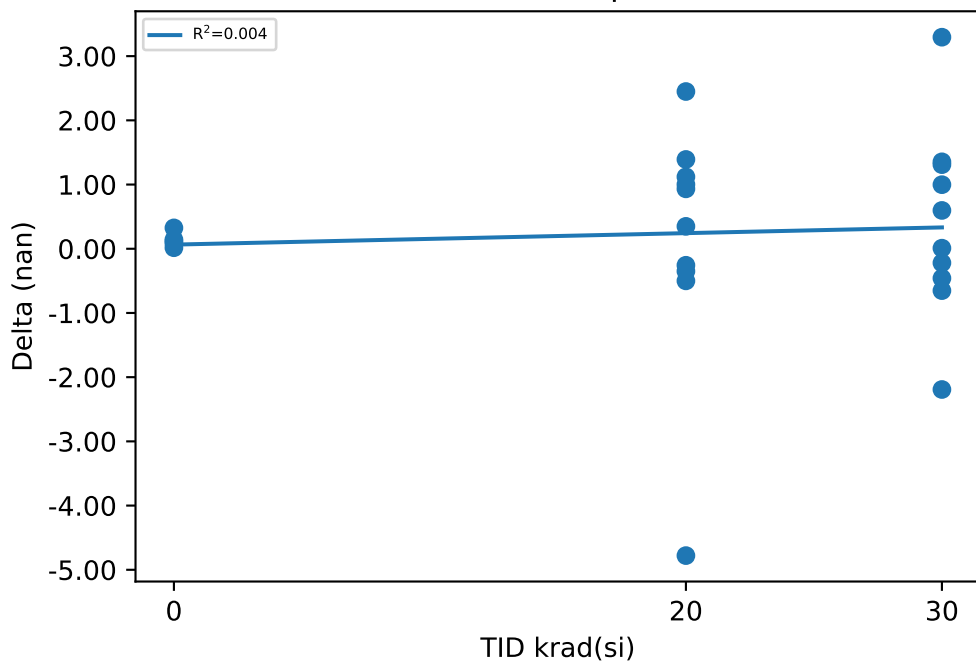

Test Statistics (nan)

krad(si)	Pre Exposure Min	Pre Exposure Avg	Pre Exposure Max	Pre Exposure Std	Post Exposure Min	Post Exposure Avg	Post Exposure Max	Post Exposure Std	Min Delta	Avg Delta	Max Delta	Std Delta
0	-3.862	-0.3852	3.232	2.5945	-3.746	-0.249	3.248	2.5836	0.016	0.1362	0.325	0.11575
20	-2.683	1.0342	5.015	2.3509	-3.033	1.1699	6.406	3.0573	-4.779	0.1357	2.449	1.9515
30	-0.945	0.1328	1.677	0.93417	-1.48	0.5368	3.006	1.4686	-2.192	0.404	3.295	1.4763

Device Test: 12.10 UJ4ZR4(RDSON_12V_OUT3_UJE410_UJ4ZR4)

TID vs Result Stats

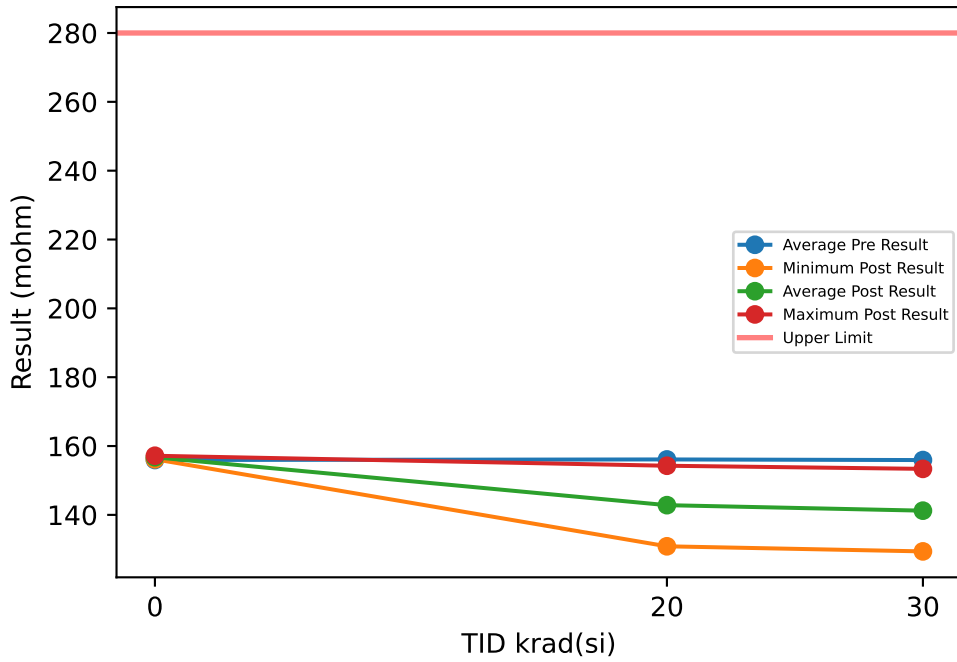

Test Results (Upper Limit = 280.0 (mohm))

Serial #	krad(si)	Exposure Conditions	Pre Result	Post Result	Delta
1	20	HDR unbiased	157.04	154.08	-2.958
2	20	HDR unbiased	156.1	153.08	-3.0115
3	20	HDR unbiased	155.02	152.16	-2.8669
4	20	HDR unbiased	156.17	153.31	-2.8621
5	20	HDR unbiased	156.8	154.28	-2.5254
6	20	HDR biased	156.58	132.56	-24.012
7	20	HDR biased	155.12	131.7	-23.412
8	20	HDR biased	154.32	130.87	-23.453
9	20	HDR biased	156.93	132.57	-24.359
10	20	HDR biased	157.01	133.62	-23.39
11	30	HDR unbiased	154.13	151.38	-2.746
12	30	HDR unbiased	155.61	152.17	-3.4439
13	30	HDR unbiased	157.05	153.37	-3.6788
14	30	HDR unbiased	155.25	153.29	-1.9634
15	30	HDR unbiased	155.72	152.63	-3.0932
16	30	HDR biased	157.1	130.39	-26.705
17	30	HDR biased	156.11	129.57	-26.546
18	30	HDR biased	156.68	130.36	-26.314
19	30	HDR biased	156.54	129.71	-26.821
20	30	HDR biased	155.08	129.39	-25.693
21	0	correlation	155.9	156.9	1.001
22	0	correlation	155.36	156.15	0.7957
23	0	correlation	156.41	157.18	0.7738
24	0	correlation	156.22	156.96	0.7348
25	0	correlation	155.83	156.51	0.6818

TID vs Post - Pre Exposure Delta

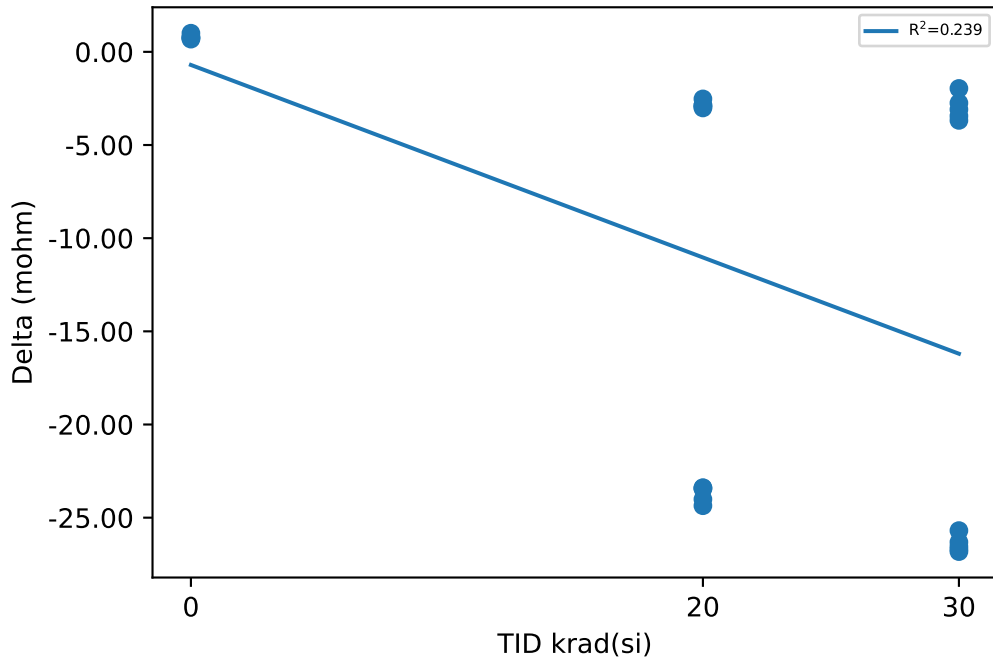

Test Statistics (mohm)

krad(si)	Pre Exposure Min	Pre Exposure Avg	Pre Exposure Max	Pre Exposure Std	Post Exposure Min	Post Exposure Avg	Post Exposure Max	Post Exposure Std	Min Delta	Avg Delta	Max Delta	Std Delta
0	155.36	155.94	156.41	0.40339	156.15	156.74	157.18	0.40732	0.6818	0.79742	1.001	0.12175
20	154.32	156.11	157.04	0.96576	130.87	142.82	154.28	11.164	-24.359	-13.285	-2.5254	11.01
30	154.13	155.93	157.1	0.95126	129.39	141.23	153.37	11.971	-26.821	-14.7	-1.9634	12.361

Device Test: 12.1 UJ4ZR4(RDSON_5V_OUT1_UJE410_UJ4ZR4)

TID vs Result Stats

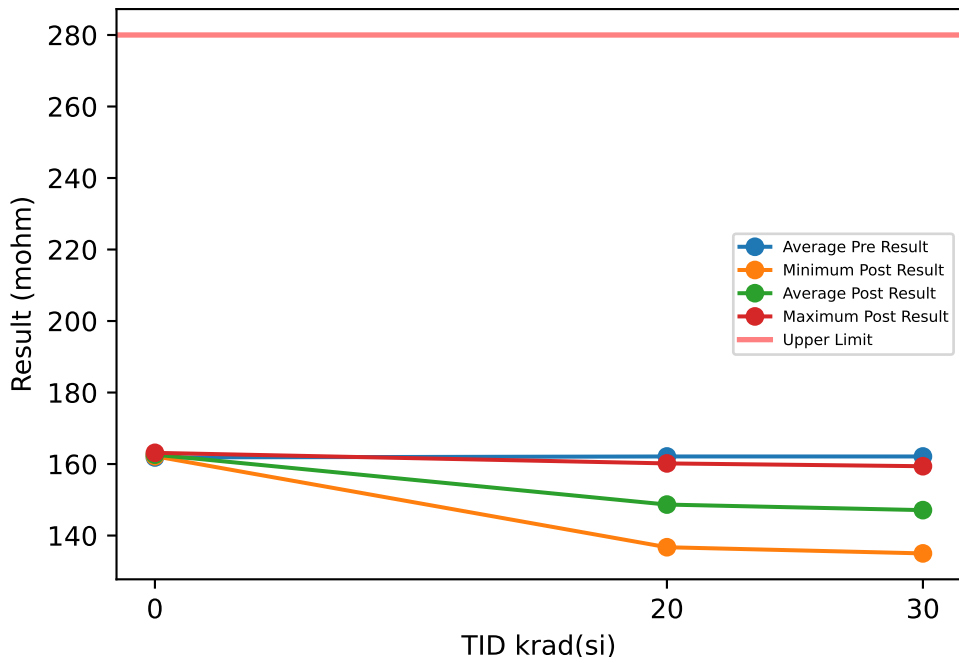

Test Results (Upper Limit = 280.0 (mohm))

Serial #	krad(si)	Exposure Conditions	Pre Result	Post Result	Delta
1	20	HDR unbiased	163.17	160.18	-2.9982
2	20	HDR unbiased	162.38	159.35	-3.0308
3	20	HDR unbiased	161.35	158.49	-2.8603
4	20	HDR unbiased	162.14	159.04	-3.1021
5	20	HDR unbiased	162.4	159.72	-2.6784
6	20	HDR biased	161.98	138.81	-23.171
7	20	HDR biased	161.54	137.69	-23.853
8	20	HDR biased	160.43	136.73	-23.697
9	20	HDR biased	162.32	137.93	-24.394
10	20	HDR biased	163.49	138.73	-24.758
11	30	HDR unbiased	160.11	157.37	-2.7467
12	30	HDR unbiased	162.05	158.69	-3.3657
13	30	HDR unbiased	163	159.39	-3.6053
14	30	HDR unbiased	160.96	159.11	-1.8479
15	30	HDR unbiased	161.25	158.16	-3.0932
16	30	HDR biased	162.82	135.3	-27.525
17	30	HDR biased	162.43	135.49	-26.941
18	30	HDR biased	164.94	137.5	-27.441
19	30	HDR biased	162.36	135.06	-27.299
20	30	HDR biased	161.24	135.01	-26.227
21	0	correlation	161.83	162.82	0.9908
22	0	correlation	161.35	162.18	0.8253
23	0	correlation	162.41	163.13	0.72
24	0	correlation	161.81	162.52	0.715
25	0	correlation	161.82	162.46	0.6421

TID vs Post - Pre Exposure Delta

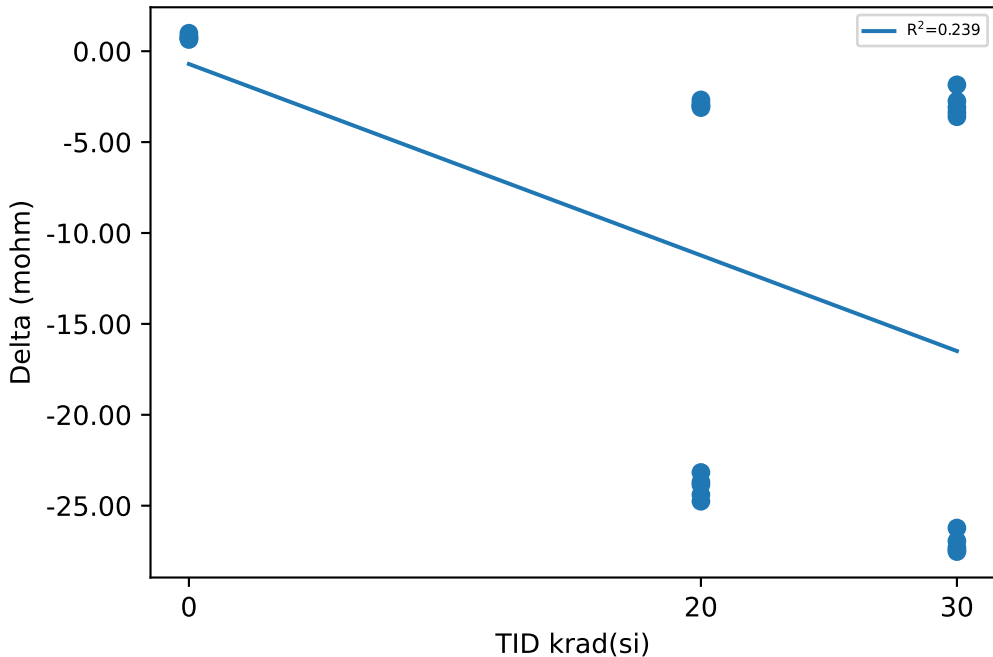

Test Statistics (mohm)

krad(si)	Pre Exposure Min	Pre Exposure Avg	Pre Exposure Max	Pre Exposure Std	Post Exposure Min	Post Exposure Avg	Post Exposure Max	Post Exposure Std	Min Delta	Avg Delta	Max Delta	Std Delta
0	161.35	161.84	162.41	0.37773	162.18	162.62	163.13	0.36614	0.6421	0.77864	0.9908	0.13539
20	160.43	162.12	163.49	0.88025	136.73	148.67	160.18	11.29	-24.758	-13.454	-2.6784	11.098
30	160.11	162.12	164.94	1.3458	135.01	147.11	159.39	12.086	-27.525	-15.009	-1.8479	12.744

Device Test: 12.11 UJ4ZR4(RDSON_28V_OUT3_UJE410_UJ4ZR4)

TID vs Result Stats

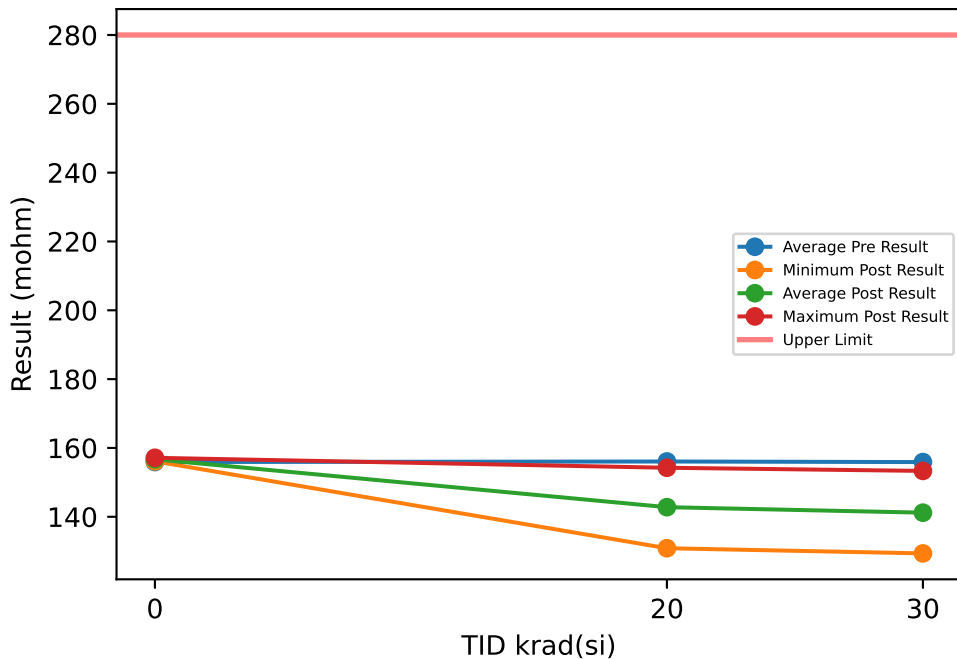

Test Results (Upper Limit = 280.0 (mohm))

Serial #	krad(si)	Exposure Conditions	Pre Result	Post Result	Delta
1	20	HDR unbiased	156.99	154.02	-2.9643
2	20	HDR unbiased	156.05	153.03	-3.0193
3	20	HDR unbiased	154.96	152.11	-2.8498
4	20	HDR unbiased	156.12	153.27	-2.8512
5	20	HDR unbiased	156.76	154.24	-2.517
6	20	HDR biased	156.53	132.55	-23.979
7	20	HDR biased	155.07	131.68	-23.384
8	20	HDR biased	154.26	130.86	-23.408
9	20	HDR biased	156.89	132.54	-24.344
10	20	HDR biased	156.98	133.59	-23.389
11	30	HDR unbiased	154.08	151.34	-2.738
12	30	HDR unbiased	155.59	152.14	-3.4488
13	30	HDR unbiased	157.02	153.33	-3.6938
14	30	HDR unbiased	155.21	153.25	-1.9574
15	30	HDR unbiased	155.69	152.58	-3.1069
16	30	HDR biased	157.08	130.37	-26.704
17	30	HDR biased	156.08	129.53	-26.552
18	30	HDR biased	156.63	130.33	-26.304
19	30	HDR biased	156.51	129.68	-26.831
20	30	HDR biased	155.04	129.36	-25.686
21	0	correlation	155.86	156.87	1.0086
22	0	correlation	155.31	156.1	0.7969
23	0	correlation	156.36	157.14	0.7747
24	0	correlation	156.18	156.91	0.7271
25	0	correlation	155.81	156.47	0.6617

TID vs Post - Pre Exposure Delta

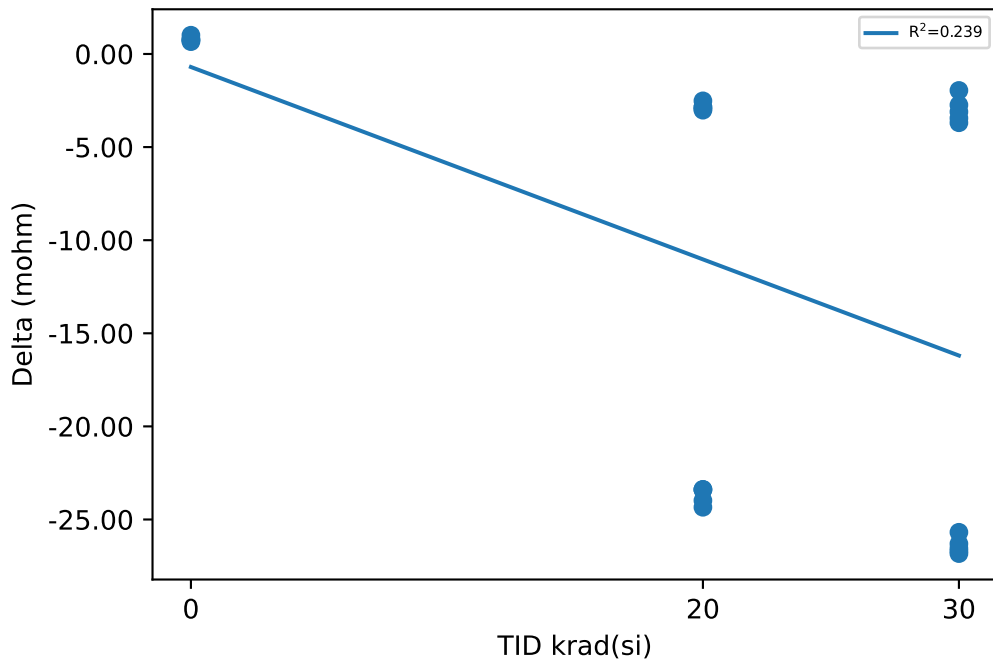

Test Statistics (mohm)

krad(si)	Pre Exposure Min	Pre Exposure Avg	Pre Exposure Max	Pre Exposure Std	Post Exposure Min	Post Exposure Avg	Post Exposure Max	Post Exposure Std	Min Delta	Avg Delta	Max Delta	Std Delta
0	155.31	155.91	156.36	0.40516	156.1	156.7	157.14	0.41037	0.6617	0.7938	1.0086	0.13078
20	154.26	156.06	156.99	0.97232	130.86	142.79	154.24	11.152	-24.344	-13.271	-2.517	10.999
30	154.08	155.89	157.08	0.95746	129.36	141.19	153.33	11.968	-26.831	-14.702	-1.9574	12.359

Device Test: 12.12 UJ4ZR4(RDSON_32V_OUT3_UJE410_UJ4ZR4)

TID vs Result Stats

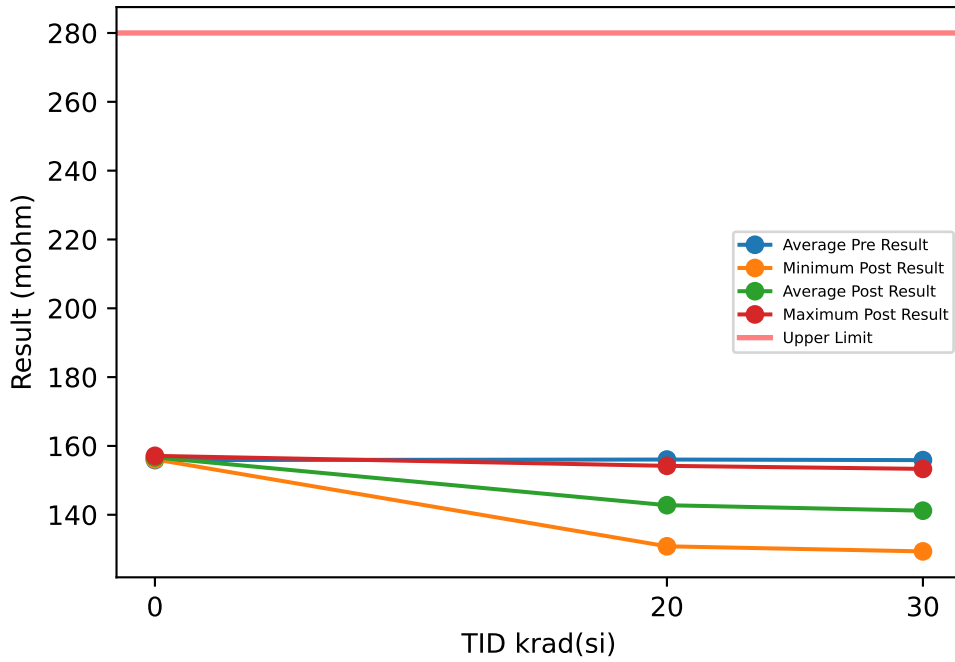

Test Results (Upper Limit = 280.0 (mohm))

Serial #	krad(si)	Exposure Conditions	Pre Result	Post Result	Delta
1	20	HDR unbiased	157	154.03	-2.9681
2	20	HDR unbiased	156.03	153.02	-3.0101
3	20	HDR unbiased	154.96	152.12	-2.8465
4	20	HDR unbiased	156.12	153.26	-2.8587
5	20	HDR unbiased	156.74	154.22	-2.5227
6	20	HDR biased	156.51	132.54	-23.968
7	20	HDR biased	155.05	131.66	-23.391
8	20	HDR biased	154.27	130.83	-23.433
9	20	HDR biased	156.86	132.53	-24.333
10	20	HDR biased	156.97	133.59	-23.376
11	30	HDR unbiased	154.08	151.34	-2.7365
12	30	HDR unbiased	155.57	152.12	-3.4532
13	30	HDR unbiased	157.01	153.33	-3.6817
14	30	HDR unbiased	155.2	153.24	-1.9613
15	30	HDR unbiased	155.67	152.57	-3.0996
16	30	HDR biased	157.06	130.37	-26.695
17	30	HDR biased	156.06	129.53	-26.536
18	30	HDR biased	156.62	130.33	-26.284
19	30	HDR biased	156.5	129.69	-26.808
20	30	HDR biased	155.02	129.36	-25.668
21	0	correlation	155.85	156.87	1.0191
22	0	correlation	155.3	156.09	0.7924
23	0	correlation	156.35	157.13	0.7729
24	0	correlation	156.17	156.9	0.7302
25	0	correlation	155.78	156.46	0.6784

TID vs Post - Pre Exposure Delta

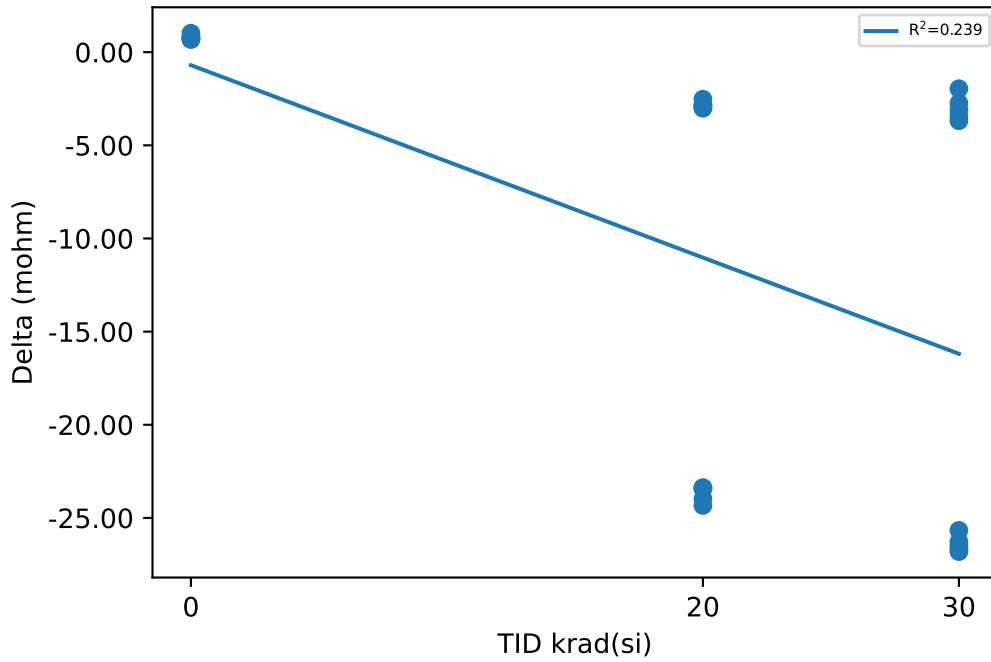

Test Statistics (mohm)

krad(si)	Pre Exposure Min	Pre Exposure Avg	Pre Exposure Max	Pre Exposure Std	Post Exposure Min	Post Exposure Avg	Post Exposure Max	Post Exposure Std	Min Delta	Avg Delta	Max Delta	Std Delta
0	155.3	155.89	156.35	0.40464	156.09	156.69	157.13	0.41139	0.6784	0.7986	1.0191	0.13081
20	154.27	156.05	157	0.96934	130.83	142.78	154.22	11.156	-24.333	-13.271	-2.5227	10.998
30	154.08	155.88	157.06	0.95571	129.36	141.19	153.33	11.963	-26.808	-14.692	-1.9613	12.351

Device Test: 12.13 UJ4ZR4(RDSON_5V_OUT4_UJE410_UJ4ZR4)

TID vs Result Stats

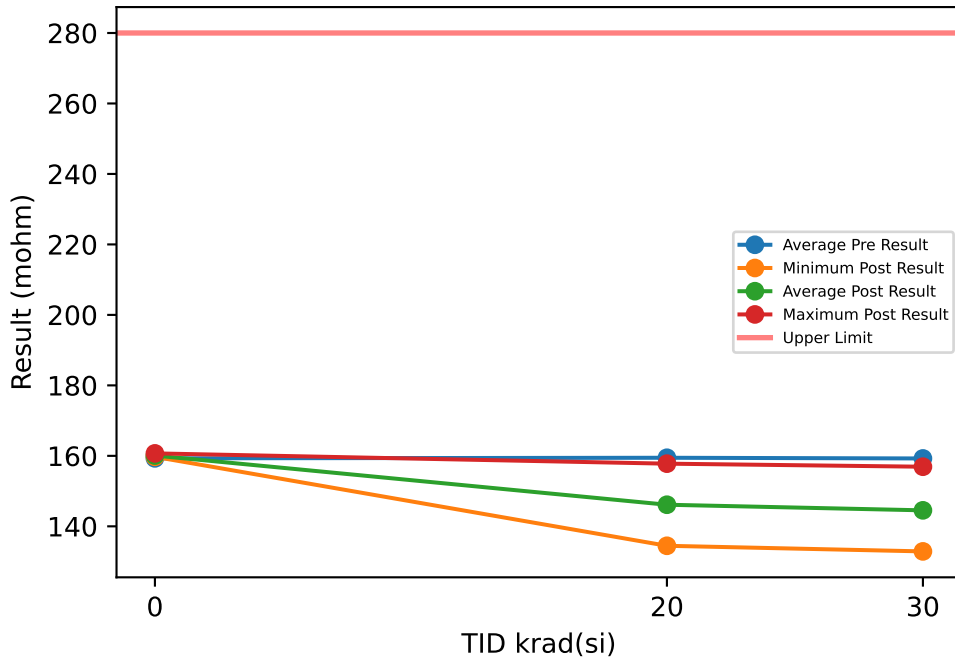

TID vs Post - Pre Exposure Delta

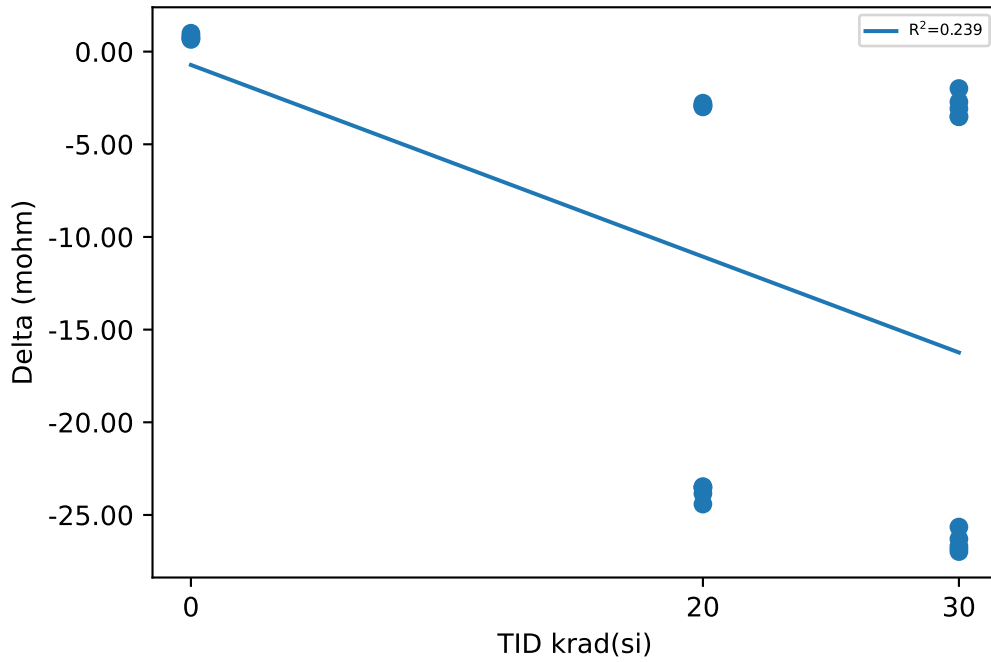

Test Results (Upper Limit = 280.0 (mohm))

Serial #	krad(si)	Exposure Conditions	Pre Result	Post Result	Delta
1	20	HDR unbiased	160.2	157.24	-2.9603
2	20	HDR unbiased	159.38	156.4	-2.9843
3	20	HDR unbiased	158.52	155.62	-2.8978
4	20	HDR unbiased	158.89	156	-2.8847
5	20	HDR unbiased	160.56	157.78	-2.7793
6	20	HDR biased	159.92	136.07	-23.847
7	20	HDR biased	158.43	134.9	-23.525
8	20	HDR biased	157.95	134.48	-23.468
9	20	HDR biased	160.32	135.91	-24.415
10	20	HDR biased	160.42	136.9	-23.522
11	30	HDR unbiased	157.52	154.81	-2.7122
12	30	HDR unbiased	159.08	155.56	-3.5194
13	30	HDR unbiased	160.42	156.92	-3.5014
14	30	HDR unbiased	158.56	156.57	-1.99
15	30	HDR unbiased	158.65	155.57	-3.0755
16	30	HDR biased	159.83	133	-26.829
17	30	HDR biased	159.69	133.01	-26.683
18	30	HDR biased	160.08	133.79	-26.295
19	30	HDR biased	159.86	132.89	-26.977
20	30	HDR biased	158.92	133.27	-25.65
21	0	correlation	159.17	160.17	0.9936
22	0	correlation	158.86	159.72	0.8579
23	0	correlation	159.96	160.7	0.7385
24	0	correlation	159.38	160.1	0.7158
25	0	correlation	159.09	159.75	0.6562

Test Statistics (mohm)

krad(si)	Pre Exposure Min	Pre Exposure Avg	Pre Exposure Max	Pre Exposure Std	Post Exposure Min	Post Exposure Avg	Post Exposure Max	Post Exposure Std	Min Delta	Avg Delta	Max Delta	Std Delta
0	158.86	159.29	159.96	0.41836	159.72	160.09	160.7	0.39872	0.6562	0.7924	0.9936	0.13425
20	157.95	159.46	160.56	0.95512	134.48	146.13	157.78	11.081	-24.415	-13.328	-2.7793	10.995
30	157.52	159.26	160.42	0.87825	132.89	144.54	156.92	11.977	-26.977	-14.723	-1.99	12.412

Device Test: 12.14 UJ4ZR4(RDSON_12V_OUT4_UJE410_UJ4ZR4)

TID vs Result Stats

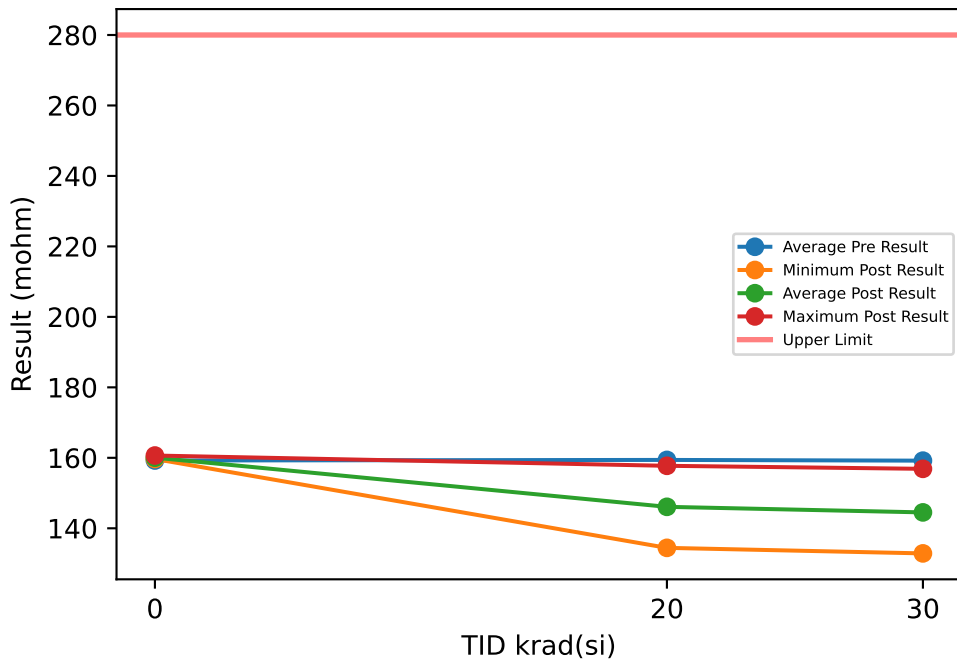

Test Results (Upper Limit = 280.0 (mohm))

Serial #	krad(si)	Exposure Conditions	Pre Result	Post Result	Delta
1	20	HDR unbiased	160.12	157.18	-2.9429
2	20	HDR unbiased	159.33	156.37	-2.9559
3	20	HDR unbiased	158.49	155.57	-2.9191
4	20	HDR unbiased	158.85	155.97	-2.8786
5	20	HDR unbiased	160.5	157.73	-2.7708
6	20	HDR biased	159.86	136.03	-23.833
7	20	HDR biased	158.36	134.86	-23.506
8	20	HDR biased	157.89	134.45	-23.439
9	20	HDR biased	160.28	135.89	-24.387
10	20	HDR biased	160.34	136.85	-23.492
11	30	HDR unbiased	157.44	154.77	-2.6703
12	30	HDR unbiased	159.01	155.53	-3.4729
13	30	HDR unbiased	160.36	156.88	-3.4829
14	30	HDR unbiased	158.48	156.54	-1.936
15	30	HDR unbiased	158.58	155.52	-3.0629
16	30	HDR biased	159.75	132.96	-26.784
17	30	HDR biased	159.63	133	-26.628
18	30	HDR biased	160.02	133.75	-26.264
19	30	HDR biased	159.82	132.87	-26.947
20	30	HDR biased	158.87	133.26	-25.606
21	0	correlation	159.12	160.12	1.0042
22	0	correlation	158.8	159.66	0.8536
23	0	correlation	159.89	160.65	0.7626
24	0	correlation	159.35	160.04	0.6928
25	0	correlation	159.04	159.75	0.7054

TID vs Post - Pre Exposure Delta

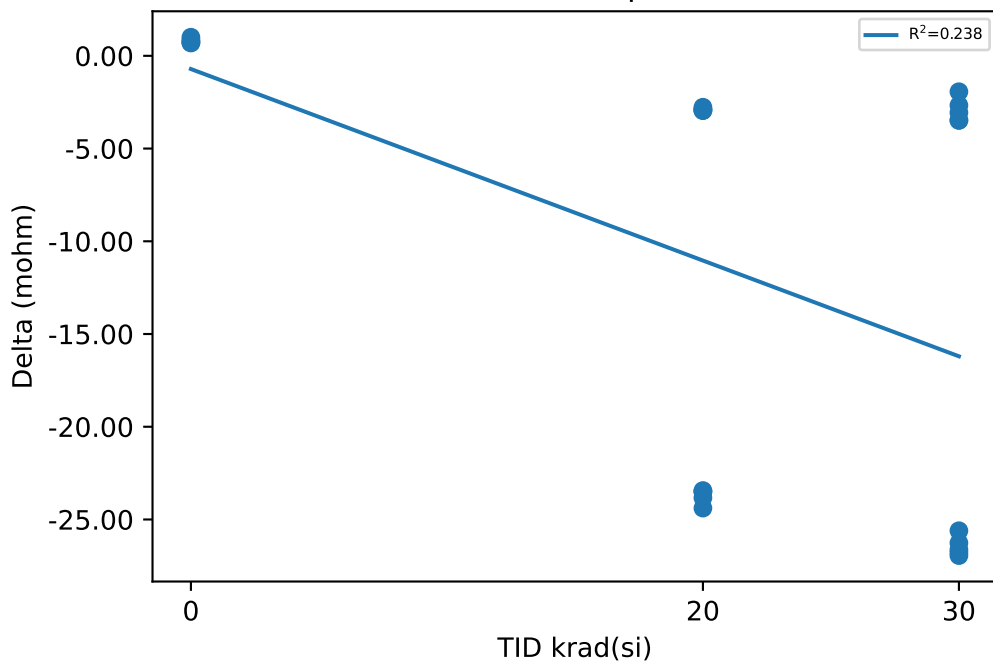

Test Statistics (mohm)

krad(si)	Pre Exposure Min	Pre Exposure Avg	Pre Exposure Max	Pre Exposure Std	Post Exposure Min	Post Exposure Avg	Post Exposure Max	Post Exposure Std	Min Delta	Avg Delta	Max Delta	Std Delta
0	158.8	159.24	159.89	0.41119	159.66	160.04	160.65	0.39074	0.6928	0.80372	1.0042	0.12878
20	157.89	159.4	160.5	0.95016	134.45	146.09	157.73	11.076	-24.387	-13.312	-2.7708	10.986
30	157.44	159.2	160.36	0.88334	132.87	144.51	156.88	11.968	-26.947	-14.686	-1.936	12.409

Device Test: 12.15 UJ4ZR4(RDSON_28V_OUT4_UJE410_UJ4ZR4)

TID vs Result Stats

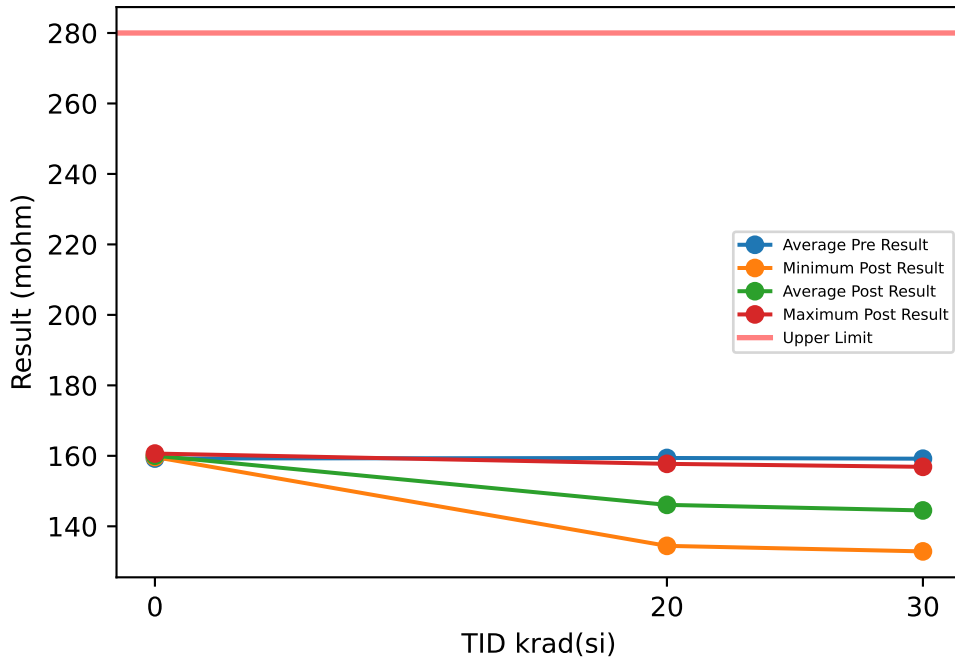

TID vs Post - Pre Exposure Delta

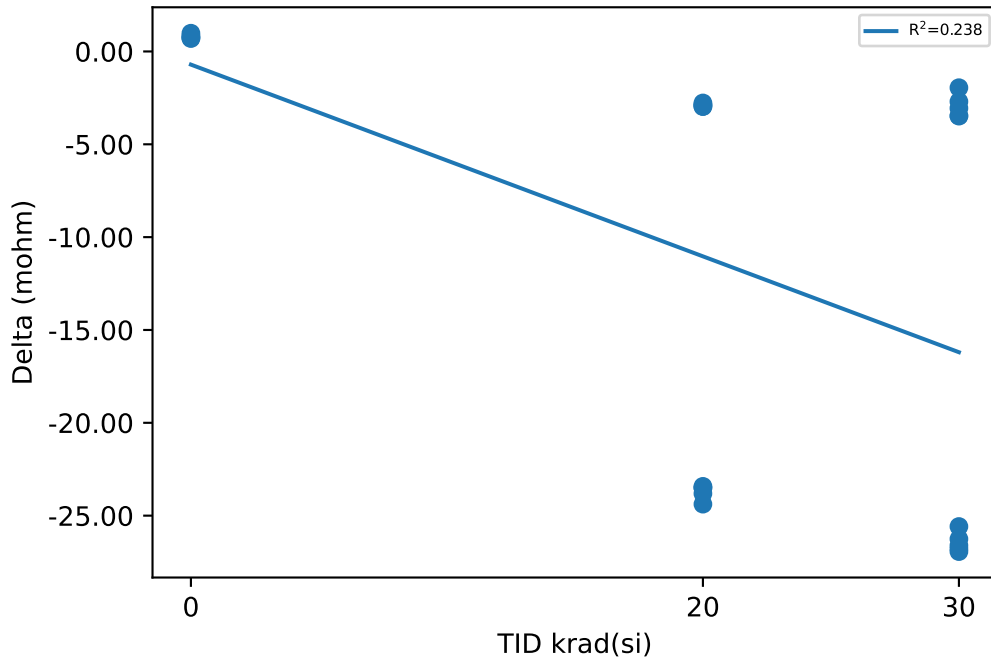

Test Results (Upper Limit = 280.0 (mohm))

Serial #	krad(si)	Exposure Conditions	Pre Result	Post Result	Delta
1	20	HDR unbiased	160.14	157.18	-2.9608
2	20	HDR unbiased	159.32	156.35	-2.9669
3	20	HDR unbiased	158.46	155.57	-2.8916
4	20	HDR unbiased	158.81	155.96	-2.8548
5	20	HDR unbiased	160.5	157.73	-2.7732
6	20	HDR biased	159.86	136.05	-23.812
7	20	HDR biased	158.35	134.86	-23.492
8	20	HDR biased	157.87	134.45	-23.422
9	20	HDR biased	160.27	135.89	-24.381
10	20	HDR biased	160.35	136.84	-23.512
11	30	HDR unbiased	157.44	154.74	-2.6993
12	30	HDR unbiased	158.99	155.53	-3.4637
13	30	HDR unbiased	160.36	156.88	-3.4819
14	30	HDR unbiased	158.48	156.53	-1.9514
15	30	HDR unbiased	158.57	155.51	-3.058
16	30	HDR biased	159.75	132.96	-26.792
17	30	HDR biased	159.61	133	-26.61
18	30	HDR biased	160	133.74	-26.257
19	30	HDR biased	159.81	132.88	-26.936
20	30	HDR biased	158.84	133.25	-25.585
21	0	correlation	159.11	160.09	0.9835
22	0	correlation	158.79	159.65	0.8531
23	0	correlation	159.88	160.65	0.7671
24	0	correlation	159.33	160.07	0.7347
25	0	correlation	159.03	159.73	0.6953

Test Statistics (mohm)

krad(si)	Pre Exposure Min	Pre Exposure Avg	Pre Exposure Max	Pre Exposure Std	Post Exposure Min	Post Exposure Avg	Post Exposure Max	Post Exposure Std	Min Delta	Avg Delta	Max Delta	Std Delta
0	158.79	159.23	159.88	0.41122	159.65	160.04	160.65	0.39509	0.6953	0.80674	0.9835	0.11464
20	157.87	159.39	160.5	0.9607	134.45	146.09	157.73	11.07	-24.381	-13.307	-2.7732	10.984
30	157.44	159.19	160.36	0.88295	132.88	144.5	156.88	11.966	-26.936	-14.683	-1.9514	12.401

Device Test: 12.16 UJ4ZR4(RDSON_32V_OUT4_UJE410_UJ4ZR4)

TID vs Result Stats

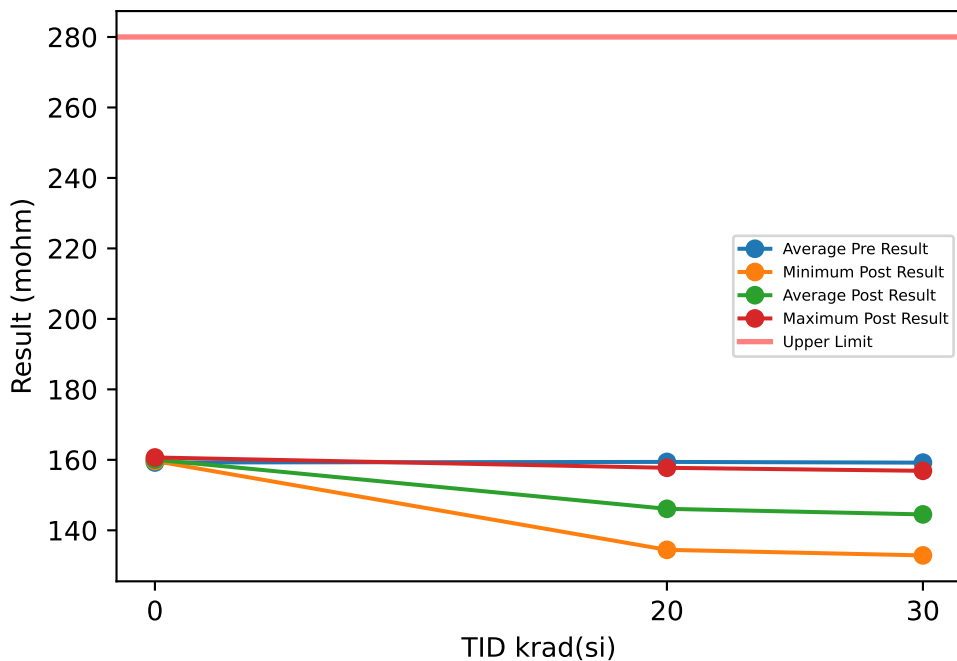

TID vs Post - Pre Exposure Delta

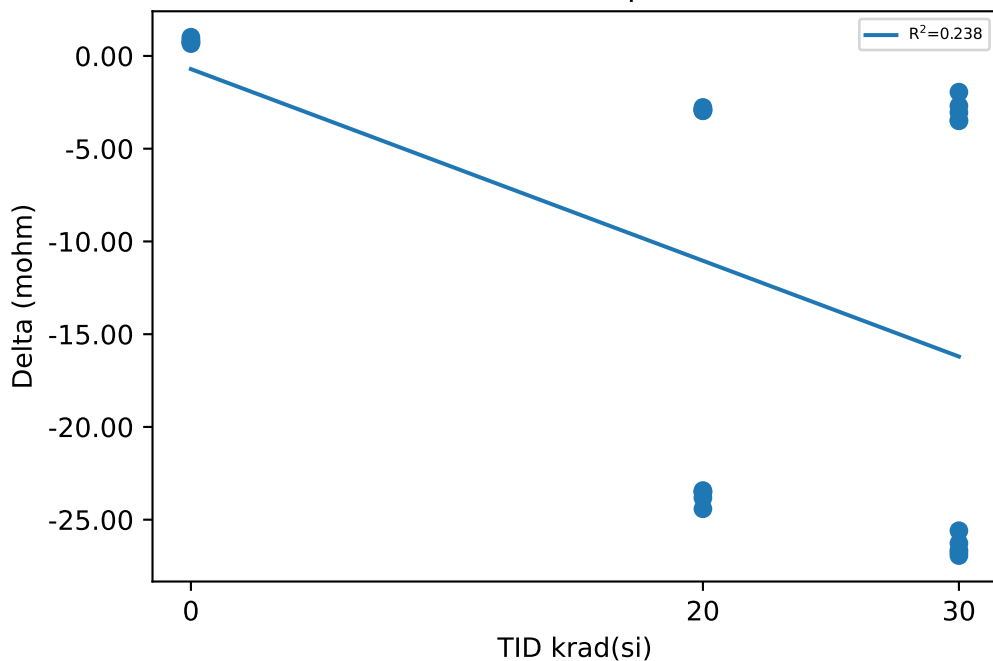

Test Results (Upper Limit = 280.0 (mohm))

Serial #	krad(si)	Exposure Conditions	Pre Result	Post Result	Delta
1	20	HDR unbiased	160.16	157.21	-2.9517
2	20	HDR unbiased	159.34	156.38	-2.9576
3	20	HDR unbiased	158.48	155.58	-2.8945
4	20	HDR unbiased	158.85	155.97	-2.8777
5	20	HDR unbiased	160.51	157.74	-2.7731
6	20	HDR biased	159.87	136.05	-23.822
7	20	HDR biased	158.37	134.85	-23.513
8	20	HDR biased	157.89	134.46	-23.427
9	20	HDR biased	160.29	135.88	-24.413
10	20	HDR biased	160.36	136.86	-23.505
11	30	HDR unbiased	157.46	154.76	-2.6965
12	30	HDR unbiased	159.01	155.53	-3.4798
13	30	HDR unbiased	160.38	156.88	-3.4976
14	30	HDR unbiased	158.5	156.55	-1.9481
15	30	HDR unbiased	158.58	155.53	-3.0474
16	30	HDR biased	159.76	132.98	-26.778
17	30	HDR biased	159.64	133	-26.641
18	30	HDR biased	160.03	133.76	-26.272
19	30	HDR biased	159.82	132.88	-26.936
20	30	HDR biased	158.86	133.27	-25.593
21	0	correlation	159.12	160.13	1.0109
22	0	correlation	158.79	159.66	0.8693
23	0	correlation	159.9	160.67	0.7721
24	0	correlation	159.34	160.06	0.7215
25	0	correlation	159.07	159.73	0.6646

Test Statistics (mohm)

krad(si)	Pre Exposure Min	Pre Exposure Avg	Pre Exposure Max	Pre Exposure Std	Post Exposure Min	Post Exposure Avg	Post Exposure Max	Post Exposure Std	Min Delta	Avg Delta	Max Delta	Std Delta
0	158.79	159.24	159.9	0.41664	159.66	160.05	160.67	0.40295	0.6646	0.80768	1.0109	0.13625
20	157.89	159.41	160.51	0.95906	134.46	146.1	157.74	11.079	-24.413	-13.314	-2.7731	10.99
30	157.46	159.2	160.38	0.88501	132.88	144.52	156.88	11.966	-26.936	-14.689	-1.9481	12.403

Device Test: 12.17 UJJ3KD(Delta_RDSON_5V_CH1CH2_UJJ3KD)

TID vs Result Stats

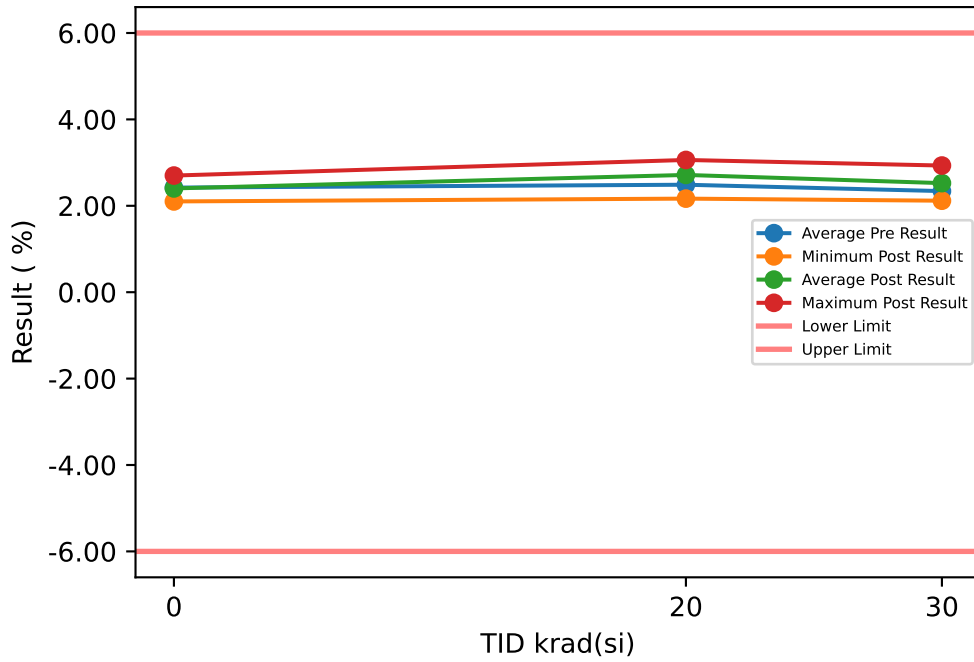

Test Results (Lower Limit = -6.0, Upper Limit = 6.0 (%))

Serial #	krad(si)	Exposure Conditions	Pre Result	Post Result	Delta
1	20	HDR unbiased	2.679	2.607	-0.072
2	20	HDR unbiased	2.877	2.925	0.048
3	20	HDR unbiased	2.49	2.528	0.038
4	20	HDR unbiased	2.495	2.407	-0.088
5	20	HDR unbiased	2.133	2.166	0.033
6	20	HDR biased	2.478	3.023	0.545
7	20	HDR biased	2.215	2.567	0.352
8	20	HDR biased	2.443	2.976	0.533
9	20	HDR biased	2.589	3.061	0.472
10	20	HDR biased	2.478	2.885	0.407
11	30	HDR unbiased	2.31	2.404	0.094
12	30	HDR unbiased	2.439	2.486	0.047
13	30	HDR unbiased	2.647	2.663	0.016
14	30	HDR unbiased	2.29	2.242	-0.048
15	30	HDR unbiased	2.034	2.118	0.084
16	30	HDR biased	2.22	2.485	0.265
17	30	HDR biased	2.231	2.575	0.344
18	30	HDR biased	2.526	2.932	0.406
19	30	HDR biased	2.224	2.609	0.385
20	30	HDR biased	2.483	2.735	0.252
21	0	correlation	2.112	2.101	-0.011
22	0	correlation	2.348	2.37	0.022
23	0	correlation	2.47	2.435	-0.035
24	0	correlation	2.43	2.405	-0.025
25	0	correlation	2.747	2.7	-0.047

TID vs Post - Pre Exposure Delta

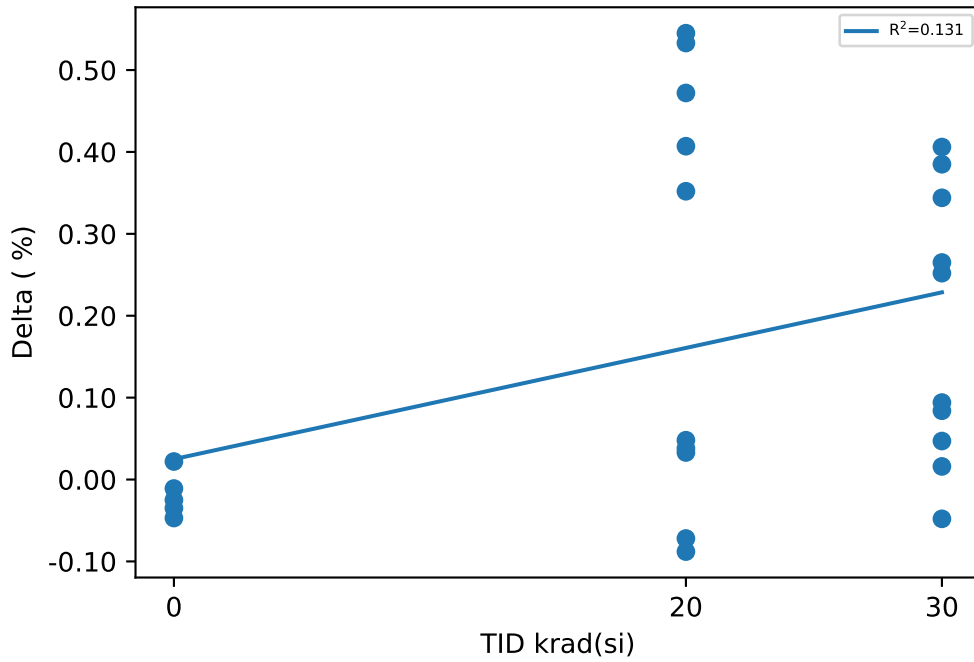

Test Statistics (%)

krad(si)	Pre Exposure Min	Pre Exposure Avg	Pre Exposure Max	Pre Exposure Std	Post Exposure Min	Post Exposure Avg	Post Exposure Max	Post Exposure Std	Min Delta	Avg Delta	Max Delta	Std Delta
0	2.112	2.4214	2.747	0.22889	2.101	2.4022	2.7	0.21303	-0.047	-0.0192	0.022	0.026556
20	2.133	2.4877	2.877	0.21104	2.166	2.7145	3.061	0.30194	-0.088	0.2268	0.545	0.25752
30	2.034	2.3404	2.647	0.18131	2.118	2.5249	2.932	0.23614	-0.048	0.1845	0.406	0.16512

Device Test: 12.18 UJJ3KD(Delta_RDSON_5V_CH1CH3_UJJ3KD)

TID vs Result Stats

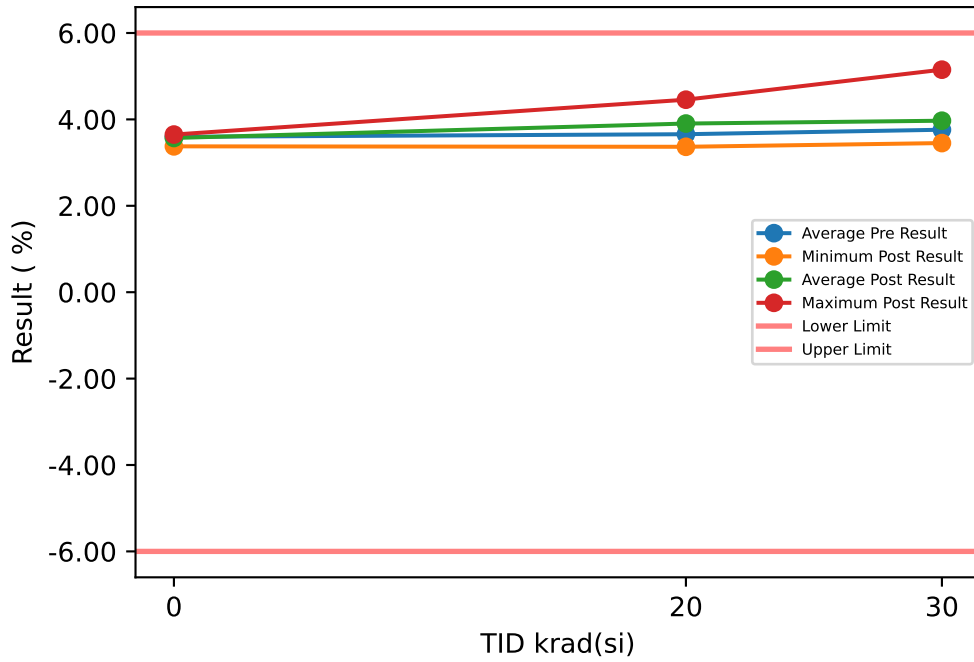

Test Results (Lower Limit = -6.0, Upper Limit = 6.0 (%))

Serial #	krad(si)	Exposure Conditions	Pre Result	Post Result	Delta
1	20	HDR unbiased	3.709	3.768	0.059
2	20	HDR unbiased	3.827	3.897	0.07
3	20	HDR unbiased	3.873	3.954	0.081
4	20	HDR unbiased	3.62	3.554	-0.066
5	20	HDR unbiased	3.385	3.366	-0.019
6	20	HDR biased	3.285	4.456	1.171
7	20	HDR biased	3.922	4.306	0.384
8	20	HDR biased	3.759	4.244	0.485
9	20	HDR biased	3.279	3.85	0.571
10	20	HDR biased	3.911	3.645	-0.266
11	30	HDR unbiased	3.683	3.752	0.069
12	30	HDR unbiased	3.917	4.068	0.151
13	30	HDR unbiased	3.585	3.719	0.134
14	30	HDR unbiased	3.505	3.609	0.104
15	30	HDR unbiased	3.375	3.452	0.077
16	30	HDR biased	3.45	3.587	0.137
17	30	HDR biased	3.835	4.313	0.478
18	30	HDR biased	4.958	5.151	0.193
19	30	HDR biased	3.543	3.923	0.38
20	30	HDR biased	3.756	4.121	0.365
21	0	correlation	3.612	3.579	-0.033
22	0	correlation	3.675	3.649	-0.026
23	0	correlation	3.658	3.618	-0.04
24	0	correlation	3.391	3.376	-0.015
25	0	correlation	3.649	3.628	-0.021

TID vs Post - Pre Exposure Delta

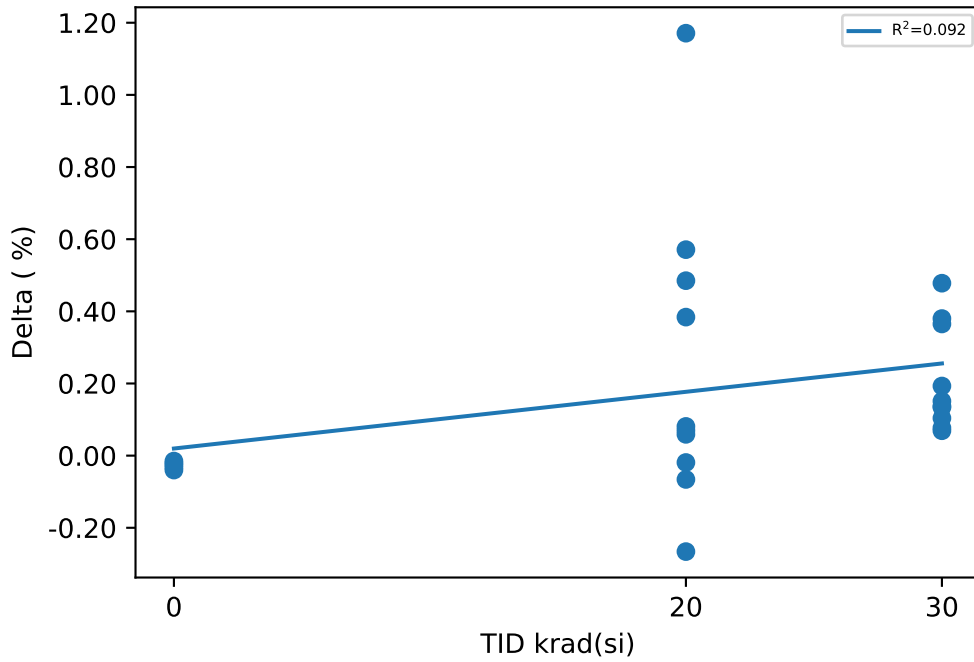

Test Statistics (%)

krad(si)	Pre Exposure Min	Pre Exposure Avg	Pre Exposure Max	Pre Exposure Std	Post Exposure Min	Post Exposure Avg	Post Exposure Max	Post Exposure Std	Min Delta	Avg Delta	Max Delta	Std Delta
0	3.391	3.597	3.675	0.11744	3.376	3.57	3.649	0.11138	-0.04	-0.027	-0.015	0.0098234
20	3.279	3.657	3.922	0.25386	3.366	3.904	4.456	0.34719	-0.266	0.247	1.171	0.41637
30	3.375	3.7607	4.958	0.45442	3.452	3.9695	5.151	0.49474	0.069	0.2088	0.478	0.14469

Device Test: 12.19 UJJ3KD(Delta_RDSON_5V_CH1CH4_UJJ3KD)

TID vs Result Stats

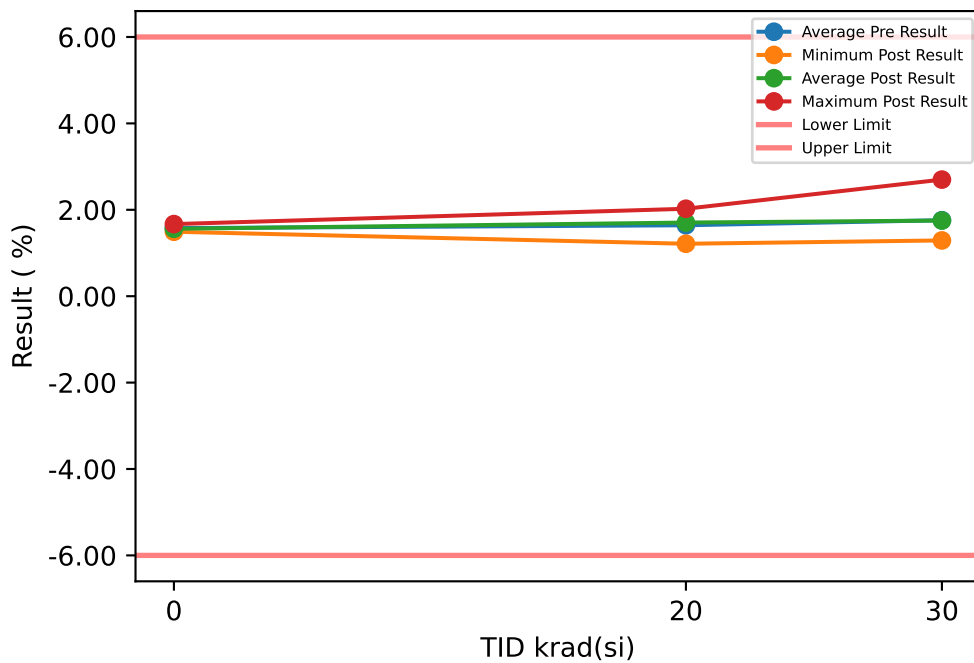

Test Results (Lower Limit = -6.0, Upper Limit = 6.0 (%))

Serial #	krad(si)	Exposure Conditions	Pre Result	Post Result	Delta
1	20	HDR unbiased	1.823	1.834	0.011
2	20	HDR unbiased	1.846	1.852	0.006
3	20	HDR unbiased	1.752	1.807	0.055
4	20	HDR unbiased	2.006	1.908	-0.098
5	20	HDR unbiased	1.132	1.214	0.082
6	20	HDR biased	1.272	1.972	0.7
7	20	HDR biased	1.928	2.024	0.096
8	20	HDR biased	1.549	1.65	0.101
9	20	HDR biased	1.233	1.466	0.233
10	20	HDR biased	1.876	1.32	-0.556
11	30	HDR unbiased	1.618	1.625	0.007
12	30	HDR unbiased	1.835	1.971	0.136
13	30	HDR unbiased	1.582	1.553	-0.029
14	30	HDR unbiased	1.493	1.599	0.106
15	30	HDR unbiased	1.614	1.635	0.021
16	30	HDR biased	1.837	1.696	-0.141
17	30	HDR biased	1.685	1.83	0.145
18	30	HDR biased	2.945	2.699	-0.246
19	30	HDR biased	1.54	1.612	0.072
20	30	HDR biased	1.439	1.291	-0.148
21	0	correlation	1.641	1.629	-0.012
22	0	correlation	1.545	1.517	-0.028
23	0	correlation	1.51	1.492	-0.018
24	0	correlation	1.499	1.492	-0.007
25	0	correlation	1.685	1.669	-0.016

TID vs Post - Pre Exposure Delta

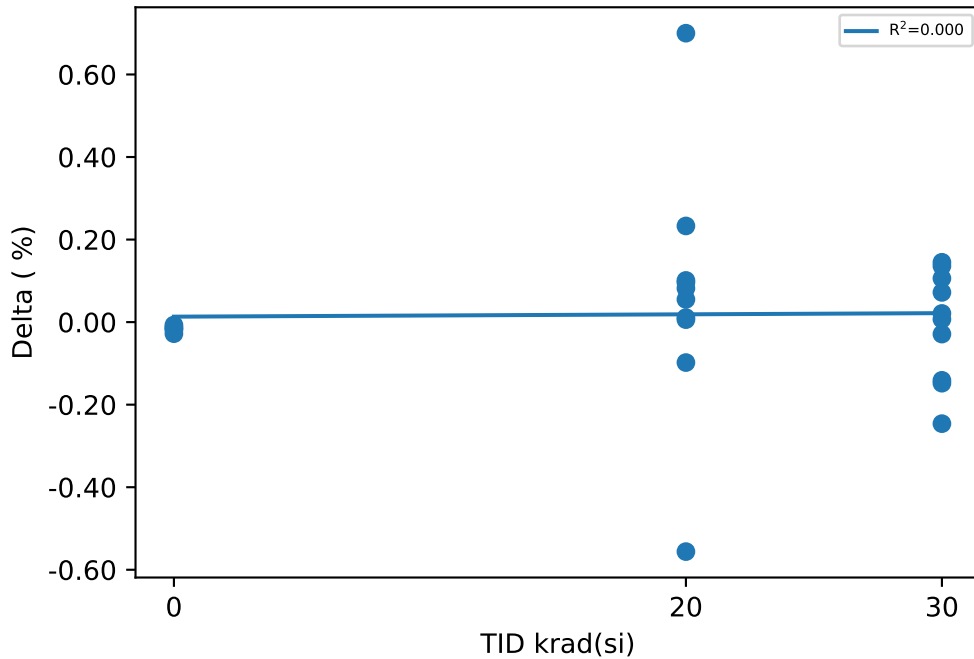

Test Statistics (%)

krad(si)	Pre Exposure Min	Pre Exposure Avg	Pre Exposure Max	Pre Exposure Std	Post Exposure Min	Post Exposure Avg	Post Exposure Max	Post Exposure Std	Min Delta	Avg Delta	Max Delta	Std Delta
0	1.499	1.576	1.685	0.082692	1.492	1.5598	1.669	0.083275	-0.028	-0.0162	-0.007	0.007823
20	1.132	1.6417	2.006	0.32119	1.214	1.7047	2.024	0.28134	-0.556	0.063	0.7	0.3078
30	1.439	1.7588	2.945	0.43682	1.291	1.7511	2.699	0.37697	-0.246	-0.0077	0.145	0.13291

Device Test: 12.20 UJJ3KD(Delta_RDSON_5V_CH2CH3_UJJ3KD)

TID vs Result Stats

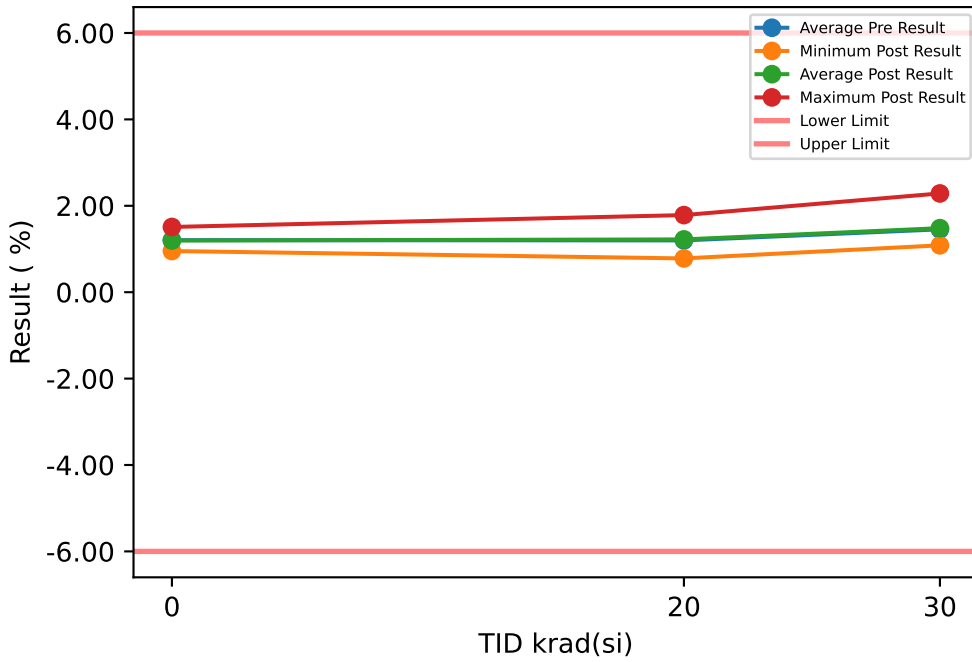

TID vs Post - Pre Exposure Delta

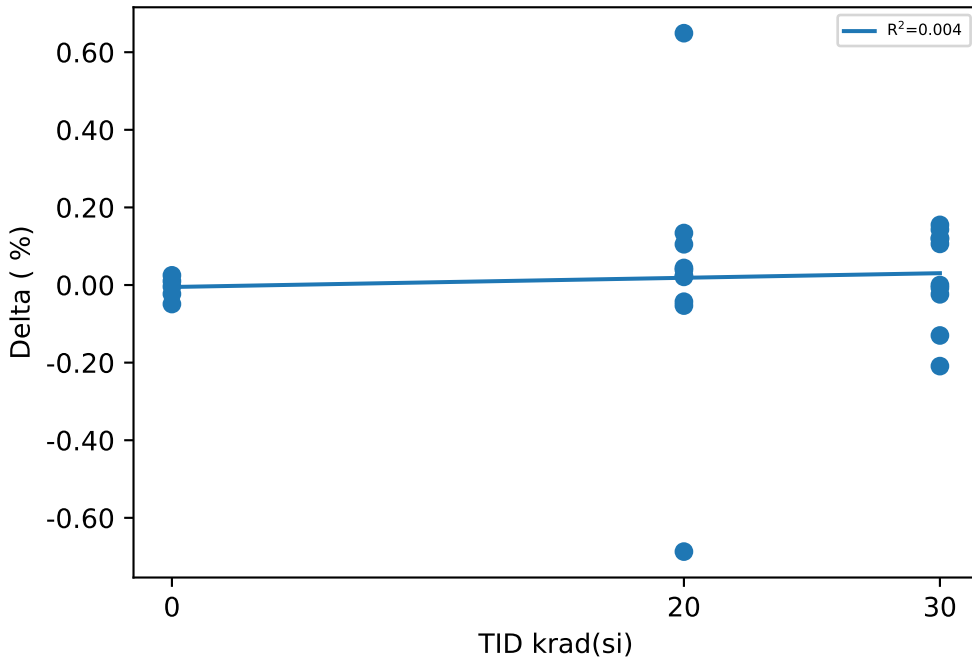

Test Results (Lower Limit = -6.0, Upper Limit = 6.0 (%))

Serial #	krad(si)	Exposure Conditions	Pre Result	Post Result	Delta
1	20	HDR unbiased	1.058	1.192	0.134
2	20	HDR unbiased	0.978	1.002	0.024
3	20	HDR unbiased	1.419	1.463	0.044
4	20	HDR unbiased	1.154	1.175	0.021
5	20	HDR unbiased	1.279	1.226	-0.053
6	20	HDR biased	0.828	1.477	0.649
7	20	HDR biased	1.746	1.785	0.039
8	20	HDR biased	1.349	1.306	-0.043
9	20	HDR biased	0.709	0.814	0.105
10	20	HDR biased	1.469	0.782	-0.687
11	30	HDR unbiased	1.405	1.381	-0.024
12	30	HDR unbiased	1.516	1.622	0.106
13	30	HDR unbiased	0.964	1.085	0.121
14	30	HDR unbiased	1.243	1.398	0.155
15	30	HDR unbiased	1.369	1.362	-0.007
16	30	HDR biased	1.259	1.129	-0.13
17	30	HDR biased	1.641	1.784	0.143
18	30	HDR biased	2.495	2.286	-0.209
19	30	HDR biased	1.349	1.349	0
20	30	HDR biased	1.306	1.425	0.119
21	0	correlation	1.533	1.51	-0.023
22	0	correlation	1.359	1.31	-0.049
23	0	correlation	1.217	1.213	-0.004
24	0	correlation	0.985	0.995	0.01
25	0	correlation	0.928	0.953	0.025

Test Statistics (%)

krad(si)	Pre Exposure Min	Pre Exposure Avg	Pre Exposure Max	Pre Exposure Std	Post Exposure Min	Post Exposure Avg	Post Exposure Max	Post Exposure Std	Min Delta	Avg Delta	Max Delta	Std Delta
0	0.928	1.2044	1.533	0.25326	0.953	1.1962	1.51	0.22985	-0.049	-0.0082	0.025	0.028874
20	0.709	1.1989	1.746	0.31586	0.782	1.2222	1.785	0.30889	-0.687	0.0233	0.649	0.32074
30	0.964	1.4547	2.495	0.40657	1.085	1.4821	2.286	0.34833	-0.209	0.0274	0.155	0.12392

Device Test: 12.2 UJ4ZR4(RDSON_12V_OUT1_UJE410_UJ4ZR4)

TID vs Result Stats

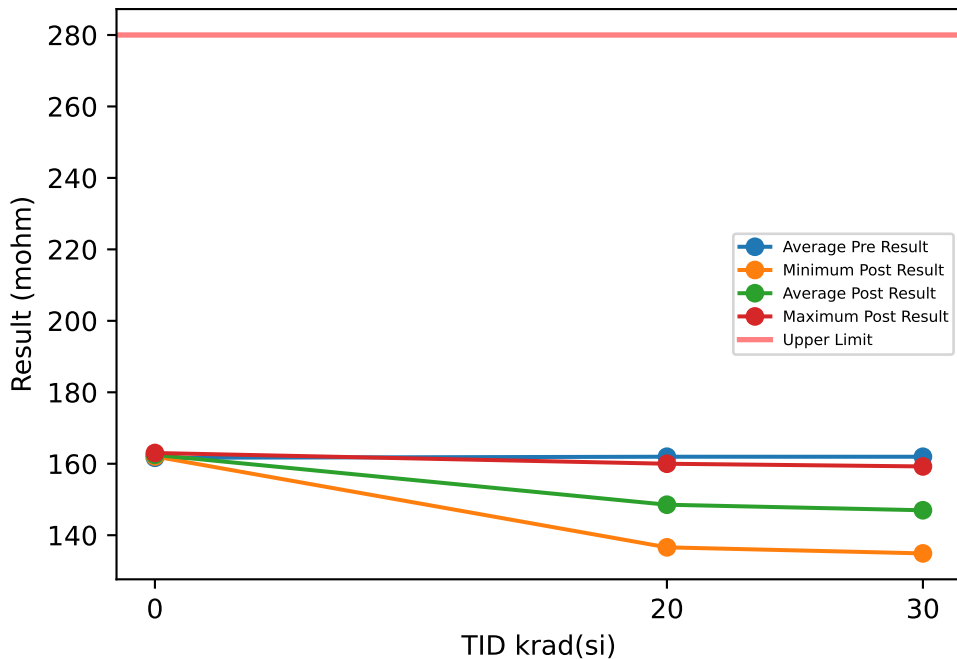

TID vs Post - Pre Exposure Delta

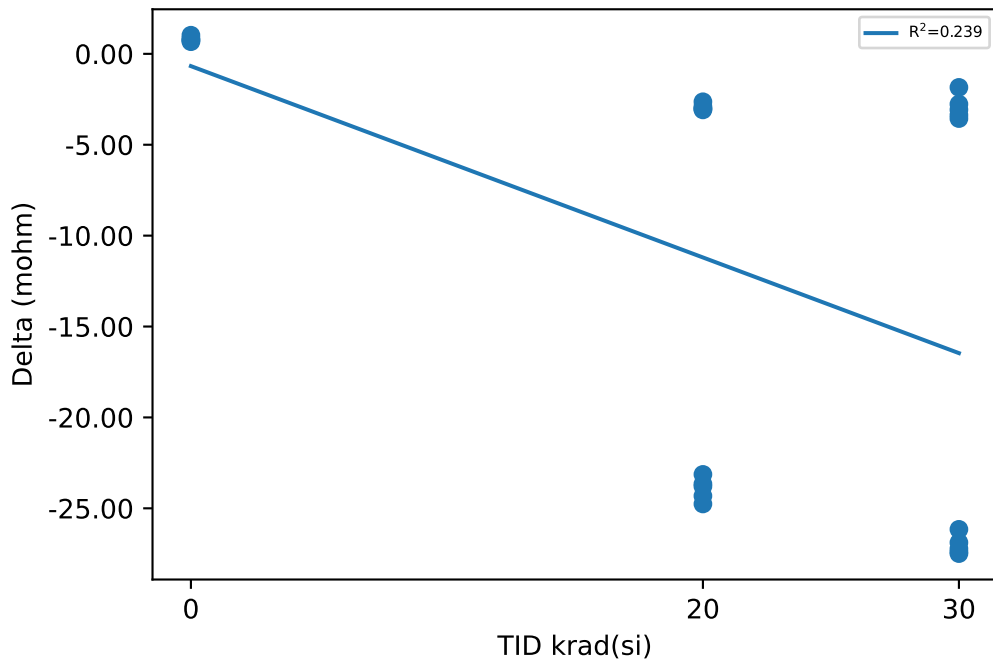

Test Results (Upper Limit = 280.0 (mohm))

Serial #	krad(si)	Exposure Conditions	Pre Result	Post Result	Delta
1	20	HDR unbiased	163.04	160	-3.0342
2	20	HDR unbiased	162.21	159.21	-2.9977
3	20	HDR unbiased	161.22	158.33	-2.8893
4	20	HDR unbiased	161.99	158.91	-3.0834
5	20	HDR unbiased	162.22	159.58	-2.6361
6	20	HDR biased	161.82	138.69	-23.134
7	20	HDR biased	161.38	137.59	-23.791
8	20	HDR biased	160.26	136.61	-23.659
9	20	HDR biased	162.16	137.84	-24.318
10	20	HDR biased	163.36	138.6	-24.76
11	30	HDR unbiased	159.97	157.2	-2.7662
12	30	HDR unbiased	161.92	158.55	-3.3665
13	30	HDR unbiased	162.81	159.25	-3.5602
14	30	HDR unbiased	160.81	158.97	-1.8447
15	30	HDR unbiased	161.1	158.03	-3.0729
16	30	HDR biased	162.68	135.19	-27.491
17	30	HDR biased	162.26	135.38	-26.884
18	30	HDR biased	164.78	137.38	-27.399
19	30	HDR biased	162.2	134.98	-27.222
20	30	HDR biased	161.07	134.91	-26.156
21	0	correlation	161.64	162.67	1.0259
22	0	correlation	161.18	162.03	0.8531
23	0	correlation	162.24	163.01	0.7726
24	0	correlation	161.63	162.37	0.7388
25	0	correlation	161.65	162.32	0.6678

Test Statistics (mohm)

krad(si)	Pre Exposure Min	Pre Exposure Avg	Pre Exposure Max	Pre Exposure Std	Post Exposure Min	Post Exposure Avg	Post Exposure Max	Post Exposure Std	Min Delta	Avg Delta	Max Delta	Std Delta
0	161.18	161.67	162.24	0.37634	162.03	162.48	163.01	0.37315	0.6678	0.81164	1.0259	0.13706
20	160.26	161.97	163.36	0.8861	136.61	148.54	160	11.27	-24.76	-13.43	-2.6361	11.079
30	159.97	161.96	164.78	1.3389	134.91	146.98	159.25	12.067	-27.491	-14.976	-1.8447	12.719

Device Test: 12.21 UJJ3KD(Delta_RDSON_5V_CH2CH4_UJJ3KD)

TID vs Result Stats

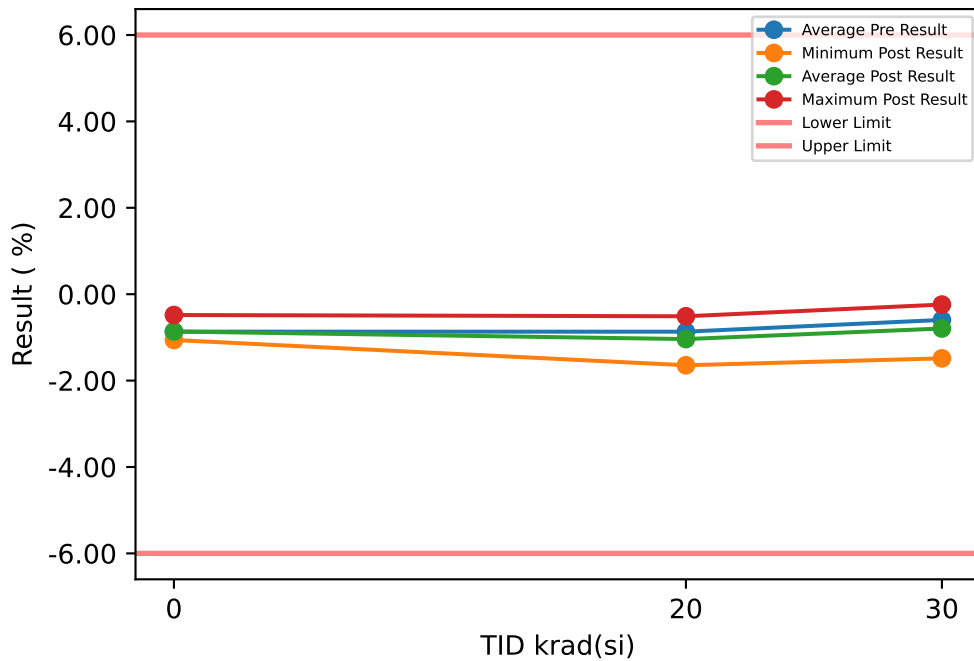

Test Results (Lower Limit = -6.0, Upper Limit = 6.0 (%))

Serial #	krad(si)	Exposure Conditions	Pre Result	Post Result	Delta
1	20	HDR unbiased	-0.88	-0.794	0.086
2	20	HDR unbiased	-1.062	-1.105	-0.043
3	20	HDR unbiased	-0.757	-0.74	0.017
4	20	HDR unbiased	-0.502	-0.511	-0.009
5	20	HDR unbiased	-1.024	-0.973	0.051
6	20	HDR biased	-1.236	-1.084	0.152
7	20	HDR biased	-0.293	-0.557	-0.264
8	20	HDR biased	-0.916	-1.367	-0.451
9	20	HDR biased	-1.392	-1.645	-0.253
10	20	HDR biased	-0.618	-1.612	-0.994
11	30	HDR unbiased	-0.708	-0.799	-0.091
12	30	HDR unbiased	-0.618	-0.528	0.09
13	30	HDR unbiased	-1.093	-1.141	-0.048
14	30	HDR unbiased	-0.816	-0.657	0.159
15	30	HDR unbiased	-0.428	-0.494	-0.066
16	30	HDR biased	-0.391	-0.809	-0.418
17	30	HDR biased	-0.558	-0.765	-0.207
18	30	HDR biased	0.43	-0.24	-0.67
19	30	HDR biased	-0.7	-1.024	-0.324
20	30	HDR biased	-1.071	-1.485	-0.414
21	0	correlation	-0.481	-0.482	-0.001
22	0	correlation	-0.822	-0.874	-0.052
23	0	correlation	-0.985	-0.967	0.018
24	0	correlation	-0.954	-0.935	0.019
25	0	correlation	-1.092	-1.06	0.032

TID vs Post - Pre Exposure Delta

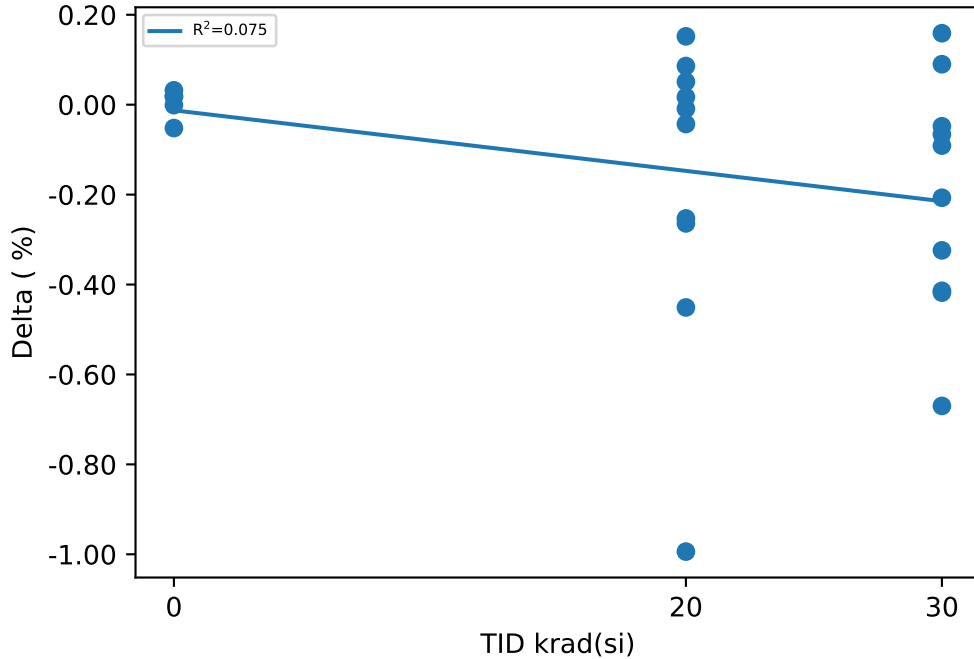

Test Statistics (%)

krad(si)	Pre Exposure Min	Pre Exposure Avg	Pre Exposure Max	Pre Exposure Std	Post Exposure Min	Post Exposure Avg	Post Exposure Max	Post Exposure Std	Min Delta	Avg Delta	Max Delta	Std Delta
0	-1.092	-0.8668	-0.481	0.23619	-1.06	-0.8636	-0.482	0.22366	-0.052	0.0032	0.032	0.033026
20	-1.392	-0.868	-0.293	0.33563	-1.645	-1.0388	-0.511	0.40475	-0.994	-0.1708	0.152	0.3446
30	-1.093	-0.5953	0.43	0.43066	-1.485	-0.7942	-0.24	0.35564	-0.67	-0.1989	0.159	0.25724

Device Test: 12.22 UJJ3KD(Delta_RDSON_5V_CH3CH4_UJJ3KD)

TID vs Result Stats

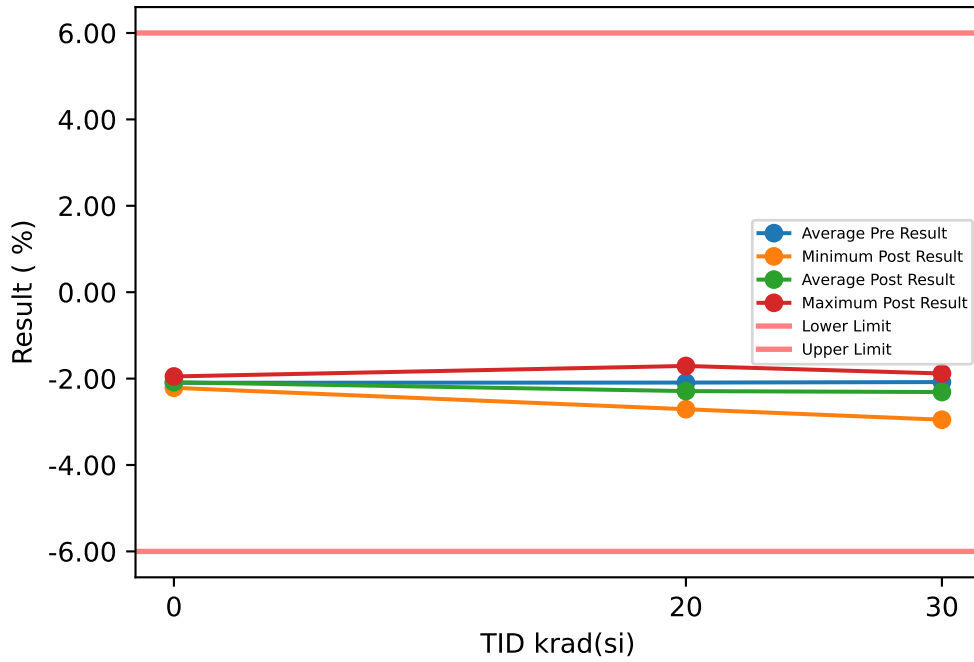

Test Results (Lower Limit = -6.0, Upper Limit = 6.0 (%))

Serial #	krad(si)	Exposure Conditions	Pre Result	Post Result	Delta
1	20	HDR unbiased	-1.958	-2.01	-0.052
2	20	HDR unbiased	-2.06	-2.128	-0.068
3	20	HDR unbiased	-2.207	-2.235	-0.028
4	20	HDR unbiased	-1.675	-1.707	-0.032
5	20	HDR unbiased	-2.332	-2.227	0.105
6	20	HDR biased	-2.082	-2.6	-0.518
7	20	HDR biased	-2.075	-2.385	-0.31
8	20	HDR biased	-2.297	-2.709	-0.412
9	20	HDR biased	-2.116	-2.479	-0.363
10	20	HDR biased	-2.118	-2.413	-0.295
11	30	HDR unbiased	-2.143	-2.211	-0.068
12	30	HDR unbiased	-2.167	-2.186	-0.019
13	30	HDR unbiased	-2.078	-2.25	-0.172
14	30	HDR unbiased	-2.085	-2.085	0
15	30	HDR unbiased	-1.822	-1.882	-0.06
16	30	HDR biased	-1.671	-1.96	-0.289
17	30	HDR biased	-2.236	-2.596	-0.36
18	30	HDR biased	-2.118	-2.585	-0.467
19	30	HDR biased	-2.077	-2.405	-0.328
20	30	HDR biased	-2.408	-2.952	-0.544
21	0	correlation	-2.046	-2.022	0.024
22	0	correlation	-2.211	-2.213	-0.002
23	0	correlation	-2.23	-2.206	0.024
24	0	correlation	-1.958	-1.95	0.008
25	0	correlation	-2.039	-2.032	0.007

TID vs Post - Pre Exposure Delta

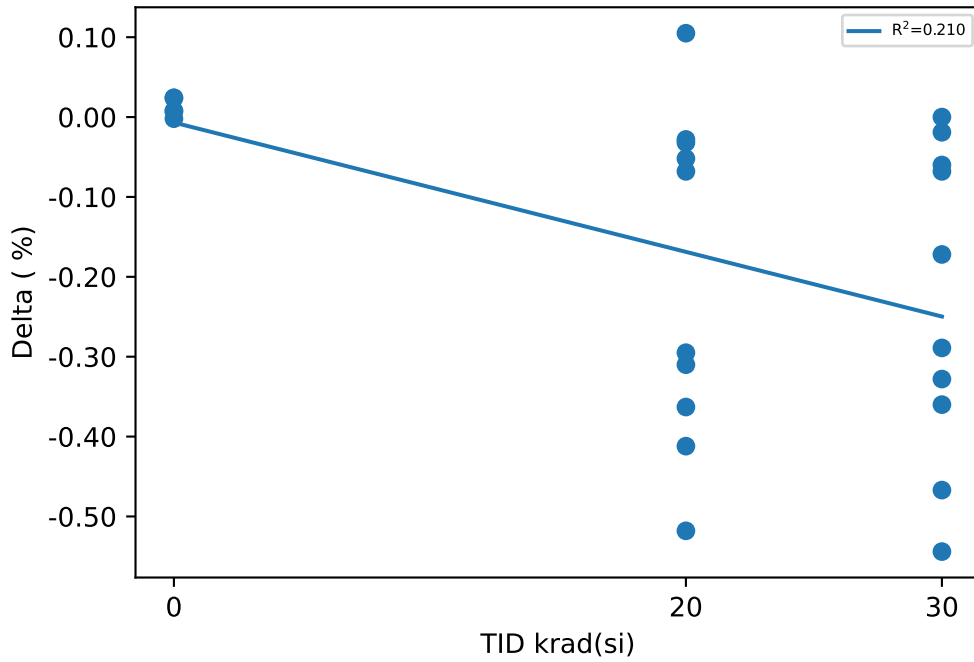

Test Statistics (%)

krad(si)	Pre Exposure Min	Pre Exposure Avg	Pre Exposure Max	Pre Exposure Std	Post Exposure Min	Post Exposure Avg	Post Exposure Max	Post Exposure Std	Min Delta	Avg Delta	Max Delta	Std Delta
0	-2.23	-2.0968	-1.958	0.11829	-2.213	-2.0846	-1.95	0.11835	-0.002	0.0122	0.024	0.011454
20	-2.332	-2.092	-1.675	0.1848	-2.709	-2.2893	-1.707	0.29497	-0.518	-0.1973	0.105	0.20652
30	-2.408	-2.0805	-1.671	0.20515	-2.952	-2.3112	-1.882	0.32722	-0.544	-0.2307	0	0.19456

Device Test: 12.23 UJJ3KD(Delta_RDSON_12V_CH1CH2_UJJ3KD)

TID vs Result Stats

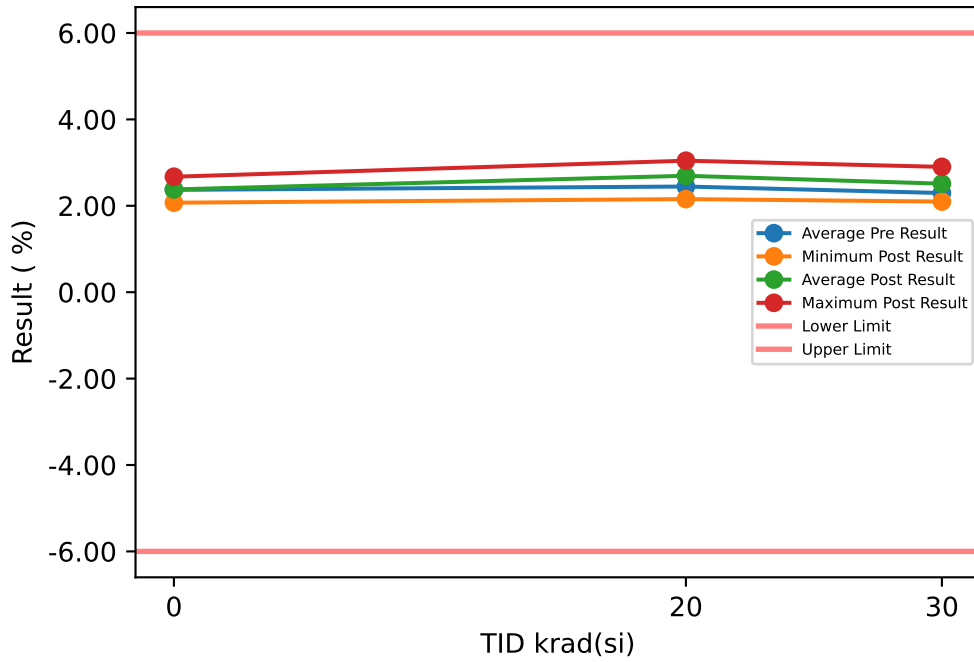

Test Results (Lower Limit = -6.0, Upper Limit = 6.0 (%))

Serial #	krad(si)	Exposure Conditions	Pre Result	Post Result	Delta
1	20	HDR unbiased	2.643	2.579	-0.064
2	20	HDR unbiased	2.834	2.901	0.067
3	20	HDR unbiased	2.472	2.479	0.007
4	20	HDR unbiased	2.447	2.407	-0.04
5	20	HDR unbiased	2.086	2.155	0.069
6	20	HDR biased	2.441	3.002	0.561
7	20	HDR biased	2.174	2.567	0.393
8	20	HDR biased	2.385	2.954	0.569
9	20	HDR biased	2.537	3.044	0.507
10	20	HDR biased	2.442	2.861	0.419
11	30	HDR unbiased	2.272	2.384	0.112
12	30	HDR unbiased	2.41	2.455	0.045
13	30	HDR unbiased	2.584	2.675	0.091
14	30	HDR unbiased	2.26	2.231	-0.029
15	30	HDR unbiased	2	2.098	0.098
16	30	HDR biased	2.188	2.478	0.29
17	30	HDR biased	2.197	2.559	0.362
18	30	HDR biased	2.468	2.901	0.433
19	30	HDR biased	2.152	2.599	0.447
20	30	HDR biased	2.428	2.737	0.309
21	0	correlation	2.065	2.072	0.007
22	0	correlation	2.312	2.353	0.041
23	0	correlation	2.415	2.417	0.002
24	0	correlation	2.384	2.379	-0.005
25	0	correlation	2.669	2.673	0.004

TID vs Post - Pre Exposure Delta

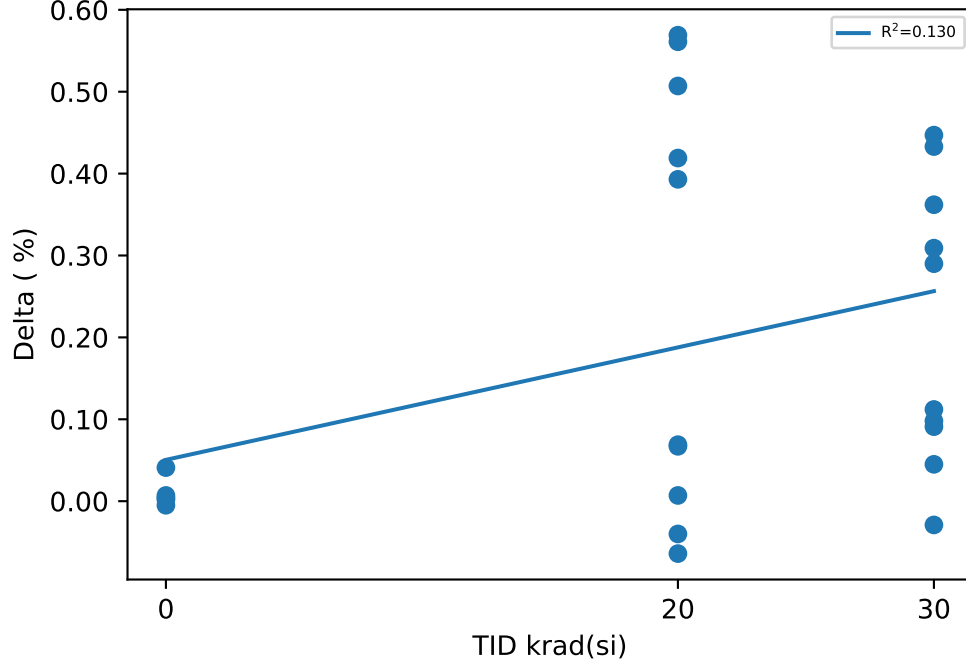

Test Statistics (%)

krad(si)	Pre Exposure Min	Pre Exposure Avg	Pre Exposure Max	Pre Exposure Std	Post Exposure Min	Post Exposure Avg	Post Exposure Max	Post Exposure Std	Min Delta	Avg Delta	Max Delta	Std Delta
0	2.065	2.369	2.669	0.2168	2.072	2.3788	2.673	0.21378	-0.005	0.0098	0.041	0.017992
20	2.086	2.4461	2.834	0.2123	2.155	2.6949	3.044	0.29892	-0.064	0.2488	0.569	0.26279
30	2	2.2959	2.584	0.17469	2.098	2.5117	2.901	0.23792	-0.029	0.2158	0.447	0.17176

Device Test: 12.24 UJJ3KD(Delta_RDSON_12V_CH1CH3_UJJ3KD)

TID vs Result Stats

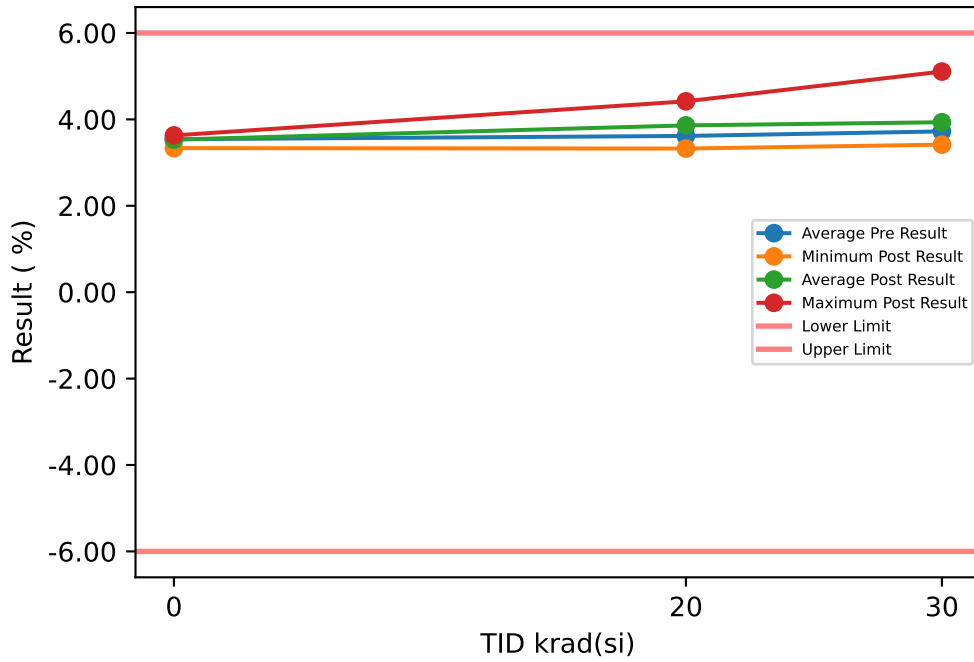

Test Results (Lower Limit = -6.0, Upper Limit = 6.0 (%))

Serial #	krad(si)	Exposure Conditions	Pre Result	Post Result	Delta
1	20	HDR unbiased	3.681	3.703	0.022
2	20	HDR unbiased	3.771	3.85	0.079
3	20	HDR unbiased	3.841	3.897	0.056
4	20	HDR unbiased	3.596	3.526	-0.07
5	20	HDR unbiased	3.34	3.325	-0.015
6	20	HDR biased	3.243	4.418	1.175
7	20	HDR biased	3.882	4.277	0.395
8	20	HDR biased	3.706	4.198	0.492
9	20	HDR biased	3.223	3.822	0.599
10	20	HDR biased	3.887	3.593	-0.294
11	30	HDR unbiased	3.652	3.704	0.052
12	30	HDR unbiased	3.894	4.025	0.131
13	30	HDR unbiased	3.538	3.692	0.154
14	30	HDR unbiased	3.459	3.574	0.115
15	30	HDR unbiased	3.338	3.416	0.078
16	30	HDR biased	3.429	3.545	0.116
17	30	HDR biased	3.79	4.293	0.503
18	30	HDR biased	4.916	5.107	0.191
19	30	HDR biased	3.491	3.897	0.406
20	30	HDR biased	3.714	4.09	0.376
21	0	correlation	3.553	3.546	-0.007
22	0	correlation	3.612	3.629	0.017
23	0	correlation	3.594	3.576	-0.018
24	0	correlation	3.348	3.335	-0.013
25	0	correlation	3.597	3.574	-0.023

TID vs Post - Pre Exposure Delta

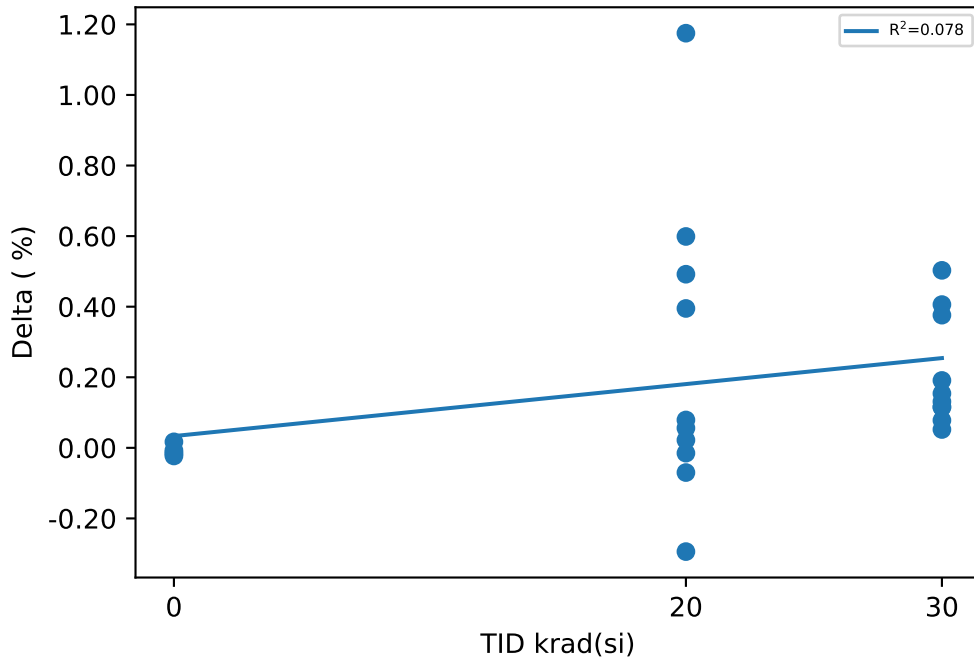

Test Statistics (%)

krad(si)	Pre Exposure Min	Pre Exposure Avg	Pre Exposure Max	Pre Exposure Std	Post Exposure Min	Post Exposure Avg	Post Exposure Max	Post Exposure Std	Min Delta	Avg Delta	Max Delta	Std Delta
0	3.348	3.5408	3.612	0.10998	3.335	3.532	3.629	0.11414	-0.023	-0.0088	0.017	0.015595
20	3.223	3.617	3.887	0.25848	3.325	3.8609	4.418	0.34899	-0.294	0.2439	1.175	0.4274
30	3.338	3.7221	4.916	0.45393	3.416	3.9343	5.107	0.49436	0.052	0.2122	0.503	0.15697

Device Test: 12.25 UJJ3KD(Delta_RDSON_12V_CH1CH4_UJJ3KD)

TID vs Result Stats

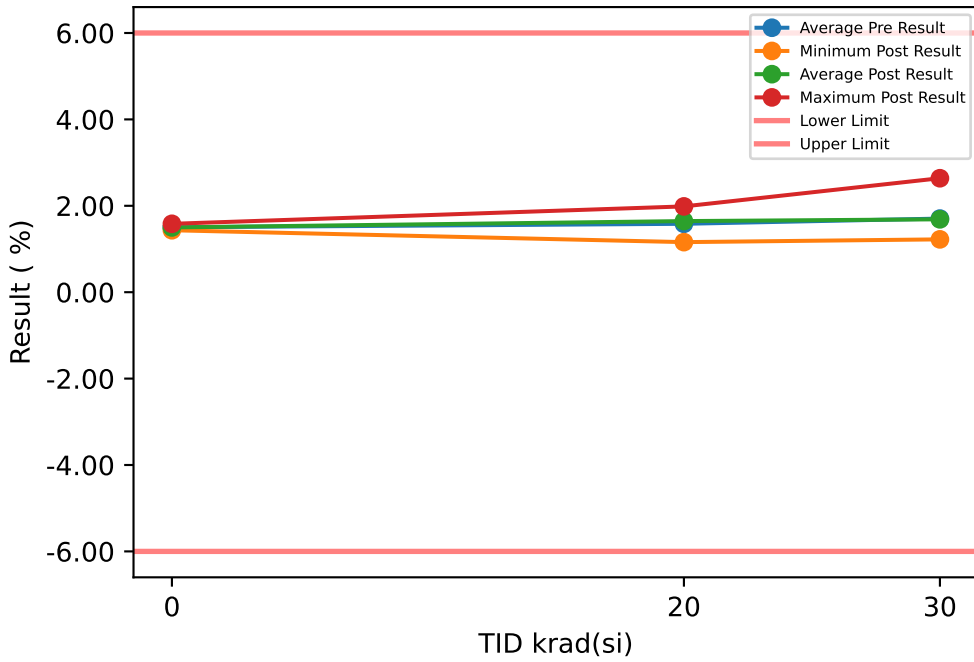

Test Results (Lower Limit = -6.0, Upper Limit = 6.0 (%))

Serial #	krad(si)	Exposure Conditions	Pre Result	Post Result	Delta
1	20	HDR unbiased	1.787	1.764	-0.023
2	20	HDR unbiased	1.779	1.786	0.007
3	20	HDR unbiased	1.692	1.742	0.05
4	20	HDR unbiased	1.941	1.85	-0.091
5	20	HDR unbiased	1.058	1.159	0.101
6	20	HDR biased	1.213	1.919	0.706
7	20	HDR biased	1.87	1.986	0.116
8	20	HDR biased	1.485	1.581	0.096
9	20	HDR biased	1.161	1.416	0.255
10	20	HDR biased	1.845	1.259	-0.586
11	30	HDR unbiased	1.582	1.548	-0.034
12	30	HDR unbiased	1.798	1.903	0.105
13	30	HDR unbiased	1.506	1.491	-0.015
14	30	HDR unbiased	1.451	1.525	0.074
15	30	HDR unbiased	1.561	1.585	0.024
16	30	HDR biased	1.801	1.644	-0.157
17	30	HDR biased	1.622	1.755	0.133
18	30	HDR biased	2.888	2.638	-0.25
19	30	HDR biased	1.465	1.557	0.092
20	30	HDR biased	1.366	1.223	-0.143
21	0	correlation	1.564	1.567	0.003
22	0	correlation	1.474	1.465	-0.009
23	0	correlation	1.449	1.448	-0.001
24	0	correlation	1.412	1.434	0.022
25	0	correlation	1.613	1.583	-0.03

TID vs Post - Pre Exposure Delta

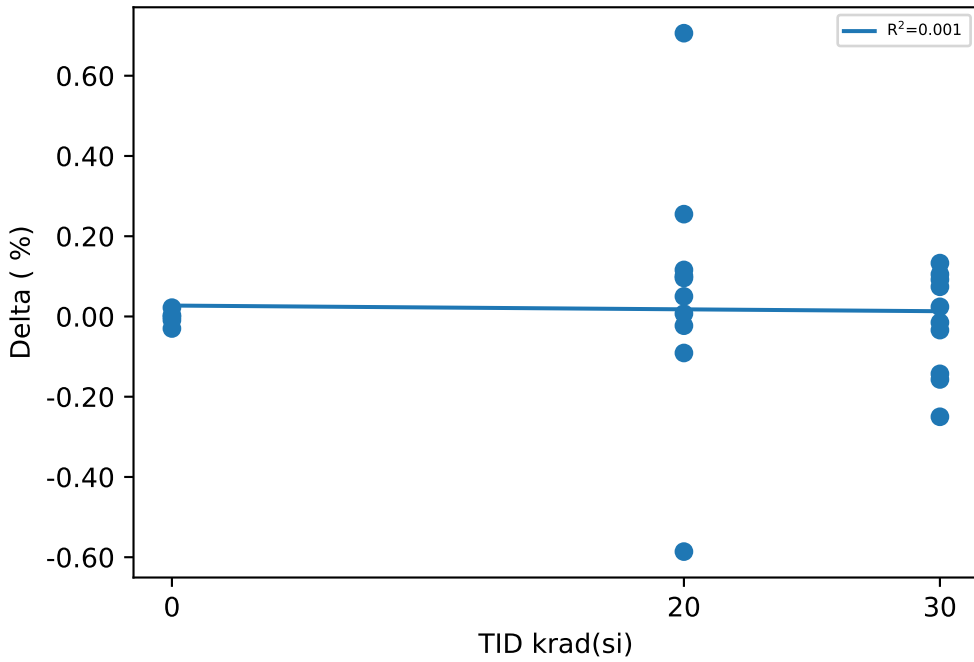

Test Statistics (%)

krad(si)	Pre Exposure Min	Pre Exposure Avg	Pre Exposure Max	Pre Exposure Std	Post Exposure Min	Post Exposure Avg	Post Exposure Max	Post Exposure Std	Min Delta	Avg Delta	Max Delta	Std Delta
0	1.412	1.5024	1.613	0.083452	1.434	1.4994	1.583	0.070109	-0.03	-0.003	0.022	0.018908
20	1.058	1.5831	1.941	0.32852	1.159	1.6462	1.986	0.28256	-0.586	0.0631	0.706	0.3182
30	1.366	1.704	2.888	0.43928	1.223	1.6869	2.638	0.37773	-0.25	-0.0171	0.133	0.12879

Device Test: 12.26 UJJ3KD(Delta_RDSON_12V_CH2CH3_UJJ3KD)

TID vs Result Stats

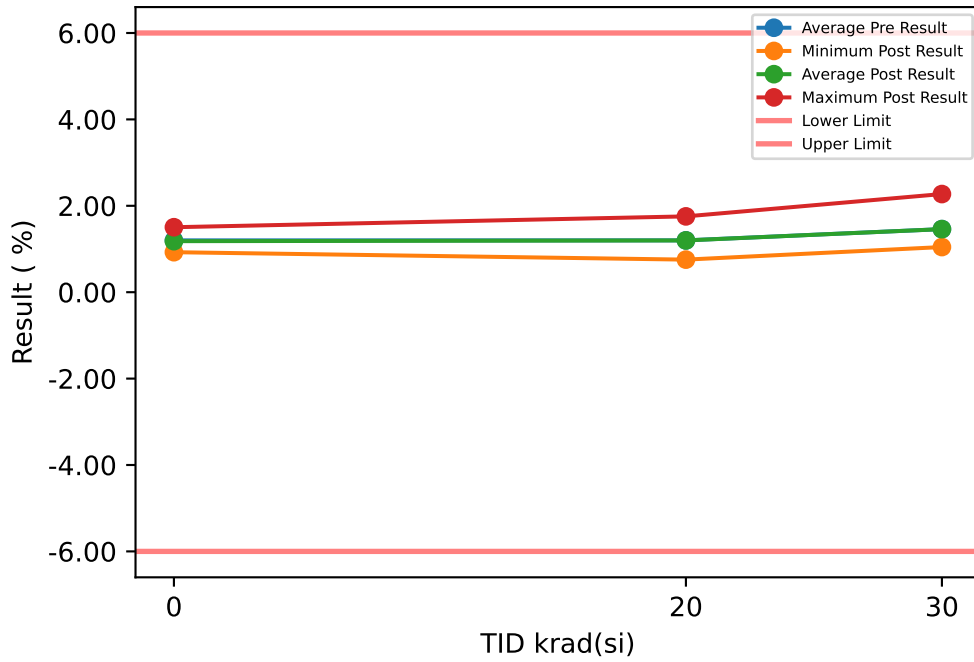

Test Results (Lower Limit = -6.0, Upper Limit = 6.0 (%))

Serial #	krad(si)	Exposure Conditions	Pre Result	Post Result	Delta
1	20	HDR unbiased	1.066	1.154	0.088
2	20	HDR unbiased	0.964	0.978	0.014
3	20	HDR unbiased	1.404	1.455	0.051
4	20	HDR unbiased	1.178	1.146	-0.032
5	20	HDR unbiased	1.281	1.196	-0.085
6	20	HDR biased	0.823	1.46	0.637
7	20	HDR biased	1.746	1.755	0.009
8	20	HDR biased	1.353	1.282	-0.071
9	20	HDR biased	0.704	0.803	0.099
10	20	HDR biased	1.481	0.754	-0.727
11	30	HDR unbiased	1.413	1.352	-0.061
12	30	HDR unbiased	1.52	1.61	0.09
13	30	HDR unbiased	0.98	1.045	0.065
14	30	HDR unbiased	1.227	1.374	0.147
15	30	HDR unbiased	1.366	1.346	-0.02
16	30	HDR biased	1.269	1.094	-0.175
17	30	HDR biased	1.629	1.78	0.151
18	30	HDR biased	2.509	2.272	-0.237
19	30	HDR biased	1.369	1.333	-0.036
20	30	HDR biased	1.318	1.391	0.073
21	0	correlation	1.519	1.504	-0.015
22	0	correlation	1.331	1.307	-0.024
23	0	correlation	1.208	1.188	-0.02
24	0	correlation	0.987	0.98	-0.007
25	0	correlation	0.954	0.926	-0.028

TID vs Post - Pre Exposure Delta

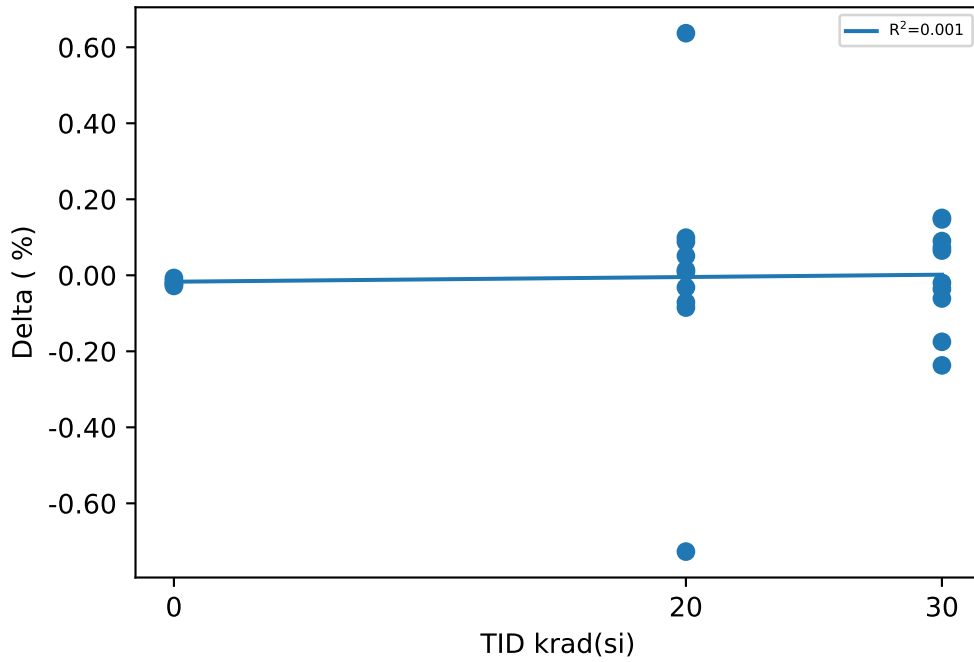

Test Statistics (%)

krad(si)	Pre Exposure Min	Pre Exposure Avg	Pre Exposure Max	Pre Exposure Std	Post Exposure Min	Post Exposure Avg	Post Exposure Max	Post Exposure Std	Min Delta	Avg Delta	Max Delta	Std Delta
0	0.954	1.1998	1.519	0.2371	0.926	1.181	1.504	0.23753	-0.028	-0.0188	-0.007	0.008167
20	0.704	1.2	1.746	0.31814	0.754	1.1983	1.755	0.3088	-0.727	-0.0017	0.637	0.32795
30	0.98	1.46	2.509	0.40732	1.045	1.4597	2.272	0.35643	-0.237	-0.0003	0.151	0.13093

Device Test: 12.27 UJJ3KD(Delta_RDSON_12V_CH2CH4_UJJ3KD)

TID vs Result Stats

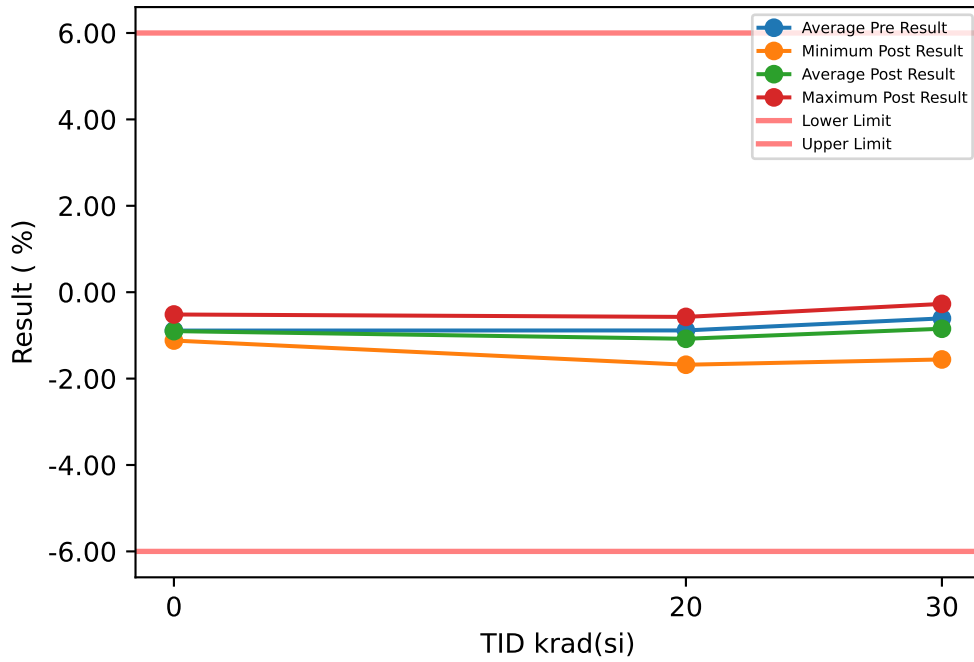

TID vs Post - Pre Exposure Delta

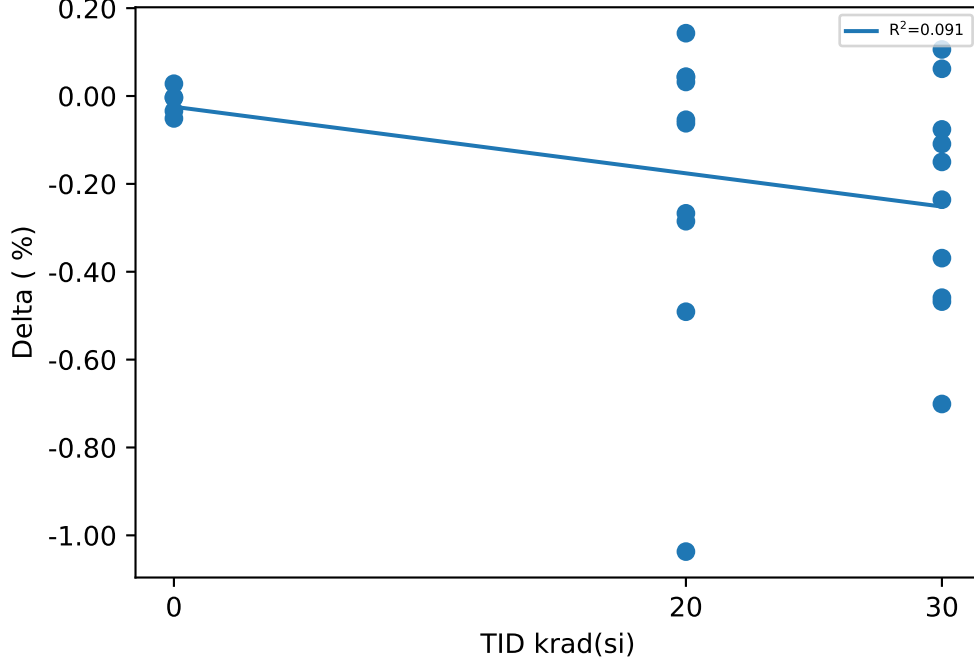

Test Results (Lower Limit = -6.0, Upper Limit = 6.0 (%))

Serial #	krad(si)	Exposure Conditions	Pre Result	Post Result	Delta
1	20	HDR unbiased	-0.88	-0.837	0.043
2	20	HDR unbiased	-1.086	-1.148	-0.062
3	20	HDR unbiased	-0.8	-0.756	0.044
4	20	HDR unbiased	-0.518	-0.572	-0.054
5	20	HDR unbiased	-1.05	-1.018	0.032
6	20	HDR biased	-1.259	-1.116	0.143
7	20	HDR biased	-0.311	-0.596	-0.285
8	20	HDR biased	-0.923	-1.414	-0.491
9	20	HDR biased	-1.412	-1.679	-0.267
10	20	HDR biased	-0.612	-1.649	-1.037
11	30	HDR unbiased	-0.706	-0.856	-0.15
12	30	HDR unbiased	-0.627	-0.565	0.062
13	30	HDR unbiased	-1.107	-1.216	-0.109
14	30	HDR unbiased	-0.828	-0.722	0.106
15	30	HDR unbiased	-0.448	-0.524	-0.076
16	30	HDR biased	-0.396	-0.855	-0.459
17	30	HDR biased	-0.588	-0.824	-0.236
18	30	HDR biased	0.43	-0.271	-0.701
19	30	HDR biased	-0.701	-1.07	-0.369
20	30	HDR biased	-1.089	-1.557	-0.468
21	0	correlation	-0.512	-0.516	-0.004
22	0	correlation	-0.858	-0.909	-0.051
23	0	correlation	-0.99	-0.993	-0.003
24	0	correlation	-0.996	-0.968	0.028
25	0	correlation	-1.085	-1.119	-0.034

Test Statistics (%)

krad(si)	Pre Exposure Min	Pre Exposure Avg	Pre Exposure Max	Pre Exposure Std	Post Exposure Min	Post Exposure Avg	Post Exposure Max	Post Exposure Std	Min Delta	Avg Delta	Max Delta	Std Delta
0	-1.085	-0.8882	-0.512	0.22536	-1.119	-0.901	-0.516	0.22845	-0.051	-0.0128	0.028	0.030606
20	-1.412	-0.8851	-0.311	0.33873	-1.679	-1.0785	-0.572	0.4028	-1.037	-0.1934	0.143	0.35386
30	-1.107	-0.606	0.43	0.43407	-1.557	-0.846	-0.271	0.36847	-0.701	-0.24	0.106	0.25652

Device Test: 12.28 UJJ3KD(Delta_RDSON_12V_CH3CH4_UJJ3KD)

TID vs Result Stats

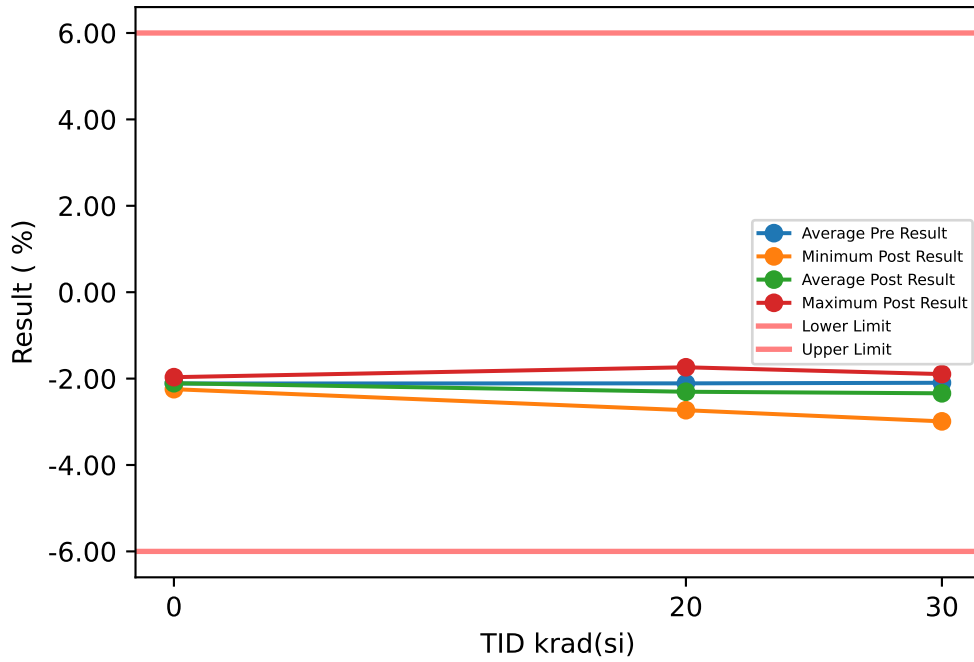

TID vs Post - Pre Exposure Delta

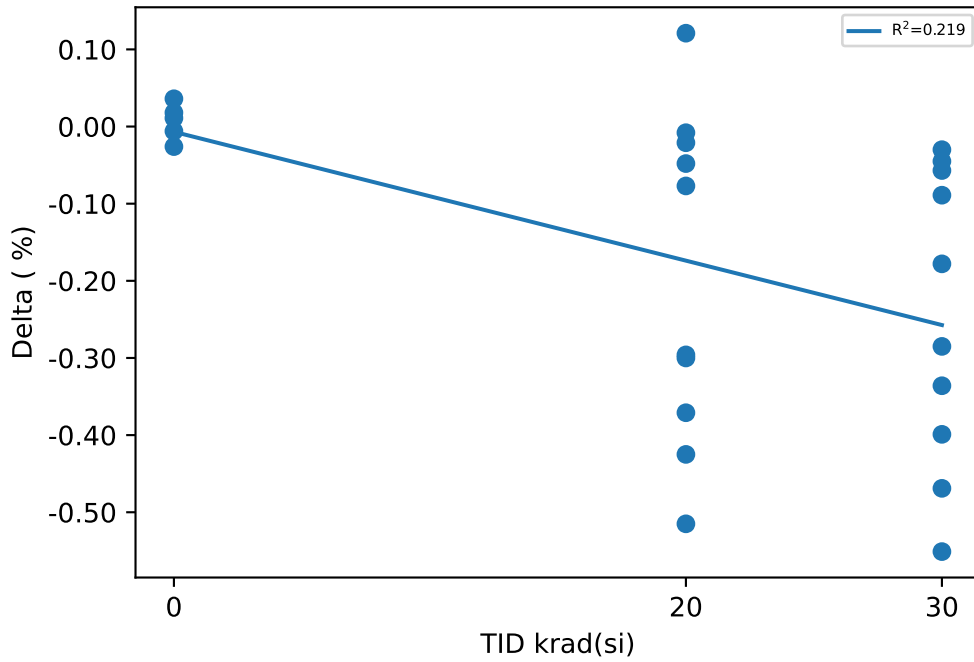

Test Results (Lower Limit = -6.0, Upper Limit = 6.0 (%))

Serial #	krad(si)	Exposure Conditions	Pre Result	Post Result	Delta
1	20	HDR unbiased	-1.966	-2.014	-0.048
2	20	HDR unbiased	-2.07	-2.147	-0.077
3	20	HDR unbiased	-2.235	-2.243	-0.008
4	20	HDR unbiased	-1.717	-1.738	-0.021
5	20	HDR unbiased	-2.361	-2.24	0.121
6	20	HDR biased	-2.099	-2.614	-0.515
7	20	HDR biased	-2.093	-2.393	-0.3
8	20	HDR biased	-2.307	-2.732	-0.425
9	20	HDR biased	-2.131	-2.502	-0.371
10	20	HDR biased	-2.125	-2.421	-0.296
11	30	HDR unbiased	-2.149	-2.238	-0.089
12	30	HDR unbiased	-2.181	-2.211	-0.03
13	30	HDR unbiased	-2.107	-2.285	-0.178
14	30	HDR unbiased	-2.08	-2.125	-0.045
15	30	HDR unbiased	-1.839	-1.896	-0.057
16	30	HDR biased	-1.686	-1.971	-0.285
17	30	HDR biased	-2.253	-2.652	-0.399
18	30	HDR biased	-2.133	-2.602	-0.469
19	30	HDR biased	-2.099	-2.435	-0.336
20	30	HDR biased	-2.439	-2.99	-0.551
21	0	correlation	-2.062	-2.051	0.011
22	0	correlation	-2.219	-2.245	-0.026
23	0	correlation	-2.225	-2.207	0.018
24	0	correlation	-2.003	-1.967	0.036
25	0	correlation	-2.059	-2.065	-0.006

Test Statistics (%)

krad(si)	Pre Exposure Min	Pre Exposure Avg	Pre Exposure Max	Pre Exposure Std	Post Exposure Min	Post Exposure Avg	Post Exposure Max	Post Exposure Std	Min Delta	Avg Delta	Max Delta	Std Delta
0	-2.225	-2.1136	-2.003	0.10173	-2.245	-2.107	-1.967	0.1157	-0.026	0.0066	0.036	0.023639
20	-2.361	-2.1104	-1.717	0.18114	-2.732	-2.3044	-1.738	0.29383	-0.515	-0.194	0.121	0.21295
30	-2.439	-2.0966	-1.686	0.20769	-2.99	-2.3405	-1.896	0.33451	-0.551	-0.2439	-0.03	0.19084

Device Test: 12.29 UJJ3KD(Delta_RDSON_28V_CH1CH2_UJJ3KD)

TID vs Result Stats

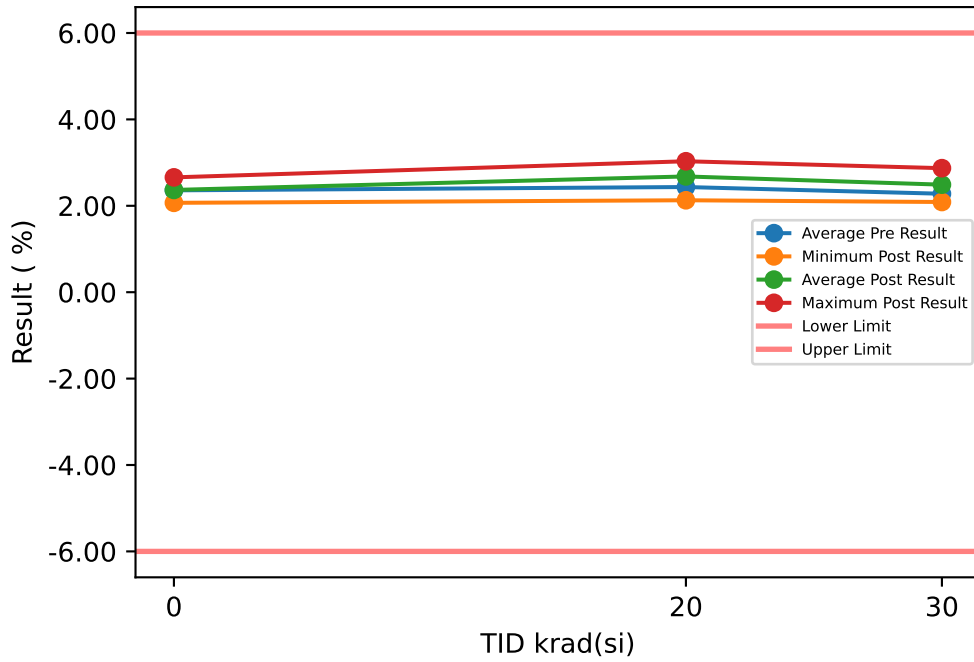

Test Results (Lower Limit = -6.0, Upper Limit = 6.0 (%))

Serial #	krad(si)	Exposure Conditions	Pre Result	Post Result	Delta
1	20	HDR unbiased	2.644	2.563	-0.081
2	20	HDR unbiased	2.818	2.886	0.068
3	20	HDR unbiased	2.448	2.471	0.023
4	20	HDR unbiased	2.44	2.397	-0.043
5	20	HDR unbiased	2.076	2.128	0.052
6	20	HDR biased	2.428	2.982	0.554
7	20	HDR biased	2.159	2.55	0.391
8	20	HDR biased	2.388	2.932	0.544
9	20	HDR biased	2.518	3.031	0.513
10	20	HDR biased	2.425	2.855	0.43
11	30	HDR unbiased	2.231	2.364	0.133
12	30	HDR unbiased	2.394	2.436	0.042
13	30	HDR unbiased	2.573	2.663	0.09
14	30	HDR unbiased	2.231	2.196	-0.035
15	30	HDR unbiased	1.984	2.088	0.104
16	30	HDR biased	2.164	2.461	0.297
17	30	HDR biased	2.181	2.534	0.353
18	30	HDR biased	2.474	2.871	0.397
19	30	HDR biased	2.145	2.578	0.433
20	30	HDR biased	2.412	2.703	0.291
21	0	correlation	2.069	2.069	0
22	0	correlation	2.284	2.338	0.054
23	0	correlation	2.408	2.419	0.011
24	0	correlation	2.37	2.352	-0.018
25	0	correlation	2.657	2.658	0.001

TID vs Post - Pre Exposure Delta

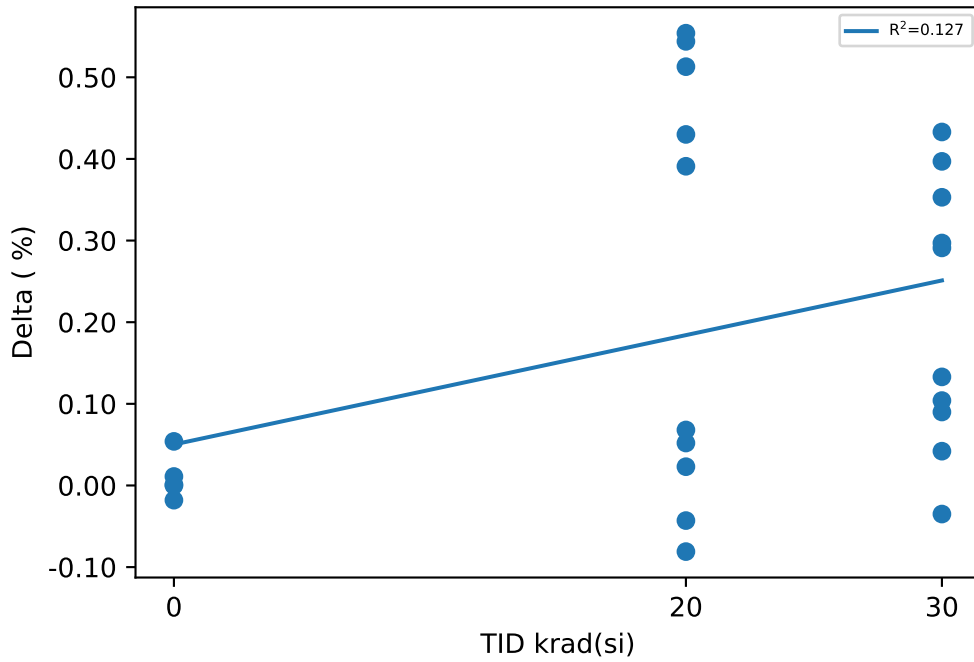

Test Statistics (%)

krad(si)	Pre Exposure Min	Pre Exposure Avg	Pre Exposure Max	Pre Exposure Std	Post Exposure Min	Post Exposure Avg	Post Exposure Max	Post Exposure Std	Min Delta	Avg Delta	Max Delta	Std Delta
0	2.069	2.3576	2.657	0.21274	2.069	2.3672	2.658	0.21051	-0.018	0.0096	0.054	0.026931
20	2.076	2.4344	2.818	0.2121	2.128	2.6795	3.031	0.30001	-0.081	0.2451	0.554	0.26232
30	1.984	2.2789	2.573	0.17882	2.088	2.4894	2.871	0.23519	-0.035	0.2105	0.433	0.16299

Device Test: 12.30 UJJ3KD(Delta_RDSON_28V_CH1CH3_UJJ3KD)

TID vs Result Stats

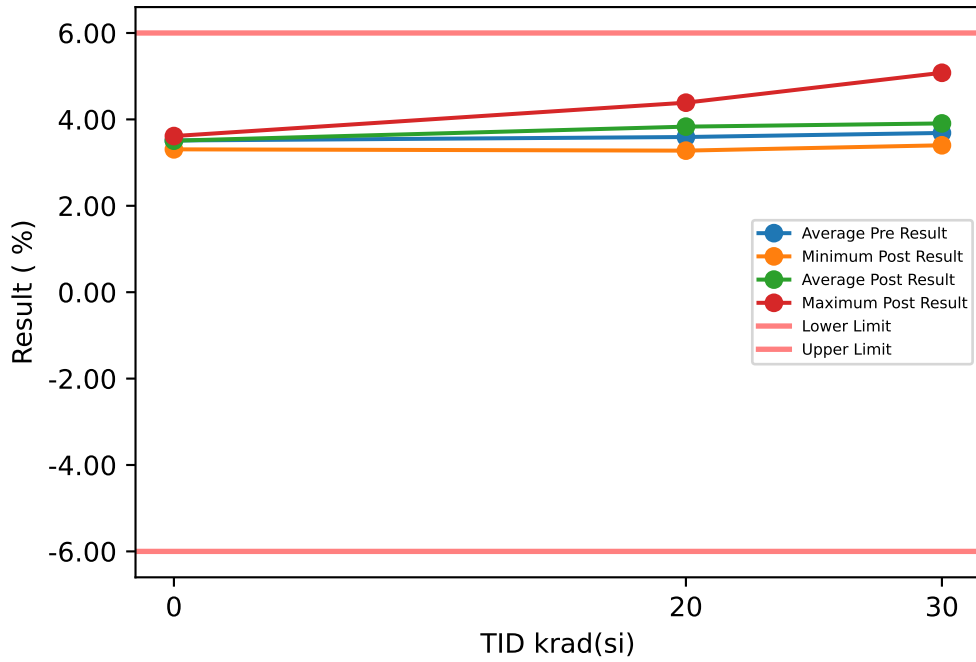

Test Results (Lower Limit = -6.0, Upper Limit = 6.0 (%))

Serial #	krad(si)	Exposure Conditions	Pre Result	Post Result	Delta
1	20	HDR unbiased	3.66	3.688	0.028
2	20	HDR unbiased	3.747	3.829	0.082
3	20	HDR unbiased	3.81	3.877	0.067
4	20	HDR unbiased	3.575	3.487	-0.088
5	20	HDR unbiased	3.321	3.277	-0.044
6	20	HDR biased	3.217	4.387	1.17
7	20	HDR biased	3.858	4.25	0.392
8	20	HDR biased	3.698	4.156	0.458
9	20	HDR biased	3.195	3.799	0.604
10	20	HDR biased	3.841	3.573	-0.268
11	30	HDR unbiased	3.607	3.666	0.059
12	30	HDR unbiased	3.859	3.984	0.125
13	30	HDR unbiased	3.501	3.677	0.176
14	30	HDR unbiased	3.425	3.545	0.12
15	30	HDR unbiased	3.303	3.401	0.098
16	30	HDR biased	3.378	3.505	0.127
17	30	HDR biased	3.757	4.276	0.519
18	30	HDR biased	4.892	5.079	0.187
19	30	HDR biased	3.458	3.874	0.416
20	30	HDR biased	3.684	4.062	0.378
21	0	correlation	3.526	3.52	-0.006
22	0	correlation	3.588	3.614	0.026
23	0	correlation	3.577	3.553	-0.024
24	0	correlation	3.314	3.307	-0.007
25	0	correlation	3.552	3.541	-0.011

TID vs Post - Pre Exposure Delta

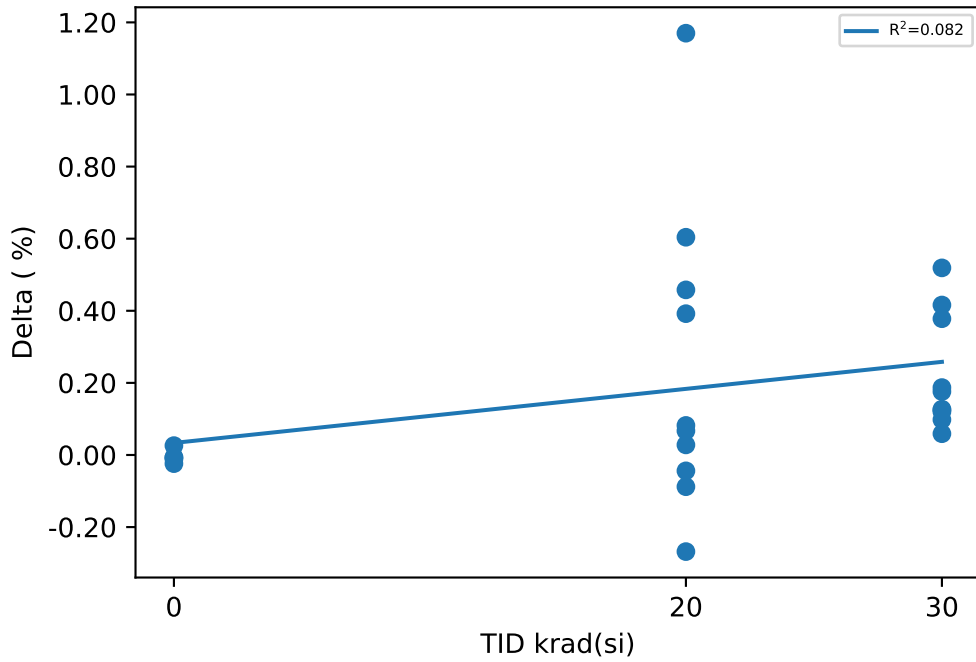

Test Statistics (%)

krad(si)	Pre Exposure Min	Pre Exposure Avg	Pre Exposure Max	Pre Exposure Std	Post Exposure Min	Post Exposure Avg	Post Exposure Max	Post Exposure Std	Min Delta	Avg Delta	Max Delta	Std Delta
0	3.314	3.5114	3.588	0.11292	3.307	3.507	3.614	0.11714	-0.024	-0.0044	0.026	0.018447
20	3.195	3.5922	3.858	0.2565	3.277	3.8323	4.387	0.35051	-0.268	0.2401	1.17	0.4235
30	3.303	3.6864	4.892	0.45844	3.401	3.9069	5.079	0.49446	0.059	0.2205	0.519	0.15786

Device Test: 12.3 UJ4ZR4(RDSON_28V_OUT1_UJE410_UJ4ZR4)

TID vs Result Stats

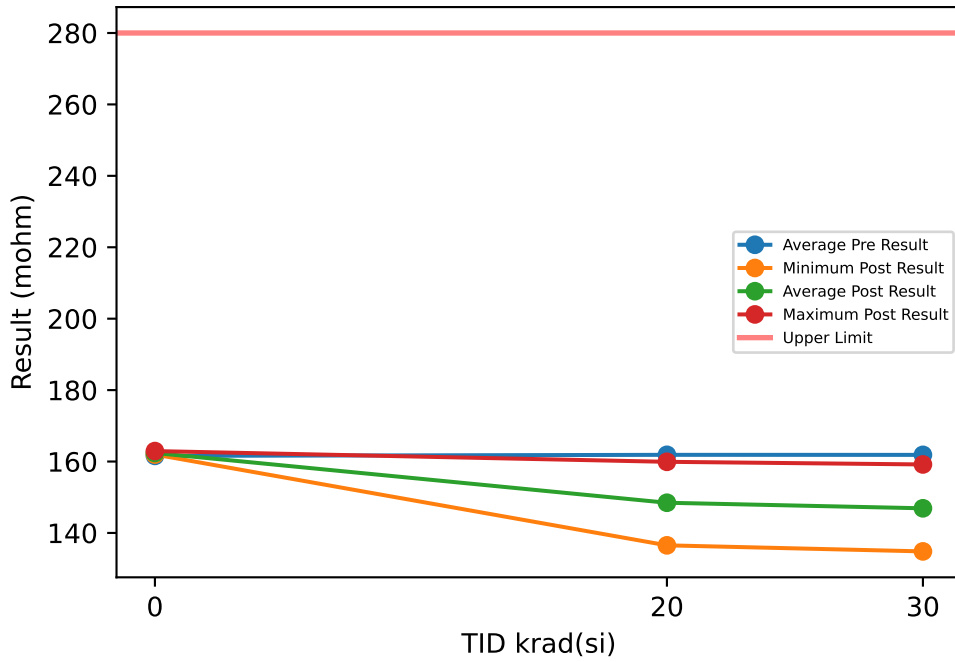

Test Results (Upper Limit = 280.0 (mohm))

Serial #	krad(si)	Exposure Conditions	Pre Result	Post Result	Delta
1	20	HDR unbiased	162.95	159.92	-3.0309
2	20	HDR unbiased	162.12	159.12	-3.0008
3	20	HDR unbiased	161.1	158.25	-2.8533
4	20	HDR unbiased	161.91	158.81	-3.1012
5	20	HDR unbiased	162.14	159.47	-2.6756
6	20	HDR biased	161.73	138.63	-23.1
7	20	HDR biased	161.29	137.53	-23.761
8	20	HDR biased	160.19	136.53	-23.657
9	20	HDR biased	162.06	137.77	-24.289
10	20	HDR biased	163.25	138.54	-24.71
11	30	HDR unbiased	159.85	157.1	-2.7454
12	30	HDR unbiased	161.83	158.45	-3.3806
13	30	HDR unbiased	162.72	159.18	-3.5366
14	30	HDR unbiased	160.71	158.88	-1.8284
15	30	HDR unbiased	161.01	157.95	-3.0526
16	30	HDR biased	162.57	135.11	-27.46
17	30	HDR biased	162.17	135.31	-26.86
18	30	HDR biased	164.69	137.3	-27.388
19	30	HDR biased	162.11	134.9	-27.212
20	30	HDR biased	160.97	134.83	-26.139
21	0	correlation	161.56	162.59	1.0353
22	0	correlation	161.09	161.96	0.8708
23	0	correlation	162.16	162.93	0.7643
24	0	correlation	161.54	162.28	0.7416
25	0	correlation	161.55	162.22	0.6684

TID vs Post - Pre Exposure Delta

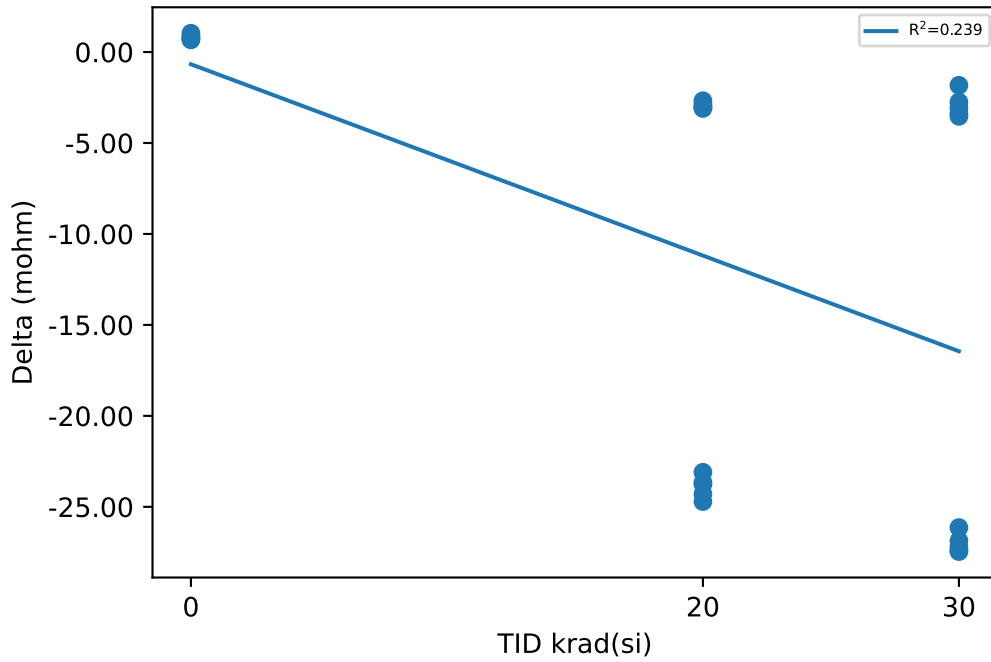

Test Statistics (mohm)

krad(si)	Pre Exposure Min	Pre Exposure Avg	Pre Exposure Max	Pre Exposure Std	Post Exposure Min	Post Exposure Avg	Post Exposure Max	Post Exposure Std	Min Delta	Avg Delta	Max Delta	Std Delta
0	161.09	161.58	162.16	0.38331	161.96	162.39	162.93	0.37448	0.6684	0.81608	1.0353	0.14238
20	160.19	161.88	163.25	0.8837	136.53	148.46	159.92	11.256	-24.71	-13.418	-2.6756	11.061
30	159.85	161.86	164.69	1.3462	134.83	146.9	159.18	12.061	-27.46	-14.96	-1.8284	12.717

Device Test: 12.31 UJJ3KD(Delta_RDSON_28V_CH1CH4_UJJ3KD)

TID vs Result Stats

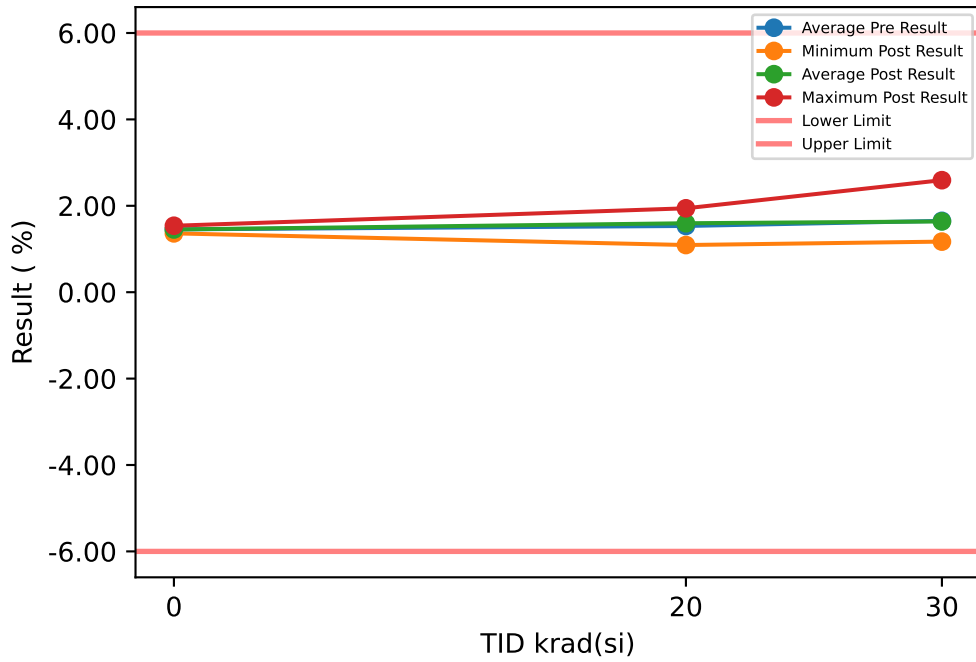

Test Results (Lower Limit = -6.0, Upper Limit = 6.0 (%))

Serial #	krad(si)	Exposure Conditions	Pre Result	Post Result	Delta
1	20	HDR unbiased	1.726	1.715	-0.011
2	20	HDR unbiased	1.729	1.741	0.012
3	20	HDR unbiased	1.642	1.696	0.054
4	20	HDR unbiased	1.913	1.795	-0.118
5	20	HDR unbiased	1.014	1.092	0.078
6	20	HDR biased	1.156	1.862	0.706
7	20	HDR biased	1.822	1.942	0.12
8	20	HDR biased	1.446	1.524	0.078
9	20	HDR biased	1.106	1.368	0.262
10	20	HDR biased	1.775	1.227	-0.548
11	30	HDR unbiased	1.507	1.504	-0.003
12	30	HDR unbiased	1.755	1.845	0.09
13	30	HDR unbiased	1.449	1.447	-0.002
14	30	HDR unbiased	1.384	1.478	0.094
15	30	HDR unbiased	1.511	1.543	0.032
16	30	HDR biased	1.735	1.593	-0.142
17	30	HDR biased	1.58	1.708	0.128
18	30	HDR biased	2.848	2.593	-0.255
19	30	HDR biased	1.418	1.499	0.081
20	30	HDR biased	1.325	1.171	-0.154
21	0	correlation	1.516	1.538	0.022
22	0	correlation	1.422	1.426	0.004
23	0	correlation	1.408	1.4	-0.008
24	0	correlation	1.364	1.362	-0.002
25	0	correlation	1.558	1.535	-0.023

TID vs Post - Pre Exposure Delta

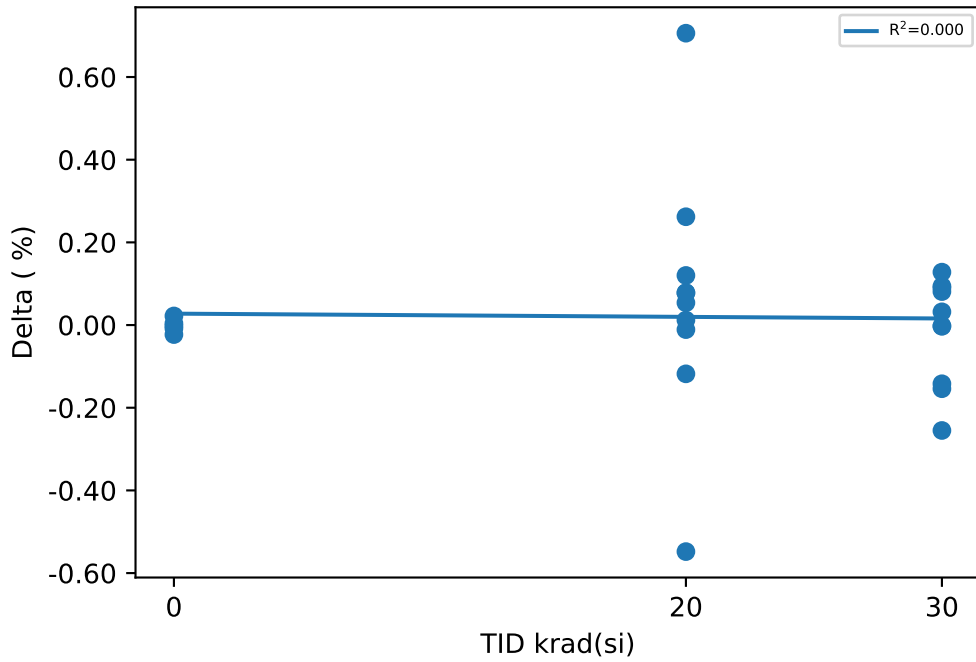

Test Statistics (%)

krad(si)	Pre Exposure Min	Pre Exposure Avg	Pre Exposure Max	Pre Exposure Std	Post Exposure Min	Post Exposure Avg	Post Exposure Max	Post Exposure Std	Min Delta	Avg Delta	Max Delta	Std Delta
0	1.364	1.4536	1.558	0.080466	1.362	1.4522	1.538	0.080257	-0.023	-0.0014	0.022	0.016486
20	1.014	1.5329	1.913	0.32921	1.092	1.5962	1.942	0.28335	-0.548	0.0633	0.706	0.31109
30	1.325	1.6512	2.848	0.44331	1.171	1.6381	2.593	0.37834	-0.255	-0.0131	0.128	0.12828

Device Test: 12.32 UJJ3KD(Delta_RDSON_28V_CH2CH3_UJJ3KD)

TID vs Result Stats

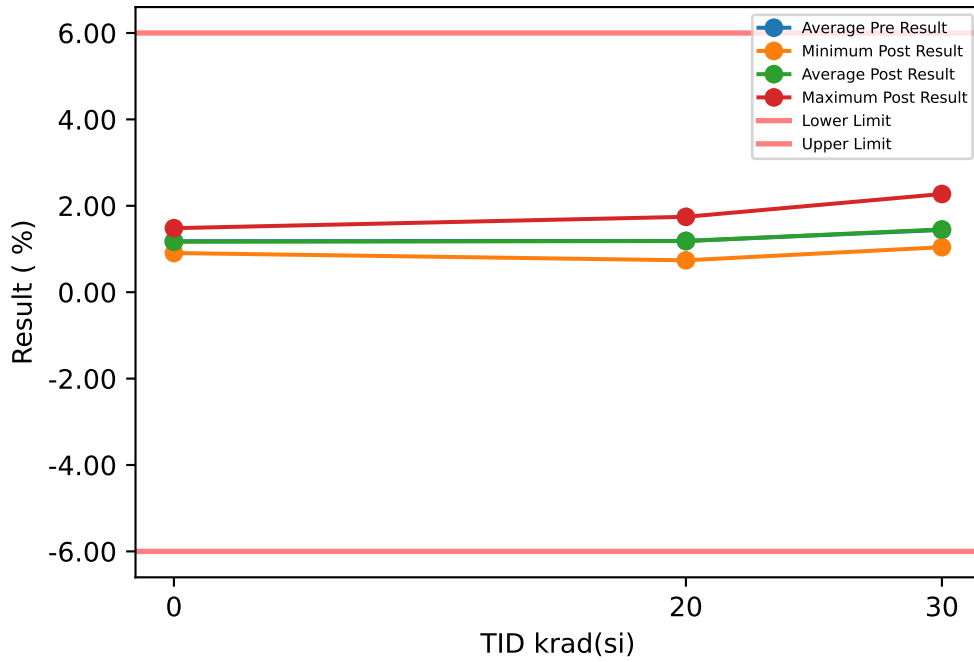

Test Results (Lower Limit = -6.0, Upper Limit = 6.0 (%))

Serial #	krad(si)	Exposure Conditions	Pre Result	Post Result	Delta
1	20	HDR unbiased	1.043	1.154	0.111
2	20	HDR unbiased	0.956	0.971	0.015
3	20	HDR unbiased	1.397	1.442	0.045
4	20	HDR unbiased	1.163	1.117	-0.046
5	20	HDR unbiased	1.271	1.174	-0.097
6	20	HDR biased	0.809	1.449	0.64
7	20	HDR biased	1.736	1.745	0.009
8	20	HDR biased	1.342	1.261	-0.081
9	20	HDR biased	0.695	0.791	0.096
10	20	HDR biased	1.451	0.738	-0.713
11	30	HDR unbiased	1.407	1.333	-0.074
12	30	HDR unbiased	1.501	1.587	0.086
13	30	HDR unbiased	0.952	1.042	0.09
14	30	HDR unbiased	1.22	1.38	0.16
15	30	HDR unbiased	1.345	1.341	-0.004
16	30	HDR biased	1.241	1.071	-0.17
17	30	HDR biased	1.612	1.787	0.175
18	30	HDR biased	2.48	2.273	-0.207
19	30	HDR biased	1.343	1.33	-0.013
20	30	HDR biased	1.304	1.397	0.093
21	0	correlation	1.487	1.482	-0.005
22	0	correlation	1.334	1.307	-0.027
23	0	correlation	1.197	1.163	-0.034
24	0	correlation	0.967	0.978	0.011
25	0	correlation	0.919	0.907	-0.012

TID vs Post - Pre Exposure Delta

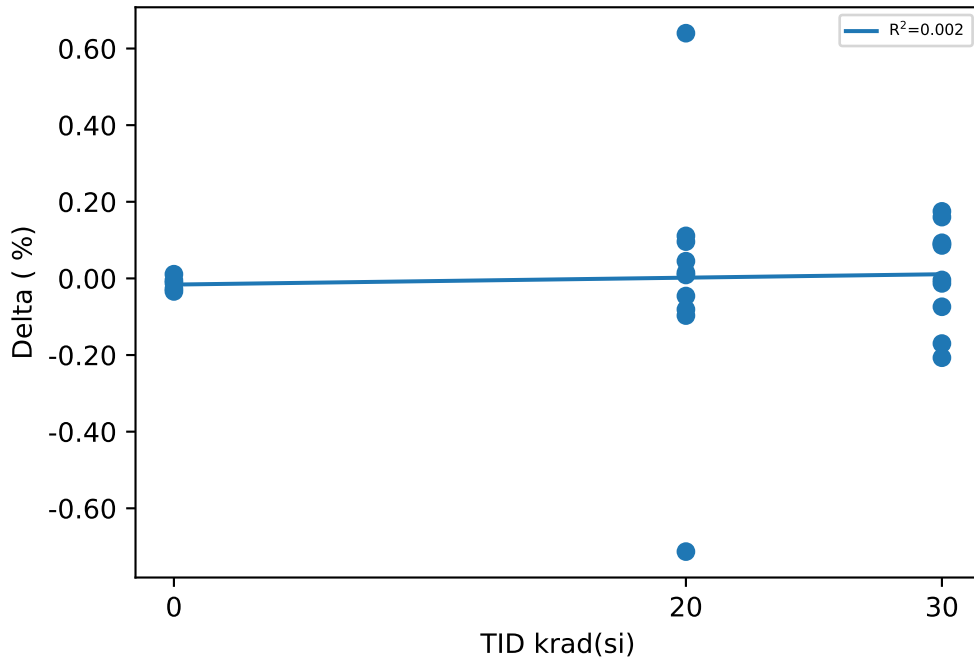

Test Statistics (%)

krad(si)	Pre Exposure Min	Pre Exposure Avg	Pre Exposure Max	Pre Exposure Std	Post Exposure Min	Post Exposure Avg	Post Exposure Max	Post Exposure Std	Min Delta	Avg Delta	Max Delta	Std Delta
0	0.919	1.1808	1.487	0.2407	0.907	1.1674	1.482	0.23567	-0.034	-0.0134	0.011	0.017869
20	0.695	1.1863	1.736	0.31726	0.738	1.1842	1.745	0.30942	-0.713	-0.0021	0.64	0.32658
30	0.952	1.4405	2.48	0.40539	1.042	1.4541	2.273	0.36014	-0.207	0.0136	0.175	0.13163

Device Test: 12.33 UJJ3KD(Delta_RDSON_28V_CH2CH4_UJJ3KD)

TID vs Result Stats

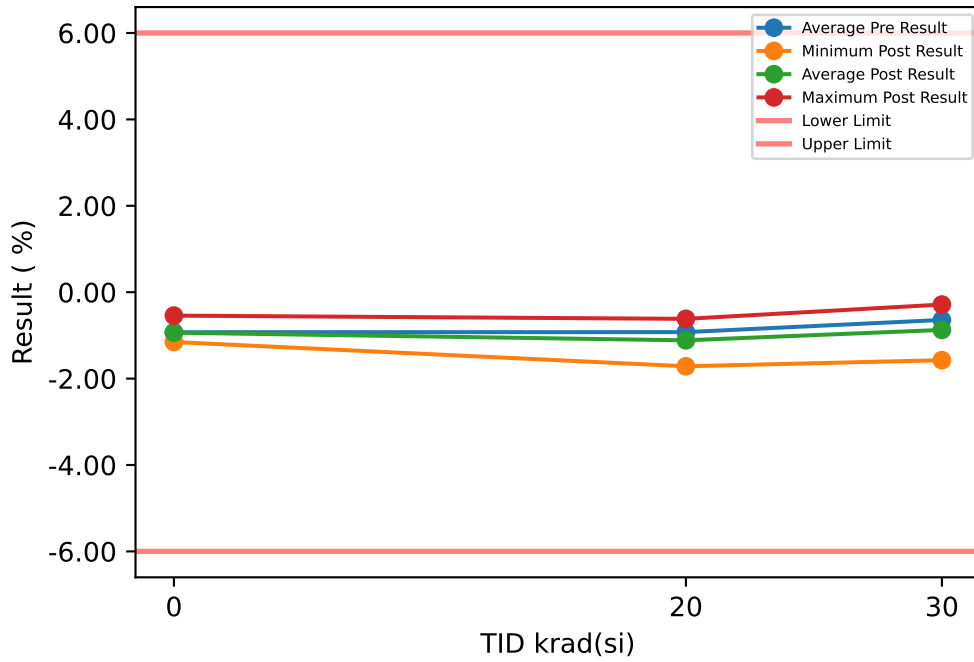

TID vs Post - Pre Exposure Delta

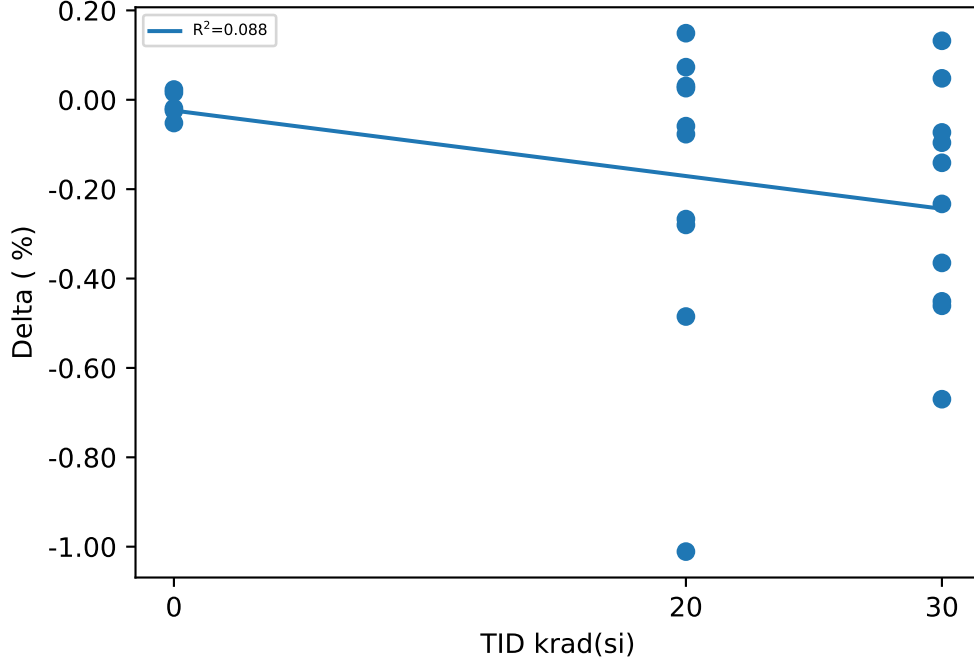

Test Results (Lower Limit = -6.0, Upper Limit = 6.0 (%))

Serial #	krad(si)	Exposure Conditions	Pre Result	Post Result	Delta
1	20	HDR unbiased	-0.944	-0.871	0.073
2	20	HDR unbiased	-1.12	-1.179	-0.059
3	20	HDR unbiased	-0.826	-0.795	0.031
4	20	HDR unbiased	-0.54	-0.617	-0.077
5	20	HDR unbiased	-1.084	-1.058	0.026
6	20	HDR biased	-1.304	-1.155	0.149
7	20	HDR biased	-0.344	-0.624	-0.28
8	20	HDR biased	-0.966	-1.451	-0.485
9	20	HDR biased	-1.448	-1.715	-0.267
10	20	HDR biased	-0.666	-1.677	-1.011
11	30	HDR unbiased	-0.74	-0.881	-0.141
12	30	HDR unbiased	-0.654	-0.606	0.048
13	30	HDR unbiased	-1.154	-1.25	-0.096
14	30	HDR unbiased	-0.866	-0.734	0.132
15	30	HDR unbiased	-0.483	-0.556	-0.073
16	30	HDR biased	-0.439	-0.89	-0.451
17	30	HDR biased	-0.614	-0.847	-0.233
18	30	HDR biased	0.384	-0.286	-0.67
19	30	HDR biased	-0.743	-1.108	-0.365
20	30	HDR biased	-1.113	-1.574	-0.461
21	0	correlation	-0.565	-0.542	0.023
22	0	correlation	-0.882	-0.934	-0.052
23	0	correlation	-1.025	-1.044	-0.019
24	0	correlation	-1.03	-1.014	0.016
25	0	correlation	-1.129	-1.153	-0.024

Test Statistics (%)

krad(si)	Pre Exposure Min	Pre Exposure Avg	Pre Exposure Max	Pre Exposure Std	Post Exposure Min	Post Exposure Avg	Post Exposure Max	Post Exposure Std	Min Delta	Avg Delta	Max Delta	Std Delta
0	-1.129	-0.9262	-0.565	0.22027	-1.153	-0.9374	-0.542	0.23456	-0.052	-0.0112	0.023	0.030817
20	-1.448	-0.9242	-0.344	0.34078	-1.715	-1.1142	-0.617	0.40121	-1.011	-0.19	0.149	0.34715
30	-1.154	-0.6422	0.384	0.43128	-1.574	-0.8732	-0.286	0.369	-0.67	-0.231	0.132	0.2523

Device Test: 12.34 UJJ3KD(Delta_RDSON_28V_CH3CH4_UJJ3KD)

TID vs Result Stats

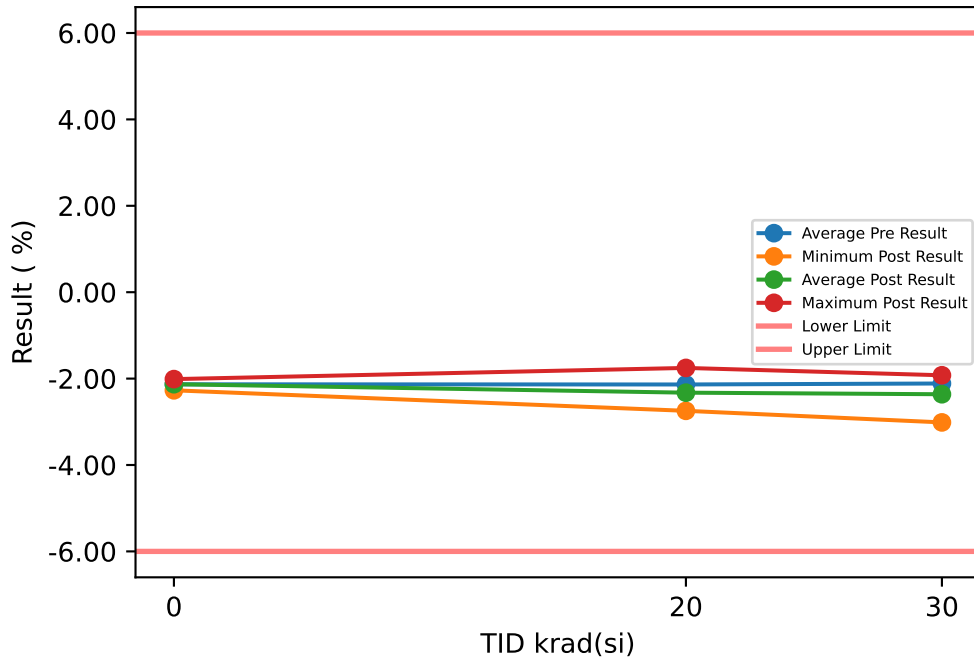

Test Results (Lower Limit = -6.0, Upper Limit = 6.0 (%))

Serial #	krad(si)	Exposure Conditions	Pre Result	Post Result	Delta
1	20	HDR unbiased	-2.008	-2.049	-0.041
2	20	HDR unbiased	-2.096	-2.172	-0.076
3	20	HDR unbiased	-2.255	-2.269	-0.014
4	20	HDR unbiased	-1.723	-1.753	-0.03
5	20	HDR unbiased	-2.386	-2.259	0.127
6	20	HDR biased	-2.13	-2.641	-0.511
7	20	HDR biased	-2.117	-2.411	-0.294
8	20	HDR biased	-2.339	-2.746	-0.407
9	20	HDR biased	-2.158	-2.526	-0.368
10	20	HDR biased	-2.148	-2.433	-0.285
11	30	HDR unbiased	-2.178	-2.243	-0.065
12	30	HDR unbiased	-2.188	-2.228	-0.04
13	30	HDR unbiased	-2.126	-2.316	-0.19
14	30	HDR unbiased	-2.113	-2.143	-0.03
15	30	HDR unbiased	-1.853	-1.923	-0.07
16	30	HDR biased	-1.701	-1.982	-0.281
17	30	HDR biased	-2.263	-2.682	-0.419
18	30	HDR biased	-2.149	-2.619	-0.47
19	30	HDR biased	-2.114	-2.471	-0.357
20	30	HDR biased	-2.449	-3.014	-0.565
21	0	correlation	-2.083	-2.054	0.029
22	0	correlation	-2.246	-2.271	-0.025
23	0	correlation	-2.249	-2.233	0.016
24	0	correlation	-2.016	-2.012	0.004
25	0	correlation	-2.067	-2.079	-0.012

TID vs Post - Pre Exposure Delta

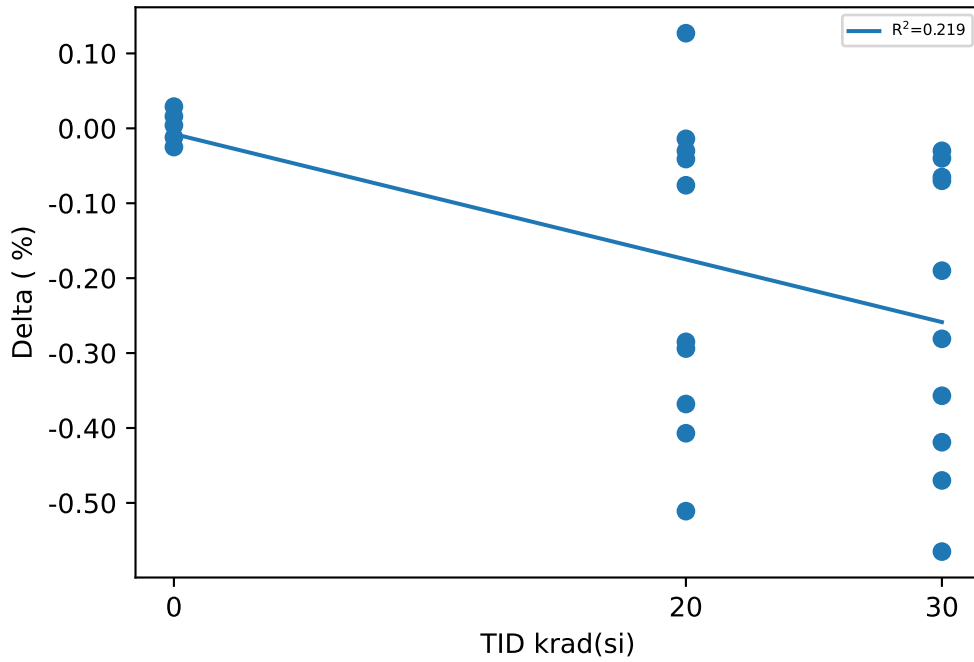

Test Statistics (%)

krad(si)	Pre Exposure Min	Pre Exposure Avg	Pre Exposure Max	Pre Exposure Std	Post Exposure Min	Post Exposure Avg	Post Exposure Max	Post Exposure Std	Min Delta	Avg Delta	Max Delta	Std Delta
0	-2.249	-2.1322	-2.016	0.10813	-2.271	-2.1298	-2.012	0.11488	-0.025	0.0024	0.029	0.021524
20	-2.386	-2.136	-1.723	0.18483	-2.746	-2.3259	-1.753	0.29265	-0.511	-0.1899	0.127	0.20921
30	-2.449	-2.1134	-1.701	0.20657	-3.014	-2.3621	-1.923	0.33743	-0.565	-0.2487	-0.03	0.19757

Device Test: 12.35 UJJ3KD(Delta_RDSON_32V_CH1CH2_UJJ3KD)

TID vs Result Stats

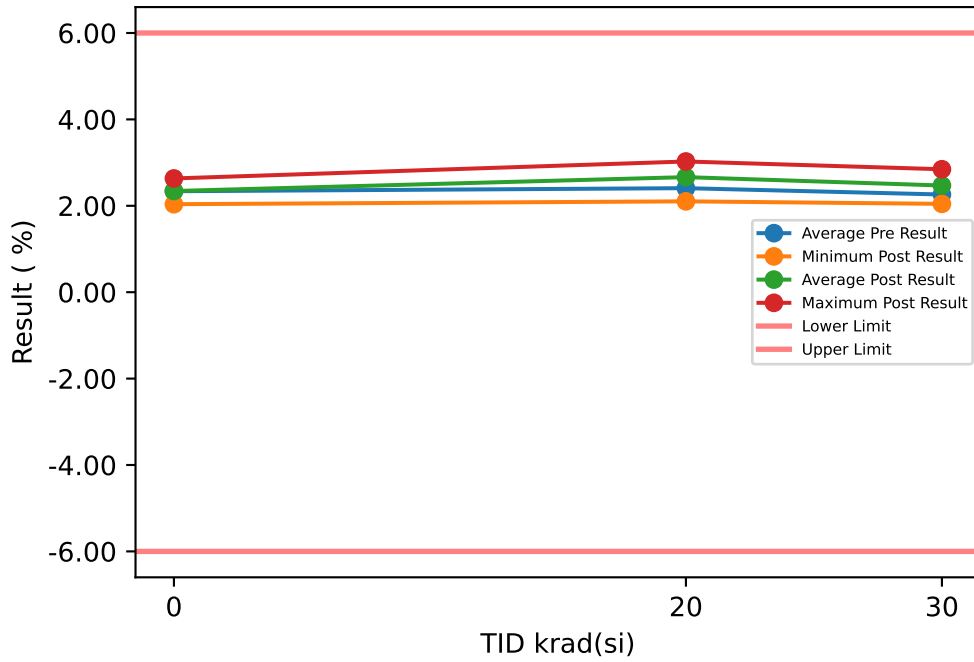

Test Results (Lower Limit = -6.0, Upper Limit = 6.0 (%))

Serial #	krad(si)	Exposure Conditions	Pre Result	Post Result	Delta
1	20	HDR unbiased	2.599	2.537	-0.062
2	20	HDR unbiased	2.804	2.878	0.074
3	20	HDR unbiased	2.429	2.457	0.028
4	20	HDR unbiased	2.414	2.381	-0.033
5	20	HDR unbiased	2.054	2.103	0.049
6	20	HDR biased	2.4	2.969	0.569
7	20	HDR biased	2.138	2.54	0.402
8	20	HDR biased	2.351	2.905	0.554
9	20	HDR biased	2.498	3.026	0.528
10	20	HDR biased	2.394	2.838	0.444
11	30	HDR unbiased	2.221	2.344	0.123
12	30	HDR unbiased	2.361	2.419	0.058
13	30	HDR unbiased	2.566	2.628	0.062
14	30	HDR unbiased	2.213	2.184	-0.029
15	30	HDR unbiased	1.964	2.045	0.081
16	30	HDR biased	2.153	2.428	0.275
17	30	HDR biased	2.152	2.538	0.386
18	30	HDR biased	2.448	2.846	0.398
19	30	HDR biased	2.135	2.575	0.44
20	30	HDR biased	2.4	2.69	0.29
21	0	correlation	2.036	2.037	0.001
22	0	correlation	2.268	2.316	0.048
23	0	correlation	2.386	2.379	-0.007
24	0	correlation	2.354	2.345	-0.009
25	0	correlation	2.643	2.633	-0.01

TID vs Post - Pre Exposure Delta

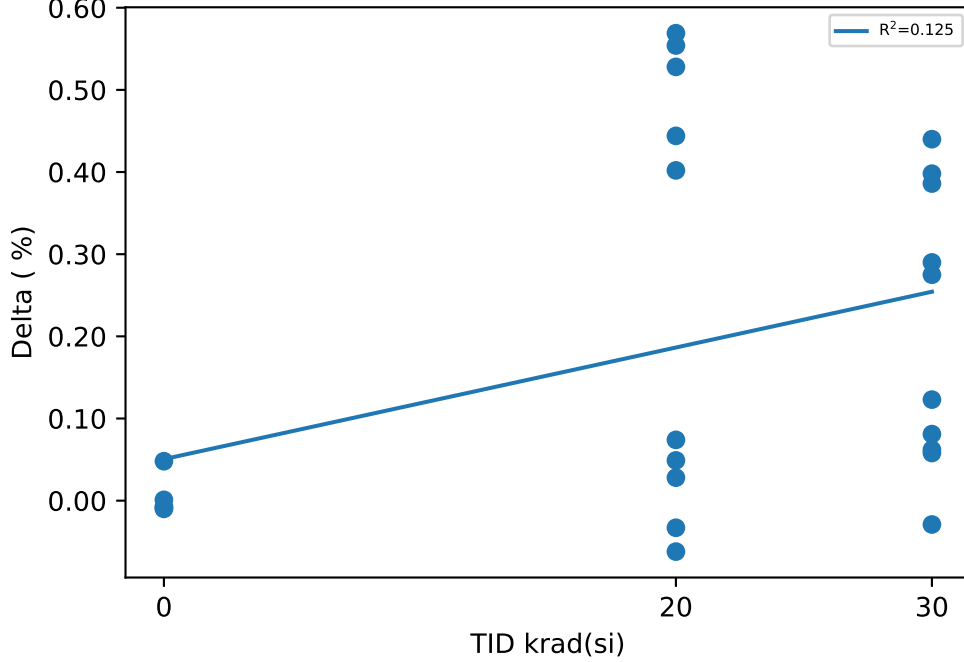

Test Statistics (%)

krad(si)	Pre Exposure Min	Pre Exposure Avg	Pre Exposure Max	Pre Exposure Std	Post Exposure Min	Post Exposure Avg	Post Exposure Max	Post Exposure Std	Min Delta	Avg Delta	Max Delta	Std Delta
0	2.036	2.3374	2.643	0.21891	2.037	2.342	2.633	0.21199	-0.01	0.0046	0.048	0.024643
20	2.054	2.4081	2.804	0.21176	2.103	2.6634	3.026	0.3032	-0.062	0.2553	0.569	0.26458
30	1.964	2.2613	2.566	0.17915	2.045	2.4697	2.846	0.23876	-0.029	0.2084	0.44	0.16871

Device Test: 12.36 UJJ3KD(Delta_RDSON_32V_CH1CH3_UJJ3KD)

TID vs Result Stats

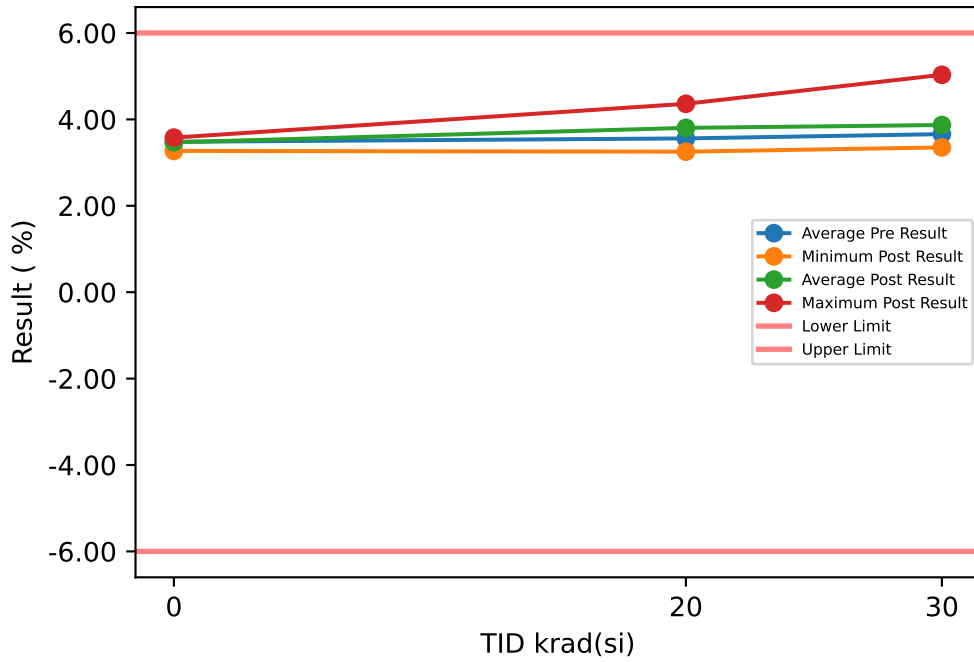

Test Results (Lower Limit = -6.0, Upper Limit = 6.0 (%))

Serial #	krad(si)	Exposure Conditions	Pre Result	Post Result	Delta
1	20	HDR unbiased	3.601	3.651	0.05
2	20	HDR unbiased	3.727	3.801	0.074
3	20	HDR unbiased	3.784	3.834	0.05
4	20	HDR unbiased	3.538	3.456	-0.082
5	20	HDR unbiased	3.299	3.253	-0.046
6	20	HDR biased	3.187	4.361	1.174
7	20	HDR biased	3.825	4.232	0.407
8	20	HDR biased	3.652	4.134	0.482
9	20	HDR biased	3.173	3.775	0.602
10	20	HDR biased	3.809	3.538	-0.271
11	30	HDR unbiased	3.571	3.631	0.06
12	30	HDR unbiased	3.816	3.95	0.134
13	30	HDR unbiased	3.486	3.628	0.142
14	30	HDR unbiased	3.395	3.52	0.125
15	30	HDR unbiased	3.275	3.352	0.077
16	30	HDR biased	3.357	3.474	0.117
17	30	HDR biased	3.729	4.244	0.515
18	30	HDR biased	4.866	5.032	0.166
19	30	HDR biased	3.435	3.839	0.404
20	30	HDR biased	3.664	4.032	0.368
21	0	correlation	3.486	3.474	-0.012
22	0	correlation	3.557	3.578	0.021
23	0	correlation	3.542	3.513	-0.029
24	0	correlation	3.29	3.27	-0.02
25	0	correlation	3.534	3.51	-0.024

TID vs Post - Pre Exposure Delta

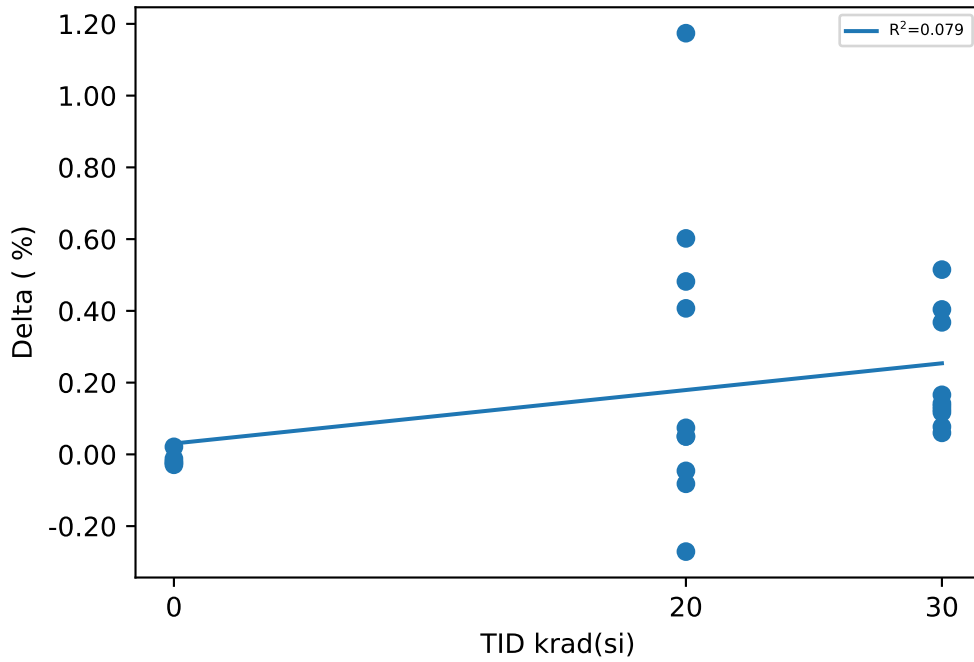

Test Statistics (%)

krad(si)	Pre Exposure Min	Pre Exposure Avg	Pre Exposure Max	Pre Exposure Std	Post Exposure Min	Post Exposure Avg	Post Exposure Max	Post Exposure Std	Min Delta	Avg Delta	Max Delta	Std Delta
0	3.29	3.4818	3.557	0.11046	3.27	3.469	3.578	0.11739	-0.029	-0.0128	0.021	0.019892
20	3.173	3.5595	3.825	0.25341	3.253	3.8035	4.361	0.35323	-0.271	0.244	1.174	0.42636
30	3.275	3.6594	4.866	0.45736	3.352	3.8702	5.032	0.49296	0.06	0.2108	0.515	0.15777

Device Test: 12.37 UJJ3KD(Delta_RDSON_32V_CH1CH4_UJJ3KD)

TID vs Result Stats

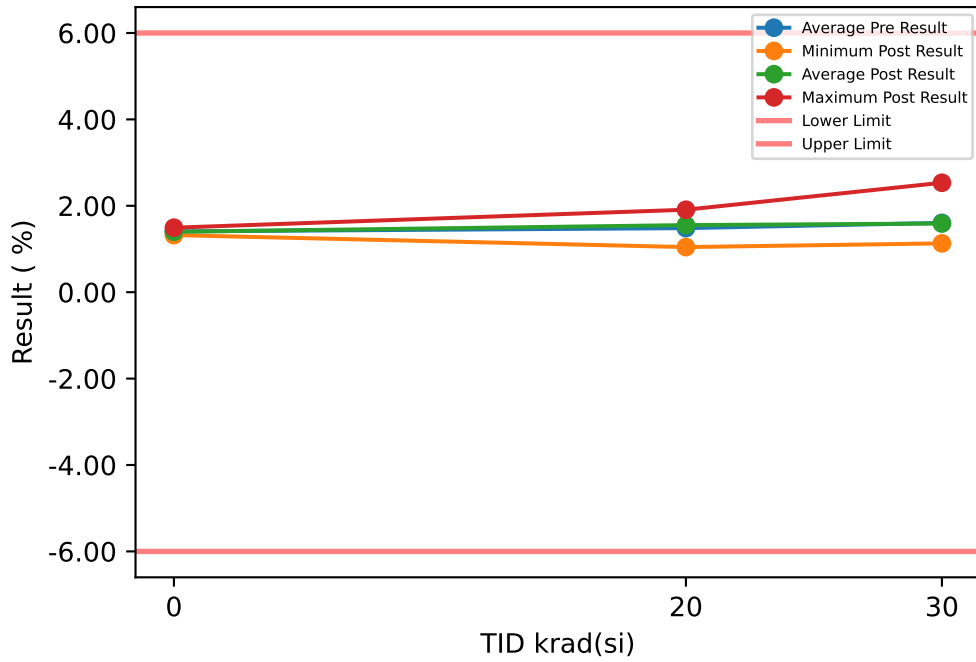

Test Results (Lower Limit = -6.0, Upper Limit = 6.0 (%))

Serial #	krad(si)	Exposure Conditions	Pre Result	Post Result	Delta
1	20	HDR unbiased	1.66	1.663	0.003
2	20	HDR unbiased	1.689	1.692	0.003
3	20	HDR unbiased	1.602	1.642	0.04
4	20	HDR unbiased	1.853	1.75	-0.103
5	20	HDR unbiased	0.972	1.044	0.072
6	20	HDR biased	1.106	1.829	0.723
7	20	HDR biased	1.768	1.909	0.141
8	20	HDR biased	1.392	1.477	0.085
9	20	HDR biased	1.056	1.343	0.287
10	20	HDR biased	1.73	1.181	-0.549
11	30	HDR unbiased	1.456	1.453	-0.003
12	30	HDR unbiased	1.689	1.795	0.106
13	30	HDR unbiased	1.415	1.394	-0.021
14	30	HDR unbiased	1.343	1.436	0.093
15	30	HDR unbiased	1.466	1.475	0.009
16	30	HDR biased	1.697	1.537	-0.16
17	30	HDR biased	1.521	1.676	0.155
18	30	HDR biased	2.79	2.533	-0.257
19	30	HDR biased	1.385	1.47	0.085
20	30	HDR biased	1.28	1.13	-0.15
21	0	correlation	1.462	1.468	0.006
22	0	correlation	1.39	1.375	-0.015
23	0	correlation	1.354	1.335	-0.019
24	0	correlation	1.328	1.322	-0.006
25	0	correlation	1.501	1.493	-0.008

TID vs Post - Pre Exposure Delta

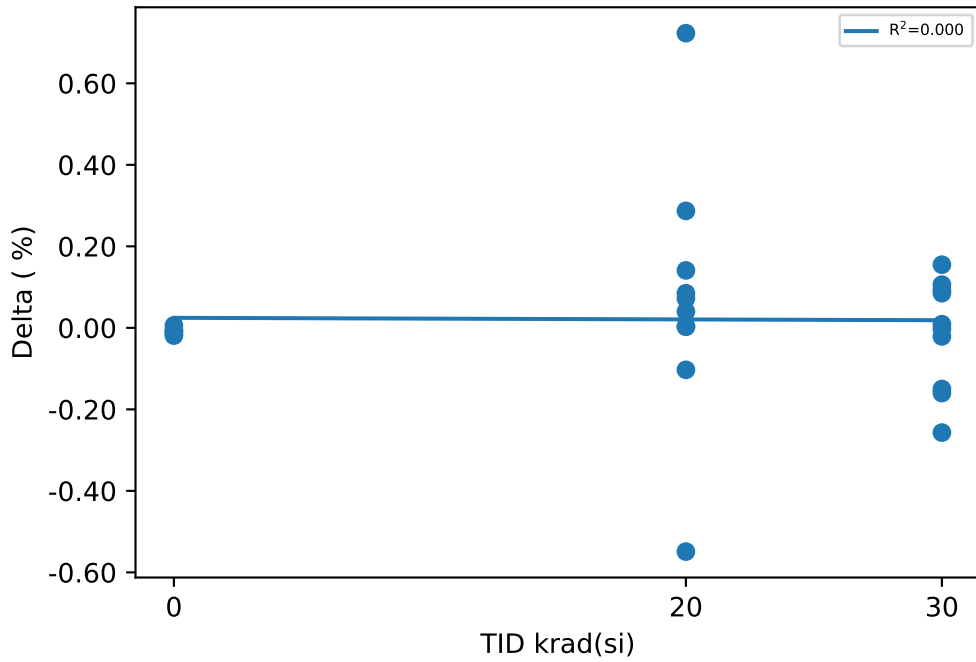

Test Statistics (%)

krad(si)	Pre Exposure Min	Pre Exposure Avg	Pre Exposure Max	Pre Exposure Std	Post Exposure Min	Post Exposure Avg	Post Exposure Max	Post Exposure Std	Min Delta	Avg Delta	Max Delta	Std Delta
0	1.328	1.407	1.501	0.072801	1.322	1.3986	1.493	0.077777	-0.019	-0.0084	0.006	0.0096073
20	0.972	1.4828	1.853	0.32676	1.044	1.553	1.909	0.28449	-0.549	0.0702	0.723	0.31653
30	1.28	1.6042	2.79	0.43806	1.13	1.5899	2.533	0.3744	-0.257	-0.0143	0.155	0.1349

Device Test: 12.38 UJJ3KD(Delta_RDSON_32V_CH2CH3_UJJ3KD)

TID vs Result Stats

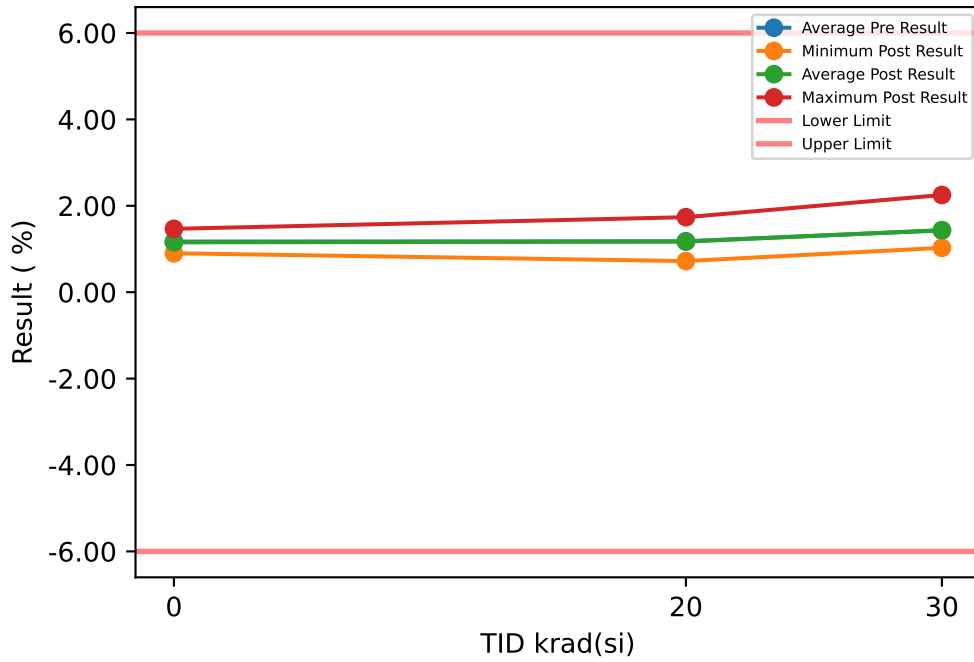

Test Results (Lower Limit = -6.0, Upper Limit = 6.0 (%))

Serial #	krad(si)	Exposure Conditions	Pre Result	Post Result	Delta
1	20	HDR unbiased	1.029	1.143	0.114
2	20	HDR unbiased	0.95	0.951	0.001
3	20	HDR unbiased	1.388	1.411	0.023
4	20	HDR unbiased	1.151	1.101	-0.05
5	20	HDR unbiased	1.272	1.175	-0.097
6	20	HDR biased	0.806	1.435	0.629
7	20	HDR biased	1.723	1.736	0.013
8	20	HDR biased	1.333	1.265	-0.068
9	20	HDR biased	0.692	0.772	0.08
10	20	HDR biased	1.45	0.721	-0.729
11	30	HDR unbiased	1.381	1.317	-0.064
12	30	HDR unbiased	1.49	1.569	0.079
13	30	HDR unbiased	0.944	1.027	0.083
14	30	HDR unbiased	1.209	1.367	0.158
15	30	HDR unbiased	1.337	1.335	-0.002
16	30	HDR biased	1.23	1.072	-0.158
17	30	HDR biased	1.612	1.75	0.138
18	30	HDR biased	2.478	2.25	-0.228
19	30	HDR biased	1.328	1.297	-0.031
20	30	HDR biased	1.295	1.379	0.084
21	0	correlation	1.481	1.467	-0.014
22	0	correlation	1.319	1.291	-0.028
23	0	correlation	1.184	1.161	-0.023
24	0	correlation	0.959	0.947	-0.012
25	0	correlation	0.916	0.901	-0.015

TID vs Post - Pre Exposure Delta

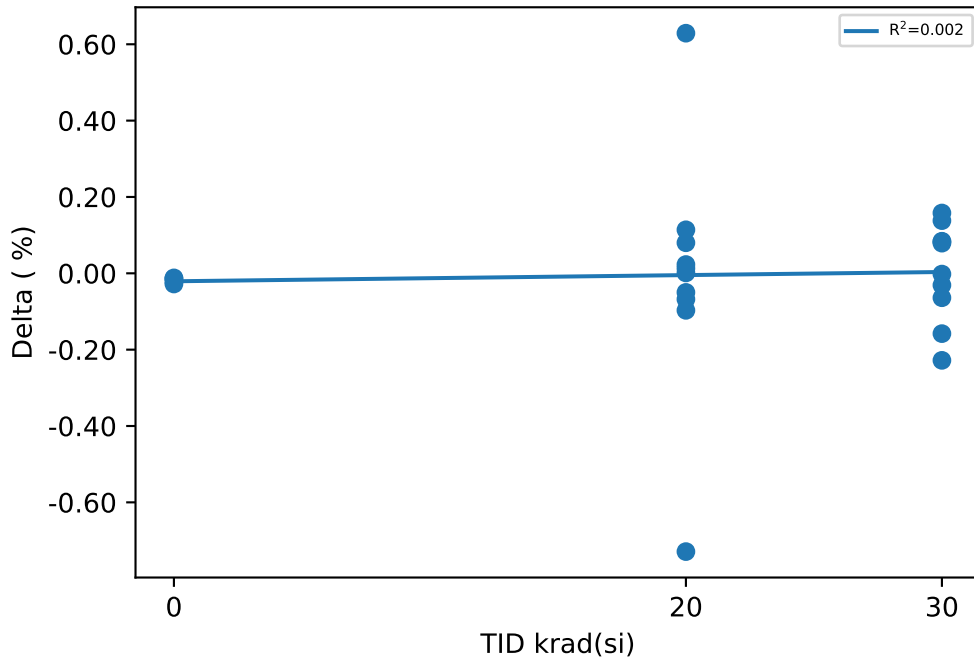

Test Statistics (%)

krad(si)	Pre Exposure Min	Pre Exposure Avg	Pre Exposure Max	Pre Exposure Std	Post Exposure Min	Post Exposure Avg	Post Exposure Max	Post Exposure Std	Min Delta	Avg Delta	Max Delta	Std Delta
0	0.916	1.1718	1.481	0.23882	0.901	1.1534	1.467	0.23645	-0.028	-0.0184	-0.012	0.0068044
20	0.692	1.1794	1.723	0.31578	0.721	1.171	1.736	0.31112	-0.729	-0.0084	0.629	0.32711
30	0.944	1.4304	2.478	0.40821	1.027	1.4363	2.25	0.35439	-0.228	0.0059	0.158	0.1273

Device Test: 12.39 UJJ3KD(Delta_RDSON_32V_CH2CH4_UJJ3KD)

TID vs Result Stats

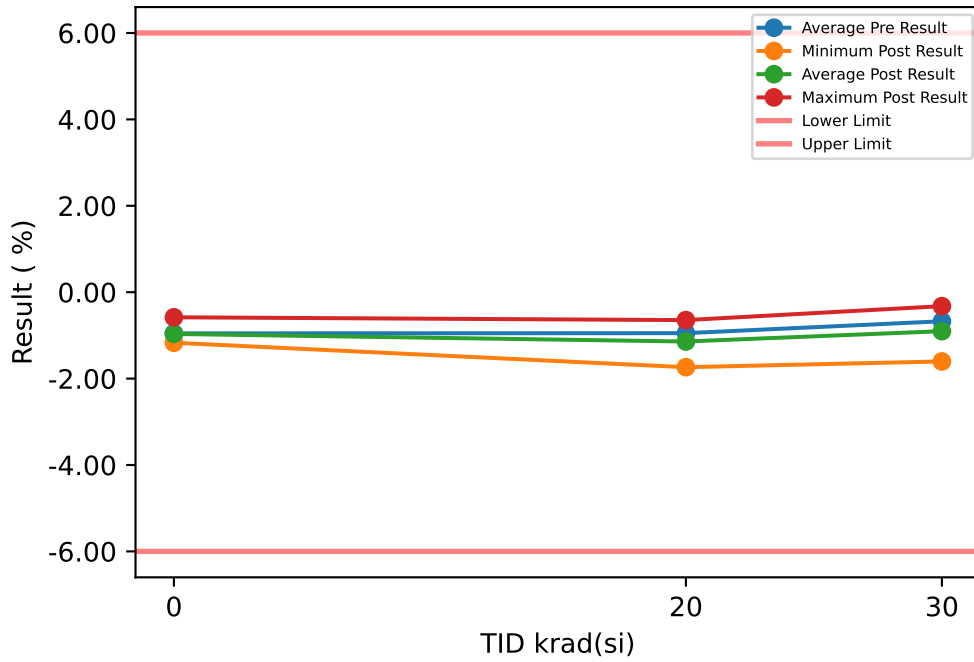

Test Results (Lower Limit = -6.0, Upper Limit = 6.0 (%))

Serial #	krad(si)	Exposure Conditions	Pre Result	Post Result	Delta
1	20	HDR unbiased	-0.964	-0.896	0.068
2	20	HDR unbiased	-1.147	-1.221	-0.074
3	20	HDR unbiased	-0.848	-0.835	0.013
4	20	HDR unbiased	-0.575	-0.646	-0.071
5	20	HDR unbiased	-1.104	-1.082	0.022
6	20	HDR biased	-1.326	-1.175	0.151
7	20	HDR biased	-0.379	-0.647	-0.268
8	20	HDR biased	-0.982	-1.471	-0.489
9	20	HDR biased	-1.479	-1.736	-0.257
10	20	HDR biased	-0.681	-1.705	-1.024
11	30	HDR unbiased	-0.782	-0.913	-0.131
12	30	HDR unbiased	-0.688	-0.639	0.049
13	30	HDR unbiased	-1.181	-1.267	-0.086
14	30	HDR unbiased	-0.891	-0.765	0.126
15	30	HDR unbiased	-0.509	-0.581	-0.072
16	30	HDR biased	-0.466	-0.913	-0.447
17	30	HDR biased	-0.644	-0.885	-0.241
18	30	HDR biased	0.35	-0.323	-0.673
19	30	HDR biased	-0.767	-1.134	-0.367
20	30	HDR biased	-1.148	-1.603	-0.455
21	0	correlation	-0.586	-0.581	0.005
22	0	correlation	-0.898	-0.963	-0.065
23	0	correlation	-1.058	-1.07	-0.012
24	0	correlation	-1.051	-1.048	0.003
25	0	correlation	-1.172	-1.17	0.002

TID vs Post - Pre Exposure Delta

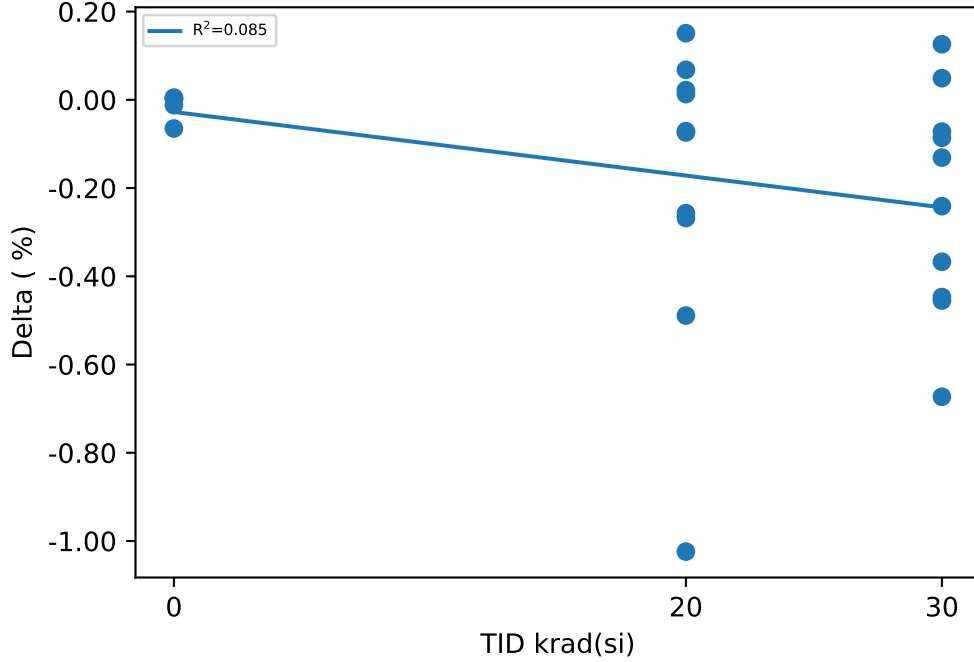

Test Statistics (%)

krad(si)	Pre Exposure Min	Pre Exposure Avg	Pre Exposure Max	Pre Exposure Std	Post Exposure Min	Post Exposure Avg	Post Exposure Max	Post Exposure Std	Min Delta	Avg Delta	Max Delta	Std Delta
0	-1.172	-0.953	-0.586	0.2271	-1.17	-0.9664	-0.581	0.2277	-0.065	-0.0134	0.005	0.029619
20	-1.479	-0.9485	-0.379	0.33901	-1.736	-1.1414	-0.646	0.39927	-1.024	-0.1929	0.151	0.34834
30	-1.181	-0.6726	0.35	0.43067	-1.603	-0.9023	-0.323	0.36594	-0.673	-0.2297	0.126	0.25231

Device Test: 12.40 UJJ3KD(Delta_RDSON_32V_CH3CH4_UJJ3KD)

TID vs Result Stats

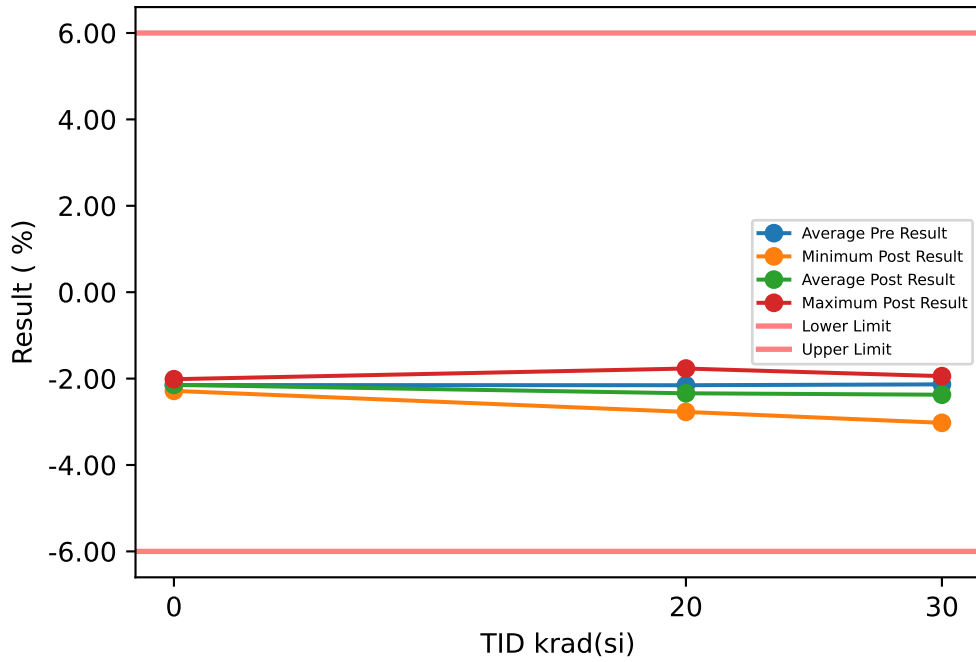

Test Results (Lower Limit = -6.0, Upper Limit = 6.0 (%))

Serial #	krad(si)	Exposure Conditions	Pre Result	Post Result	Delta
1	20	HDR unbiased	-2.013	-2.063	-0.05
2	20	HDR unbiased	-2.117	-2.193	-0.076
3	20	HDR unbiased	-2.268	-2.279	-0.011
4	20	HDR unbiased	-1.747	-1.767	-0.02
5	20	HDR unbiased	-2.407	-2.284	0.123
6	20	HDR biased	-2.149	-2.648	-0.499
7	20	HDR biased	-2.139	-2.425	-0.286
8	20	HDR biased	-2.346	-2.771	-0.425
9	20	HDR biased	-2.186	-2.527	-0.341
10	20	HDR biased	-2.162	-2.444	-0.282
11	30	HDR unbiased	-2.194	-2.26	-0.066
12	30	HDR unbiased	-2.211	-2.244	-0.033
13	30	HDR unbiased	-2.146	-2.317	-0.171
14	30	HDR unbiased	-2.125	-2.161	-0.036
15	30	HDR unbiased	-1.87	-1.943	-0.073
16	30	HDR biased	-1.718	-2.006	-0.288
17	30	HDR biased	-2.293	-2.682	-0.389
18	30	HDR biased	-2.182	-2.632	-0.45
19	30	HDR biased	-2.123	-2.463	-0.34
20	30	HDR biased	-2.475	-3.024	-0.549
21	0	correlation	-2.097	-2.078	0.019
22	0	correlation	-2.247	-2.284	-0.037
23	0	correlation	-2.269	-2.257	0.012
24	0	correlation	-2.029	-2.014	0.015
25	0	correlation	-2.107	-2.09	0.017

TID vs Post - Pre Exposure Delta

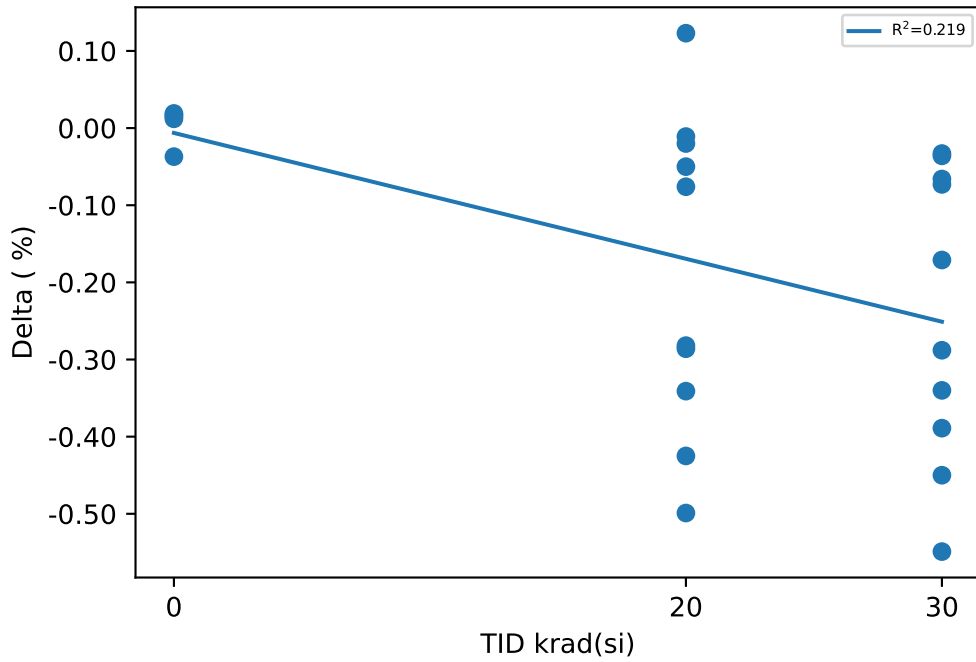

Test Statistics (%)

krad(si)	Pre Exposure Min	Pre Exposure Avg	Pre Exposure Max	Pre Exposure Std	Post Exposure Min	Post Exposure Avg	Post Exposure Max	Post Exposure Std	Min Delta	Avg Delta	Max Delta	Std Delta
0	-2.269	-2.1498	-2.029	0.10352	-2.284	-2.1446	-2.014	0.11889	-0.037	0.0052	0.019	0.023732
20	-2.407	-2.1534	-1.747	0.18321	-2.771	-2.3401	-1.767	0.29196	-0.499	-0.1867	0.123	0.20618
30	-2.475	-2.1337	-1.718	0.20989	-3.024	-2.3732	-1.943	0.33192	-0.549	-0.2395	-0.033	0.189

Device Test: 12.4 UJ4ZR4(RDSON_32V_OUT1_UJE410_UJ4ZR4)

TID vs Result Stats

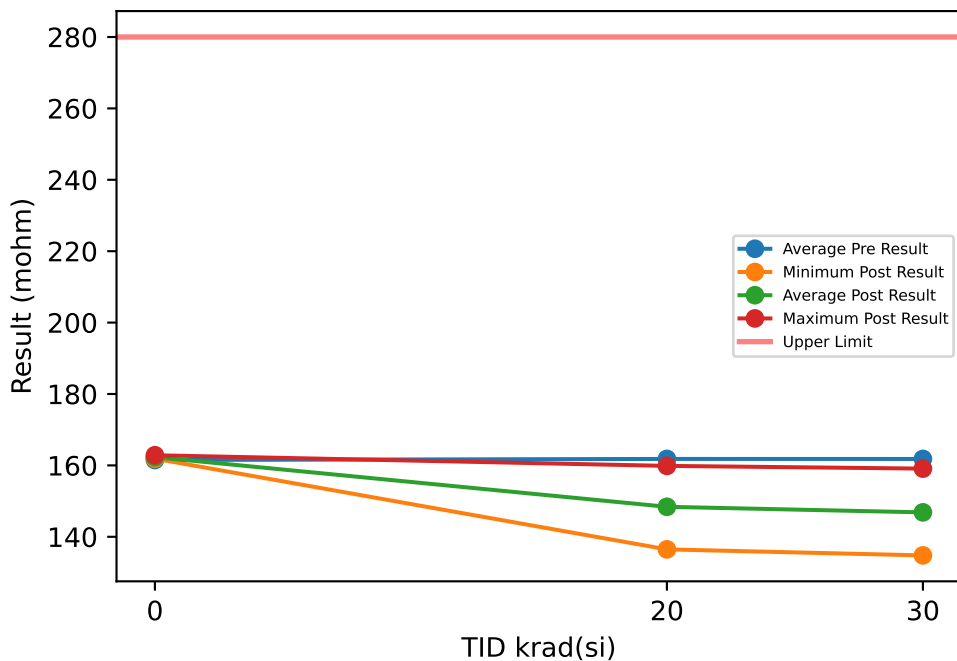

Test Results (Upper Limit = 280.0 (mohm))

Serial #	krad(si)	Exposure Conditions	Pre Result	Post Result	Delta
1	20	HDR unbiased	162.86	159.86	-2.9961
2	20	HDR unbiased	162.07	159.07	-3.0041
3	20	HDR unbiased	161.06	158.18	-2.8769
4	20	HDR unbiased	161.85	158.75	-3.0979
5	20	HDR unbiased	162.09	159.4	-2.6851
6	20	HDR biased	161.66	138.58	-23.076
7	20	HDR biased	161.22	137.48	-23.739
8	20	HDR biased	160.12	136.48	-23.64
9	20	HDR biased	162	137.73	-24.274
10	20	HDR biased	163.19	138.5	-24.692
11	30	HDR unbiased	159.78	157.04	-2.7404
12	30	HDR unbiased	161.75	158.38	-3.3701
13	30	HDR unbiased	162.68	159.1	-3.5817
14	30	HDR unbiased	160.65	158.83	-1.8243
15	30	HDR unbiased	160.94	157.86	-3.0777
16	30	HDR biased	162.52	135.06	-27.459
17	30	HDR biased	162.11	135.27	-26.84
18	30	HDR biased	164.63	137.24	-27.388
19	30	HDR biased	162.06	134.86	-27.197
20	30	HDR biased	160.92	134.79	-26.13
21	0	correlation	161.48	162.52	1.0349
22	0	correlation	161.03	161.88	0.8565
23	0	correlation	162.1	162.85	0.7514
24	0	correlation	161.49	162.21	0.7213
25	0	correlation	161.49	162.15	0.6615

TID vs Post - Pre Exposure Delta

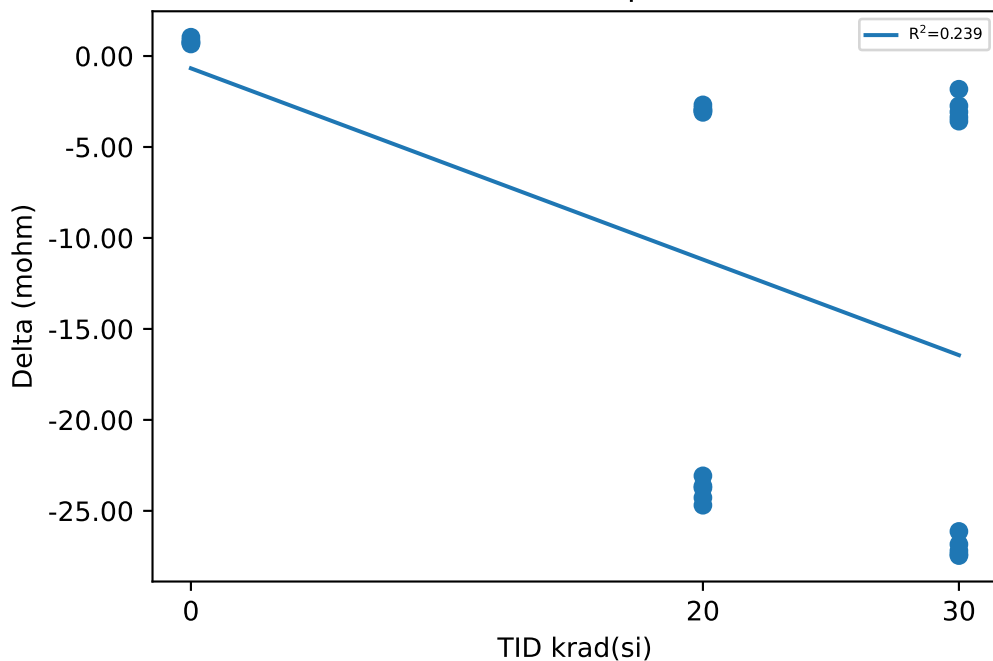

Test Statistics (mohm)

krad(si)	Pre Exposure Min	Pre Exposure Avg	Pre Exposure Max	Pre Exposure Std	Post Exposure Min	Post Exposure Avg	Post Exposure Max	Post Exposure Std	Min Delta	Avg Delta	Max Delta	Std Delta
0	161.03	161.52	162.1	0.37965	161.88	162.32	162.85	0.3696	0.6615	0.80512	1.0349	0.14661
20	160.12	161.81	163.19	0.88209	136.48	148.4	159.86	11.25	-24.692	-13.408	-2.6851	11.051
30	159.78	161.8	164.63	1.348	134.79	146.84	159.1	12.048	-27.459	-14.961	-1.8243	12.707

Device Test: 12.5 UJ4ZR4(RDSON_5V_OUT2_UJE410_UJ4ZR4)

TID vs Result Stats

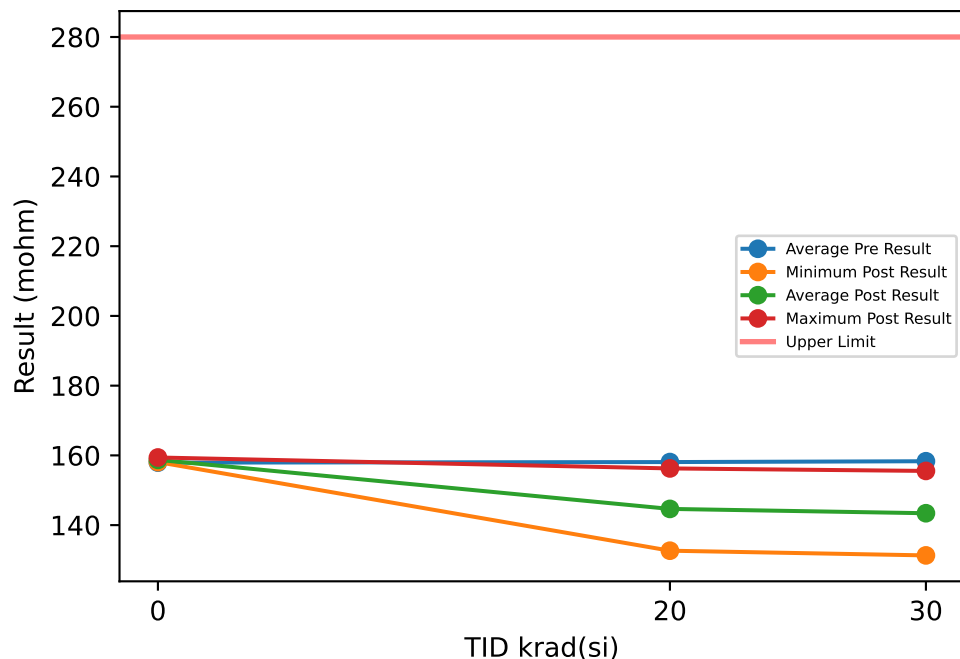

Test Results (Upper Limit = 280.0 (mohm))

Serial #	krad(si)	Exposure Conditions	Pre Result	Post Result	Delta
1	20	HDR unbiased	158.8	156	-2.8024
2	20	HDR unbiased	157.71	154.69	-3.0196
3	20	HDR unbiased	157.33	154.48	-2.8492
4	20	HDR unbiased	158.09	155.21	-2.8851
5	20	HDR unbiased	158.93	156.26	-2.6737
6	20	HDR biased	157.96	134.61	-23.354
7	20	HDR biased	157.96	134.15	-23.81
8	20	HDR biased	156.51	132.66	-23.848
9	20	HDR biased	158.12	133.71	-24.413
10	20	HDR biased	159.43	134.72	-24.709
11	30	HDR unbiased	156.41	153.58	-2.8321
12	30	HDR unbiased	158.1	154.74	-3.3593
13	30	HDR unbiased	158.68	155.15	-3.5364
14	30	HDR unbiased	157.27	155.54	-1.729
15	30	HDR unbiased	157.97	154.81	-3.1641
16	30	HDR biased	159.21	131.94	-27.273
17	30	HDR biased	158.81	132	-26.807
18	30	HDR biased	160.78	133.47	-27.306
19	30	HDR biased	158.75	131.54	-27.212
20	30	HDR biased	157.23	131.32	-25.917
21	0	correlation	158.41	159.4	0.9881
22	0	correlation	157.56	158.33	0.7697
23	0	correlation	158.4	159.16	0.76
24	0	correlation	157.87	158.61	0.7387
25	0	correlation	157.37	158.07	0.7004

TID vs Post - Pre Exposure Delta

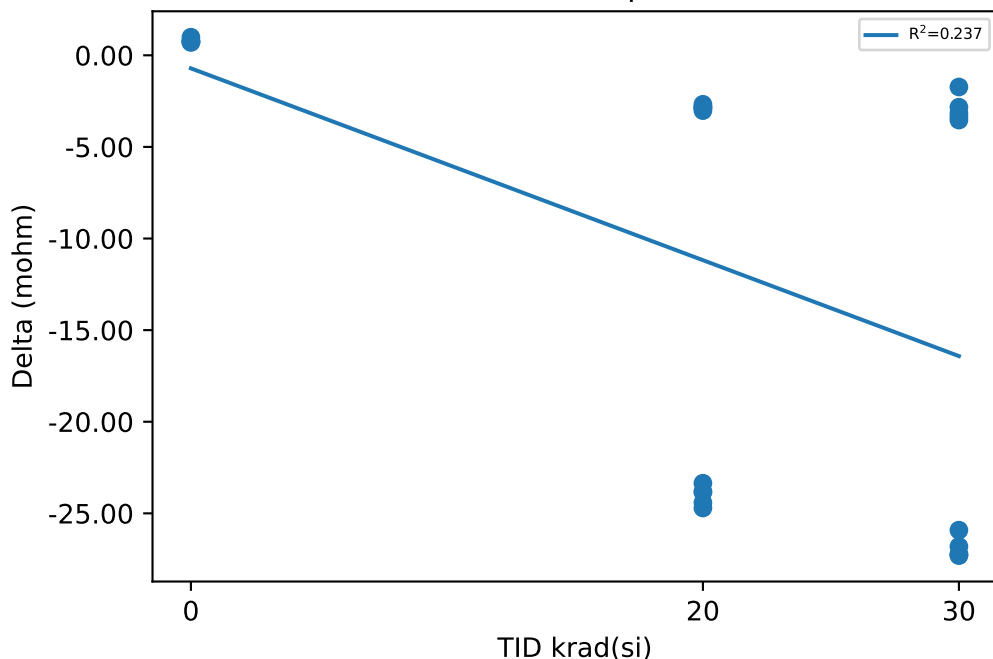

Test Statistics (mohm)

krad(si)	Pre Exposure Min	Pre Exposure Avg	Pre Exposure Max	Pre Exposure Std	Post Exposure Min	Post Exposure Avg	Post Exposure Max	Post Exposure Std	Min Delta	Avg Delta	Max Delta	Std Delta
0	157.37	157.92	158.41	0.47488	158.07	158.72	159.4	0.55581	0.7004	0.79138	0.9881	0.11314
20	156.51	158.09	159.43	0.83505	132.66	144.65	156.26	11.282	-24.709	-13.436	-2.6737	11.169
30	156.41	158.32	160.78	1.2226	131.32	143.41	155.54	11.994	-27.306	-14.914	-1.729	12.653

Device Test: 12.6 UJ4ZR4(RDSON_12V_OUT2_UJE410_UJ4ZR4)

TID vs Result Stats

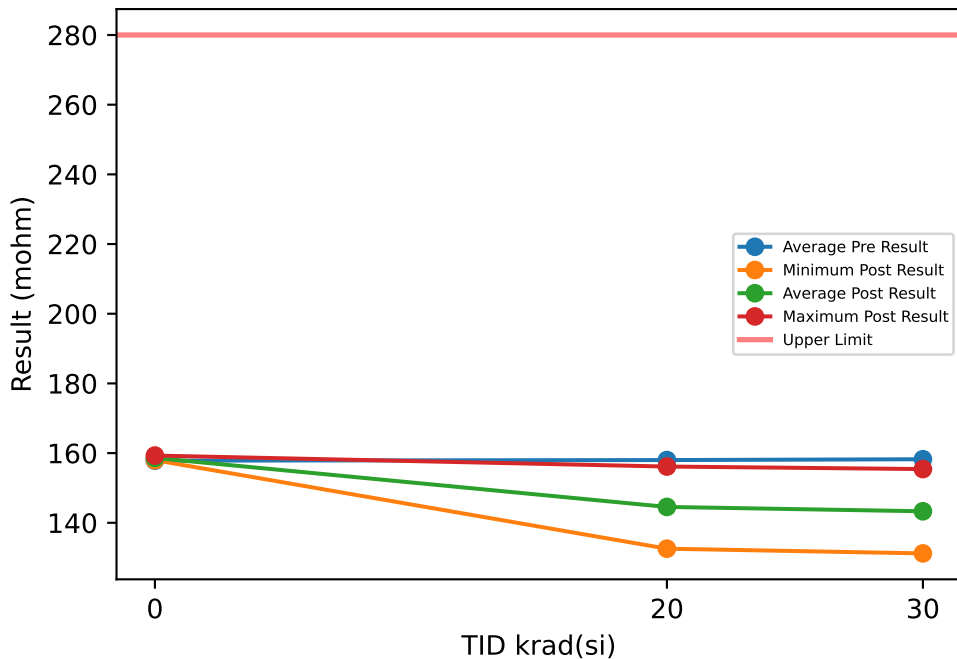

Test Results (Upper Limit = 280.0 (mohm))

Serial #	krad(si)	Exposure Conditions	Pre Result	Post Result	Delta
1	20	HDR unbiased	158.73	155.88	-2.8513
2	20	HDR unbiased	157.61	154.6	-3.0189
3	20	HDR unbiased	157.23	154.4	-2.828
4	20	HDR unbiased	158.03	155.08	-2.9459
5	20	HDR unbiased	158.84	156.14	-2.6917
6	20	HDR biased	157.88	134.53	-23.348
7	20	HDR biased	157.87	134.06	-23.815
8	20	HDR biased	156.44	132.57	-23.87
9	20	HDR biased	158.05	133.65	-24.398
10	20	HDR biased	159.37	134.63	-24.736
11	30	HDR unbiased	156.34	153.46	-2.8803
12	30	HDR unbiased	158.02	154.66	-3.3562
13	30	HDR unbiased	158.6	154.99	-3.6127
14	30	HDR unbiased	157.18	155.42	-1.7564
15	30	HDR unbiased	157.88	154.71	-3.167
16	30	HDR biased	159.12	131.84	-27.282
17	30	HDR biased	158.7	131.91	-26.783
18	30	HDR biased	160.71	133.39	-27.316
19	30	HDR biased	158.71	131.47	-27.241
20	30	HDR biased	157.16	131.22	-25.938
21	0	correlation	158.31	159.3	0.9934
22	0	correlation	157.45	158.22	0.7674
23	0	correlation	158.32	159.07	0.7511
24	0	correlation	157.78	158.51	0.7304
25	0	correlation	157.33	157.98	0.6447

TID vs Post - Pre Exposure Delta

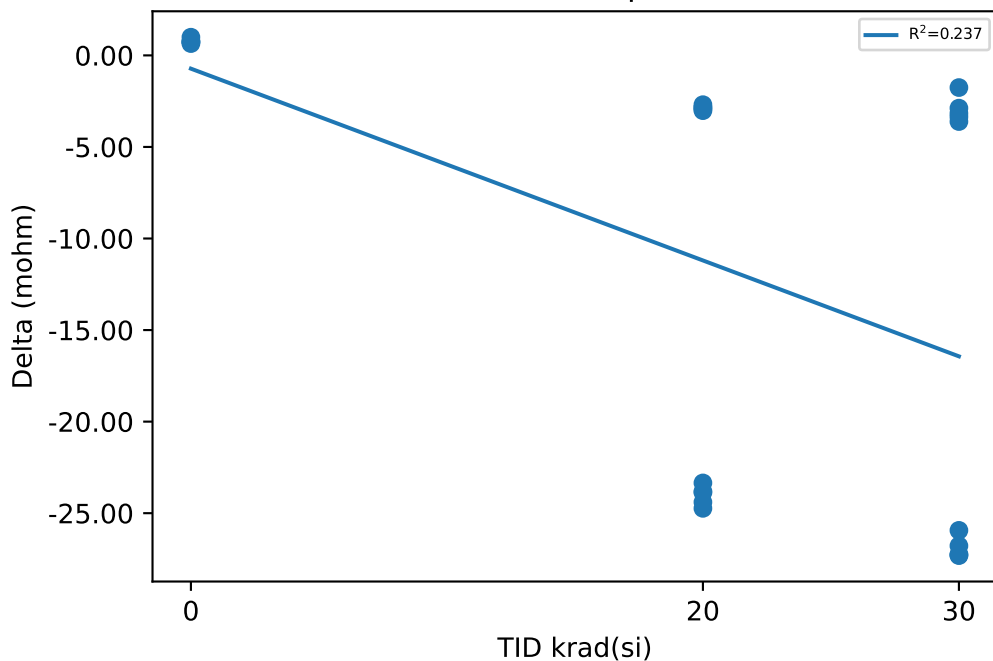

Test Statistics (mohm)

krad(si)	Pre Exposure Min	Pre Exposure Avg	Pre Exposure Max	Pre Exposure Std	Post Exposure Min	Post Exposure Avg	Post Exposure Max	Post Exposure Std	Min Delta	Avg Delta	Max Delta	Std Delta
0	157.33	157.84	158.32	0.46297	157.98	158.62	159.3	0.55863	0.6447	0.7774	0.9934	0.12968
20	156.44	158	159.37	0.83697	132.57	144.55	156.14	11.269	-24.736	-13.45	-2.6917	11.162
30	156.34	158.24	160.71	1.2264	131.22	143.31	155.42	11.978	-27.316	-14.933	-1.7564	12.642

Device Test: 12.7 UJ4ZR4(RDSON_28V_OUT2_UJE410_UJ4ZR4)

TID vs Result Stats

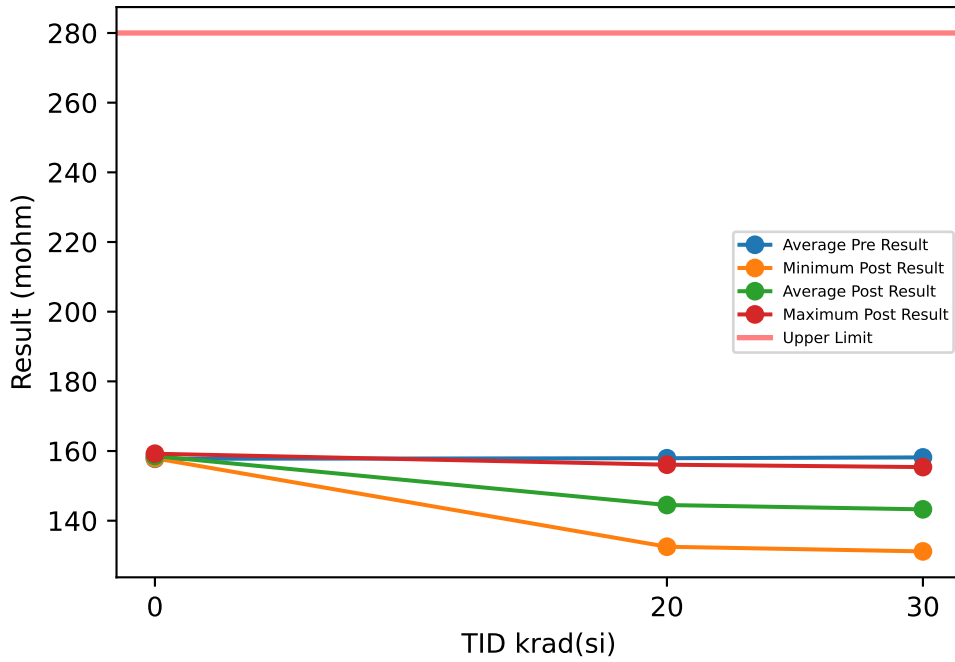

Test Results (Upper Limit = 280.0 (mohm))

Serial #	krad(si)	Exposure Conditions	Pre Result	Post Result	Delta
1	20	HDR unbiased	158.64	155.82	-2.8207
2	20	HDR unbiased	157.55	154.53	-3.0251
3	20	HDR unbiased	157.16	154.34	-2.8194
4	20	HDR unbiased	157.96	155	-2.957
5	20	HDR unbiased	158.78	156.07	-2.7033
6	20	HDR biased	157.8	134.49	-23.307
7	20	HDR biased	157.81	134.02	-23.786
8	20	HDR biased	156.36	132.53	-23.834
9	20	HDR biased	157.98	133.6	-24.385
10	20	HDR biased	159.29	134.58	-24.708
11	30	HDR unbiased	156.28	153.39	-2.8936
12	30	HDR unbiased	157.96	154.59	-3.3666
13	30	HDR unbiased	158.53	154.94	-3.5885
14	30	HDR unbiased	157.12	155.39	-1.7312
15	30	HDR unbiased	157.81	154.65	-3.1559
16	30	HDR biased	159.05	131.78	-27.267
17	30	HDR biased	158.63	131.88	-26.753
18	30	HDR biased	160.62	133.36	-27.256
19	30	HDR biased	158.64	131.42	-27.213
20	30	HDR biased	157.09	131.19	-25.901
21	0	correlation	158.22	159.23	1.0145
22	0	correlation	157.41	158.17	0.7633
23	0	correlation	158.26	158.99	0.7286
24	0	correlation	157.71	158.46	0.7527
25	0	correlation	157.26	157.91	0.6495

TID vs Post - Pre Exposure Delta

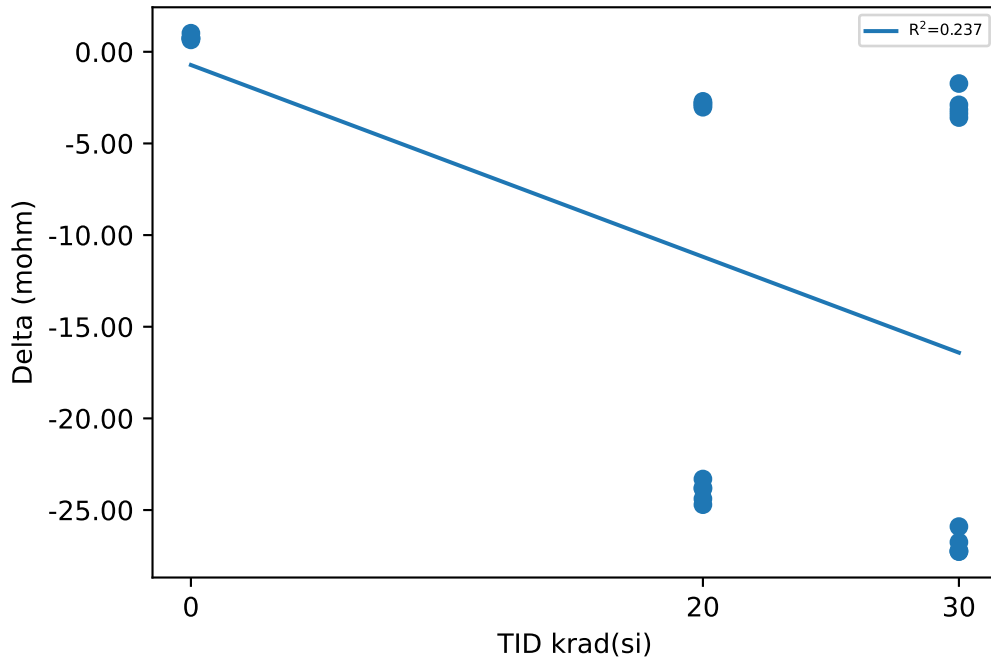

Test Statistics (mohm)

krad(si)	Pre Exposure Min	Pre Exposure Avg	Pre Exposure Max	Pre Exposure Std	Post Exposure Min	Post Exposure Avg	Post Exposure Max	Post Exposure Std	Min Delta	Avg Delta	Max Delta	Std Delta
0	157.26	157.77	158.26	0.45763	157.91	158.55	159.23	0.55277	0.6495	0.78172	1.0145	0.13754
20	156.36	157.93	159.29	0.83744	132.53	144.5	156.07	11.256	-24.708	-13.434	-2.7033	11.147
30	156.28	158.17	160.62	1.2172	131.19	143.26	155.39	11.97	-27.267	-14.913	-1.7312	12.628

Device Test: 12.8 UJ4ZR4(RDSON_32V_OUT2_UJE410_UJ4ZR4)

TID vs Result Stats

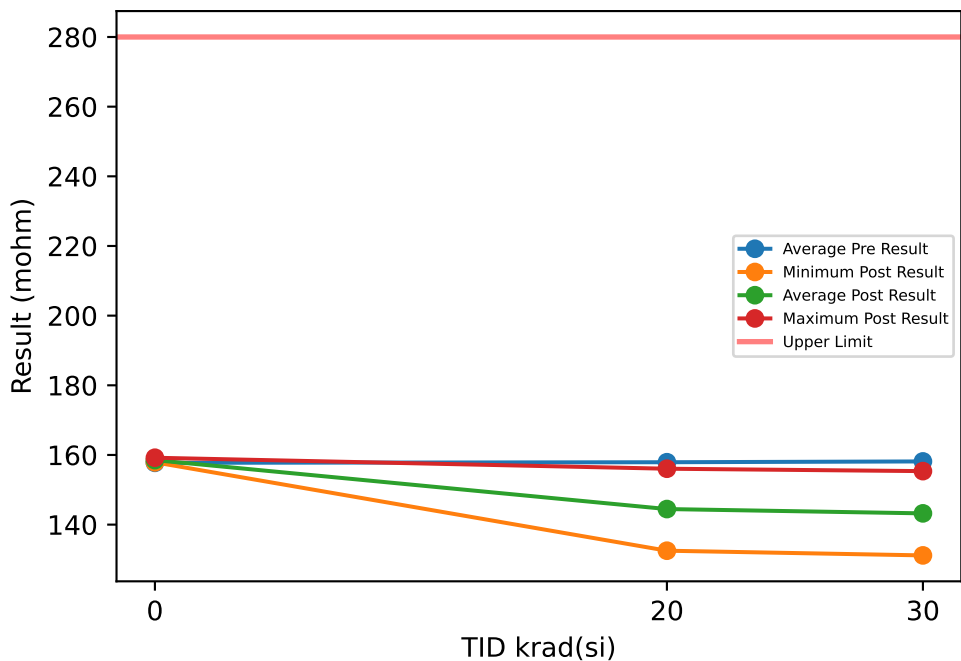

Test Results (Upper Limit = 280.0 (mohm))

Serial #	krad(si)	Exposure Conditions	Pre Result	Post Result	Delta
1	20	HDR unbiased	158.63	155.81	-2.8189
2	20	HDR unbiased	157.53	154.49	-3.0379
3	20	HDR unbiased	157.14	154.29	-2.8511
4	20	HDR unbiased	157.94	154.97	-2.9706
5	20	HDR unbiased	158.76	156.05	-2.708
6	20	HDR biased	157.78	134.47	-23.311
7	20	HDR biased	157.77	133.99	-23.783
8	20	HDR biased	156.35	132.51	-23.841
9	20	HDR biased	157.96	133.56	-24.394
10	20	HDR biased	159.28	134.56	-24.715
11	30	HDR unbiased	156.23	153.36	-2.8738
12	30	HDR unbiased	157.93	154.55	-3.3819
13	30	HDR unbiased	158.51	154.92	-3.5875
14	30	HDR unbiased	157.1	155.36	-1.7369
15	30	HDR unbiased	157.78	154.64	-3.1436
16	30	HDR biased	159.02	131.78	-27.239
17	30	HDR biased	158.62	131.83	-26.785
18	30	HDR biased	160.6	133.33	-27.265
19	30	HDR biased	158.6	131.39	-27.21
20	30	HDR biased	157.06	131.16	-25.894
21	0	correlation	158.19	159.21	1.0117
22	0	correlation	157.38	158.13	0.7583
23	0	correlation	158.23	158.97	0.7456
24	0	correlation	157.68	158.4	0.7195
25	0	correlation	157.22	157.88	0.66

TID vs Post - Pre Exposure Delta

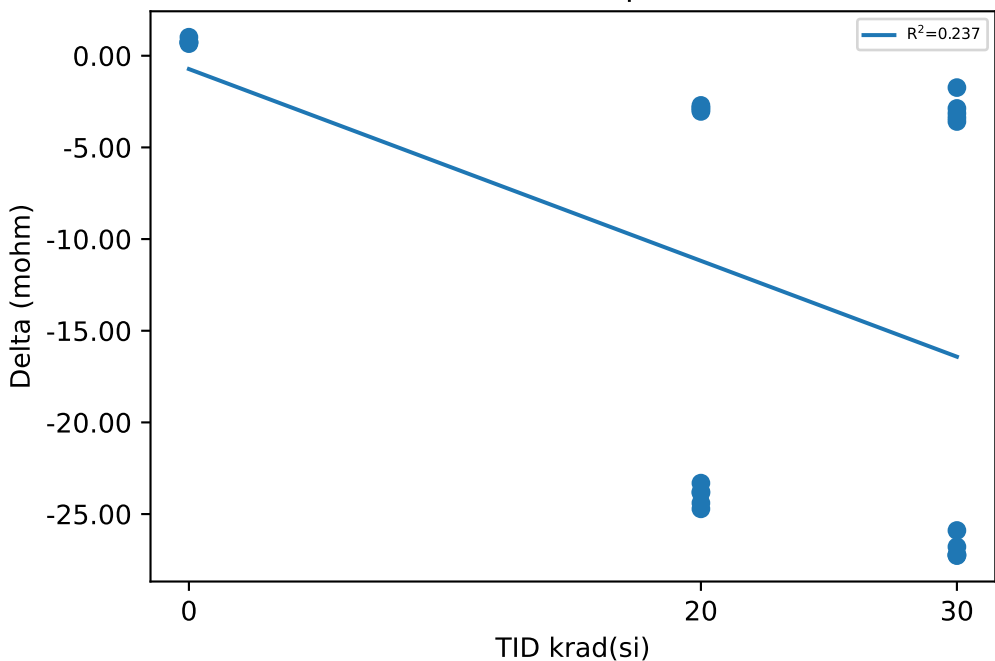

Test Statistics (mohm)

krad(si)	Pre Exposure Min	Pre Exposure Avg	Pre Exposure Max	Pre Exposure Std	Post Exposure Min	Post Exposure Avg	Post Exposure Max	Post Exposure Std	Min Delta	Avg Delta	Max Delta	Std Delta
0	157.22	157.74	158.23	0.45957	157.88	158.52	159.21	0.55712	0.66	0.77902	1.0117	0.13546
20	156.35	157.91	159.28	0.83744	132.51	144.47	156.05	11.255	-24.715	-13.443	-2.708	11.144
30	156.23	158.14	160.6	1.2226	131.16	143.23	155.36	11.969	-27.265	-14.912	-1.7369	12.629

Device Test: 12.9 UJ4ZR4(RDSON_5V_OUT3_UJE410_UJ4ZR4)

TID vs Result Stats

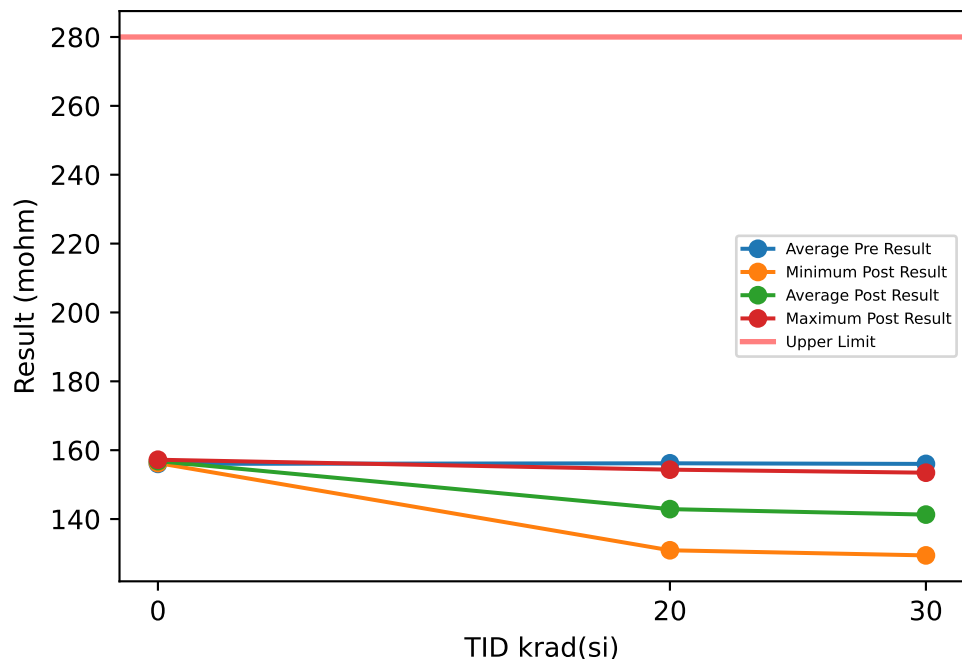

Test Results (Upper Limit = 280.0 (mohm))

Serial #	krad(si)	Exposure Conditions	Pre Result	Post Result	Delta
1	20	HDR unbiased	157.12	154.14	-2.982
2	20	HDR unbiased	156.17	153.14	-3.0274
3	20	HDR unbiased	155.1	152.22	-2.8777
4	20	HDR unbiased	156.27	153.38	-2.8846
5	20	HDR unbiased	156.9	154.35	-2.5567
6	20	HDR biased	156.66	132.62	-24.034
7	20	HDR biased	155.2	131.76	-23.447
8	20	HDR biased	154.4	130.93	-23.469
9	20	HDR biased	157	132.62	-24.381
10	20	HDR biased	157.09	133.67	-23.42
11	30	HDR unbiased	154.22	151.46	-2.7553
12	30	HDR unbiased	155.71	152.23	-3.4736
13	30	HDR unbiased	157.15	153.46	-3.6892
14	30	HDR unbiased	155.32	153.37	-1.9489
15	30	HDR unbiased	155.81	152.7	-3.1107
16	30	HDR biased	157.21	130.45	-26.76
17	30	HDR biased	156.2	129.65	-26.556
18	30	HDR biased	156.76	130.42	-26.345
19	30	HDR biased	156.61	129.77	-26.844
20	30	HDR biased	155.18	129.44	-25.735
21	0	correlation	155.98	156.99	1.0095
22	0	correlation	155.42	156.26	0.8363
23	0	correlation	156.47	157.23	0.7582
24	0	correlation	156.32	157.03	0.7154
25	0	correlation	155.91	156.57	0.6539

TID vs Post - Pre Exposure Delta

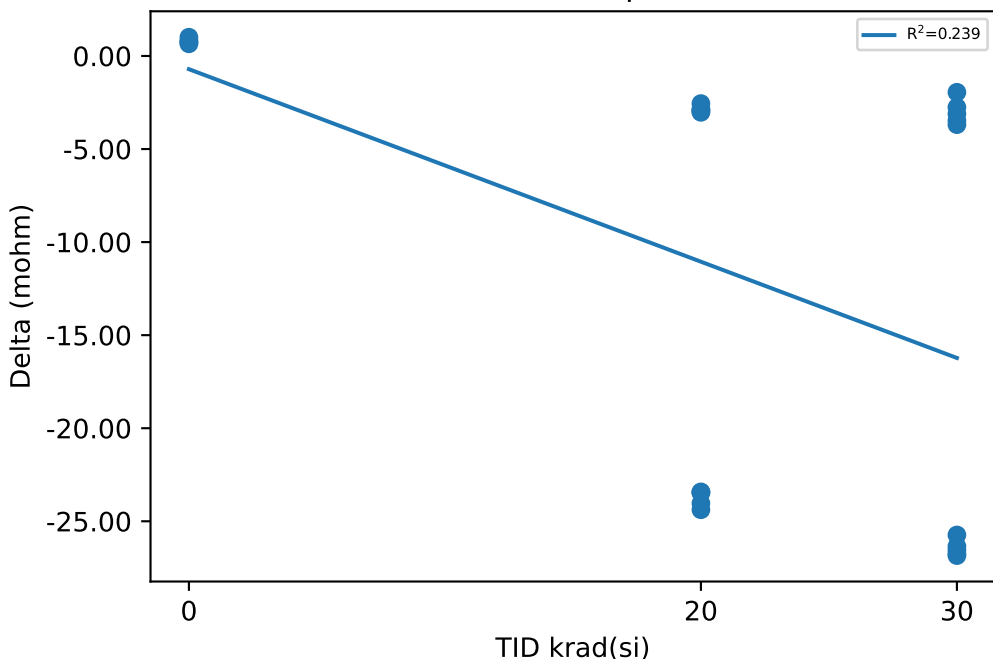

Test Statistics (mohm)

krad(si)	Pre Exposure Min	Pre Exposure Avg	Pre Exposure Max	Pre Exposure Std	Post Exposure Min	Post Exposure Avg	Post Exposure Max	Post Exposure Std	Min Delta	Avg Delta	Max Delta	Std Delta
0	155.42	156.02	156.47	0.40819	156.26	156.82	157.23	0.39536	0.6539	0.79466	1.0095	0.13722
20	154.4	156.19	157.12	0.96838	130.93	142.88	154.35	11.17	-24.381	-13.308	-2.5567	11.012
30	154.22	156.02	157.21	0.95562	129.44	141.29	153.46	11.981	-26.844	-14.722	-1.9489	12.373

Device Test: 14.2 UJUUDV(VDS_CLAMP_CH1_UJUUDV)

TID vs Result Stats

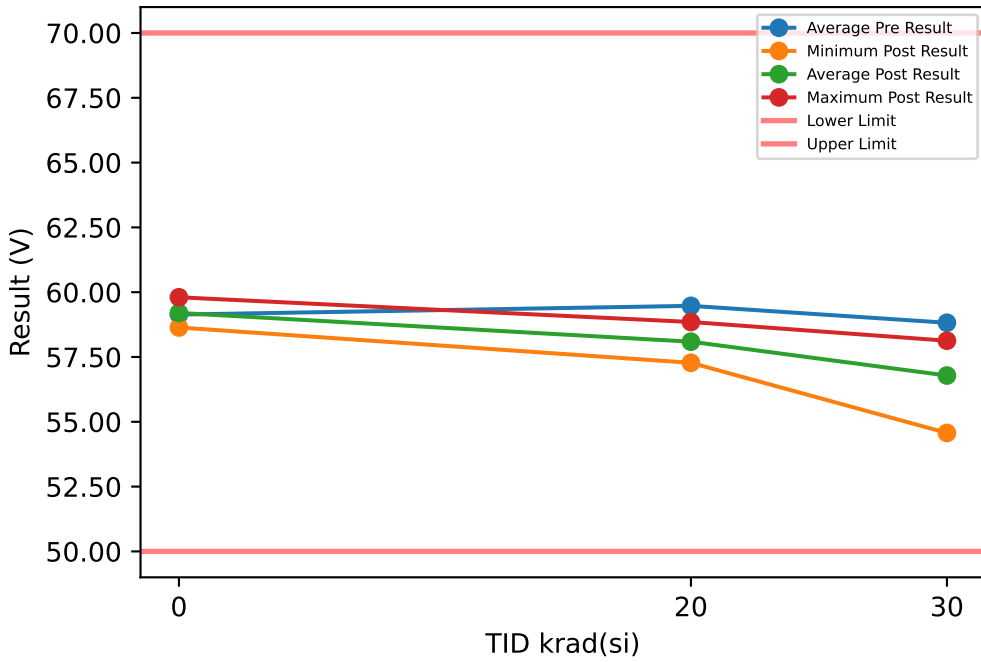

Test Results (Lower Limit = 50.0, Upper Limit = 70.0 (V))

Serial #	krad(si)	Exposure Conditions	Pre Result	Post Result	Delta
1	20	HDR unbiased	60.086	58.851	-1.235
2	20	HDR unbiased	59.751	58.464	-1.287
3	20	HDR unbiased	58.78	57.507	-1.273
4	20	HDR unbiased	59.798	58.489	-1.309
5	20	HDR unbiased	59.775	58.322	-1.453
6	20	HDR biased	60.168	57.276	-2.892
7	20	HDR biased	59.209	57.794	-1.415
8	20	HDR biased	58.98	57.52	-1.46
9	20	HDR biased	59.596	57.927	-1.669
10	20	HDR biased	58.592	58.759	0.167
11	30	HDR unbiased	58.647	57.384	-1.263
12	30	HDR unbiased	58.856	57.16	-1.696
13	30	HDR unbiased	59.772	58.128	-1.644
14	30	HDR unbiased	59.542	57.933	-1.609
15	30	HDR unbiased	58.868	57.213	-1.655
16	30	HDR biased	59.218	57.321	-1.897
17	30	HDR biased	58.007	56.206	-1.801
18	30	HDR biased	56.229	54.57	-1.659
19	30	HDR biased	59.858	54.661	-5.197
20	30	HDR biased	59.216	57.275	-1.941
21	0	correlation	58.586	58.639	0.053
22	0	correlation	58.803	58.874	0.071
23	0	correlation	59.739	59.804	0.065
24	0	correlation	59.338	59.394	0.056
25	0	correlation	59.217	59.289	0.072

TID vs Post - Pre Exposure Delta

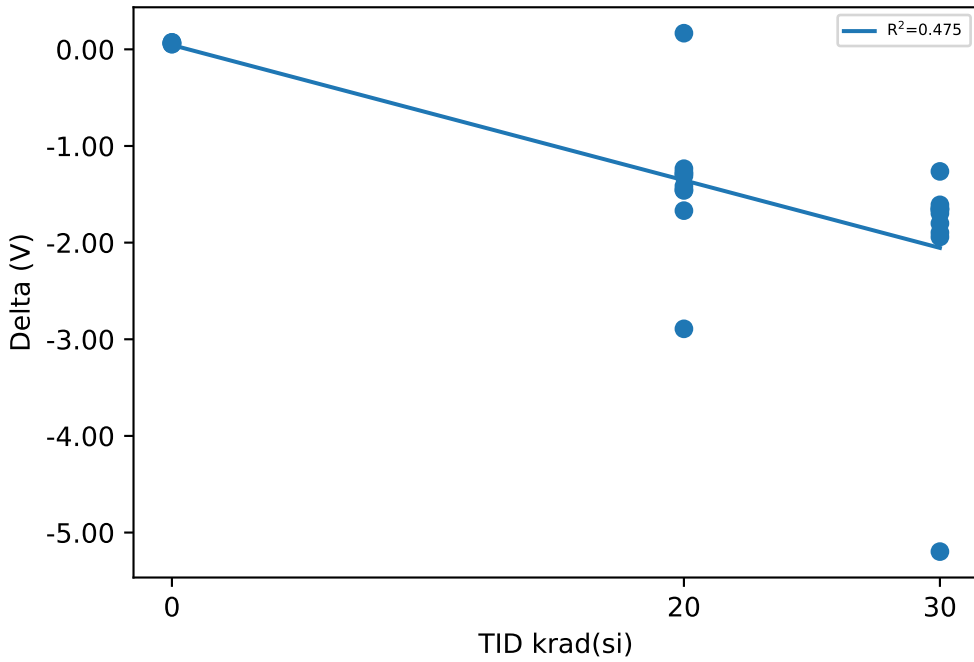

Test Statistics (V)

krad(si)	Pre Exposure Min	Pre Exposure Avg	Pre Exposure Max	Pre Exposure Std	Post Exposure Min	Post Exposure Avg	Post Exposure Max	Post Exposure Std	Min Delta	Avg Delta	Max Delta	Std Delta
0	58.586	59.137	59.739	0.45397	58.639	59.2	59.804	0.4559	0.053	0.0634	0.072	0.0086197
20	58.592	59.474	60.168	0.54946	57.276	58.091	58.851	0.55988	-2.892	-1.3826	0.167	0.73196
30	56.229	58.821	59.858	1.066	54.57	56.785	58.128	1.251	-5.197	-2.0362	-1.263	1.1261

Device Test: 14.4 UJUUDV(VDS_CLAMP_CH2_UJUUDV)

TID vs Result Stats

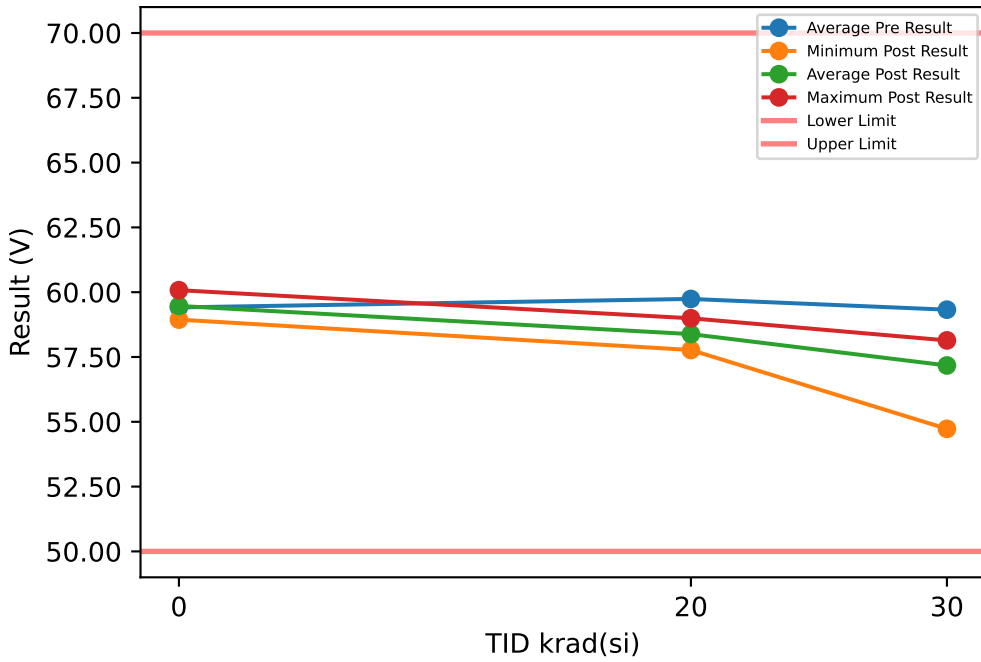

Test Results (Lower Limit = 50.0, Upper Limit = 70.0 (V))

Serial #	krad(si)	Exposure Conditions	Pre Result	Post Result	Delta
1	20	HDR unbiased	60.126	58.9	-1.226
2	20	HDR unbiased	60.205	58.994	-1.211
3	20	HDR unbiased	59.402	58.041	-1.361
4	20	HDR unbiased	60.017	58.821	-1.196
5	20	HDR unbiased	59.378	58.077	-1.301
6	20	HDR biased	59.857	58.051	-1.806
7	20	HDR biased	59.844	58.322	-1.522
8	20	HDR biased	59.844	58.251	-1.593
9	20	HDR biased	59.224	57.77	-1.454
10	20	HDR biased	59.501	58.607	-0.894
11	30	HDR unbiased	59.232	57.835	-1.397
12	30	HDR unbiased	59.745	57.9	-1.845
13	30	HDR unbiased	59.866	58.14	-1.726
14	30	HDR unbiased	59.464	57.747	-1.717
15	30	HDR unbiased	59.755	57.907	-1.848
16	30	HDR biased	59.836	57.673	-2.163
17	30	HDR biased	58.992	56.922	-2.07
18	30	HDR biased	57.176	55.246	-1.93
19	30	HDR biased	59.414	54.729	-4.685
20	30	HDR biased	59.779	57.635	-2.144
21	0	correlation	59.086	59.145	0.059
22	0	correlation	59.724	59.802	0.078
23	0	correlation	59.332	59.382	0.05
24	0	correlation	60.037	60.078	0.041
25	0	correlation	58.887	58.942	0.055

TID vs Post - Pre Exposure Delta

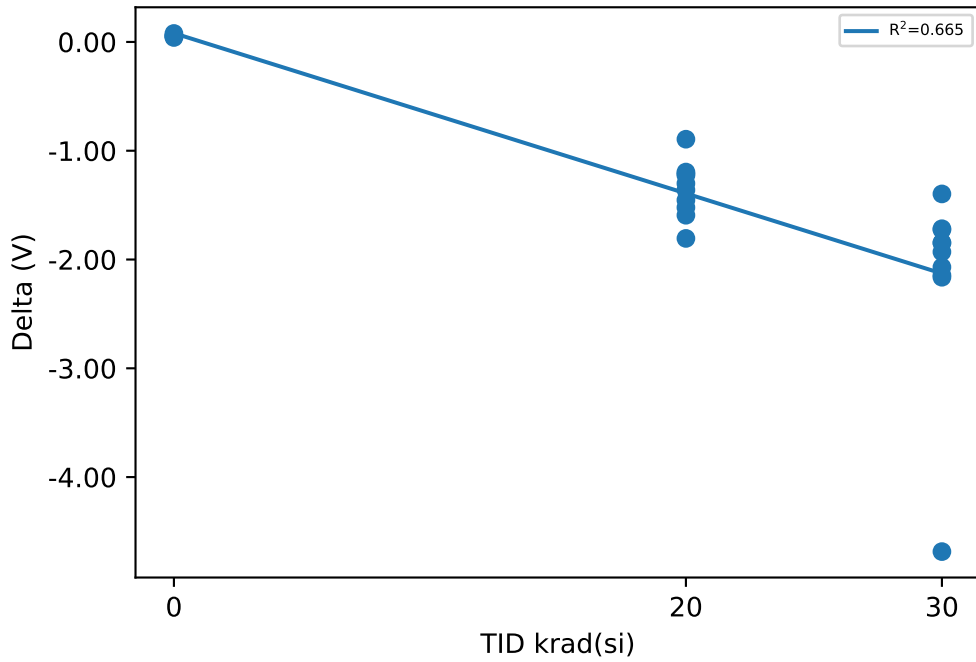

Test Statistics (V)

krad(si)	Pre Exposure Min	Pre Exposure Avg	Pre Exposure Max	Pre Exposure Std	Post Exposure Min	Post Exposure Avg	Post Exposure Max	Post Exposure Std	Min Delta	Avg Delta	Max Delta	Std Delta
0	58.887	59.413	60.037	0.46804	58.942	59.47	60.078	0.46692	0.041	0.0566	0.078	0.013722
20	59.224	59.74	60.205	0.3409	57.77	58.383	58.994	0.42169	-1.806	-1.3564	-0.894	0.25295
30	57.176	59.326	59.866	0.80872	54.729	57.173	58.14	1.2011	-4.685	-2.1525	-1.397	0.91892

Device Test: 14.6 UJUUDV(VDS_CLAMP_CH3_UJUUDV)

TID vs Result Stats

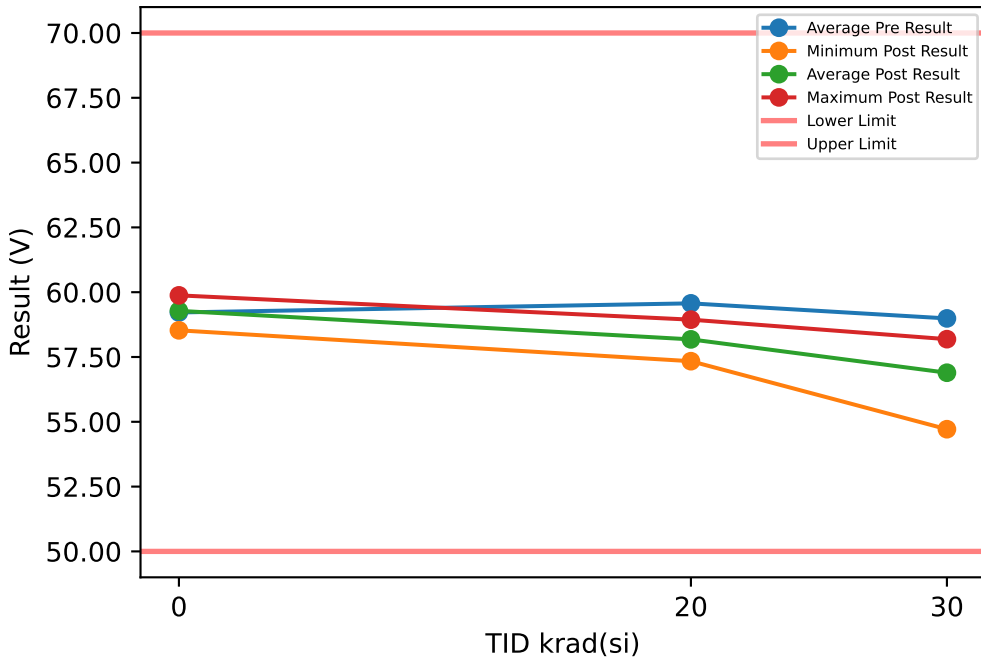

Test Results (Lower Limit = 50.0, Upper Limit = 70.0 (V))

Serial #	krad(si)	Exposure Conditions	Pre Result	Post Result	Delta
1	20	HDR unbiased	60.3	58.941	-1.359
2	20	HDR unbiased	59.956	58.692	-1.264
3	20	HDR unbiased	58.953	57.68	-1.273
4	20	HDR unbiased	59.868	58.537	-1.331
5	20	HDR unbiased	59.773	58.327	-1.446
6	20	HDR biased	60.075	57.338	-2.737
7	20	HDR biased	59.055	57.651	-1.404
8	20	HDR biased	59.149	57.705	-1.444
9	20	HDR biased	59.893	58.222	-1.671
10	20	HDR biased	58.675	58.707	0.032
11	30	HDR unbiased	58.456	57.155	-1.301
12	30	HDR unbiased	59.173	57.431	-1.742
13	30	HDR unbiased	59.881	58.188	-1.693
14	30	HDR unbiased	59.884	57.969	-1.915
15	30	HDR unbiased	59.254	57.612	-1.642
16	30	HDR biased	59.05	57.152	-1.898
17	30	HDR biased	58.469	56.616	-1.853
18	30	HDR biased	56.624	54.865	-1.759
19	30	HDR biased	59.867	54.714	-5.153
20	30	HDR biased	59.23	57.23	-2
21	0	correlation	58.456	58.529	0.073
22	0	correlation	59.075	59.141	0.066
23	0	correlation	59.82	59.878	0.058
24	0	correlation	59.5	59.563	0.063
25	0	correlation	59.238	59.295	0.057

TID vs Post - Pre Exposure Delta

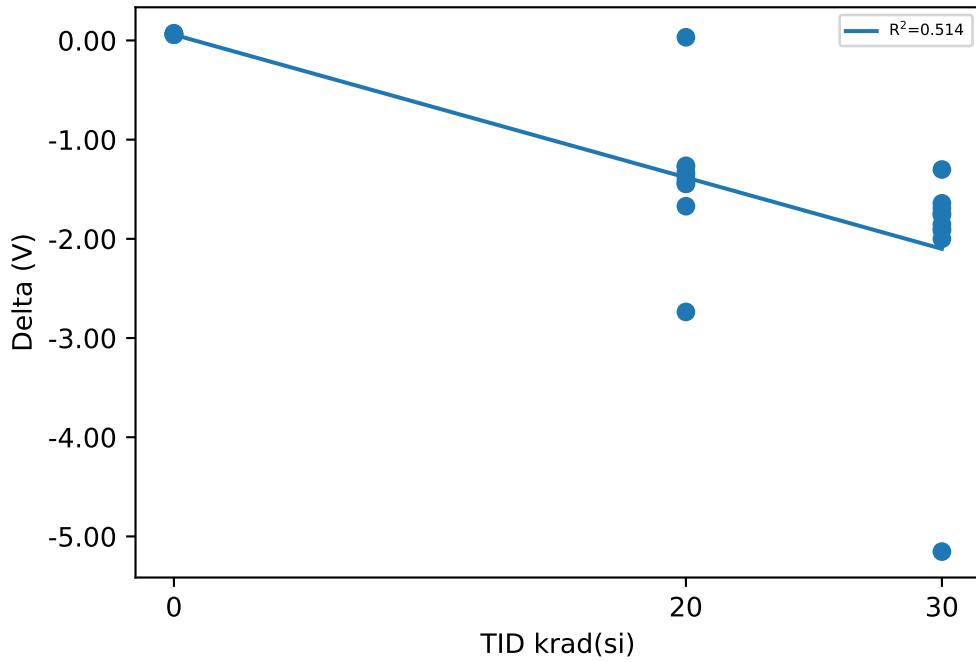

Test Statistics (V)

krad(si)	Pre Exposure Min	Pre Exposure Avg	Pre Exposure Max	Pre Exposure Std	Post Exposure Min	Post Exposure Avg	Post Exposure Max	Post Exposure Std	Min Delta	Avg Delta	Max Delta	Std Delta
0	58.456	59.218	59.82	0.51074	58.529	59.281	59.878	0.50528	0.057	0.0634	0.073	0.0065038
20	58.675	59.57	60.3	0.55732	57.338	58.18	58.941	0.55119	-2.737	-1.3897	0.032	0.66297
30	56.624	58.989	59.884	0.98213	54.714	56.893	58.188	1.1939	-5.153	-2.0956	-1.301	1.0916

Device Test: 14.8 UJUUDV(VDS_CLAMP_CH4_UJUUDV)

TID vs Result Stats

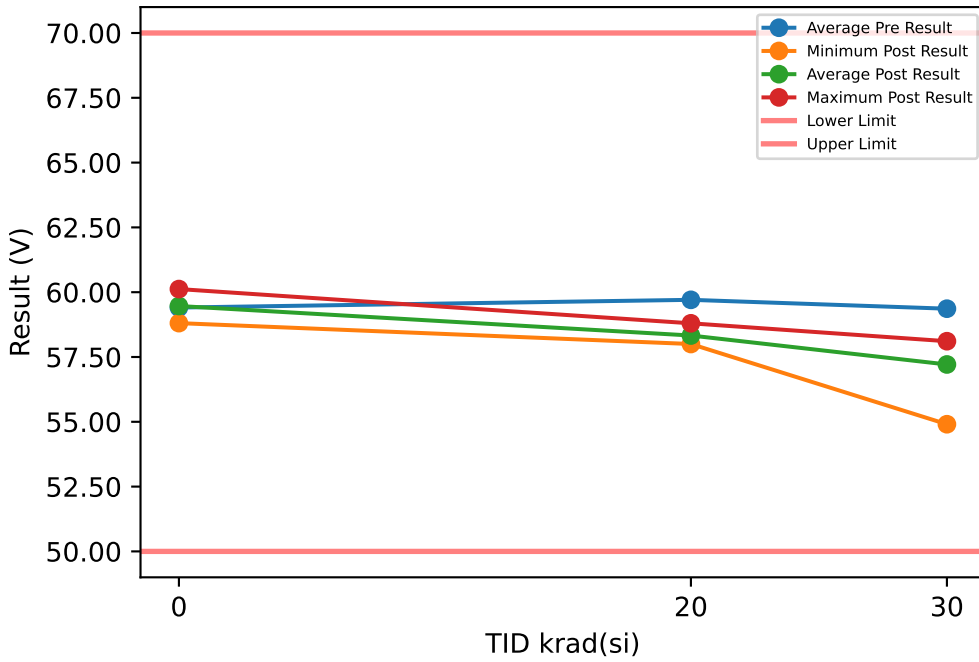

Test Results (Lower Limit = 50.0, Upper Limit = 70.0 (V))

Serial #	krad(si)	Exposure Conditions	Pre Result	Post Result	Delta
1	20	HDR unbiased	59.779	58.532	-1.247
2	20	HDR unbiased	60.093	58.8	-1.293
3	20	HDR unbiased	59.592	58.252	-1.34
4	20	HDR unbiased	59.981	58.718	-1.263
5	20	HDR unbiased	59.485	58.192	-1.293
6	20	HDR biased	59.716	58.001	-1.715
7	20	HDR biased	59.595	58.041	-1.554
8	20	HDR biased	59.703	58.153	-1.55
9	20	HDR biased	59.632	58.153	-1.479
10	20	HDR biased	59.479	58.446	-1.033
11	30	HDR unbiased	59.14	57.701	-1.439
12	30	HDR unbiased	59.819	57.925	-1.894
13	30	HDR unbiased	59.742	58.022	-1.72
14	30	HDR unbiased	59.742	57.729	-2.013
15	30	HDR unbiased	59.904	58.109	-1.795
16	30	HDR biased	59.594	57.466	-2.128
17	30	HDR biased	59.094	57.077	-2.017
18	30	HDR biased	57.483	55.546	-1.937
19	30	HDR biased	59.422	54.906	-4.516
20	30	HDR biased	59.696	57.637	-2.059
21	0	correlation	59.193	59.261	0.068
22	0	correlation	59.532	59.597	0.065
23	0	correlation	59.496	59.55	0.054
24	0	correlation	60.059	60.121	0.062
25	0	correlation	58.758	58.807	0.049

TID vs Post - Pre Exposure Delta

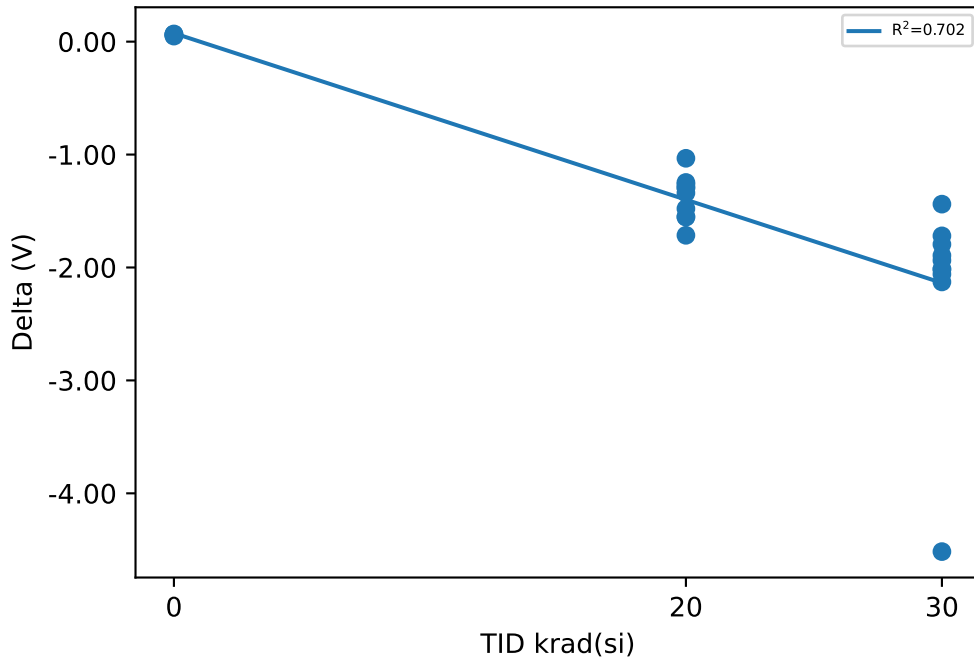

Test Statistics (V)

krad(si)	Pre Exposure Min	Pre Exposure Avg	Pre Exposure Max	Pre Exposure Std	Post Exposure Min	Post Exposure Avg	Post Exposure Max	Post Exposure Std	Min Delta	Avg Delta	Max Delta	Std Delta
0	58.758	59.408	60.059	0.47845	58.807	59.467	60.121	0.48206	0.049	0.0596	0.068	0.007893
20	59.479	59.706	60.093	0.20055	58.001	58.329	58.8	0.27993	-1.715	-1.3767	-1.033	0.1971
30	57.483	59.364	59.904	0.71586	54.906	57.212	58.109	1.0971	-4.516	-2.1518	-1.439	0.85443

Device Test: 15.1 UJ33GQ(TON_DELAY_CH1_UJ33GQ)

TID vs Result Stats

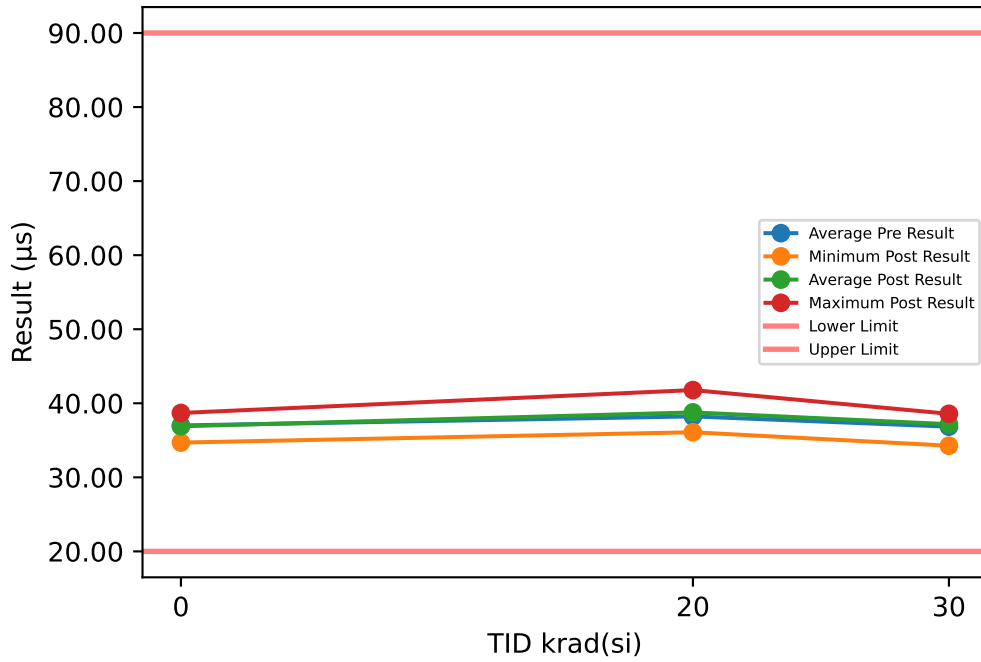

Test Results (Lower Limit = 20.0, Upper Limit = 90.0 (µs))

Serial #	krad(si)	Exposure Conditions	Pre Result	Post Result	Delta
1	20	HDR unbiased	39.509	39.812	0.3023
2	20	HDR unbiased	38.307	38.344	0.037
3	20	HDR unbiased	37.901	38.94	1.0388
4	20	HDR unbiased	38.877	39.313	0.4363
5	20	HDR unbiased	36.654	36.088	-0.566
6	20	HDR biased	36.872	37.502	0.6299
7	20	HDR biased	40.54	41.784	1.2441
8	20	HDR biased	36.572	37.462	0.8899
9	20	HDR biased	39.794	40.151	0.3566
10	20	HDR biased	37.245	38.283	1.0373
11	30	HDR unbiased	34.999	34.272	-0.727
12	30	HDR unbiased	37.483	37.919	0.4355
13	30	HDR unbiased	36.168	37.1	0.9321
14	30	HDR unbiased	38.501	37.188	-1.313
15	30	HDR unbiased	38.283	38.582	0.2985
16	30	HDR biased	37.73	38.186	0.4566
17	30	HDR biased	35.455	36.107	0.6518
18	30	HDR biased	37.417	37.884	0.4672
19	30	HDR biased	35.918	38.33	2.4114
20	30	HDR biased	36.459	36.229	-0.2306
21	0	correlation	36.839	36.825	-0.0142
22	0	correlation	38.025	37.95	-0.0745
23	0	correlation	38.536	38.69	0.1542
24	0	correlation	36.345	36.304	-0.0407
25	0	correlation	35.292	34.695	-0.5969

TID vs Post - Pre Exposure Delta

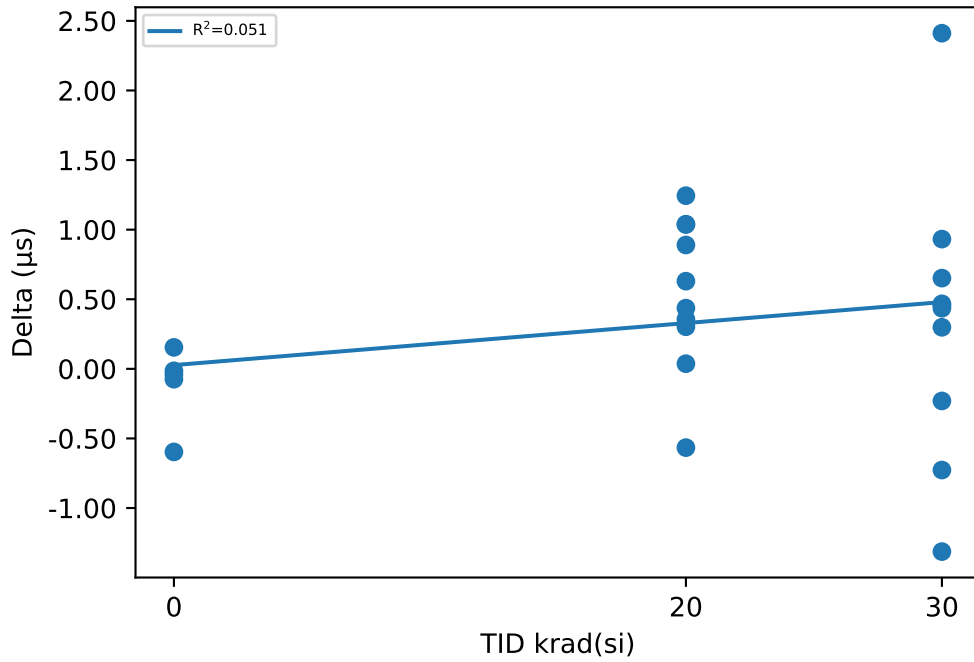

Test Statistics (µs)

krad(si)	Pre Exposure Min	Pre Exposure Avg	Pre Exposure Max	Pre Exposure Std	Post Exposure Min	Post Exposure Avg	Post Exposure Max	Post Exposure Std	Min Delta	Avg Delta	Max Delta	Std Delta
0	35.292	37.007	38.536	1.302	34.695	36.893	38.69	1.5435	-0.5969	-0.11442	0.1542	0.28373
20	36.572	38.227	40.54	1.414	36.088	38.768	41.784	1.61	-0.566	0.54062	1.2441	0.54767
30	34.999	36.841	38.501	1.2081	34.272	37.18	38.582	1.3276	-1.313	0.33825	2.4114	0.99864

Device Test: 15.10 UJP09Y(TRISE_CH2_UJP09Y)

TID vs Result Stats

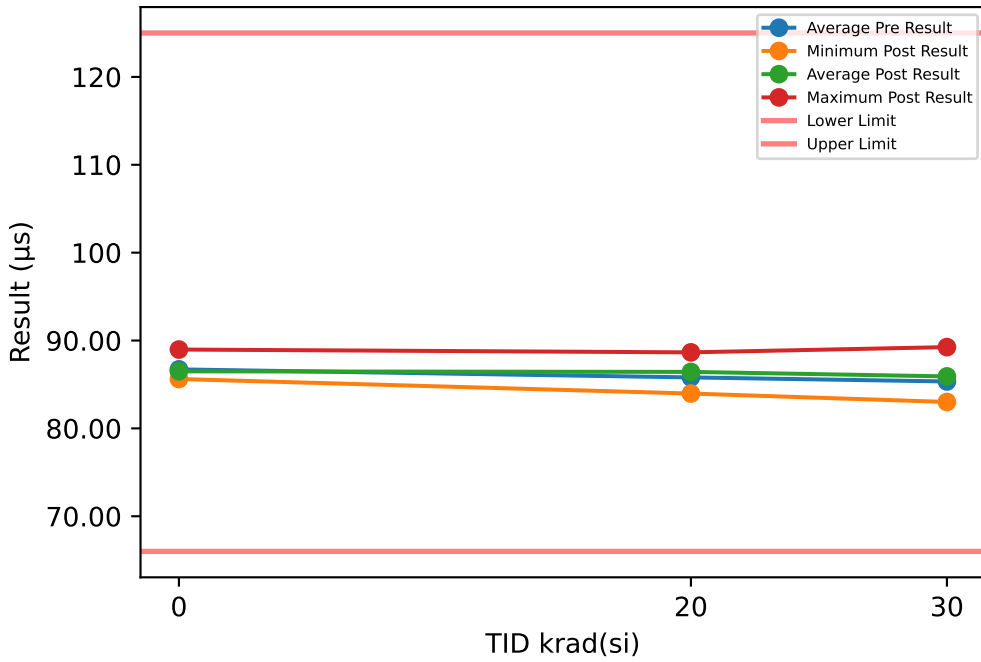

TID vs Post - Pre Exposure Delta

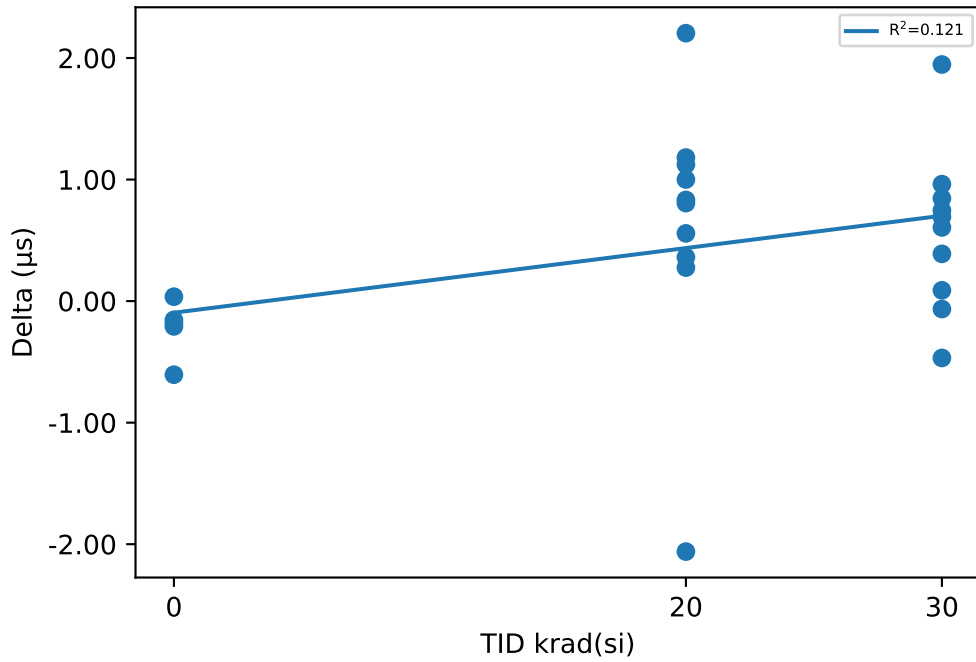

Test Results (Lower Limit = 66.0, Upper Limit = 125.0 (µs))

Serial #	krad(si)	Exposure Conditions	Pre Result	Post Result	Delta
1	20	HDR unbiased	85.547	86.353	0.8063
2	20	HDR unbiased	85.138	85.97	0.8324
3	20	HDR unbiased	87.652	88.653	1.0004
4	20	HDR unbiased	83.691	83.967	0.2756
5	20	HDR unbiased	84.147	84.508	0.3612
6	20	HDR biased	87.703	85.642	-2.0609
7	20	HDR biased	84.146	85.269	1.1238
8	20	HDR biased	85.937	87.119	1.1812
9	20	HDR biased	88.041	88.598	0.5571
10	20	HDR biased	86.008	88.212	2.2041
11	30	HDR unbiased	82.259	83.006	0.7471
12	30	HDR unbiased	88.556	89.249	0.6933
13	30	HDR unbiased	84.099	84.034	-0.0652
14	30	HDR unbiased	86.401	85.933	-0.4677
15	30	HDR unbiased	84.93	85.018	0.0887
16	30	HDR biased	87.623	88.229	0.6062
17	30	HDR biased	84.921	85.767	0.8454
18	30	HDR biased	83.223	84.185	0.962
19	30	HDR biased	85.505	87.451	1.9466
20	30	HDR biased	85.898	86.287	0.3886
21	0	correlation	86.323	86.139	-0.184
22	0	correlation	86.212	86.004	-0.2082
23	0	correlation	85.583	85.62	0.0361
24	0	correlation	89.58	88.974	-0.6055
25	0	correlation	85.884	85.73	-0.1548

Test Statistics (µs)

krad(si)	Pre Exposure Min	Pre Exposure Avg	Pre Exposure Max	Pre Exposure Std	Post Exposure Min	Post Exposure Avg	Post Exposure Max	Post Exposure Std	Min Delta	Avg Delta	Max Delta	Std Delta
0	85.583	86.716	89.58	1.6267	85.62	86.493	88.974	1.4024	-0.6055	-0.22328	0.0361	0.23443
20	83.691	85.801	88.041	1.5832	83.967	86.429	88.653	1.6747	-2.0609	0.62812	2.2041	1.0893
30	82.259	85.341	88.556	1.9112	83.006	85.916	89.249	1.9661	-0.4677	0.5745	1.9466	0.65972

Device Test: 15.11 UJ6AIM(TFALL_CH2_UJ6AIM)

TID vs Result Stats

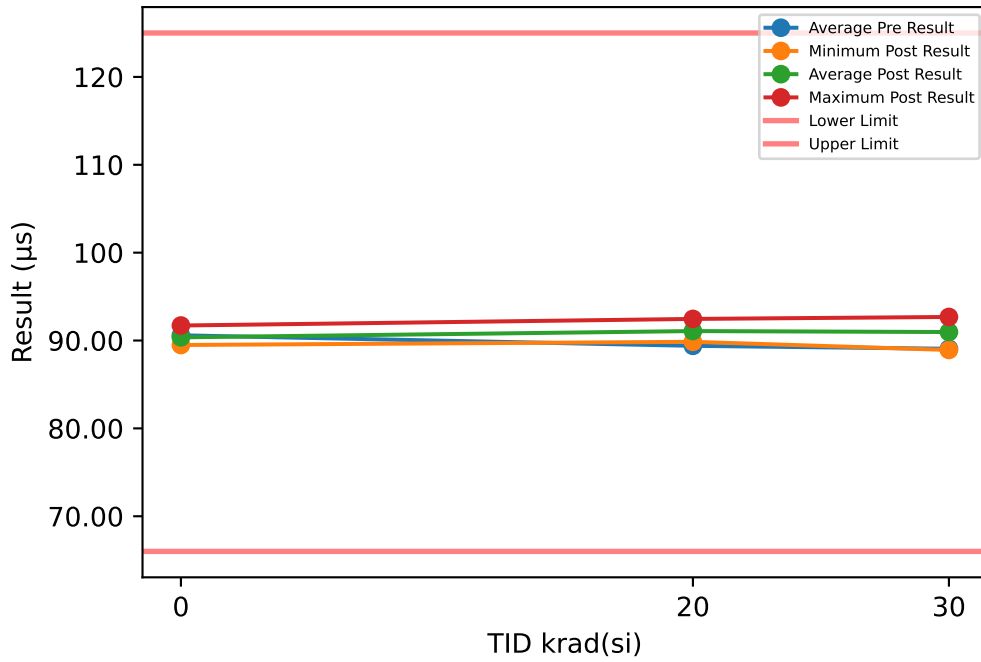

TID vs Post - Pre Exposure Delta

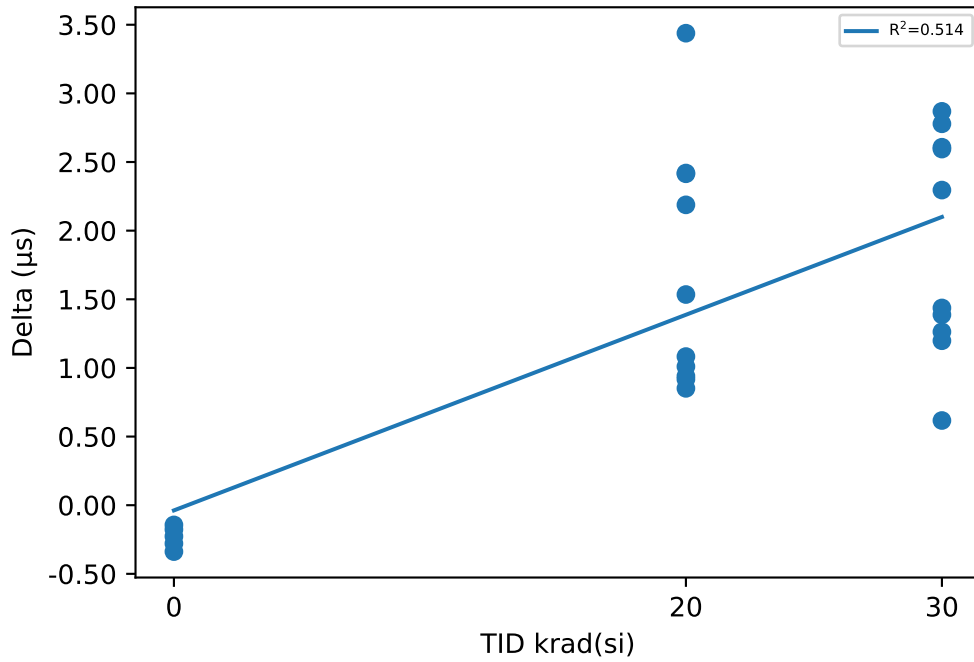

Test Results (Lower Limit = 66.0, Upper Limit = 125.0 (µs))

Serial #	krad(si)	Exposure Conditions	Pre Result	Post Result	Delta
1	20	HDR unbiased	90.036	90.977	0.9402
2	20	HDR unbiased	90.449	91.367	0.9175
3	20	HDR unbiased	91.375	92.458	1.0828
4	20	HDR unbiased	90.172	91.182	1.01
5	20	HDR unbiased	89.002	89.853	0.8512
6	20	HDR biased	89.668	91.203	1.5347
7	20	HDR biased	87.926	90.34	2.4143
8	20	HDR biased	87.867	90.287	2.4197
9	20	HDR biased	88.836	91.024	2.188
10	20	HDR biased	88.63	92.069	3.4384
11	30	HDR unbiased	90.948	92.336	1.3873
12	30	HDR unbiased	89.331	90.594	1.263
13	30	HDR unbiased	88.733	90.169	1.4369
14	30	HDR unbiased	87.694	90.563	2.8691
15	30	HDR unbiased	87.729	88.927	1.1981
16	30	HDR biased	89.005	91.613	2.6077
17	30	HDR biased	89.305	91.899	2.5943
18	30	HDR biased	88.233	91.011	2.7784
19	30	HDR biased	89.254	89.871	0.617
20	30	HDR biased	90.385	92.681	2.2956
21	0	correlation	91.935	91.708	-0.2269
22	0	correlation	90.215	89.936	-0.2793
23	0	correlation	89.667	89.49	-0.1767
24	0	correlation	90.419	90.081	-0.338
25	0	correlation	90.737	90.594	-0.1437

Test Statistics (µs)

krad(si)	Pre Exposure Min	Pre Exposure Avg	Pre Exposure Max	Pre Exposure Std	Post Exposure Min	Post Exposure Avg	Post Exposure Max	Post Exposure Std	Min Delta	Avg Delta	Max Delta	Std Delta
0	89.667	90.595	91.935	0.84444	89.49	90.362	91.708	0.84941	-0.338	-0.23292	-0.1437	0.078023
20	87.867	89.396	91.375	1.1385	89.853	91.076	92.458	0.79441	0.8512	1.6797	3.4384	0.88686
30	87.694	89.062	90.948	1.0501	88.927	90.966	92.681	1.1737	0.617	1.9047	2.8691	0.80772

Device Test: 15.12 UJPEEL(SLEWRATE_ON_CH2_UJPEEL)

TID vs Result Stats

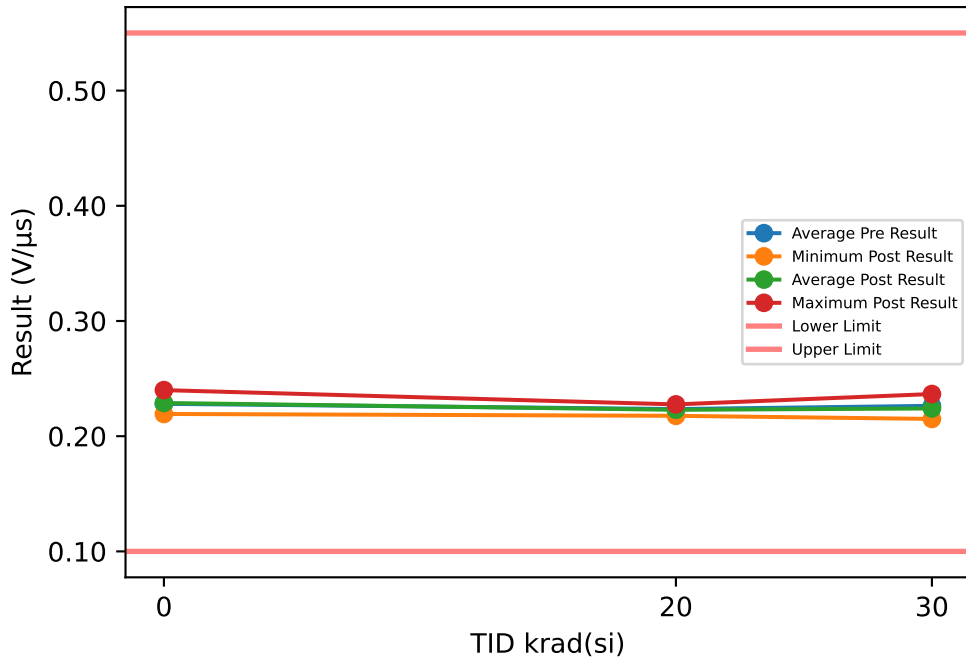

Test Results (Lower Limit = 0.1, Upper Limit = 0.55 (V/μs))

Serial #	krad(si)	Exposure Conditions	Pre Result	Post Result	Delta
1	20	HDR unbiased	0.2275	0.2254	-0.0021
2	20	HDR unbiased	0.2241	0.2236	-0.0005
3	20	HDR unbiased	0.2244	0.2242	-0.0002
4	20	HDR unbiased	0.2296	0.2276	-0.002
5	20	HDR unbiased	0.2246	0.2241	-0.0005
6	20	HDR biased	0.219	0.2199	0.0009
7	20	HDR biased	0.2286	0.2261	-0.0025
8	20	HDR biased	0.2199	0.2197	-0.0002
9	20	HDR biased	0.2186	0.2177	-0.0009
10	20	HDR biased	0.2193	0.2208	0.0015
11	30	HDR unbiased	0.2306	0.229	-0.0016
12	30	HDR unbiased	0.2176	0.215	-0.0026
13	30	HDR unbiased	0.2267	0.2273	0.0006
14	30	HDR unbiased	0.2238	0.2233	-0.0005
15	30	HDR unbiased	0.2241	0.2224	-0.0017
16	30	HDR biased	0.2228	0.2208	-0.002
17	30	HDR biased	0.2246	0.2211	-0.0035
18	30	HDR biased	0.2409	0.2366	-0.0043
19	30	HDR biased	0.2252	0.2228	-0.0024
20	30	HDR biased	0.2273	0.2224	-0.0049
21	0	correlation	0.2385	0.24	0.0015
22	0	correlation	0.2275	0.2286	0.0011
23	0	correlation	0.2288	0.2286	-0.0002
24	0	correlation	0.2191	0.2193	0.0002
25	0	correlation	0.2267	0.2277	0.001

TID vs Post - Pre Exposure Delta

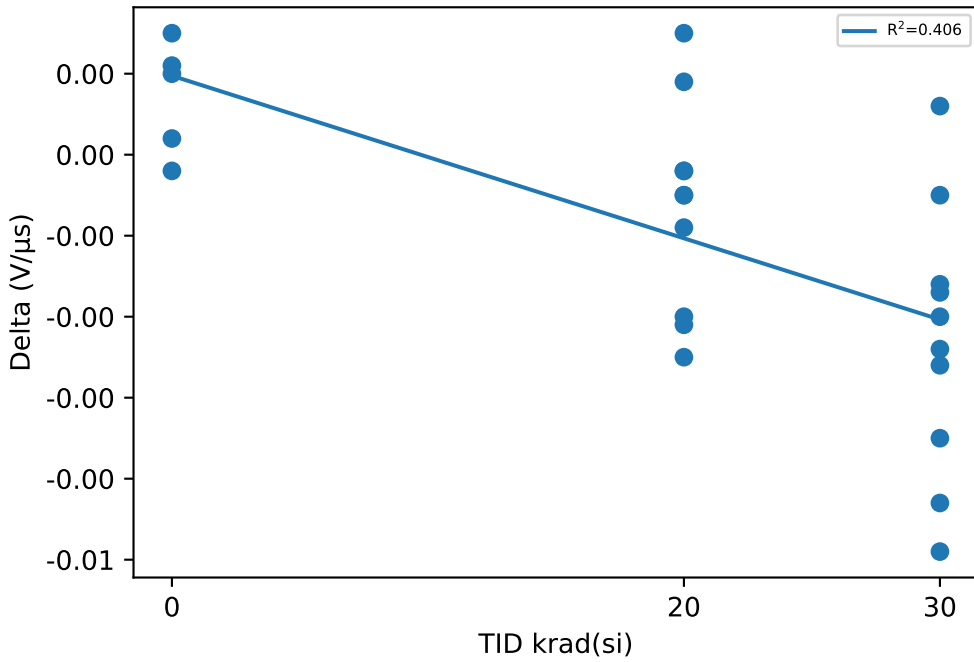

Test Statistics (V/μs)

krad(si)	Pre Exposure Min	Pre Exposure Avg	Pre Exposure Max	Pre Exposure Std	Post Exposure Min	Post Exposure Avg	Post Exposure Max	Post Exposure Std	Min Delta	Avg Delta	Max Delta	Std Delta
0	0.2191	0.22812	0.2385	0.0069276	0.2193	0.22884	0.24	0.007365	-0.0002	0.00072	0.0015	0.00069785
20	0.2186	0.22356	0.2296	0.004169	0.2177	0.22291	0.2276	0.0032126	-0.0025	-0.00065	0.0015	0.001286
30	0.2176	0.22636	0.2409	0.0061092	0.215	0.22407	0.2366	0.005786	-0.0049	-0.00229	0.0006	0.001663

Device Test: 15.13 UJD80I(SLEWRATE_OFF_CH2_UJD80I)

TID vs Result Stats

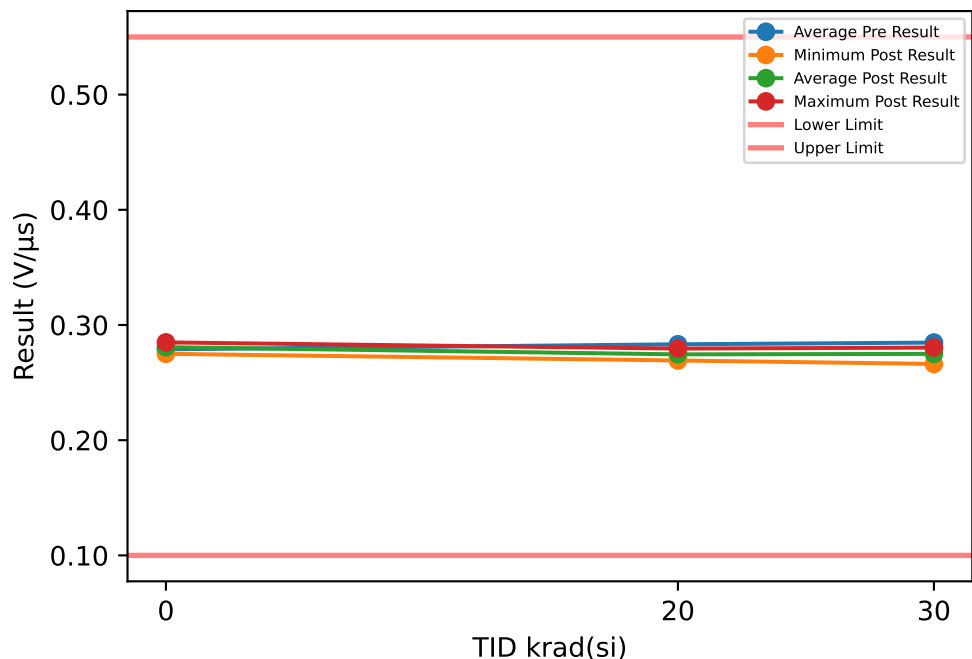

Test Results (Lower Limit = 0.1, Upper Limit = 0.55 (V/μs))

Serial #	krad(si)	Exposure Conditions	Pre Result	Post Result	Delta
1	20	HDR unbiased	0.2818	0.2769	-0.0049
2	20	HDR unbiased	0.2825	0.2787	-0.0038
3	20	HDR unbiased	0.2755	0.2719	-0.0036
4	20	HDR unbiased	0.2816	0.2766	-0.005
5	20	HDR unbiased	0.2848	0.2795	-0.0053
6	20	HDR biased	0.2822	0.2695	-0.0127
7	20	HDR biased	0.2875	0.2747	-0.0128
8	20	HDR biased	0.2884	0.2758	-0.0126
9	20	HDR biased	0.2854	0.2722	-0.0132
10	20	HDR biased	0.2827	0.2692	-0.0135
11	30	HDR unbiased	0.2839	0.2778	-0.0061
12	30	HDR unbiased	0.2827	0.2761	-0.0066
13	30	HDR unbiased	0.2869	0.2799	-0.007
14	30	HDR unbiased	0.2897	0.2759	-0.0138
15	30	HDR unbiased	0.2869	0.2804	-0.0065
16	30	HDR biased	0.286	0.2725	-0.0135
17	30	HDR biased	0.2807	0.2684	-0.0123
18	30	HDR biased	0.2888	0.275	-0.0138
19	30	HDR biased	0.2825	0.277	-0.0055
20	30	HDR biased	0.2792	0.2662	-0.013
21	0	correlation	0.2739	0.275	0.0011
22	0	correlation	0.277	0.2793	0.0023
23	0	correlation	0.2834	0.2849	0.0015
24	0	correlation	0.2815	0.2836	0.0021
25	0	correlation	0.2786	0.281	0.0024

TID vs Post - Pre Exposure Delta

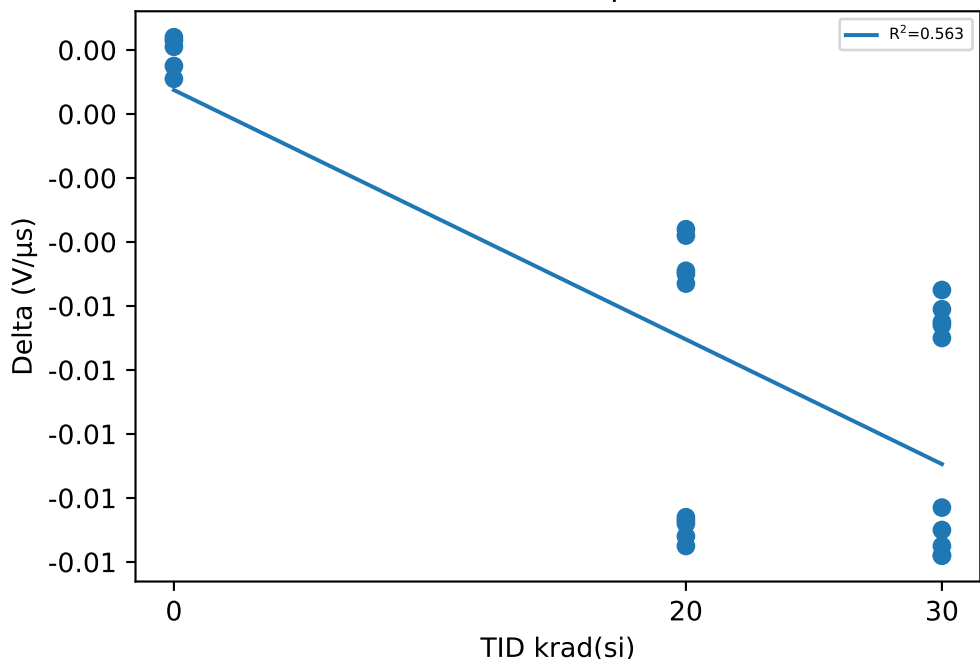

Test Statistics (V/μs)

krad(si)	Pre Exposure Min	Pre Exposure Avg	Pre Exposure Max	Pre Exposure Std	Post Exposure Min	Post Exposure Avg	Post Exposure Max	Post Exposure Std	Min Delta	Avg Delta	Max Delta	Std Delta
0	0.2739	0.27888	0.2834	0.0037319	0.275	0.28076	0.2849	0.0038914	0.0011	0.00188	0.0024	0.00055857
20	0.2755	0.28324	0.2884	0.003628	0.2692	0.2745	0.2795	0.0036466	-0.0135	-0.00874	-0.0036	0.0044846
30	0.2792	0.28473	0.2897	0.0034785	0.2662	0.27492	0.2804	0.0046454	-0.0138	-0.00981	-0.0055	0.0037018

Device Test: 15.14 UJHGWM(TMATCH_CH2_UJHGWM)

TID vs Result Stats

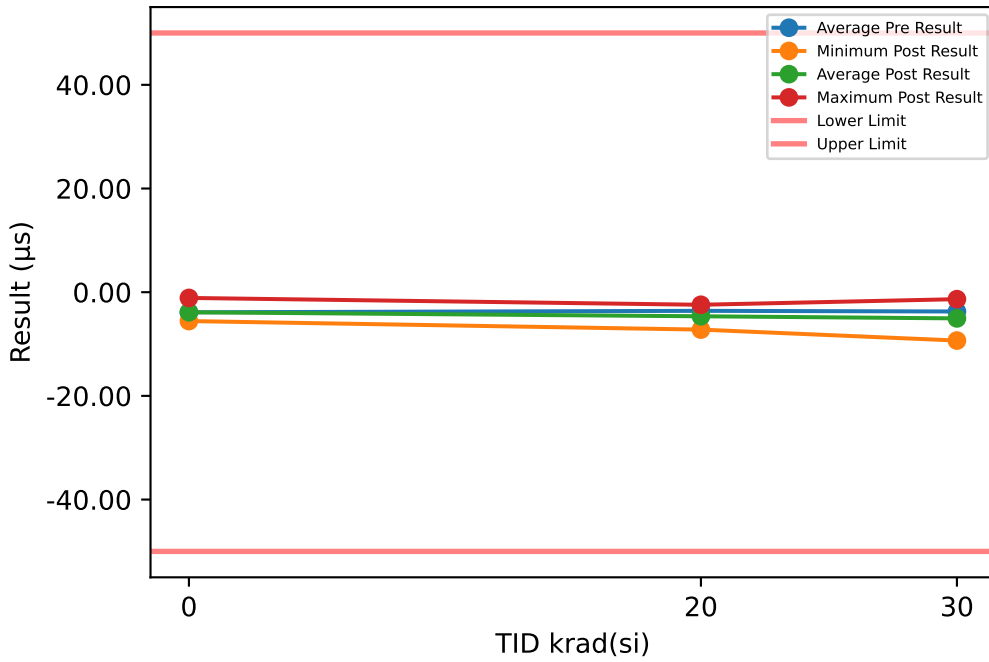

Test Results (Lower Limit = -50.0, Upper Limit = 50.0 (µs))

Serial #	krad(si)	Exposure Conditions	Pre Result	Post Result	Delta
1	20	HDR unbiased	-4.4898	-4.6236	-0.1338
2	20	HDR unbiased	-5.3113	-5.3963	-0.085
3	20	HDR unbiased	-3.7229	-3.8053	-0.0824
4	20	HDR unbiased	-6.4813	-7.2157	-0.7344
5	20	HDR unbiased	-4.855	-5.345	-0.49
6	20	HDR biased	-1.9647	-5.5603	-3.5956
7	20	HDR biased	-3.7802	-5.0708	-1.2906
8	20	HDR biased	-1.9298	-3.1684	-1.2386
9	20	HDR biased	-0.7949	-2.4259	-1.631
10	20	HDR biased	-2.6221	-3.8564	-1.2343
11	30	HDR unbiased	-8.689	-9.3293	-0.6403
12	30	HDR unbiased	-0.7755	-1.3452	-0.5697
13	30	HDR unbiased	-4.6337	-6.1358	-1.5021
14	30	HDR unbiased	-1.2932	-4.63	-3.3368
15	30	HDR unbiased	-2.7991	-3.9085	-1.1094
16	30	HDR biased	-1.382	-3.3836	-2.0016
17	30	HDR biased	-4.3835	-6.1323	-1.7488
18	30	HDR biased	-5.0099	-6.8263	-1.8164
19	30	HDR biased	-3.7492	-2.4196	1.3296
20	30	HDR biased	-4.4869	-6.3938	-1.9069
21	0	correlation	-5.6123	-5.5694	0.0429
22	0	correlation	-4.0036	-3.9324	0.0712
23	0	correlation	-4.0834	-3.8705	0.2129
24	0	correlation	-0.8395	-1.107	-0.2675
25	0	correlation	-4.853	-4.8641	-0.0111

TID vs Post - Pre Exposure Delta

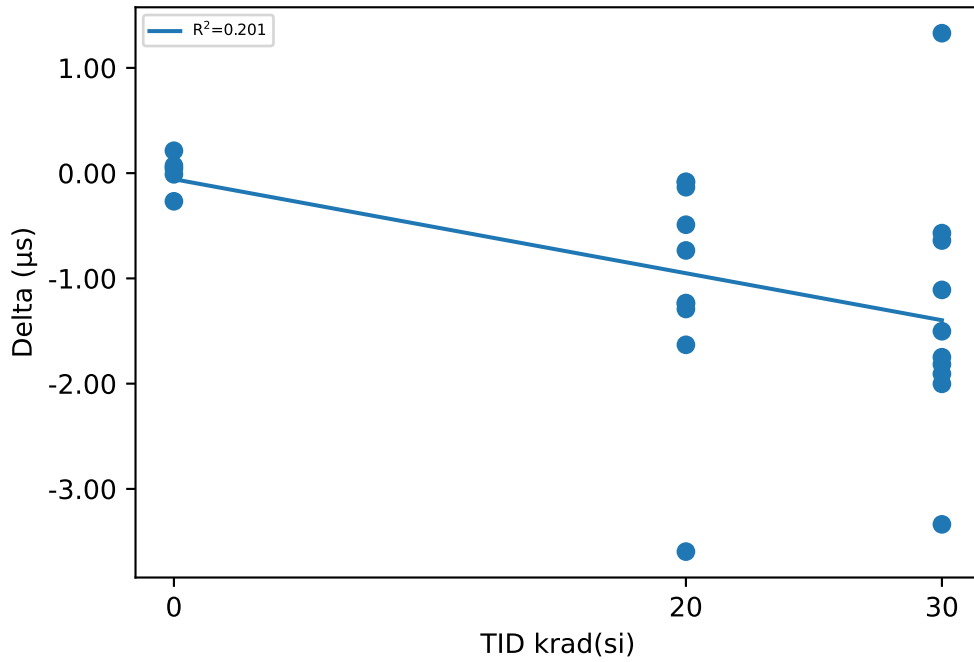

Test Statistics (µs)

krad(si)	Pre Exposure Min	Pre Exposure Avg	Pre Exposure Max	Pre Exposure Std	Post Exposure Min	Post Exposure Avg	Post Exposure Max	Post Exposure Std	Min Delta	Avg Delta	Max Delta	Std Delta
0	-5.6123	-3.8784	-0.8395	1.8199	-5.5694	-3.8687	-1.107	1.6966	-0.2675	0.00968	0.2129	0.17568
20	-6.4813	-3.5952	-0.7949	1.7617	-7.2157	-4.6468	-2.4259	1.379	-3.5956	-1.0516	-0.0824	1.0575
30	-8.689	-3.7202	-0.7755	2.3355	-9.3293	-5.0504	-1.3452	2.3694	-3.3368	-1.3302	1.3296	1.2215

Device Test: 15.15 UJ33GQ(TON_DELAY_CH3_UJ33GQ)

TID vs Result Stats

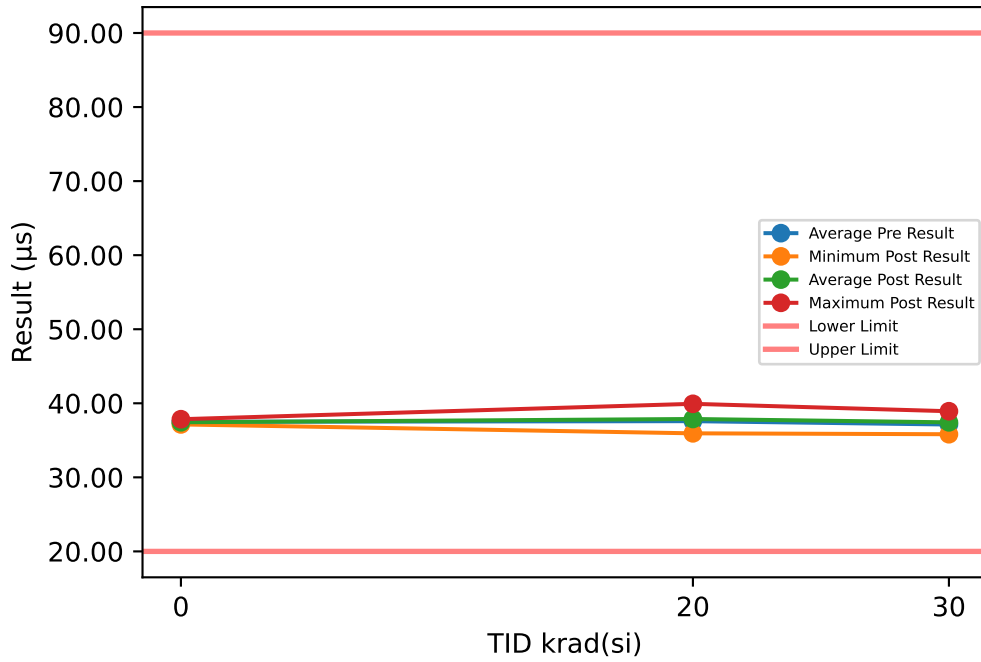

Test Results (Lower Limit = 20.0, Upper Limit = 90.0 (µs))

Serial #	krad(si)	Exposure Conditions	Pre Result	Post Result	Delta
1	20	HDR unbiased	38.638	38.748	0.1102
2	20	HDR unbiased	37.36	37.368	0.0085
3	20	HDR unbiased	35.676	35.942	0.2661
4	20	HDR unbiased	40.063	39.927	-0.1361
5	20	HDR unbiased	36.536	36.697	0.1613
6	20	HDR biased	38.686	37.727	-0.9591
7	20	HDR biased	37.896	39.629	1.7321
8	20	HDR biased	36.678	37.13	0.4517
9	20	HDR biased	36.729	37.373	0.6439
10	20	HDR biased	37.587	38.25	0.6624
11	30	HDR unbiased	35.818	35.821	0.0032
12	30	HDR unbiased	37.155	36.956	-0.1986
13	30	HDR unbiased	37.911	38.557	0.6465
14	30	HDR unbiased	37.488	36.092	-1.396
15	30	HDR unbiased	37.821	37.872	0.0517
16	30	HDR biased	37.38	37.606	0.2256
17	30	HDR biased	37.795	38.356	0.5611
18	30	HDR biased	36.318	36.823	0.5054
19	30	HDR biased	36.011	37.277	1.2656
20	30	HDR biased	37.624	38.927	1.3032
21	0	correlation	38.126	37.85	-0.2758
22	0	correlation	37.105	37.225	0.1205
23	0	correlation	37.202	37.145	-0.0566
24	0	correlation	37.715	37.641	-0.0738
25	0	correlation	37.347	37.31	-0.0376

TID vs Post - Pre Exposure Delta

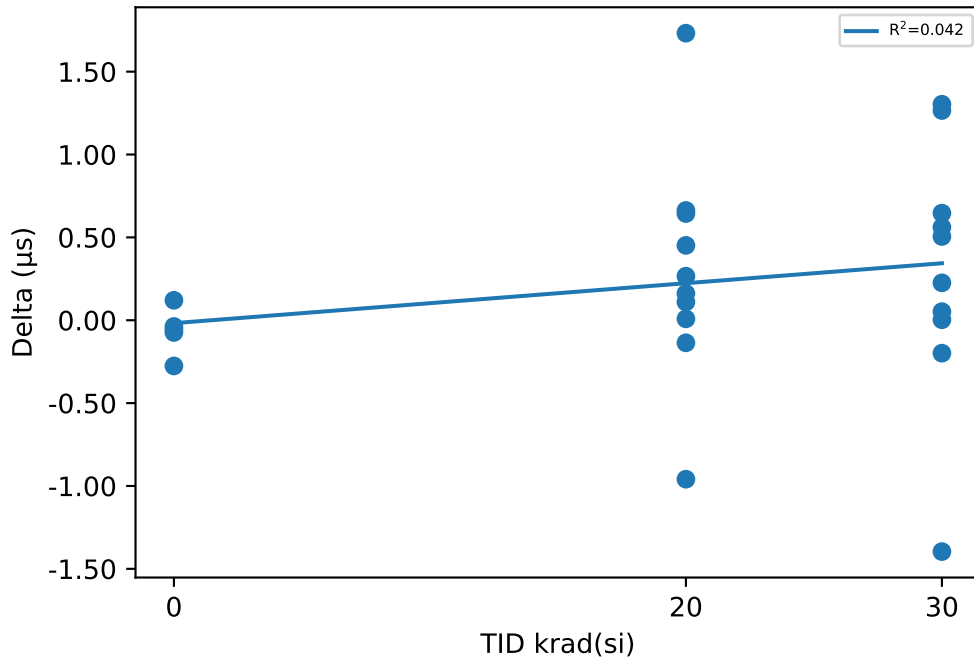

Test Statistics (µs)

krad(si)	Pre Exposure Min	Pre Exposure Avg	Pre Exposure Max	Pre Exposure Std	Post Exposure Min	Post Exposure Avg	Post Exposure Max	Post Exposure Std	Min Delta	Avg Delta	Max Delta	Std Delta
0	37.105	37.499	38.126	0.42012	37.145	37.434	37.85	0.29924	-0.2758	-0.06466	0.1205	0.1412
20	35.676	37.585	40.063	1.2872	35.942	37.879	39.927	1.265	-0.9591	0.2941	1.7321	0.68638
30	35.818	37.132	37.911	0.78858	35.821	37.429	38.927	1.0323	-1.396	0.29677	1.3032	0.77813

Device Test: 15.16 UJZB3P(TOFF_DELAY_CH3_UJZB3P)

TID vs Result Stats

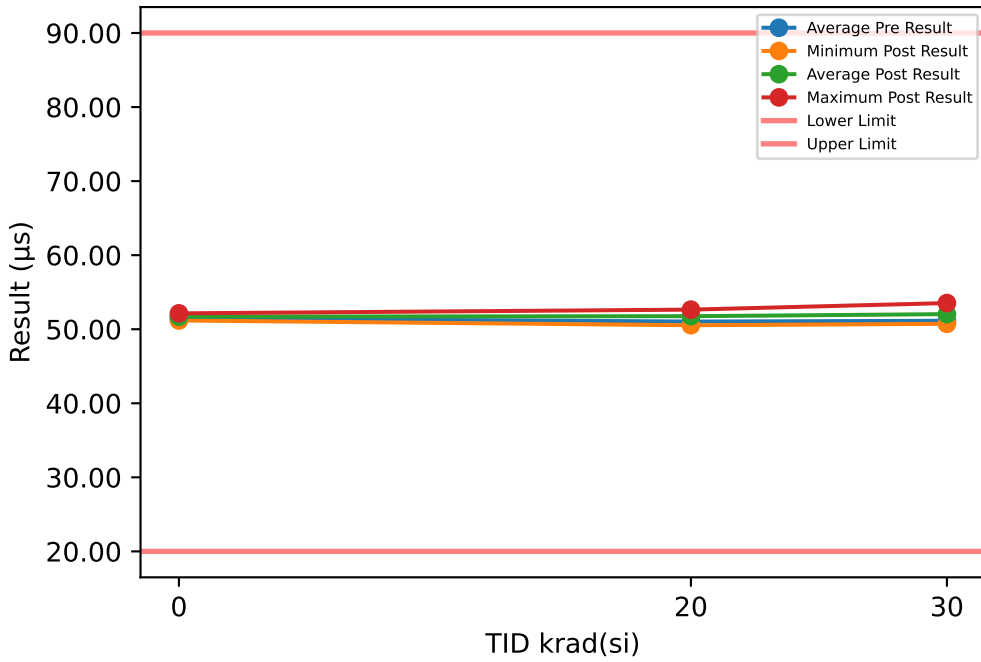

Test Results (Lower Limit = 20.0, Upper Limit = 90.0 (µs))

Serial #	krad(si)	Exposure Conditions	Pre Result	Post Result	Delta
1	20	HDR unbiased	50.759	51.649	0.8896
2	20	HDR unbiased	51.084	51.961	0.8774
3	20	HDR unbiased	51.927	52.645	0.7182
4	20	HDR unbiased	51.227	51.825	0.5975
5	20	HDR unbiased	51.944	52.242	0.2987
6	20	HDR biased	49.787	51.408	1.6216
7	20	HDR biased	51.111	51.733	0.6225
8	20	HDR biased	50.8	51.597	0.7971
9	20	HDR biased	51.133	51.989	0.8563
10	20	HDR biased	50.599	50.538	-0.0609
11	30	HDR unbiased	52.666	53.532	0.8665
12	30	HDR unbiased	50.746	51.562	0.8164
13	30	HDR unbiased	51.013	51.927	0.914
14	30	HDR unbiased	50.362	52.357	1.9954
15	30	HDR unbiased	50.186	50.729	0.5426
16	30	HDR biased	50.627	51.701	1.0741
17	30	HDR biased	50.934	51.801	0.8674
18	30	HDR biased	51.619	52.597	0.9773
19	30	HDR biased	51.337	51.284	-0.0528
20	30	HDR biased	51.896	52.891	0.9943
21	0	correlation	51.768	52.143	0.3749
22	0	correlation	51.053	51.18	0.1272
23	0	correlation	51.756	52.112	0.3558
24	0	correlation	51.314	51.419	0.1043
25	0	correlation	51.53	51.65	0.12

TID vs Post - Pre Exposure Delta

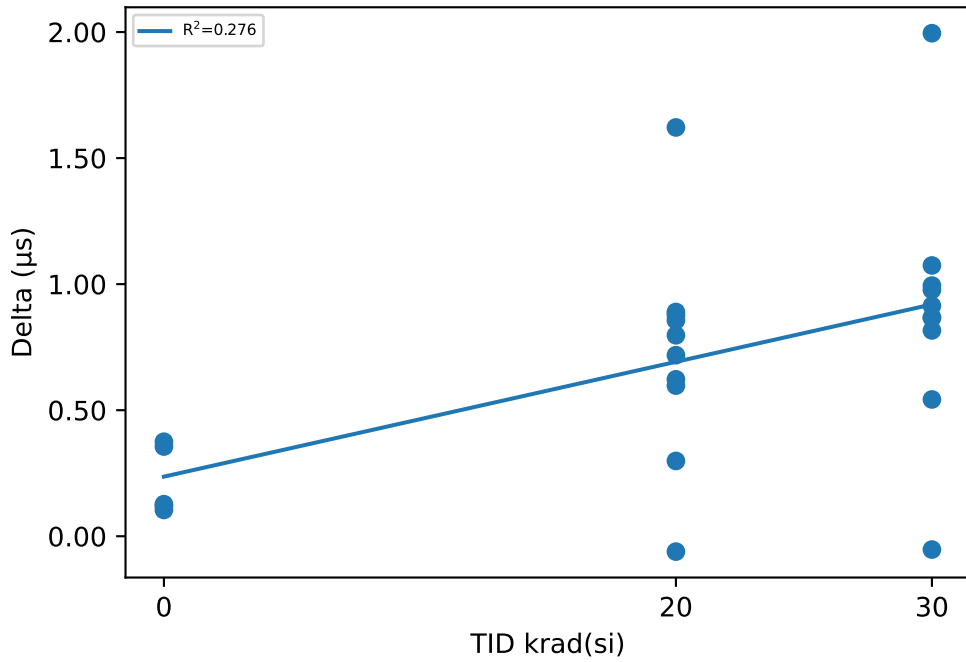

Test Statistics (µs)

krad(si)	Pre Exposure Min	Pre Exposure Avg	Pre Exposure Max	Pre Exposure Std	Post Exposure Min	Post Exposure Avg	Post Exposure Max	Post Exposure Std	Min Delta	Avg Delta	Max Delta	Std Delta
0	51.053	51.484	51.768	0.30483	51.18	51.701	52.143	0.42371	0.1043	0.21644	0.3749	0.13635
20	49.787	51.037	51.944	0.62852	50.538	51.759	52.645	0.55469	-0.0609	0.7218	1.6216	0.43496
30	50.186	51.139	52.666	0.75733	50.729	52.038	53.532	0.82093	-0.0528	0.89952	1.9954	0.50443

Device Test: 15.17 UJP09Y(TRISE_CH3_UJP09Y)

TID vs Result Stats

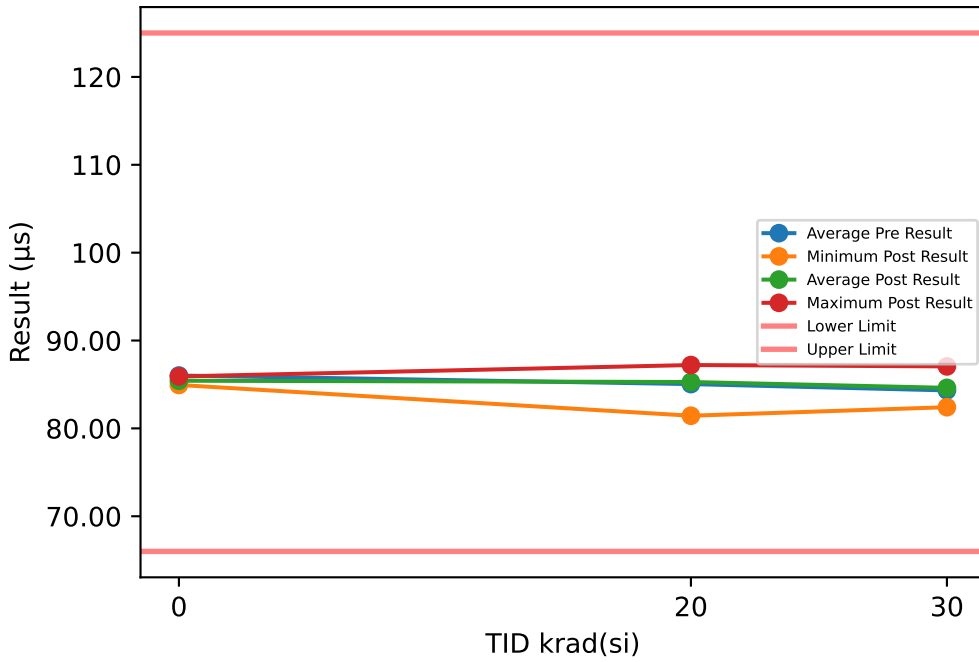

Test Results (Lower Limit = 66.0, Upper Limit = 125.0 (µs))

Serial #	krad(si)	Exposure Conditions	Pre Result	Post Result	Delta
1	20	HDR unbiased	86.133	86.236	0.1029
2	20	HDR unbiased	86.036	86.084	0.0483
3	20	HDR unbiased	81.461	81.441	-0.0196
4	20	HDR unbiased	88.032	87.21	-0.8218
5	20	HDR unbiased	83.076	83.593	0.517
6	20	HDR biased	87.271	85.189	-2.0819
7	20	HDR biased	84.448	85.859	1.4117
8	20	HDR biased	85.884	86.385	0.5012
9	20	HDR biased	82.993	84.137	1.1433
10	20	HDR biased	85.082	86.666	1.5839
11	30	HDR unbiased	82.23	82.411	0.181
12	30	HDR unbiased	83.693	83.33	-0.3624
13	30	HDR unbiased	85.868	86.649	0.7814
14	30	HDR unbiased	85.005	82.609	-2.3957
15	30	HDR unbiased	85.073	84.791	-0.2819
16	30	HDR biased	85.062	85.803	0.7413
17	30	HDR biased	84.566	84.585	0.0185
18	30	HDR biased	83.808	84.351	0.5435
19	30	HDR biased	82.14	84.562	2.4228
20	30	HDR biased	85.783	87.056	1.2732
21	0	correlation	86.163	85.552	-0.6116
22	0	correlation	86.745	85.91	-0.8346
23	0	correlation	85.36	84.943	-0.4169
24	0	correlation	86.212	85.765	-0.447
25	0	correlation	85.599	84.949	-0.6493

TID vs Post - Pre Exposure Delta

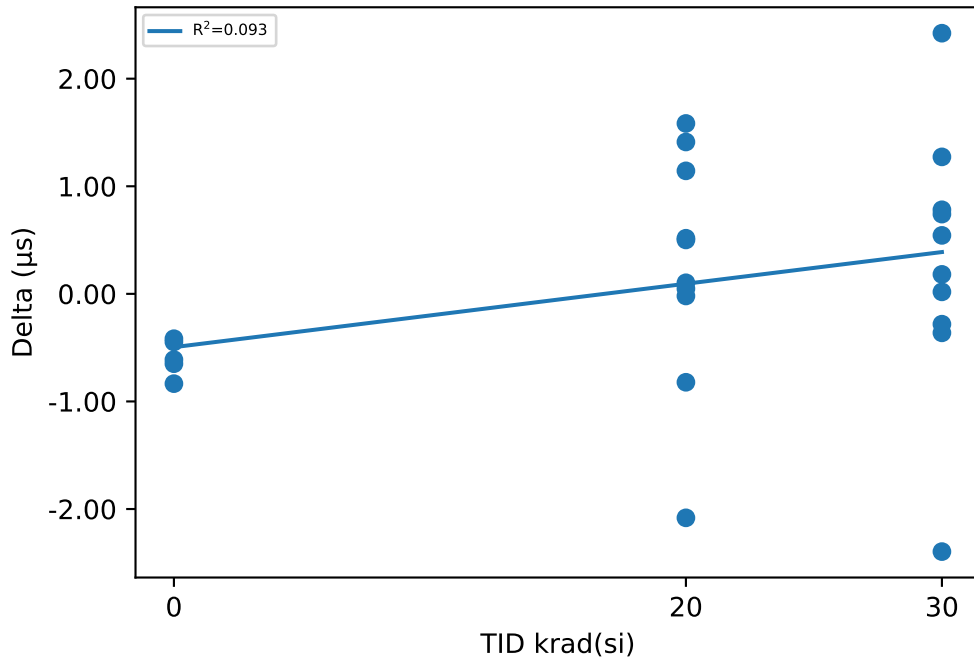

Test Statistics (µs)

krad(si)	Pre Exposure Min	Pre Exposure Avg	Pre Exposure Max	Pre Exposure Std	Post Exposure Min	Post Exposure Avg	Post Exposure Max	Post Exposure Std	Min Delta	Avg Delta	Max Delta	Std Delta
0	85.36	86.016	86.745	0.54673	84.943	85.424	85.91	0.45426	-0.8346	-0.59188	-0.4169	0.16897
20	81.461	85.042	88.032	2.0558	81.441	85.28	87.21	1.7531	-2.0819	0.2385	1.5839	1.0945
30	82.14	84.323	85.868	1.3317	82.411	84.615	87.056	1.5686	-2.3957	0.29217	2.4228	1.2506

Device Test: 15.18 UJ6AIM(TFALL_CH3_UJ6AIM)

TID vs Result Stats

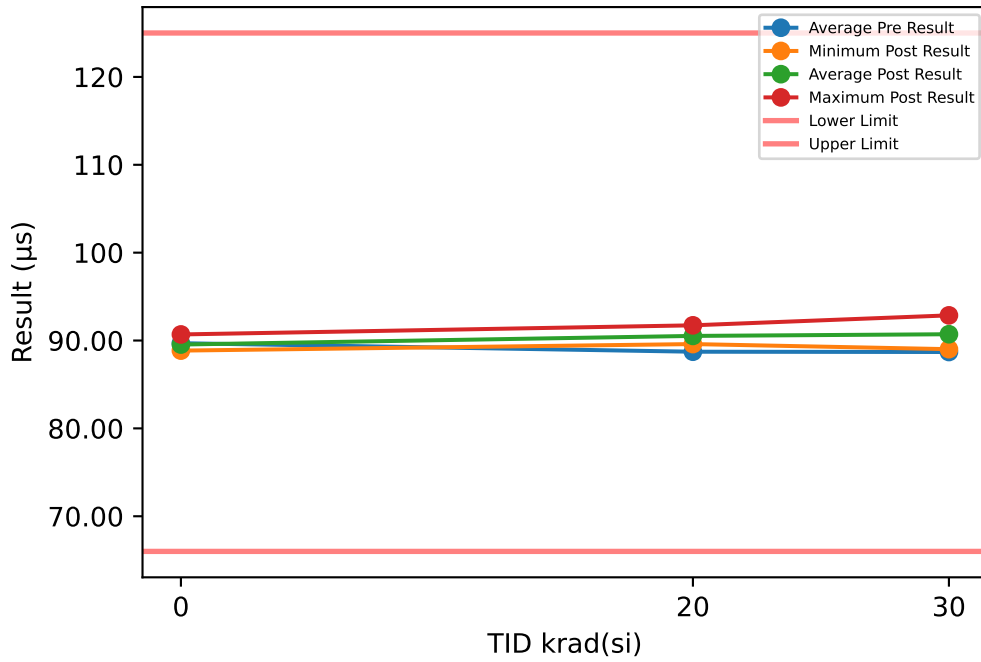

Test Results (Lower Limit = 66.0, Upper Limit = 125.0 (µs))

Serial #	krad(si)	Exposure Conditions	Pre Result	Post Result	Delta
1	20	HDR unbiased	88.676	89.676	1.0002
2	20	HDR unbiased	88.751	90.096	1.3446
3	20	HDR unbiased	90.231	91.73	1.4988
4	20	HDR unbiased	89.116	90.096	0.9801
5	20	HDR unbiased	89.733	90.572	0.8391
6	20	HDR biased	87.12	90.766	3.6458
7	20	HDR biased	88.475	90.802	2.3268
8	20	HDR biased	87.97	90.419	2.4497
9	20	HDR biased	89.111	91.494	2.3825
10	20	HDR biased	88.077	89.596	1.5187
11	30	HDR unbiased	90.269	91.622	1.353
12	30	HDR unbiased	88.07	89.414	1.344
13	30	HDR unbiased	88.399	89.963	1.5639
14	30	HDR unbiased	87.456	90.421	2.9649
15	30	HDR unbiased	87.56	89.016	1.4559
16	30	HDR biased	88.484	91.153	2.6682
17	30	HDR biased	88.121	90.765	2.6446
18	30	HDR biased	89.518	92.342	2.8238
19	30	HDR biased	88.861	89.591	0.7297
20	30	HDR biased	90.198	92.863	2.6649
21	0	correlation	90.938	90.691	-0.2462
22	0	correlation	88.944	88.852	-0.0919
23	0	correlation	89.702	89.621	-0.0806
24	0	correlation	89.079	88.954	-0.1256
25	0	correlation	89.816	89.592	-0.2237

TID vs Post - Pre Exposure Delta

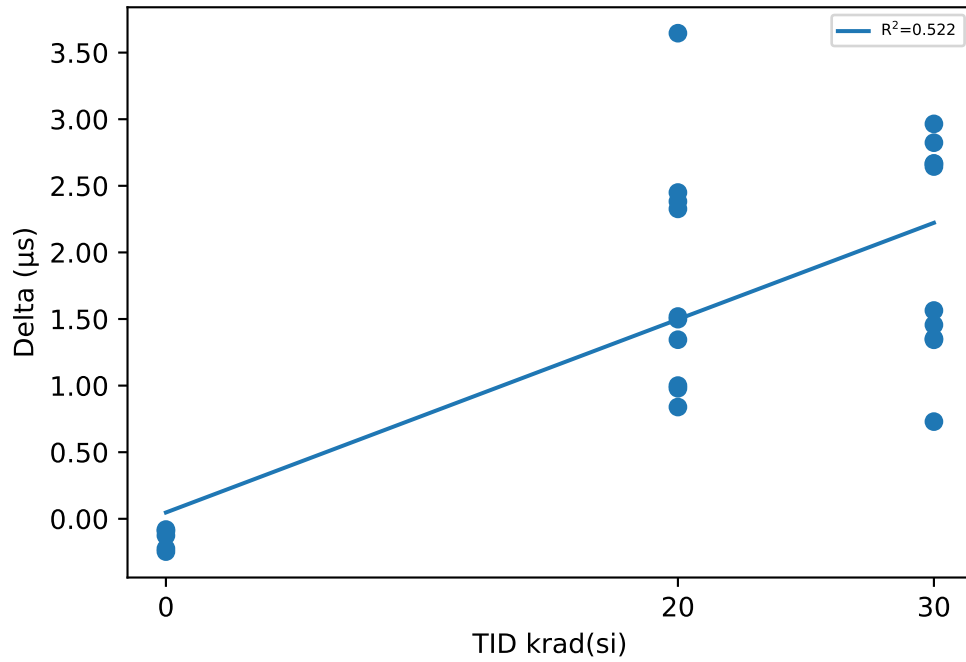

Test Statistics (µs)

krad(si)	Pre Exposure Min	Pre Exposure Avg	Pre Exposure Max	Pre Exposure Std	Post Exposure Min	Post Exposure Avg	Post Exposure Max	Post Exposure Std	Min Delta	Avg Delta	Max Delta	Std Delta
0	88.944	89.696	90.938	0.79078	88.852	89.542	90.691	0.7334	-0.2462	-0.1536	-0.0806	0.076499
20	87.12	88.726	90.231	0.89556	89.596	90.525	91.73	0.70631	0.8391	1.7986	3.6458	0.88559
30	87.456	88.694	90.269	1.0065	89.016	90.715	92.863	1.2812	0.7297	2.0213	2.9649	0.80678

Device Test: 15.19 UJPEEL(SLEWRATE_ON_CH3_UJPEEL)

TID vs Result Stats

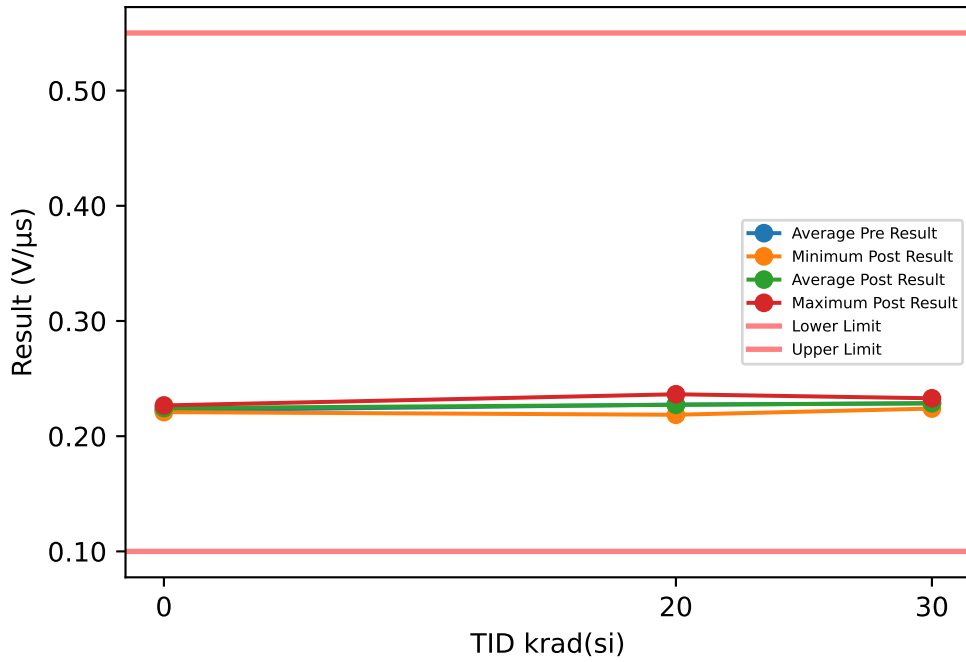

TID vs Post - Pre Exposure Delta

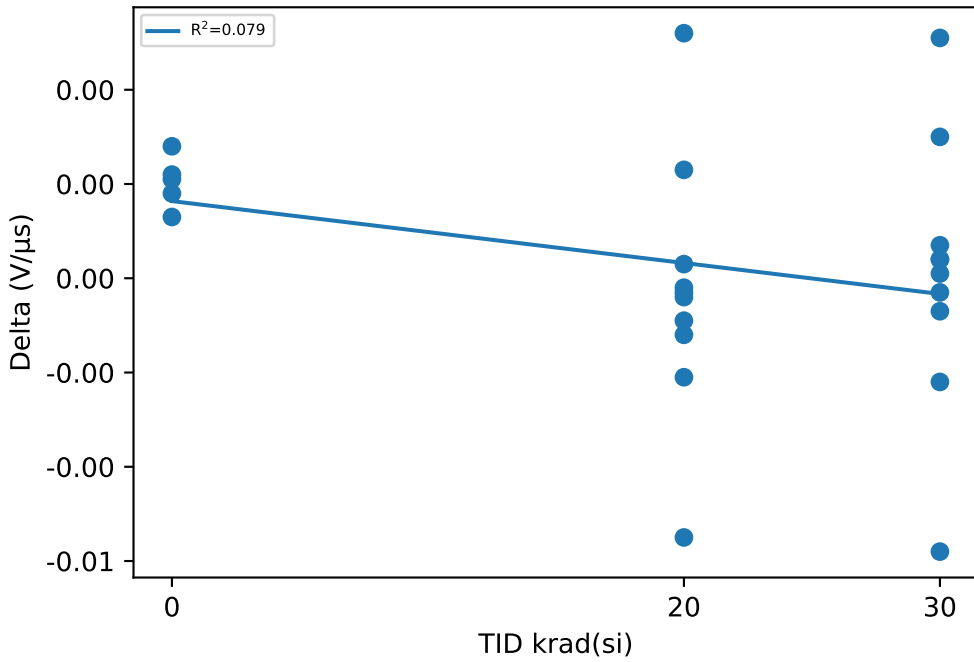

Test Results (Lower Limit = 0.1, Upper Limit = 0.55 (V/μs))

Serial #	krad(si)	Exposure Conditions	Pre Result	Post Result	Delta
1	20	HDR unbiased	0.2259	0.2257	-0.0002
2	20	HDR unbiased	0.2218	0.2215	-0.0003
3	20	HDR unbiased	0.2373	0.2364	-0.0009
4	20	HDR unbiased	0.2256	0.2279	0.0023
5	20	HDR unbiased	0.2312	0.23	-0.0012
6	20	HDR biased	0.2219	0.2271	0.0052
7	20	HDR biased	0.2327	0.233	0.0003
8	20	HDR biased	0.219	0.2186	-0.0004
9	20	HDR biased	0.2325	0.2304	-0.0021
10	20	HDR biased	0.2269	0.2214	-0.0055
11	30	HDR unbiased	0.2323	0.2316	-0.0007
12	30	HDR unbiased	0.2323	0.232	-0.0003
13	30	HDR unbiased	0.2233	0.224	0.0007
14	30	HDR unbiased	0.2267	0.2318	0.0051
15	30	HDR unbiased	0.2294	0.2298	0.0004
16	30	HDR biased	0.2265	0.2243	-0.0022
17	30	HDR biased	0.2299	0.2329	0.003
18	30	HDR biased	0.2267	0.2271	0.0004
19	30	HDR biased	0.2338	0.228	-0.0058
20	30	HDR biased	0.2246	0.2247	0.0001
21	0	correlation	0.2239	0.2267	0.0028
22	0	correlation	0.2188	0.2209	0.0021
23	0	correlation	0.2241	0.2254	0.0013
24	0	correlation	0.2215	0.2237	0.0022
25	0	correlation	0.2237	0.2255	0.0018

Test Statistics (V/μs)

krad(si)	Pre Exposure Min	Pre Exposure Avg	Pre Exposure Max	Pre Exposure Std	Post Exposure Min	Post Exposure Avg	Post Exposure Max	Post Exposure Std	Min Delta	Avg Delta	Max Delta	Std Delta
0	0.2188	0.2224	0.2241	0.0022694	0.2209	0.22444	0.2267	0.002249	0.0013	0.00204	0.0028	0.00055045
20	0.219	0.22748	0.2373	0.0058156	0.2186	0.2272	0.2364	0.0055698	-0.0055	-0.00028	0.0052	0.0027656
30	0.2233	0.22855	0.2338	0.0035347	0.224	0.22862	0.2329	0.0034672	-0.0058	7e-05	0.0051	0.0028837

Device Test: 15.20 UJD80I(SLEWRATE_OFF_CH3_UJD80I)

TID vs Result Stats

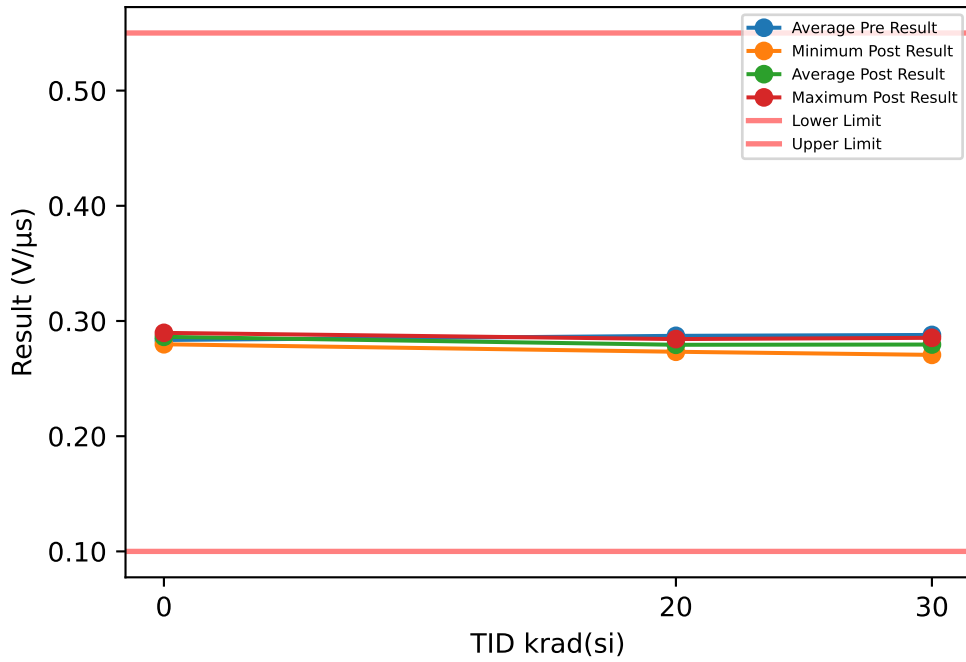

Test Results (Lower Limit = 0.1, Upper Limit = 0.55 (V/μs))

Serial #	krad(si)	Exposure Conditions	Pre Result	Post Result	Delta
1	20	HDR unbiased	0.2866	0.2843	-0.0023
2	20	HDR unbiased	0.286	0.2842	-0.0018
3	20	HDR unbiased	0.2816	0.2778	-0.0038
4	20	HDR unbiased	0.2855	0.2822	-0.0033
5	20	HDR unbiased	0.2882	0.2833	-0.0049
6	20	HDR biased	0.2904	0.2758	-0.0146
7	20	HDR biased	0.2888	0.2766	-0.0122
8	20	HDR biased	0.2913	0.2784	-0.0129
9	20	HDR biased	0.2849	0.2733	-0.0116
10	20	HDR biased	0.2879	0.2776	-0.0103
11	30	HDR unbiased	0.2882	0.2837	-0.0045
12	30	HDR unbiased	0.2894	0.2854	-0.004
13	30	HDR unbiased	0.2895	0.2834	-0.0061
14	30	HDR unbiased	0.2923	0.2837	-0.0086
15	30	HDR unbiased	0.2873	0.2827	-0.0046
16	30	HDR biased	0.2858	0.273	-0.0128
17	30	HDR biased	0.2913	0.2789	-0.0124
18	30	HDR biased	0.2851	0.2725	-0.0126
19	30	HDR biased	0.2885	0.2818	-0.0067
20	30	HDR biased	0.2816	0.2706	-0.011
21	0	correlation	0.2772	0.2798	0.0026
22	0	correlation	0.2837	0.2865	0.0028
23	0	correlation	0.2872	0.2896	0.0024
24	0	correlation	0.2872	0.2897	0.0025
25	0	correlation	0.2822	0.2857	0.0035

TID vs Post - Pre Exposure Delta

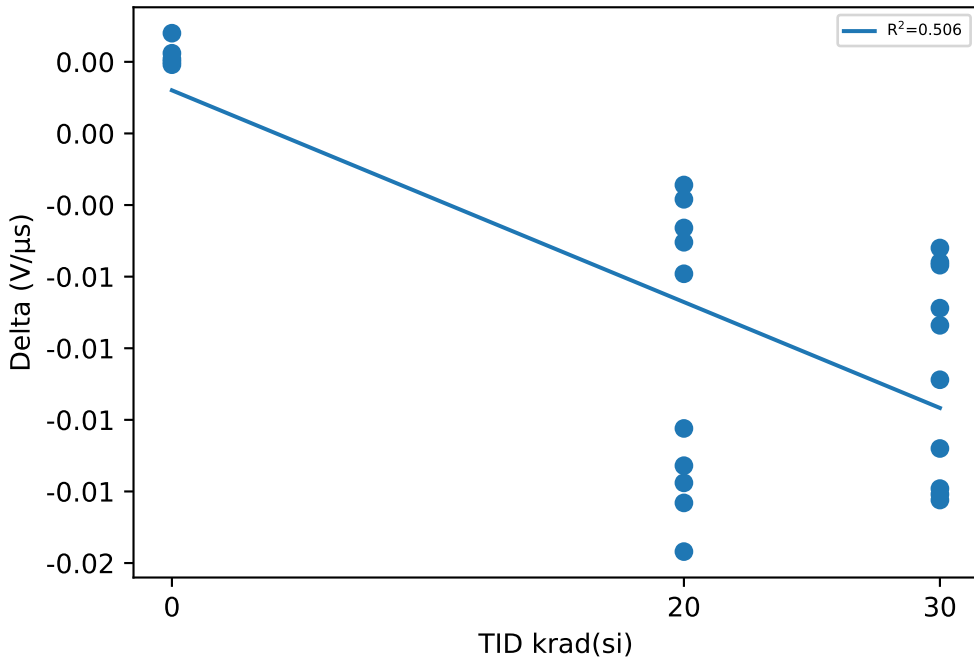

Test Statistics (V/μs)

krad(si)	Pre Exposure Min	Pre Exposure Avg	Pre Exposure Max	Pre Exposure Std	Post Exposure Min	Post Exposure Avg	Post Exposure Max	Post Exposure Std	Min Delta	Avg Delta	Max Delta	Std Delta
0	0.2772	0.2835	0.2872	0.0041473	0.2798	0.28626	0.2897	0.004034	0.0024	0.00276	0.0035	0.00043932
20	0.2816	0.28712	0.2913	0.0028358	0.2733	0.27935	0.2843	0.0038713	-0.0146	-0.00777	-0.0018	0.00498
30	0.2816	0.2879	0.2923	0.0031355	0.2706	0.27957	0.2854	0.0054934	-0.0128	-0.00833	-0.004	0.0036046

Device Test: 15.2 UJZB3P(TOFF_DELAY_CH1_UJZB3P)

TID vs Result Stats

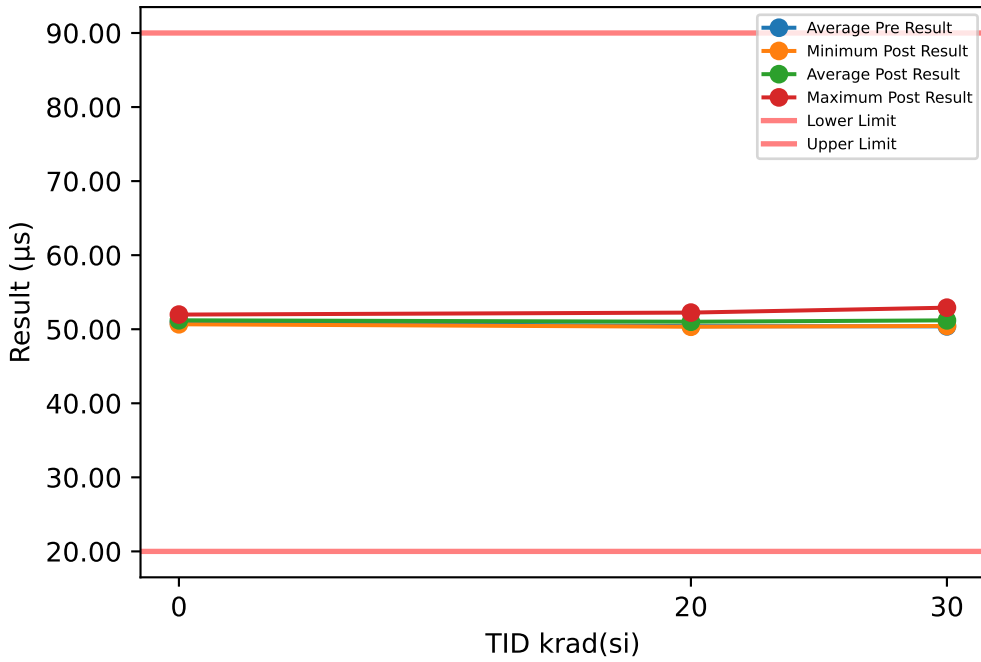

TID vs Post - Pre Exposure Delta

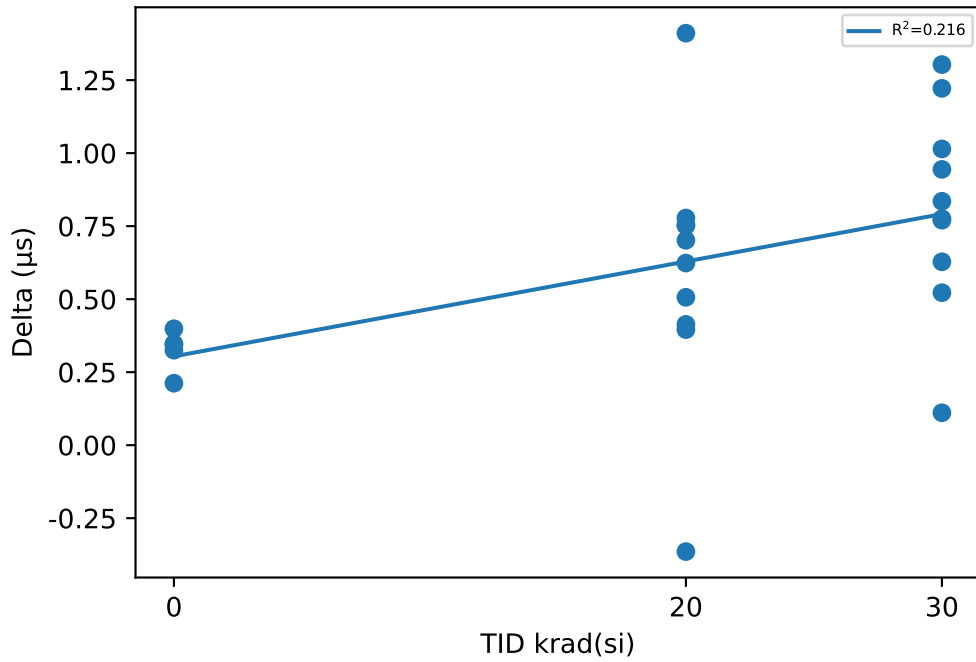

Test Results (Lower Limit = 20.0, Upper Limit = 90.0 (µs))

Serial #	krad(si)	Exposure Conditions	Pre Result	Post Result	Delta
1	20	HDR unbiased	50.186	50.938	0.7519
2	20	HDR unbiased	50.134	50.758	0.6236
3	20	HDR unbiased	51.739	52.246	0.5064
4	20	HDR unbiased	50.74	51.518	0.7778
5	20	HDR unbiased	50.949	51.345	0.3957
6	20	HDR biased	50.699	50.334	-0.3644
7	20	HDR biased	50.118	50.873	0.7543
8	20	HDR biased	50.016	50.718	0.7016
9	20	HDR biased	49.934	50.347	0.4136
10	20	HDR biased	49.658	51.069	1.4107
11	30	HDR unbiased	52.139	52.91	0.7705
12	30	HDR unbiased	49.936	50.563	0.628
13	30	HDR unbiased	50.204	50.98	0.7756
14	30	HDR unbiased	49.746	51.05	1.3033
15	30	HDR unbiased	49.919	50.442	0.5222
16	30	HDR biased	51.256	52.091	0.8352
17	30	HDR biased	49.828	50.842	1.0144
18	30	HDR biased	49.597	50.819	1.2219
19	30	HDR biased	50.512	50.623	0.111
20	30	HDR biased	50.709	51.653	0.9444
21	0	correlation	51.579	51.978	0.3987
22	0	correlation	50.456	50.668	0.2121
23	0	correlation	50.377	50.702	0.3253
24	0	correlation	51.045	51.392	0.3472
25	0	correlation	50.95	51.294	0.3435

Test Statistics (µs)

krad(si)	Pre Exposure Min	Pre Exposure Avg	Pre Exposure Max	Pre Exposure Std	Post Exposure Min	Post Exposure Avg	Post Exposure Max	Post Exposure Std	Min Delta	Avg Delta	Max Delta	Std Delta
0	50.377	50.881	51.579	0.48841	50.668	51.207	51.978	0.5435	0.2121	0.32536	0.3987	0.068943
20	49.658	50.417	51.739	0.61531	50.334	51.014	52.246	0.57428	-0.3644	0.59712	1.4107	0.44245
30	49.597	50.385	52.139	0.79907	50.442	51.197	52.91	0.78736	0.111	0.81265	1.3033	0.34652

Device Test: 15.21 UJHGWM(TMATCH_CH3_UJHGWM)

TID vs Result Stats

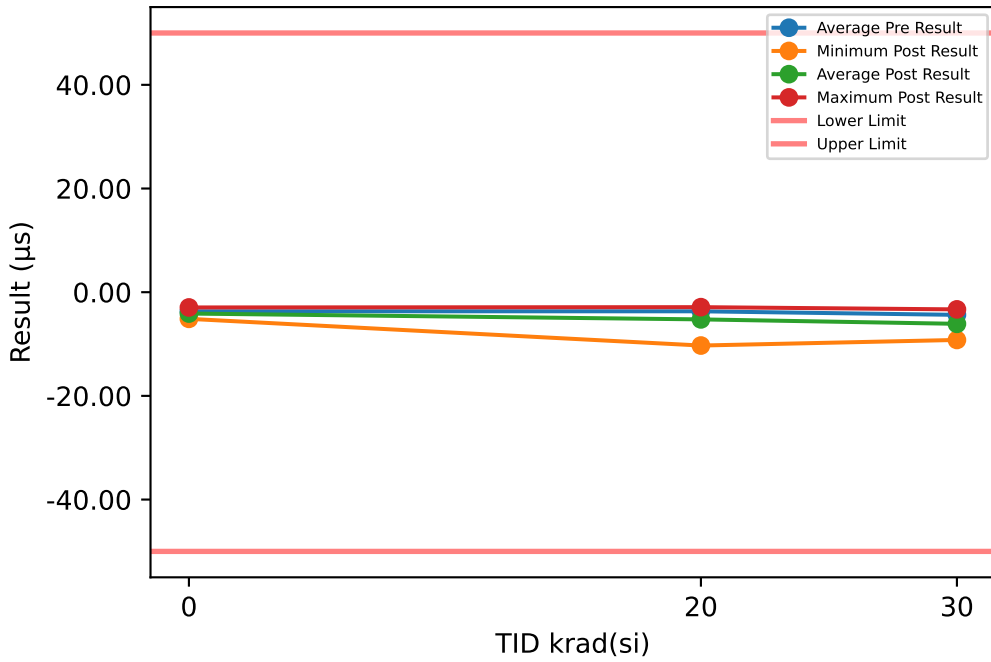

Test Results (Lower Limit = -50.0, Upper Limit = 50.0 (µs))

Serial #	krad(si)	Exposure Conditions	Pre Result	Post Result	Delta
1	20	HDR unbiased	-2.5431	-3.4403	-0.8972
2	20	HDR unbiased	-2.7155	-4.0118	-1.2963
3	20	HDR unbiased	-8.7703	-10.289	-1.5184
4	20	HDR unbiased	-1.0845	-2.8863	-1.8018
5	20	HDR unbiased	-6.6571	-6.9793	-0.3222
6	20	HDR biased	0.1509	-5.5768	-5.7277
7	20	HDR biased	-4.0275	-4.9425	-0.915
8	20	HDR biased	-2.0857	-4.0343	-1.9486
9	20	HDR biased	-6.1178	-7.3568	-1.239
10	20	HDR biased	-2.9954	-2.9301	0.0653
11	30	HDR unbiased	-8.0387	-9.2106	-1.1719
12	30	HDR unbiased	-4.377	-6.0835	-1.7065
13	30	HDR unbiased	-2.5313	-3.3138	-0.7825
14	30	HDR unbiased	-2.4513	-7.8119	-5.3606
15	30	HDR unbiased	-2.487	-4.2248	-1.7378
16	30	HDR biased	-3.4224	-5.3493	-1.9269
17	30	HDR biased	-3.5545	-6.1806	-2.6261
18	30	HDR biased	-5.71	-7.9905	-2.2805
19	30	HDR biased	-6.7219	-5.0287	1.6932
20	30	HDR biased	-4.4157	-5.8074	-1.3917
21	0	correlation	-4.7743	-5.1397	-0.3654
22	0	correlation	-2.1993	-2.942	-0.7427
23	0	correlation	-4.3418	-4.6781	-0.3363
24	0	correlation	-2.8676	-3.1891	-0.3215
25	0	correlation	-4.2177	-4.6432	-0.4255

TID vs Post - Pre Exposure Delta

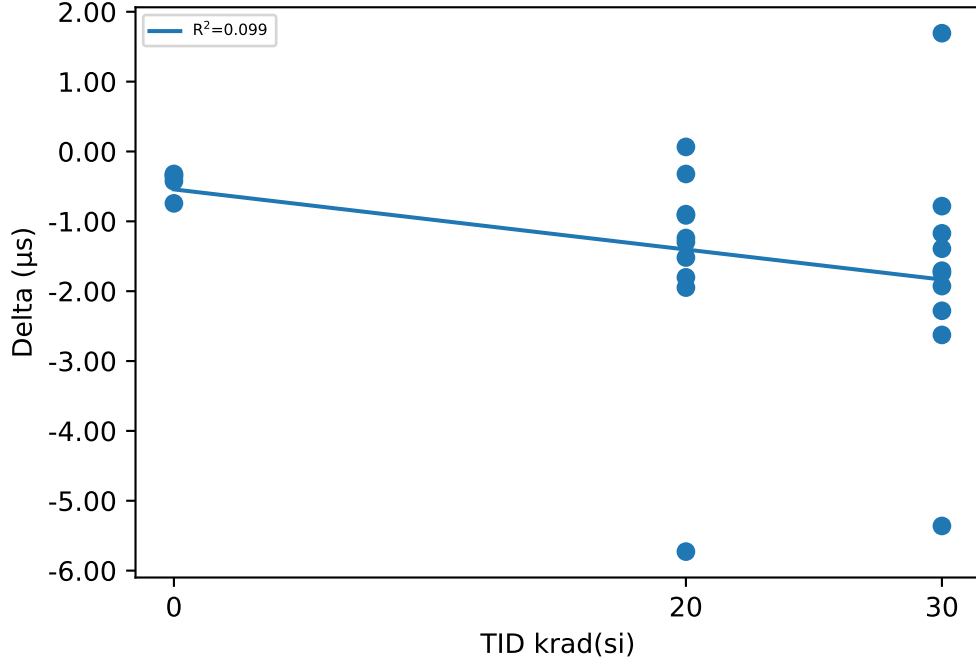

Test Statistics (µs)

krad(si)	Pre Exposure Min	Pre Exposure Avg	Pre Exposure Max	Pre Exposure Std	Post Exposure Min	Post Exposure Avg	Post Exposure Max	Post Exposure Std	Min Delta	Avg Delta	Max Delta	Std Delta
0	-4.7743	-3.6801	-2.1993	1.0928	-5.1397	-4.1184	-2.942	0.98479	-0.7427	-0.43828	-0.3215	0.17477
20	-8.7703	-3.6846	0.1509	2.7383	-10.289	-5.2447	-2.8863	2.3635	-5.7277	-1.5601	0.0653	1.591
30	-8.0387	-4.371	-2.4513	1.9137	-9.2106	-6.1001	-3.3138	1.8032	-5.3606	-1.7291	1.6932	1.7438

Device Test: 15.22 UJ33GQ(TON_DELAY_CH4_UJ33GQ)

TID vs Result Stats

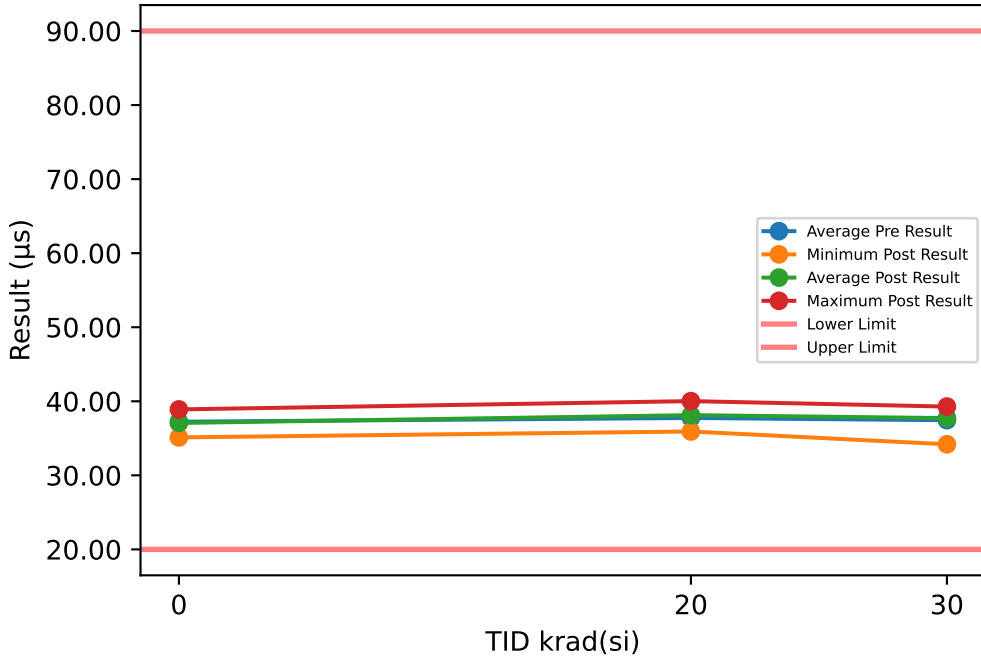

Test Results (Lower Limit = 20.0, Upper Limit = 90.0 (µs))

Serial #	krad(si)	Exposure Conditions	Pre Result	Post Result	Delta
1	20	HDR unbiased	38.593	38.265	-0.3283
2	20	HDR unbiased	37.806	37.759	-0.0468
3	20	HDR unbiased	39.666	40.022	0.356
4	20	HDR unbiased	36.566	36.722	0.1556
5	20	HDR unbiased	36.373	35.924	-0.4492
6	20	HDR biased	37.397	37.881	0.4843
7	20	HDR biased	38.29	39.355	1.0652
8	20	HDR biased	39.58	39.876	0.2959
9	20	HDR biased	36.862	37.452	0.5901
10	20	HDR biased	36.329	38.035	1.7058
11	30	HDR unbiased	34.041	34.192	0.151
12	30	HDR unbiased	38.235	38.003	-0.2325
13	30	HDR unbiased	37.544	38.096	0.5521
14	30	HDR unbiased	36.247	38.599	2.3521
15	30	HDR unbiased	37.214	37.462	0.2486
16	30	HDR biased	38.099	38.642	0.5434
17	30	HDR biased	38.633	39.283	0.6508
18	30	HDR biased	38.213	38.157	-0.0552
19	30	HDR biased	38.29	36.416	-1.874
20	30	HDR biased	37.951	38.424	0.4723
21	0	correlation	35.375	35.123	-0.2519
22	0	correlation	38.897	38.902	0.0057
23	0	correlation	36.79	36.541	-0.2482
24	0	correlation	37.812	37.69	-0.1226
25	0	correlation	37.332	37.11	-0.2226

TID vs Post - Pre Exposure Delta

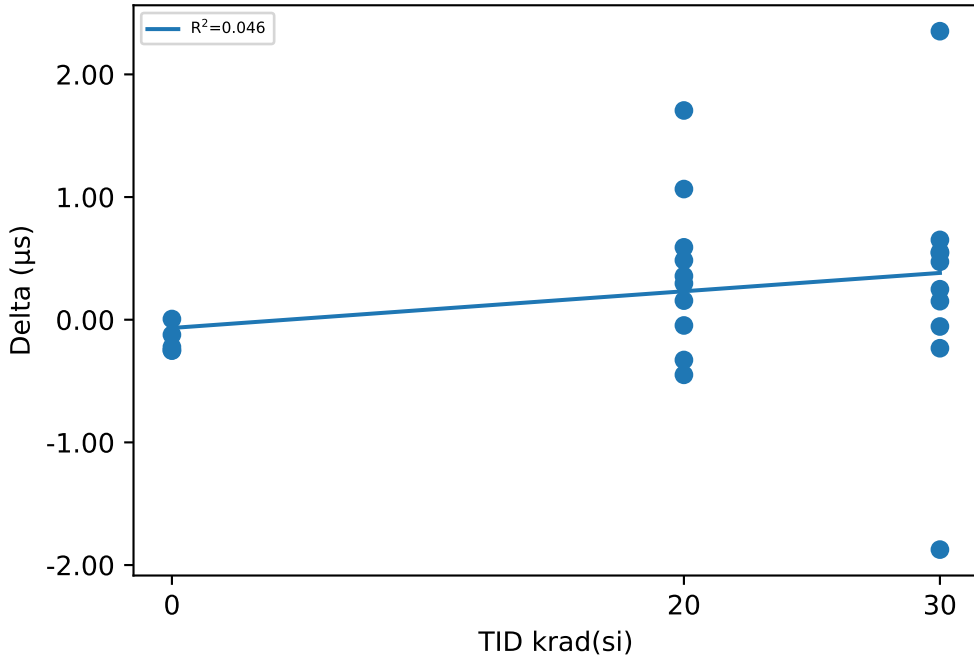

Test Statistics (µs)

krad(si)	Pre Exposure Min	Pre Exposure Avg	Pre Exposure Max	Pre Exposure Std	Post Exposure Min	Post Exposure Avg	Post Exposure Max	Post Exposure Std	Min Delta	Avg Delta	Max Delta	Std Delta
0	35.375	37.241	38.897	1.3002	35.123	37.073	38.902	1.3976	-0.2519	-0.16792	0.0057	0.11032
20	36.329	37.746	39.666	1.2586	35.924	38.129	40.022	1.3193	-0.4492	0.38286	1.7058	0.64218
30	34.041	37.447	38.633	1.3786	34.192	37.728	39.283	1.4601	-1.874	0.28086	2.3521	1.0352

Device Test: 15.23 UJZB3P(TOFF_DELAY_CH4_UJZB3P)

TID vs Result Stats

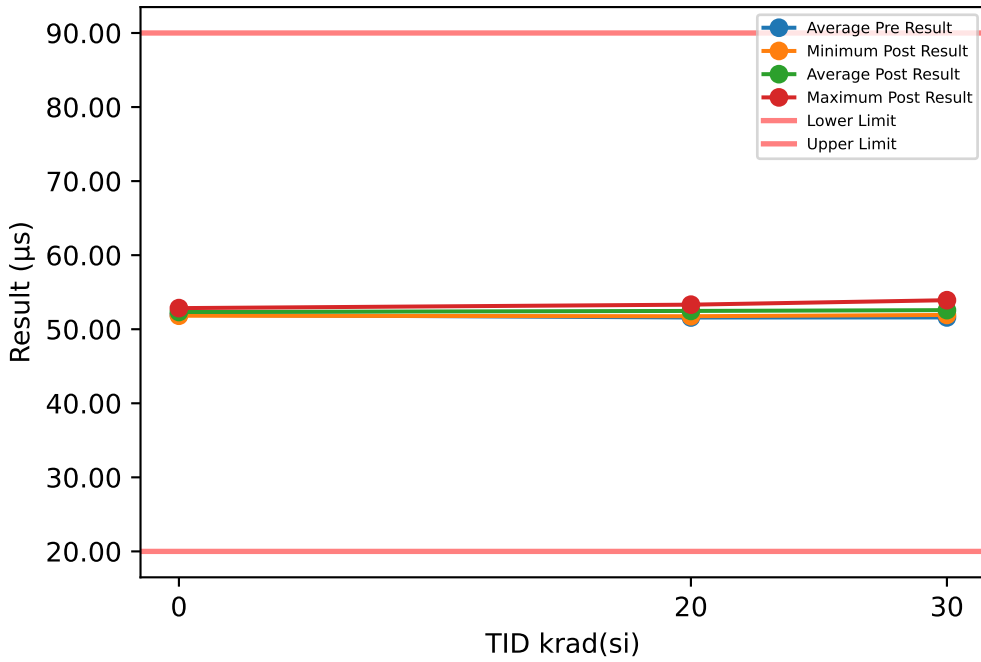

Test Results (Lower Limit = 20.0, Upper Limit = 90.0 (µs))

Serial #	krad(si)	Exposure Conditions	Pre Result	Post Result	Delta
1	20	HDR unbiased	51.758	52.742	0.984
2	20	HDR unbiased	51.589	52.536	0.9462
3	20	HDR unbiased	52.618	53.316	0.6979
4	20	HDR unbiased	52.463	53.2	0.7375
5	20	HDR unbiased	51.478	52.47	0.9916
6	20	HDR biased	51.241	52.301	1.06
7	20	HDR biased	51.432	52.407	0.9744
8	20	HDR biased	50.905	51.757	0.8519
9	20	HDR biased	51.002	51.963	0.9608
10	20	HDR biased	51.324	52.013	0.6885
11	30	HDR unbiased	52.989	53.919	0.9301
12	30	HDR unbiased	50.905	51.928	1.0232
13	30	HDR unbiased	51.356	52.373	1.0162
14	30	HDR unbiased	50.885	52.741	1.8551
15	30	HDR unbiased	50.928	51.947	1.0189
16	30	HDR biased	52.252	53.19	0.9371
17	30	HDR biased	51.142	52.377	1.2355
18	30	HDR biased	51.958	52.811	0.853
19	30	HDR biased	51.92	52.059	0.1398
20	30	HDR biased	51.57	52.434	0.8639
21	0	correlation	52.778	52.851	0.0733
22	0	correlation	51.318	51.822	0.5044
23	0	correlation	51.786	52.358	0.5714
24	0	correlation	51.533	51.983	0.4497
25	0	correlation	52.327	52.611	0.2845

TID vs Post - Pre Exposure Delta

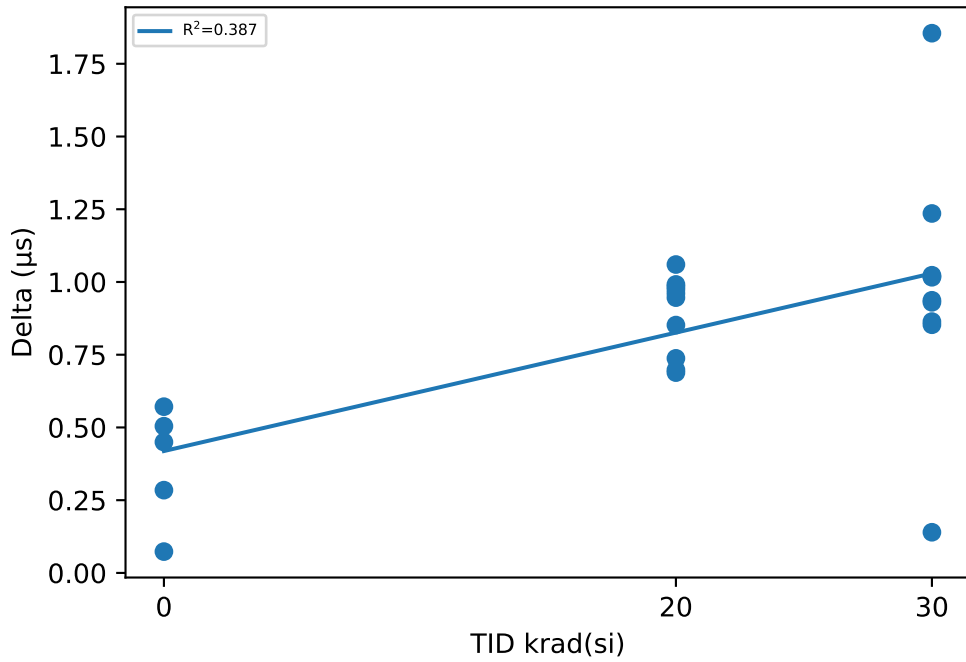

Test Statistics (µs)

krad(si)	Pre Exposure Min	Pre Exposure Avg	Pre Exposure Max	Pre Exposure Std	Post Exposure Min	Post Exposure Avg	Post Exposure Max	Post Exposure Std	Min Delta	Avg Delta	Max Delta	Std Delta
0	51.318	51.948	52.778	0.59732	51.822	52.325	52.851	0.42704	0.0733	0.37666	0.5714	0.20006
20	50.905	51.581	52.618	0.56665	51.757	52.47	53.316	0.50921	0.6885	0.88928	1.06	0.13563
30	50.885	51.59	52.989	0.69107	51.928	52.578	53.919	0.61864	0.1398	0.98728	1.8551	0.41835

Device Test: 15.24 UJP09Y(TRISE_CH4_UJP09Y)

TID vs Result Stats

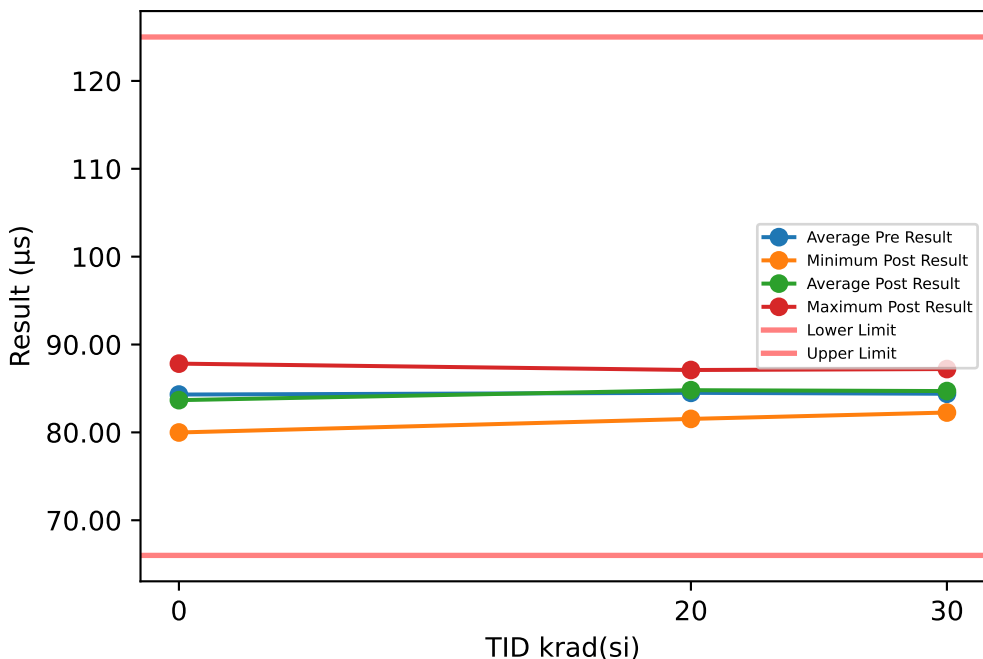

Test Results (Lower Limit = 66.0, Upper Limit = 125.0 (µs))

Serial #	krad(si)	Exposure Conditions	Pre Result	Post Result	Delta
1	20	HDR unbiased	83.84	83.937	0.0969
2	20	HDR unbiased	85.66	85.273	-0.3866
3	20	HDR unbiased	85.075	85.499	0.4246
4	20	HDR unbiased	81.733	81.819	0.0857
5	20	HDR unbiased	81.719	81.535	-0.184
6	20	HDR biased	84.98	85.804	0.8237
7	20	HDR biased	86.553	87.1	0.5469
8	20	HDR biased	87.016	87.034	0.0181
9	20	HDR biased	84.311	84.576	0.2649
10	20	HDR biased	84.115	85.444	1.3288
11	30	HDR unbiased	81.97	82.26	0.2893
12	30	HDR unbiased	84.112	84.228	0.1162
13	30	HDR unbiased	86.721	87.208	0.4877
14	30	HDR unbiased	83.274	86.102	2.8283
15	30	HDR unbiased	82.247	82.52	0.2733
16	30	HDR biased	83.487	84.218	0.7306
17	30	HDR biased	87.102	87.184	0.0815
18	30	HDR biased	85.445	85.16	-0.2843
19	30	HDR biased	85.601	83.313	-2.2878
20	30	HDR biased	84.001	84.839	0.8382
21	0	correlation	80.52	79.989	-0.5308
22	0	correlation	88.621	87.826	-0.7959
23	0	correlation	84.063	83.455	-0.608
24	0	correlation	83.986	83.432	-0.5541
25	0	correlation	84.343	83.639	-0.7037

TID vs Post - Pre Exposure Delta

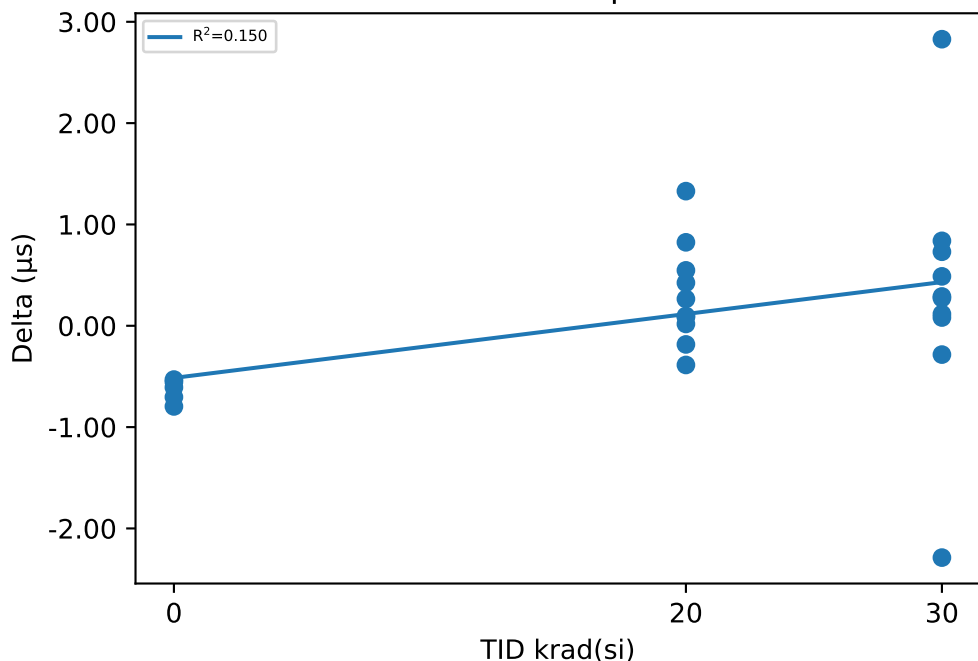

Test Statistics (µs)

krad(si)	Pre Exposure Min	Pre Exposure Avg	Pre Exposure Max	Pre Exposure Std	Post Exposure Min	Post Exposure Avg	Post Exposure Max	Post Exposure Std	Min Delta	Avg Delta	Max Delta	Std Delta
0	80.52	84.307	88.621	2.8774	79.989	83.668	87.826	2.7803	-0.7959	-0.6385	-0.5308	0.11032
20	81.719	84.5	87.016	1.7783	81.535	84.802	87.1	1.9079	-0.3866	0.3019	1.3288	0.50362
30	81.97	84.396	87.102	1.7672	82.26	84.703	87.208	1.7557	-2.2878	0.3073	2.8283	1.2482

Device Test: 15.25 UJ6AIM(TFALL_CH4_UJ6AIM)

TID vs Result Stats

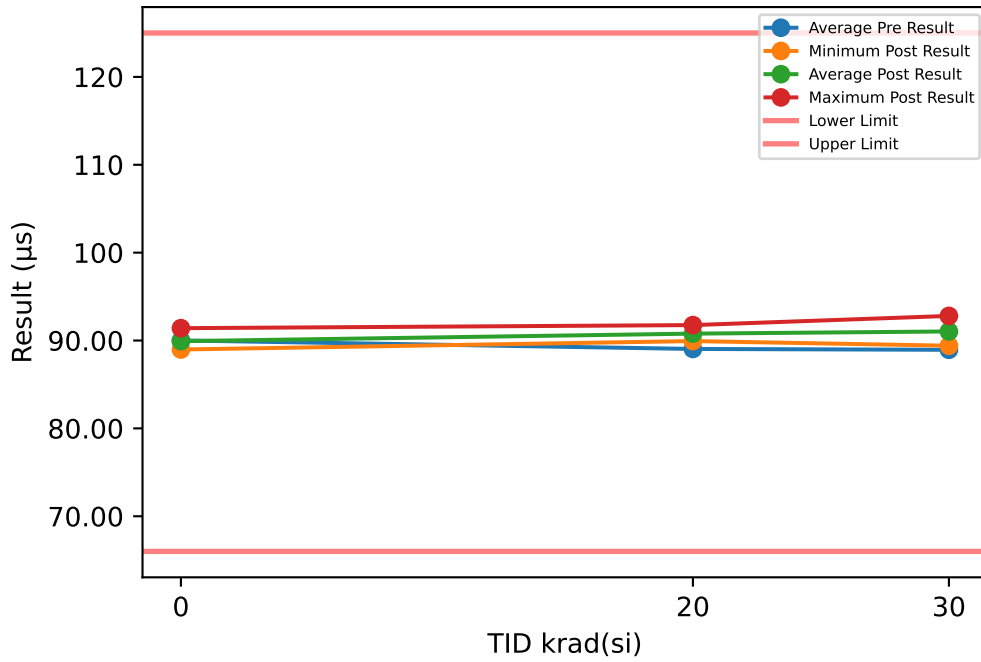

TID vs Post - Pre Exposure Delta

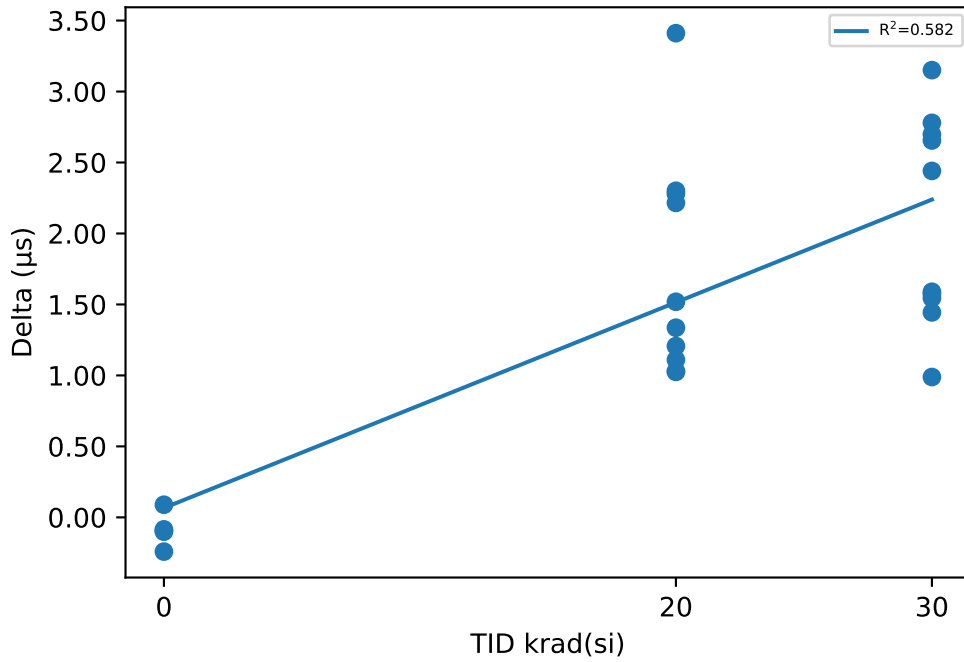

Test Results (Lower Limit = 66.0, Upper Limit = 125.0 (µs))

Serial #	krad(si)	Exposure Conditions	Pre Result	Post Result	Delta
1	20	HDR unbiased	89.39	90.42	1.0296
2	20	HDR unbiased	89.063	90.173	1.1101
3	20	HDR unbiased	90.431	91.455	1.0248
4	20	HDR unbiased	89.917	91.124	1.2069
5	20	HDR unbiased	88.601	89.937	1.3361
6	20	HDR biased	88.345	91.756	3.411
7	20	HDR biased	88.916	91.131	2.2155
8	20	HDR biased	88.169	90.469	2.3007
9	20	HDR biased	88.36	90.64	2.2794
10	20	HDR biased	89.221	90.74	1.5189
11	30	HDR unbiased	90.187	91.776	1.5893
12	30	HDR unbiased	87.864	89.409	1.5447
13	30	HDR unbiased	88.657	90.231	1.5735
14	30	HDR unbiased	87.547	90.698	3.1508
15	30	HDR unbiased	88.468	89.912	1.4439
16	30	HDR biased	90.145	92.8	2.6551
17	30	HDR biased	88.475	91.173	2.6982
18	30	HDR biased	89.568	92.348	2.7793
19	30	HDR biased	89.279	90.268	0.9888
20	30	HDR biased	89.259	91.7	2.4407
21	0	correlation	91.5	91.406	-0.0939
22	0	correlation	89.682	89.597	-0.0846
23	0	correlation	89.358	89.257	-0.1009
24	0	correlation	89.219	88.978	-0.2412
25	0	correlation	90.3	90.389	0.0889

Test Statistics (µs)

krad(si)	Pre Exposure Min	Pre Exposure Avg	Pre Exposure Max	Pre Exposure Std	Post Exposure Min	Post Exposure Avg	Post Exposure Max	Post Exposure Std	Min Delta	Avg Delta	Max Delta	Std Delta
0	89.219	90.012	91.5	0.93024	88.978	89.925	91.406	0.98213	-0.2412	-0.08634	0.0889	0.11722
20	88.169	89.041	90.431	0.72816	89.937	90.784	91.756	0.57508	1.0248	1.7433	3.411	0.78406
30	87.547	88.945	90.187	0.89649	89.409	91.032	92.8	1.1107	0.9888	2.0864	3.1508	0.73465

Device Test: 15.26 UJPEEL(SLEWRATE_ON_CH4_UJPEEL)

TID vs Result Stats

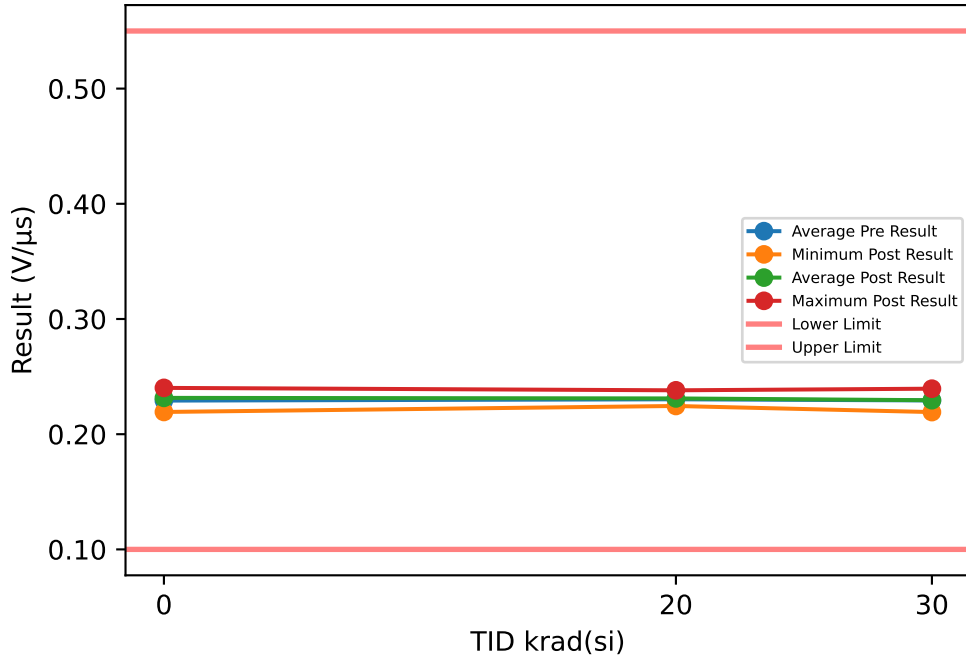

Test Results (Lower Limit = 0.1, Upper Limit = 0.55 (V/μs))

Serial #	krad(si)	Exposure Conditions	Pre Result	Post Result	Delta
1	20	HDR unbiased	0.2372	0.2364	-0.0008
2	20	HDR unbiased	0.2261	0.226	-0.0001
3	20	HDR unbiased	0.2366	0.237	0.0004
4	20	HDR unbiased	0.2381	0.2381	0
5	20	HDR unbiased	0.2363	0.2372	0.0009
6	20	HDR biased	0.2263	0.2245	-0.0018
7	20	HDR biased	0.224	0.2252	0.0012
8	20	HDR biased	0.2267	0.2282	0.0015
9	20	HDR biased	0.2274	0.2302	0.0028
10	20	HDR biased	0.2242	0.2277	0.0035
11	30	HDR unbiased	0.225	0.225	0
12	30	HDR unbiased	0.2338	0.2326	-0.0012
13	30	HDR unbiased	0.2187	0.2192	0.0005
14	30	HDR unbiased	0.2284	0.2268	-0.0016
15	30	HDR unbiased	0.2393	0.2395	0.0002
16	30	HDR biased	0.2367	0.2364	-0.0003
17	30	HDR biased	0.2226	0.2238	0.0012
18	30	HDR biased	0.2276	0.2284	0.0008
19	30	HDR biased	0.2284	0.2302	0.0018
20	30	HDR biased	0.2324	0.2331	0.0007
21	0	correlation	0.238	0.2402	0.0022
22	0	correlation	0.217	0.2193	0.0023
23	0	correlation	0.2278	0.2298	0.002
24	0	correlation	0.2342	0.2366	0.0024
25	0	correlation	0.2288	0.2318	0.003

TID vs Post - Pre Exposure Delta

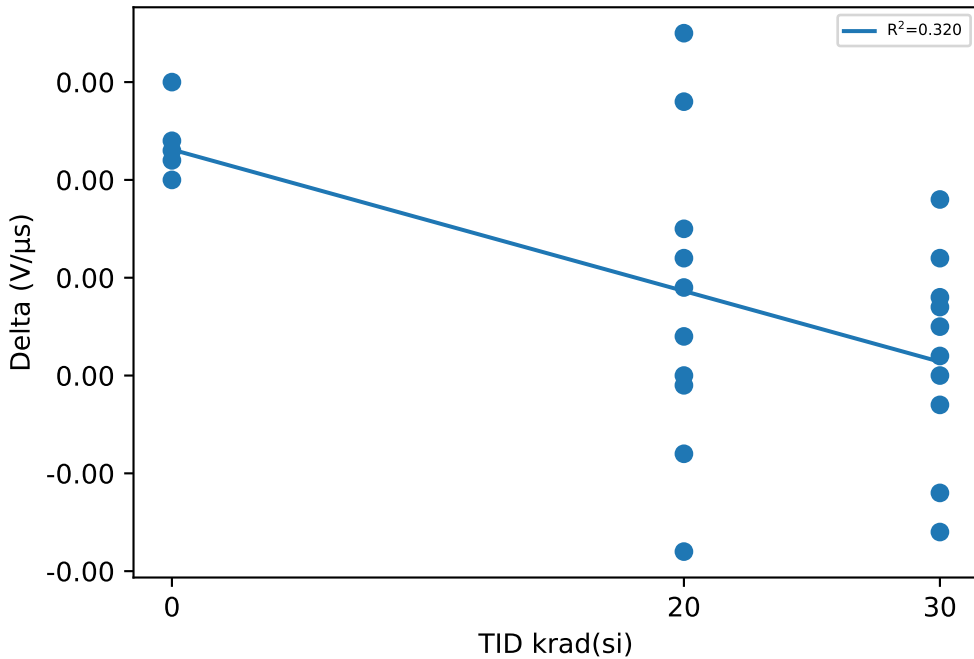

Test Statistics (V/μs)

krad(si)	Pre Exposure Min	Pre Exposure Avg	Pre Exposure Max	Pre Exposure Std	Post Exposure Min	Post Exposure Avg	Post Exposure Max	Post Exposure Std	Min Delta	Avg Delta	Max Delta	Std Delta
0	0.217	0.22916	0.238	0.0079591	0.2193	0.23154	0.2402	0.007961	0.002	0.00238	0.003	0.00037683
20	0.224	0.23029	0.2381	0.0059259	0.2245	0.23105	0.2381	0.0055201	-0.0018	0.00076	0.0035	0.0015939
30	0.2187	0.22929	0.2393	0.0063672	0.2192	0.2295	0.2395	0.0061283	-0.0016	0.00021	0.0018	0.0010408

Device Test: 15.27 UJD80I(SLEWRATE_OFF_CH4_UJD80I)

TID vs Result Stats

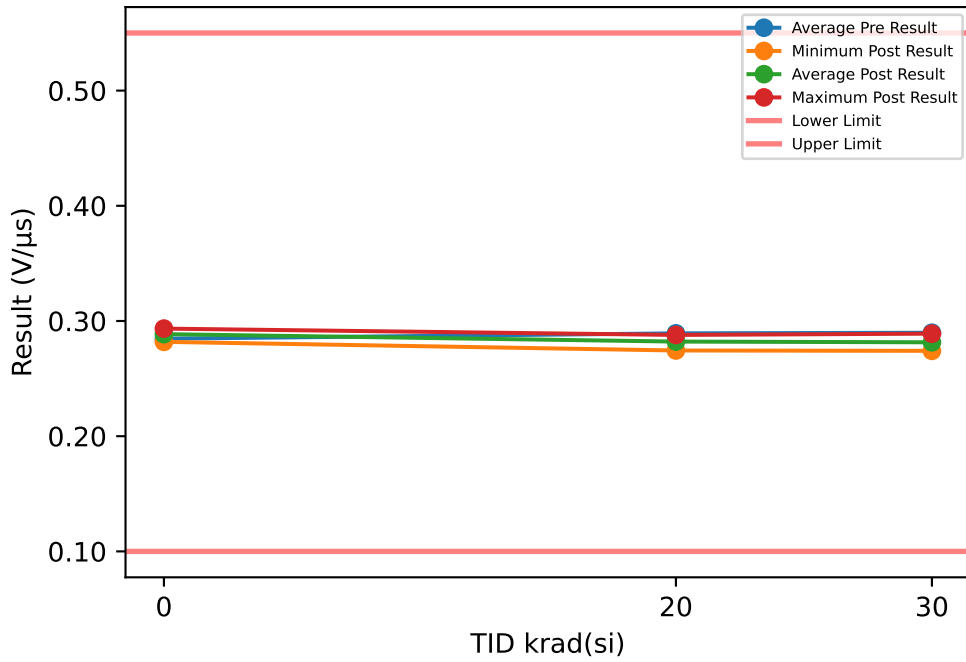

Test Results (Lower Limit = 0.1, Upper Limit = 0.55 (V/μs))

Serial #	krad(si)	Exposure Conditions	Pre Result	Post Result	Delta
1	20	HDR unbiased	0.2897	0.286	-0.0037
2	20	HDR unbiased	0.29	0.2879	-0.0021
3	20	HDR unbiased	0.2858	0.2831	-0.0027
4	20	HDR unbiased	0.2887	0.286	-0.0027
5	20	HDR unbiased	0.2913	0.2877	-0.0036
6	20	HDR biased	0.2895	0.2744	-0.0151
7	20	HDR biased	0.29	0.2792	-0.0108
8	20	HDR biased	0.291	0.2798	-0.0112
9	20	HDR biased	0.291	0.2787	-0.0123
10	20	HDR biased	0.2858	0.2786	-0.0072
11	30	HDR unbiased	0.291	0.2864	-0.0046
12	30	HDR unbiased	0.2926	0.289	-0.0036
13	30	HDR unbiased	0.2912	0.2856	-0.0056
14	30	HDR unbiased	0.2944	0.2849	-0.0095
15	30	HDR unbiased	0.2891	0.2848	-0.0043
16	30	HDR biased	0.286	0.2741	-0.0119
17	30	HDR biased	0.2909	0.2773	-0.0136
18	30	HDR biased	0.2866	0.2747	-0.0119
19	30	HDR biased	0.2895	0.2828	-0.0067
20	30	HDR biased	0.2867	0.2755	-0.0112
21	0	correlation	0.2781	0.2819	0.0038
22	0	correlation	0.2824	0.2872	0.0048
23	0	correlation	0.2895	0.2934	0.0039
24	0	correlation	0.2889	0.2922	0.0033
25	0	correlation	0.2843	0.2882	0.0039

TID vs Post - Pre Exposure Delta

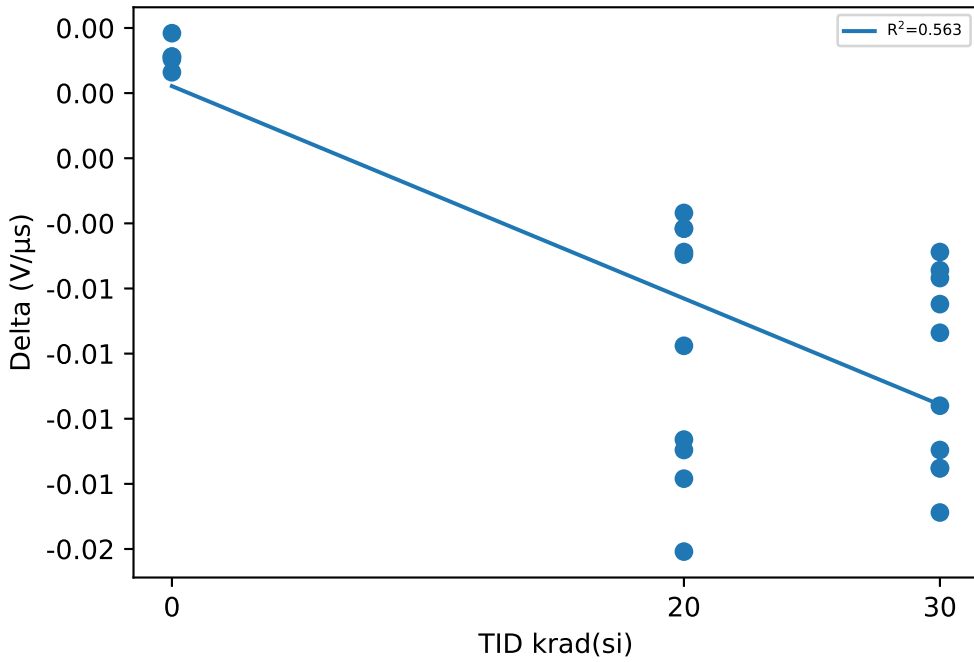

Test Statistics (V/μs)

krad(si)	Pre Exposure Min	Pre Exposure Avg	Pre Exposure Max	Pre Exposure Std	Post Exposure Min	Post Exposure Avg	Post Exposure Max	Post Exposure Std	Min Delta	Avg Delta	Max Delta	Std Delta
0	0.2781	0.28464	0.2895	0.0047348	0.2819	0.28858	0.2934	0.0045554	0.0033	0.00394	0.0048	0.00054129
20	0.2858	0.28928	0.2913	0.0019949	0.2744	0.28214	0.2879	0.0046333	-0.0151	-0.00714	-0.0021	0.0048197
30	0.286	0.2898	0.2944	0.0027584	0.2741	0.28151	0.289	0.0055362	-0.0136	-0.00829	-0.0036	0.0037341

Device Test: 15.28 UJHGWM(TMATCH_CH4_UJHGWM)

TID vs Result Stats

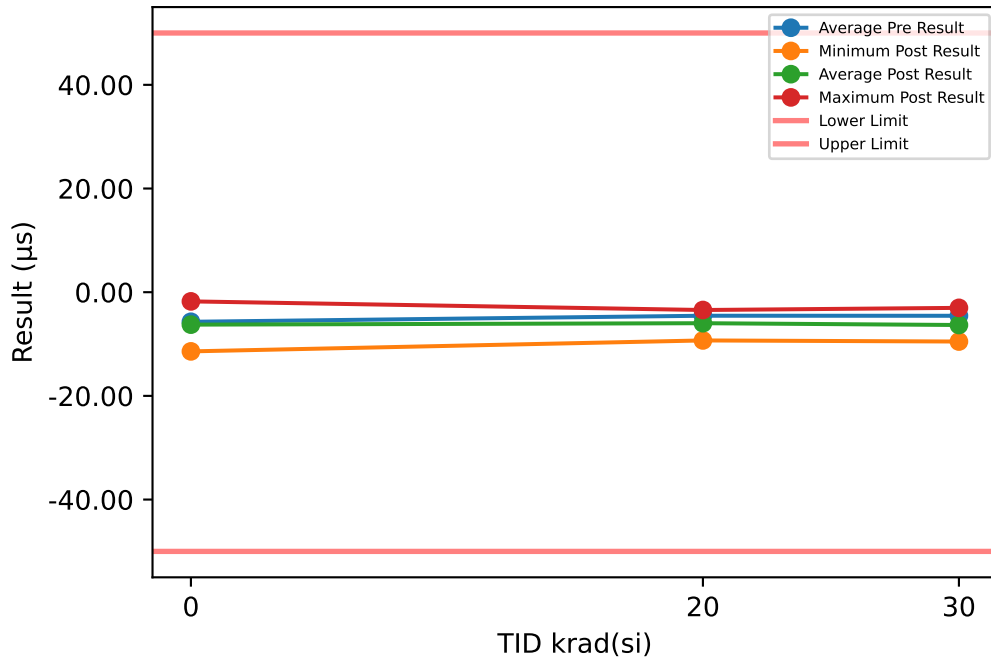

TID vs Post - Pre Exposure Delta

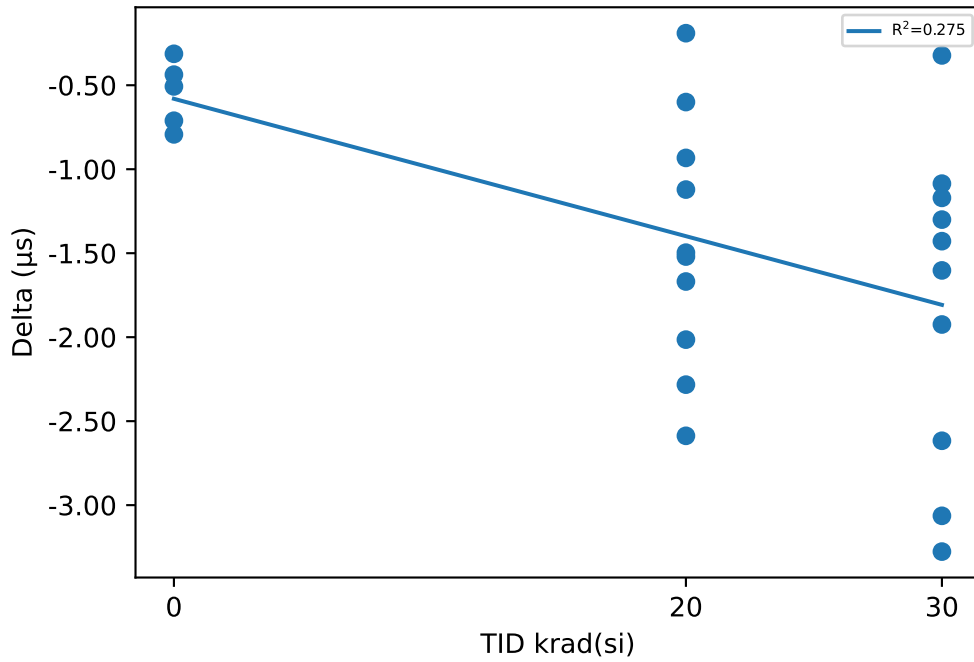

Test Results (Lower Limit = -50.0, Upper Limit = 50.0 (µs))

Serial #	krad(si)	Exposure Conditions	Pre Result	Post Result	Delta
1	20	HDR unbiased	-5.5502	-6.4829	-0.9327
2	20	HDR unbiased	-3.4031	-4.8999	-1.4968
3	20	HDR unbiased	-5.3557	-5.9559	-0.6002
4	20	HDR unbiased	-8.1839	-9.3051	-1.1212
5	20	HDR unbiased	-6.8822	-8.4022	-1.52
6	20	HDR biased	-3.3645	-5.9518	-2.5873
7	20	HDR biased	-2.3631	-4.0317	-1.6686
8	20	HDR biased	-1.1527	-3.4353	-2.2826
9	20	HDR biased	-4.049	-6.0636	-2.0146
10	20	HDR biased	-5.1056	-5.2958	-0.1902
11	30	HDR unbiased	-8.2166	-9.5166	-1.3
12	30	HDR unbiased	-3.7528	-5.1812	-1.4284
13	30	HDR unbiased	-1.9367	-3.0226	-1.0859
14	30	HDR unbiased	-4.2738	-4.5963	-0.3225
15	30	HDR unbiased	-6.2211	-7.3917	-1.1706
16	30	HDR biased	-6.6575	-8.582	-1.9245
17	30	HDR biased	-1.3729	-3.9896	-2.6167
18	30	HDR biased	-4.1236	-7.1872	-3.0636
19	30	HDR biased	-3.6778	-6.9544	-3.2766
20	30	HDR biased	-5.2585	-6.861	-1.6025
21	0	correlation	-10.979	-11.416	-0.437
22	0	correlation	-1.0604	-1.7717	-0.7113
23	0	correlation	-5.2956	-5.8027	-0.5071
24	0	correlation	-5.2328	-5.5457	-0.3129
25	0	correlation	-5.9575	-6.7501	-0.7926

Test Statistics (µs)

krad(si)	Pre Exposure Min	Pre Exposure Avg	Pre Exposure Max	Pre Exposure Std	Post Exposure Min	Post Exposure Avg	Post Exposure Max	Post Exposure Std	Min Delta	Avg Delta	Max Delta	Std Delta
0	-10.979	-5.7052	-1.0604	3.5301	-11.416	-6.2573	-1.7717	3.453	-0.7926	-0.55218	-0.3129	0.19728
20	-8.1839	-4.541	-1.1527	2.1055	-9.3051	-5.9824	-3.4353	1.7979	-2.5873	-1.4414	-0.1902	0.74867
30	-8.2166	-4.5491	-1.3729	2.1018	-9.5166	-6.3283	-3.0226	2.0683	-3.2766	-1.7791	-0.3225	0.94112

Device Test: 15.29 UJD1II(TCL_DEGLITCH1_UJD1II)

TID vs Result Stats

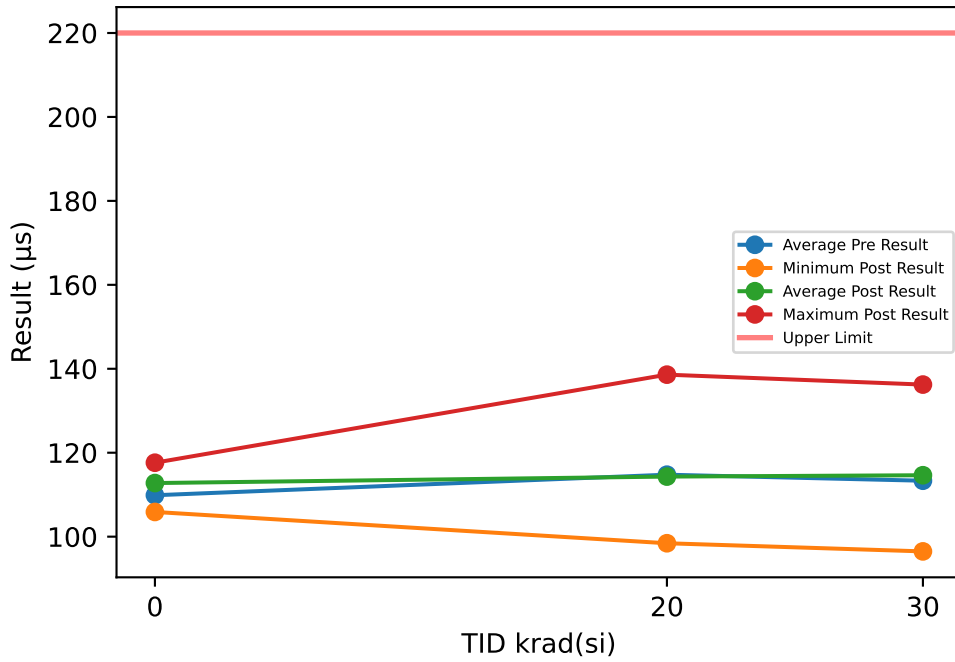

Test Results (Upper Limit = 220.0 (µs))

Serial #	krad(si)	Exposure Conditions	Pre Result	Post Result	Delta
1	20	HDR unbiased	90.645	104.56	13.91
2	20	HDR unbiased	93.994	127.13	33.14
3	20	HDR unbiased	116.26	107.16	-9.101
4	20	HDR unbiased	110.77	121.42	10.648
5	20	HDR unbiased	96.064	98.477	2.4133
6	20	HDR biased	128.31	138.6	10.289
7	20	HDR biased	97.92	98.43	0.51
8	20	HDR biased	133.45	110.56	-22.895
9	20	HDR biased	142.97	108.05	-34.915
10	20	HDR biased	137.25	128.75	-8.5032
11	30	HDR unbiased	87.132	115.36	28.224
12	30	HDR unbiased	135.59	117.85	-17.736
13	30	HDR unbiased	135.63	116.32	-19.31
14	30	HDR unbiased	124.84	136.24	11.397
15	30	HDR unbiased	92.969	99.017	6.0485
16	30	HDR biased	107.02	112.09	5.0637
17	30	HDR biased	116.85	96.489	-20.36
18	30	HDR biased	107.76	102.77	-4.9879
19	30	HDR biased	98.092	133.24	35.147
20	30	HDR biased	127.41	116.98	-10.435
21	0	correlation	118.66	105.89	-12.775
22	0	correlation	105.72	106.42	0.7017
23	0	correlation	108.28	117.53	9.2559
24	0	correlation	112.79	117.62	4.824
25	0	correlation	103.87	116.4	12.523

TID vs Post - Pre Exposure Delta

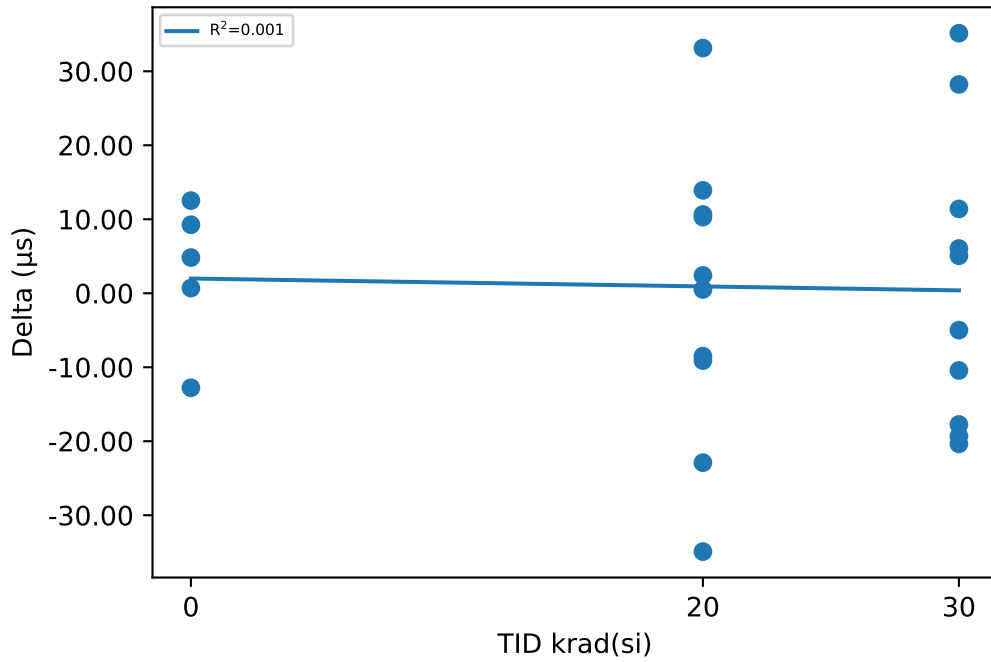

Test Statistics (µs)

krad(si)	Pre Exposure Min	Pre Exposure Avg	Pre Exposure Max	Pre Exposure Std	Post Exposure Min	Post Exposure Avg	Post Exposure Max	Post Exposure Std	Min Delta	Avg Delta	Max Delta	Std Delta
0	103.87	109.87	118.66	5.9489	105.89	112.77	117.62	6.0619	-12.775	2.9059	12.523	9.8394
20	90.645	114.76	142.97	19.716	98.43	114.31	138.6	13.808	-34.915	-0.45045	33.14	19.475
30	87.132	113.33	135.63	17.448	96.489	114.63	136.24	13.134	-20.36	1.3051	35.147	19.558

Device Test: 15.3 UJP09Y(TRISE_CH1_UJP09Y)

TID vs Result Stats

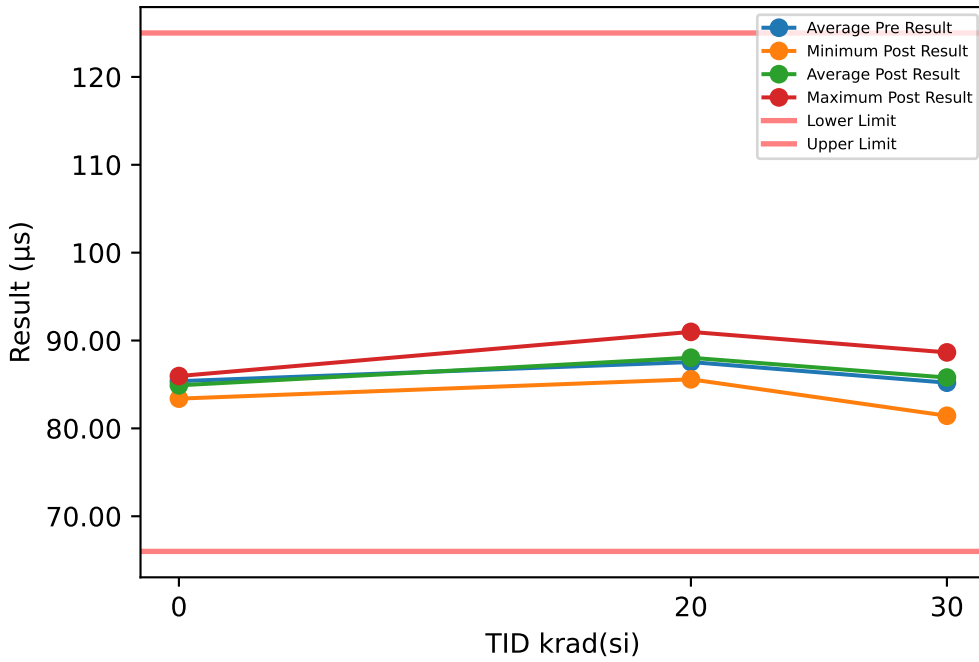

Test Results (Lower Limit = 66.0, Upper Limit = 125.0 (µs))

Serial #	krad(si)	Exposure Conditions	Pre Result	Post Result	Delta
1	20	HDR unbiased	86.943	87.382	0.4387
2	20	HDR unbiased	89.926	89.977	0.0514
3	20	HDR unbiased	86.855	88.111	1.256
4	20	HDR unbiased	88.275	88.524	0.2497
5	20	HDR unbiased	86.448	85.584	-0.8642
6	20	HDR biased	84.887	86.84	1.9529
7	20	HDR biased	90.031	90.983	0.9524
8	20	HDR biased	84.638	85.79	1.1526
9	20	HDR biased	90.698	90.928	0.2302
10	20	HDR biased	86.809	86.305	-0.504
11	30	HDR unbiased	81.484	81.437	-0.0469
12	30	HDR unbiased	87.756	88.649	0.8927
13	30	HDR unbiased	85.026	85.524	0.4985
14	30	HDR unbiased	87.045	87.047	0.0022
15	30	HDR unbiased	86.705	87.505	0.7991
16	30	HDR biased	84.774	85.29	0.5153
17	30	HDR biased	83.977	86.088	2.1111
18	30	HDR biased	83.767	84.163	0.3957
19	30	HDR biased	86.296	86.917	0.6208
20	30	HDR biased	85.189	85.246	0.0573
21	0	correlation	85.28	84.71	-0.5701
22	0	correlation	85.448	84.688	-0.7594
23	0	correlation	86.013	85.752	-0.2607
24	0	correlation	86.427	85.957	-0.4703
25	0	correlation	83.697	83.387	-0.3099

TID vs Post - Pre Exposure Delta

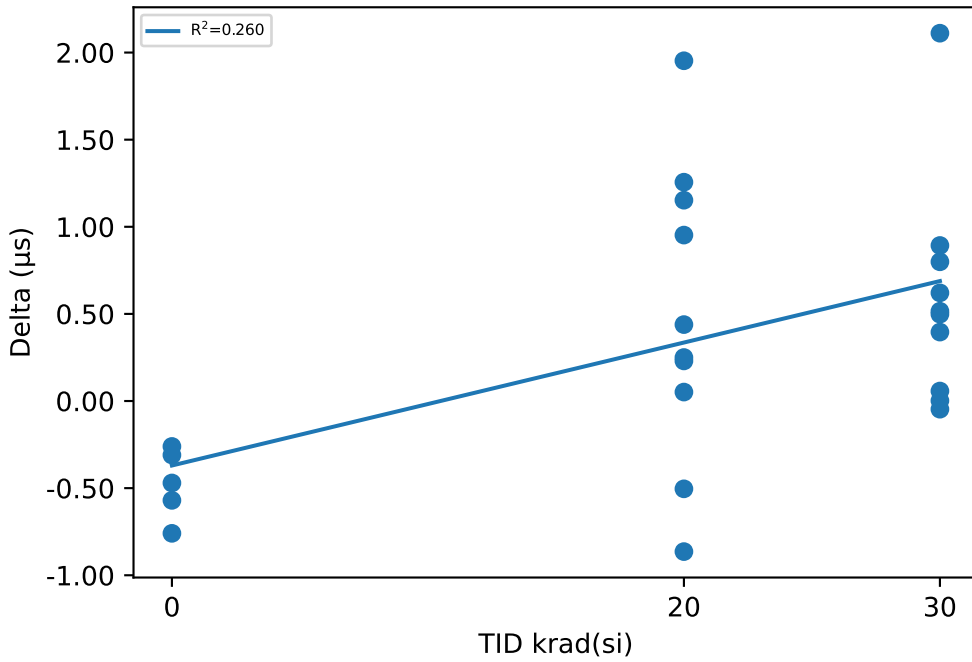

Test Statistics (µs)

krad(si)	Pre Exposure Min	Pre Exposure Avg	Pre Exposure Max	Pre Exposure Std	Post Exposure Min	Post Exposure Avg	Post Exposure Max	Post Exposure Std	Min Delta	Avg Delta	Max Delta	Std Delta
0	83.697	85.373	86.427	1.0422	83.387	84.899	85.957	1.0263	-0.7594	-0.47408	-0.2607	0.20195
20	84.638	87.551	90.698	2.1193	85.584	88.042	90.983	2.0269	-0.8642	0.49157	1.9529	0.85126
30	81.484	85.202	87.756	1.8553	81.437	85.787	88.649	2.0075	-0.0469	0.58458	2.1111	0.62684

Device Test: 15.4 UJ6AIM(TFALL_CH1_UJ6AIM)

TID vs Result Stats

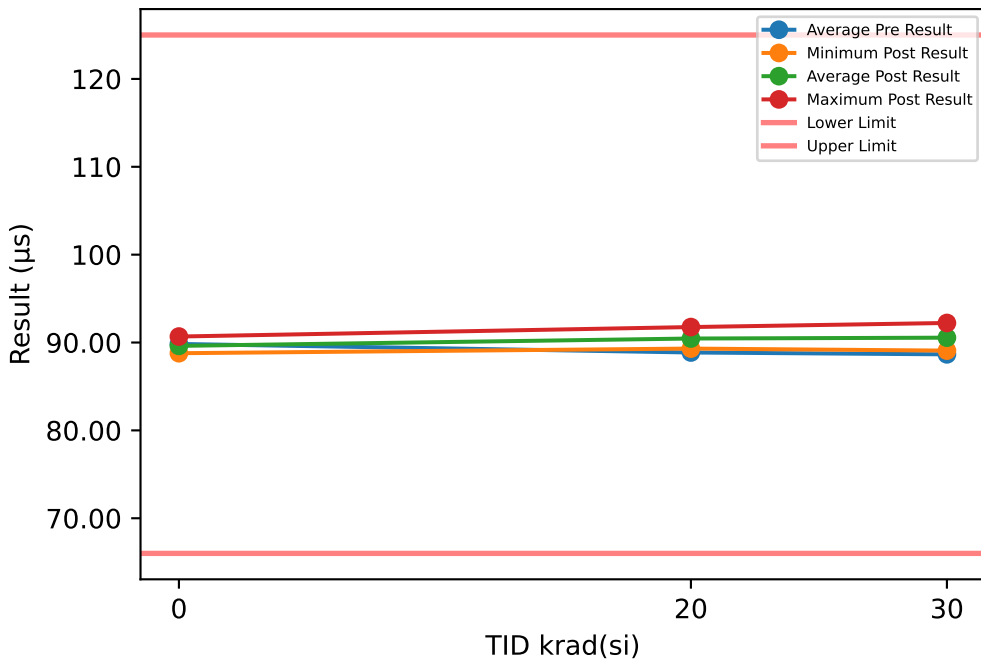

Test Results (Lower Limit = 66.0, Upper Limit = 125.0 (µs))

Serial #	krad(si)	Exposure Conditions	Pre Result	Post Result	Delta
1	20	HDR unbiased	88.81	89.77	0.9601
2	20	HDR unbiased	88.169	89.311	1.1418
3	20	HDR unbiased	90.907	91.76	0.8526
4	20	HDR unbiased	89.321	90.429	1.1085
5	20	HDR unbiased	88.877	89.848	0.9711
6	20	HDR biased	88.951	90.719	1.7681
7	20	HDR biased	88.391	90.693	2.3023
8	20	HDR biased	88.654	90.917	2.2628
9	20	HDR biased	88.112	90.04	1.9279
10	20	HDR biased	88.456	91.065	2.6091
11	30	HDR unbiased	90.481	91.793	1.3118
12	30	HDR unbiased	87.896	89.079	1.1835
13	30	HDR unbiased	88.489	89.945	1.456
14	30	HDR unbiased	87.81	89.774	1.9645
15	30	HDR unbiased	88.111	89.272	1.1606
16	30	HDR biased	89.656	92.036	2.3801
17	30	HDR biased	88.061	90.841	2.7799
18	30	HDR biased	87.66	90.5	2.8392
19	30	HDR biased	88.665	90.047	1.3823
20	30	HDR biased	89.721	92.225	2.504
21	0	correlation	91.092	90.681	-0.411
22	0	correlation	89.268	89.054	-0.2146
23	0	correlation	88.882	88.784	-0.0987
24	0	correlation	89.748	89.408	-0.3398
25	0	correlation	90.198	90.163	-0.0347

TID vs Post - Pre Exposure Delta

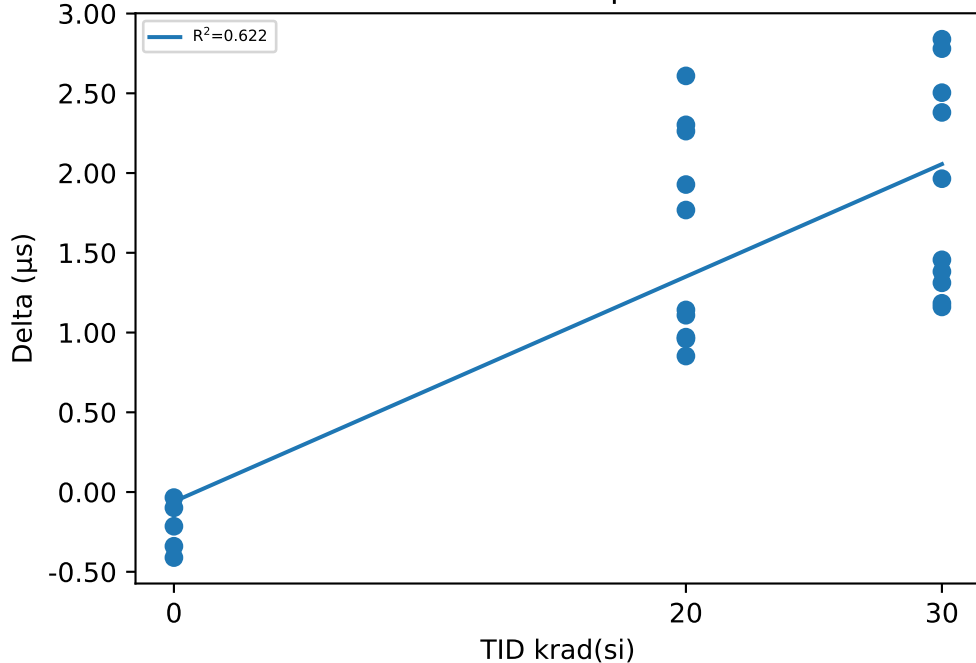

Test Statistics (µs)

krad(si)	Pre Exposure Min	Pre Exposure Avg	Pre Exposure Max	Pre Exposure Std	Post Exposure Min	Post Exposure Avg	Post Exposure Max	Post Exposure Std	Min Delta	Avg Delta	Max Delta	Std Delta
0	88.882	89.838	91.092	0.85861	88.784	89.618	90.681	0.78841	-0.411	-0.21976	-0.0347	0.15804
20	88.112	88.865	90.907	0.80815	89.311	90.455	91.76	0.72526	0.8526	1.5904	2.6091	0.65835
30	87.66	88.655	90.481	0.96764	89.079	90.551	92.225	1.1383	1.1606	1.8962	2.8392	0.67716

Device Test: 15.5 UJPEEL(SLEWRATE_ON_CH1_UJPEEL)

TID vs Result Stats

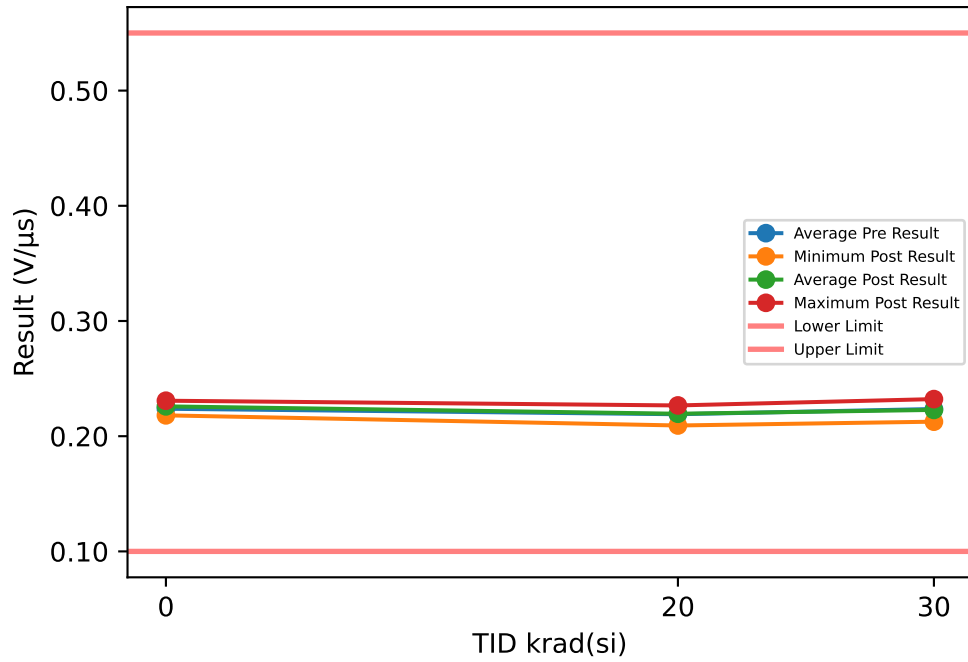

Test Results (Lower Limit = 0.1, Upper Limit = 0.55 (V/μs))

Serial #	krad(si)	Exposure Conditions	Pre Result	Post Result	Delta
1	20	HDR unbiased	0.2276	0.2267	-0.0009
2	20	HDR unbiased	0.2093	0.2093	0
3	20	HDR unbiased	0.2192	0.2206	0.0014
4	20	HDR unbiased	0.2195	0.2204	0.0009
5	20	HDR unbiased	0.216	0.2181	0.0021
6	20	HDR biased	0.2256	0.2193	-0.0063
7	20	HDR biased	0.2183	0.2193	0.001
8	20	HDR biased	0.2242	0.2233	-0.0009
9	20	HDR biased	0.2126	0.2122	-0.0004
10	20	HDR biased	0.2183	0.2258	0.0075
11	30	HDR unbiased	0.232	0.2292	-0.0028
12	30	HDR unbiased	0.215	0.2126	-0.0024
13	30	HDR unbiased	0.222	0.2235	0.0015
14	30	HDR unbiased	0.2223	0.2151	-0.0072
15	30	HDR unbiased	0.2219	0.221	-0.0009
16	30	HDR biased	0.2302	0.2307	0.0005
17	30	HDR biased	0.2213	0.2186	-0.0027
18	30	HDR biased	0.233	0.2322	-0.0008
19	30	HDR biased	0.2162	0.2241	0.0079
20	30	HDR biased	0.2222	0.2211	-0.0011
21	0	correlation	0.2233	0.2254	0.0021
22	0	correlation	0.2292	0.2308	0.0016
23	0	correlation	0.2282	0.2306	0.0024
24	0	correlation	0.2158	0.2181	0.0023
25	0	correlation	0.2226	0.2246	0.002

TID vs Post - Pre Exposure Delta

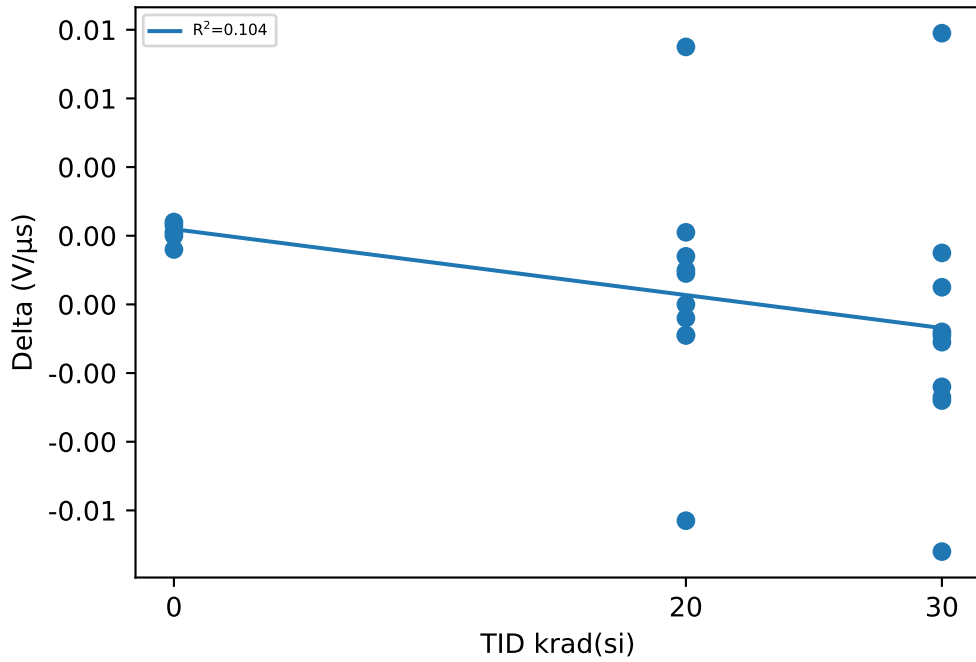

Test Statistics (V/μs)

krad(si)	Pre Exposure Min	Pre Exposure Avg	Pre Exposure Max	Pre Exposure Std	Post Exposure Min	Post Exposure Avg	Post Exposure Max	Post Exposure Std	Min Delta	Avg Delta	Max Delta	Std Delta
0	0.2158	0.22382	0.2292	0.0053434	0.2181	0.2259	0.2308	0.0052173	0.0016	0.00208	0.0024	0.00031145
20	0.2093	0.21906	0.2276	0.0056749	0.2093	0.2195	0.2267	0.0054504	-0.0063	0.00044	0.0075	0.0033988
30	0.215	0.22361	0.233	0.0061967	0.2126	0.22281	0.2322	0.0065065	-0.0072	-0.0008	0.0079	0.0038572

Device Test: 15.6 UJD80I(SLEWRATE_OFF_CH1_UJD80I)

TID vs Result Stats

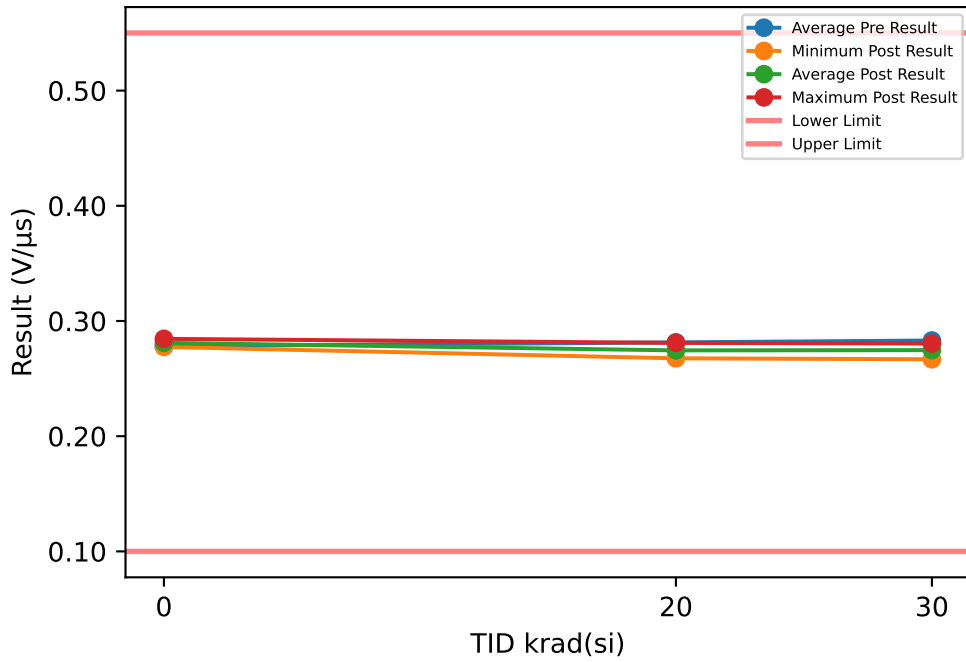

Test Results (Lower Limit = 0.1, Upper Limit = 0.55 (V/μs))

Serial #	krad(si)	Exposure Conditions	Pre Result	Post Result	Delta
1	20	HDR unbiased	0.281	0.2786	-0.0024
2	20	HDR unbiased	0.2833	0.281	-0.0023
3	20	HDR unbiased	0.2755	0.2728	-0.0027
4	20	HDR unbiased	0.282	0.2781	-0.0039
5	20	HDR unbiased	0.2836	0.281	-0.0026
6	20	HDR biased	0.2818	0.2676	-0.0142
7	20	HDR biased	0.2842	0.2722	-0.012
8	20	HDR biased	0.2804	0.2698	-0.0106
9	20	HDR biased	0.284	0.2725	-0.0115
10	20	HDR biased	0.2786	0.2714	-0.0072
11	30	HDR unbiased	0.2837	0.2789	-0.0048
12	30	HDR unbiased	0.2839	0.2798	-0.0041
13	30	HDR unbiased	0.2827	0.2772	-0.0055
14	30	HDR unbiased	0.2851	0.2794	-0.0057
15	30	HDR unbiased	0.2836	0.2804	-0.0032
16	30	HDR biased	0.2822	0.2706	-0.0116
17	30	HDR biased	0.2824	0.2692	-0.0132
18	30	HDR biased	0.2854	0.2711	-0.0143
19	30	HDR biased	0.2834	0.2736	-0.0098
20	30	HDR biased	0.2781	0.2668	-0.0113
21	0	correlation	0.2752	0.2796	0.0044
22	0	correlation	0.279	0.2813	0.0023
23	0	correlation	0.2819	0.2845	0.0026
24	0	correlation	0.2801	0.2822	0.0021
25	0	correlation	0.2749	0.2775	0.0026

TID vs Post - Pre Exposure Delta

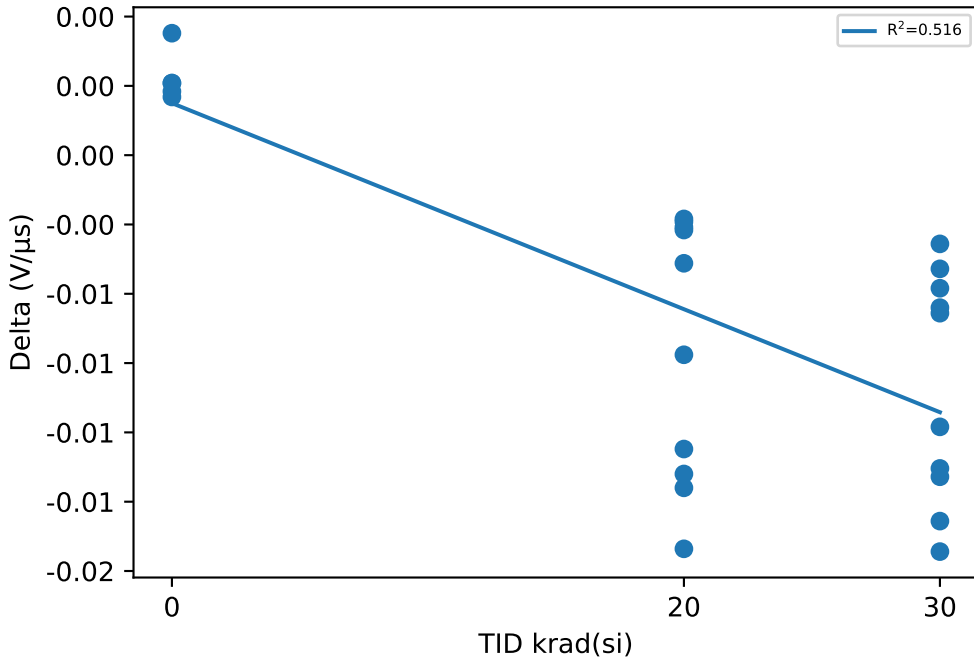

Test Statistics (V/μs)

krad(si)	Pre Exposure Min	Pre Exposure Avg	Pre Exposure Max	Pre Exposure Std	Post Exposure Min	Post Exposure Avg	Post Exposure Max	Post Exposure Std	Min Delta	Avg Delta	Max Delta	Std Delta
0	0.2749	0.27822	0.2819	0.0030752	0.2775	0.28102	0.2845	0.0026452	0.0021	0.0028	0.0044	0.00091924
20	0.2755	0.28144	0.2842	0.0027359	0.2676	0.2745	0.281	0.0047814	-0.0142	-0.00694	-0.0023	0.004723
30	0.2781	0.28305	0.2854	0.0020294	0.2668	0.2747	0.2804	0.0050345	-0.0143	-0.00835	-0.0032	0.004118

Device Test: 15.7 UJHGWM(TMATCH_CH1_UJHGWM)

TID vs Result Stats

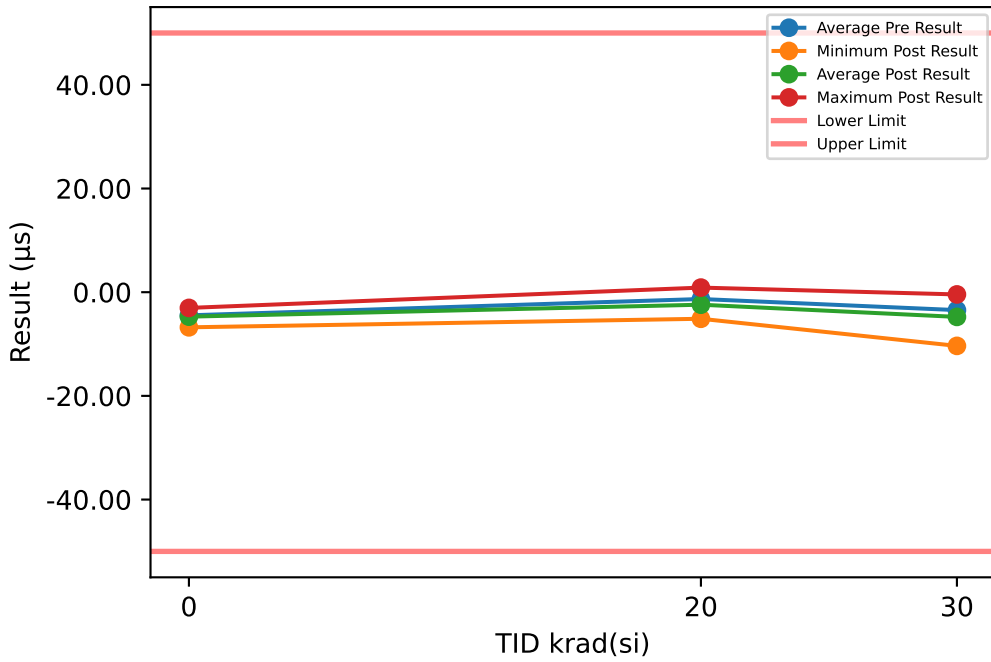

Test Results (Lower Limit = -50.0, Upper Limit = 50.0 (µs))

Serial #	krad(si)	Exposure Conditions	Pre Result	Post Result	Delta
1	20	HDR unbiased	-1.8671	-2.3884	-0.5213
2	20	HDR unbiased	1.7567	0.6663	-1.0904
3	20	HDR unbiased	-4.0529	-3.6494	0.4035
4	20	HDR unbiased	-1.0463	-1.9049	-0.8586
5	20	HDR unbiased	-2.4287	-4.264	-1.8353
6	20	HDR biased	-4.0641	-3.8792	0.1849
7	20	HDR biased	1.64	0.2901	-1.3499
8	20	HDR biased	-4.0164	-5.1265	-1.1101
9	20	HDR biased	2.5853	0.8876	-1.6977
10	20	HDR biased	-1.6467	-4.7599	-3.1132
11	30	HDR unbiased	-8.9971	-10.356	-1.3586
12	30	HDR unbiased	-0.1393	-0.4301	-0.2908
13	30	HDR unbiased	-3.4637	-4.4212	-0.9575
14	30	HDR unbiased	-0.765	-2.7273	-1.9623
15	30	HDR unbiased	-1.4058	-1.7673	-0.3615
16	30	HDR biased	-4.8812	-6.746	-1.8648
17	30	HDR biased	-4.0839	-4.7527	-0.6688
18	30	HDR biased	-3.893	-6.3366	-2.4436
19	30	HDR biased	-2.3687	-3.1303	-0.7616
20	30	HDR biased	-4.5322	-6.9789	-2.4467
21	0	correlation	-5.812	-5.9711	-0.1591
22	0	correlation	-3.8208	-4.3654	-0.5446
23	0	correlation	-2.8698	-3.0318	-0.162
24	0	correlation	-3.3203	-3.4508	-0.1305
25	0	correlation	-6.5007	-6.7759	-0.2752

TID vs Post - Pre Exposure Delta

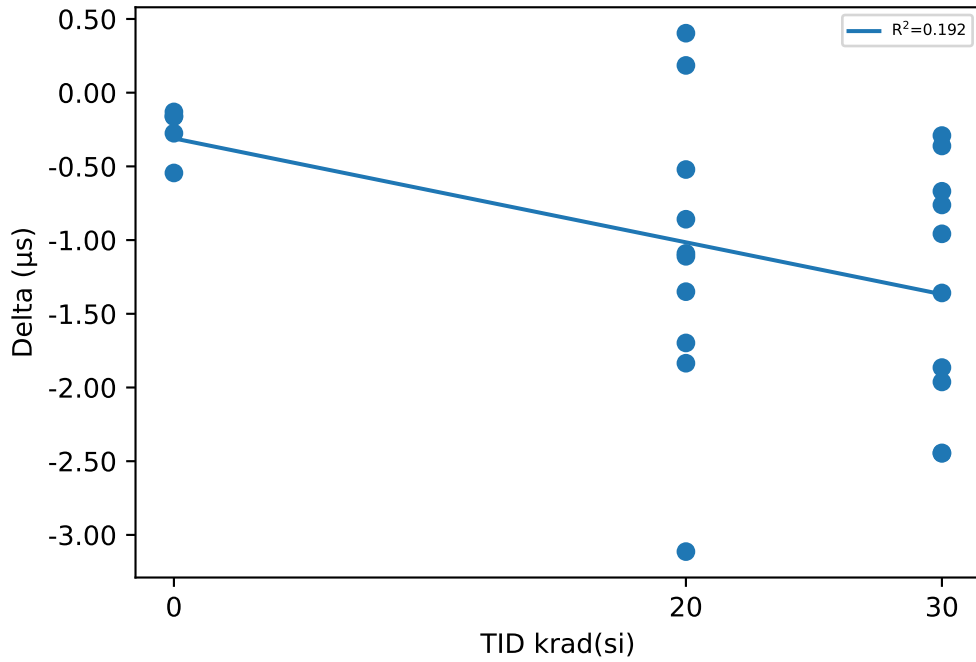

Test Statistics (µs)

krad(si)	Pre Exposure Min	Pre Exposure Avg	Pre Exposure Max	Pre Exposure Std	Post Exposure Min	Post Exposure Avg	Post Exposure Max	Post Exposure Std	Min Delta	Avg Delta	Max Delta	Std Delta
0	-6.5007	-4.4647	-2.8698	1.5991	-6.7759	-4.719	-3.0318	1.6108	-0.5446	-0.25428	-0.1305	0.17148
20	-4.0641	-1.314	2.5853	2.5267	-5.1265	-2.4128	0.8876	2.3074	-3.1132	-1.0988	0.4035	1.0175
30	-8.9971	-3.453	-0.1393	2.5409	-10.356	-4.7646	-0.4301	2.9301	-2.4467	-1.3116	-0.2908	0.82242

Device Test: 15.8 UJ33GQ(TON_DELAY_CH2_UJ33GQ)

TID vs Result Stats

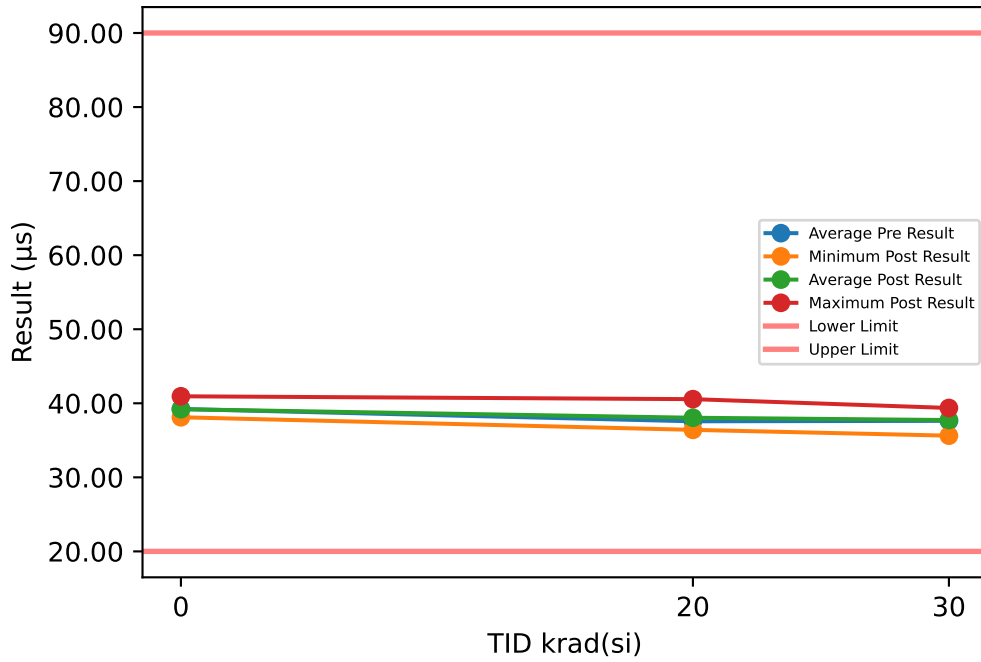

Test Results (Lower Limit = 20.0, Upper Limit = 90.0 (µs))

Serial #	krad(si)	Exposure Conditions	Pre Result	Post Result	Delta
1	20	HDR unbiased	38.218	38.506	0.2878
2	20	HDR unbiased	37.177	37.686	0.5094
3	20	HDR unbiased	39.717	40.558	0.8412
4	20	HDR unbiased	36.402	36.744	0.3426
5	20	HDR unbiased	36.078	36.412	0.3333
6	20	HDR biased	38.56	36.49	-2.0703
7	20	HDR biased	36.834	37.607	0.7729
8	20	HDR biased	36.953	38.014	1.061
9	20	HDR biased	38.757	38.923	0.1658
10	20	HDR biased	36.964	39.529	2.5646
11	30	HDR unbiased	35.382	35.628	0.246
12	30	HDR unbiased	38.895	38.827	-0.0683
13	30	HDR unbiased	36.454	36.825	0.3707
14	30	HDR unbiased	37.99	37.405	-0.5847
15	30	HDR unbiased	36.9	36.633	-0.267
16	30	HDR biased	39.202	39.369	0.1667
17	30	HDR biased	36.874	37.223	0.3483
18	30	HDR biased	38.745	38.535	-0.21
19	30	HDR biased	37.656	39.202	1.5465
20	30	HDR biased	38.203	37.74	-0.4631
21	0	correlation	41.015	40.944	-0.0712
22	0	correlation	38.527	38.594	0.0672
23	0	correlation	38.365	38.112	-0.2531
24	0	correlation	39.916	39.883	-0.033
25	0	correlation	38.315	38.461	0.1464

TID vs Post - Pre Exposure Delta

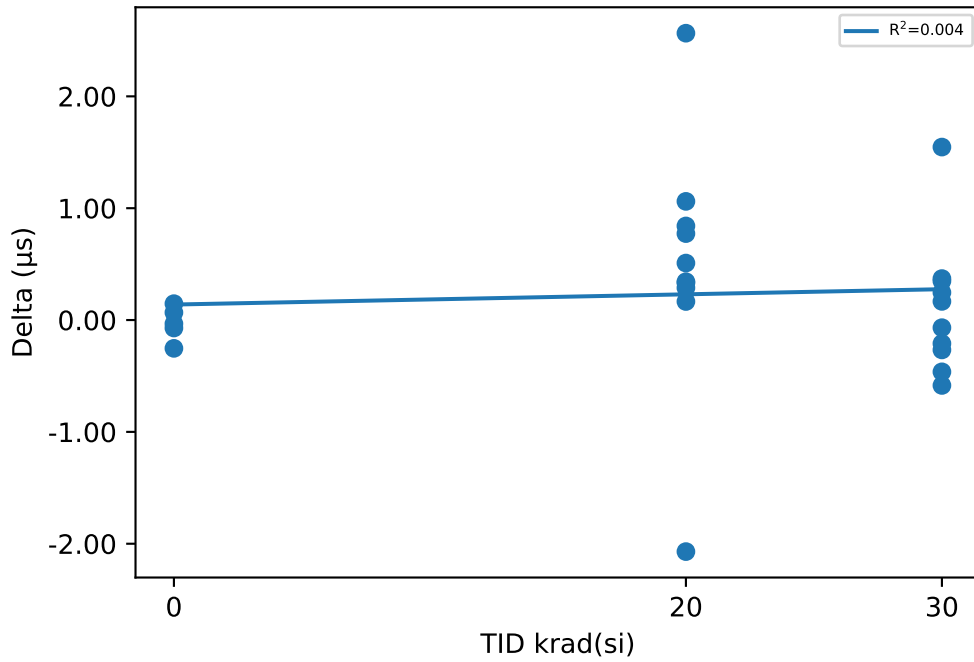

Test Statistics (µs)

krad(si)	Pre Exposure Min	Pre Exposure Avg	Pre Exposure Max	Pre Exposure Std	Post Exposure Min	Post Exposure Avg	Post Exposure Max	Post Exposure Std	Min Delta	Avg Delta	Max Delta	Std Delta
0	38.315	39.228	41.015	1.1978	38.112	39.199	40.944	1.1838	-0.2531	-0.02874	0.1464	0.15169
20	36.078	37.566	39.717	1.1763	36.412	38.047	40.558	1.3581	-2.0703	0.48083	2.5646	1.1343
30	35.382	37.63	39.202	1.2163	35.628	37.739	39.369	1.2251	-0.5847	0.10851	1.5465	0.60529

Device Test: 15.9 UJZB3P(TOFF_DELAY_CH2_UJZB3P)

TID vs Result Stats

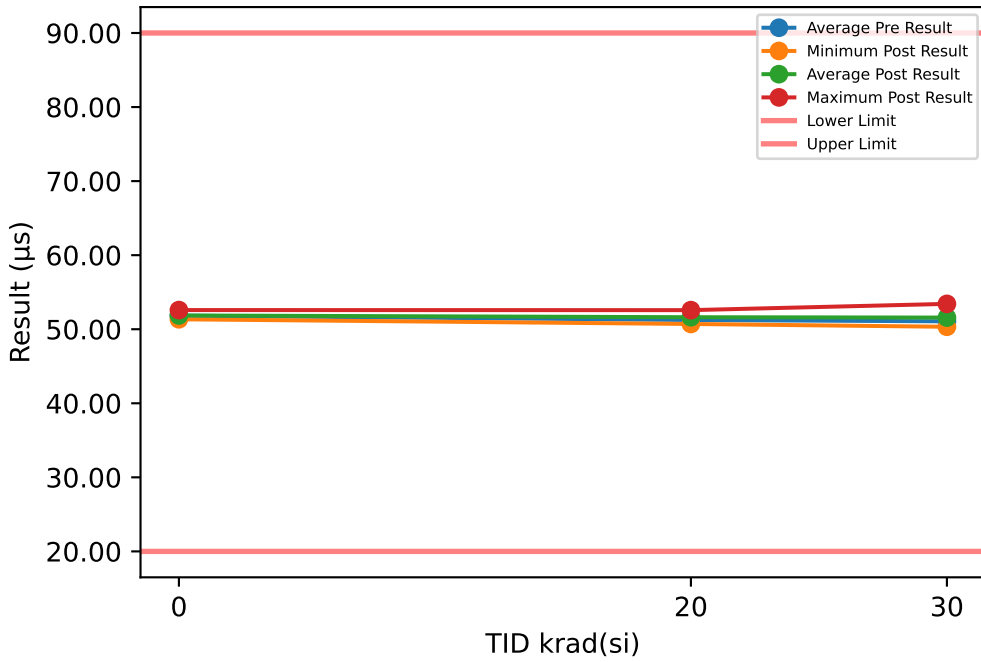

TID vs Post - Pre Exposure Delta

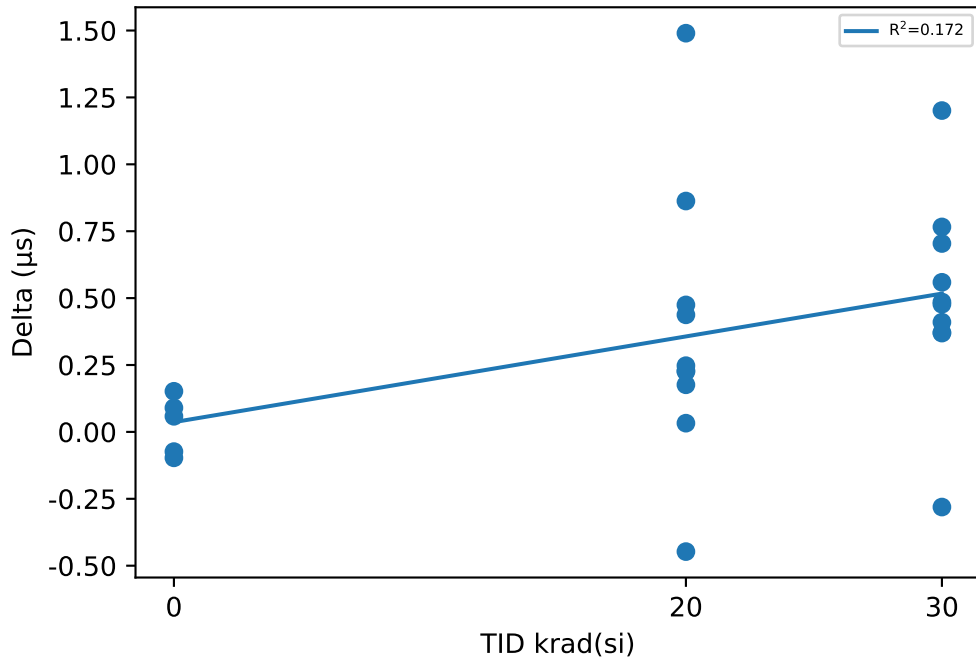

Test Results (Lower Limit = 20.0, Upper Limit = 90.0 (µs))

Serial #	krad(si)	Exposure Conditions	Pre Result	Post Result	Delta
1	20	HDR unbiased	51.766	51.994	0.2284
2	20	HDR unbiased	52.102	52.577	0.4746
3	20	HDR unbiased	52.301	52.333	0.0326
4	20	HDR unbiased	51.633	52.07	0.4375
5	20	HDR unbiased	51.078	51.325	0.2475
6	20	HDR biased	51.569	51.122	-0.4473
7	20	HDR biased	50.535	50.711	0.1761
8	20	HDR biased	50.076	50.939	0.8628
9	20	HDR biased	51.135	51.36	0.2253
10	20	HDR biased	50.274	51.764	1.49
11	30	HDR unbiased	52.946	53.423	0.4771
12	30	HDR unbiased	50.977	51.386	0.41
13	30	HDR unbiased	51.091	51.46	0.3693
14	30	HDR unbiased	50.233	51.434	1.2009
15	30	HDR unbiased	49.773	50.332	0.5591
16	30	HDR biased	51.383	51.754	0.3713
17	30	HDR biased	50.801	51.505	0.7041
18	30	HDR biased	50.819	51.585	0.766
19	30	HDR biased	51.021	50.74	-0.2808
20	30	HDR biased	51.623	52.109	0.4856
21	0	correlation	52.434	52.586	0.1518
22	0	correlation	51.294	51.383	0.0899
23	0	correlation	51.44	51.343	-0.0969
24	0	correlation	51.911	51.969	0.0583
25	0	correlation	52.095	52.022	-0.0736

Test Statistics (µs)

krad(si)	Pre Exposure Min	Pre Exposure Avg	Pre Exposure Max	Pre Exposure Std	Post Exposure Min	Post Exposure Avg	Post Exposure Max	Post Exposure Std	Min Delta	Avg Delta	Max Delta	Std Delta
0	51.294	51.835	52.434	0.46949	51.343	51.861	52.586	0.51462	-0.0969	0.0259	0.1518	0.10721
20	50.076	51.247	52.301	0.76238	50.711	51.62	52.577	0.62194	-0.4473	0.37275	1.49	0.51511
30	49.773	51.066	52.946	0.84678	50.332	51.573	53.423	0.81976	-0.2808	0.50626	1.2009	0.374

Device Test: 16.1 UJY13V(TCS_OFF1_UJY13V)

TID vs Result Stats

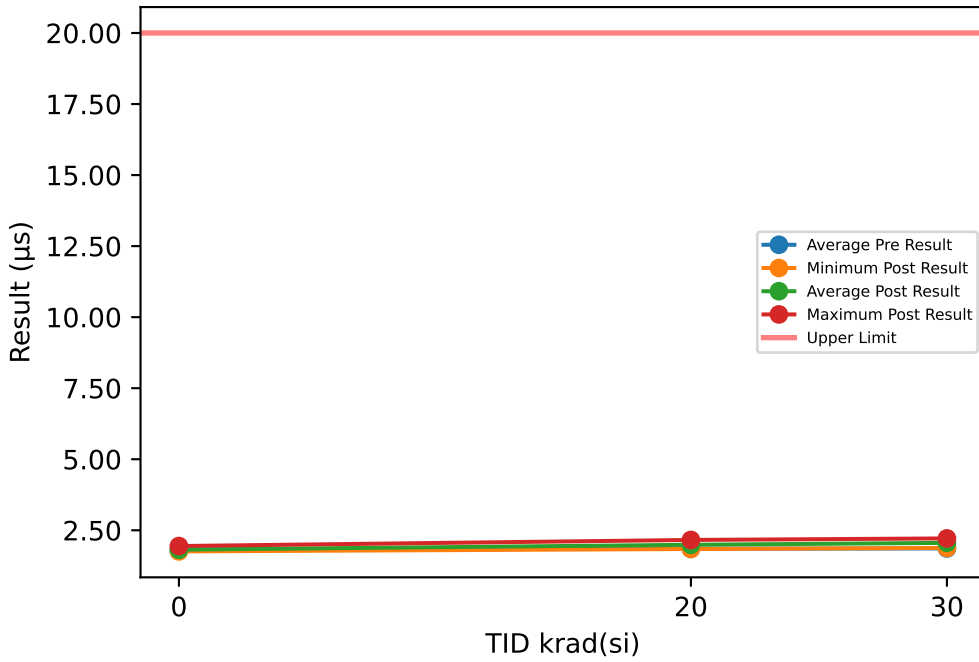

Test Results (Upper Limit = 20.0 (µs))

Serial #	krad(si)	Exposure Conditions	Pre Result	Post Result	Delta
1	20	HDR unbiased	1.881	1.96	0.079
2	20	HDR unbiased	1.801	1.881	0.08
3	20	HDR unbiased	1.827	1.841	0.014
4	20	HDR unbiased	1.906	1.96	0.054
5	20	HDR unbiased	1.829	1.919	0.09
6	20	HDR biased	1.803	2.027	0.224
7	20	HDR biased	1.827	2.028	0.201
8	20	HDR biased	1.828	2.118	0.29
9	20	HDR biased	1.921	2.16	0.239
10	20	HDR biased	1.881	2.001	0.12
11	30	HDR unbiased	1.8	1.879	0.079
12	30	HDR unbiased	1.908	1.973	0.065
13	30	HDR unbiased	1.854	1.908	0.054
14	30	HDR unbiased	1.91	1.946	0.036
15	30	HDR unbiased	1.92	1.947	0.027
16	30	HDR biased	1.867	2.161	0.294
17	30	HDR biased	1.841	2.201	0.36
18	30	HDR biased	1.868	2.172	0.304
19	30	HDR biased	1.788	2.214	0.426
20	30	HDR biased	1.854	2.175	0.321
21	0	correlation	1.827	1.826	-0.001
22	0	correlation	1.813	1.8	-0.013
23	0	correlation	1.907	1.946	0.039
24	0	correlation	1.815	1.757	-0.058
25	0	correlation	1.785	1.76	-0.025

TID vs Post - Pre Exposure Delta

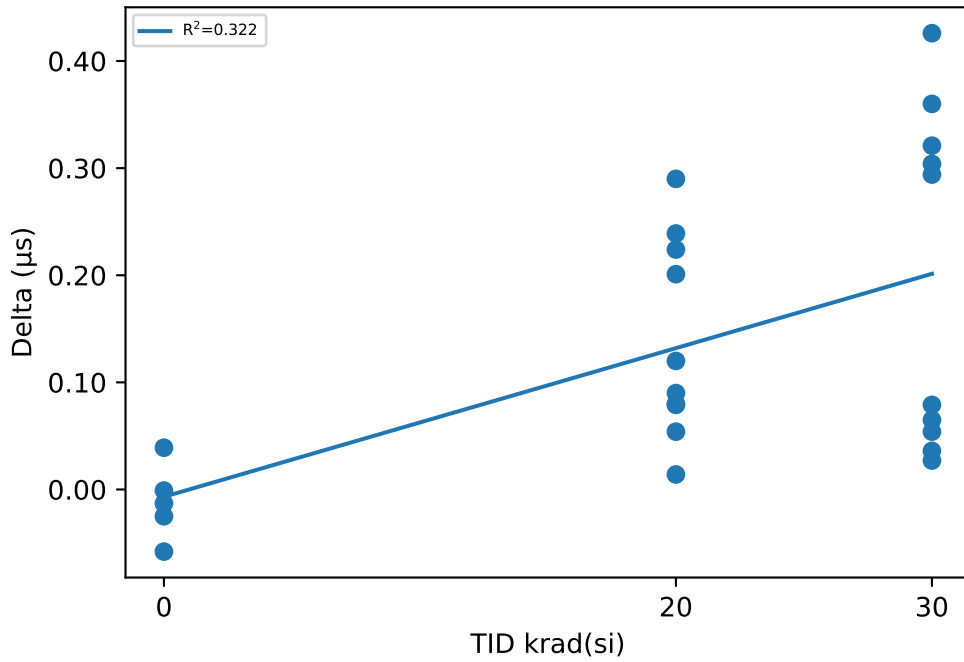

Test Statistics (µs)

krad(si)	Pre Exposure Min	Pre Exposure Avg	Pre Exposure Max	Pre Exposure Std	Post Exposure Min	Post Exposure Avg	Post Exposure Max	Post Exposure Std	Min Delta	Avg Delta	Max Delta	Std Delta
0	1.785	1.8294	1.907	0.04603	1.757	1.8178	1.946	0.077228	-0.058	-0.0116	0.039	0.035381
20	1.801	1.8504	1.921	0.043064	1.841	1.9895	2.16	0.09952	0.014	0.1391	0.29	0.092233
30	1.788	1.861	1.92	0.044377	1.879	2.0576	2.214	0.13691	0.027	0.1966	0.426	0.15701

Device Test: 16.2 UJXNQ0(TCS_ON1_UJXNQ0)

TID vs Result Stats

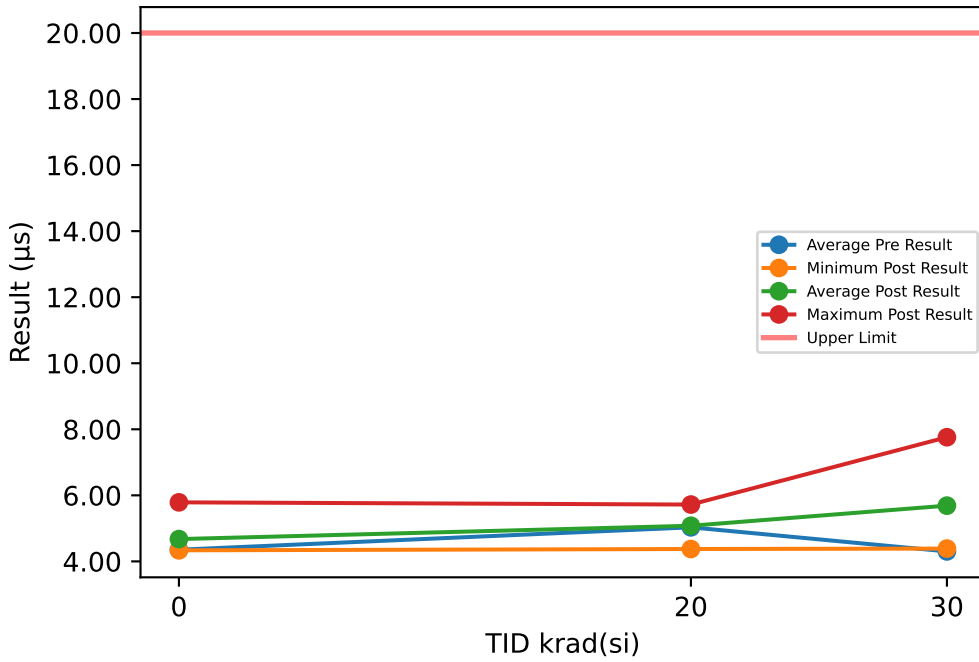

Test Results (Upper Limit = 20.0 (µs))

Serial #	krad(si)	Exposure Conditions	Pre Result	Post Result	Delta
1	20	HDR unbiased	4.548	4.762	0.214
2	20	HDR unbiased	4.361	4.636	0.275
3	20	HDR unbiased	4.481	4.708	0.227
4	20	HDR unbiased	4.227	4.375	0.148
5	20	HDR unbiased	10.48	4.695	-5.785
6	20	HDR biased	4.521	5.442	0.921
7	20	HDR biased	4.522	5.721	1.199
8	20	HDR biased	4.385	5.585	1.2
9	20	HDR biased	4.335	5.389	1.054
10	20	HDR biased	4.453	5.479	1.026
11	30	HDR unbiased	4.43	4.64	0.21
12	30	HDR unbiased	4.185	4.6	0.415
13	30	HDR unbiased	4.082	4.399	0.317
14	30	HDR unbiased	4.441	4.706	0.265
15	30	HDR unbiased	4.081	4.388	0.307
16	30	HDR biased	4.403	6.904	2.501
17	30	HDR biased	4.418	6.799	2.381
18	30	HDR biased	4.319	6.481	2.162
19	30	HDR biased	4.427	7.76	3.333
20	30	HDR biased	4.24	6.2	1.96
21	0	correlation	4.547	4.506	-0.041
22	0	correlation	4.057	5.788	1.731
23	0	correlation	4.374	4.335	-0.039
24	0	correlation	4.428	4.387	-0.041
25	0	correlation	4.362	4.362	0

TID vs Post - Pre Exposure Delta

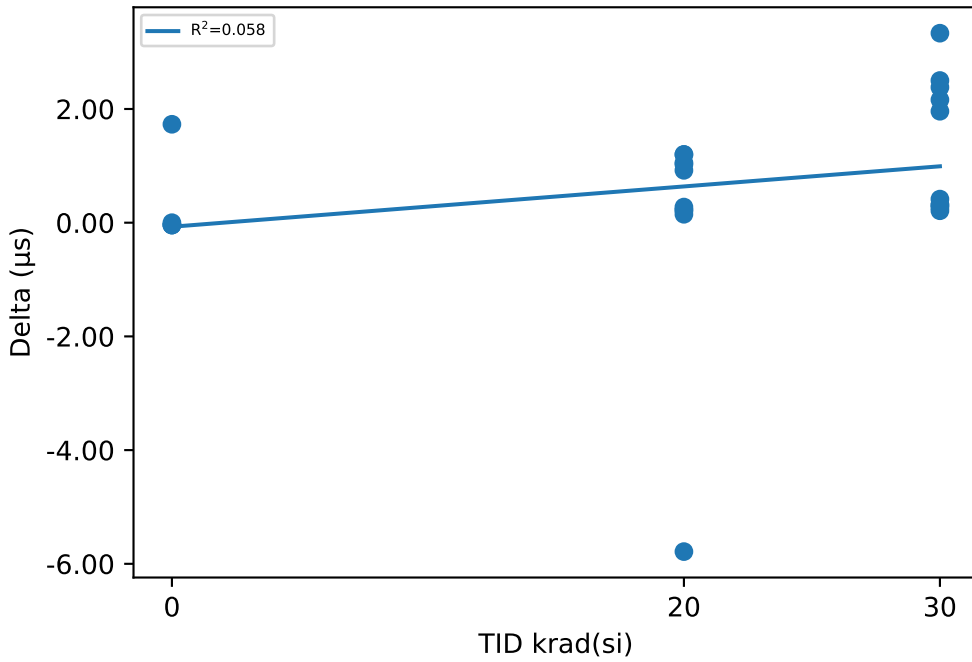

Test Statistics (µs)

krad(si)	Pre Exposure Min	Pre Exposure Avg	Pre Exposure Max	Pre Exposure Std	Post Exposure Min	Post Exposure Avg	Post Exposure Max	Post Exposure Std	Min Delta	Avg Delta	Max Delta	Std Delta
0	4.057	4.3536	4.547	0.18124	4.335	4.6756	5.788	0.62527	-0.041	0.322	1.731	0.78785
20	4.227	5.0313	10.48	1.9171	4.375	5.0792	5.721	0.48689	-5.785	0.0479	1.2	2.0957
30	4.081	4.3026	4.441	0.14531	4.388	5.6877	7.76	1.2691	0.21	1.3851	3.333	1.1947

Device Test: 16.3 UJRKCS(TCS_OFF2_UJRKCS)

TID vs Result Stats

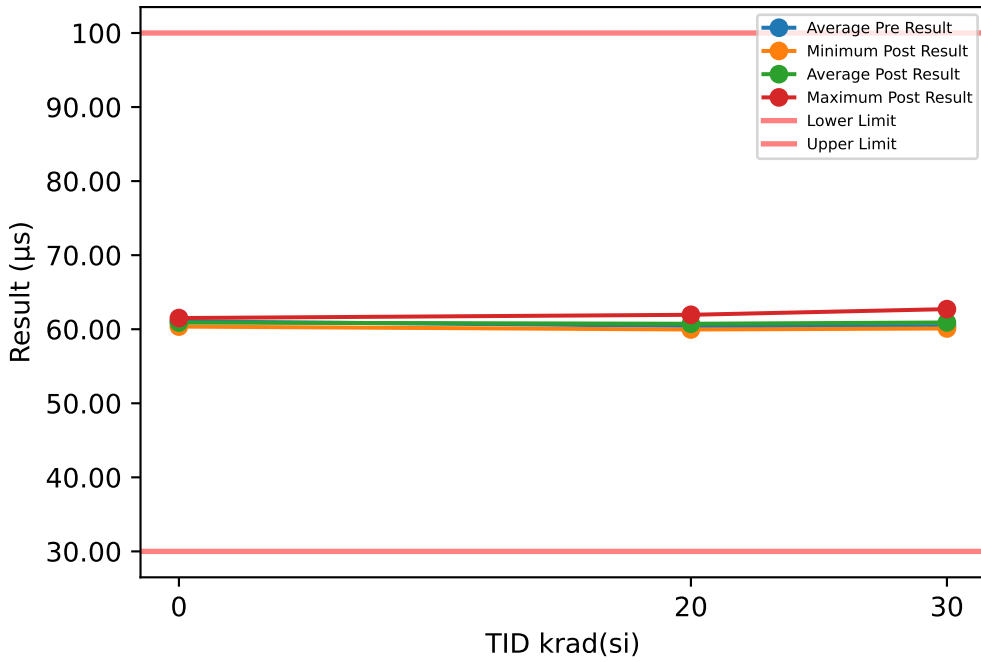

TID vs Post - Pre Exposure Delta

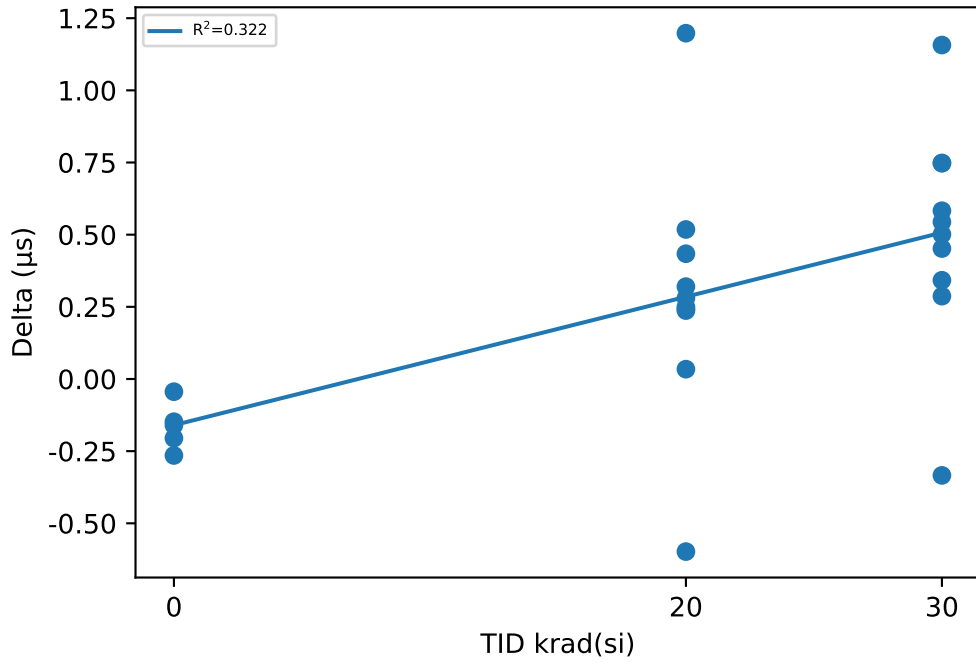

Test Results (Lower Limit = 30.0, Upper Limit = 100.0 (µs))

Serial #	krad(si)	Exposure Conditions	Pre Result	Post Result	Delta
1	20	HDR unbiased	60.289	60.531	0.242
2	20	HDR unbiased	60.134	60.568	0.434
3	20	HDR unbiased	61.628	61.948	0.32
4	20	HDR unbiased	60.902	61.42	0.518
5	20	HDR unbiased	60.783	61.02	0.237
6	20	HDR biased	60.599	60.001	-0.598
7	20	HDR biased	60.228	60.508	0.28
8	20	HDR biased	60.263	60.513	0.25
9	20	HDR biased	59.928	59.962	0.034
10	20	HDR biased	59.716	60.914	1.198
11	30	HDR unbiased	62.262	62.714	0.452
12	30	HDR unbiased	59.921	60.208	0.287
13	30	HDR unbiased	60.386	60.887	0.501
14	30	HDR unbiased	59.677	60.834	1.157
15	30	HDR unbiased	59.973	60.517	0.544
16	30	HDR biased	61.304	61.646	0.342
17	30	HDR biased	59.901	60.649	0.748
18	30	HDR biased	59.353	60.101	0.748
19	30	HDR biased	60.463	60.129	-0.334
20	30	HDR biased	60.859	61.442	0.583
21	0	correlation	61.713	61.508	-0.205
22	0	correlation	60.699	60.539	-0.16
23	0	correlation	60.621	60.356	-0.265
24	0	correlation	61.153	61.005	-0.148
25	0	correlation	61.132	61.088	-0.044

Test Statistics (µs)

krad(si)	Pre Exposure Min	Pre Exposure Avg	Pre Exposure Max	Pre Exposure Std	Post Exposure Min	Post Exposure Avg	Post Exposure Max	Post Exposure Std	Min Delta	Avg Delta	Max Delta	Std Delta
0	60.621	61.064	61.713	0.43681	60.356	60.899	61.508	0.45888	-0.265	-0.1644	-0.044	0.081476
20	59.716	60.447	61.628	0.55239	59.962	60.739	61.948	0.61104	-0.598	0.2915	1.198	0.44209
30	59.353	60.41	62.262	0.86781	60.101	60.913	62.714	0.82092	-0.334	0.5028	1.157	0.38465

Device Test: 16.4 UJJ1V5(TCS_ON2_UJJ1V5)

TID vs Result Stats

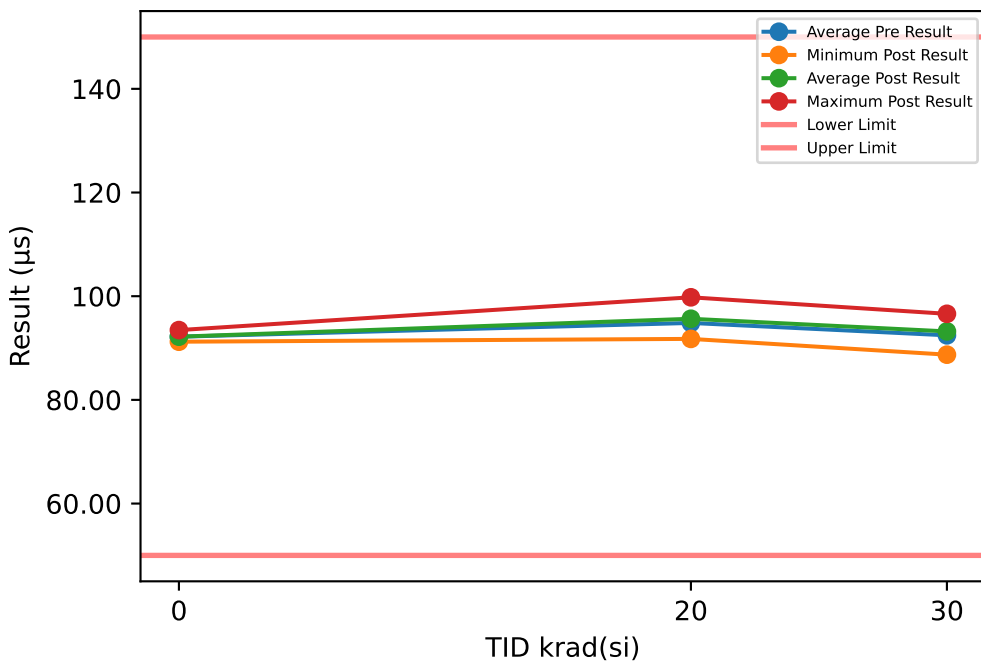

Test Results (Lower Limit = 50.0, Upper Limit = 150.0 (µs))

Serial #	krad(si)	Exposure Conditions	Pre Result	Post Result	Delta
1	20	HDR unbiased	94.336	95.22	0.884
2	20	HDR unbiased	97.047	97.336	0.289
3	20	HDR unbiased	94.658	96.033	1.375
4	20	HDR unbiased	95.513	95.662	0.149
5	20	HDR unbiased	92.592	91.764	-0.828
6	20	HDR biased	91.553	94.546	2.993
7	20	HDR biased	98.461	99.787	1.326
8	20	HDR biased	92.361	93.61	1.249
9	20	HDR biased	98.093	98.797	0.704
10	20	HDR biased	93.793	93.694	-0.099
11	30	HDR unbiased	88.462	88.721	0.259
12	30	HDR unbiased	94.954	96.602	1.648
13	30	HDR unbiased	92.124	93.432	1.308
14	30	HDR unbiased	95.119	94.845	-0.274
15	30	HDR unbiased	94.948	95.643	0.695
16	30	HDR biased	91.803	91.962	0.159
17	30	HDR biased	91.421	92.748	1.327
18	30	HDR biased	91.391	92.416	1.025
19	30	HDR biased	92.736	94.586	1.85
20	30	HDR biased	91.58	91.122	-0.458
21	0	correlation	93.802	93.461	-0.341
22	0	correlation	92.353	92.257	-0.096
23	0	correlation	91.372	91.643	0.271
24	0	correlation	92.281	92.372	0.091
25	0	correlation	91.101	91.222	0.121

TID vs Post - Pre Exposure Delta

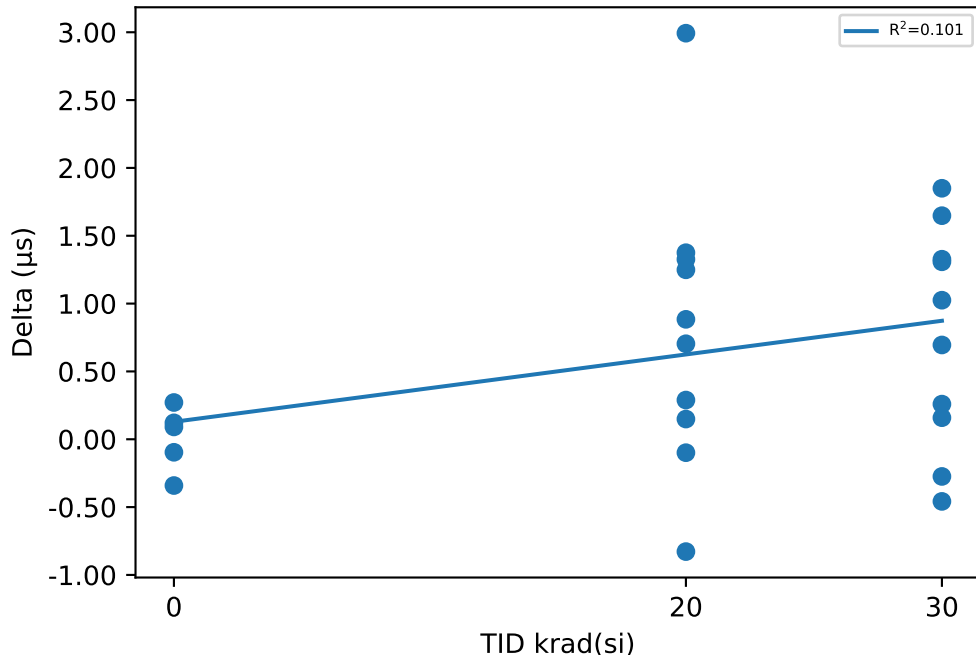

Test Statistics (µs)

krad(si)	Pre Exposure Min	Pre Exposure Avg	Pre Exposure Max	Pre Exposure Std	Post Exposure Min	Post Exposure Avg	Post Exposure Max	Post Exposure Std	Min Delta	Avg Delta	Max Delta	Std Delta
0	91.101	92.182	93.802	1.0593	91.222	92.191	93.461	0.84989	-0.341	0.0092	0.271	0.23529
20	91.553	94.841	98.461	2.413	91.764	95.645	99.787	2.4608	-0.828	0.8042	2.993	1.0423
30	88.462	92.454	95.119	2.0838	88.721	93.208	96.602	2.3322	-0.458	0.7539	1.85	0.80536

Device Test: 16.5 UJSI7E(TMUX_UJSI7E)

TID vs Result Stats

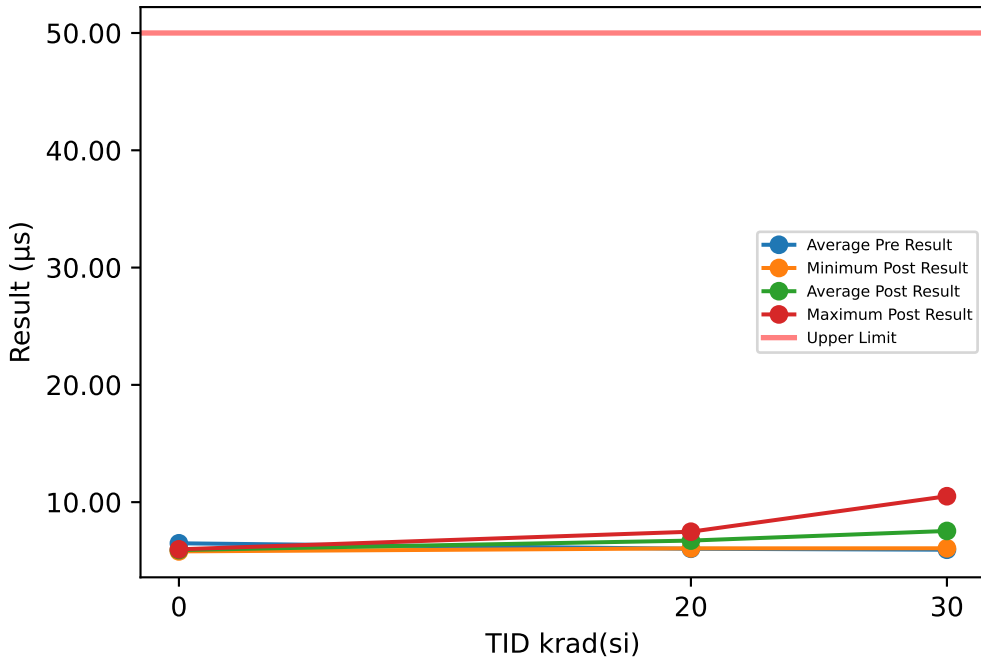

Test Results (Upper Limit = 50.0 (µs))

Serial #	krad(si)	Exposure Conditions	Pre Result	Post Result	Delta
1	20	HDR unbiased	5.983	6.183	0.2
2	20	HDR unbiased	6.077	6.226	0.149
3	20	HDR unbiased	6.135	6.137	0.002
4	20	HDR unbiased	6.028	6.061	0.033
5	20	HDR unbiased	5.888	6.115	0.227
6	20	HDR biased	6.063	7.157	1.094
7	20	HDR biased	5.914	7.403	1.489
8	20	HDR biased	6.027	7.399	1.372
9	20	HDR biased	6.038	7.48	1.442
10	20	HDR biased	6.109	7.071	0.962
11	30	HDR unbiased	6.027	6.236	0.209
12	30	HDR unbiased	6.031	6.152	0.121
13	30	HDR unbiased	5.875	6.192	0.317
14	30	HDR unbiased	6.105	6.137	0.032
15	30	HDR unbiased	5.922	6.068	0.146
16	30	HDR biased	6.019	8.595	2.576
17	30	HDR biased	5.892	8.524	2.632
18	30	HDR biased	5.768	8.512	2.744
19	30	HDR biased	5.878	10.506	4.628
20	30	HDR biased	5.919	8.523	2.604
21	0	correlation	6.029	5.962	-0.067
22	0	correlation	8.204	5.802	-2.402
23	0	correlation	6.095	5.971	-0.124
24	0	correlation	5.988	5.874	-0.114
25	0	correlation	6.148	5.977	-0.171

TID vs Post - Pre Exposure Delta

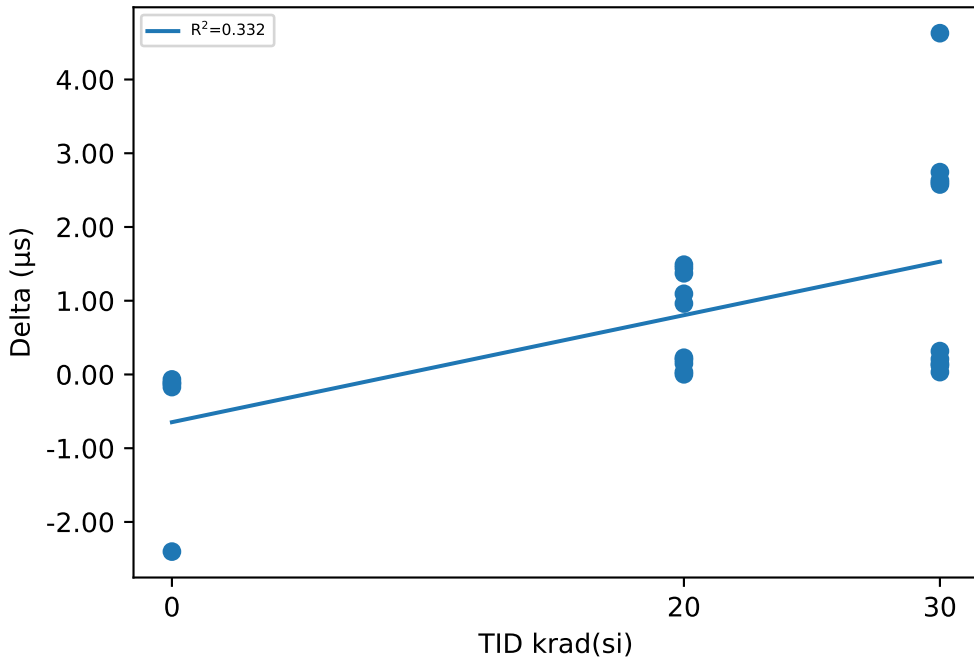

Test Statistics (µs)

krad(si)	Pre Exposure Min	Pre Exposure Avg	Pre Exposure Max	Pre Exposure Std	Post Exposure Min	Post Exposure Avg	Post Exposure Max	Post Exposure Std	Min Delta	Avg Delta	Max Delta	Std Delta
0	5.988	6.4928	8.204	0.95855	5.802	5.9172	5.977	0.076836	-2.402	-0.5756	-0.067	1.0217
20	5.888	6.0262	6.135	0.07911	6.061	6.7232	7.48	0.62288	0.002	0.697	1.489	0.62874
30	5.768	5.9436	6.105	0.099949	6.068	7.5445	10.506	1.5765	0.032	1.6009	4.628	1.6277

B Appendix B: LDR TID Report

This appendix contains the LDR TID report data.

Device Test: 10.1 UJR405(dCSR_5mA_CH1_UJR405)

TID vs Result Stats

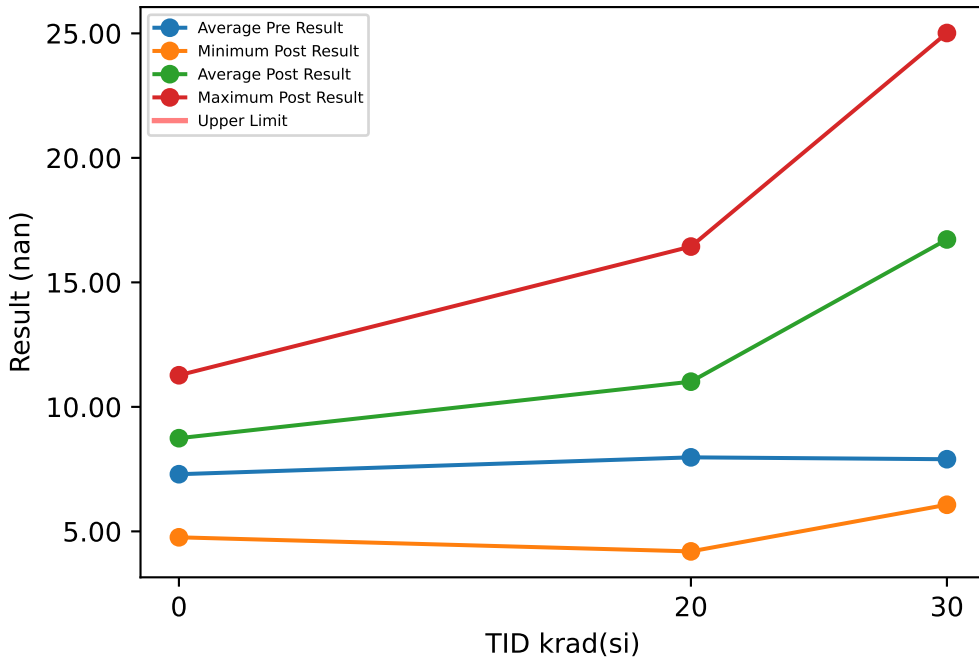

Test Results (No Limits Specified (nan))

Serial #	krad(si)	Exposure Conditions	Pre Result	Post Result	Delta
50	20	LDR biased	7.463	10.306	2.843
51	20	LDR biased	8.237	15.766	7.529
52	20	LDR biased	6.325	14.83	8.505
53	20	LDR biased	9.13	16.438	7.308
54	20	LDR biased	9.865	14.402	4.537
55	30	LDR biased	7.272	25.015	17.743
56	30	LDR biased	6.224	21.71	15.486
57	30	LDR biased	12.92	19.745	6.825
58	30	LDR biased	7.971	24.52	16.549
59	30	LDR biased	7.129	20.086	12.957
60	20	LDR unbiased	12.621	10.394	-2.227
61	20	LDR unbiased	5.233	7.837	2.604
62	20	LDR unbiased	4.397	4.196	-0.201
63	20	LDR unbiased	8.268	8.19	-0.078
64	20	LDR unbiased	8.191	7.765	-0.426
65	30	LDR unbiased	6.863	6.069	-0.794
66	30	LDR unbiased	6.844	14.785	7.941
67	30	LDR unbiased	6.607	11.194	4.587
68	30	LDR unbiased	10.161	11.278	1.117
69	30	LDR unbiased	6.988	12.831	5.843
70	0	correlation	7.866	8.661	0.795
71	0	correlation	6.015	9.476	3.461
72	0	correlation	6.088	4.762	-1.326
73	0	correlation	6.645	11.27	4.625
74	0	correlation	9.864	9.542	-0.322

TID vs Post - Pre Exposure Delta

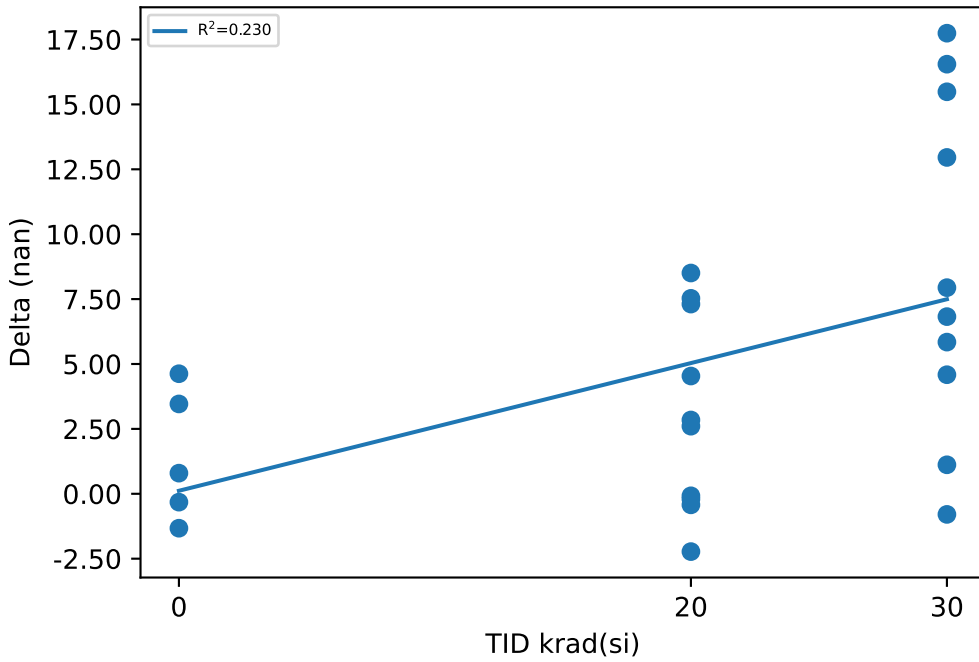

Test Statistics (nan)

krad(si)	Pre Exposure Min	Pre Exposure Avg	Pre Exposure Max	Pre Exposure Std	Post Exposure Min	Post Exposure Avg	Post Exposure Max	Post Exposure Std	Min Delta	Avg Delta	Max Delta	Std Delta
0	6.015	7.2956	9.864	1.6158	4.762	8.7422	11.27	2.4195	-1.326	1.4466	4.625	2.5199
20	4.397	7.973	12.621	2.357	4.196	11.012	16.438	4.1371	-2.227	3.0394	8.505	3.8106
30	6.224	7.8979	12.92	2.0766	6.069	16.723	25.015	6.39	-0.794	8.8254	17.743	6.5337

Device Test: 10.10 UJ74P3(dCSR_100mA_CH2_UJ74P3)

TID vs Result Stats

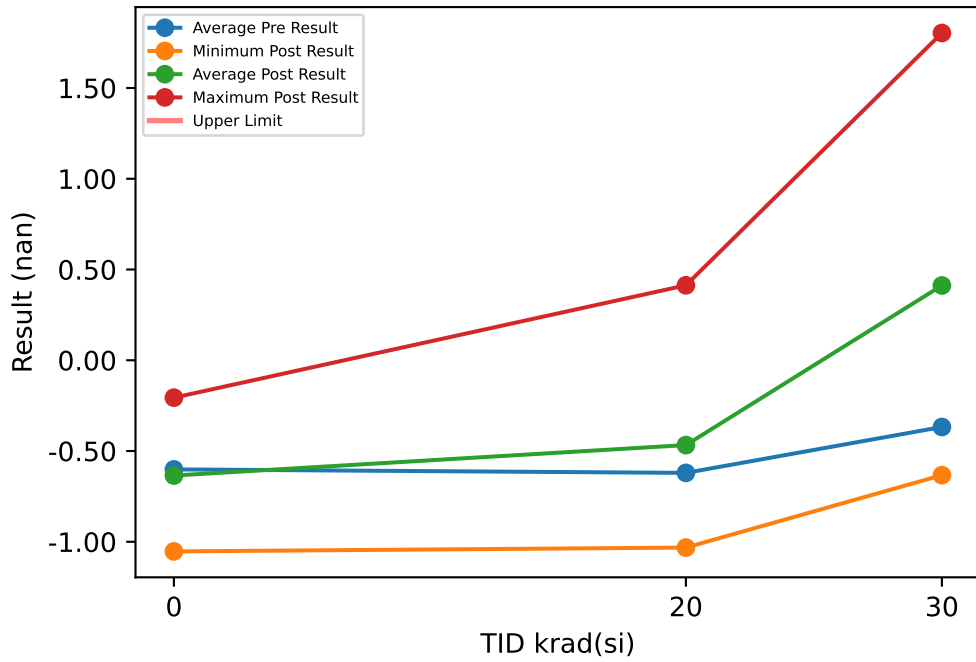

Test Results (No Limits Specified (nan))

Serial #	krad(si)	Exposure Conditions	Pre Result	Post Result	Delta
50	20	LDR biased	-0.612	-0.261	0.351
51	20	LDR biased	-0.938	-1.032	-0.094
52	20	LDR biased	-0.28	0.24	0.52
53	20	LDR biased	-0.672	-0.187	0.485
54	20	LDR biased	-0.516	-0.494	0.022
55	30	LDR biased	-0.827	1.204	2.031
56	30	LDR biased	-0.893	1.083	1.976
57	30	LDR biased	-0.665	0.966	1.631
58	30	LDR biased	0.07	1.803	1.733
59	30	LDR biased	-0.702	0.497	1.199
60	20	LDR unbiased	-0.803	-0.656	0.147
61	20	LDR unbiased	-1.042	-0.975	0.067
62	20	LDR unbiased	-0.774	-0.997	-0.223
63	20	LDR unbiased	-0.619	-0.724	-0.105
64	20	LDR unbiased	0.052	0.413	0.361
65	30	LDR unbiased	-0.036	-0.395	-0.359
66	30	LDR unbiased	0.073	0.235	0.162
67	30	LDR unbiased	-0.604	-0.633	-0.029
68	30	LDR unbiased	-0.062	-0.362	-0.3
69	30	LDR unbiased	-0.031	-0.278	-0.247
70	0	correlation	-0.132	-0.206	-0.074
71	0	correlation	-0.628	-0.775	-0.147
72	0	correlation	-1.099	-1.053	0.046
73	0	correlation	-0.756	-0.847	-0.091
74	0	correlation	-0.391	-0.294	0.097

TID vs Post - Pre Exposure Delta

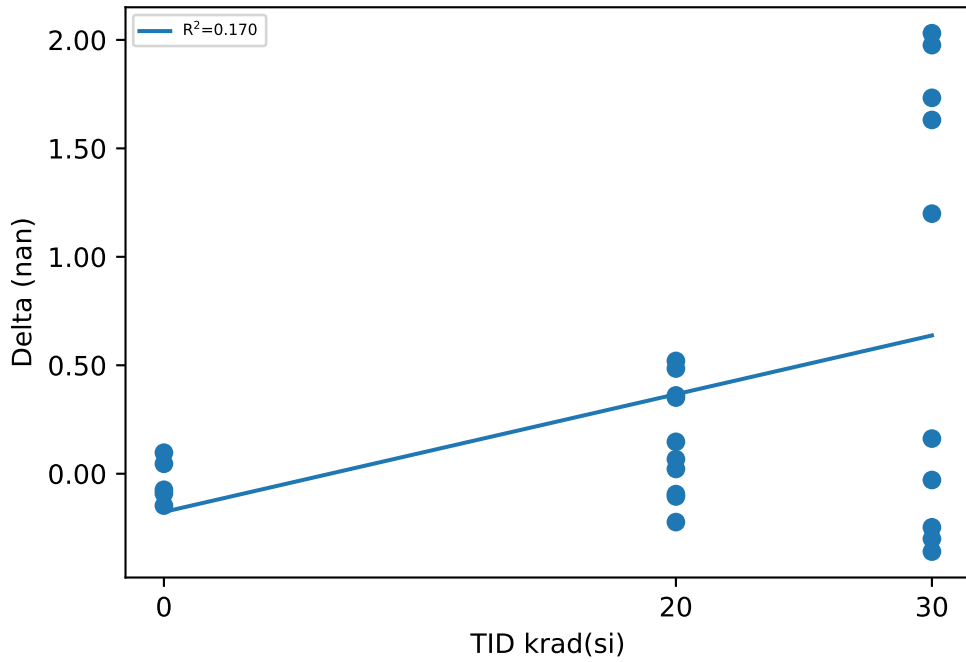

Test Statistics (nan)

krad(si)	Pre Exposure Min	Pre Exposure Avg	Pre Exposure Max	Pre Exposure Std	Post Exposure Min	Post Exposure Avg	Post Exposure Max	Post Exposure Std	Min Delta	Avg Delta	Max Delta	Std Delta
0	-1.099	-0.6012	-0.132	0.36634	-1.053	-0.635	-0.206	0.36728	-0.147	-0.0338	0.097	0.10146
20	-1.042	-0.6204	0.052	0.31923	-1.032	-0.4673	0.413	0.51162	-0.223	0.1531	0.52	0.26266
30	-0.893	-0.3677	0.073	0.40077	-0.633	0.412	1.803	0.82841	-0.359	0.7797	2.031	1.0197

Device Test: 10.12 UJA0RR(dCSR_500mA_CH2_UJA0RR)

TID vs Result Stats

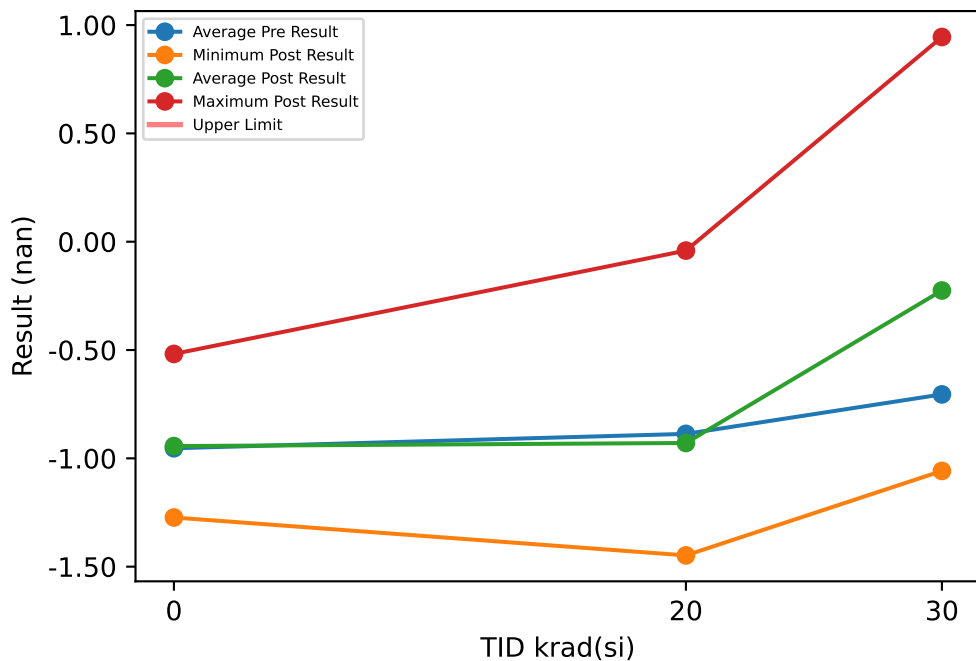

Test Results (No Limits Specified (nan))

Serial #	krad(si)	Exposure Conditions	Pre Result	Post Result	Delta
50	20	LDR biased	-0.864	-0.881	-0.017
51	20	LDR biased	-1.054	-1.448	-0.394
52	20	LDR biased	-0.468	-0.469	-0.001
53	20	LDR biased	-1.083	-0.904	0.179
54	20	LDR biased	-0.812	-0.784	0.028
55	30	LDR biased	-1.073	0.442	1.515
56	30	LDR biased	-1.14	0.289	1.429
57	30	LDR biased	-1.031	-0.16	0.871
58	30	LDR biased	-0.369	0.945	1.314
59	30	LDR biased	-0.884	0.016	0.9
60	20	LDR unbiased	-1.093	-1.109	-0.016
61	20	LDR unbiased	-1.24	-1.253	-0.013
62	20	LDR unbiased	-0.918	-1.327	-0.409
63	20	LDR unbiased	-1.019	-1.075	-0.056
64	20	LDR unbiased	-0.32	-0.041	0.279
65	30	LDR unbiased	-0.436	-0.909	-0.473
66	30	LDR unbiased	-0.282	-0.379	-0.097
67	30	LDR unbiased	-1.081	-1.058	0.023
68	30	LDR unbiased	-0.45	-0.803	-0.353
69	30	LDR unbiased	-0.302	-0.635	-0.333
70	0	correlation	-0.571	-0.518	0.053
71	0	correlation	-1.018	-1.038	-0.02
72	0	correlation	-1.358	-1.273	0.085
73	0	correlation	-1.05	-1.021	0.029
74	0	correlation	-0.77	-0.867	-0.097

TID vs Post - Pre Exposure Delta

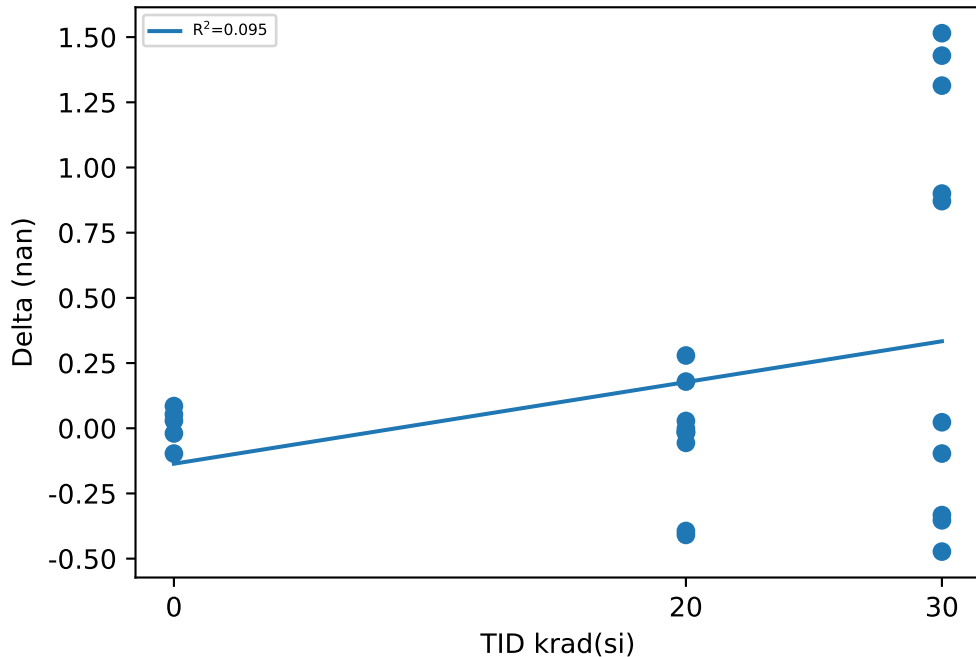

Test Statistics (nan)

krad(si)	Pre Exposure Min	Pre Exposure Avg	Pre Exposure Max	Pre Exposure Std	Post Exposure Min	Post Exposure Avg	Post Exposure Max	Post Exposure Std	Min Delta	Avg Delta	Max Delta	Std Delta
0	-1.358	-0.9534	-0.571	0.29878	-1.273	-0.9434	-0.518	0.27857	-0.097	0.01	0.085	0.071035
20	-1.24	-0.8871	-0.32	0.28962	-1.448	-0.9291	-0.041	0.42303	-0.409	-0.042	0.279	0.21587
30	-1.14	-0.7048	-0.282	0.36453	-1.058	-0.2252	0.945	0.65217	-0.473	0.4796	1.515	0.80288

Device Test: 10.13 UJR405(dCSR_5mA_CH3_UJR405)

TID vs Result Stats

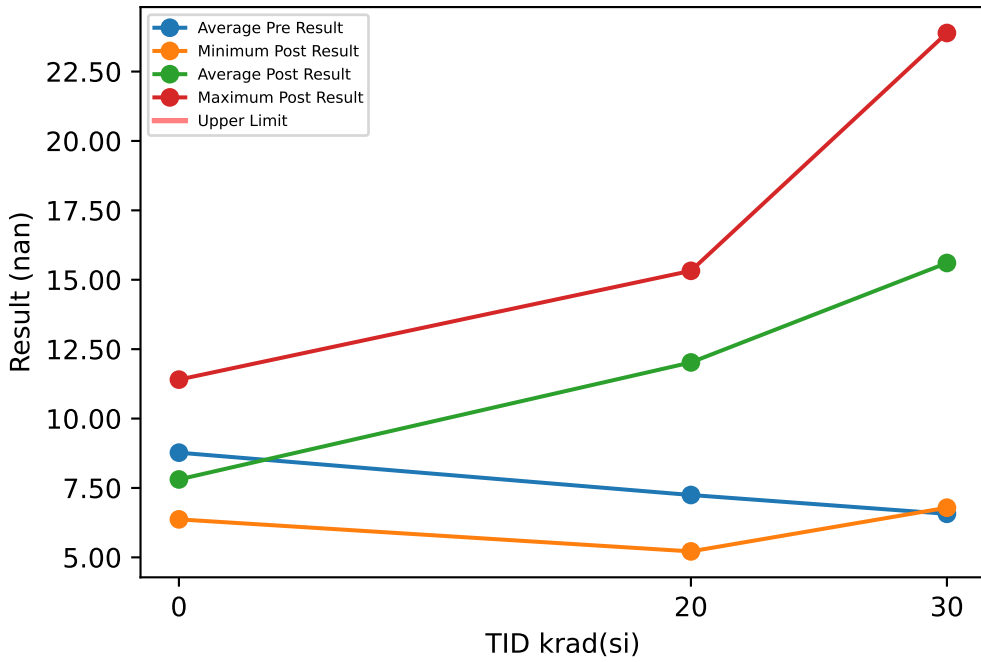

Test Results (No Limits Specified (nan))

Serial #	krad(si)	Exposure Conditions	Pre Result	Post Result	Delta
50	20	LDR biased	7.802	13.421	5.619
51	20	LDR biased	4.739	15.158	10.419
52	20	LDR biased	5.651	14.332	8.681
53	20	LDR biased	7.114	15.322	8.208
54	20	LDR biased	9.232	14.693	5.461
55	30	LDR biased	6.115	21.249	15.134
56	30	LDR biased	6.717	21.315	14.598
57	30	LDR biased	7.924	23.889	15.965
58	30	LDR biased	8.016	22.45	14.434
59	30	LDR biased	6.32	18.364	12.044
60	20	LDR unbiased	8.93	11.041	2.111
61	20	LDR unbiased	4.77	10.902	6.132
62	20	LDR unbiased	6.656	5.215	-1.441
63	20	LDR unbiased	10.487	11.527	1.04
64	20	LDR unbiased	7.082	8.607	1.525
65	30	LDR unbiased	5.327	8.227	2.9
66	30	LDR unbiased	8.53	11.172	2.642
67	30	LDR unbiased	4.502	10.216	5.714
68	30	LDR unbiased	5.954	12.372	6.418
69	30	LDR unbiased	6.285	6.789	0.504
70	0	correlation	8.718	6.859	-1.859
71	0	correlation	7.107	6.369	-0.738
72	0	correlation	9.441	7.762	-1.679
73	0	correlation	8.491	6.639	-1.852
74	0	correlation	10.102	11.403	1.301

TID vs Post - Pre Exposure Delta

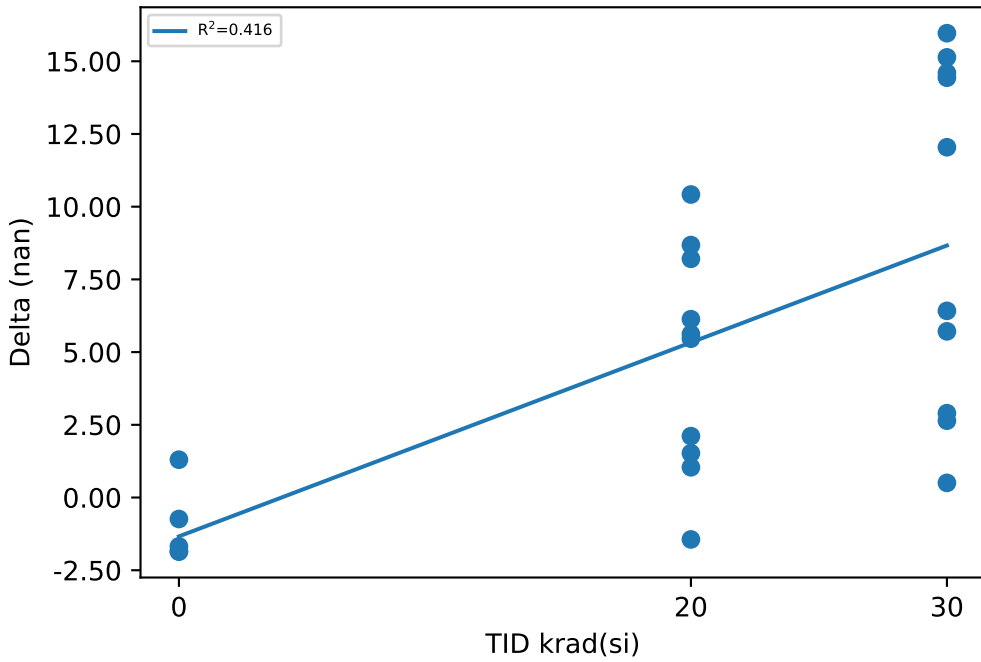

Test Statistics (nan)

krad(si)	Pre Exposure Min	Pre Exposure Avg	Pre Exposure Max	Pre Exposure Std	Post Exposure Min	Post Exposure Avg	Post Exposure Max	Post Exposure Std	Min Delta	Avg Delta	Max Delta	Std Delta
0	7.107	8.7718	10.102	1.1259	6.369	7.8064	11.403	2.0775	-1.859	-0.9654	1.301	1.3493
20	4.739	7.2463	10.487	1.9133	5.215	12.022	15.322	3.2594	-1.441	4.7755	10.419	3.8322
30	4.502	6.569	8.53	1.2622	6.789	15.604	23.889	6.488	0.504	9.0353	15.965	5.9957

Device Test: 10.14 UJFZSP(dCSR_25mA_CH3_UJFZSP)

TID vs Result Stats

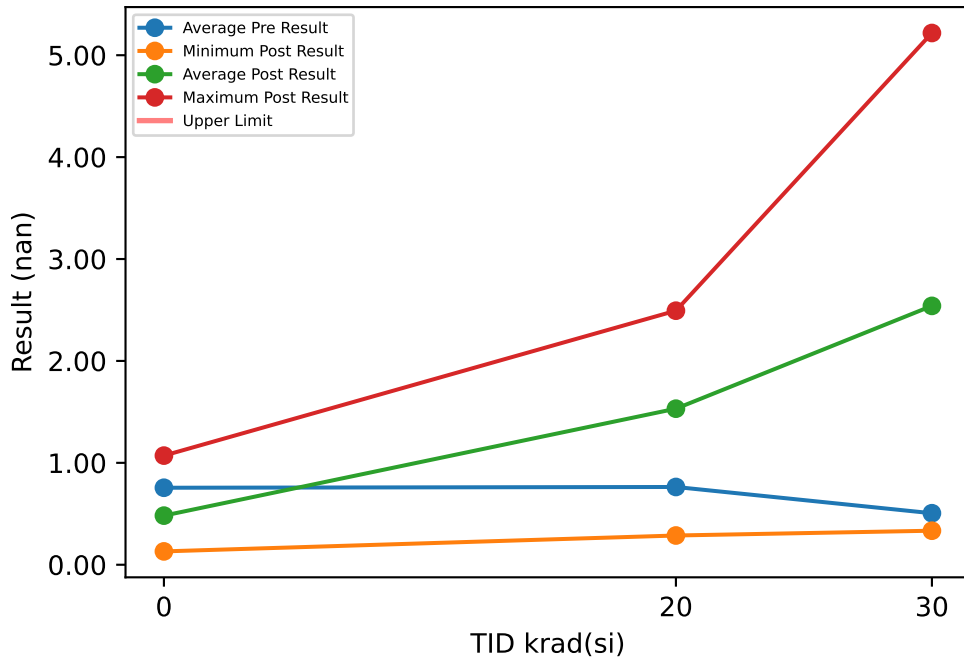

Test Results (No Limits Specified (nan))

Serial #	krad(si)	Exposure Conditions	Pre Result	Post Result	Delta
50	20	LDR biased	1.118	2.493	1.375
51	20	LDR biased	0.133	0.686	0.553
52	20	LDR biased	0.304	1.599	1.295
53	20	LDR biased	0.92	2.132	1.212
54	20	LDR biased	0.663	1.386	0.723
55	30	LDR biased	0.596	5.218	4.622
56	30	LDR biased	0.326	4.841	4.515
57	30	LDR biased	0.472	3.894	3.422
58	30	LDR biased	0.359	3.553	3.194
59	30	LDR biased	0.064	3.662	3.598
60	20	LDR unbiased	1.433	1.926	0.493
61	20	LDR unbiased	0.72	1.773	1.053
62	20	LDR unbiased	0.559	0.287	-0.272
63	20	LDR unbiased	0.177	0.757	0.58
64	20	LDR unbiased	1.604	2.275	0.671
65	30	LDR unbiased	0.459	0.334	-0.125
66	30	LDR unbiased	0.709	1.312	0.603
67	30	LDR unbiased	1.36	0.88	-0.48
68	30	LDR unbiased	0.056	0.954	0.898
69	30	LDR unbiased	0.655	0.754	0.099
70	0	correlation	0.943	0.425	-0.518
71	0	correlation	0.994	0.358	-0.636
72	0	correlation	0.413	0.131	-0.282
73	0	correlation	0.301	0.425	0.124
74	0	correlation	1.127	1.071	-0.056

TID vs Post - Pre Exposure Delta

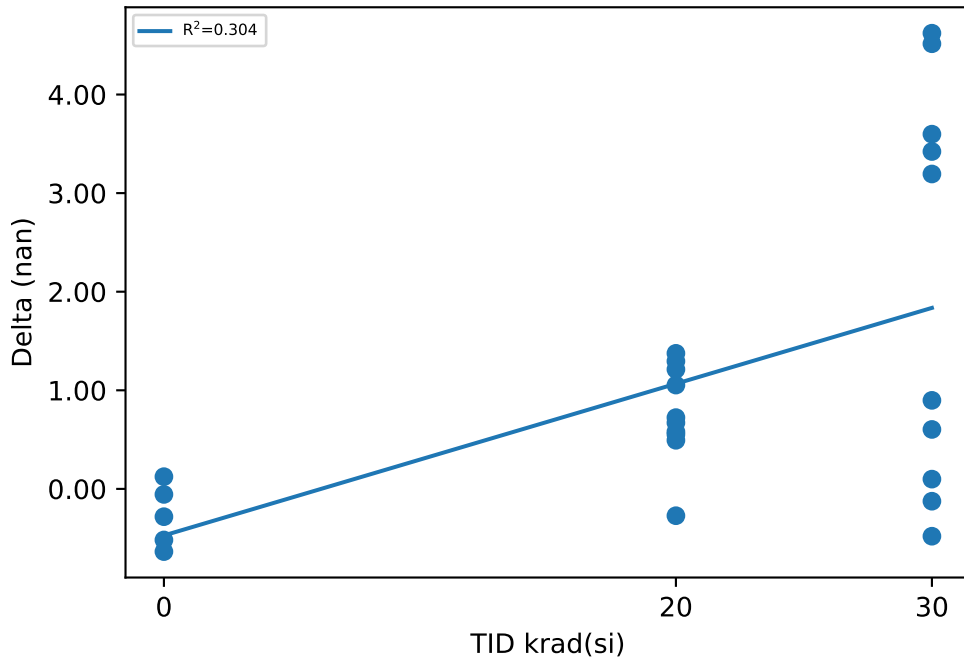

Test Statistics (nan)

krad(si)	Pre Exposure Min	Pre Exposure Avg	Pre Exposure Max	Pre Exposure Std	Post Exposure Min	Post Exposure Avg	Post Exposure Max	Post Exposure Std	Min Delta	Avg Delta	Max Delta	Std Delta
0	0.301	0.7556	1.127	0.37213	0.131	0.482	1.071	0.35071	-0.636	-0.2736	0.124	0.31487
20	0.133	0.7631	1.604	0.50677	0.287	1.5314	2.493	0.74095	-0.272	0.7683	1.375	0.49157
30	0.056	0.5056	1.36	0.37358	0.334	2.5402	5.218	1.8684	-0.48	2.0346	4.622	2.0176

Device Test: 10.15 UJF0T(dCSR_50mA_CH3_UJF0T)

TID vs Result Stats

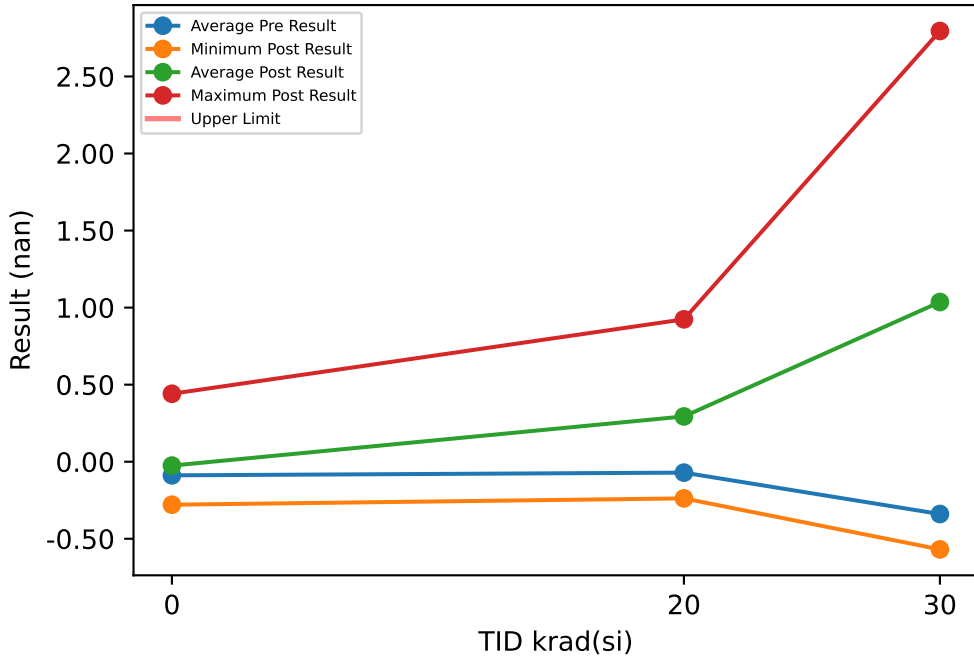

Test Results (No Limits Specified (nan))

Serial #	krad(si)	Exposure Conditions	Pre Result	Post Result	Delta
50	20	LDR biased	-0.042	0.777	0.819
51	20	LDR biased	-0.518	-0.11	0.408
52	20	LDR biased	-0.536	-0.114	0.422
53	20	LDR biased	-0.202	0.263	0.465
54	20	LDR biased	-0.076	0.147	0.223
55	30	LDR biased	-0.5	1.953	2.453
56	30	LDR biased	-0.432	2.795	3.227
57	30	LDR biased	0.017	2.085	2.068
58	30	LDR biased	-0.501	1.798	2.299
59	30	LDR biased	-0.673	1.908	2.581
60	20	LDR unbiased	0.446	0.62	0.174
61	20	LDR unbiased	0.443	0.678	0.235
62	20	LDR unbiased	-0.397	-0.238	0.159
63	20	LDR unbiased	-0.002	-0.009	-0.007
64	20	LDR unbiased	0.176	0.924	0.748
65	30	LDR unbiased	-0.207	-0.569	-0.362
66	30	LDR unbiased	-0.428	0.331	0.759
67	30	LDR unbiased	0.14	0.639	0.499
68	30	LDR unbiased	-0.544	-0.178	0.366
69	30	LDR unbiased	-0.267	-0.4	-0.133
70	0	correlation	-0.008	-0.092	-0.084
71	0	correlation	-0.089	-0.011	0.078
72	0	correlation	-0.253	-0.185	0.068
73	0	correlation	-0.133	-0.279	-0.146
74	0	correlation	0.041	0.441	0.4

TID vs Post - Pre Exposure Delta

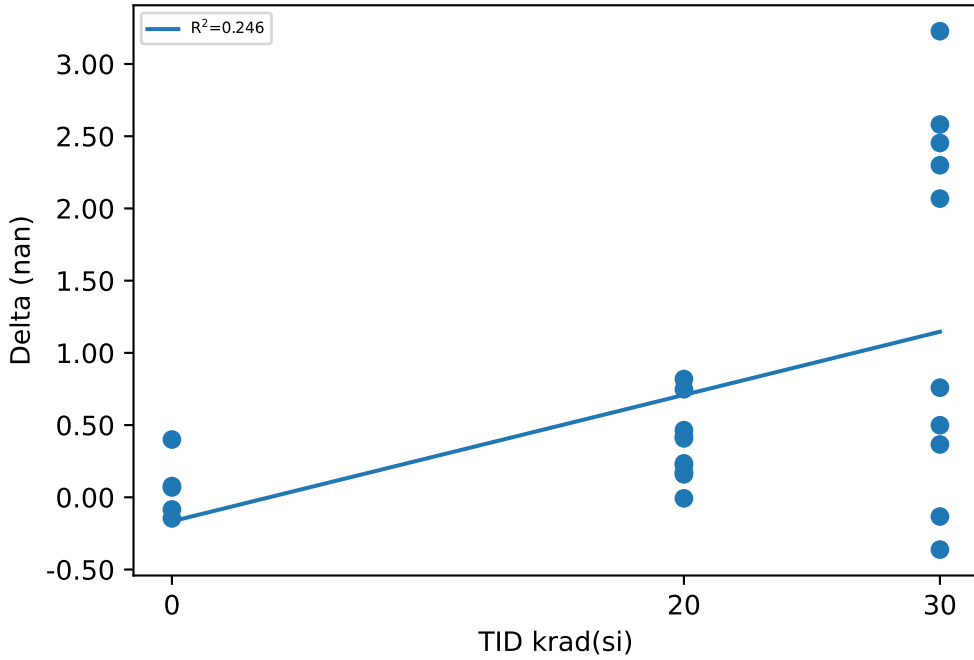

Test Statistics (nan)

krad(si)	Pre Exposure Min	Pre Exposure Avg	Pre Exposure Max	Pre Exposure Std	Post Exposure Min	Post Exposure Avg	Post Exposure Max	Post Exposure Std	Min Delta	Avg Delta	Max Delta	Std Delta
0	-0.253	-0.0884	0.041	0.11434	-0.279	-0.0252	0.441	0.27927	-0.146	0.0632	0.4	0.21161
20	-0.536	-0.0708	0.446	0.35553	-0.238	0.2938	0.924	0.42308	-0.007	0.3646	0.819	0.26295
30	-0.673	-0.3395	0.14	0.25844	-0.569	1.0362	2.795	1.2084	-0.362	1.3757	3.227	1.2839

Device Test: 10.16 UJ74P3(dCSR_100mA_CH3_UJ74P3)

TID vs Result Stats

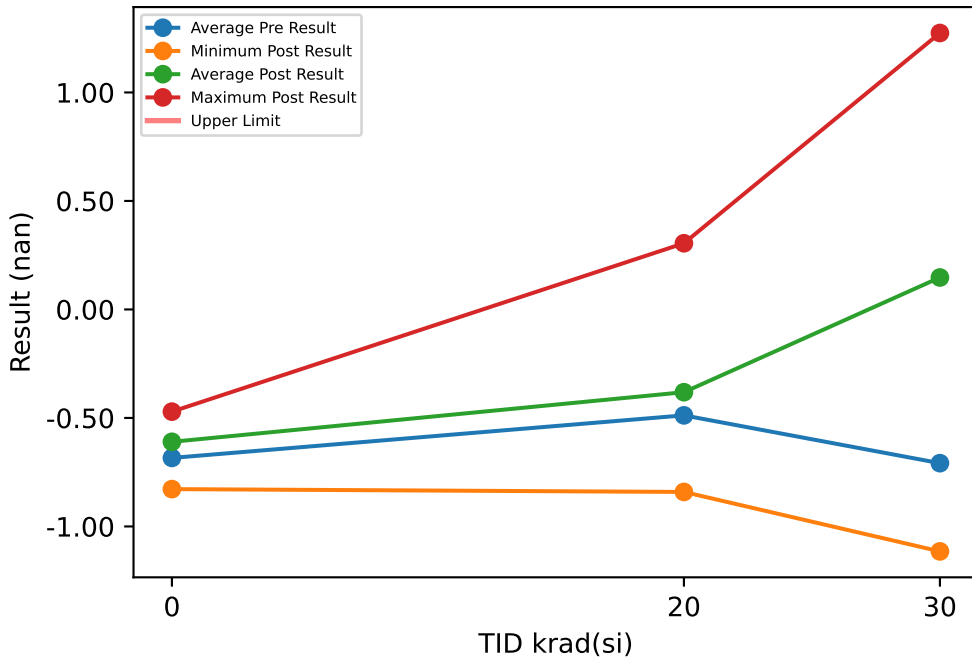

Test Results (No Limits Specified (nan))

Serial #	krad(si)	Exposure Conditions	Pre Result	Post Result	Delta
50	20	LDR biased	-0.517	-0.436	0.081
51	20	LDR biased	-0.779	-0.797	-0.018
52	20	LDR biased	-1.004	-0.514	0.49
53	20	LDR biased	-0.776	-0.328	0.448
54	20	LDR biased	-0.569	-0.521	0.048
55	30	LDR biased	-0.727	0.963	1.69
56	30	LDR biased	-0.903	1.274	2.177
57	30	LDR biased	-0.666	0.804	1.47
58	30	LDR biased	-0.729	0.836	1.565
59	30	LDR biased	-0.776	0.879	1.655
60	20	LDR unbiased	-0.09	-0.004	0.086
61	20	LDR unbiased	0.087	-0.13	-0.217
62	20	LDR unbiased	-0.57	-0.841	-0.271
63	20	LDR unbiased	-0.585	-0.548	0.037
64	20	LDR unbiased	-0.078	0.305	0.383
65	30	LDR unbiased	-0.68	-1.115	-0.435
66	30	LDR unbiased	-0.795	-0.436	0.359
67	30	LDR unbiased	-0.202	-0.081	0.121
68	30	LDR unbiased	-0.887	-0.812	0.075
69	30	LDR unbiased	-0.719	-0.839	-0.12
70	0	correlation	-0.478	-0.471	0.007
71	0	correlation	-0.658	-0.534	0.124
72	0	correlation	-0.965	-0.828	0.137
73	0	correlation	-0.792	-0.678	0.114
74	0	correlation	-0.528	-0.539	-0.011

TID vs Post - Pre Exposure Delta

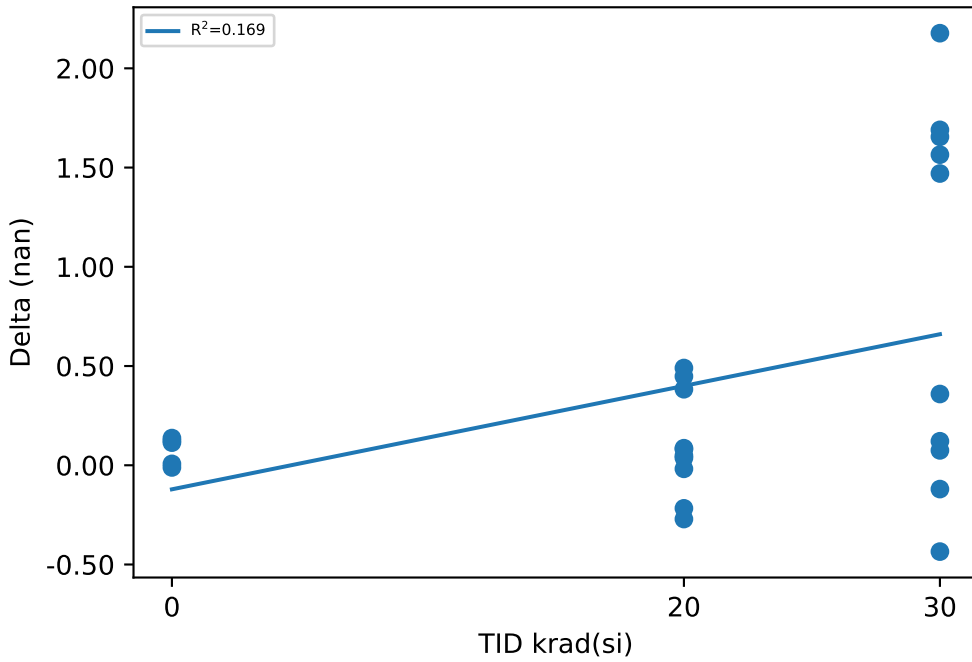

Test Statistics (nan)

krad(si)	Pre Exposure Min	Pre Exposure Avg	Pre Exposure Max	Pre Exposure Std	Post Exposure Min	Post Exposure Avg	Post Exposure Max	Post Exposure Std	Min Delta	Avg Delta	Max Delta	Std Delta
0	-0.965	-0.6842	-0.478	0.19879	-0.828	-0.61	-0.471	0.14343	-0.011	0.0742	0.137	0.070326
20	-1.004	-0.4881	0.087	0.35191	-0.841	-0.3814	0.305	0.35456	-0.271	0.1067	0.49	0.2608
30	-0.903	-0.7084	-0.202	0.19487	-1.115	0.1473	1.274	0.89781	-0.435	0.8557	2.177	0.94134

Device Test: 10.18 UJA0RR(dCSR_500mA_CH3_UJA0RR)

TID vs Result Stats

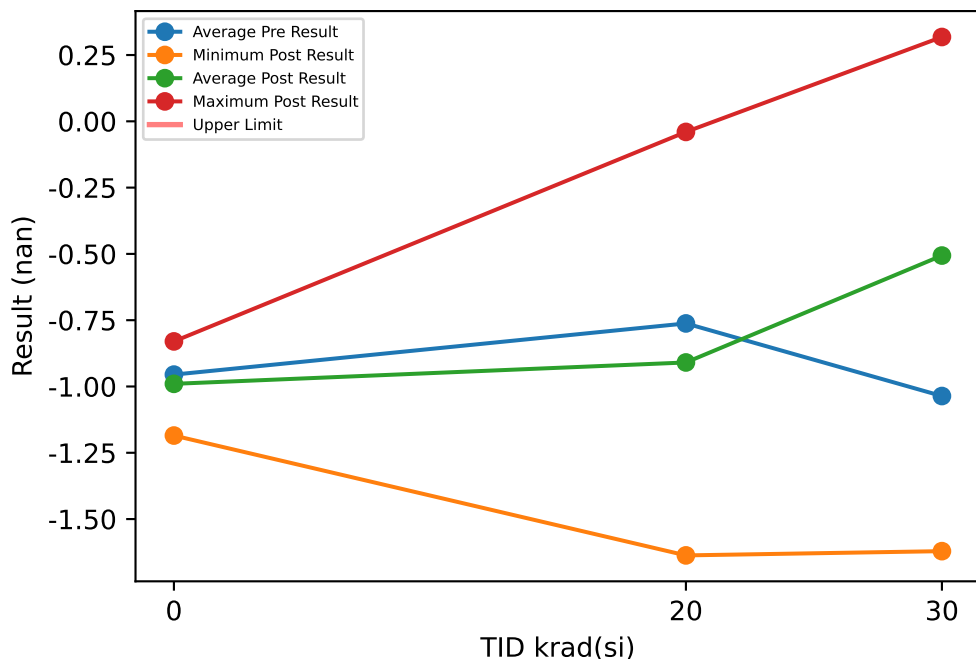

Test Results (No Limits Specified (nan))

Serial #	krad(si)	Exposure Conditions	Pre Result	Post Result	Delta
50	20	LDR biased	-0.848	-1.074	-0.226
51	20	LDR biased	-1.155	-1.637	-0.482
52	20	LDR biased	-1.141	-1.044	0.097
53	20	LDR biased	-0.933	-1.111	-0.178
54	20	LDR biased	-0.904	-1.172	-0.268
55	30	LDR biased	-1.078	0.318	1.396
56	30	LDR biased	-1.095	0.177	1.272
57	30	LDR biased	-1.026	0.202	1.228
58	30	LDR biased	-1.178	-0.032	1.146
59	30	LDR biased	-1.191	0.018	1.209
60	20	LDR unbiased	-0.434	-0.493	-0.059
61	20	LDR unbiased	-0.267	-0.406	-0.139
62	20	LDR unbiased	-0.84	-1.079	-0.239
63	20	LDR unbiased	-0.831	-1.038	-0.207
64	20	LDR unbiased	-0.269	-0.04	0.229
65	30	LDR unbiased	-0.912	-1.621	-0.709
66	30	LDR unbiased	-1.199	-1.032	0.167
67	30	LDR unbiased	-0.501	-0.429	0.072
68	30	LDR unbiased	-1.119	-1.395	-0.276
69	30	LDR unbiased	-1.061	-1.268	-0.207
70	0	correlation	-0.879	-0.853	0.026
71	0	correlation	-0.886	-0.83	0.056
72	0	correlation	-1.069	-1.185	-0.116
73	0	correlation	-0.963	-1.158	-0.195
74	0	correlation	-0.979	-0.924	0.055

TID vs Post - Pre Exposure Delta

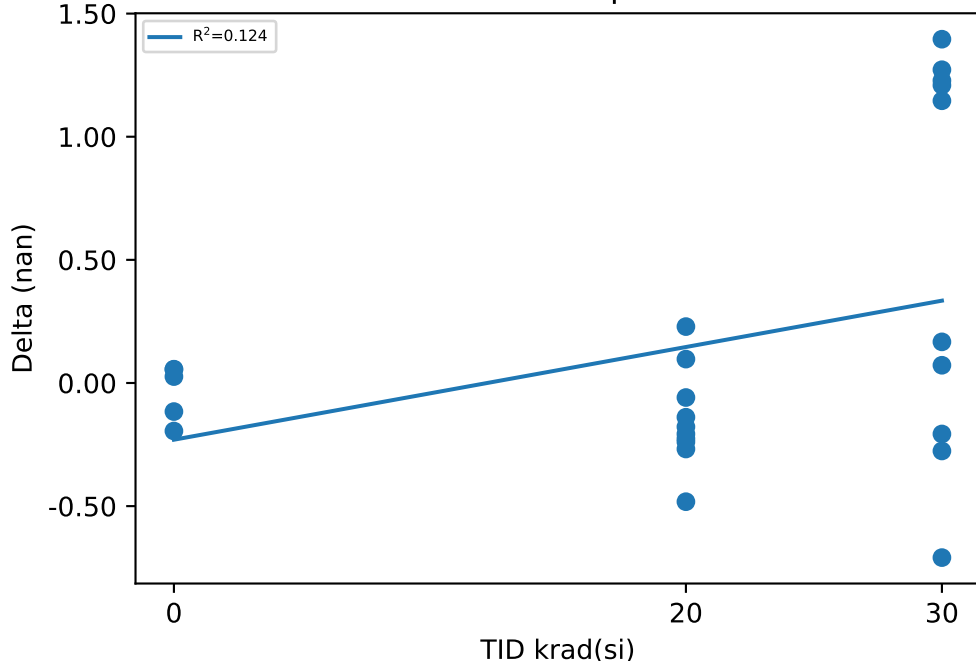

Test Statistics (nan)

krad(si)	Pre Exposure Min	Pre Exposure Avg	Pre Exposure Max	Pre Exposure Std	Post Exposure Min	Post Exposure Avg	Post Exposure Max	Post Exposure Std	Min Delta	Avg Delta	Max Delta	Std Delta
0	-1.069	-0.9552	-0.879	0.077738	-1.185	-0.99	-0.83	0.16954	-0.195	-0.0348	0.056	0.11431
20	-1.155	-0.7622	-0.267	0.32684	-1.637	-0.9094	-0.04	0.46094	-0.482	-0.1472	0.229	0.19856
30	-1.199	-1.036	-0.501	0.20689	-1.621	-0.5062	0.318	0.74854	-0.709	0.5298	1.396	0.79566

Device Test: 10.19 UJR405(dCSR_5mA_CH4_UJR405)

TID vs Result Stats

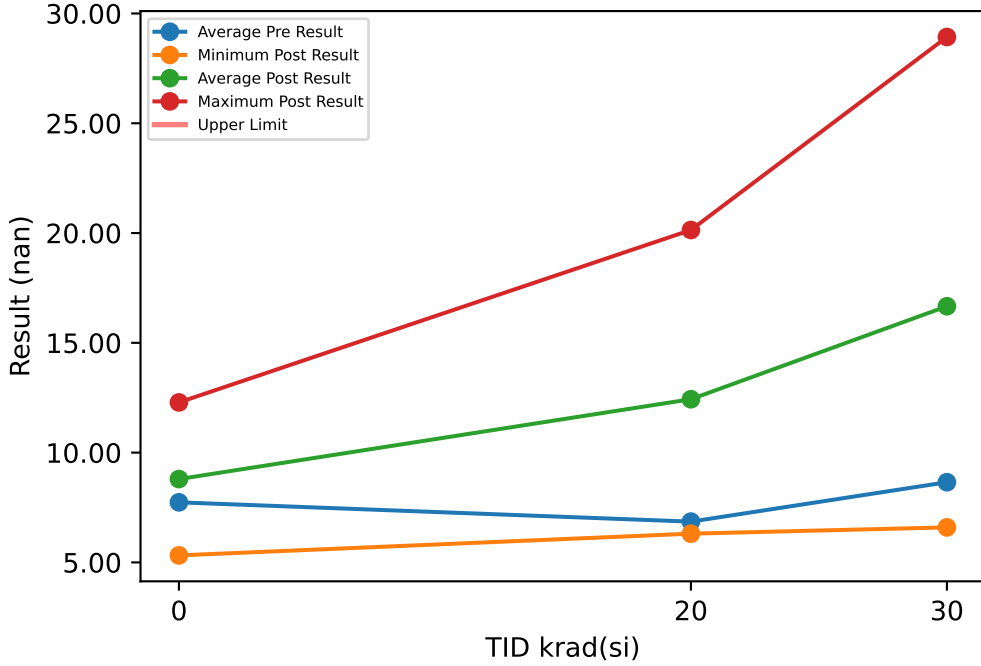

Test Results (No Limits Specified (nan))

Serial #	krad(si)	Exposure Conditions	Pre Result	Post Result	Delta
50	20	LDR biased	6.136	17.307	11.171
51	20	LDR biased	7.739	16.253	8.514
52	20	LDR biased	3.673	20.139	16.466
53	20	LDR biased	4.822	14.562	9.74
54	20	LDR biased	9.353	14.723	5.37
55	30	LDR biased	7.838	27.556	19.718
56	30	LDR biased	9.453	20.699	11.246
57	30	LDR biased	9.372	28.929	19.557
58	30	LDR biased	7.763	21.274	13.511
59	30	LDR biased	8.208	18.613	10.405
60	20	LDR unbiased	7.967	10.189	2.222
61	20	LDR unbiased	6.294	6.309	0.015
62	20	LDR unbiased	6.947	7.699	0.752
63	20	LDR unbiased	8.78	10.513	1.733
64	20	LDR unbiased	6.857	6.621	-0.236
65	30	LDR unbiased	5.419	7.541	2.122
66	30	LDR unbiased	12.238	12.553	0.315
67	30	LDR unbiased	7.223	6.595	-0.628
68	30	LDR unbiased	11.026	10.379	-0.647
69	30	LDR unbiased	7.972	12.515	4.543
70	0	correlation	9.857	9.028	-0.829
71	0	correlation	5.47	8.436	2.966
72	0	correlation	7.864	8.906	1.042
73	0	correlation	7.783	5.319	-2.464
74	0	correlation	7.704	12.286	4.582

TID vs Post - Pre Exposure Delta

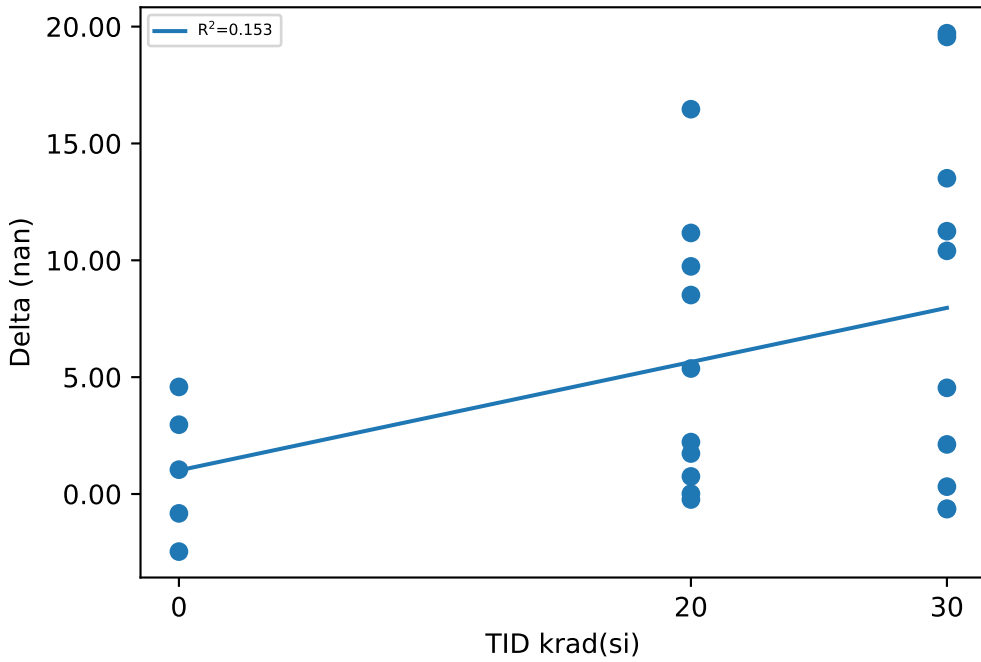

Test Statistics (nan)

krad(si)	Pre Exposure Min	Pre Exposure Avg	Pre Exposure Max	Pre Exposure Std	Post Exposure Min	Post Exposure Avg	Post Exposure Max	Post Exposure Std	Min Delta	Avg Delta	Max Delta	Std Delta
0	5.47	7.7356	9.857	1.5535	5.319	8.795	12.286	2.4731	-2.464	1.0594	4.582	2.8295
20	3.673	6.8568	9.353	1.734	6.309	12.431	20.139	4.8296	-0.236	5.5747	16.466	5.6755
30	5.419	8.6512	12.238	1.9511	6.595	16.665	28.929	7.9486	-0.647	8.0142	19.718	7.9745

Device Test: 10.2 UJFZSP(dCSR_25mA_CH1_UJFZSP)

TID vs Result Stats

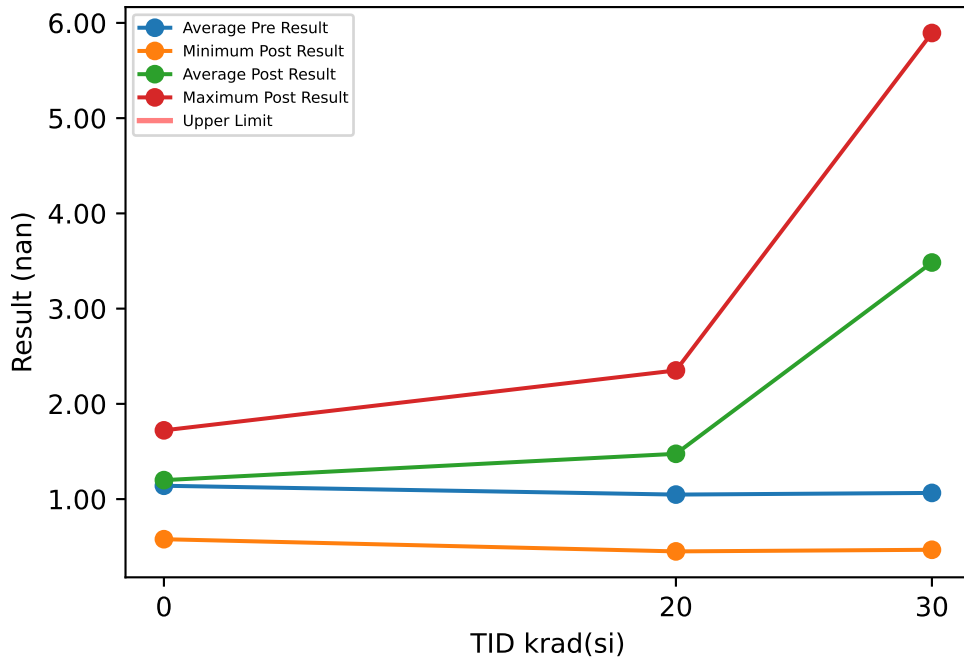

Test Results (No Limits Specified (nan))

Serial #	krad(si)	Exposure Conditions	Pre Result	Post Result	Delta
50	20	LDR biased	1.714	2.117	0.403
51	20	LDR biased	1.489	1.686	0.197
52	20	LDR biased	0.187	1.683	1.496
53	20	LDR biased	0.932	2.147	1.215
54	20	LDR biased	1.072	2.351	1.279
55	30	LDR biased	1.249	5.633	4.384
56	30	LDR biased	0.985	5.69	4.705
57	30	LDR biased	0.925	4.268	3.343
58	30	LDR biased	1.65	5.894	4.244
59	30	LDR biased	1.027	4.84	3.813
60	20	LDR unbiased	1.293	1.216	-0.077
61	20	LDR unbiased	1.134	0.721	-0.413
62	20	LDR unbiased	0.553	0.451	-0.102
63	20	LDR unbiased	0.964	1.191	0.227
64	20	LDR unbiased	1.137	1.193	0.056
65	30	LDR unbiased	0.361	0.468	0.107
66	30	LDR unbiased	1.749	2.647	0.898
67	30	LDR unbiased	1.22	1.935	0.715
68	30	LDR unbiased	0.123	1.444	1.321
69	30	LDR unbiased	1.361	2.023	0.662
70	0	correlation	0.823	1.203	0.38
71	0	correlation	0.578	0.579	0.001
72	0	correlation	1.198	1.34	0.142
73	0	correlation	1.185	1.722	0.537
74	0	correlation	1.917	1.152	-0.765

TID vs Post - Pre Exposure Delta

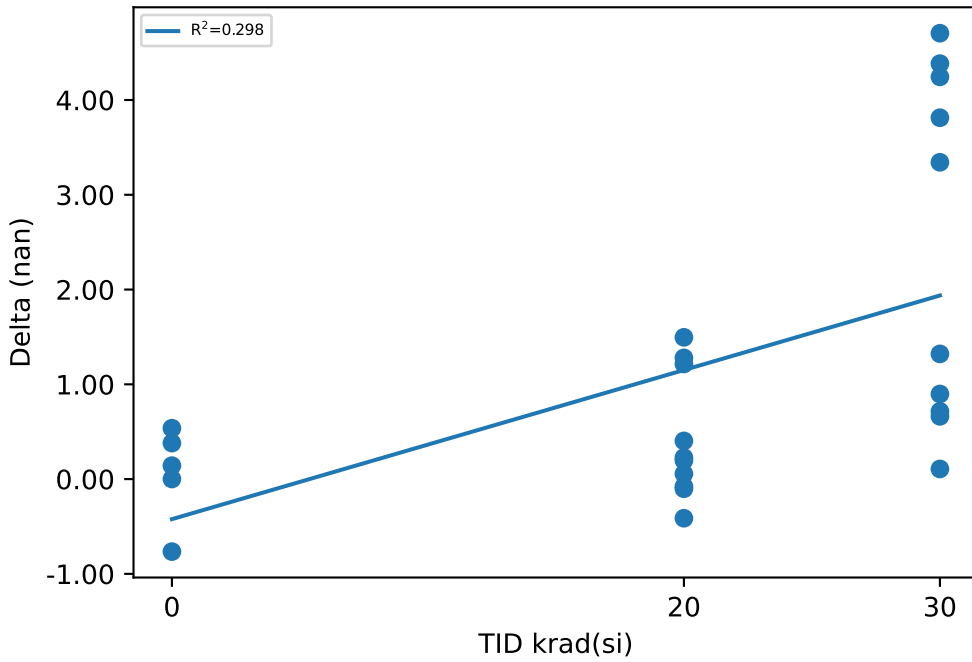

Test Statistics (nan)

krad(si)	Pre Exposure Min	Pre Exposure Avg	Pre Exposure Max	Pre Exposure Std	Post Exposure Min	Post Exposure Avg	Post Exposure Max	Post Exposure Std	Min Delta	Avg Delta	Max Delta	Std Delta
0	0.578	1.1402	1.917	0.50632	0.579	1.1992	1.722	0.41232	-0.765	0.059	0.537	0.50516
20	0.187	1.0475	1.714	0.43727	0.451	1.4756	2.351	0.62922	-0.413	0.4281	1.496	0.66334
30	0.123	1.065	1.749	0.51273	0.468	3.4842	5.894	2.0066	0.107	2.4192	4.705	1.8279

Device Test: 10.20 UJFZSP(dCSR_25mA_CH4_UJFZSP)

TID vs Result Stats

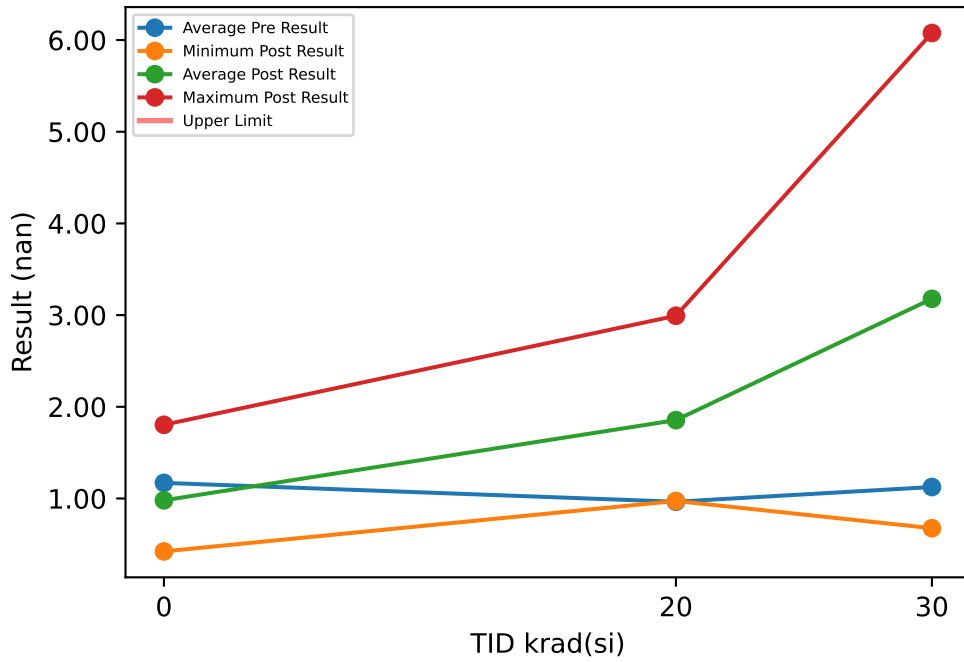

Test Results (No Limits Specified (nan))

Serial #	krad(si)	Exposure Conditions	Pre Result	Post Result	Delta
50	20	LDR biased	1.01	2.385	1.375
51	20	LDR biased	0.679	2.06	1.381
52	20	LDR biased	0.215	2.109	1.894
53	20	LDR biased	0.893	2.993	2.1
54	20	LDR biased	1.291	2.383	1.092
55	30	LDR biased	1.328	5.205	3.877
56	30	LDR biased	1.146	4.766	3.62
57	30	LDR biased	1.221	3.796	2.575
58	30	LDR biased	0.774	4.498	3.724
59	30	LDR biased	1.414	6.077	4.663
60	20	LDR unbiased	1.207	1.392	0.185
61	20	LDR unbiased	1.052	1.048	-0.004
62	20	LDR unbiased	0.731	0.973	0.242
63	20	LDR unbiased	0.856	1.288	0.432
64	20	LDR unbiased	1.713	1.915	0.202
65	30	LDR unbiased	0.681	0.676	-0.005
66	30	LDR unbiased	1.797	2.351	0.554
67	30	LDR unbiased	0.326	0.832	0.506
68	30	LDR unbiased	1.597	1.765	0.168
69	30	LDR unbiased	0.966	1.812	0.846
70	0	correlation	1.045	0.62	-0.425
71	0	correlation	1.01	0.423	-0.587
72	0	correlation	1.196	0.575	-0.621
73	0	correlation	1.329	1.804	0.475
74	0	correlation	1.272	1.479	0.207

TID vs Post - Pre Exposure Delta

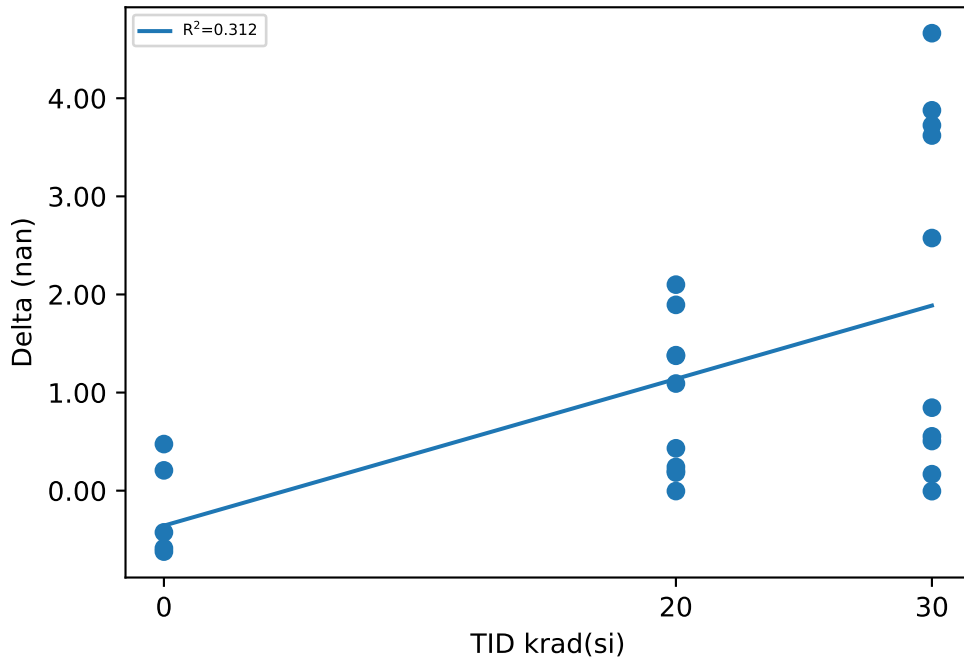

Test Statistics (nan)

krad(si)	Pre Exposure Min	Pre Exposure Avg	Pre Exposure Max	Pre Exposure Std	Post Exposure Min	Post Exposure Avg	Post Exposure Max	Post Exposure Std	Min Delta	Avg Delta	Max Delta	Std Delta
0	1.01	1.1704	1.329	0.13927	0.423	0.9802	1.804	0.61884	-0.621	-0.1902	0.475	0.49961
20	0.215	0.9647	1.713	0.40139	0.973	1.8546	2.993	0.6608	-0.004	0.8899	2.1	0.77377
30	0.326	1.125	1.797	0.44632	0.676	3.1778	6.077	1.9284	-0.005	2.0528	4.663	1.8118

Device Test: 10.21 UJF0T(dCSR_50mA_CH4_UJF0T)

TID vs Result Stats

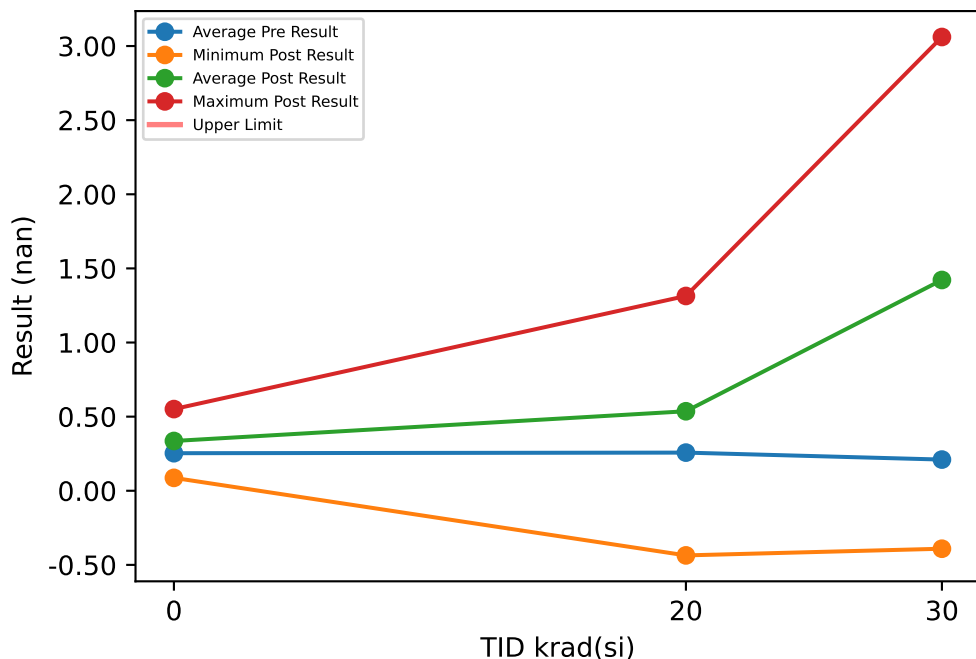

Test Results (No Limits Specified (nan))

Serial #	krad(si)	Exposure Conditions	Pre Result	Post Result	Delta
50	20	LDR biased	-0.011	0.77	0.781
51	20	LDR biased	0.194	0.273	0.079
52	20	LDR biased	0.037	0.763	0.726
53	20	LDR biased	0.631	1.259	0.628
54	20	LDR biased	0.386	1.314	0.928
55	30	LDR biased	-0.078	2.494	2.572
56	30	LDR biased	0.525	3.061	2.536
57	30	LDR biased	0.449	2.256	1.807
58	30	LDR biased	0.094	2.253	2.159
59	30	LDR biased	0.322	2.545	2.223
60	20	LDR unbiased	0.297	0.214	-0.083
61	20	LDR unbiased	0.035	0.002	-0.033
62	20	LDR unbiased	0.393	-0.436	-0.829
63	20	LDR unbiased	0.224	0.541	0.317
64	20	LDR unbiased	0.388	0.663	0.275
65	30	LDR unbiased	0.012	-0.391	-0.403
66	30	LDR unbiased	0.395	1.214	0.819
67	30	LDR unbiased	-0.513	0.047	0.56
68	30	LDR unbiased	0.739	0.535	-0.204
69	30	LDR unbiased	0.159	0.205	0.046
70	0	correlation	0.183	0.541	0.358
71	0	correlation	-0.077	0.184	0.261
72	0	correlation	0.026	0.087	0.061
73	0	correlation	0.681	0.316	-0.365
74	0	correlation	0.454	0.551	0.097

TID vs Post - Pre Exposure Delta

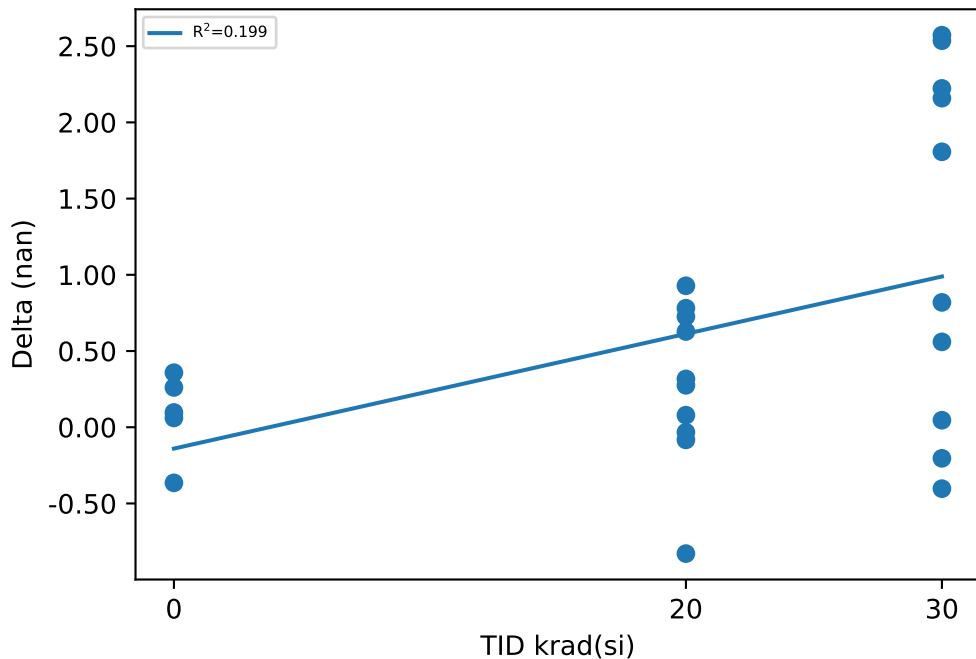

Test Statistics (nan)

krad(si)	Pre Exposure Min	Pre Exposure Avg	Pre Exposure Max	Pre Exposure Std	Post Exposure Min	Post Exposure Avg	Post Exposure Max	Post Exposure Std	Min Delta	Avg Delta	Max Delta	Std Delta
0	-0.077	0.2534	0.681	0.31181	0.087	0.3358	0.551	0.20842	-0.365	0.0824	0.358	0.2778
20	-0.011	0.2574	0.631	0.2023	-0.436	0.5363	1.314	0.54296	-0.829	0.2789	0.928	0.52624
30	-0.513	0.2104	0.739	0.35651	-0.391	1.4219	3.061	1.2459	-0.403	1.2115	2.572	1.1751

Device Test: 10.22 UJ74P3(dCSR_100mA_CH4_UJ74P3)

TID vs Result Stats

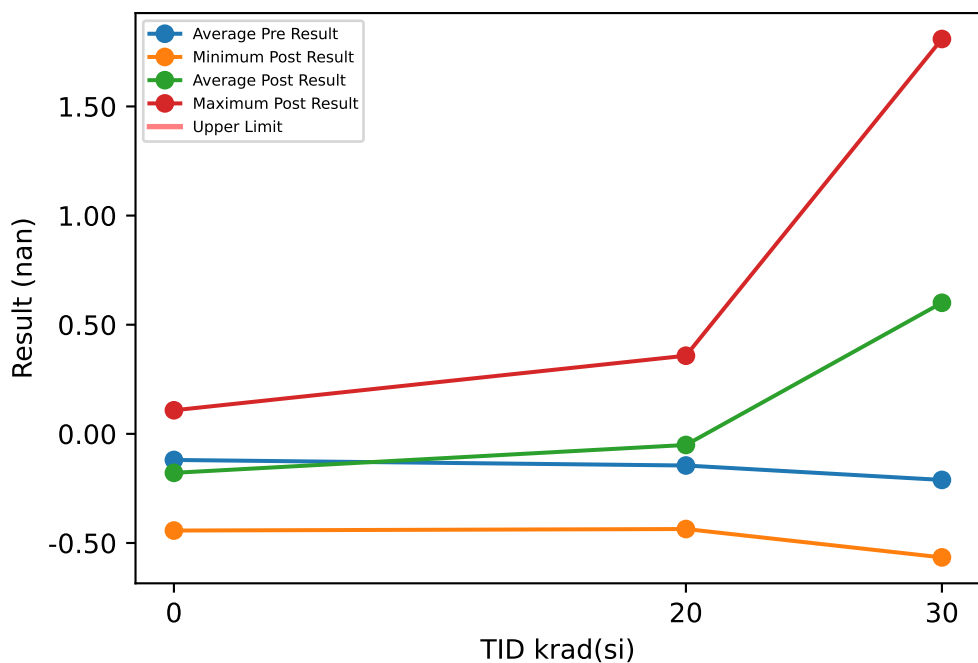

Test Results (No Limits Specified (nan))

Serial #	krad(si)	Exposure Conditions	Pre Result	Post Result	Delta
50	20	LDR biased	-0.269	-0.156	0.113
51	20	LDR biased	-0.437	-0.436	0.001
52	20	LDR biased	-0.331	0.094	0.425
53	20	LDR biased	-0.085	0.358	0.443
54	20	LDR biased	0.122	0.296	0.174
55	30	LDR biased	-0.109	1.809	1.918
56	30	LDR biased	-0.141	1.504	1.645
57	30	LDR biased	-0.159	1.177	1.336
58	30	LDR biased	-0.354	1.399	1.753
59	30	LDR biased	-0.198	1.5	1.698
60	20	LDR unbiased	-0.201	-0.304	-0.103
61	20	LDR unbiased	0.03	-0.114	-0.144
62	20	LDR unbiased	-0.085	-0.315	-0.23
63	20	LDR unbiased	-0.029	-0.064	-0.035
64	20	LDR unbiased	-0.165	0.132	0.297
65	30	LDR unbiased	-0.393	-0.566	-0.173
66	30	LDR unbiased	-0.085	0.117	0.202
67	30	LDR unbiased	-0.593	-0.413	0.18
68	30	LDR unbiased	0.235	-0.16	-0.395
69	30	LDR unbiased	-0.314	-0.362	-0.048
70	0	correlation	-0.263	-0.345	-0.082
71	0	correlation	-0.317	-0.443	-0.126
72	0	correlation	-0.255	-0.297	-0.042
73	0	correlation	0.129	0.108	-0.021
74	0	correlation	0.108	0.084	-0.024

TID vs Post - Pre Exposure Delta

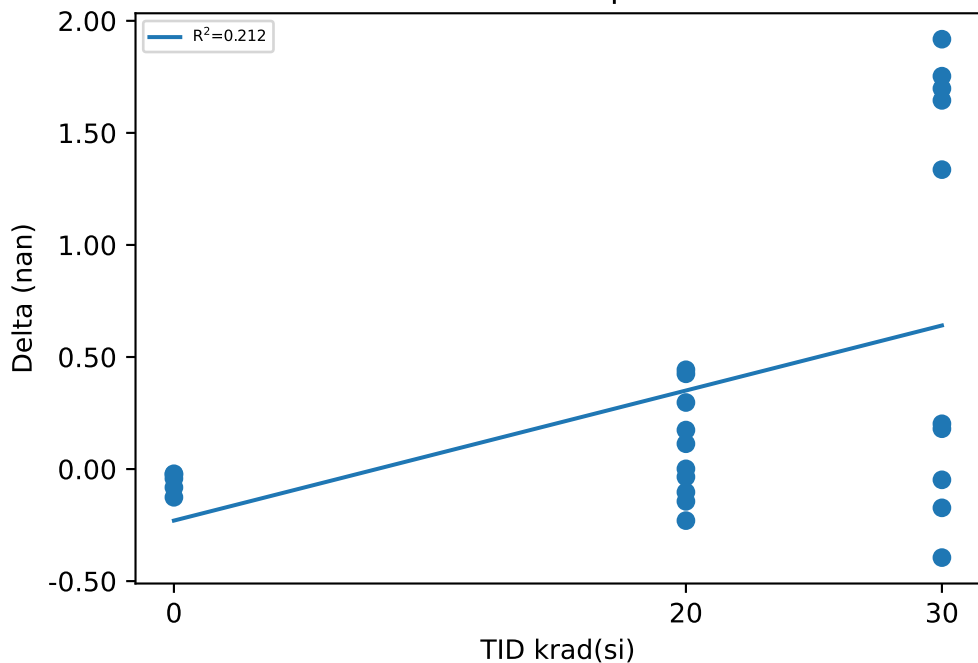

Test Statistics (nan)

krad(si)	Pre Exposure Min	Pre Exposure Avg	Pre Exposure Max	Pre Exposure Std	Post Exposure Min	Post Exposure Avg	Post Exposure Max	Post Exposure Std	Min Delta	Avg Delta	Max Delta	Std Delta
0	-0.317	-0.1196	0.129	0.21878	-0.443	-0.1786	0.108	0.25628	-0.126	-0.059	-0.021	0.044654
20	-0.437	-0.145	0.122	0.17041	-0.436	-0.0509	0.358	0.26652	-0.23	0.0941	0.443	0.23689
30	-0.593	-0.2111	0.235	0.22188	-0.566	0.6005	1.809	0.95349	-0.395	0.8116	1.918	0.93097

Device Test: 10.24 UJA0RR(dCSR_500mA_CH4_UJA0RR)

TID vs Result Stats

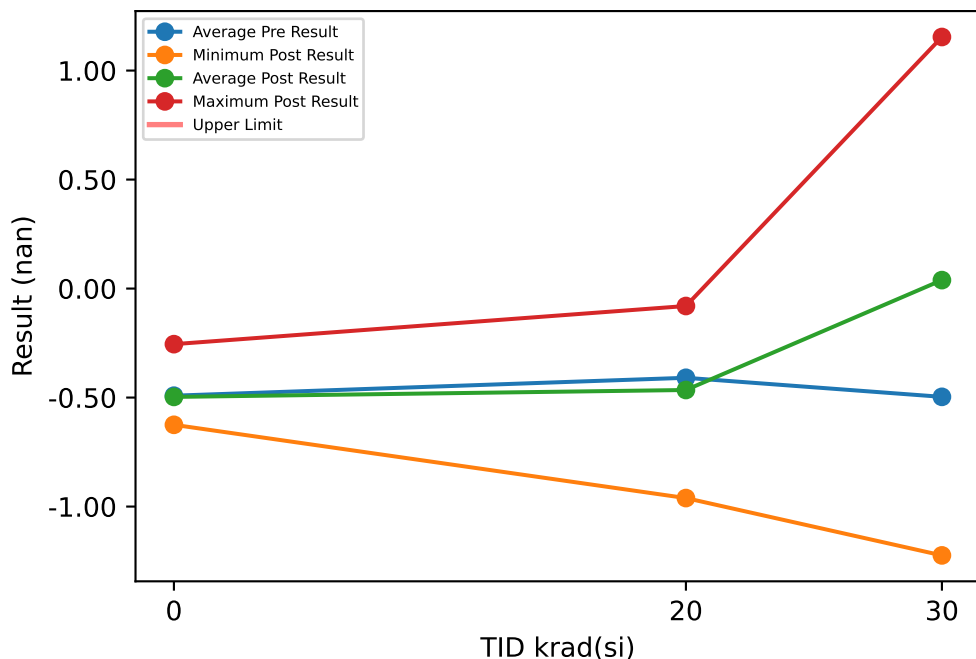

Test Results (No Limits Specified (nan))

Serial #	krad(si)	Exposure Conditions	Pre Result	Post Result	Delta
50	20	LDR biased	-0.458	-0.65	-0.192
51	20	LDR biased	-0.641	-0.961	-0.32
52	20	LDR biased	-0.597	-0.402	0.195
53	20	LDR biased	-0.3	-0.11	0.19
54	20	LDR biased	-0.206	-0.169	0.037
55	30	LDR biased	-0.369	0.775	1.144
56	30	LDR biased	-0.482	1.154	1.636
57	30	LDR biased	-0.377	0.53	0.907
58	30	LDR biased	-0.727	0.808	1.535
59	30	LDR biased	-0.372	0.859	1.231
60	20	LDR unbiased	-0.592	-0.651	-0.059
61	20	LDR unbiased	-0.304	-0.585	-0.281
62	20	LDR unbiased	-0.319	-0.527	-0.208
63	20	LDR unbiased	-0.376	-0.518	-0.142
64	20	LDR unbiased	-0.3	-0.08	0.22
65	30	LDR unbiased	-0.669	-1.224	-0.555
66	30	LDR unbiased	-0.556	-0.365	0.191
67	30	LDR unbiased	-0.761	-0.784	-0.023
68	30	LDR unbiased	-0.19	-0.45	-0.26
69	30	LDR unbiased	-0.464	-0.915	-0.451
70	0	correlation	-0.549	-0.613	-0.064
71	0	correlation	-0.688	-0.625	0.063
72	0	correlation	-0.531	-0.585	-0.054
73	0	correlation	-0.285	-0.255	0.03
74	0	correlation	-0.404	-0.407	-0.003

TID vs Post - Pre Exposure Delta

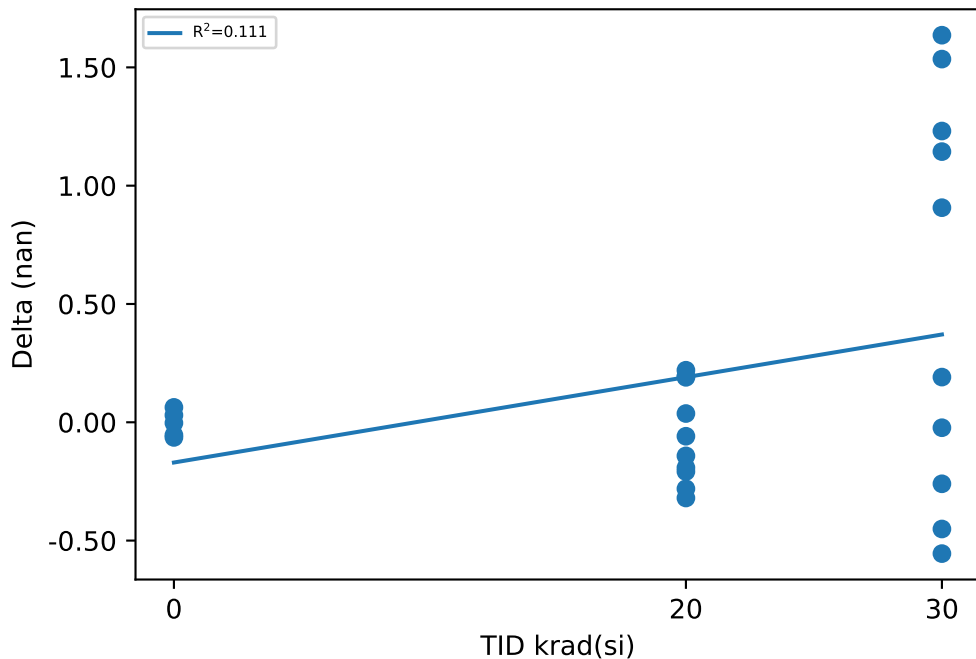

Test Statistics (nan)

krad(si)	Pre Exposure Min	Pre Exposure Avg	Pre Exposure Max	Pre Exposure Std	Post Exposure Min	Post Exposure Avg	Post Exposure Max	Post Exposure Std	Min Delta	Avg Delta	Max Delta	Std Delta
0	-0.688	-0.4914	-0.285	0.15312	-0.625	-0.497	-0.255	0.16144	-0.064	-0.0056	0.063	0.05416
20	-0.641	-0.4093	-0.206	0.15284	-0.961	-0.4653	-0.08	0.27923	-0.32	-0.056	0.22	0.20485
30	-0.761	-0.4967	-0.19	0.18185	-1.224	0.0388	1.154	0.87399	-0.555	0.5355	1.636	0.84511

Device Test: 10.25 UJXOZU(Kcs_5mA_CH1_UJXOZU)

TID vs Result Stats

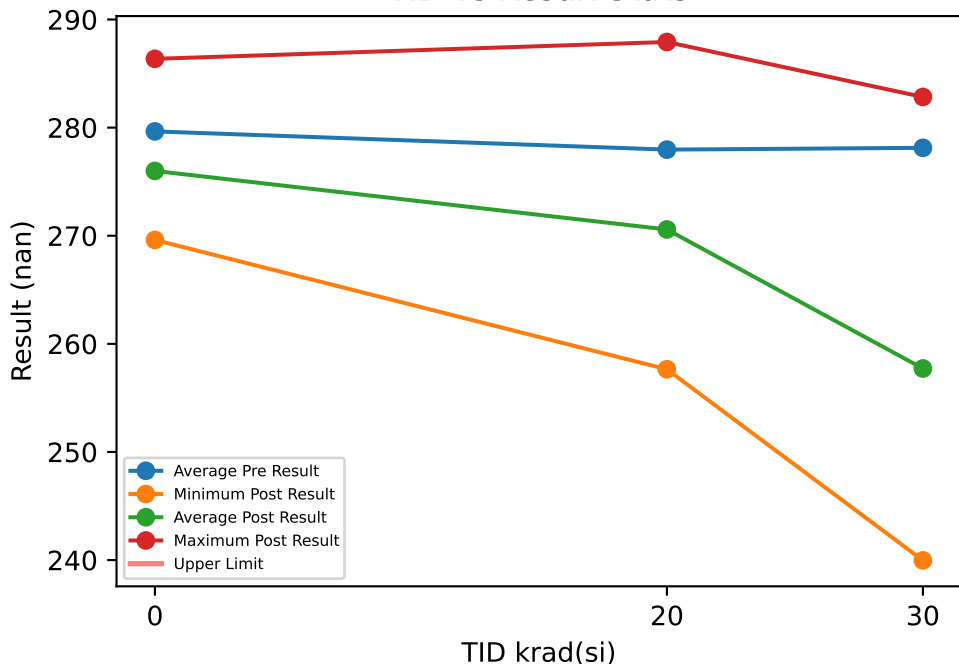

TID vs Post - Pre Exposure Delta

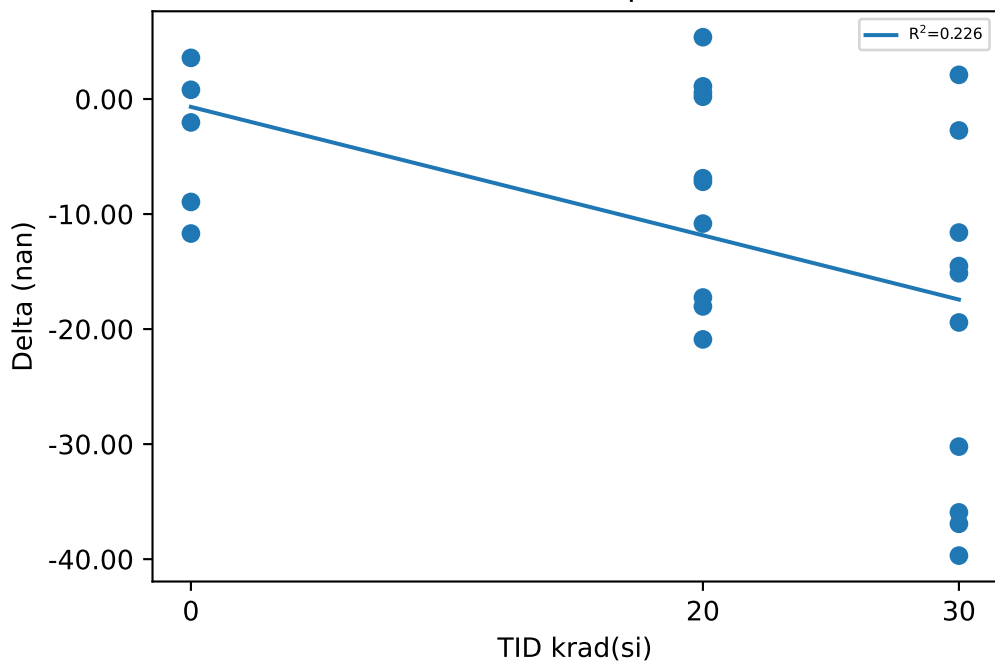

Test Results (No Limits Specified (nan))

Serial #	krad(si)	Exposure Conditions	Pre Result	Post Result	Delta
50	20	LDR biased	279.17	271.97	-7.195
51	20	LDR biased	277.17	259.14	-18.028
52	20	LDR biased	282.15	261.26	-20.896
53	20	LDR biased	274.9	257.65	-17.254
54	20	LDR biased	273.06	262.23	-10.829
55	30	LDR biased	279.66	239.97	-39.691
56	30	LDR biased	282.42	246.49	-35.934
57	30	LDR biased	265.67	250.53	-15.142
58	30	LDR biased	277.85	240.93	-36.926
59	30	LDR biased	280.04	249.82	-30.215
60	20	LDR unbiased	266.38	271.75	5.375
61	20	LDR unbiased	285.08	278.2	-6.884
62	20	LDR unbiased	287.37	287.92	0.555
63	20	LDR unbiased	277.09	277.29	0.198
64	20	LDR unbiased	277.29	278.38	1.097
65	30	LDR unbiased	280.73	282.83	2.101
66	30	LDR unbiased	280.78	261.36	-19.425
67	30	LDR unbiased	281.41	269.8	-11.608
68	30	LDR unbiased	272.33	269.6	-2.734
69	30	LDR unbiased	280.41	265.88	-14.522
70	0	correlation	278.12	276.09	-2.035
71	0	correlation	282.98	274.03	-8.947
72	0	correlation	282.78	286.36	3.578
73	0	correlation	281.31	269.62	-11.692
74	0	correlation	273.06	273.87	0.803

Test Statistics (nan)

krad(si)	Pre Exposure Min	Pre Exposure Avg	Pre Exposure Max	Pre Exposure Std	Post Exposure Min	Post Exposure Avg	Post Exposure Max	Post Exposure Std	Min Delta	Avg Delta	Max Delta	Std Delta
0	273.06	279.65	282.98	4.1635	269.62	275.99	286.36	6.2564	-11.692	-3.6586	3.578	6.4694
20	266.38	277.97	287.37	6.0324	257.65	270.58	287.92	10.125	-20.896	-7.3861	5.375	9.1934
30	265.67	278.13	282.42	5.1964	239.97	257.72	282.83	14.279	-39.691	-20.41	2.101	14.688

Device Test: 10.26 UJXOZU(Kcs_25mA_CH1_UJXOZU)

TID vs Result Stats

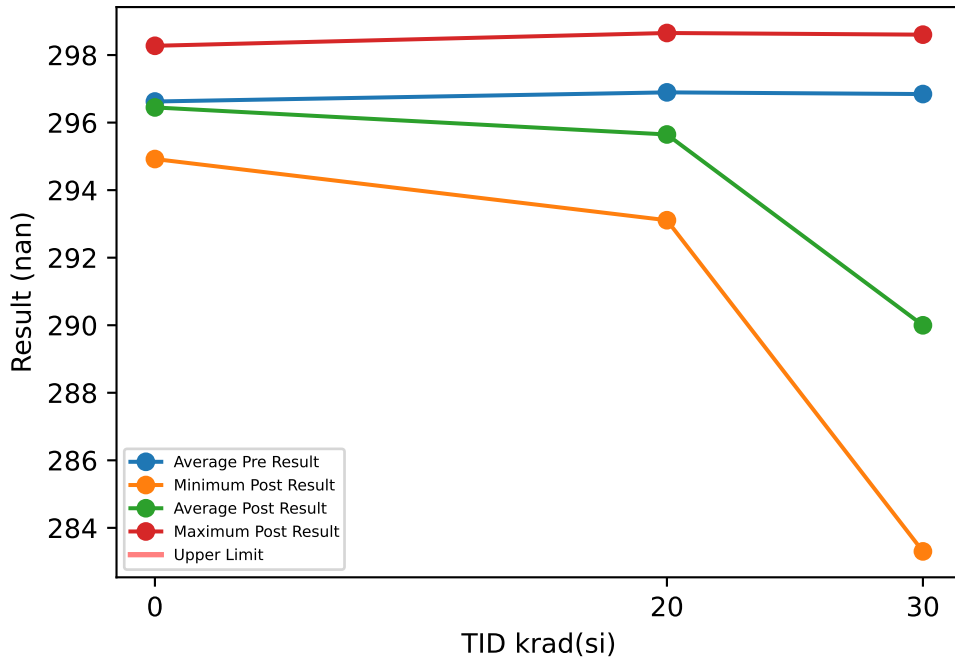

Test Results (No Limits Specified (nan))

Serial #	krad(si)	Exposure Conditions	Pre Result	Post Result	Delta
50	20	LDR biased	294.94	293.78	-1.163
51	20	LDR biased	295.6	295.03	-0.573
52	20	LDR biased	299.44	295.04	-4.406
53	20	LDR biased	297.23	293.69	-3.534
54	20	LDR biased	296.82	293.11	-3.71
55	30	LDR biased	296.3	284	-12.297
56	30	LDR biased	297.07	283.85	-13.225
57	30	LDR biased	297.25	287.72	-9.53
58	30	LDR biased	295.13	283.3	-11.828
59	30	LDR biased	296.95	286.15	-10.8
60	20	LDR unbiased	296.17	296.4	0.228
61	20	LDR unbiased	296.63	297.85	1.218
62	20	LDR unbiased	298.35	298.65	0.304
63	20	LDR unbiased	297.14	296.47	-0.668
64	20	LDR unbiased	296.63	296.46	-0.164
65	30	LDR unbiased	298.92	298.6	-0.316
66	30	LDR unbiased	294.84	292.26	-2.58
67	30	LDR unbiased	296.38	294.31	-2.078
68	30	LDR unbiased	299.63	295.73	-3.901
69	30	LDR unbiased	295.97	294.05	-1.922
70	0	correlation	297.55	296.43	-1.118
71	0	correlation	298.27	298.27	-0.001
72	0	correlation	296.45	296.03	-0.417
73	0	correlation	296.49	294.92	-1.567
74	0	correlation	294.36	296.58	2.225

TID vs Post - Pre Exposure Delta

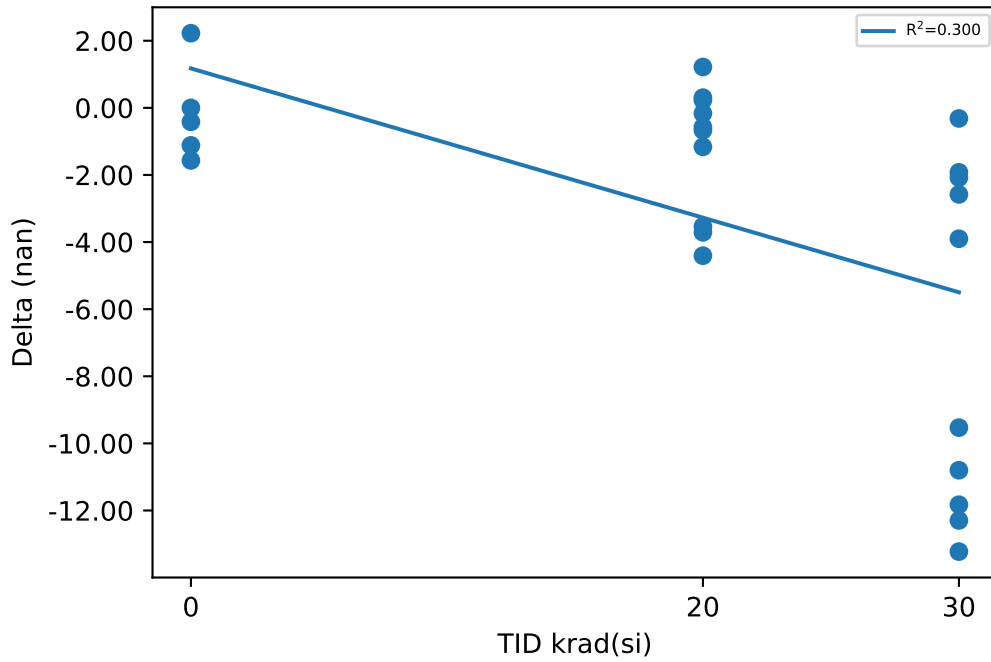

Test Statistics (nan)

krad(si)	Pre Exposure Min	Pre Exposure Avg	Pre Exposure Max	Pre Exposure Std	Post Exposure Min	Post Exposure Avg	Post Exposure Max	Post Exposure Std	Min Delta	Avg Delta	Max Delta	Std Delta
0	294.36	296.62	298.27	1.4808	294.92	296.45	298.27	1.2101	-1.567	-0.1756	2.225	1.4727
20	294.94	296.89	299.44	1.2877	293.11	295.65	298.65	1.8349	-4.406	-1.2468	1.218	1.9409
30	294.84	296.85	299.63	1.5096	283.3	290	298.6	5.6333	-13.225	-6.8477	-0.316	5.1051

Device Test: 10.27 UJXOZU(Kcs_50mA_CH1_UJXOZU)

TID vs Result Stats

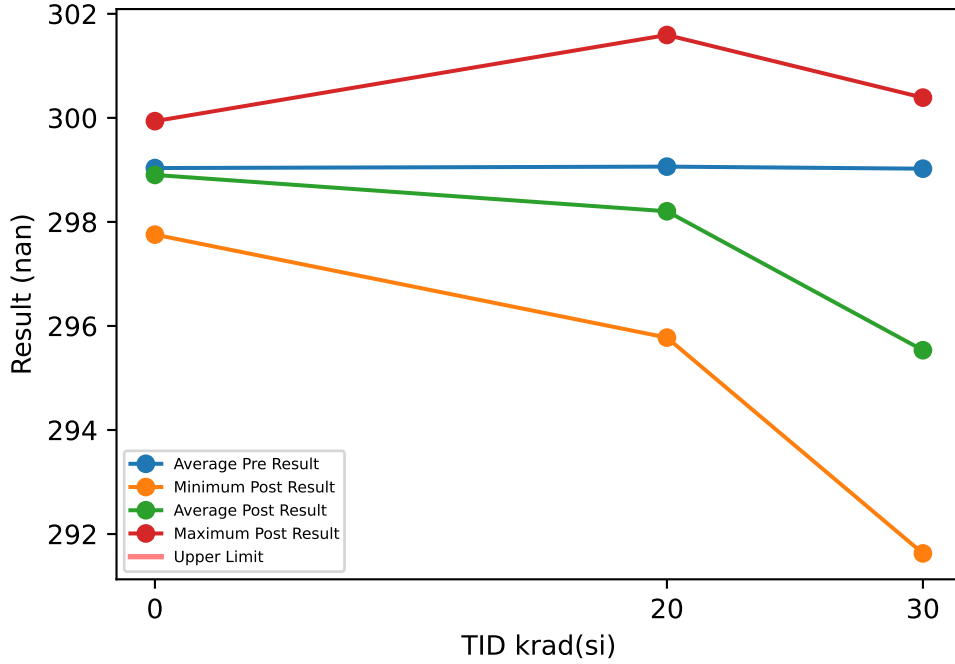

Test Results (No Limits Specified (nan))

Serial #	krad(si)	Exposure Conditions	Pre Result	Post Result	Delta
50	20	LDR biased	299.57	297.19	-2.377
51	20	LDR biased	298.95	298.42	-0.53
52	20	LDR biased	297.93	295.78	-2.158
53	20	LDR biased	299.58	297.57	-2.011
54	20	LDR biased	298.61	296.44	-2.168
55	30	LDR biased	298.89	292.54	-6.353
56	30	LDR biased	298.97	291.74	-7.224
57	30	LDR biased	299.54	294.86	-4.682
58	30	LDR biased	299.82	291.63	-8.191
59	30	LDR biased	298.29	292.07	-6.22
60	20	LDR unbiased	299.57	299.22	-0.348
61	20	LDR unbiased	300.76	298.22	-2.546
62	20	LDR unbiased	299.13	301.59	2.464
63	20	LDR unbiased	298.41	299.32	0.909
64	20	LDR unbiased	298.12	298.3	0.18
65	30	LDR unbiased	300.07	300.39	0.32
66	30	LDR unbiased	299.1	298.06	-1.035
67	30	LDR unbiased	298.71	297.76	-0.949
68	30	LDR unbiased	298.94	298.12	-0.825
69	30	LDR unbiased	297.91	298.17	0.264
70	0	correlation	300.13	299.94	-0.194
71	0	correlation	299.82	299.6	-0.219
72	0	correlation	299.12	298.5	-0.618
73	0	correlation	298.32	297.76	-0.568
74	0	correlation	297.78	298.72	0.937

TID vs Post - Pre Exposure Delta

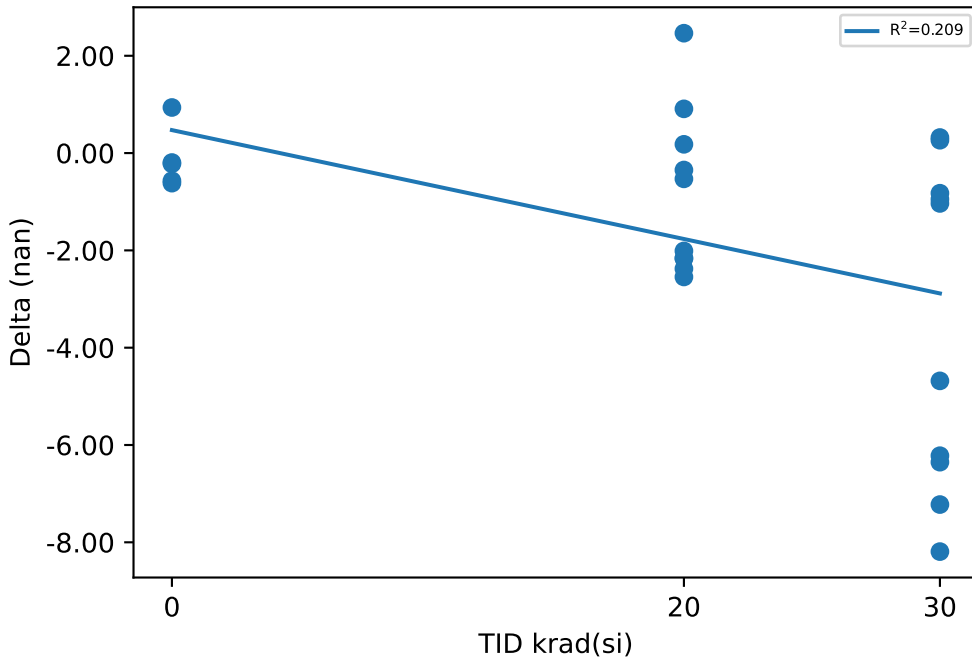

Test Statistics (nan)

krad(si)	Pre Exposure Min	Pre Exposure Avg	Pre Exposure Max	Pre Exposure Std	Post Exposure Min	Post Exposure Avg	Post Exposure Max	Post Exposure Std	Min Delta	Avg Delta	Max Delta	Std Delta
0	297.78	299.04	300.13	0.98795	297.76	298.9	299.94	0.87515	-0.618	-0.1324	0.937	0.62858
20	297.93	299.06	300.76	0.84905	295.78	298.2	301.59	1.6411	-2.546	-0.8585	2.464	1.6831
30	297.91	299.02	300.07	0.65927	291.63	295.53	300.39	3.3274	-8.191	-3.4895	0.32	3.355

Device Test: 10.28 UJXOZU(Kcs_100mA_CH1_UJXOZU)

TID vs Result Stats



Test Results (No Limits Specified (nan))

Serial #	krad(si)	Exposure Conditions	Pre Result	Post Result	Delta
50	20	LDR biased	300.25	299.93	-0.313
51	20	LDR biased	300.47	300.17	-0.304
52	20	LDR biased	299.99	298.31	-1.681
53	20	LDR biased	300.58	299.22	-1.362
54	20	LDR biased	300.07	299.31	-0.762
55	30	LDR biased	300.44	295.4	-5.035
56	30	LDR biased	300.58	294.96	-5.627
57	30	LDR biased	300.55	296.96	-3.592
58	30	LDR biased	300.81	295.11	-5.704
59	30	LDR biased	299.91	295.81	-4.099
60	20	LDR unbiased	300.35	300.46	0.116
61	20	LDR unbiased	300.57	300.75	0.188
62	20	LDR unbiased	300.54	301.21	0.672
63	20	LDR unbiased	299.89	300.83	0.944
64	20	LDR unbiased	300.27	299.42	-0.848
65	30	LDR unbiased	301.18	302.5	1.324
66	30	LDR unbiased	300.12	299.59	-0.532
67	30	LDR unbiased	299.32	299.17	-0.149
68	30	LDR unbiased	299.69	300.56	0.87
69	30	LDR unbiased	299.1	300.15	1.058
70	0	correlation	301.12	301.79	0.671
71	0	correlation	300.92	300.64	-0.273
72	0	correlation	299.77	299.89	0.118
73	0	correlation	299.75	300.05	0.3
74	0	correlation	300.41	300.06	-0.356

TID vs Post - Pre Exposure Delta

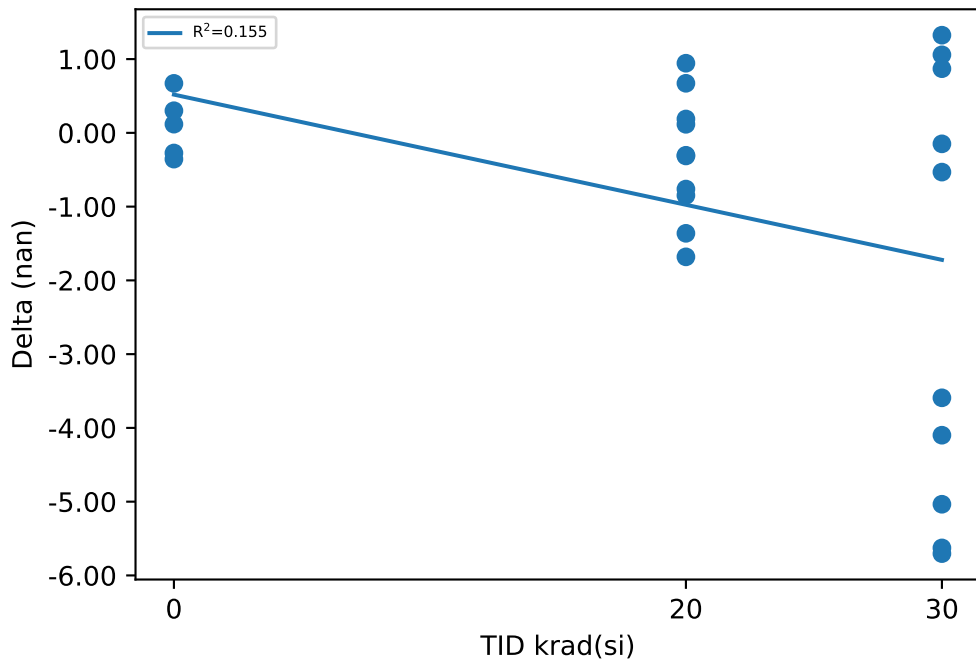

Test Statistics (nan)

krad(si)	Pre Exposure Min	Pre Exposure Avg	Pre Exposure Max	Pre Exposure Std	Post Exposure Min	Post Exposure Avg	Post Exposure Max	Post Exposure Std	Min Delta	Avg Delta	Max Delta	Std Delta
0	299.75	300.4	301.12	0.63235	299.89	300.49	301.79	0.78452	-0.356	0.092	0.671	0.42223
20	299.89	300.3	300.58	0.24824	298.31	299.96	301.21	0.89521	-1.681	-0.335	0.944	0.84592
30	299.1	300.17	301.18	0.66623	294.96	298.02	302.5	2.6984	-5.704	-2.1486	1.324	2.9254

Device Test: 10.29 UJXOZU(Kcs_250mA_CH1_UJXOZU)

TID vs Result Stats

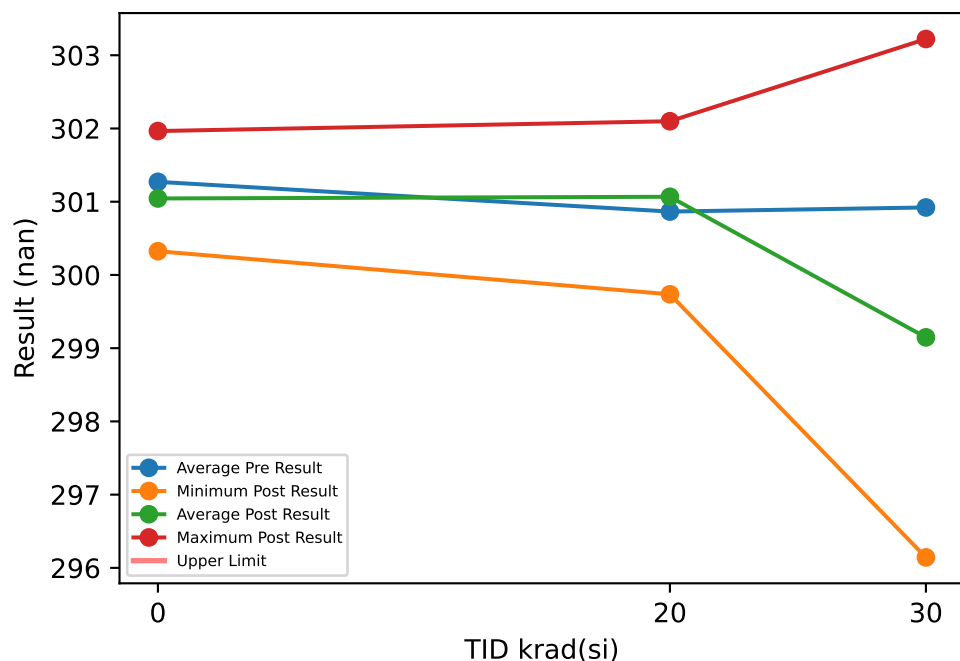

Test Results (No Limits Specified (nan))

Serial #	krad(si)	Exposure Conditions	Pre Result	Post Result	Delta
50	20	LDR biased	300.98	299.74	-1.246
51	20	LDR biased	301.47	301.86	0.381
52	20	LDR biased	299.9	300.35	0.449
53	20	LDR biased	300.95	300.84	-0.11
54	20	LDR biased	300.43	301.36	0.937
55	30	LDR biased	301.09	296.7	-4.389
56	30	LDR biased	301.37	296.16	-5.209
57	30	LDR biased	301.26	298.94	-2.315
58	30	LDR biased	300.79	296.14	-4.643
59	30	LDR biased	300.36	297.43	-2.928
60	20	LDR unbiased	301.54	301.22	-0.314
61	20	LDR unbiased	301.12	301.38	0.263
62	20	LDR unbiased	300.94	302.1	1.155
63	20	LDR unbiased	301.01	301.84	0.837
64	20	LDR unbiased	300.31	299.98	-0.334
65	30	LDR unbiased	302.31	303.22	0.914
66	30	LDR unbiased	301.08	300.7	-0.375
67	30	LDR unbiased	300.22	300.04	-0.182
68	30	LDR unbiased	300.42	301.65	1.23
69	30	LDR unbiased	300.32	300.48	0.16
70	0	correlation	301.98	301.96	-0.019
71	0	correlation	301.83	301.55	-0.284
72	0	correlation	299.91	300.32	0.414
73	0	correlation	300.92	300.49	-0.436
74	0	correlation	301.71	300.9	-0.809

TID vs Post - Pre Exposure Delta

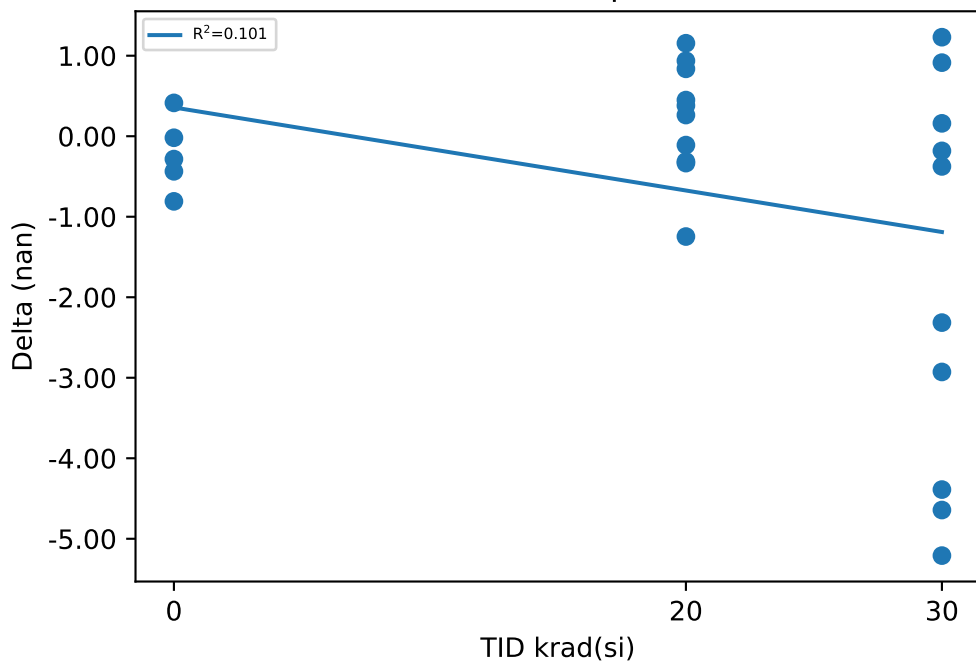

Test Statistics (nan)

krad(si)	Pre Exposure Min	Pre Exposure Avg	Pre Exposure Max	Pre Exposure Std	Post Exposure Min	Post Exposure Avg	Post Exposure Max	Post Exposure Std	Min Delta	Avg Delta	Max Delta	Std Delta
0	299.91	301.27	301.98	0.86411	300.32	301.04	301.96	0.69786	-0.809	-0.2268	0.414	0.4582
20	299.9	300.87	301.54	0.51161	299.74	301.07	302.1	0.81765	-1.246	0.2018	1.155	0.72234
30	300.22	300.92	302.31	0.64426	296.14	299.15	303.22	2.4662	-5.209	-1.7737	1.23	2.4261

Device Test: 10.3 UJF0T(dCSR_50mA_CH1_UJF0T)

TID vs Result Stats

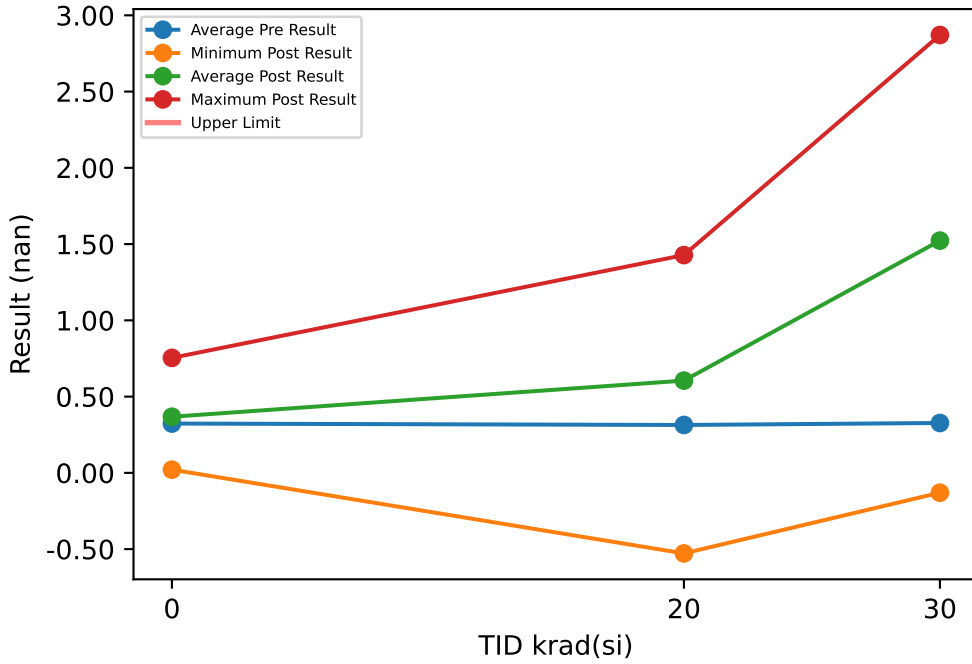

Test Results (No Limits Specified (nan))

Serial #	krad(si)	Exposure Conditions	Pre Result	Post Result	Delta
50	20	LDR biased	0.144	0.945	0.801
51	20	LDR biased	0.352	0.53	0.178
52	20	LDR biased	0.693	1.428	0.735
53	20	LDR biased	0.14	0.817	0.677
54	20	LDR biased	0.465	1.2	0.735
55	30	LDR biased	0.371	2.55	2.179
56	30	LDR biased	0.346	2.83	2.484
57	30	LDR biased	0.154	1.744	1.59
58	30	LDR biased	0.06	2.871	2.811
59	30	LDR biased	0.574	2.716	2.142
60	20	LDR unbiased	0.144	0.26	0.116
61	20	LDR unbiased	-0.254	0.598	0.852
62	20	LDR unbiased	0.291	-0.528	-0.819
63	20	LDR unbiased	0.534	0.228	-0.306
64	20	LDR unbiased	0.631	0.571	-0.06
65	30	LDR unbiased	-0.023	-0.13	-0.107
66	30	LDR unbiased	0.301	0.649	0.348
67	30	LDR unbiased	0.433	0.753	0.32
68	30	LDR unbiased	0.353	0.631	0.278
69	30	LDR unbiased	0.702	0.613	-0.089
70	0	correlation	-0.044	0.021	0.065
71	0	correlation	0.06	0.134	0.074
72	0	correlation	0.293	0.501	0.208
73	0	correlation	0.562	0.754	0.192
74	0	correlation	0.746	0.43	-0.316

TID vs Post - Pre Exposure Delta

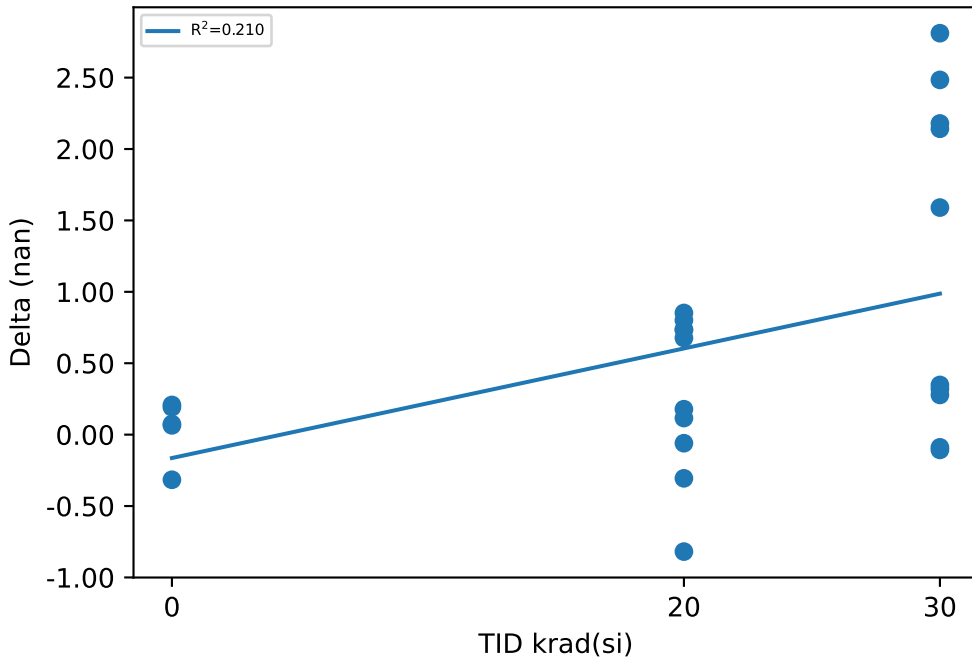

Test Statistics (nan)

krad(si)	Pre Exposure Min	Pre Exposure Avg	Pre Exposure Max	Pre Exposure Std	Post Exposure Min	Post Exposure Avg	Post Exposure Max	Post Exposure Std	Min Delta	Avg Delta	Max Delta	Std Delta
0	-0.044	0.3234	0.746	0.33197	0.021	0.368	0.754	0.29398	-0.316	0.0446	0.208	0.21198
20	-0.254	0.314	0.693	0.28441	-0.528	0.6049	1.428	0.55212	-0.819	0.2909	0.852	0.56502
30	-0.023	0.3271	0.702	0.22117	-0.13	1.5227	2.871	1.1433	-0.107	1.1956	2.811	1.1529

Device Test: 10.30 UJXOZU(Kcs_500mA_CH1_UJXOZU)

TID vs Result Stats

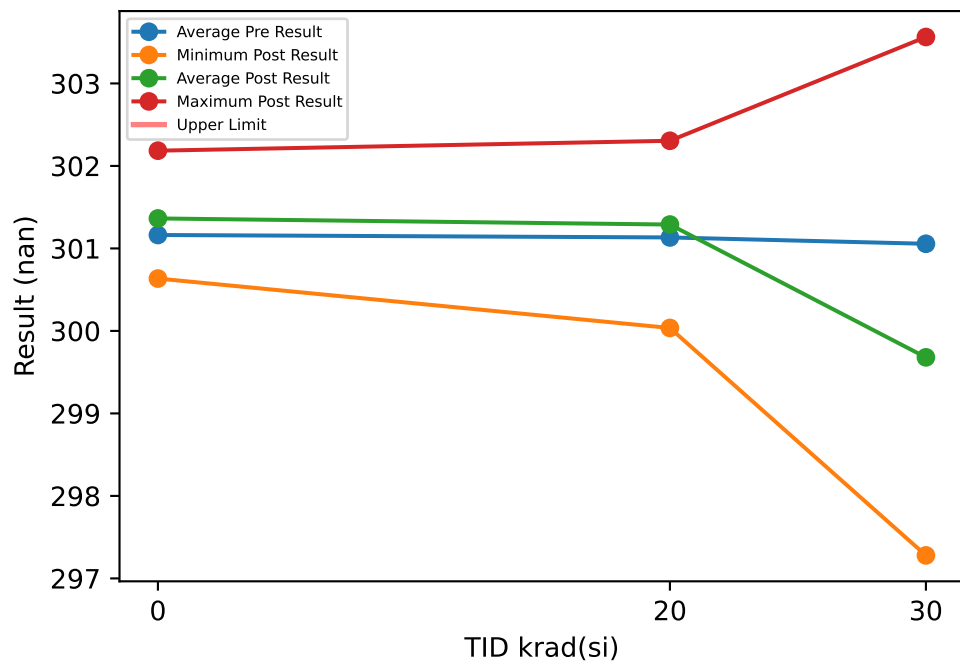

Test Results (No Limits Specified (nan))

Serial #	krad(si)	Exposure Conditions	Pre Result	Post Result	Delta
50	20	LDR biased	300.74	301.34	0.595
51	20	LDR biased	301.45	302.31	0.854
52	20	LDR biased	299.99	300.05	0.061
53	20	LDR biased	301.65	301.15	-0.502
54	20	LDR biased	301	300.98	-0.02
55	30	LDR biased	301.26	297.28	-3.978
56	30	LDR biased	301.55	297.34	-4.212
57	30	LDR biased	301.61	299.03	-2.584
58	30	LDR biased	301.39	297.61	-3.781
59	30	LDR biased	300.55	297.71	-2.842
60	20	LDR unbiased	301.3	301.71	0.415
61	20	LDR unbiased	301.3	301.62	0.324
62	20	LDR unbiased	301.42	302.09	0.675
63	20	LDR unbiased	301.35	301.61	0.265
64	20	LDR unbiased	301.14	300.04	-1.104
65	30	LDR unbiased	302.19	303.56	1.369
66	30	LDR unbiased	301.17	300.88	-0.296
67	30	LDR unbiased	300.08	300.01	-0.064
68	30	LDR unbiased	300.5	302.42	1.92
69	30	LDR unbiased	300.25	300.95	0.701
70	0	correlation	302.06	302.19	0.13
71	0	correlation	301.81	301.79	-0.024
72	0	correlation	300.61	300.63	0.024
73	0	correlation	300.33	300.83	0.503
74	0	correlation	301.01	301.38	0.371

TID vs Post - Pre Exposure Delta

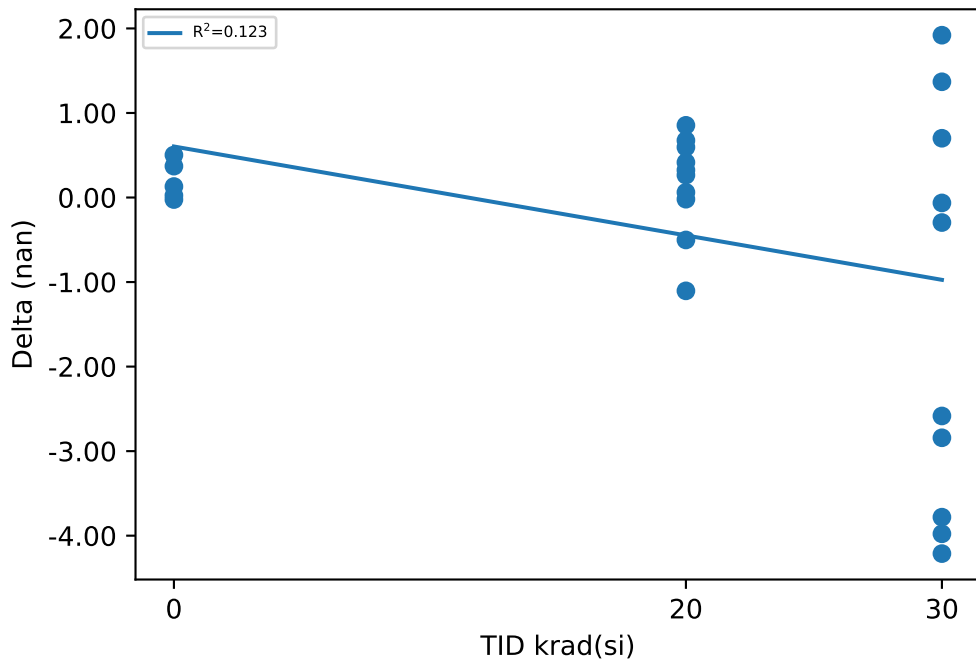

Test Statistics (nan)

krad(si)	Pre Exposure Min	Pre Exposure Avg	Pre Exposure Max	Pre Exposure Std	Post Exposure Min	Post Exposure Avg	Post Exposure Max	Post Exposure Std	Min Delta	Avg Delta	Max Delta	Std Delta
0	300.33	301.16	302.06	0.74823	300.63	301.36	302.19	0.6458	-0.024	0.2008	0.503	0.22754
20	299.99	301.13	301.65	0.47434	300.04	301.29	302.31	0.76711	-1.104	0.1563	0.854	0.5885
30	300.08	301.06	302.19	0.68246	297.28	299.68	303.56	2.2494	-4.212	-1.3767	1.92	2.3524

Device Test: 10.31 UJXOZU(Kcs_5mA_CH2_UJXOZU)

TID vs Result Stats

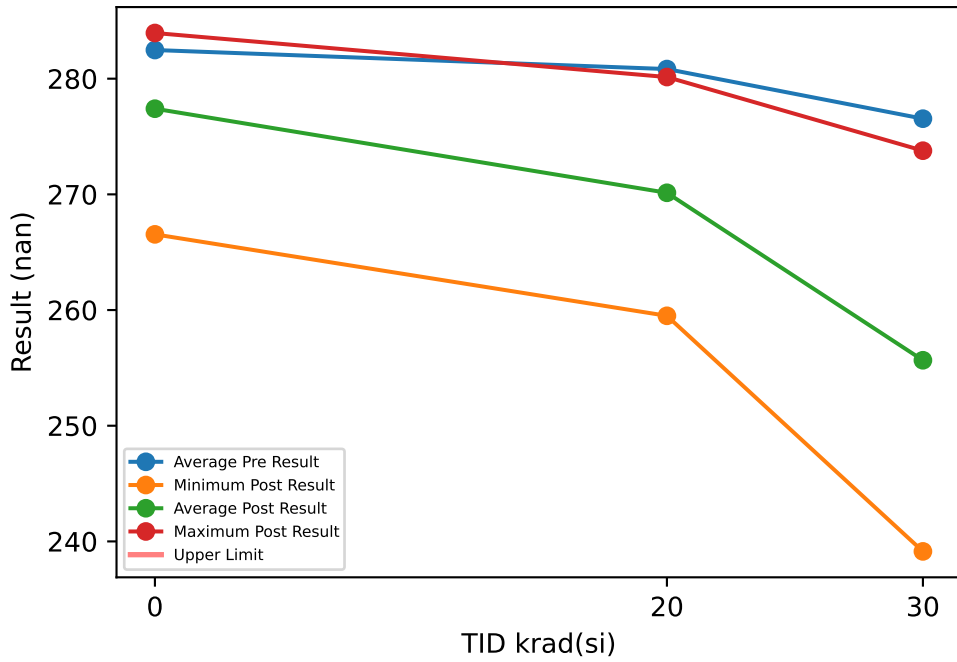

Test Results (No Limits Specified (nan))

Serial #	krad(si)	Exposure Conditions	Pre Result	Post Result	Delta
50	20	LDR biased	281.91	262.73	-19.18
51	20	LDR biased	275.82	264.28	-11.535
52	20	LDR biased	289.02	259.5	-29.522
53	20	LDR biased	276.87	263.54	-13.336
54	20	LDR biased	280.15	269.64	-10.51
55	30	LDR biased	280.71	241.32	-39.393
56	30	LDR biased	275.17	247.4	-27.769
57	30	LDR biased	273.58	244.29	-29.289
58	30	LDR biased	276.68	239.14	-37.547
59	30	LDR biased	272.37	249.14	-23.232
60	20	LDR unbiased	278.75	273.46	-5.292
61	20	LDR unbiased	288.84	280.14	-8.702
62	20	LDR unbiased	283.49	277.18	-6.308
63	20	LDR unbiased	275.18	278.32	3.142
64	20	LDR unbiased	278.29	272.57	-5.718
65	30	LDR unbiased	277.39	273.77	-3.614
66	30	LDR unbiased	273.77	259.53	-14.247
67	30	LDR unbiased	281.21	263.96	-17.251
68	30	LDR unbiased	278.57	265.8	-12.771
69	30	LDR unbiased	275.96	272.24	-3.717
70	0	correlation	280.65	275.54	-5.114
71	0	correlation	277.52	280.17	2.647
72	0	correlation	284.7	283.95	-0.755
73	0	correlation	286.88	280.83	-6.054
74	0	correlation	282.63	266.54	-16.085

TID vs Post - Pre Exposure Delta

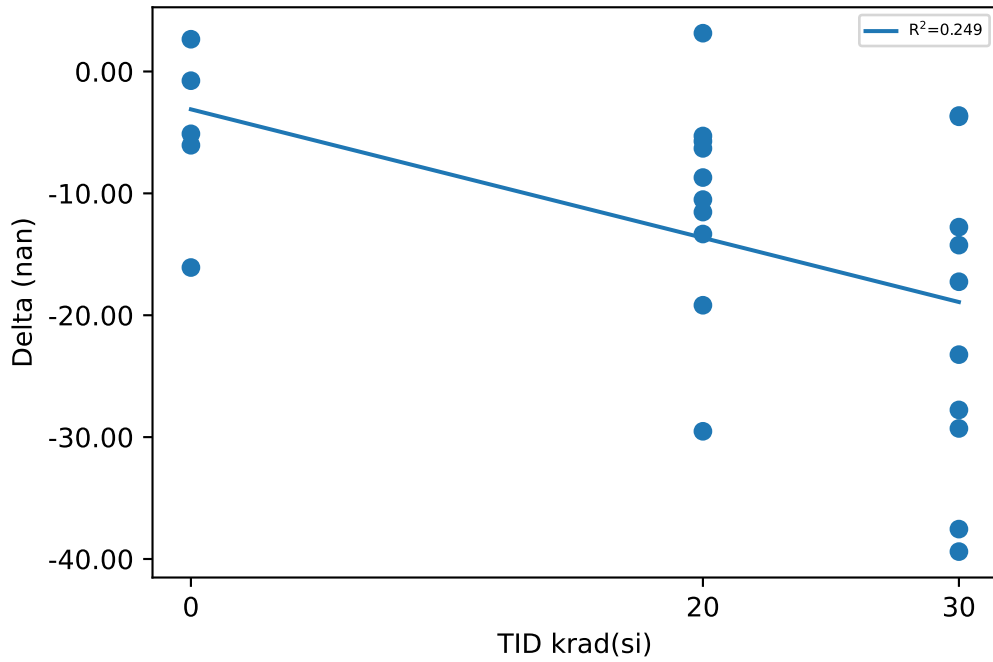

Test Statistics (nan)

krad(si)	Pre Exposure Min	Pre Exposure Avg	Pre Exposure Max	Pre Exposure Std	Post Exposure Min	Post Exposure Avg	Post Exposure Max	Post Exposure Std	Min Delta	Avg Delta	Max Delta	Std Delta
0	277.52	282.48	286.88	3.6145	266.54	277.41	283.95	6.7754	-16.085	-5.0722	2.647	7.0794
20	275.18	280.83	289.02	4.9844	259.5	270.14	280.14	7.3006	-29.522	-10.696	3.142	8.8368
30	272.37	276.54	281.21	2.9823	239.14	255.66	273.77	12.946	-39.393	-20.883	-3.614	12.736

Device Test: 10.32 UJXOZU(Kcs_25mA_CH2_UJXOZU)

TID vs Result Stats

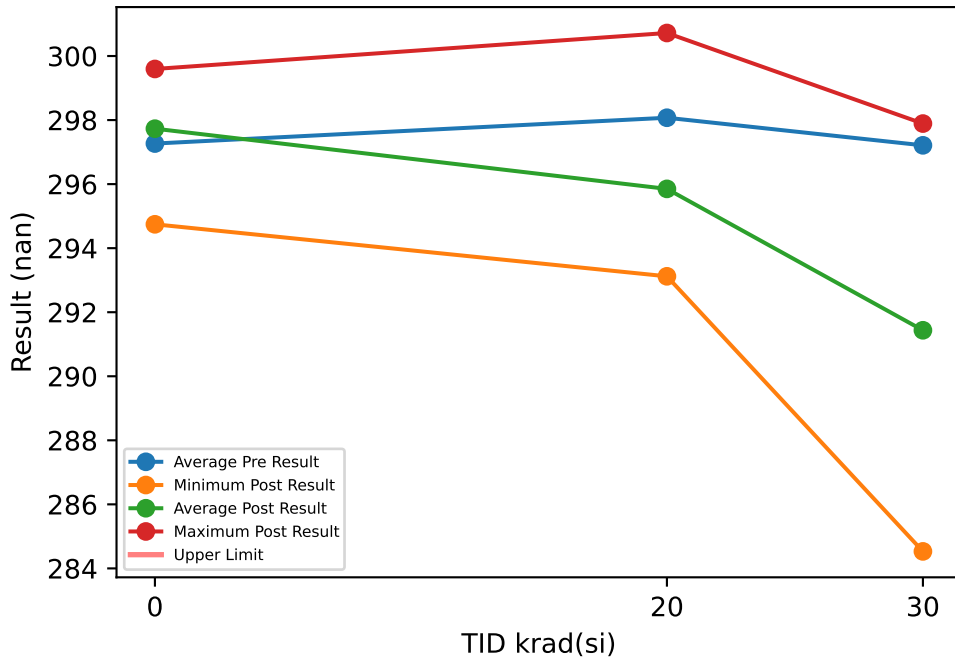

Test Results (No Limits Specified (nan))

Serial #	krad(si)	Exposure Conditions	Pre Result	Post Result	Delta
50	20	LDR biased	297.38	293.12	-4.26
51	20	LDR biased	298.17	294.67	-3.505
52	20	LDR biased	298.25	293.98	-4.274
53	20	LDR biased	300.21	295.08	-5.128
54	20	LDR biased	296.04	295.08	-0.957
55	30	LDR biased	298.89	286.18	-12.718
56	30	LDR biased	297.17	288.83	-8.345
57	30	LDR biased	296.88	289.97	-6.911
58	30	LDR biased	295.45	284.53	-10.919
59	30	LDR biased	299.88	287.59	-12.284
60	20	LDR unbiased	296.9	296.26	-0.635
61	20	LDR unbiased	299.7	298.89	-0.811
62	20	LDR unbiased	300.65	300.72	0.071
63	20	LDR unbiased	298.35	296.84	-1.512
64	20	LDR unbiased	295.07	293.87	-1.202
65	30	LDR unbiased	296.74	295.14	-1.598
66	30	LDR unbiased	295.2	292.03	-3.167
67	30	LDR unbiased	298.34	297.89	-0.453
68	30	LDR unbiased	296.07	295.83	-0.247
69	30	LDR unbiased	297.49	296.38	-1.114
70	0	correlation	297.59	294.75	-2.848
71	0	correlation	296.99	299.6	2.605
72	0	correlation	299.33	299.11	-0.217
73	0	correlation	297.52	298.34	0.819
74	0	correlation	294.9	296.86	1.962

TID vs Post - Pre Exposure Delta

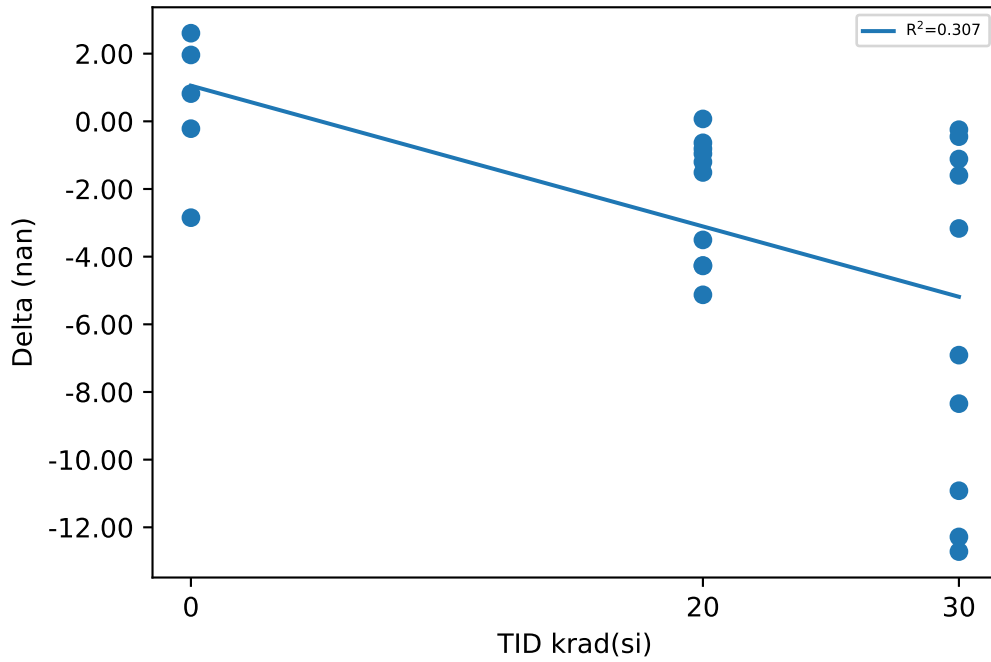

Test Statistics (nan)

krad(si)	Pre Exposure Min	Pre Exposure Avg	Pre Exposure Max	Pre Exposure Std	Post Exposure Min	Post Exposure Avg	Post Exposure Max	Post Exposure Std	Min Delta	Avg Delta	Max Delta	Std Delta
0	294.9	297.27	299.33	1.5879	294.75	297.73	299.6	1.9634	-2.848	0.4642	2.605	2.144
20	295.07	298.07	300.65	1.794	293.12	295.85	300.72	2.3939	-5.128	-2.2213	0.071	1.8669
30	295.2	297.21	299.88	1.494	284.53	291.44	297.89	4.6965	-12.718	-5.7756	-0.247	5.0529

Device Test: 10.33 UJXOZU(Kcs_50mA_CH2_UJXOZU)

TID vs Result Stats

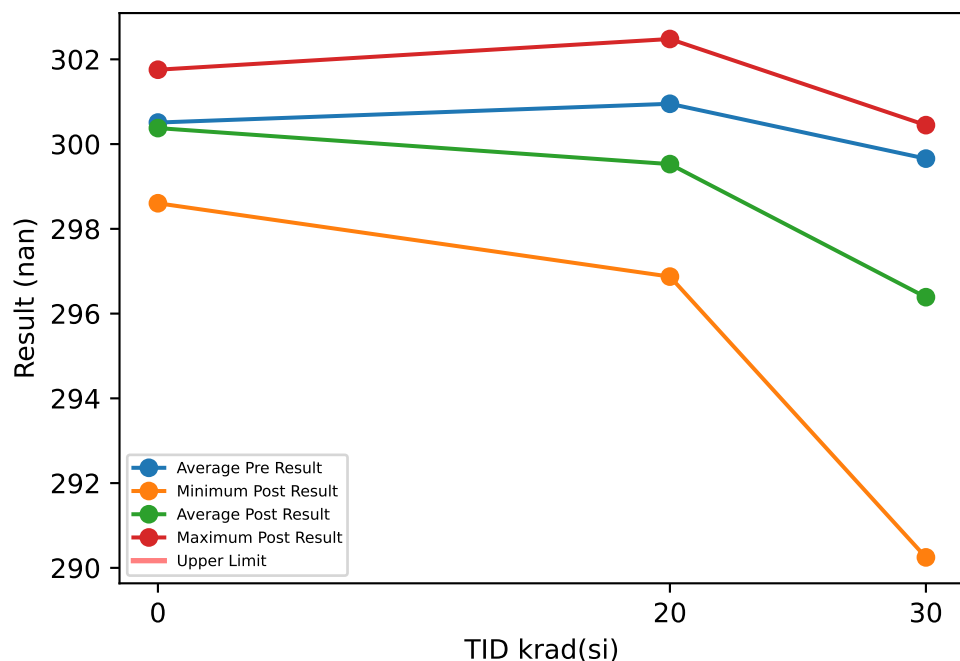

Test Results (No Limits Specified (nan))

Serial #	krad(si)	Exposure Conditions	Pre Result	Post Result	Delta
50	20	LDR biased	300.51	299.45	-1.06
51	20	LDR biased	301.19	300.51	-0.679
52	20	LDR biased	300.25	298.89	-1.353
53	20	LDR biased	301.67	298	-3.661
54	20	LDR biased	300.17	298.15	-2.017
55	30	LDR biased	300.72	292.13	-8.593
56	30	LDR biased	301.12	294.05	-7.064
57	30	LDR biased	299.4	295.49	-3.918
58	30	LDR biased	297.94	290.25	-7.693
59	30	LDR biased	300.81	295.63	-5.173
60	20	LDR unbiased	301.44	299.32	-2.12
61	20	LDR unbiased	302.85	301.35	-1.499
62	20	LDR unbiased	301.36	302.48	1.118
63	20	LDR unbiased	300.78	300.24	-0.54
64	20	LDR unbiased	299.3	296.87	-2.422
65	30	LDR unbiased	299.68	299.41	-0.268
66	30	LDR unbiased	298.16	297.1	-1.067
67	30	LDR unbiased	300.54	300.45	-0.089
68	30	LDR unbiased	299.55	299.85	0.301
69	30	LDR unbiased	298.65	299.52	0.865
70	0	correlation	299.42	298.6	-0.818
71	0	correlation	300.83	300.96	0.132
72	0	correlation	302.34	301.75	-0.586
73	0	correlation	300.64	300.39	-0.245
74	0	correlation	299.31	300.17	0.864

TID vs Post - Pre Exposure Delta

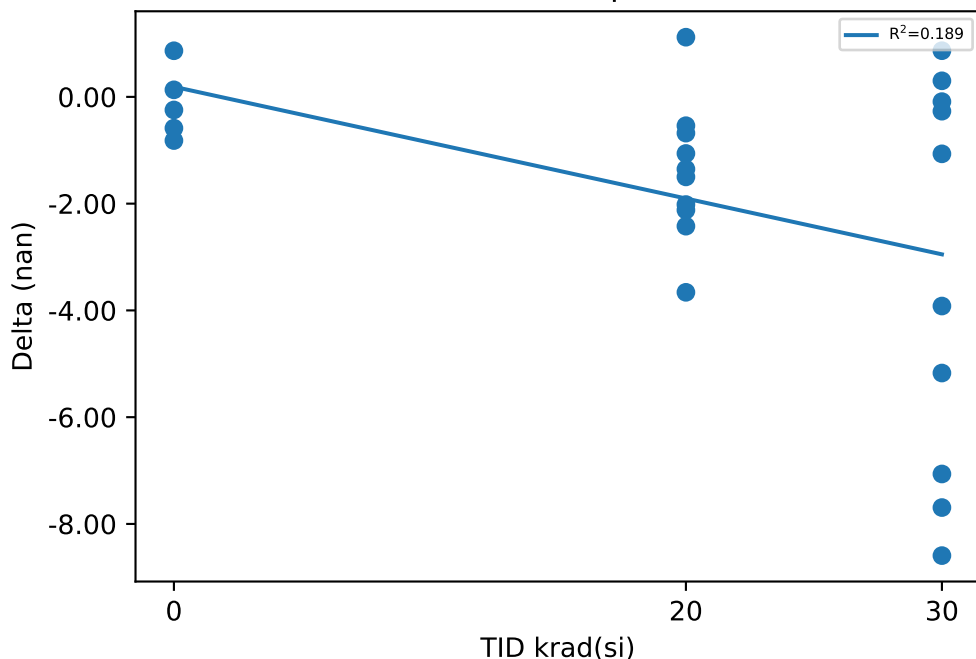

Test Statistics (nan)

krad(si)	Pre Exposure Min	Pre Exposure Avg	Pre Exposure Max	Pre Exposure Std	Post Exposure Min	Post Exposure Avg	Post Exposure Max	Post Exposure Std	Min Delta	Avg Delta	Max Delta	Std Delta
0	299.31	300.51	302.34	1.235	298.6	300.38	301.75	1.1649	-0.818	-0.1306	0.864	0.66166
20	299.3	300.95	302.85	0.98009	296.87	299.53	302.48	1.674	-3.661	-1.4233	1.118	1.2814
30	297.94	299.66	301.12	1.1367	290.25	296.39	300.45	3.5049	-8.593	-3.2699	0.865	3.654

Device Test: 10.34 UJXOZU(Kcs_100mA_CH2_UJXOZU)

TID vs Result Stats

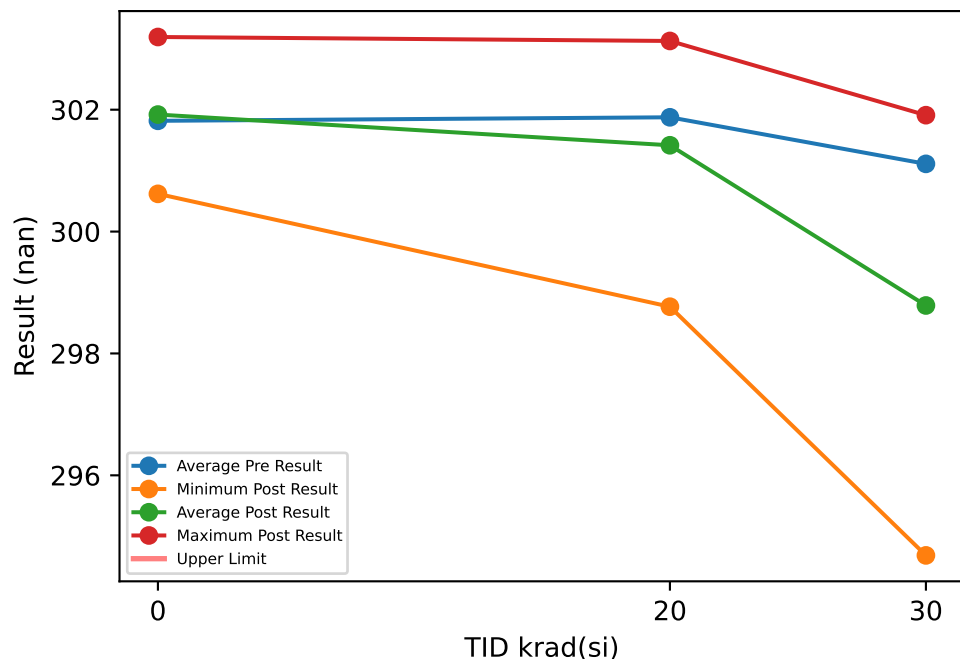

Test Results (No Limits Specified (nan))

Serial #	krad(si)	Exposure Conditions	Pre Result	Post Result	Delta
50	20	LDR biased	301.85	300.79	-1.062
51	20	LDR biased	302.84	303.13	0.289
52	20	LDR biased	300.84	299.28	-1.558
53	20	LDR biased	302.03	300.56	-1.468
54	20	LDR biased	301.56	301.49	-0.064
55	30	LDR biased	302.5	296.43	-6.07
56	30	LDR biased	302.7	296.79	-5.915
57	30	LDR biased	302.01	297.13	-4.881
58	30	LDR biased	299.79	294.69	-5.103
59	30	LDR biased	302.12	298.51	-3.605
60	20	LDR unbiased	302.43	301.98	-0.446
61	20	LDR unbiased	303.16	302.95	-0.206
62	20	LDR unbiased	302.34	303.02	0.681
63	20	LDR unbiased	301.87	302.19	0.321
64	20	LDR unbiased	299.85	298.77	-1.078
65	30	LDR unbiased	300.11	301.19	1.083
66	30	LDR unbiased	299.78	299.3	-0.484
67	30	LDR unbiased	301.82	301.91	0.087
68	30	LDR unbiased	300.19	301.09	0.904
69	30	LDR unbiased	300.09	300.84	0.745
70	0	correlation	300.4	300.62	0.223
71	0	correlation	301.89	302.34	0.448
72	0	correlation	303.33	303.19	-0.142
73	0	correlation	302.29	302.56	0.276
74	0	correlation	301.18	300.88	-0.292

TID vs Post - Pre Exposure Delta

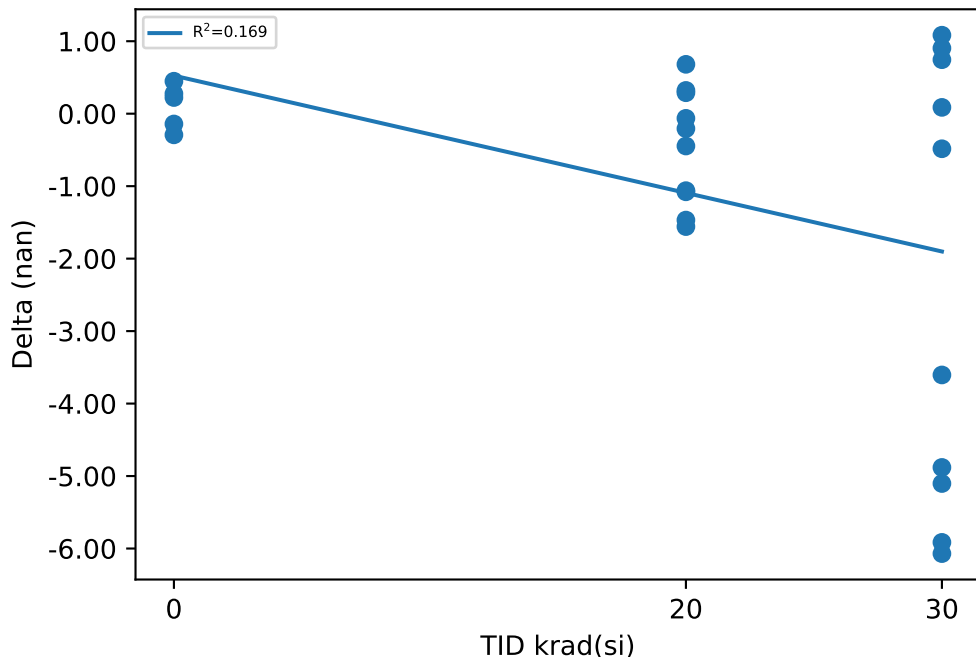

Test Statistics (nan)

krad(si)	Pre Exposure Min	Pre Exposure Avg	Pre Exposure Max	Pre Exposure Std	Post Exposure Min	Post Exposure Avg	Post Exposure Max	Post Exposure Std	Min Delta	Avg Delta	Max Delta	Std Delta
0	300.4	301.82	303.33	1.1134	300.62	301.92	303.19	1.1151	-0.292	0.1026	0.448	0.30798
20	299.85	301.88	303.16	0.96708	298.77	301.42	303.13	1.5451	-1.558	-0.4591	0.681	0.79305
30	299.78	301.11	302.7	1.2113	294.69	298.79	301.91	2.4608	-6.07	-2.3239	1.083	3.0455

Device Test: 10.35 UJXOZU(Kcs_250mA_CH2_UJXOZU)

TID vs Result Stats

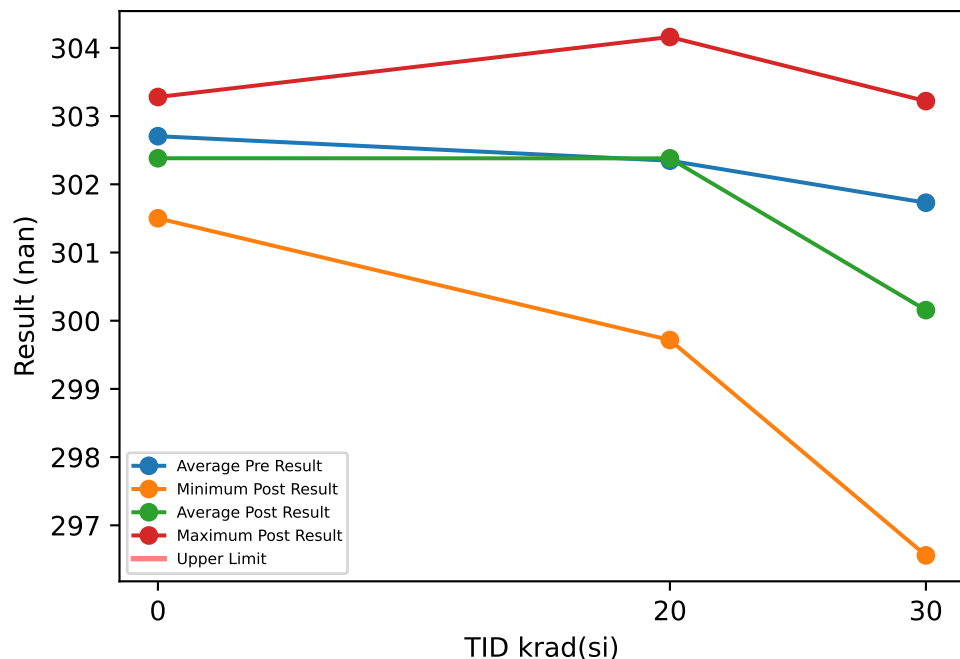

Test Results (No Limits Specified (nan))

Serial #	krad(si)	Exposure Conditions	Pre Result	Post Result	Delta
50	20	LDR biased	302.81	302.7	-0.105
51	20	LDR biased	303.21	303.69	0.481
52	20	LDR biased	301.16	300.55	-0.614
53	20	LDR biased	302.26	301.96	-0.304
54	20	LDR biased	302.18	302.35	0.175
55	30	LDR biased	302.59	297.12	-5.471
56	30	LDR biased	303.17	297.61	-5.558
57	30	LDR biased	302.66	299.79	-2.864
58	30	LDR biased	300.47	296.56	-3.907
59	30	LDR biased	302.73	300.16	-2.566
60	20	LDR unbiased	303	302.89	-0.105
61	20	LDR unbiased	303.25	303.16	-0.093
62	20	LDR unbiased	302.71	304.16	1.445
63	20	LDR unbiased	302.35	302.63	0.279
64	20	LDR unbiased	300.54	299.72	-0.819
65	30	LDR unbiased	301.03	302.74	1.709
66	30	LDR unbiased	299.73	300.38	0.65
67	30	LDR unbiased	302.79	303.22	0.429
68	30	LDR unbiased	301.37	301.94	0.57
69	30	LDR unbiased	300.76	302.02	1.259
70	0	correlation	301.89	301.5	-0.391
71	0	correlation	302.67	302.48	-0.189
72	0	correlation	303.78	303.28	-0.501
73	0	correlation	303.19	302.75	-0.44
74	0	correlation	302	301.9	-0.095

TID vs Post - Pre Exposure Delta

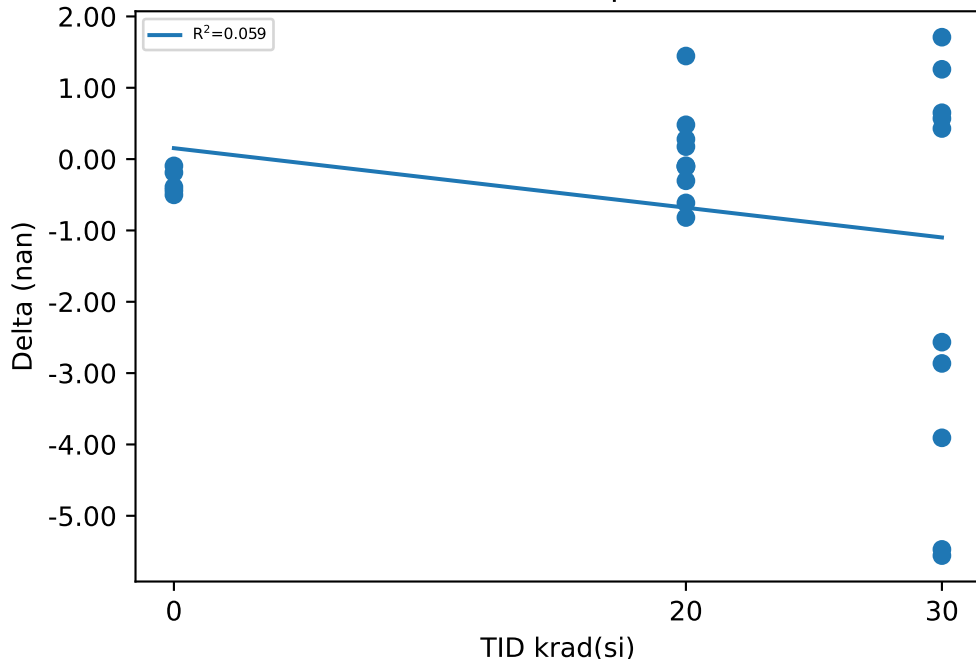

Test Statistics (nan)

krad(si)	Pre Exposure Min	Pre Exposure Avg	Pre Exposure Max	Pre Exposure Std	Post Exposure Min	Post Exposure Avg	Post Exposure Max	Post Exposure Std	Min Delta	Avg Delta	Max Delta	Std Delta
0	301.89	302.71	303.78	0.79837	301.5	302.38	303.28	0.69867	-0.501	-0.3232	-0.095	0.17316
20	300.54	302.35	303.25	0.8849	299.72	302.38	304.16	1.3556	-0.819	0.034	1.445	0.63133
30	299.73	301.73	303.17	1.1987	296.56	300.16	303.22	2.3931	-5.558	-1.5749	1.709	2.8188

Device Test: 10.36 UJXOZU(Kcs_500mA_CH2_UJXOZU)

TID vs Result Stats

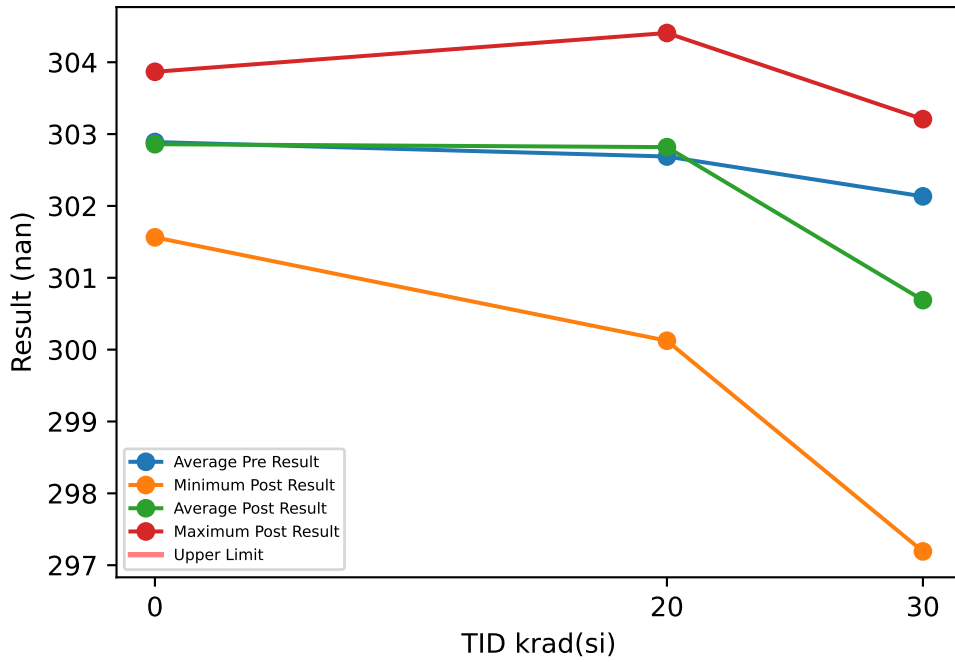

Test Results (No Limits Specified (nan))

Serial #	krad(si)	Exposure Conditions	Pre Result	Post Result	Delta
50	20	LDR biased	302.62	302.67	0.049
51	20	LDR biased	303.2	304.41	1.21
52	20	LDR biased	301.41	301.41	0.002
53	20	LDR biased	303.29	302.74	-0.547
54	20	LDR biased	302.45	302.37	-0.083
55	30	LDR biased	303.25	298.68	-4.573
56	30	LDR biased	303.46	299.13	-4.325
57	30	LDR biased	303.12	300.48	-2.643
58	30	LDR biased	301.11	297.19	-3.92
59	30	LDR biased	302.68	299.95	-2.724
60	20	LDR unbiased	303.31	303.37	0.05
61	20	LDR unbiased	303.77	303.81	0.04
62	20	LDR unbiased	302.78	304.04	1.255
63	20	LDR unbiased	303.09	303.26	0.172
64	20	LDR unbiased	300.96	300.12	-0.839
65	30	LDR unbiased	301.31	302.75	1.438
66	30	LDR unbiased	300.85	301.14	0.293
67	30	LDR unbiased	303.28	303.21	-0.071
68	30	LDR unbiased	301.36	302.43	1.073
69	30	LDR unbiased	300.91	301.92	1.007
70	0	correlation	301.72	301.56	-0.161
71	0	correlation	303.09	303.15	0.061
72	0	correlation	304.13	303.87	-0.262
73	0	correlation	303.18	303.09	-0.089
74	0	correlation	302.33	302.62	0.298

TID vs Post - Pre Exposure Delta

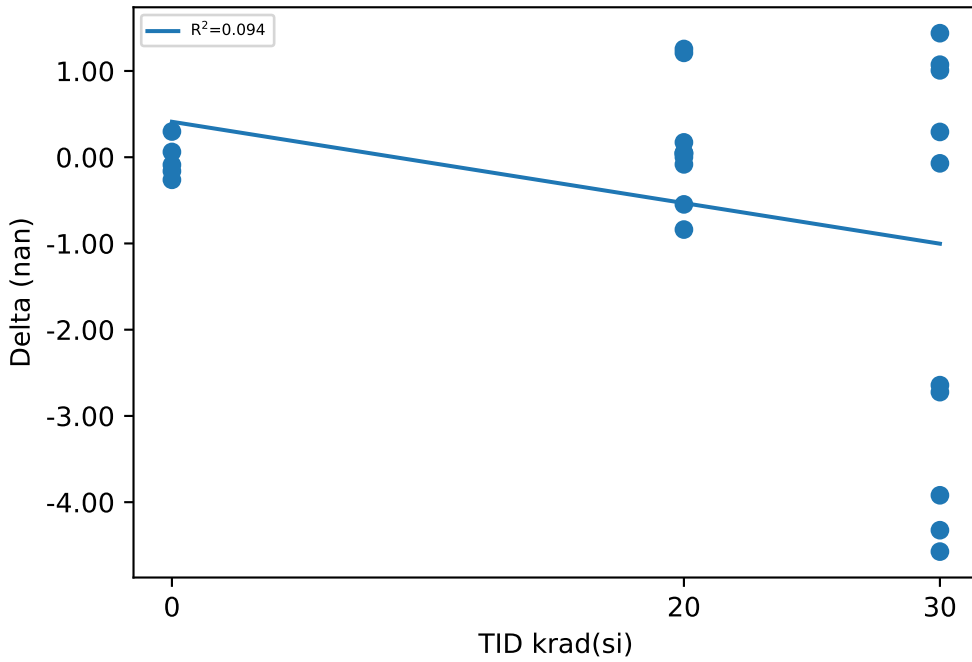

Test Statistics (nan)

krad(si)	Pre Exposure Min	Pre Exposure Avg	Pre Exposure Max	Pre Exposure Std	Post Exposure Min	Post Exposure Avg	Post Exposure Max	Post Exposure Std	Min Delta	Avg Delta	Max Delta	Std Delta
0	301.72	302.89	304.13	0.91322	301.56	302.86	303.87	0.84979	-0.262	-0.0306	0.298	0.21813
20	300.96	302.69	303.77	0.88212	300.12	302.82	304.41	1.2882	-0.839	0.1309	1.255	0.65945
30	300.85	302.13	303.46	1.109	297.19	300.69	303.21	1.961	-4.573	-1.4445	1.438	2.4232

Device Test: 10.37 UJXOZU(Kcs_5mA_CH3_UJXOZU)

TID vs Result Stats

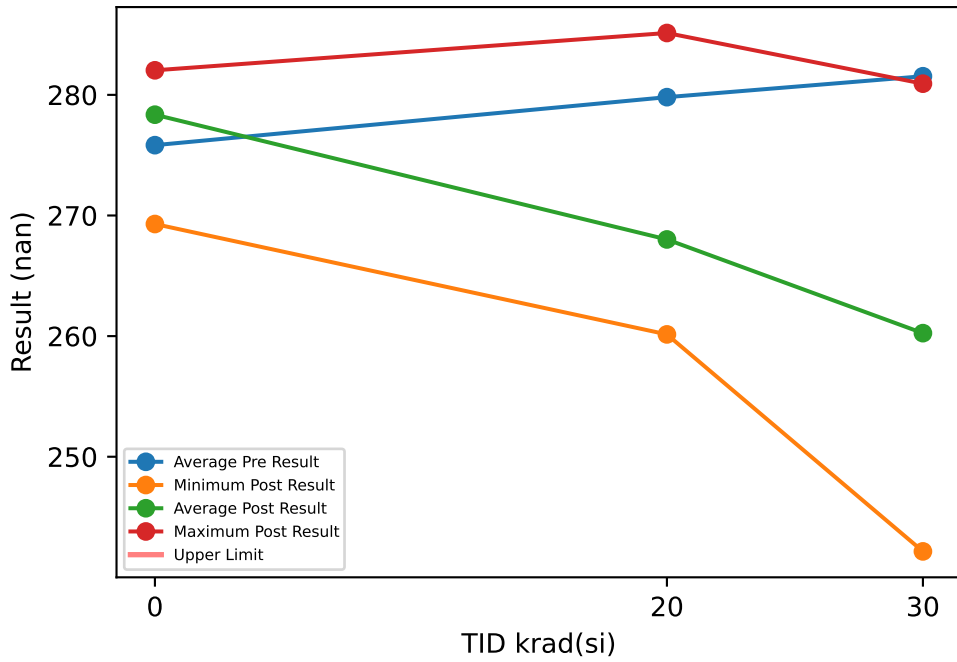

Test Results (No Limits Specified (nan))

Serial #	krad(si)	Exposure Conditions	Pre Result	Post Result	Delta
50	20	LDR biased	278.29	264.5	-13.788
51	20	LDR biased	286.43	260.51	-25.916
52	20	LDR biased	283.95	262.39	-21.561
53	20	LDR biased	280.08	260.14	-19.934
54	20	LDR biased	274.64	261.57	-13.075
55	30	LDR biased	282.71	247.42	-35.288
56	30	LDR biased	281.12	247.29	-33.828
57	30	LDR biased	277.97	242.15	-35.82
58	30	LDR biased	277.74	245	-32.738
59	30	LDR biased	282.17	253.46	-28.712
60	20	LDR unbiased	275.41	270.17	-5.235
61	20	LDR unbiased	286.34	270.51	-15.832
62	20	LDR unbiased	281.28	285.13	3.851
63	20	LDR unbiased	271.52	268.99	-2.53
64	20	LDR unbiased	280.16	276.23	-3.935
65	30	LDR unbiased	284.83	277.2	-7.631
66	30	LDR unbiased	276.42	269.85	-6.569
67	30	LDR unbiased	287.08	272.19	-14.883
68	30	LDR unbiased	283.14	266.97	-16.172
69	30	LDR unbiased	282.26	280.93	-1.333
70	0	correlation	275.94	280.74	4.8
71	0	correlation	280.09	282.04	1.943
72	0	correlation	274.12	278.39	4.27
73	0	correlation	276.52	281.32	4.802
74	0	correlation	272.47	269.29	-3.181

TID vs Post - Pre Exposure Delta

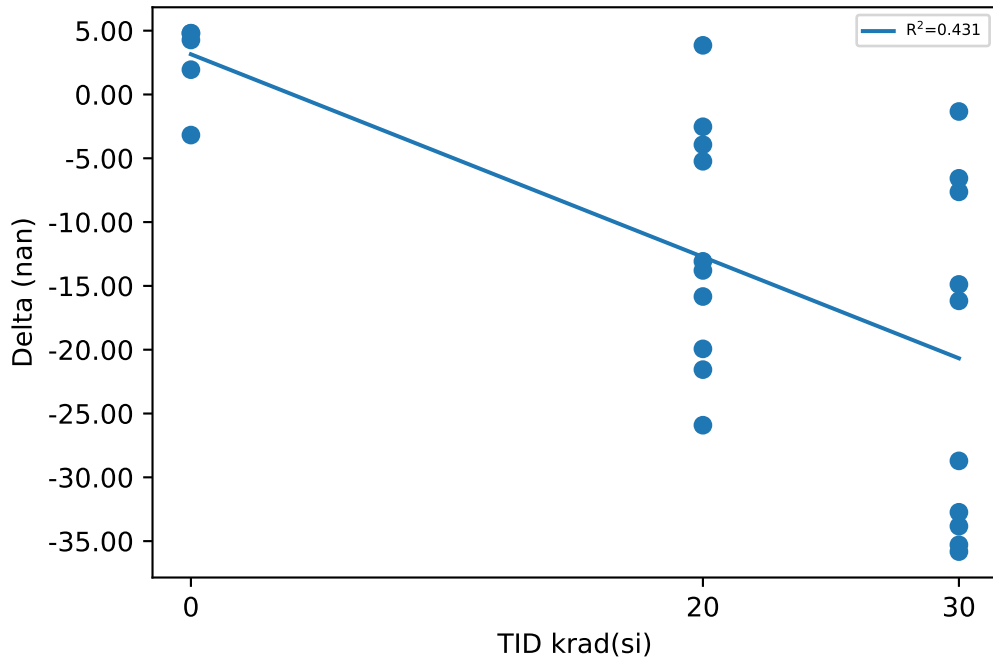

Test Statistics (nan)

krad(si)	Pre Exposure Min	Pre Exposure Avg	Pre Exposure Max	Pre Exposure Std	Post Exposure Min	Post Exposure Avg	Post Exposure Max	Post Exposure Std	Min Delta	Avg Delta	Max Delta	Std Delta
0	272.47	275.83	280.09	2.8655	269.29	278.36	282.04	5.2483	-3.181	2.5268	4.802	3.4023
20	271.52	279.81	286.43	4.9778	260.14	268.01	285.13	7.9995	-25.916	-11.795	3.851	9.5358
30	276.42	281.54	287.08	3.3312	242.15	260.25	280.93	14.657	-35.82	-21.297	-1.333	13.413

Device Test: 10.38 UJXOZU(Kcs_25mA_CH3_UJXOZU)

TID vs Result Stats

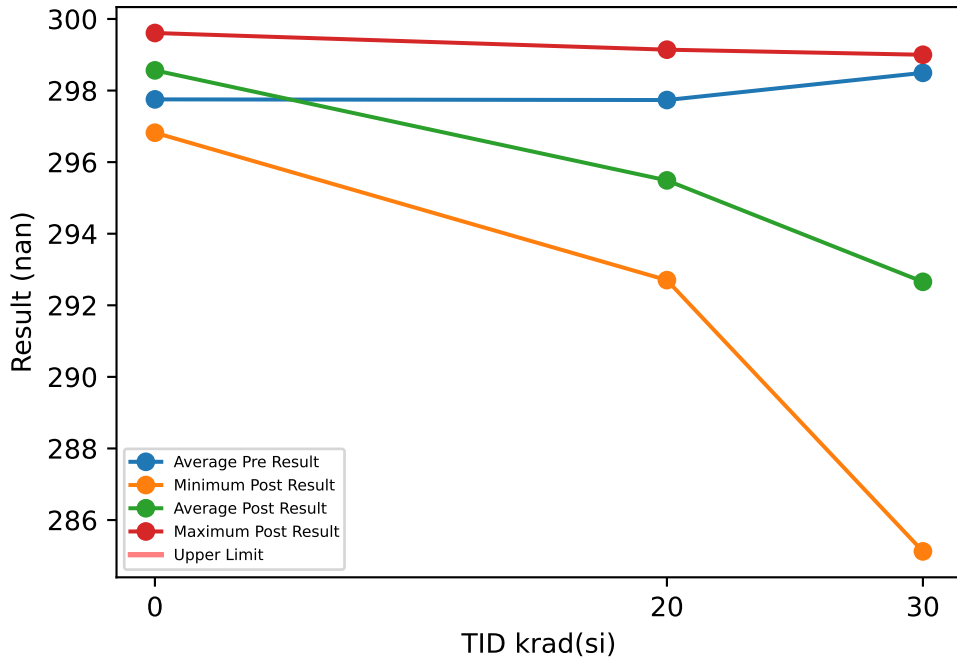

TID vs Post - Pre Exposure Delta

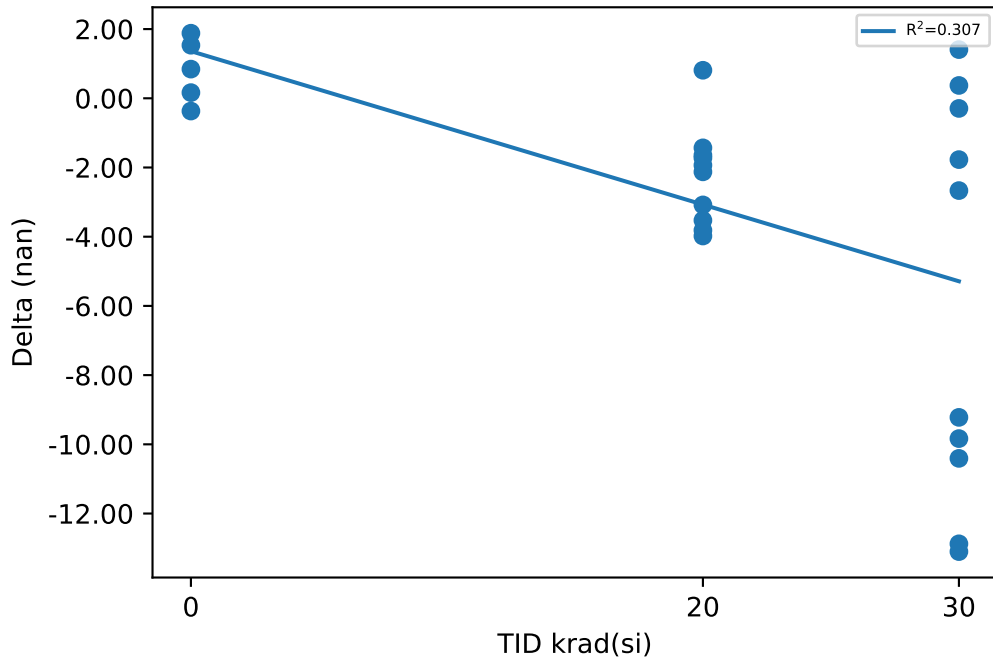

Test Results (No Limits Specified (nan))

Serial #	krad(si)	Exposure Conditions	Pre Result	Post Result	Delta
50	20	LDR biased	296.68	292.7	-3.98
51	20	LDR biased	299.6	297.96	-1.646
52	20	LDR biased	299.09	295.28	-3.814
53	20	LDR biased	297.26	293.74	-3.527
54	20	LDR biased	298.02	295.9	-2.126
55	30	LDR biased	298.22	285.12	-13.1
56	30	LDR biased	299.02	286.15	-12.875
57	30	LDR biased	298.59	288.76	-9.834
58	30	LDR biased	298.93	289.71	-9.221
59	30	LDR biased	299.81	289.4	-10.406
60	20	LDR unbiased	295.76	294.33	-1.432
61	20	LDR unbiased	297.86	294.77	-3.081
62	20	LDR unbiased	298.33	299.14	0.81
63	20	LDR unbiased	299.47	297.75	-1.724
64	20	LDR unbiased	295.26	293.33	-1.935
65	30	LDR unbiased	298.63	299	0.371
66	30	LDR unbiased	297.89	296.12	-1.772
67	30	LDR unbiased	295.98	297.38	1.407
68	30	LDR unbiased	299.83	297.17	-2.667
69	30	LDR unbiased	298.05	297.76	-0.293
70	0	correlation	297.2	298.73	1.533
71	0	correlation	297.05	298.93	1.881
72	0	correlation	298.76	299.61	0.843
73	0	correlation	299.1	298.73	-0.369
74	0	correlation	296.66	296.82	0.164

Test Statistics (nan)

krad(si)	Pre Exposure Min	Pre Exposure Avg	Pre Exposure Max	Pre Exposure Std	Post Exposure Min	Post Exposure Avg	Post Exposure Max	Post Exposure Std	Min Delta	Avg Delta	Max Delta	Std Delta
0	296.66	297.75	299.1	1.1002	296.82	298.56	299.61	1.0383	-0.369	0.8104	1.881	0.9325
20	295.26	297.74	299.6	1.4952	292.7	295.49	299.14	2.1625	-3.98	-2.2455	0.81	1.4356
30	295.98	298.49	299.83	1.1054	285.12	292.66	299	5.3175	-13.1	-5.839	1.407	5.763

Device Test: 10.39 UJXOZU(Kcs_50mA_CH3_UJXOZU)

TID vs Result Stats

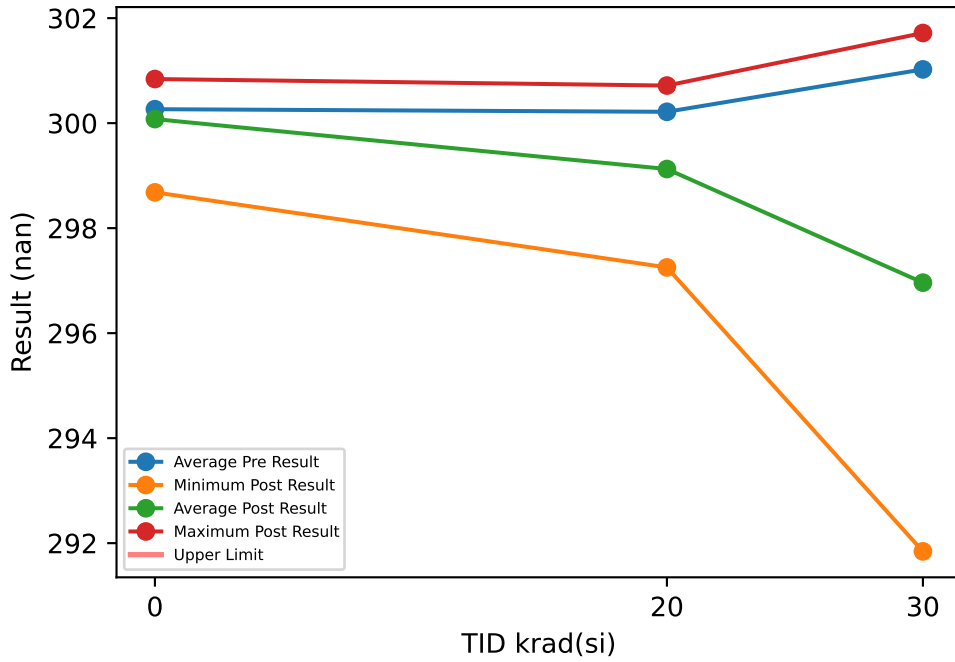

Test Results (No Limits Specified (nan))

Serial #	krad(si)	Exposure Conditions	Pre Result	Post Result	Delta
50	20	LDR biased	300.13	297.69	-2.44
51	20	LDR biased	301.56	300.33	-1.232
52	20	LDR biased	301.62	300.34	-1.274
53	20	LDR biased	300.61	299.21	-1.395
54	20	LDR biased	300.23	299.56	-0.667
55	30	LDR biased	301.51	294.25	-7.257
56	30	LDR biased	301.3	291.84	-9.457
57	30	LDR biased	299.95	293.87	-6.075
58	30	LDR biased	301.51	294.7	-6.809
59	30	LDR biased	302.03	294.38	-7.648
60	20	LDR unbiased	298.67	298.15	-0.518
61	20	LDR unbiased	298.68	297.98	-0.695
62	20	LDR unbiased	301.2	300.72	-0.481
63	20	LDR unbiased	300	300.03	0.023
64	20	LDR unbiased	299.47	297.25	-2.222
65	30	LDR unbiased	300.62	301.72	1.095
66	30	LDR unbiased	301.29	299.01	-2.278
67	30	LDR unbiased	299.58	298.09	-1.487
68	30	LDR unbiased	301.64	300.54	-1.106
69	30	LDR unbiased	300.8	301.21	0.403
70	0	correlation	300.02	300.27	0.251
71	0	correlation	300.27	300.03	-0.234
72	0	correlation	300.76	300.56	-0.204
73	0	correlation	300.4	300.84	0.441
74	0	correlation	299.88	298.68	-1.196

TID vs Post - Pre Exposure Delta

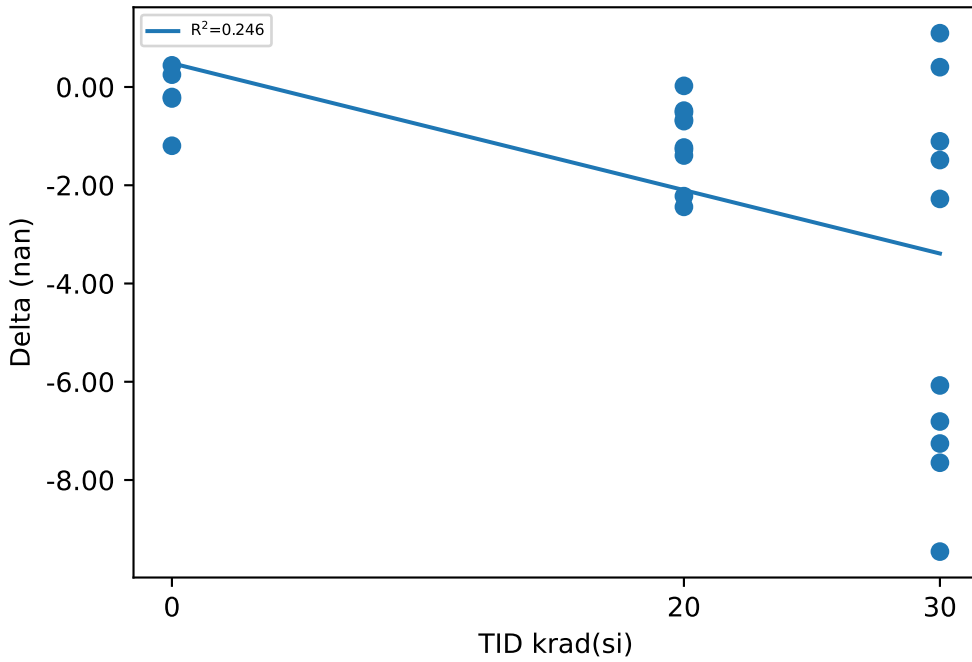

Test Statistics (nan)

krad(si)	Pre Exposure Min	Pre Exposure Avg	Pre Exposure Max	Pre Exposure Std	Post Exposure Min	Post Exposure Avg	Post Exposure Max	Post Exposure Std	Min Delta	Avg Delta	Max Delta	Std Delta
0	299.88	300.27	300.76	0.34345	298.68	300.08	300.84	0.83663	-1.196	-0.1884	0.441	0.6338
20	298.67	300.22	301.62	1.0676	297.25	299.13	300.72	1.2611	-2.44	-1.0901	0.023	0.78335
30	299.58	301.02	302.03	0.77913	291.84	296.96	301.72	3.5546	-9.457	-4.0619	1.095	3.7838

Device Test: 10.4 UJ74P3(dCSR_100mA_CH1_UJ74P3)

TID vs Result Stats

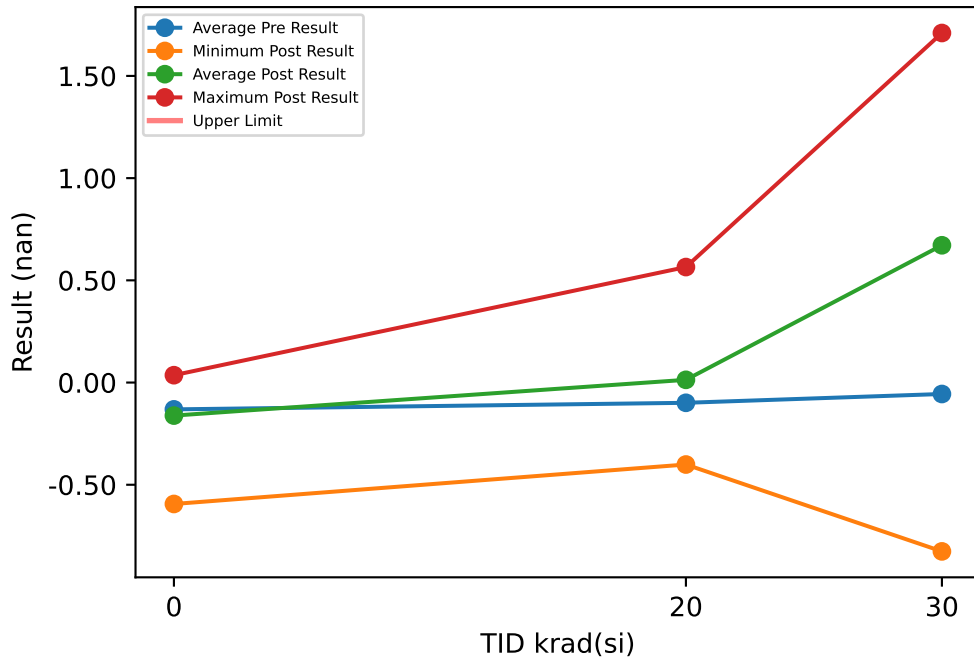

Test Results (No Limits Specified (nan))

Serial #	krad(si)	Exposure Conditions	Pre Result	Post Result	Delta
50	20	LDR biased	-0.082	0.022	0.104
51	20	LDR biased	-0.156	-0.055	0.101
52	20	LDR biased	0.002	0.565	0.563
53	20	LDR biased	-0.194	0.26	0.454
54	20	LDR biased	-0.025	0.23	0.255
55	30	LDR biased	-0.145	1.556	1.701
56	30	LDR biased	-0.195	1.71	1.905
57	30	LDR biased	-0.184	1.024	1.208
58	30	LDR biased	-0.27	1.658	1.928
59	30	LDR biased	0.029	1.415	1.386
60	20	LDR unbiased	-0.115	-0.153	-0.038
61	20	LDR unbiased	-0.189	-0.251	-0.062
62	20	LDR unbiased	-0.179	-0.401	-0.222
63	20	LDR unbiased	0.037	-0.277	-0.314
64	20	LDR unbiased	-0.09	0.193	0.283
65	30	LDR unbiased	-0.391	-0.826	-0.435
66	30	LDR unbiased	-0.04	0.137	0.177
67	30	LDR unbiased	0.228	0.277	0.049
68	30	LDR unbiased	0.105	-0.185	-0.29
69	30	LDR unbiased	0.303	-0.051	-0.354
70	0	correlation	-0.373	-0.594	-0.221
71	0	correlation	-0.304	-0.214	0.09
72	0	correlation	0.076	0.036	-0.04
73	0	correlation	0.082	-0.018	-0.1
74	0	correlation	-0.137	-0.018	0.119

TID vs Post - Pre Exposure Delta

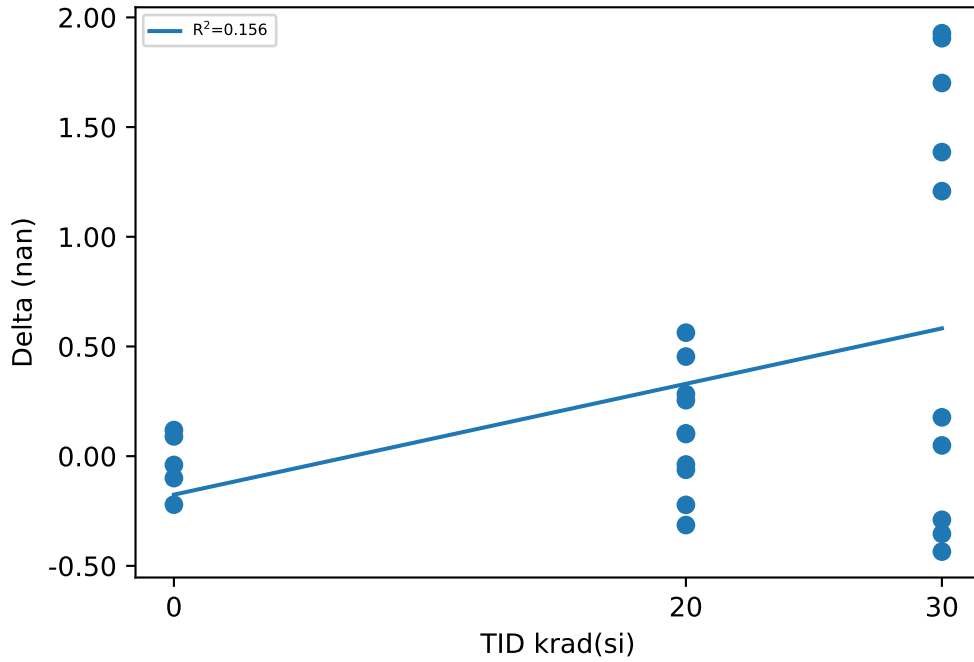

Test Statistics (nan)

krad(si)	Pre Exposure Min	Pre Exposure Avg	Pre Exposure Max	Pre Exposure Std	Post Exposure Min	Post Exposure Avg	Post Exposure Max	Post Exposure Std	Min Delta	Avg Delta	Max Delta	Std Delta
0	-0.373	-0.1312	0.082	0.21021	-0.594	-0.1616	0.036	0.25981	-0.221	-0.0304	0.119	0.13972
20	-0.194	-0.0991	0.037	0.082713	-0.401	0.0133	0.565	0.29864	-0.314	0.1124	0.563	0.28207
30	-0.391	-0.056	0.303	0.22226	-0.826	0.6715	1.71	0.90985	-0.435	0.7275	1.928	0.98656

Device Test: 10.40 UJXOZU(Kcs_100mA_CH3_UJXOZU)

TID vs Result Stats

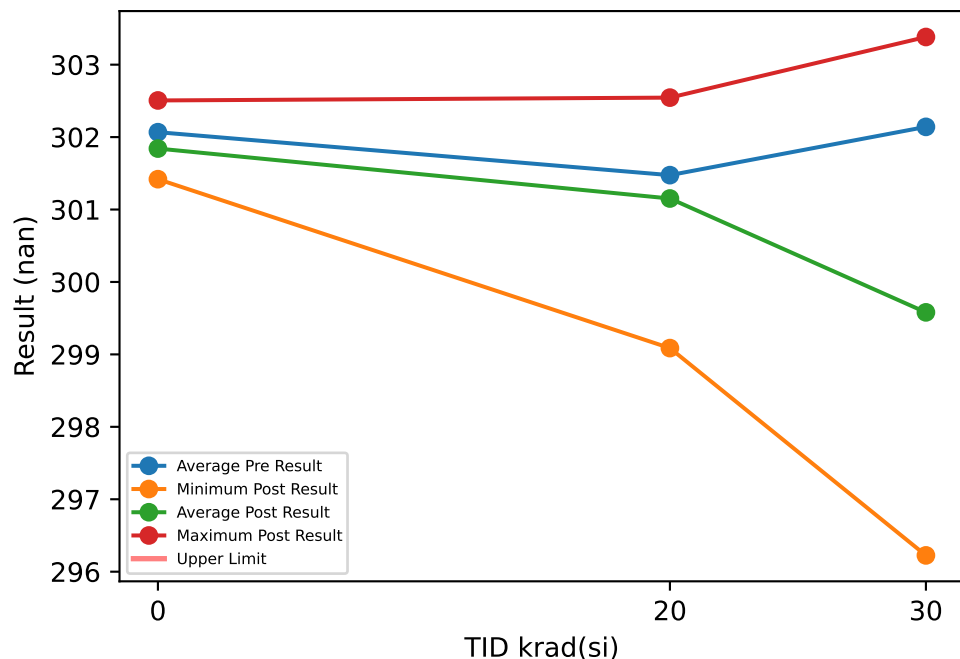

Test Results (No Limits Specified (nan))

Serial #	krad(si)	Exposure Conditions	Pre Result	Post Result	Delta
50	20	LDR biased	301.56	301.31	-0.245
51	20	LDR biased	302.36	302.41	0.055
52	20	LDR biased	303.04	301.55	-1.493
53	20	LDR biased	302.35	300.99	-1.357
54	20	LDR biased	301.72	301.57	-0.146
55	30	LDR biased	302.2	297.14	-5.058
56	30	LDR biased	302.73	296.23	-6.508
57	30	LDR biased	302.01	297.61	-4.405
58	30	LDR biased	302.2	297.51	-4.692
59	30	LDR biased	302.35	297.39	-4.959
60	20	LDR unbiased	300.27	300.01	-0.257
61	20	LDR unbiased	299.74	300.39	0.654
62	20	LDR unbiased	301.72	302.55	0.824
63	20	LDR unbiased	301.76	301.65	-0.112
64	20	LDR unbiased	300.24	299.09	-1.148
65	30	LDR unbiased	302.06	303.38	1.327
66	30	LDR unbiased	302.4	301.31	-1.088
67	30	LDR unbiased	300.61	300.24	-0.363
68	30	LDR unbiased	302.69	302.46	-0.229
69	30	LDR unbiased	302.17	302.54	0.367
70	0	correlation	301.44	301.42	-0.021
71	0	correlation	301.99	301.61	-0.376
72	0	correlation	302.92	302.51	-0.418
73	0	correlation	302.4	302.05	-0.349
74	0	correlation	301.59	301.62	0.034

TID vs Post - Pre Exposure Delta

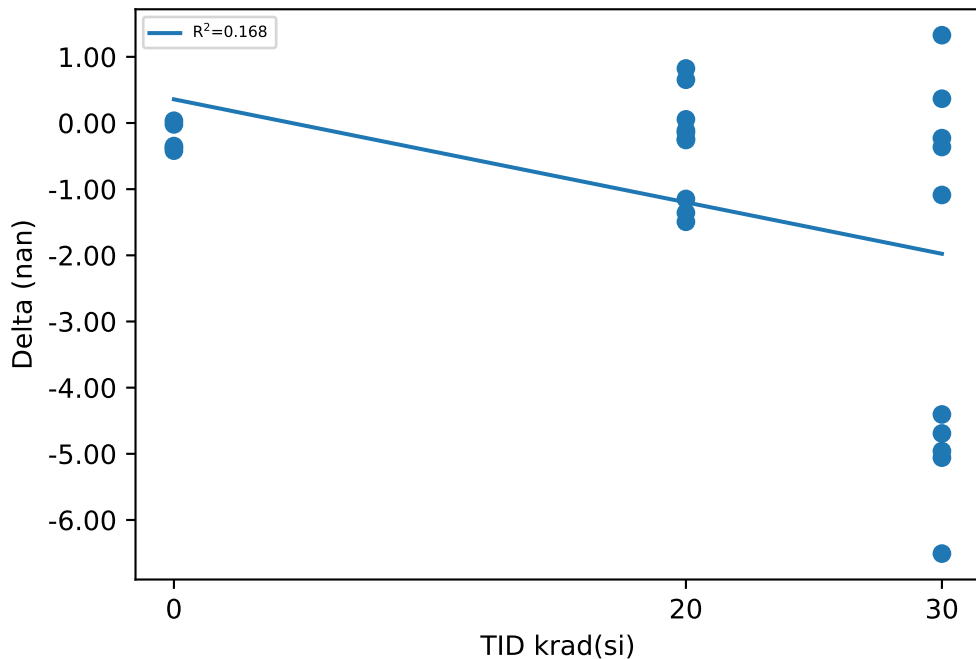

Test Statistics (nan)

krad(si)	Pre Exposure Min	Pre Exposure Avg	Pre Exposure Max	Pre Exposure Std	Post Exposure Min	Post Exposure Avg	Post Exposure Max	Post Exposure Std	Min Delta	Avg Delta	Max Delta	Std Delta
0	301.44	302.07	302.92	0.60594	301.42	301.84	302.51	0.43642	-0.418	-0.226	0.034	0.21454
20	299.74	301.47	303.04	1.0649	299.09	301.15	302.55	1.0699	-1.493	-0.3225	0.824	0.79008
30	300.61	302.14	302.73	0.59084	296.23	299.58	303.38	2.69	-6.508	-2.5608	1.327	2.8212

Device Test: 10.41 UJXOZU(Kcs_250mA_CH3_UJXOZU)

TID vs Result Stats

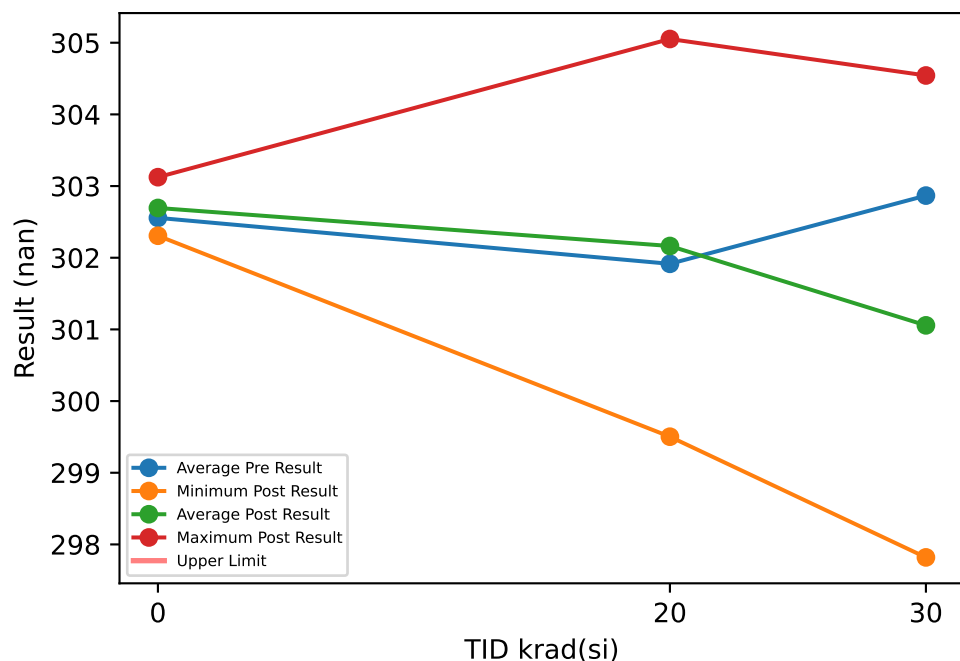

Test Results (No Limits Specified (nan))

Serial #	krad(si)	Exposure Conditions	Pre Result	Post Result	Delta
50	20	LDR biased	302.24	302.02	-0.218
51	20	LDR biased	302.9	305.05	2.151
52	20	LDR biased	303.05	302.79	-0.26
53	20	LDR biased	302.82	302.29	-0.528
54	20	LDR biased	302.35	302.46	0.104
55	30	LDR biased	303.05	298.86	-4.191
56	30	LDR biased	303.02	297.82	-5.197
57	30	LDR biased	302.76	299.9	-2.857
58	30	LDR biased	303.41	298.73	-4.682
59	30	LDR biased	303.03	299.18	-3.856
60	20	LDR unbiased	300.77	301.23	0.458
61	20	LDR unbiased	300.39	301.02	0.627
62	20	LDR unbiased	301.94	302.79	0.847
63	20	LDR unbiased	302.49	302.49	-0.002
64	20	LDR unbiased	300.19	299.5	-0.692
65	30	LDR unbiased	302.33	304.54	2.211
66	30	LDR unbiased	303.68	302.74	-0.938
67	30	LDR unbiased	301	300.99	-0.005
68	30	LDR unbiased	303.21	304.17	0.961
69	30	LDR unbiased	303.19	303.64	0.448
70	0	correlation	302.46	302.37	-0.085
71	0	correlation	302.21	302.8	0.586
72	0	correlation	303.66	302.87	-0.792
73	0	correlation	301.86	303.12	1.26
74	0	correlation	302.59	302.31	-0.279

TID vs Post - Pre Exposure Delta

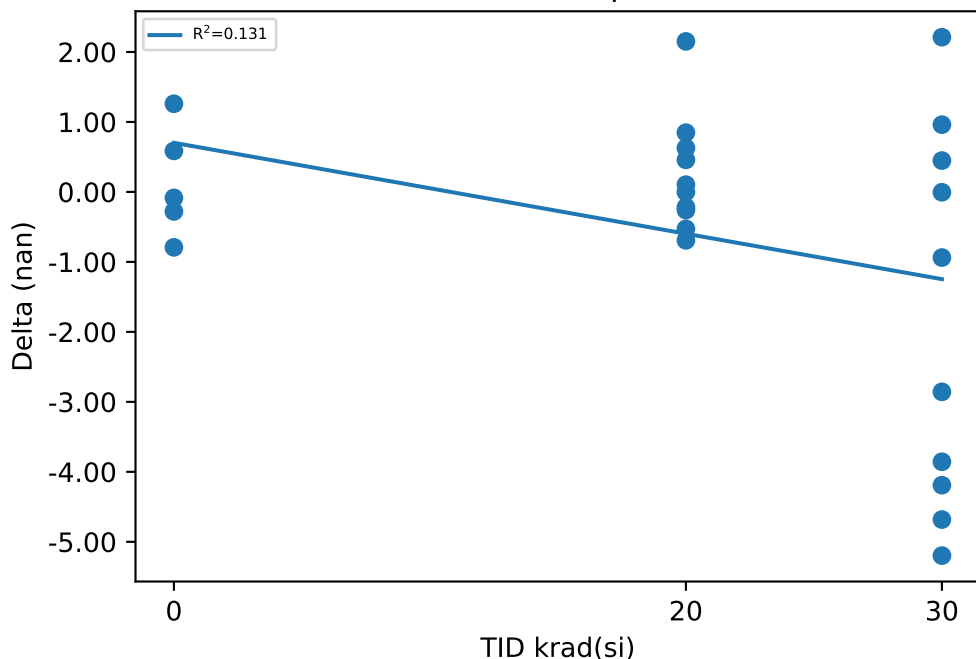

Test Statistics (nan)

krad(si)	Pre Exposure Min	Pre Exposure Avg	Pre Exposure Max	Pre Exposure Std	Post Exposure Min	Post Exposure Avg	Post Exposure Max	Post Exposure Std	Min Delta	Avg Delta	Max Delta	Std Delta
0	301.86	302.56	303.66	0.6754	302.31	302.69	303.12	0.34644	-0.792	0.138	1.26	0.79814
20	300.19	301.92	303.05	1.0697	299.5	302.16	305.05	1.4381	-0.692	0.2487	2.151	0.83081
30	301	302.87	303.68	0.74931	297.82	301.06	304.54	2.5162	-5.197	-1.8106	2.211	2.6591

Device Test: 10.42 UJXOZU(Kcs_500mA_CH3_UJXOZU)

TID vs Result Stats

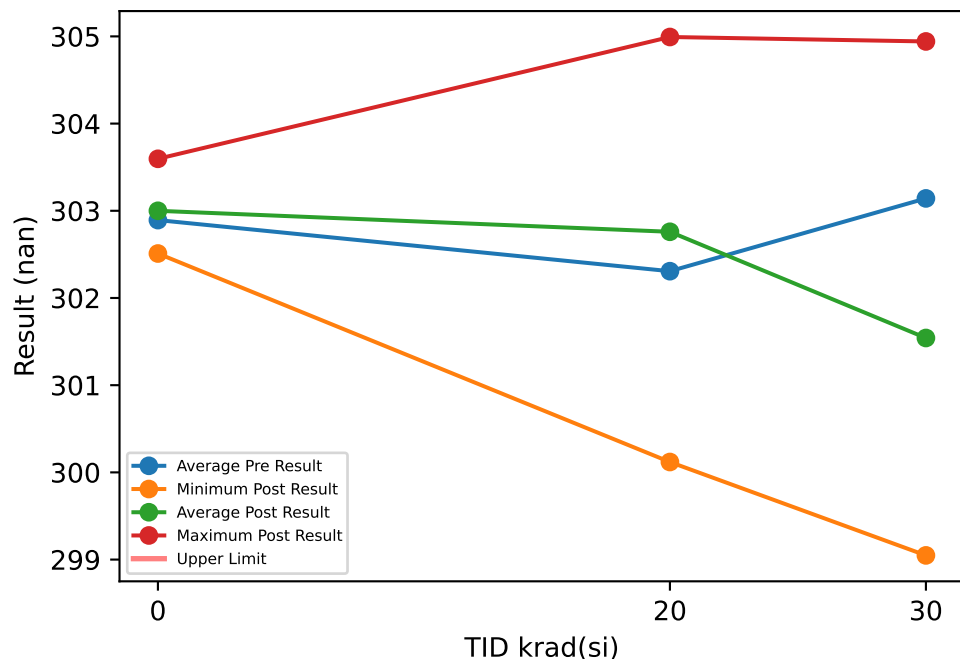

Test Results (No Limits Specified (nan))

Serial #	krad(si)	Exposure Conditions	Pre Result	Post Result	Delta
50	20	LDR biased	302.56	303.26	0.692
51	20	LDR biased	303.5	304.99	1.489
52	20	LDR biased	303.46	303.17	-0.298
53	20	LDR biased	302.83	303.37	0.545
54	20	LDR biased	302.74	303.56	0.818
55	30	LDR biased	303.27	299.05	-4.221
56	30	LDR biased	303.32	299.47	-3.852
57	30	LDR biased	303.11	299.39	-3.716
58	30	LDR biased	303.58	300.1	-3.48
59	30	LDR biased	303.62	299.94	-3.672
60	20	LDR unbiased	301.31	301.49	0.177
61	20	LDR unbiased	300.8	301.22	0.42
62	20	LDR unbiased	302.54	303.27	0.733
63	20	LDR unbiased	302.51	303.15	0.634
64	20	LDR unbiased	300.81	300.12	-0.691
65	30	LDR unbiased	302.76	304.94	2.182
66	30	LDR unbiased	303.64	303.13	-0.511
67	30	LDR unbiased	301.51	301.29	-0.218
68	30	LDR unbiased	303.39	304.24	0.849
69	30	LDR unbiased	303.22	303.85	0.632
70	0	correlation	302.66	302.58	-0.08
71	0	correlation	302.68	302.51	-0.17
72	0	correlation	303.24	303.6	0.353
73	0	correlation	302.92	303.51	0.599
74	0	correlation	302.97	302.8	-0.169

TID vs Post - Pre Exposure Delta

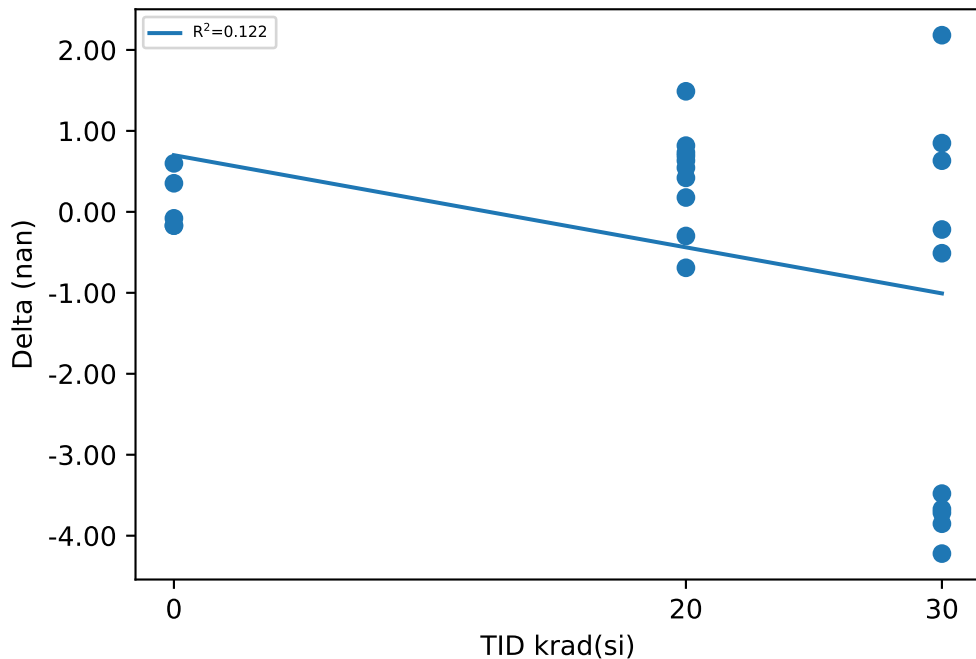

Test Statistics (nan)

krad(si)	Pre Exposure Min	Pre Exposure Avg	Pre Exposure Max	Pre Exposure Std	Post Exposure Min	Post Exposure Avg	Post Exposure Max	Post Exposure Std	Min Delta	Avg Delta	Max Delta	Std Delta
0	302.66	302.89	303.24	0.23851	302.51	303	303.6	0.51897	-0.17	0.1066	0.599	0.35016
20	300.8	302.31	303.5	0.99383	300.12	302.76	304.99	1.4055	-0.691	0.4519	1.489	0.60857
30	301.51	303.14	303.64	0.6321	299.05	301.54	304.94	2.2741	-4.221	-1.6007	2.182	2.4181

Device Test: 10.43 UJXOZU(Kcs_5mA_CH4_UJXOZU)

TID vs Result Stats

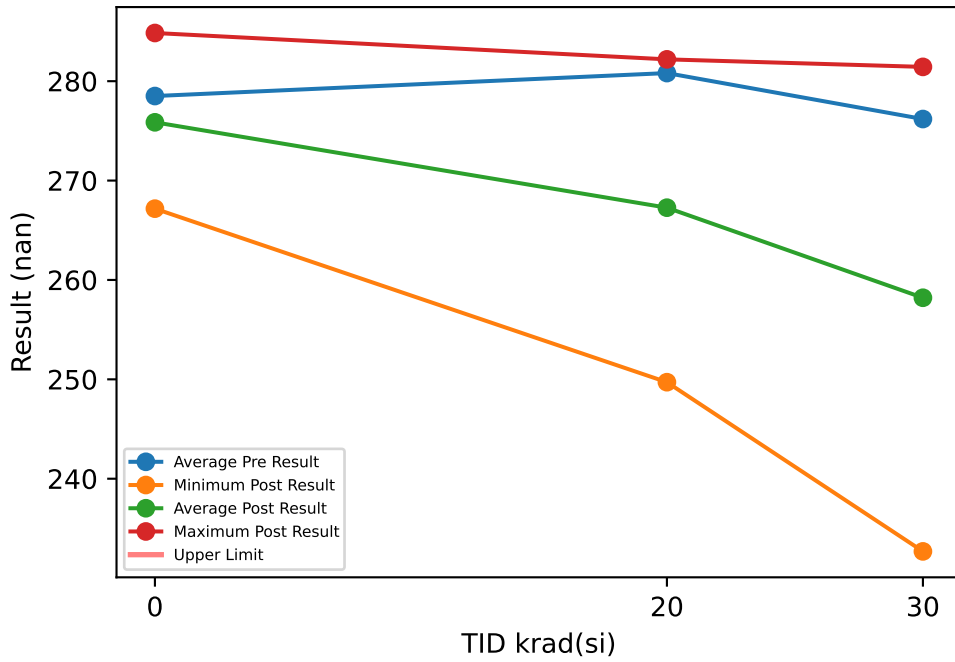

Test Results (No Limits Specified (nan))

Serial #	krad(si)	Exposure Conditions	Pre Result	Post Result	Delta
50	20	LDR biased	282.66	255.74	-26.917
51	20	LDR biased	278.45	258.06	-20.394
52	20	LDR biased	289.37	249.71	-39.66
53	20	LDR biased	286.2	261.87	-24.334
54	20	LDR biased	274.34	261.5	-12.841
55	30	LDR biased	278.19	235.19	-43.005
56	30	LDR biased	274.09	248.55	-25.539
57	30	LDR biased	274.29	232.69	-41.606
58	30	LDR biased	278.39	247.37	-31.015
59	30	LDR biased	277.25	252.92	-24.322
60	20	LDR unbiased	277.86	272.26	-5.604
61	20	LDR unbiased	282.24	282.2	-0.038
62	20	LDR unbiased	280.51	278.55	-1.959
63	20	LDR unbiased	275.79	271.46	-4.323
64	20	LDR unbiased	280.75	281.37	0.622
65	30	LDR unbiased	284.58	278.96	-5.615
66	30	LDR unbiased	267.29	266.54	-0.747
67	30	LDR unbiased	279.79	281.44	1.649
68	30	LDR unbiased	270.21	271.79	1.583
69	30	LDR unbiased	277.85	266.63	-11.219
70	0	correlation	273.08	275.16	2.077
71	0	correlation	284.44	276.66	-7.779
72	0	correlation	278.13	275.47	-2.661
73	0	correlation	278.34	284.85	6.513
74	0	correlation	278.54	267.17	-11.368

TID vs Post - Pre Exposure Delta

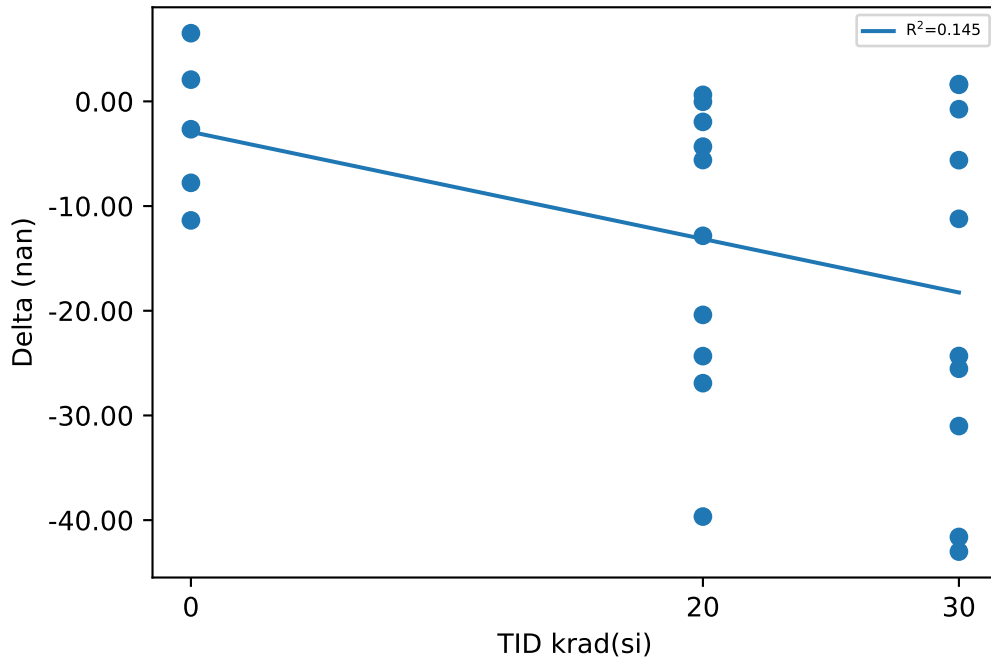

Test Statistics (nan)

krad(si)	Pre Exposure Min	Pre Exposure Avg	Pre Exposure Max	Pre Exposure Std	Post Exposure Min	Post Exposure Avg	Post Exposure Max	Post Exposure Std	Min Delta	Avg Delta	Max Delta	Std Delta
0	273.08	278.51	284.44	4.0251	267.17	275.86	284.85	6.2757	-11.368	-2.6436	6.513	7.2218
20	274.34	280.82	289.37	4.5856	249.71	267.27	282.2	11.451	-39.66	-13.545	0.622	13.704
30	267.29	276.19	284.58	4.9339	232.69	258.21	281.44	17.369	-43.005	-17.984	1.649	17.37

Device Test: 10.44 UJXOZU(Kcs_25mA_CH4_UJXOZU)

TID vs Result Stats

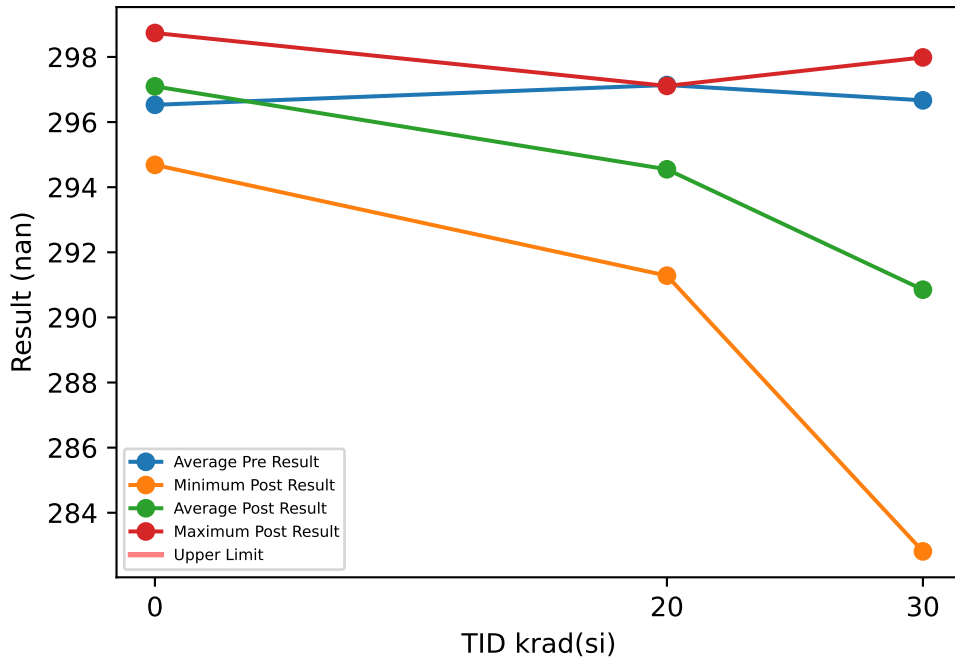

Test Results (No Limits Specified (nan))

Serial #	krad(si)	Exposure Conditions	Pre Result	Post Result	Delta
50	20	LDR biased	297	293.01	-3.989
51	20	LDR biased	297.98	293.94	-4.033
52	20	LDR biased	299.36	293.81	-5.553
53	20	LDR biased	297.35	291.28	-6.063
54	20	LDR biased	296.18	293.02	-3.156
55	30	LDR biased	296.07	285.16	-10.911
56	30	LDR biased	296.6	286.35	-10.249
57	30	LDR biased	296.38	289.03	-7.355
58	30	LDR biased	297.7	287.09	-10.61
59	30	LDR biased	295.82	282.81	-13.003
60	20	LDR unbiased	296.42	295.88	-0.54
61	20	LDR unbiased	296.88	296.89	0.014
62	20	LDR unbiased	297.82	297.11	-0.712
63	20	LDR unbiased	297.45	296.19	-1.268
64	20	LDR unbiased	294.95	294.36	-0.585
65	30	LDR unbiased	297.97	297.99	0.016
66	30	LDR unbiased	294.7	293.11	-1.594
67	30	LDR unbiased	299.02	297.52	-1.5
68	30	LDR unbiased	295.29	294.8	-0.487
69	30	LDR unbiased	297.13	294.66	-2.467
70	0	correlation	296.9	298.15	1.255
71	0	correlation	297	298.74	1.734
72	0	correlation	296.45	298.29	1.832
73	0	correlation	296.06	294.69	-1.38
74	0	correlation	296.23	295.63	-0.606

TID vs Post - Pre Exposure Delta

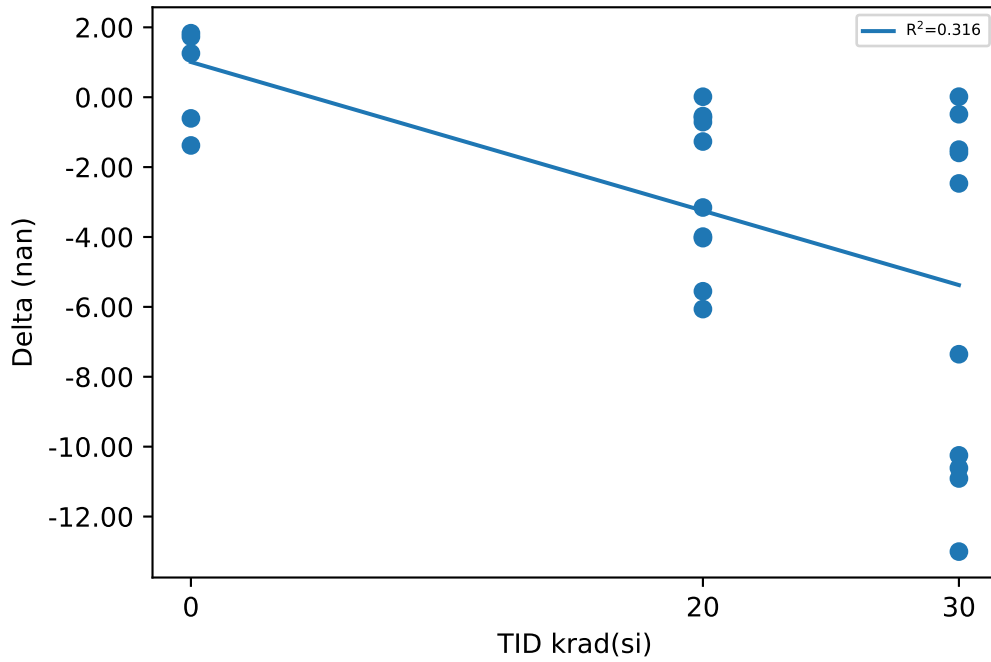

Test Statistics (nan)

krad(si)	Pre Exposure Min	Pre Exposure Avg	Pre Exposure Max	Pre Exposure Std	Post Exposure Min	Post Exposure Avg	Post Exposure Max	Post Exposure Std	Min Delta	Avg Delta	Max Delta	Std Delta
0	296.06	296.53	297	0.40879	294.69	297.1	298.74	1.8161	-1.38	0.567	1.832	1.4665
20	294.95	297.14	299.36	1.1817	291.28	294.55	297.11	1.9097	-6.063	-2.5885	0.014	2.2479
30	294.7	296.67	299.02	1.3106	282.81	290.85	297.99	5.4304	-13.003	-5.816	0.016	5.0848

Device Test: 10.45 UJXOZU(Kcs_50mA_CH4_UJXOZU)

TID vs Result Stats

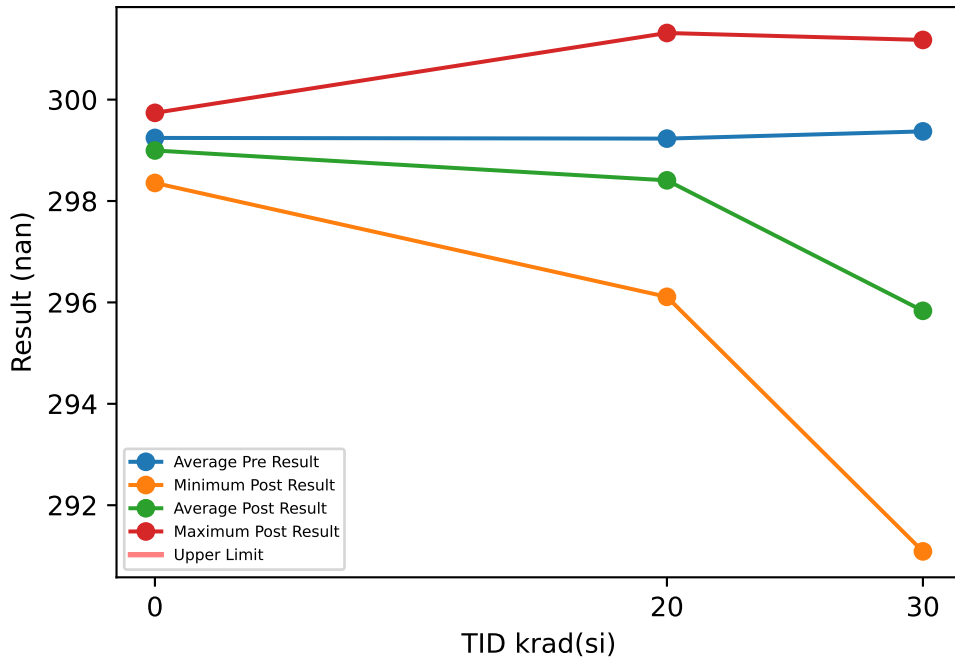

Test Results (No Limits Specified (nan))

Serial #	krad(si)	Exposure Conditions	Pre Result	Post Result	Delta
50	20	LDR biased	300.03	297.71	-2.326
51	20	LDR biased	299.42	299.18	-0.236
52	20	LDR biased	299.89	297.73	-2.16
53	20	LDR biased	298.12	296.27	-1.85
54	20	LDR biased	298.85	296.11	-2.737
55	30	LDR biased	300.24	292.7	-7.535
56	30	LDR biased	298.43	291.09	-7.343
57	30	LDR biased	298.66	293.38	-5.276
58	30	LDR biased	299.72	293.39	-6.33
59	30	LDR biased	299.04	292.55	-6.483
60	20	LDR unbiased	299.11	299.36	0.25
61	20	LDR unbiased	299.89	299.99	0.099
62	20	LDR unbiased	298.82	301.31	2.489
63	20	LDR unbiased	299.33	298.39	-0.942
64	20	LDR unbiased	298.84	298.02	-0.819
65	30	LDR unbiased	299.96	301.18	1.214
66	30	LDR unbiased	298.82	296.4	-2.419
67	30	LDR unbiased	301.55	299.86	-1.689
68	30	LDR unbiased	297.8	298.4	0.606
69	30	LDR unbiased	299.52	299.39	-0.137
70	0	correlation	299.45	298.38	-1.069
71	0	correlation	300.23	299.45	-0.781
72	0	correlation	299.92	299.74	-0.184
73	0	correlation	297.97	299.06	1.085
74	0	correlation	298.64	298.36	-0.289

TID vs Post - Pre Exposure Delta

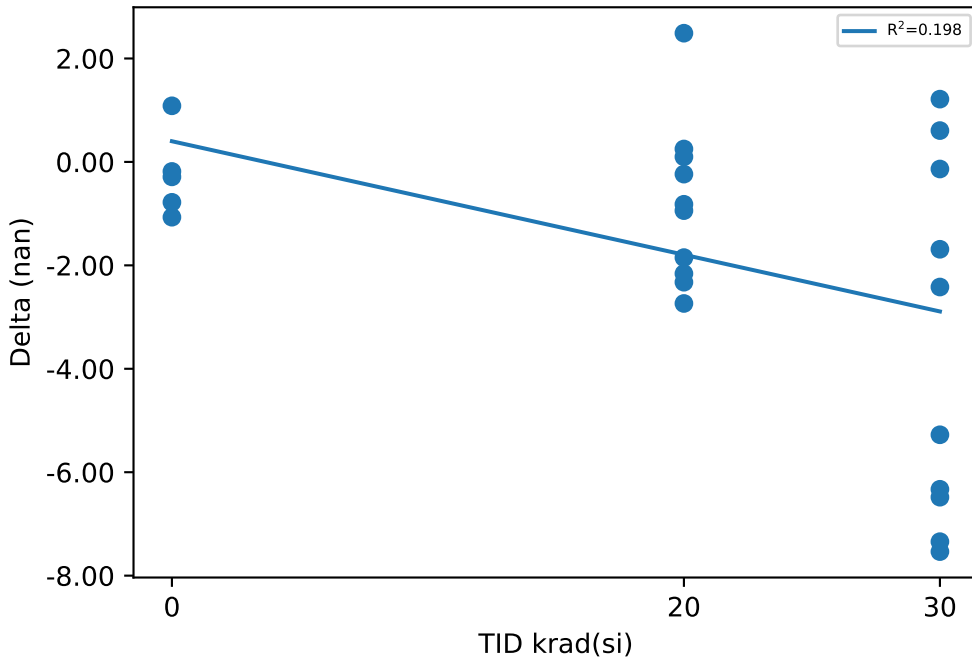

Test Statistics (nan)

krad(si)	Pre Exposure Min	Pre Exposure Avg	Pre Exposure Max	Pre Exposure Std	Post Exposure Min	Post Exposure Avg	Post Exposure Max	Post Exposure Std	Min Delta	Avg Delta	Max Delta	Std Delta
0	297.97	299.24	300.23	0.92955	298.36	299	299.74	0.62149	-1.069	-0.2476	1.085	0.82777
20	298.12	299.23	300.03	0.60319	296.11	298.41	301.31	1.613	-2.737	-0.8232	2.489	1.5668
30	297.8	299.37	301.55	1.0673	291.09	295.83	301.18	3.6421	-7.535	-3.5392	1.214	3.4308

Device Test: 10.46 UJXOZU(Kcs_100mA_CH4_UJXOZU)

TID vs Result Stats

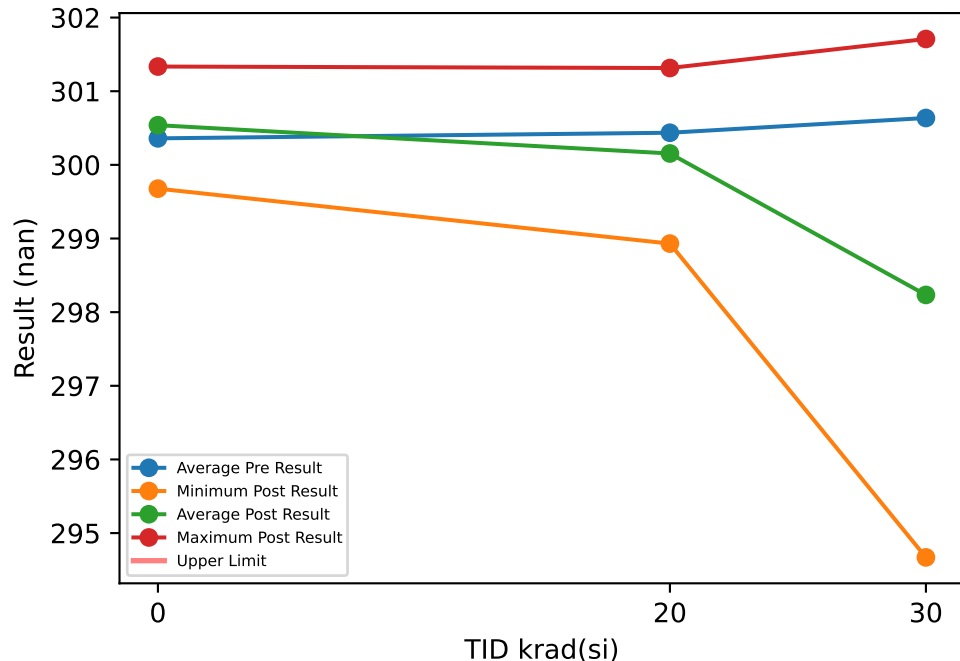

Test Results (No Limits Specified (nan))

Serial #	krad(si)	Exposure Conditions	Pre Result	Post Result	Delta
50	20	LDR biased	300.81	300.47	-0.341
51	20	LDR biased	301.32	301.31	-0.001
52	20	LDR biased	301	299.72	-1.279
53	20	LDR biased	300.26	298.93	-1.325
54	20	LDR biased	299.63	299.11	-0.519
55	30	LDR biased	300.33	294.67	-5.656
56	30	LDR biased	300.43	295.55	-4.871
57	30	LDR biased	300.48	296.51	-3.969
58	30	LDR biased	301.06	295.86	-5.203
59	30	LDR biased	300.6	295.57	-5.029
60	20	LDR unbiased	300.6	300.91	0.311
61	20	LDR unbiased	299.91	300.34	0.431
62	20	LDR unbiased	300.25	300.95	0.694
63	20	LDR unbiased	300.09	300.19	0.104
64	20	LDR unbiased	300.5	299.61	-0.89
65	30	LDR unbiased	301.18	301.71	0.526
66	30	LDR unbiased	300.26	299.65	-0.606
67	30	LDR unbiased	301.79	301.24	-0.546
68	30	LDR unbiased	299.3	300.48	1.183
69	30	LDR unbiased	300.94	301.09	0.146
70	0	correlation	300.79	301.04	0.247
71	0	correlation	300.95	301.33	0.381
72	0	correlation	300.77	300.89	0.127
73	0	correlation	299.61	299.68	0.065
74	0	correlation	299.68	299.75	0.074

TID vs Post - Pre Exposure Delta

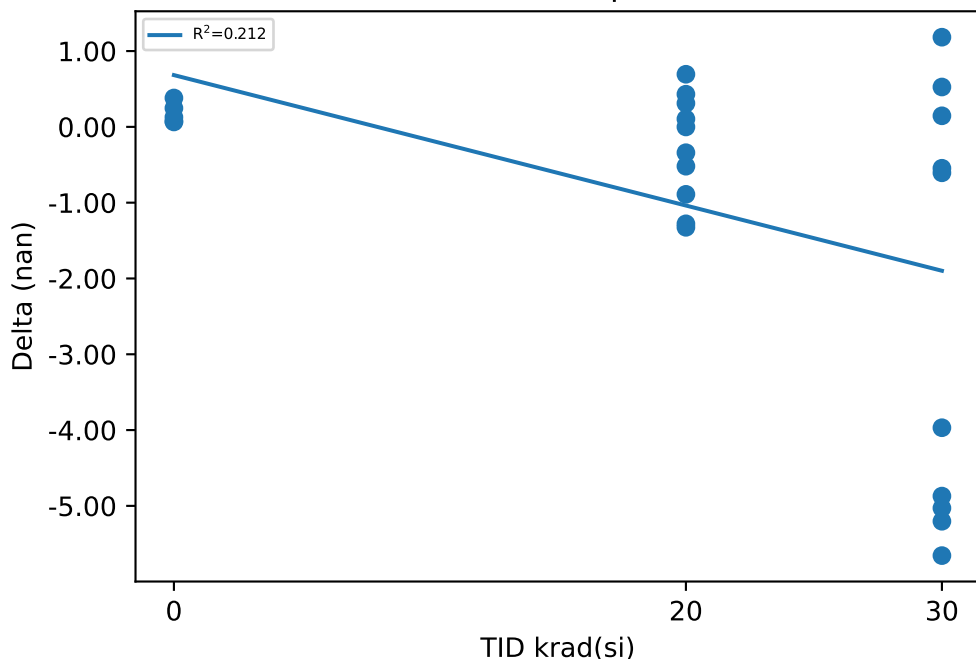

Test Statistics (nan)

krad(si)	Pre Exposure Min	Pre Exposure Avg	Pre Exposure Max	Pre Exposure Std	Post Exposure Min	Post Exposure Avg	Post Exposure Max	Post Exposure Std	Min Delta	Avg Delta	Max Delta	Std Delta
0	299.61	300.36	300.95	0.65795	299.68	300.54	301.33	0.77042	0.065	0.1788	0.381	0.13431
20	299.63	300.44	301.32	0.51307	298.93	300.15	301.31	0.80002	-1.325	-0.2815	0.694	0.71116
30	299.3	300.64	301.79	0.66755	294.67	298.23	301.71	2.8274	-5.656	-2.4025	1.183	2.7583

Device Test: 10.47 UJXOZU(Kcs_250mA_CH4_UJXOZU)

TID vs Result Stats

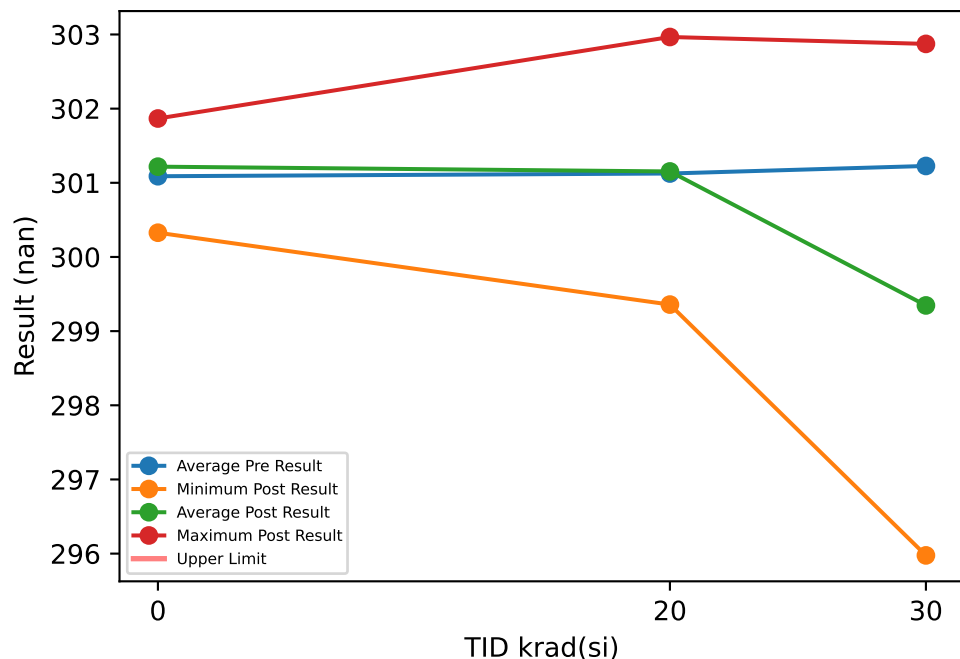

Test Results (No Limits Specified (nan))

Serial #	krad(si)	Exposure Conditions	Pre Result	Post Result	Delta
50	20	LDR biased	301.51	302.17	0.657
51	20	LDR biased	301.81	302.97	1.151
52	20	LDR biased	302.04	300.6	-1.432
53	20	LDR biased	300.99	300.27	-0.716
54	20	LDR biased	300.65	300.56	-0.099
55	30	LDR biased	300.02	295.98	-4.042
56	30	LDR biased	300.84	295.98	-4.859
57	30	LDR biased	300.84	298.39	-2.453
58	30	LDR biased	301.6	297.55	-4.058
59	30	LDR biased	300.86	296.76	-4.099
60	20	LDR unbiased	300.97	301.74	0.768
61	20	LDR unbiased	300.3	301.61	1.303
62	20	LDR unbiased	300.95	301.39	0.441
63	20	LDR unbiased	301.17	300.87	-0.301
64	20	LDR unbiased	300.85	299.36	-1.492
65	30	LDR unbiased	302.49	302.87	0.379
66	30	LDR unbiased	301.43	300.97	-0.467
67	30	LDR unbiased	302.32	302.46	0.135
68	30	LDR unbiased	300.56	300.9	0.343
69	30	LDR unbiased	301.3	301.61	0.316
70	0	correlation	301.24	301.87	0.625
71	0	correlation	301.77	301.72	-0.049
72	0	correlation	301.35	301.47	0.118
73	0	correlation	300.32	300.71	0.386
74	0	correlation	300.76	300.33	-0.435

TID vs Post - Pre Exposure Delta

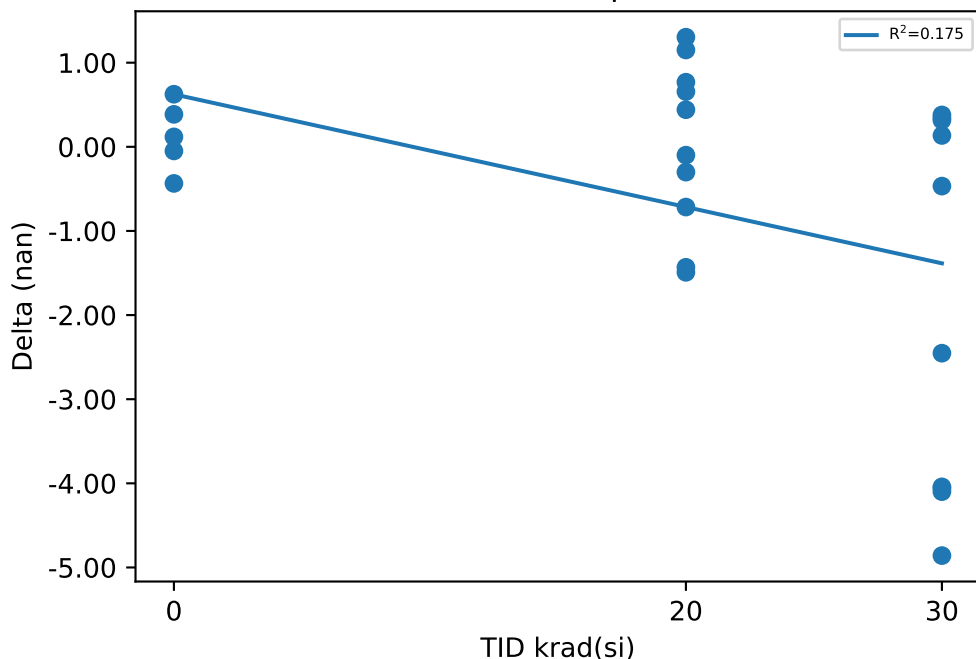

Test Statistics (nan)

krad(si)	Pre Exposure Min	Pre Exposure Avg	Pre Exposure Max	Pre Exposure Std	Post Exposure Min	Post Exposure Avg	Post Exposure Max	Post Exposure Std	Min Delta	Avg Delta	Max Delta	Std Delta
0	300.32	301.09	301.77	0.55776	300.33	301.22	301.87	0.66824	-0.435	0.129	0.625	0.40681
20	300.3	301.13	302.04	0.52742	299.36	301.15	302.97	1.0359	-1.492	0.028	1.303	1.0067
30	300.02	301.23	302.49	0.77068	295.98	299.35	302.87	2.7049	-4.859	-1.8805	0.379	2.2228

Device Test: 10.48 UJXOZU(Kcs_500mA_CH4_UJXOZU)

TID vs Result Stats

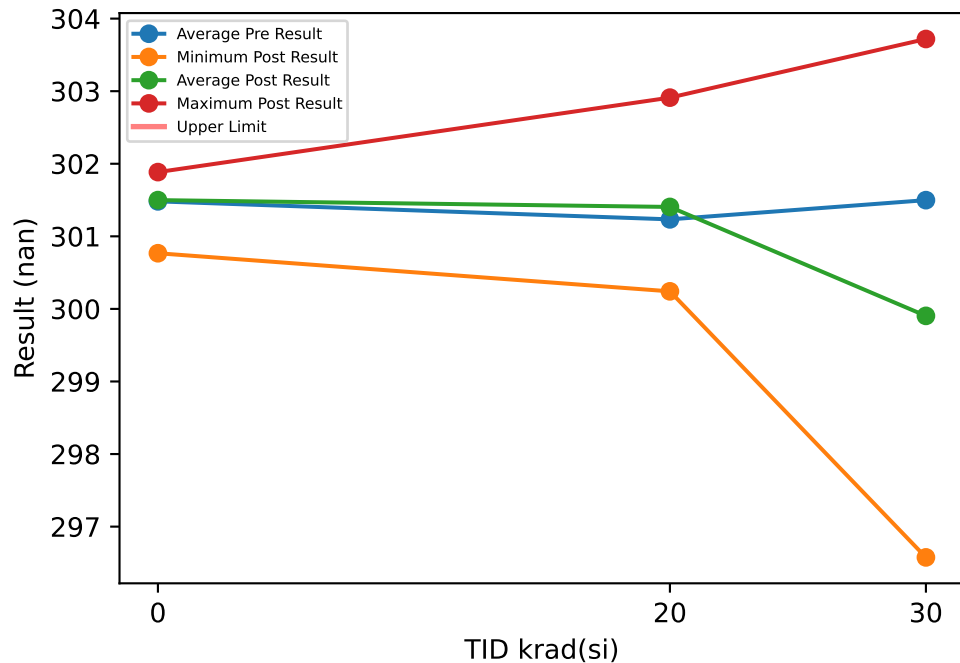

Test Results (No Limits Specified (nan))

Serial #	krad(si)	Exposure Conditions	Pre Result	Post Result	Delta
50	20	LDR biased	301.38	301.96	0.582
51	20	LDR biased	301.94	302.91	0.975
52	20	LDR biased	301.8	301.21	-0.589
53	20	LDR biased	300.9	300.33	-0.575
54	20	LDR biased	300.62	300.51	-0.111
55	30	LDR biased	301.11	297.69	-3.418
56	30	LDR biased	301.45	296.58	-4.877
57	30	LDR biased	301.13	298.42	-2.718
58	30	LDR biased	302.19	297.6	-4.599
59	30	LDR biased	301.12	297.44	-3.677
60	20	LDR unbiased	301.79	301.97	0.181
61	20	LDR unbiased	300.92	301.76	0.849
62	20	LDR unbiased	300.96	301.59	0.63
63	20	LDR unbiased	301.13	301.56	0.43
64	20	LDR unbiased	300.9	300.24	-0.66
65	30	LDR unbiased	302.02	303.72	1.699
66	30	LDR unbiased	301.68	301.1	-0.577
67	30	LDR unbiased	302.3	302.37	0.069
68	30	LDR unbiased	300.57	301.36	0.785
69	30	LDR unbiased	301.4	302.77	1.369
70	0	correlation	301.66	301.85	0.194
71	0	correlation	302.08	301.88	-0.194
72	0	correlation	301.6	301.77	0.166
73	0	correlation	300.86	300.77	-0.09
74	0	correlation	301.22	301.23	0.01

TID vs Post - Pre Exposure Delta

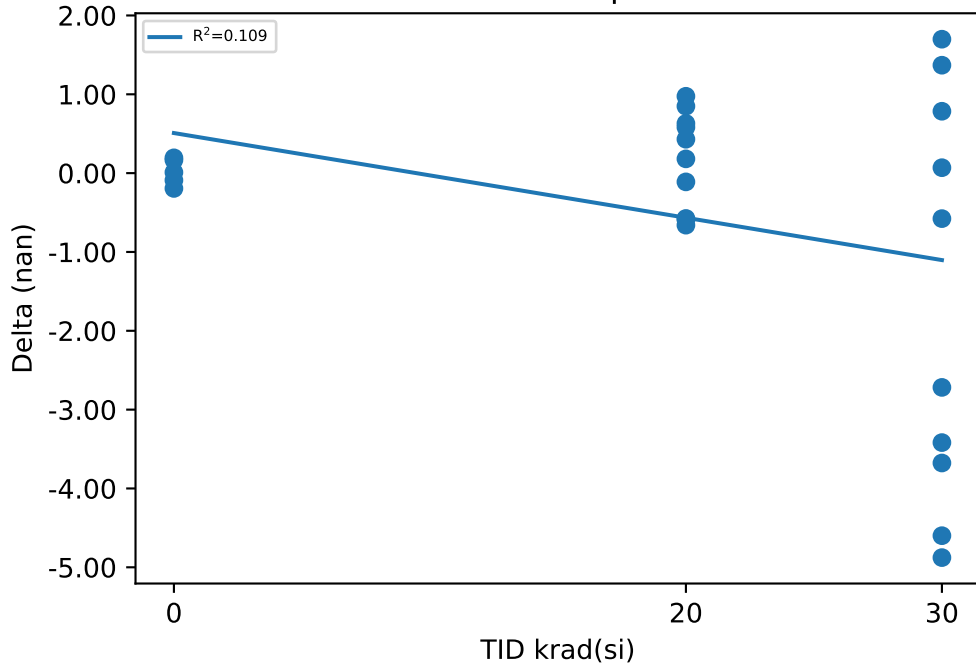

Test Statistics (nan)

krad(si)	Pre Exposure Min	Pre Exposure Avg	Pre Exposure Max	Pre Exposure Std	Post Exposure Min	Post Exposure Avg	Post Exposure Max	Post Exposure Std	Min Delta	Avg Delta	Max Delta	Std Delta
0	300.86	301.48	302.08	0.46428	300.77	301.5	301.88	0.48846	-0.194	0.0172	0.194	0.16549
20	300.62	301.23	301.94	0.46222	300.24	301.41	302.91	0.84547	-0.66	0.1712	0.975	0.61977
30	300.57	301.5	302.3	0.55073	296.58	299.9	303.72	2.6233	-4.877	-1.5944	1.699	2.5347

Device Test: 10.6 UJA0RR(dCSR_500mA_CH1_UJA0RR)

TID vs Result Stats

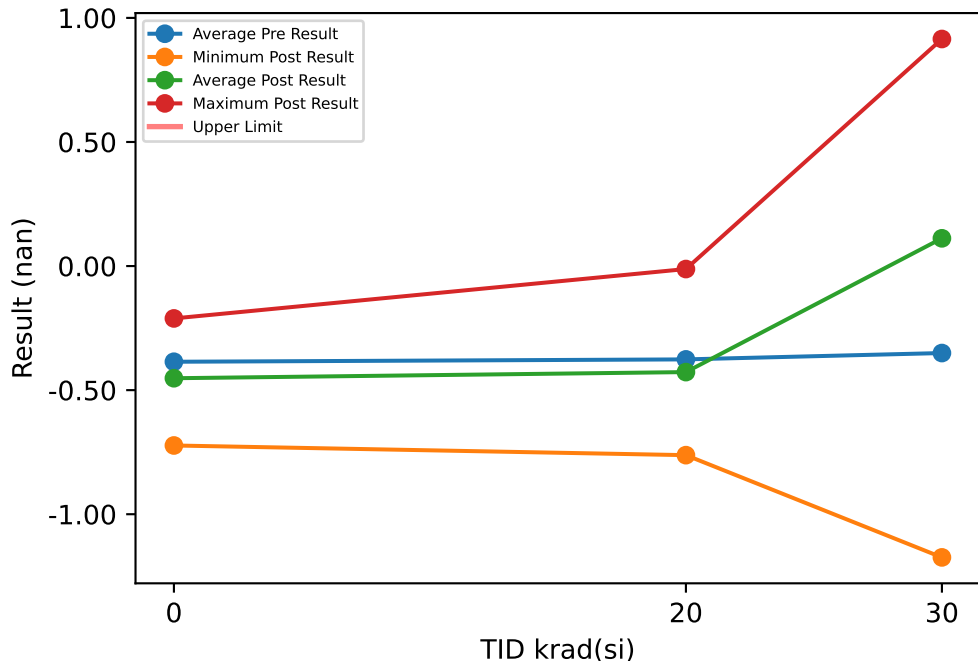

Test Results (No Limits Specified (nan))

Serial #	krad(si)	Exposure Conditions	Pre Result	Post Result	Delta
50	20	LDR biased	-0.247	-0.444	-0.197
51	20	LDR biased	-0.481	-0.762	-0.281
52	20	LDR biased	0.003	-0.017	-0.02
53	20	LDR biased	-0.547	-0.381	0.166
54	20	LDR biased	-0.33	-0.324	0.006
55	30	LDR biased	-0.417	0.915	1.332
56	30	LDR biased	-0.515	0.894	1.409
57	30	LDR biased	-0.535	0.325	0.86
58	30	LDR biased	-0.463	0.802	1.265
59	30	LDR biased	-0.184	0.769	0.953
60	20	LDR unbiased	-0.43	-0.567	-0.137
61	20	LDR unbiased	-0.432	-0.539	-0.107
62	20	LDR unbiased	-0.471	-0.693	-0.222
63	20	LDR unbiased	-0.447	-0.534	-0.087
64	20	LDR unbiased	-0.379	-0.012	0.367
65	30	LDR unbiased	-0.726	-1.174	-0.448
66	30	LDR unbiased	-0.39	-0.292	0.098
67	30	LDR unbiased	-0.026	-0.005	0.021
68	30	LDR unbiased	-0.166	-0.8	-0.634
69	30	LDR unbiased	-0.083	-0.316	-0.233
70	0	correlation	-0.68	-0.723	-0.043
71	0	correlation	-0.6	-0.591	0.009
72	0	correlation	-0.203	-0.211	-0.008
73	0	correlation	-0.109	-0.276	-0.167
74	0	correlation	-0.336	-0.459	-0.123

TID vs Post - Pre Exposure Delta

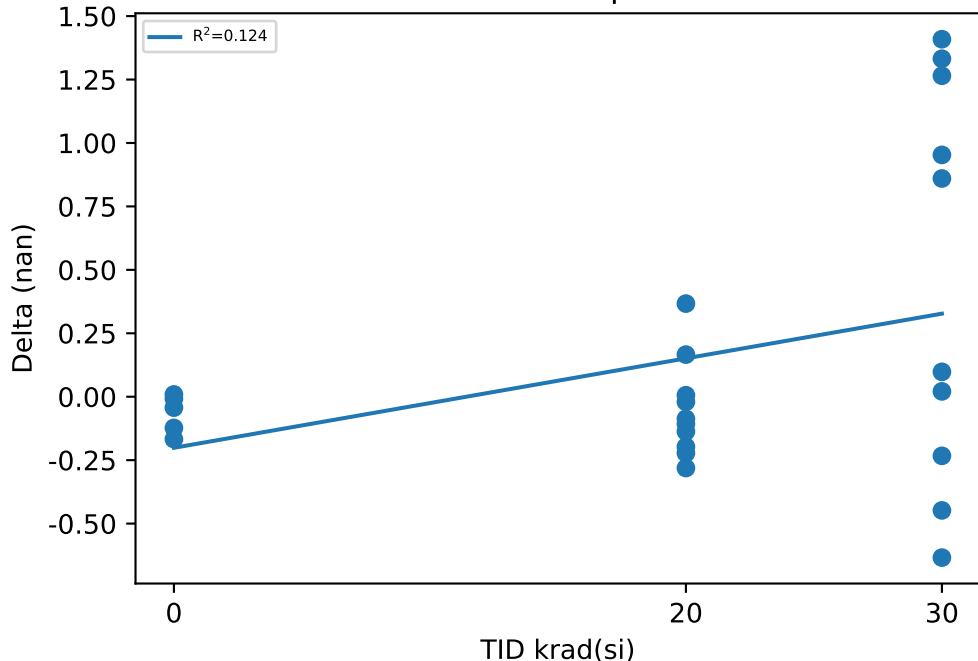

Test Statistics (nan)

krad(si)	Pre Exposure Min	Pre Exposure Avg	Pre Exposure Max	Pre Exposure Std	Post Exposure Min	Post Exposure Avg	Post Exposure Max	Post Exposure Std	Min Delta	Avg Delta	Max Delta	Std Delta
0	-0.68	-0.3856	-0.109	0.24746	-0.723	-0.452	-0.211	0.21323	-0.167	-0.0664	0.009	0.075775
20	-0.547	-0.3761	0.003	0.15734	-0.762	-0.4273	-0.012	0.25384	-0.281	-0.0512	0.367	0.19474
30	-0.726	-0.3505	-0.026	0.22592	-1.174	0.1118	0.915	0.74945	-0.634	0.4623	1.409	0.78438

Device Test: 10.7 UJR405(dCSR_5mA_CH2_UJR405)

TID vs Result Stats

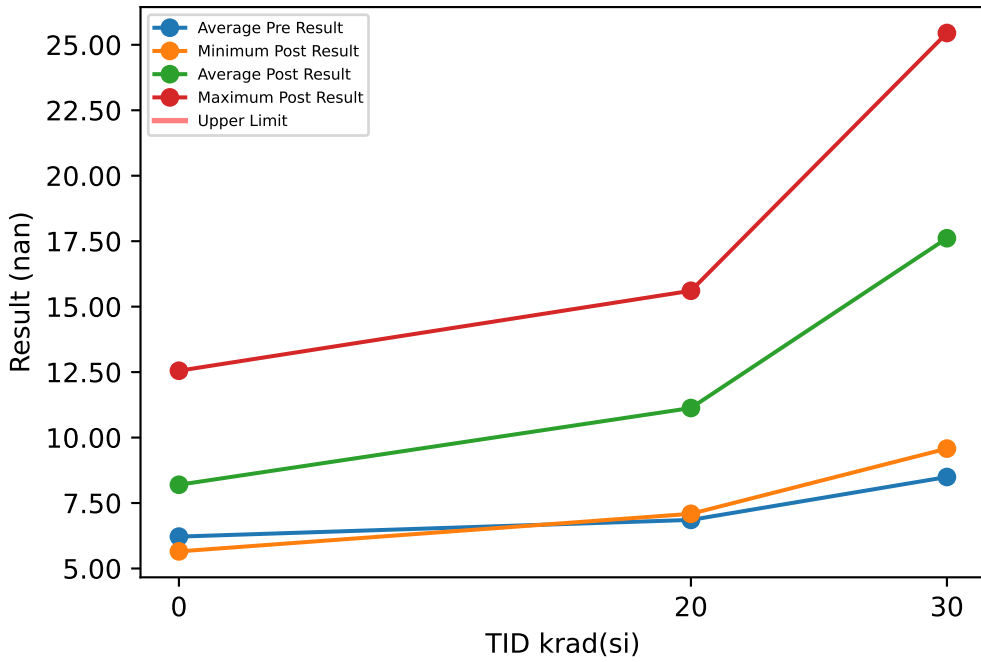

Test Results (No Limits Specified (nan))

Serial #	krad(si)	Exposure Conditions	Pre Result	Post Result	Delta
50	20	LDR biased	6.418	14.187	7.769
51	20	LDR biased	8.768	13.515	4.747
52	20	LDR biased	3.797	15.606	11.809
53	20	LDR biased	8.352	13.836	5.484
54	20	LDR biased	7.086	11.26	4.174
55	30	LDR biased	6.871	24.317	17.446
56	30	LDR biased	9.022	21.259	12.237
57	30	LDR biased	9.656	22.803	13.147
58	30	LDR biased	8.427	25.451	17.024
59	30	LDR biased	10.144	20.415	10.271
60	20	LDR unbiased	7.623	9.706	2.083
61	20	LDR unbiased	3.862	7.088	3.226
62	20	LDR unbiased	5.824	8.232	2.408
63	20	LDR unbiased	9.021	7.79	-1.231
64	20	LDR unbiased	7.803	10.064	2.261
65	30	LDR unbiased	8.151	9.579	1.428
66	30	LDR unbiased	9.579	15.595	6.016
67	30	LDR unbiased	6.683	13.655	6.972
68	30	LDR unbiased	7.693	12.867	5.174
69	30	LDR unbiased	8.712	10.196	1.484
70	0	correlation	6.894	8.877	1.983
71	0	correlation	8.1	7.079	-1.021
72	0	correlation	5.373	5.653	0.28
73	0	correlation	4.573	6.828	2.255
74	0	correlation	6.147	12.552	6.405

TID vs Post - Pre Exposure Delta

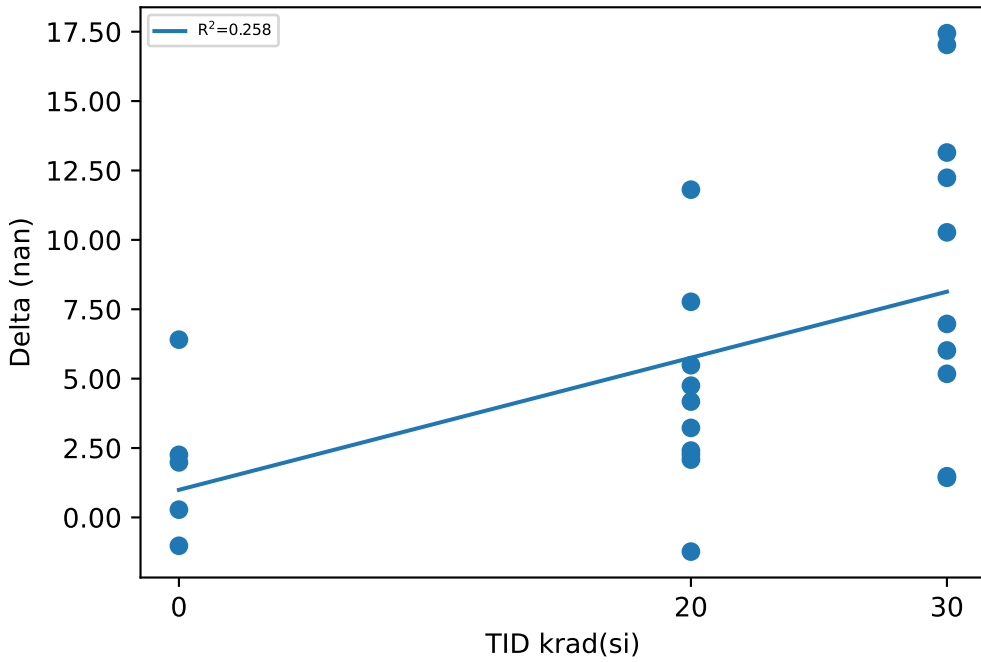

Test Statistics (nan)

krad(si)	Pre Exposure Min	Pre Exposure Avg	Pre Exposure Max	Pre Exposure Std	Post Exposure Min	Post Exposure Avg	Post Exposure Max	Post Exposure Std	Min Delta	Avg Delta	Max Delta	Std Delta
0	4.573	6.2174	8.1	1.3623	5.653	8.1978	12.552	2.6937	-1.021	1.9804	6.405	2.8086
20	3.797	6.8554	9.021	1.8767	7.088	11.128	15.606	3.0086	-1.231	4.273	11.809	3.5657
30	6.683	8.4938	10.144	1.1669	9.579	17.614	25.451	5.9281	1.428	9.1199	17.446	5.8343

Device Test: 10.761 UJQY9R(VCS_LINEAR_6p5V_Go-No-Go_UJQY9R)

TID vs Result Stats

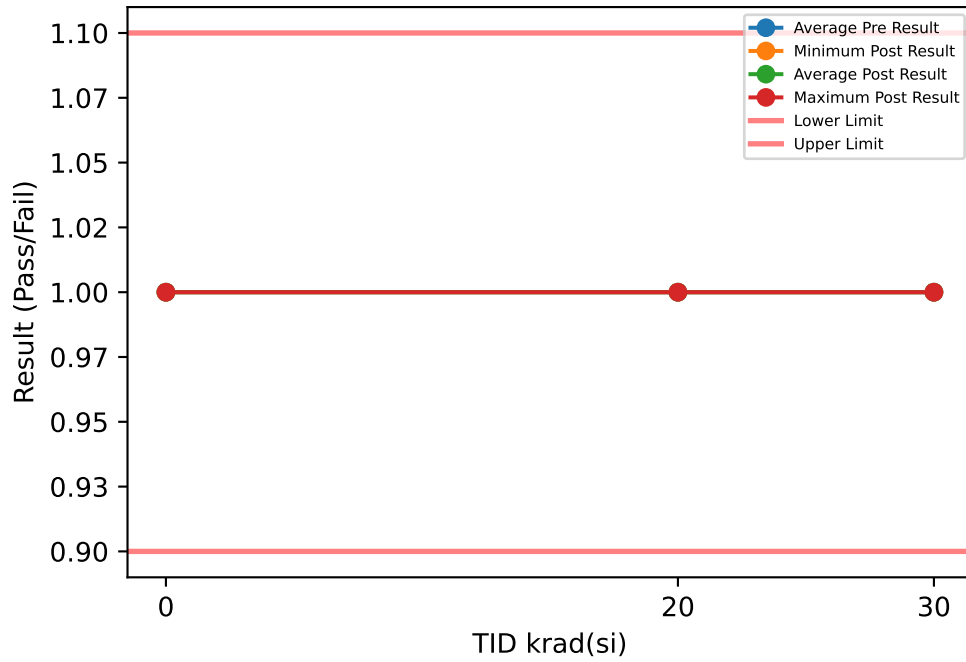

TID vs Post - Pre Exposure Delta

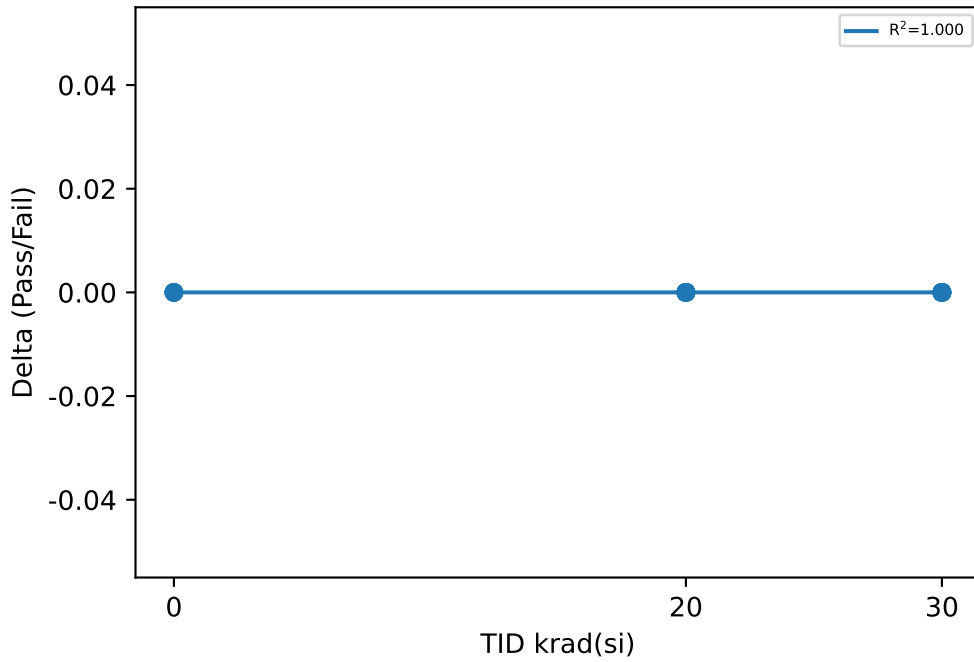

Test Results (Lower Limit = 0.9, Upper Limit = 1.1 (Pass/Fail))

Serial #	krad(si)	Exposure Conditions	Pre Result	Post Result	Delta
50	20	LDR biased	1	1	0
51	20	LDR biased	1	1	0
52	20	LDR biased	1	1	0
53	20	LDR biased	1	1	0
54	20	LDR biased	1	1	0
55	30	LDR biased	1	1	0
56	30	LDR biased	1	1	0
57	30	LDR biased	1	1	0
58	30	LDR biased	1	1	0
59	30	LDR biased	1	1	0
60	20	LDR unbiased	1	1	0
61	20	LDR unbiased	1	1	0
62	20	LDR unbiased	1	1	0
63	20	LDR unbiased	1	1	0
64	20	LDR unbiased	1	1	0
65	30	LDR unbiased	1	1	0
66	30	LDR unbiased	1	1	0
67	30	LDR unbiased	1	1	0
68	30	LDR unbiased	1	1	0
69	30	LDR unbiased	1	1	0
70	0	correlation	1	1	0
71	0	correlation	1	1	0
72	0	correlation	1	1	0
73	0	correlation	1	1	0
74	0	correlation	1	1	0

Test Statistics (Pass/Fail)

krad(si)	Pre Exposure Min	Pre Exposure Avg	Pre Exposure Max	Pre Exposure Std	Post Exposure Min	Post Exposure Avg	Post Exposure Max	Post Exposure Std	Min Delta	Avg Delta	Max Delta	Std Delta
0	1	1	1	0	1	1	1	0	0	0	0	0
20	1	1	1	0	1	1	1	0	0	0	0	0
30	1	1	1	0	1	1	1	0	0	0	0	0

Device Test: 10.791 UJWB0Y(VCS_LINEAR_5V_Go-No-Go_UJWB0Y)

TID vs Result Stats

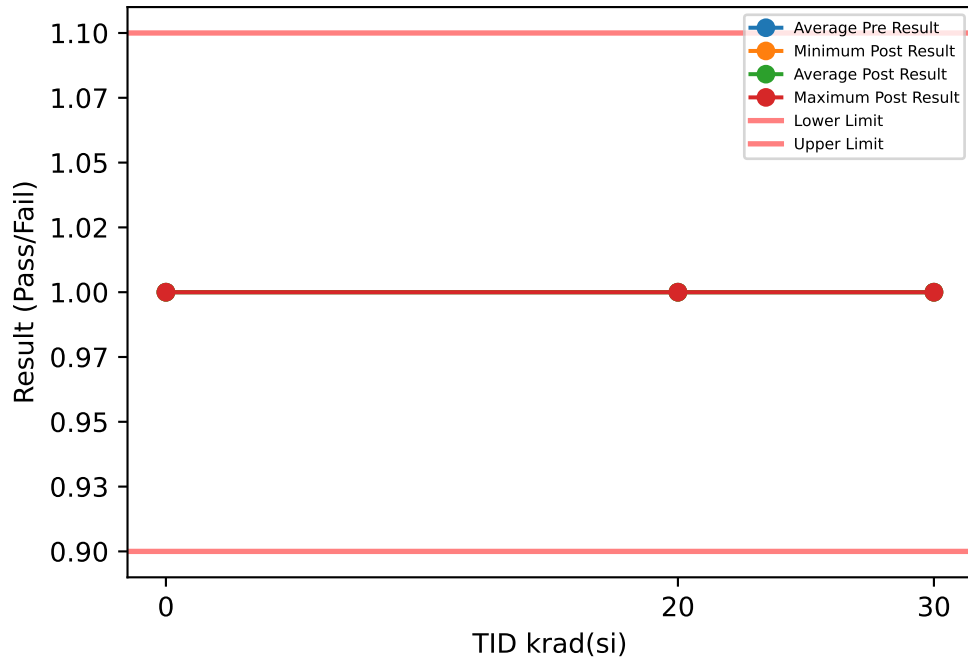

TID vs Post - Pre Exposure Delta

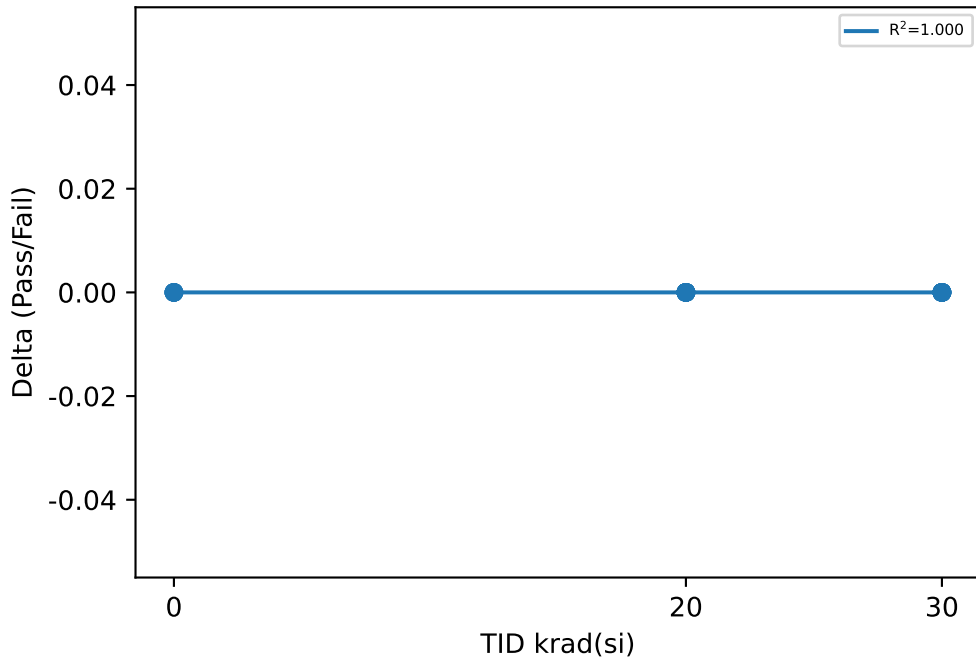

Test Results (Lower Limit = 0.9, Upper Limit = 1.1 (Pass/Fail))

Serial #	krad(si)	Exposure Conditions	Pre Result	Post Result	Delta
50	20	LDR biased	1	1	0
51	20	LDR biased	1	1	0
52	20	LDR biased	1	1	0
53	20	LDR biased	1	1	0
54	20	LDR biased	1	1	0
55	30	LDR biased	1	1	0
56	30	LDR biased	1	1	0
57	30	LDR biased	1	1	0
58	30	LDR biased	1	1	0
59	30	LDR biased	1	1	0
60	20	LDR unbiased	1	1	0
61	20	LDR unbiased	1	1	0
62	20	LDR unbiased	1	1	0
63	20	LDR unbiased	1	1	0
64	20	LDR unbiased	1	1	0
65	30	LDR unbiased	1	1	0
66	30	LDR unbiased	1	1	0
67	30	LDR unbiased	1	1	0
68	30	LDR unbiased	1	1	0
69	30	LDR unbiased	1	1	0
70	0	correlation	1	1	0
71	0	correlation	1	1	0
72	0	correlation	1	1	0
73	0	correlation	1	1	0
74	0	correlation	1	1	0

Test Statistics (Pass/Fail)

krad(si)	Pre Exposure Min	Pre Exposure Avg	Pre Exposure Max	Pre Exposure Std	Post Exposure Min	Post Exposure Avg	Post Exposure Max	Post Exposure Std	Min Delta	Avg Delta	Max Delta	Std Delta
0	1	1	1	0	1	1	1	0	0	0	0	0
20	1	1	1	0	1	1	1	0	0	0	0	0
30	1	1	1	0	1	1	1	0	0	0	0	0

Device Test: 10.8 UJFZSP(dCSR_25mA_CH2_UJFZSP)

TID vs Result Stats

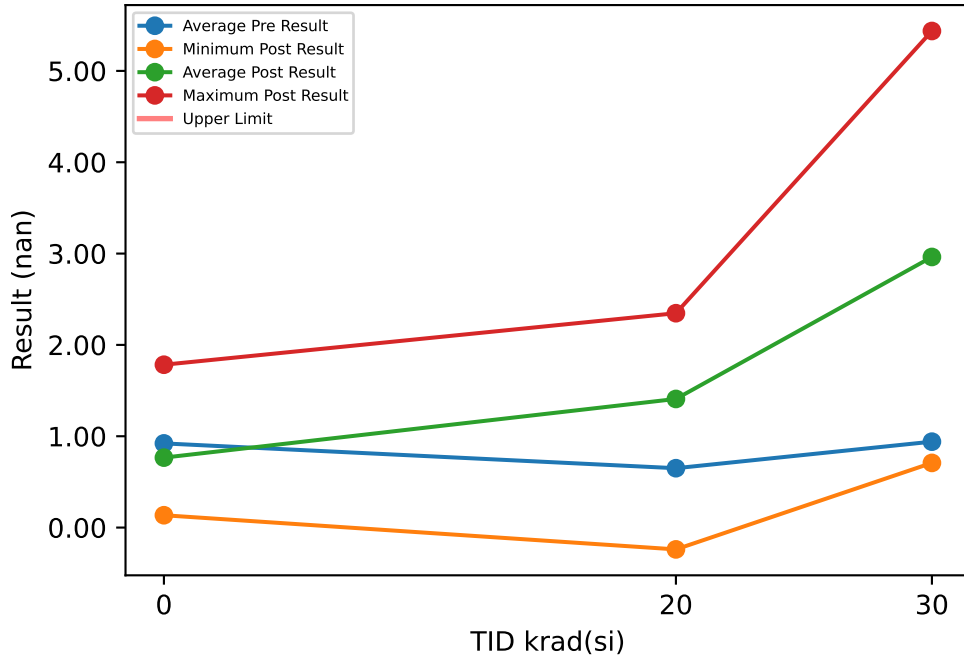

Test Results (No Limits Specified (nan))

Serial #	krad(si)	Exposure Conditions	Pre Result	Post Result	Delta
50	20	LDR biased	0.881	2.347	1.466
51	20	LDR biased	0.612	1.809	1.197
52	20	LDR biased	0.587	2.049	1.462
53	20	LDR biased	-0.069	1.668	1.737
54	20	LDR biased	1.34	1.668	0.328
55	30	LDR biased	0.37	4.831	4.461
56	30	LDR biased	0.951	3.868	2.917
57	30	LDR biased	1.052	3.46	2.408
58	30	LDR biased	1.54	5.437	3.897
59	30	LDR biased	0.041	4.314	4.273
60	20	LDR unbiased	1.045	1.261	0.216
61	20	LDR unbiased	0.099	0.37	0.271
62	20	LDR unbiased	-0.216	-0.239	-0.023
63	20	LDR unbiased	0.552	1.064	0.512
64	20	LDR unbiased	1.669	2.085	0.416
65	30	LDR unbiased	1.1	1.647	0.547
66	30	LDR unbiased	1.627	2.73	1.103
67	30	LDR unbiased	0.555	0.708	0.153
68	30	LDR unbiased	1.326	1.41	0.084
69	30	LDR unbiased	0.843	1.223	0.38
70	0	correlation	0.809	1.783	0.974
71	0	correlation	1.013	0.135	-0.878
72	0	correlation	0.225	0.298	0.073
73	0	correlation	0.832	0.556	-0.276
74	0	correlation	1.729	1.057	-0.672

TID vs Post - Pre Exposure Delta

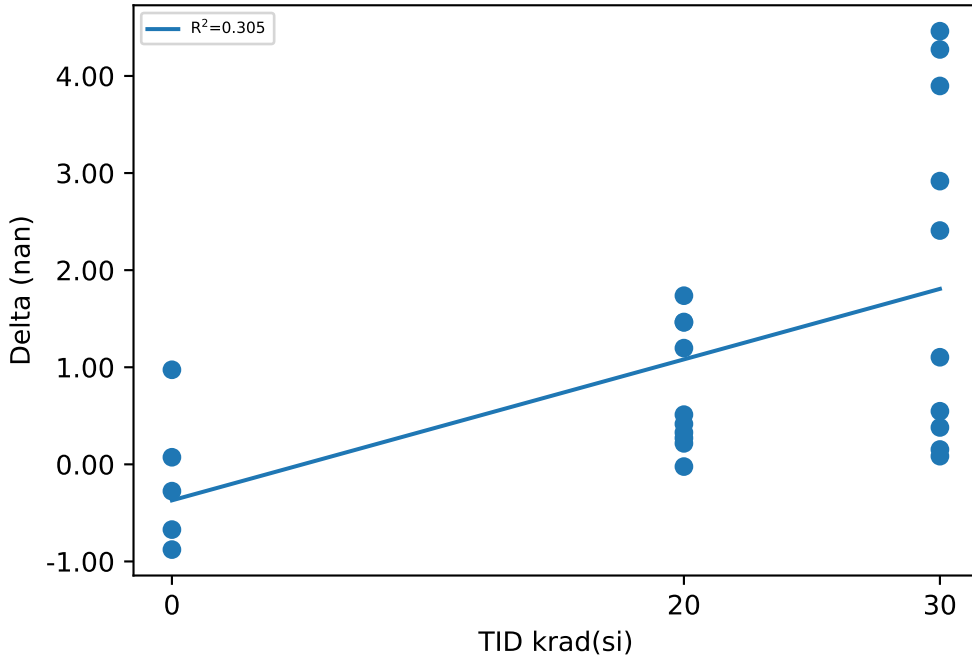

Test Statistics (nan)

krad(si)	Pre Exposure Min	Pre Exposure Avg	Pre Exposure Max	Pre Exposure Std	Post Exposure Min	Post Exposure Avg	Post Exposure Max	Post Exposure Std	Min Delta	Avg Delta	Max Delta	Std Delta
0	0.225	0.9216	1.729	0.53996	0.135	0.7658	1.783	0.66713	-0.878	-0.1558	0.974	0.72995
20	-0.216	0.65	1.669	0.60639	-0.239	1.4082	2.347	0.81493	-0.023	0.7582	1.737	0.63695
30	0.041	0.9405	1.627	0.50662	0.708	2.9628	5.437	1.6604	0.084	2.0223	4.461	1.7778

Device Test: 10.9 UJF0T(dCSR_50mA_CH2_UJF0T)

TID vs Result Stats

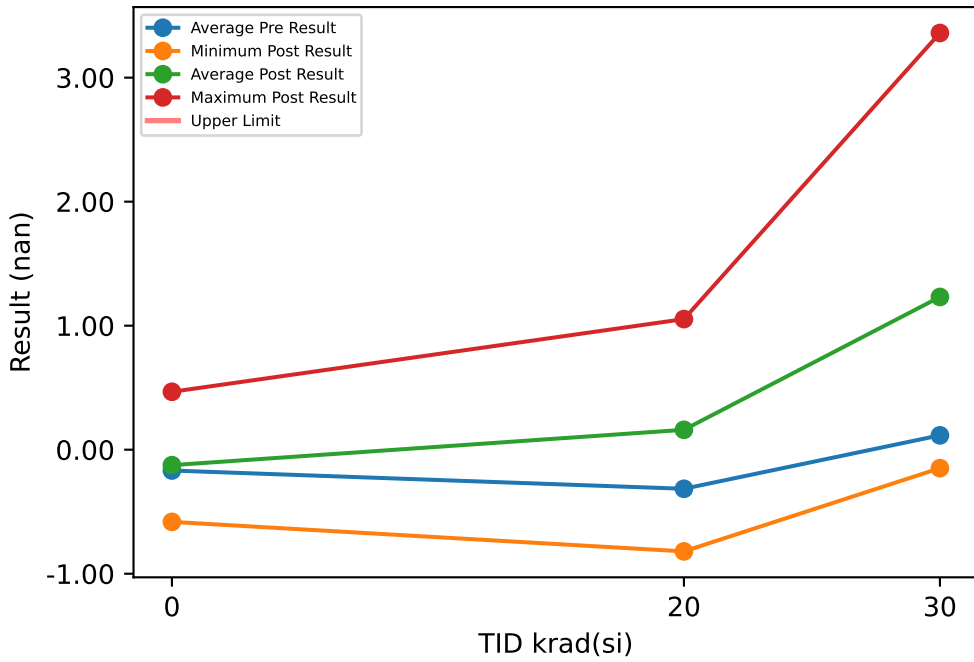

Test Results (No Limits Specified (nan))

Serial #	krad(si)	Exposure Conditions	Pre Result	Post Result	Delta
50	20	LDR biased	-0.17	0.183	0.353
51	20	LDR biased	-0.396	-0.171	0.225
52	20	LDR biased	-0.082	0.37	0.452
53	20	LDR biased	-0.552	0.67	1.222
54	20	LDR biased	-0.057	0.62	0.677
55	30	LDR biased	-0.241	2.694	2.935
56	30	LDR biased	-0.371	2.022	2.393
57	30	LDR biased	0.199	1.528	1.329
58	30	LDR biased	0.692	3.36	2.668
59	30	LDR biased	-0.268	1.477	1.745
60	20	LDR unbiased	-0.478	0.227	0.705
61	20	LDR unbiased	-0.94	-0.448	0.492
62	20	LDR unbiased	-0.452	-0.82	-0.368
63	20	LDR unbiased	-0.259	-0.08	0.179
64	20	LDR unbiased	0.235	1.053	0.818
65	30	LDR unbiased	0.107	0.197	0.09
66	30	LDR unbiased	0.616	0.978	0.362
67	30	LDR unbiased	-0.178	-0.149	0.029
68	30	LDR unbiased	0.151	0.05	-0.101
69	30	LDR unbiased	0.451	0.16	-0.291
70	0	correlation	0.193	0.467	0.274
71	0	correlation	-0.276	-0.32	-0.044
72	0	correlation	-0.774	-0.582	0.192
73	0	correlation	-0.213	-0.131	0.082
74	0	correlation	0.231	-0.057	-0.288

TID vs Post - Pre Exposure Delta

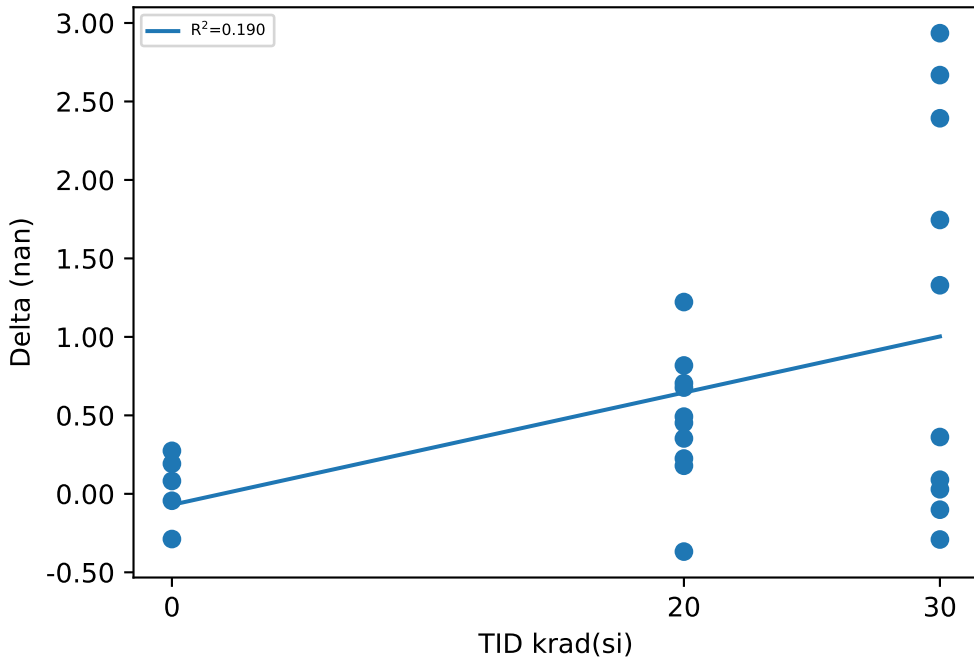

Test Statistics (nan)

krad(si)	Pre Exposure Min	Pre Exposure Avg	Pre Exposure Max	Pre Exposure Std	Post Exposure Min	Post Exposure Avg	Post Exposure Max	Post Exposure Std	Min Delta	Avg Delta	Max Delta	Std Delta
0	-0.774	-0.1678	0.231	0.4094	-0.582	-0.1246	0.467	0.38794	-0.288	0.0432	0.274	0.22035
20	-0.94	-0.3151	0.235	0.32424	-0.82	0.1604	1.053	0.55931	-0.368	0.4755	1.222	0.42763
30	-0.371	0.1158	0.692	0.38016	-0.149	1.2317	3.36	1.2031	-0.291	1.1159	2.935	1.2496

Device Test: 11.1 UJ9ZQ5(dCLR_P25A_CH1_UJ9ZQ5)

TID vs Result Stats

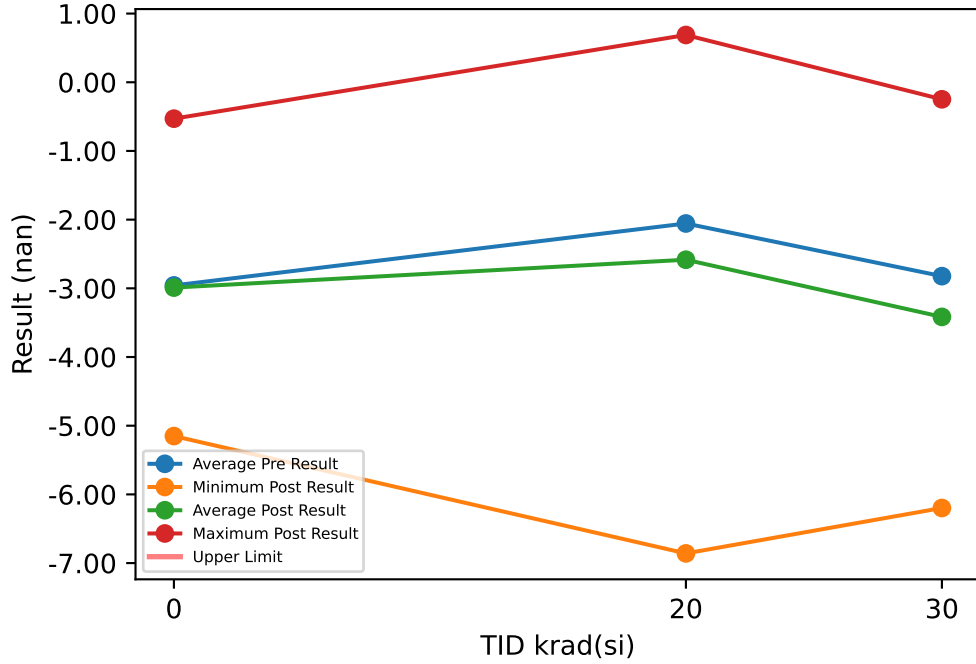

Test Results (No Limits Specified (nan))

Serial #	krad(si)	Exposure Conditions	Pre Result	Post Result	Delta
50	20	LDR biased	-1.234	-3.803	-2.569
51	20	LDR biased	-0.158	-0.754	-0.596
52	20	LDR biased	-4.271	-6.859	-2.588
53	20	LDR biased	-2.407	-1.768	0.639
54	20	LDR biased	-1.555	-0.292	1.263
55	30	LDR biased	-1.572	-3.056	-1.484
56	30	LDR biased	-5.15	-6.198	-1.048
57	30	LDR biased	-2.174	-0.248	1.926
58	30	LDR biased	-0.937	-3.295	-2.358
59	30	LDR biased	-3.803	-3.866	-0.063
60	20	LDR unbiased	-2.688	-3.158	-0.47
61	20	LDR unbiased	-4.814	-4.647	0.167
62	20	LDR unbiased	0.189	-0.551	-0.74
63	20	LDR unbiased	-4.464	-4.694	-0.23
64	20	LDR unbiased	0.842	0.688	-0.154
65	30	LDR unbiased	-2.308	-1.557	0.751
66	30	LDR unbiased	-3.597	-5.039	-1.442
67	30	LDR unbiased	-2.296	-2.778	-0.482
68	30	LDR unbiased	-3.338	-4.657	-1.319
69	30	LDR unbiased	-3.052	-3.466	-0.414
70	0	correlation	-4.479	-4.895	-0.416
71	0	correlation	-0.582	-0.53	0.052
72	0	correlation	-3.431	-3.354	0.077
73	0	correlation	-1.087	-1.017	0.07
74	0	correlation	-5.209	-5.151	0.058

TID vs Post - Pre Exposure Delta

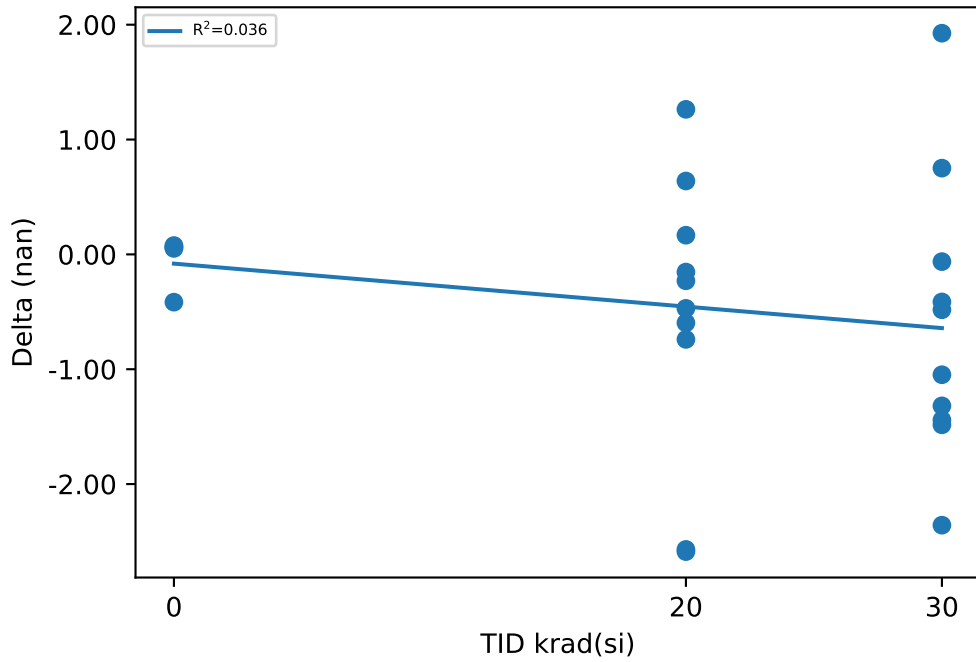

Test Statistics (nan)

krad(si)	Pre Exposure Min	Pre Exposure Avg	Pre Exposure Max	Pre Exposure Std	Post Exposure Min	Post Exposure Avg	Post Exposure Max	Post Exposure Std	Min Delta	Avg Delta	Max Delta	Std Delta
0	-5.209	-2.9576	-0.582	2.0463	-5.151	-2.9894	-0.53	2.1433	-0.416	-0.0318	0.077	0.215
20	-4.814	-2.056	0.842	2.0221	-6.859	-2.5838	0.688	2.4246	-2.588	-0.5278	1.263	1.2357
30	-5.15	-2.8227	-0.937	1.2192	-6.198	-3.416	-0.248	1.705	-2.358	-0.5933	1.926	1.2401

Device Test: 11.10 UJQ28B(Delta_dCLR_P5A_CH1CH3_UJQ28B)

TID vs Result Stats

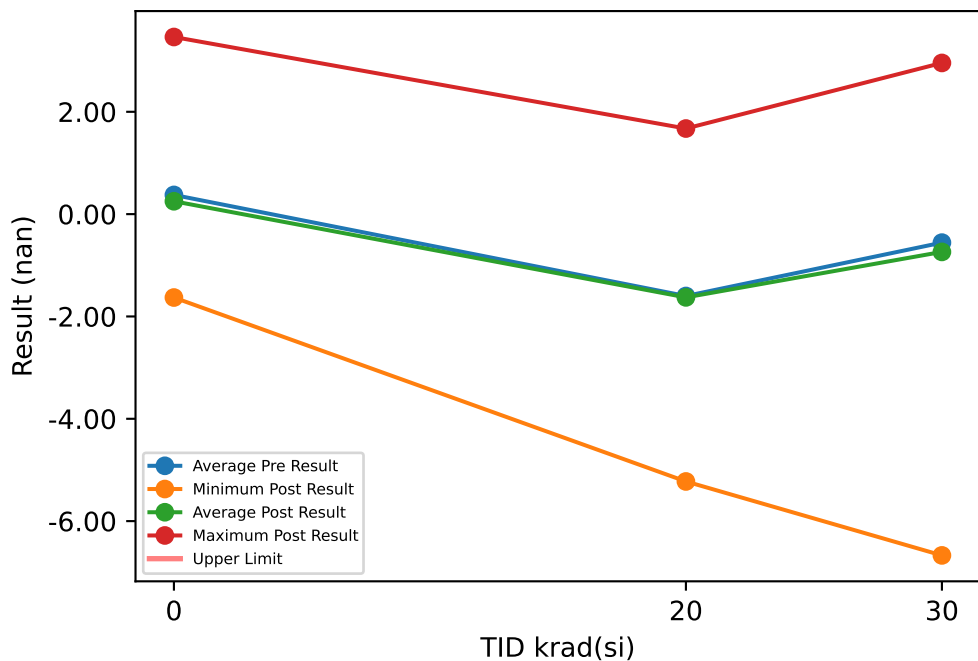

Test Results (No Limits Specified (nan))

Serial #	krad(si)	Exposure Conditions	Pre Result	Post Result	Delta
50	20	LDR biased	-3.896	-5.225	-1.329
51	20	LDR biased	-0.569	-0.69	-0.121
52	20	LDR biased	-3.225	-4.552	-1.327
53	20	LDR biased	-1.174	-0.796	0.378
54	20	LDR biased	0.461	1.673	1.212
55	30	LDR biased	1.11	1.302	0.192
56	30	LDR biased	-6.101	-6.67	-0.569
57	30	LDR biased	-1.972	-1.187	0.785
58	30	LDR biased	3.89	2.955	-0.935
59	30	LDR biased	-0.932	-0.633	0.299
60	20	LDR unbiased	-3.386	-3.048	0.338
61	20	LDR unbiased	-3.043	-2.342	0.701
62	20	LDR unbiased	0.701	0.903	0.202
63	20	LDR unbiased	-2.159	-2.391	-0.232
64	20	LDR unbiased	0.289	0.197	-0.092
65	30	LDR unbiased	0.654	0.475	-0.179
66	30	LDR unbiased	2.872	2.629	-0.243
67	30	LDR unbiased	-2.143	-2.417	-0.274
68	30	LDR unbiased	-2.475	-3.24	-0.765
69	30	LDR unbiased	-0.473	-0.598	-0.125
70	0	correlation	0.441	-0.075	-0.516
71	0	correlation	0.895	0.892	-0.003
72	0	correlation	-1.829	-1.63	0.199
73	0	correlation	3.494	3.462	-0.032
74	0	correlation	-1.125	-1.392	-0.267

TID vs Post - Pre Exposure Delta

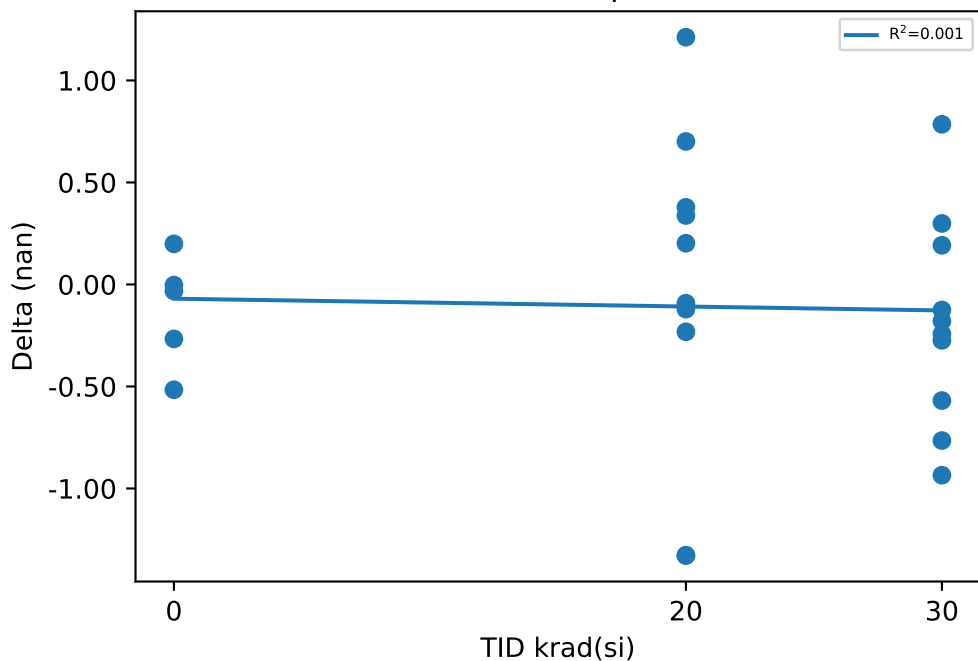

Test Statistics (nan)

krad(si)	Pre Exposure Min	Pre Exposure Avg	Pre Exposure Max	Pre Exposure Std	Post Exposure Min	Post Exposure Avg	Post Exposure Max	Post Exposure Std	Min Delta	Avg Delta	Max Delta	Std Delta
0	-1.829	0.3752	3.494	2.0682	-1.63	0.2514	3.462	2.0655	-0.516	-0.1238	0.199	0.27457
20	-3.896	-1.6001	0.701	1.7592	-5.225	-1.6271	1.673	2.2804	-1.329	-0.027	1.212	0.80658
30	-6.101	-0.557	3.89	2.884	-6.67	-0.7384	2.955	2.8888	-0.935	-0.1814	0.785	0.51407

Device Test: 11.11 UJ8ROM(Delta_dCLR_P5A_CH1CH4_UJ8ROM)

TID vs Result Stats

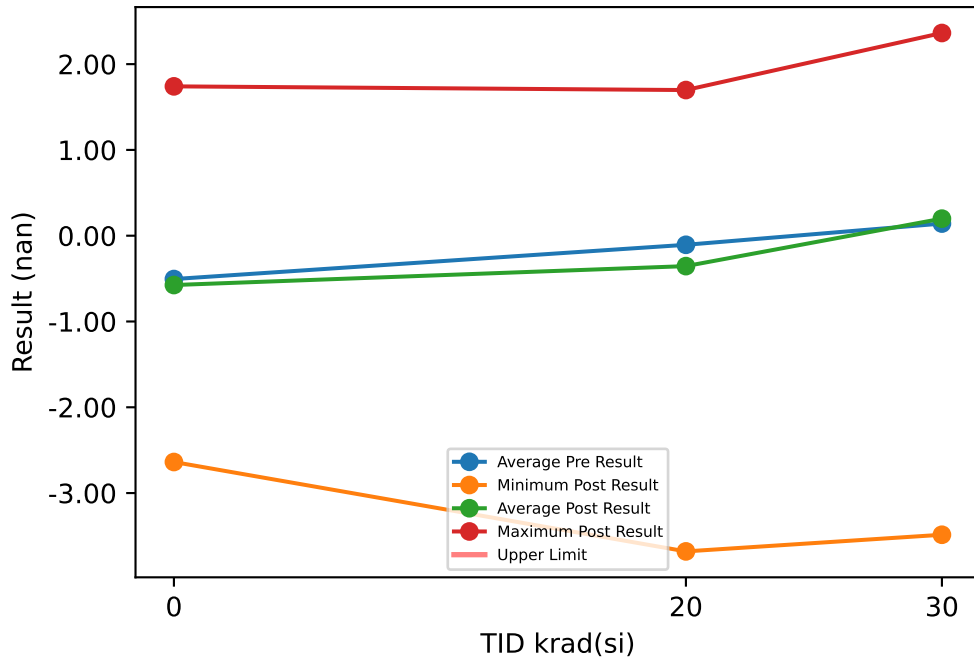

Test Results (No Limits Specified (nan))

Serial #	krad(si)	Exposure Conditions	Pre Result	Post Result	Delta
50	20	LDR biased	-0.811	-1.468	-0.657
51	20	LDR biased	1.59	0.207	-1.383
52	20	LDR biased	-0.93	-1.792	-0.862
53	20	LDR biased	-0.315	1.028	1.343
54	20	LDR biased	0.623	1.698	1.075
55	30	LDR biased	1.411	-0.494	-1.905
56	30	LDR biased	-3.65	-3.486	0.164
57	30	LDR biased	-0.556	1.411	1.967
58	30	LDR biased	0.696	-0.243	-0.939
59	30	LDR biased	0.689	2.234	1.545
60	20	LDR unbiased	-2.7	-3.68	-0.98
61	20	LDR unbiased	0.202	0.13	-0.072
62	20	LDR unbiased	-0.838	-1.501	-0.663
63	20	LDR unbiased	0.806	0.774	-0.032
64	20	LDR unbiased	1.313	1.059	-0.254
65	30	LDR unbiased	-1.172	-0.181	0.991
66	30	LDR unbiased	-0.008	0.31	0.318
67	30	LDR unbiased	2.831	2.363	-0.468
68	30	LDR unbiased	-0.54	-1.561	-1.021
69	30	LDR unbiased	1.715	1.635	-0.08
70	0	correlation	0.308	-0.227	-0.535
71	0	correlation	1.543	1.741	0.198
72	0	correlation	-2.743	-2.638	0.105
73	0	correlation	-1.023	-0.974	0.049
74	0	correlation	-0.611	-0.777	-0.166

TID vs Post - Pre Exposure Delta

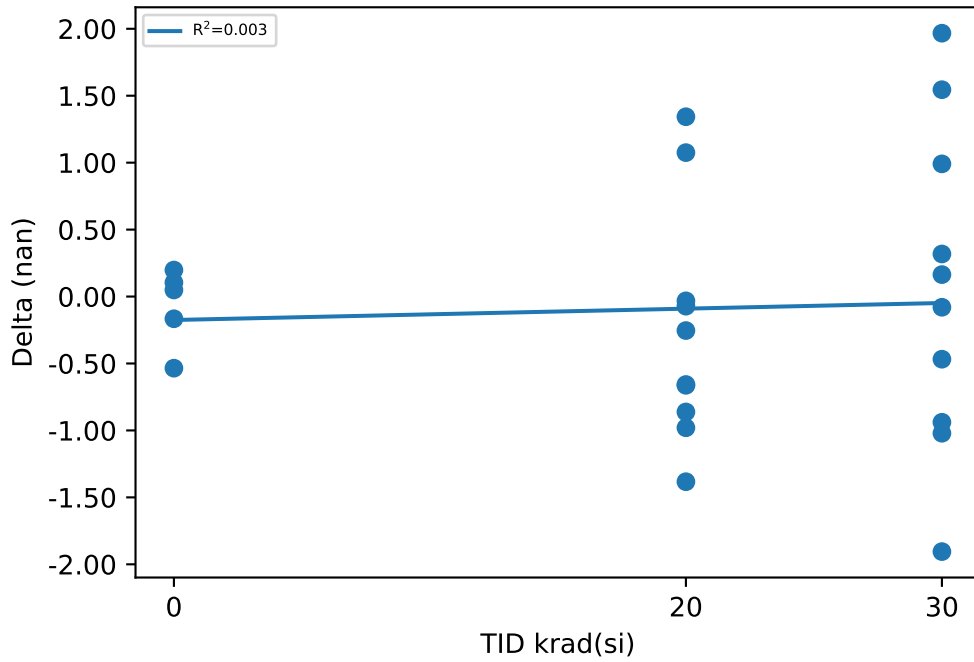

Test Statistics (nan)

krad(si)	Pre Exposure Min	Pre Exposure Avg	Pre Exposure Max	Pre Exposure Std	Post Exposure Min	Post Exposure Avg	Post Exposure Max	Post Exposure Std	Min Delta	Avg Delta	Max Delta	Std Delta
0	-2.743	-0.5052	1.543	1.5924	-2.638	-0.575	1.741	1.5765	-0.535	-0.0698	0.198	0.29243
20	-2.7	-0.106	1.59	1.2838	-3.68	-0.3545	1.698	1.6874	-1.383	-0.2485	1.343	0.87558
30	-3.65	0.1416	2.831	1.7951	-3.486	0.1988	2.363	1.8216	-1.905	0.0572	1.967	1.207

Device Test: 11.12 UJ2PYL(Delta_dCLR_P5A_CH2CH3_UJ2PYL)

TID vs Result Stats

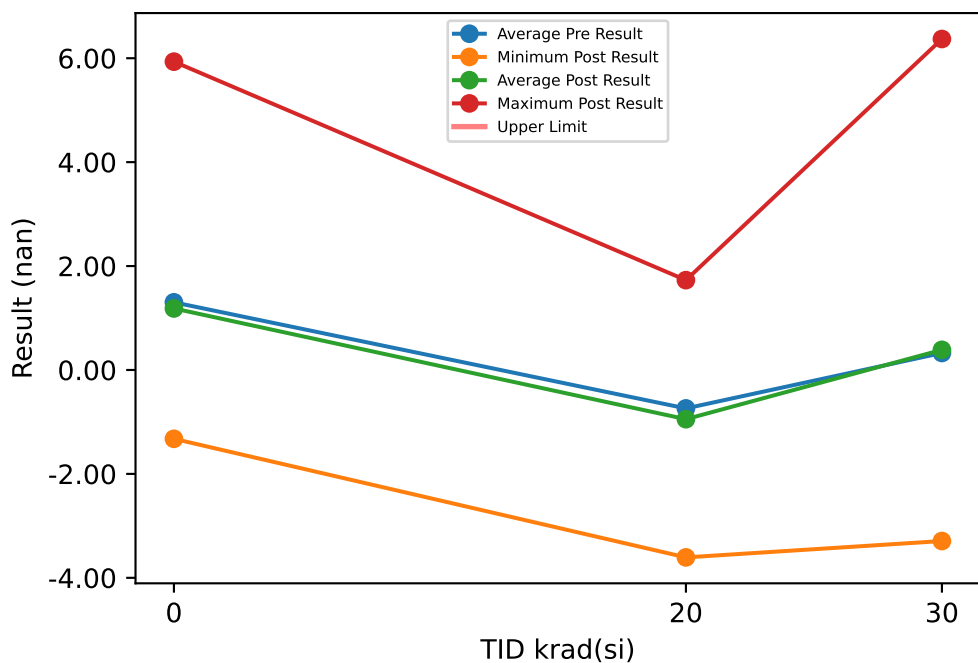

Test Results (No Limits Specified (nan))

Serial #	krad(si)	Exposure Conditions	Pre Result	Post Result	Delta
50	20	LDR biased	-3.092	-3.607	-0.515
51	20	LDR biased	-2.927	-2.793	0.134
52	20	LDR biased	-0.327	-1.415	-1.088
53	20	LDR biased	0.467	0.345	-0.122
54	20	LDR biased	0.101	-0.094	-0.195
55	30	LDR biased	-1.194	-1.159	0.035
56	30	LDR biased	-1.444	-0.36	1.084
57	30	LDR biased	1.042	0.752	-0.29
58	30	LDR biased	4.218	5.033	0.815
59	30	LDR biased	-3.659	-3.292	0.367
60	20	LDR unbiased	-1.278	-2.043	-0.765
61	20	LDR unbiased	-1.322	-0.605	0.717
62	20	LDR unbiased	1.224	1.729	0.505
63	20	LDR unbiased	-0.2	-0.525	-0.325
64	20	LDR unbiased	-0.043	-0.465	-0.422
65	30	LDR unbiased	1.923	0.81	-1.113
66	30	LDR unbiased	5.5	6.37	0.87
67	30	LDR unbiased	-1.818	-2.818	-1
68	30	LDR unbiased	-0.816	-0.322	0.494
69	30	LDR unbiased	-0.479	-1.138	-0.659
70	0	correlation	0.747	0.699	-0.048
71	0	correlation	0.59	0.577	-0.013
72	0	correlation	0.036	0.035	-0.001
73	0	correlation	6.357	5.934	-0.423
74	0	correlation	-1.219	-1.325	-0.106

TID vs Post - Pre Exposure Delta

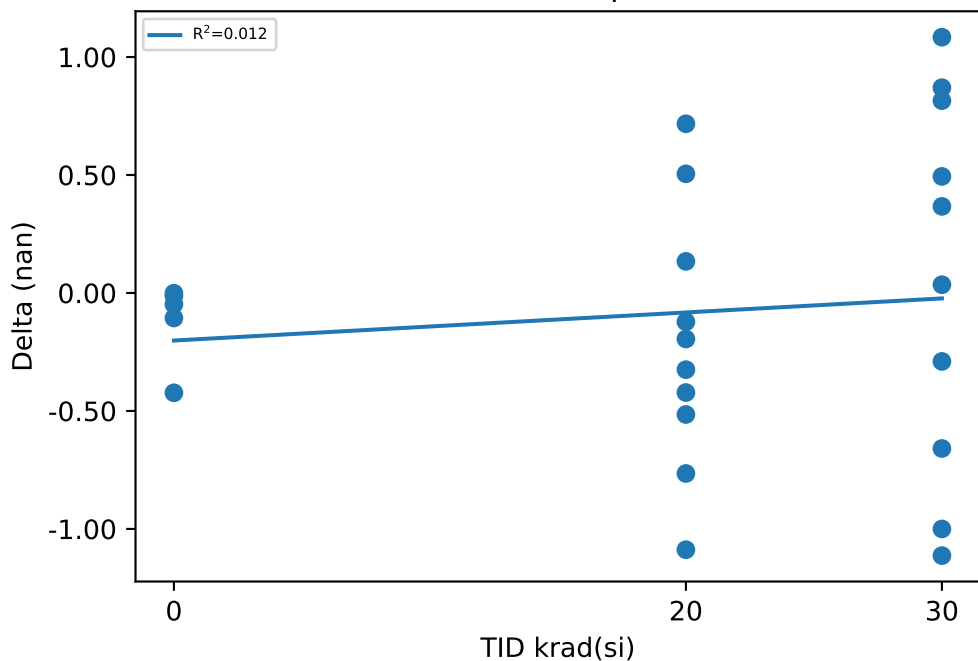

Test Statistics (nan)

krad(si)	Pre Exposure Min	Pre Exposure Avg	Pre Exposure Max	Pre Exposure Std	Post Exposure Min	Post Exposure Avg	Post Exposure Max	Post Exposure Std	Min Delta	Avg Delta	Max Delta	Std Delta
0	-1.219	1.3022	6.357	2.9294	-1.325	1.184	5.934	2.7741	-0.423	-0.1182	-0.001	0.1752
20	-3.092	-0.7397	1.224	1.4108	-3.607	-0.9473	1.729	1.5631	-1.088	-0.2076	0.717	0.55044
30	-3.659	0.3273	5.5	2.8451	-3.292	0.3876	6.37	3.1141	-1.113	0.0603	1.084	0.79561

Device Test: 11.15 UJET8J(KCL_P25A_CH1_UJET8J)

TID vs Result Stats

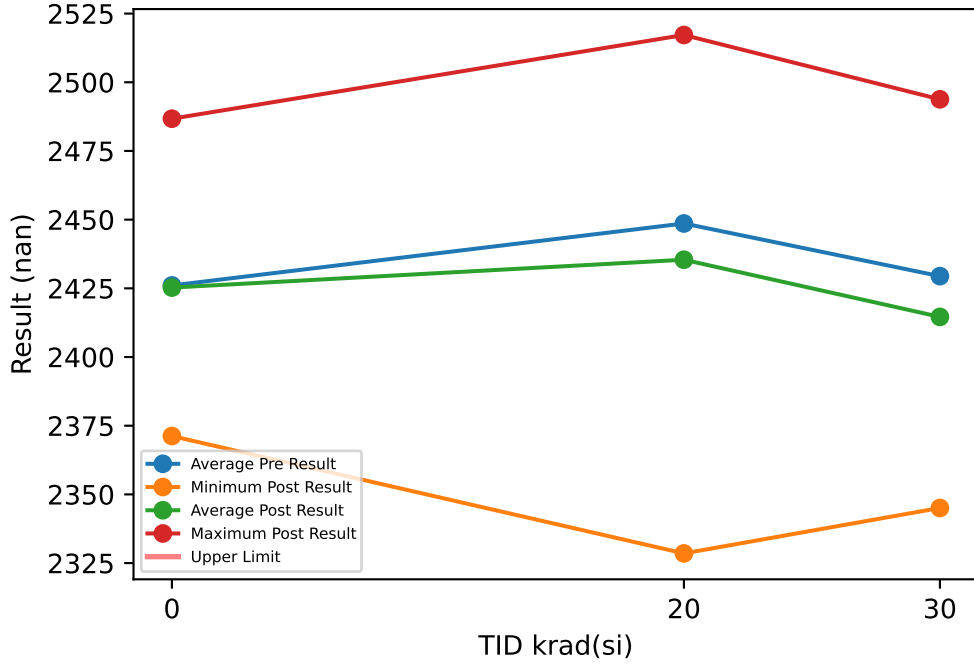

Test Results (No Limits Specified (nan))

Serial #	krad(si)	Exposure Conditions	Pre Result	Post Result	Delta
50	20	LDR biased	2469.2	2404.9	-64.242
51	20	LDR biased	2496	2481.1	-14.905
52	20	LDR biased	2393.2	2328.5	-64.709
53	20	LDR biased	2439.8	2455.8	15.982
54	20	LDR biased	2461.1	2492.7	31.574
55	30	LDR biased	2460.7	2423.6	-37.088
56	30	LDR biased	2371.3	2345.1	-26.202
57	30	LDR biased	2445.7	2493.8	48.139
58	30	LDR biased	2476.6	2417.6	-58.957
59	30	LDR biased	2404.9	2403.3	-1.576
60	20	LDR unbiased	2432.8	2421.1	-11.748
61	20	LDR unbiased	2379.7	2383.8	4.162
62	20	LDR unbiased	2504.7	2486.2	-18.512
63	20	LDR unbiased	2388.4	2382.7	-5.74
64	20	LDR unbiased	2521.1	2517.2	-3.851
65	30	LDR unbiased	2442.3	2461.1	18.778
66	30	LDR unbiased	2410.1	2374	-36.037
67	30	LDR unbiased	2442.6	2430.6	-12.047
68	30	LDR unbiased	2416.6	2383.6	-32.988
69	30	LDR unbiased	2423.7	2413.4	-10.358
70	0	correlation	2388	2377.6	-10.403
71	0	correlation	2485.4	2486.7	1.299
72	0	correlation	2414.2	2416.1	1.92
73	0	correlation	2472.8	2474.6	1.75
74	0	correlation	2369.8	2371.2	1.472

TID vs Post - Pre Exposure Delta

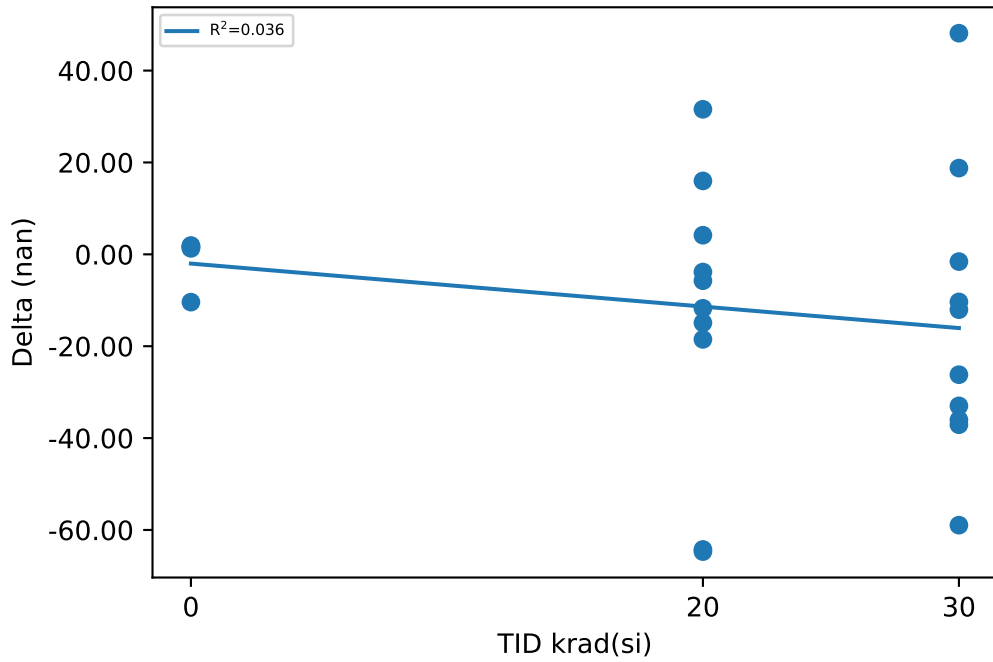

Test Statistics (nan)

krad(si)	Pre Exposure Min	Pre Exposure Avg	Pre Exposure Max	Pre Exposure Std	Post Exposure Min	Post Exposure Avg	Post Exposure Max	Post Exposure Std	Min Delta	Avg Delta	Max Delta	Std Delta
0	2369.8	2426.1	2485.4	51.158	2371.2	2425.3	2486.7	53.577	-10.403	-0.7924	1.92	5.3779
20	2379.7	2448.6	2521.1	50.553	2328.5	2435.4	2517.2	60.615	-64.709	-13.199	31.574	30.899
30	2371.3	2429.4	2476.6	30.481	2345.1	2414.6	2493.8	42.622	-58.957	-14.834	48.139	31.001

Device Test: 11.16 UJET8J(KCL_P5A_CH1_UJET8J)

TID vs Result Stats

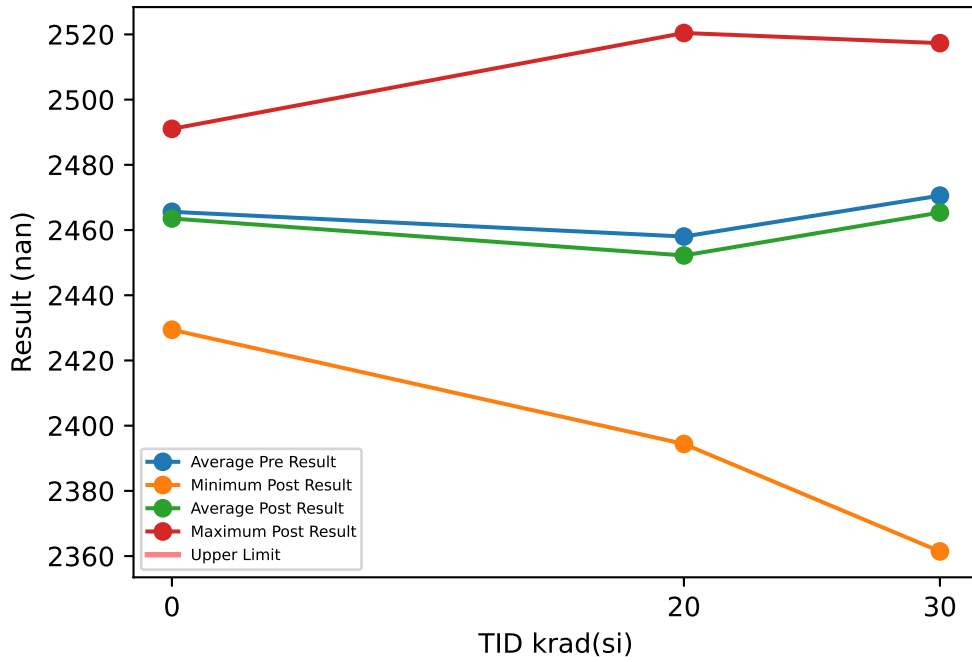

Test Results (No Limits Specified (nan))

Serial #	krad(si)	Exposure Conditions	Pre Result	Post Result	Delta
50	20	LDR biased	2466	2434.7	-31.353
51	20	LDR biased	2527.3	2520.4	-6.873
52	20	LDR biased	2425.5	2394.4	-31.051
53	20	LDR biased	2434.8	2443.1	8.327
54	20	LDR biased	2459.7	2476.6	16.836
55	30	LDR biased	2482.5	2465.8	-16.696
56	30	LDR biased	2372.4	2361.4	-10.915
57	30	LDR biased	2450.4	2478.5	28.079
58	30	LDR biased	2501	2468.2	-32.836
59	30	LDR biased	2504.7	2508	3.264
60	20	LDR unbiased	2427.6	2421.6	-6.018
61	20	LDR unbiased	2428.4	2430	1.648
62	20	LDR unbiased	2493.7	2486.1	-7.625
63	20	LDR unbiased	2426.7	2422.8	-3.844
64	20	LDR unbiased	2490.5	2492.4	1.911
65	30	LDR unbiased	2506.6	2517.3	10.76
66	30	LDR unbiased	2472.7	2457.8	-14.916
67	30	LDR unbiased	2515.8	2510.5	-5.37
68	30	LDR unbiased	2431.2	2418.1	-13.053
69	30	LDR unbiased	2468.3	2468	-0.292
70	0	correlation	2483.2	2472	-11.218
71	0	correlation	2490.7	2491	0.344
72	0	correlation	2432.1	2434.4	2.309
73	0	correlation	2489.9	2490.9	1.009
74	0	correlation	2432.1	2429.4	-2.702

TID vs Post - Pre Exposure Delta

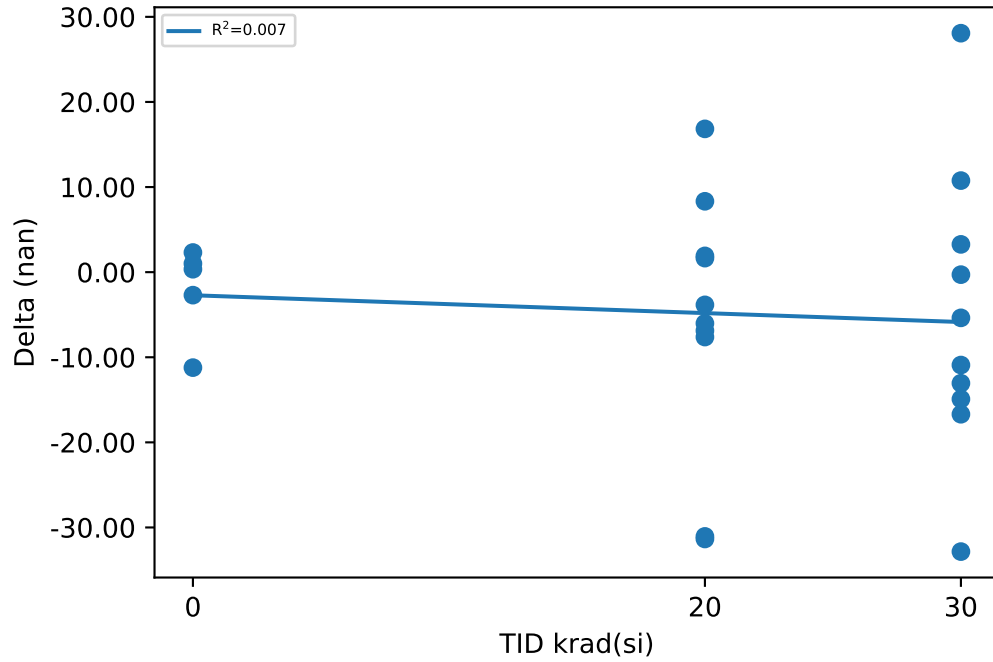

Test Statistics (nan)

krad(si)	Pre Exposure Min	Pre Exposure Avg	Pre Exposure Max	Pre Exposure Std	Post Exposure Min	Post Exposure Avg	Post Exposure Max	Post Exposure Std	Min Delta	Avg Delta	Max Delta	Std Delta
0	2432.1	2465.6	2490.7	30.706	2429.4	2463.5	2491	29.949	-11.218	-2.0516	2.309	5.4444
20	2425.5	2458	2527.3	35.879	2394.4	2452.2	2520.4	39.497	-31.353	-5.8042	16.836	15.369
30	2372.4	2470.6	2515.8	43.708	2361.4	2465.4	2517.3	46.934	-32.836	-5.1975	28.079	16.808

Device Test: 11.17 UJET8J(KCL_P25A_CH2_UJET8J)

TID vs Result Stats

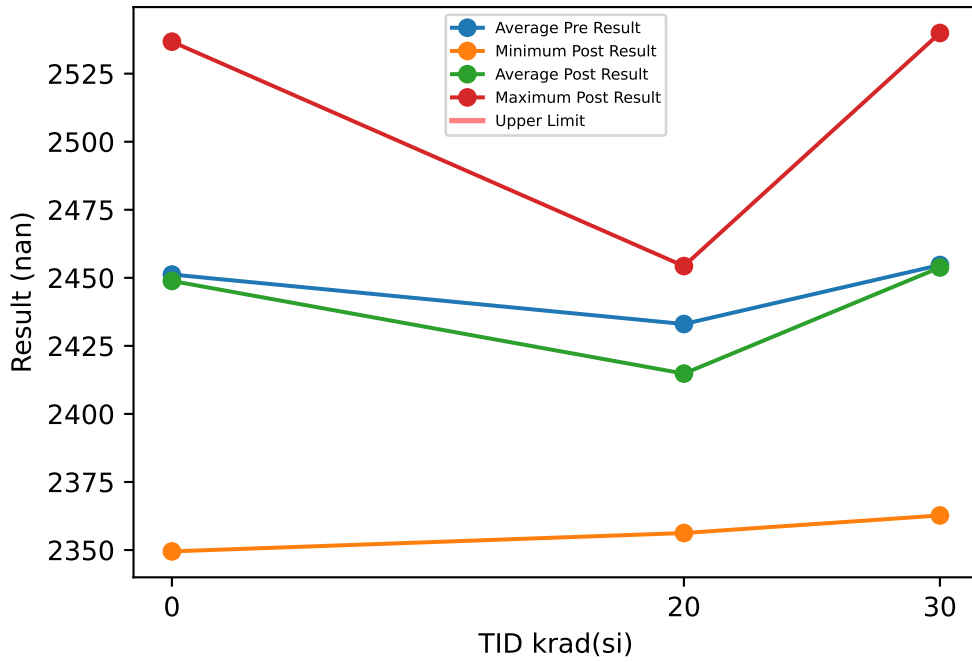

Test Results (No Limits Specified (nan))

Serial #	krad(si)	Exposure Conditions	Pre Result	Post Result	Delta
50	20	LDR biased	2449.6	2426.9	-22.726
51	20	LDR biased	2430.6	2425.9	-4.674
52	20	LDR biased	2464.6	2420.3	-44.311
53	20	LDR biased	2421.4	2420	-1.459
54	20	LDR biased	2386.7	2356.2	-30.467
55	30	LDR biased	2452.5	2413.8	-38.726
56	30	LDR biased	2408.9	2466.1	57.214
57	30	LDR biased	2487.8	2484.9	-2.936
58	30	LDR biased	2393.1	2412.7	19.567
59	30	LDR biased	2450.3	2458.1	7.806
60	20	LDR unbiased	2453.4	2391.1	-62.327
61	20	LDR unbiased	2425.6	2433.1	7.514
62	20	LDR unbiased	2454.1	2454.3	0.242
63	20	LDR unbiased	2455.6	2449.1	-6.45
64	20	LDR unbiased	2388.6	2371.2	-17.474
65	30	LDR unbiased	2452.5	2426.9	-25.591
66	30	LDR unbiased	2520.2	2534.6	14.388
67	30	LDR unbiased	2409.4	2362.7	-46.661
68	30	LDR unbiased	2508.6	2539.9	31.294
69	30	LDR unbiased	2463.8	2438.2	-25.539
70	0	correlation	2540.6	2536.8	-3.836
71	0	correlation	2471.7	2469.1	-2.562
72	0	correlation	2422.6	2423.6	0.971
73	0	correlation	2473	2465.3	-7.66
74	0	correlation	2348.2	2349.5	1.276

TID vs Post - Pre Exposure Delta

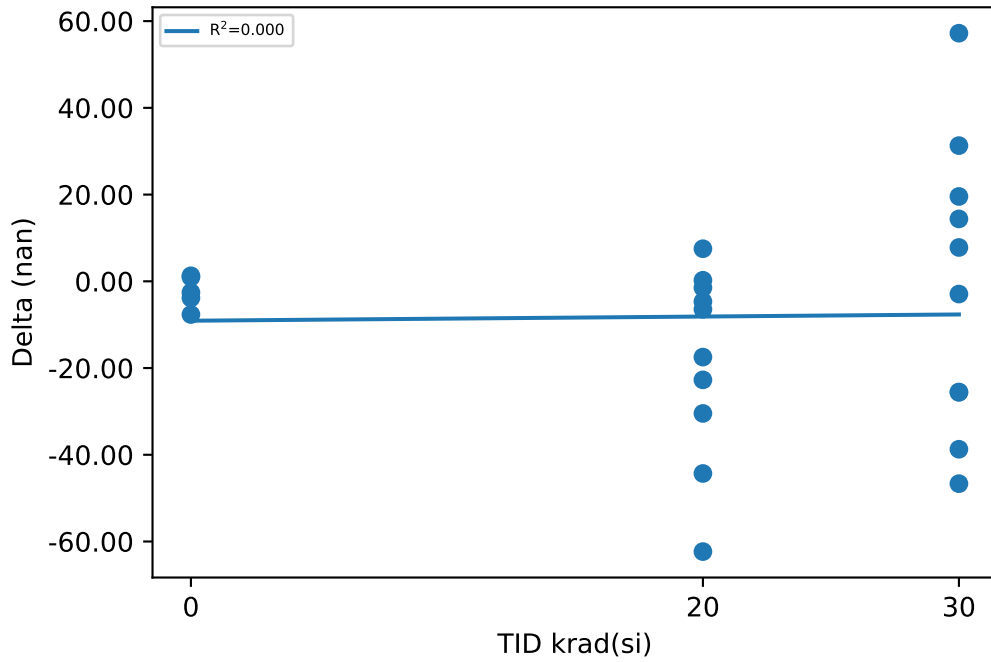

Test Statistics (nan)

krad(si)	Pre Exposure Min	Pre Exposure Avg	Pre Exposure Max	Pre Exposure Std	Post Exposure Min	Post Exposure Avg	Post Exposure Max	Post Exposure Std	Min Delta	Avg Delta	Max Delta	Std Delta
0	2348.2	2451.2	2540.6	71.25	2349.5	2448.9	2536.8	68.772	-7.66	-2.3622	1.276	3.6955
20	2386.7	2433	2464.6	27.789	2356.2	2414.8	2454.3	32.135	-62.327	-18.213	7.514	22.119
30	2393.1	2454.7	2520.2	42.624	2362.7	2453.8	2539.9	55.422	-46.661	-0.9184	57.214	33.146

Device Test: 11.18 UJET8J(KCL_P5A_CH2_UJET8J)

TID vs Result Stats

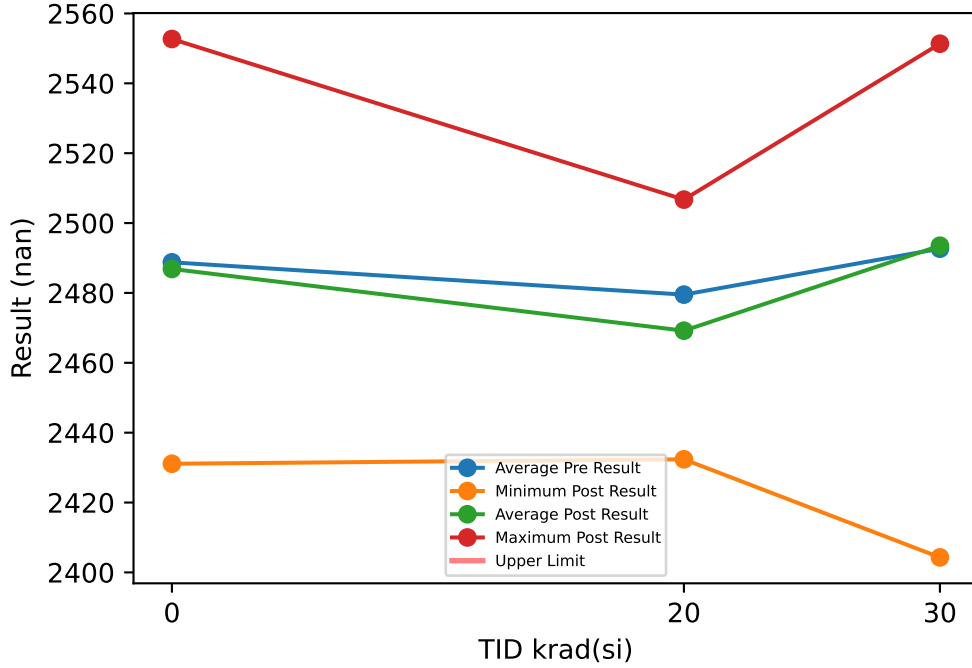

Test Results (No Limits Specified (nan))

Serial #	krad(si)	Exposure Conditions	Pre Result	Post Result	Delta
50	20	LDR biased	2486.1	2475.1	-11.035
51	20	LDR biased	2468.3	2467.9	-0.483
52	20	LDR biased	2497.9	2472.8	-25.097
53	20	LDR biased	2475.8	2471.6	-4.179
54	20	LDR biased	2450.7	2432.4	-18.367
55	30	LDR biased	2424.9	2404.3	-20.616
56	30	LDR biased	2488.8	2519.2	30.386
57	30	LDR biased	2525.8	2527	1.208
58	30	LDR biased	2509.2	2520.2	10.926
59	30	LDR biased	2436.5	2441.5	4.949
60	20	LDR unbiased	2480.3	2446.7	-33.581
61	20	LDR unbiased	2471.4	2473.4	2.027
62	20	LDR unbiased	2506.8	2506.7	-0.039
63	20	LDR unbiased	2475.6	2469.5	-6.164
64	20	LDR unbiased	2482.2	2475.9	-6.344
65	30	LDR unbiased	2538.3	2525.7	-12.588
66	30	LDR unbiased	2538.4	2551.3	12.914
67	30	LDR unbiased	2524	2500.4	-23.531
68	30	LDR unbiased	2472.7	2491.1	18.407
69	30	LDR unbiased	2468.1	2454.5	-13.625
70	0	correlation	2490.8	2491.3	0.508
71	0	correlation	2483.1	2483.1	0.082
72	0	correlation	2478.7	2476	-2.68
73	0	correlation	2561.5	2552.7	-8.769
74	0	correlation	2429.8	2431.1	1.336

TID vs Post - Pre Exposure Delta

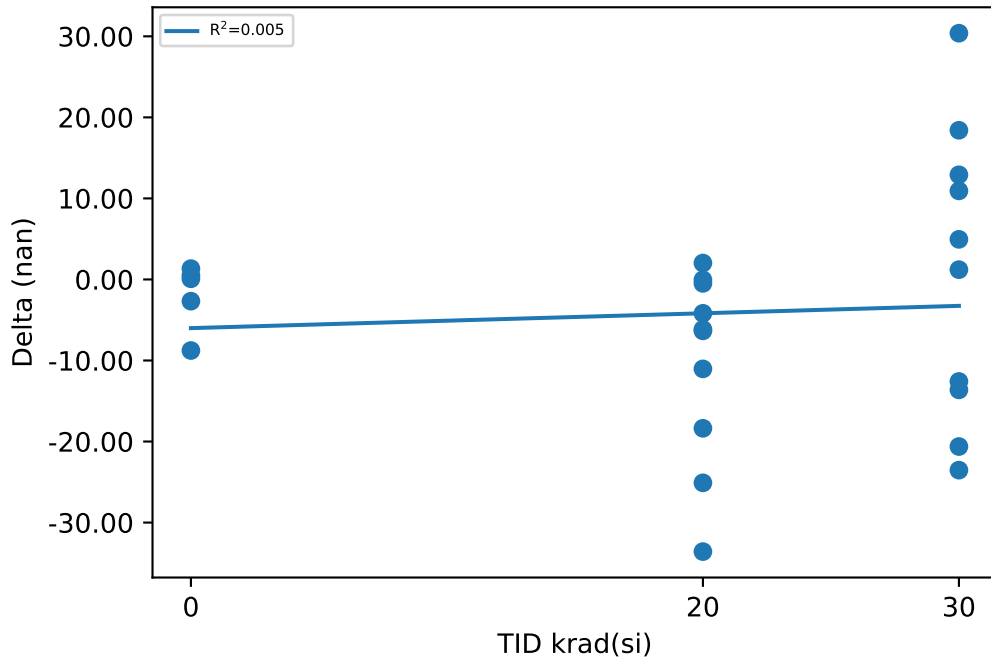

Test Statistics (nan)

krad(si)	Pre Exposure Min	Pre Exposure Avg	Pre Exposure Max	Pre Exposure Std	Post Exposure Min	Post Exposure Avg	Post Exposure Max	Post Exposure Std	Min Delta	Avg Delta	Max Delta	Std Delta
0	2429.8	2488.8	2561.5	47.177	2431.1	2486.9	2552.7	43.569	-8.769	-1.9046	1.336	4.1228
20	2450.7	2479.5	2506.8	15.56	2432.4	2469.2	2506.7	19.404	-33.581	-10.326	2.027	11.787
30	2424.9	2492.7	2538.4	41.217	2404.3	2493.5	2551.3	46.088	-23.531	0.843	30.386	17.919

Device Test: 11.19 UJET8J(KCL_P25A_CH3_UJET8J)

TID vs Result Stats

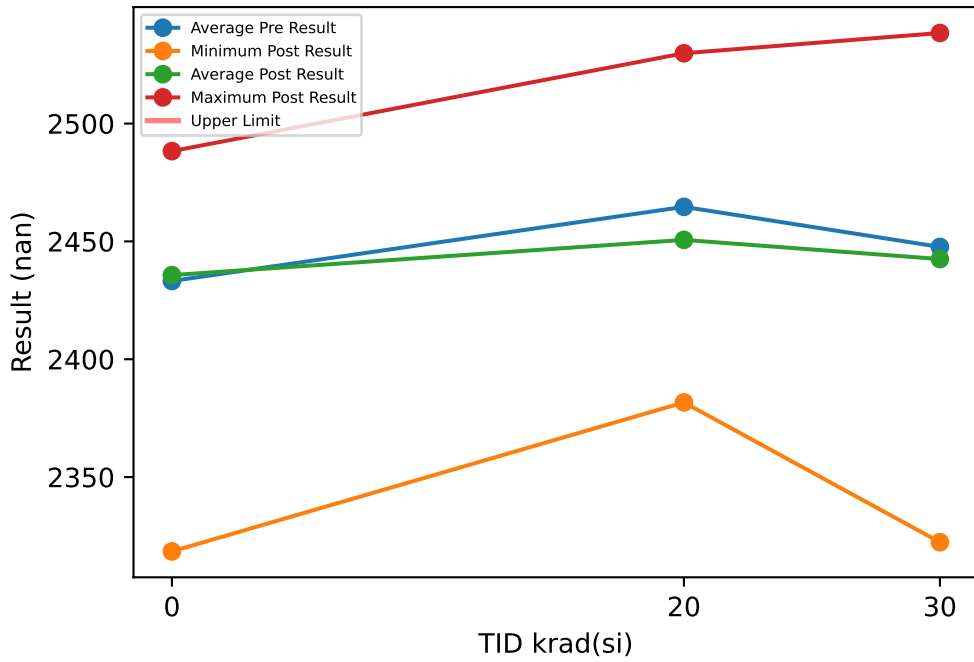

Test Results (No Limits Specified (nan))

Serial #	krad(si)	Exposure Conditions	Pre Result	Post Result	Delta
50	20	LDR biased	2524.1	2529.8	5.73
51	20	LDR biased	2522.7	2514.6	-8.128
52	20	LDR biased	2440.7	2446.9	6.162
53	20	LDR biased	2420.7	2414.9	-5.788
54	20	LDR biased	2429.4	2403.8	-25.609
55	30	LDR biased	2442.9	2399.6	-43.265
56	30	LDR biased	2531.7	2538.4	6.748
57	30	LDR biased	2463.7	2480.2	16.497
58	30	LDR biased	2393.4	2371	-22.344
59	30	LDR biased	2447.9	2438.5	-9.338
60	20	LDR unbiased	2522	2483.9	-38.14
61	20	LDR unbiased	2416.4	2381.7	-34.744
62	20	LDR unbiased	2466.4	2429.1	-37.338
63	20	LDR unbiased	2464.1	2465.8	1.711
64	20	LDR unbiased	2440	2436	-3.982
65	30	LDR unbiased	2453.6	2480.1	26.439
66	30	LDR unbiased	2352.8	2322.4	-30.425
67	30	LDR unbiased	2528.6	2528.4	-0.232
68	30	LDR unbiased	2431.6	2445.6	14.013
69	30	LDR unbiased	2430.5	2420.8	-9.663
70	0	correlation	2452.7	2455.8	3.155
71	0	correlation	2470.4	2468.4	-1.987
72	0	correlation	2485.2	2488.3	3.123
73	0	correlation	2316.8	2318.5	1.697
74	0	correlation	2441	2447.4	6.489

TID vs Post - Pre Exposure Delta

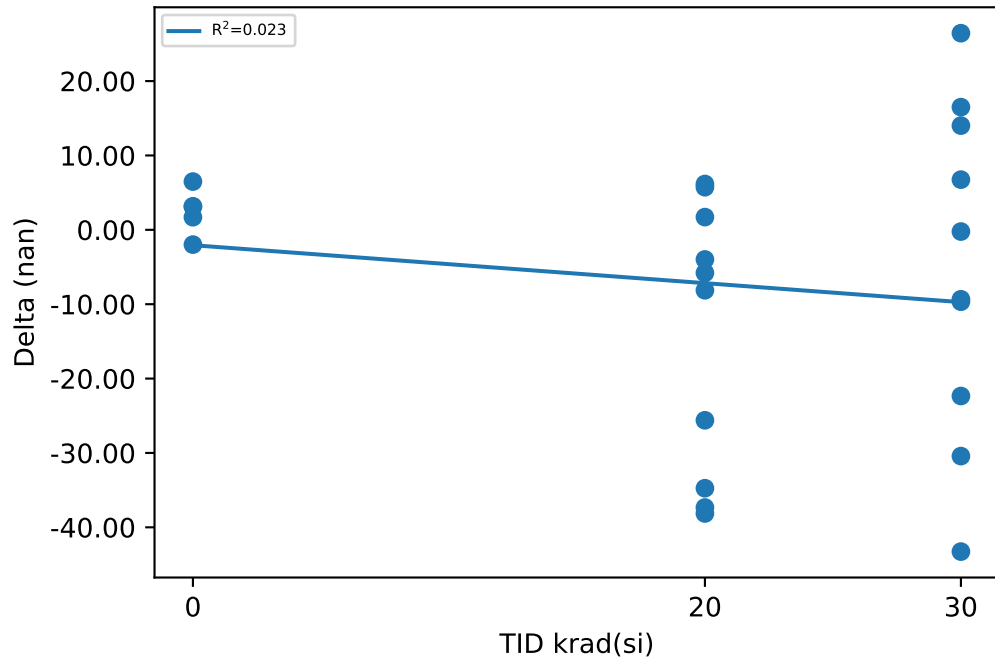

Test Statistics (nan)

krad(si)	Pre Exposure Min	Pre Exposure Avg	Pre Exposure Max	Pre Exposure Std	Post Exposure Min	Post Exposure Avg	Post Exposure Max	Post Exposure Std	Min Delta	Avg Delta	Max Delta	Std Delta
0	2316.8	2433.2	2485.2	67.236	2318.5	2435.7	2488.3	67.315	-1.987	2.4954	6.489	3.0622
20	2416.4	2464.7	2524.1	43.301	2381.7	2450.6	2529.8	47.855	-38.14	-14.013	6.162	18.066
30	2352.8	2447.7	2531.7	54.19	2322.4	2442.5	2538.4	67.729	-43.265	-5.157	26.439	22.172

Device Test: 11.2 UJSYNT(dCLR_P5A_CH1_UJSYNT)

TID vs Result Stats

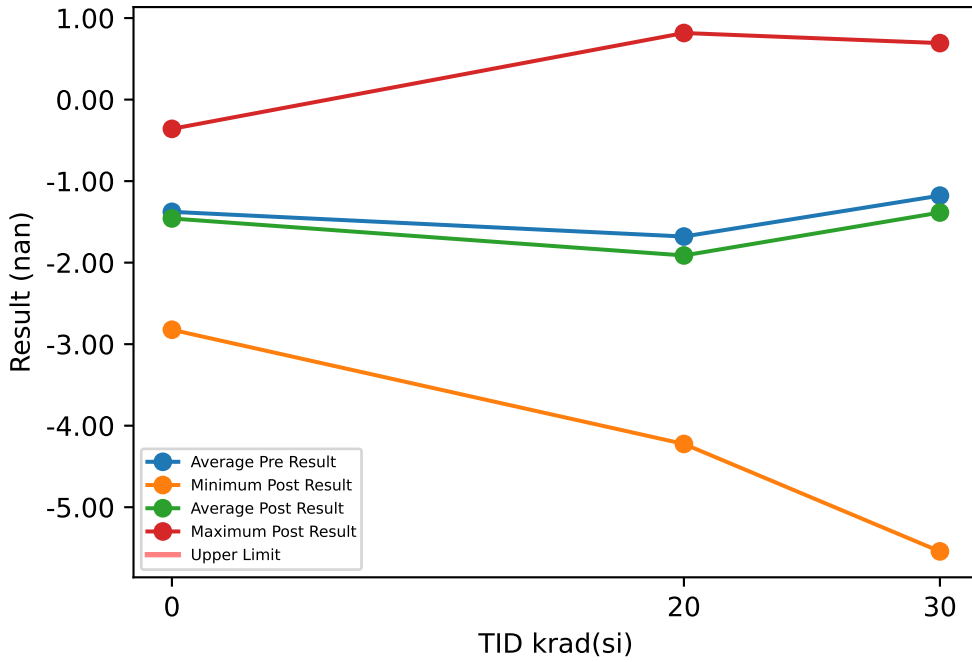

Test Results (No Limits Specified (nan))

Serial #	krad(si)	Exposure Conditions	Pre Result	Post Result	Delta
50	20	LDR biased	-1.36	-2.614	-1.254
51	20	LDR biased	1.092	0.817	-0.275
52	20	LDR biased	-2.982	-4.224	-1.242
53	20	LDR biased	-2.609	-2.276	0.333
54	20	LDR biased	-1.61	-0.937	0.673
55	30	LDR biased	-0.7	-1.368	-0.668
56	30	LDR biased	-5.106	-5.542	-0.436
57	30	LDR biased	-1.983	-0.86	1.123
58	30	LDR biased	0.041	-1.272	-1.313
59	30	LDR biased	0.188	0.318	0.13
60	20	LDR unbiased	-2.897	-3.138	-0.241
61	20	LDR unbiased	-2.865	-2.799	0.066
62	20	LDR unbiased	-0.253	-0.558	-0.305
63	20	LDR unbiased	-2.934	-3.087	-0.153
64	20	LDR unbiased	-0.379	-0.302	0.077
65	30	LDR unbiased	0.262	0.693	0.431
66	30	LDR unbiased	-1.09	-1.687	-0.597
67	30	LDR unbiased	0.634	0.419	-0.215
68	30	LDR unbiased	-2.753	-3.275	-0.522
69	30	LDR unbiased	-1.27	-1.281	-0.011
70	0	correlation	-0.673	-1.121	-0.448
71	0	correlation	-0.373	-0.359	0.014
72	0	correlation	-2.717	-2.624	0.093
73	0	correlation	-0.405	-0.364	0.041
74	0	correlation	-2.715	-2.823	-0.108

TID vs Post - Pre Exposure Delta

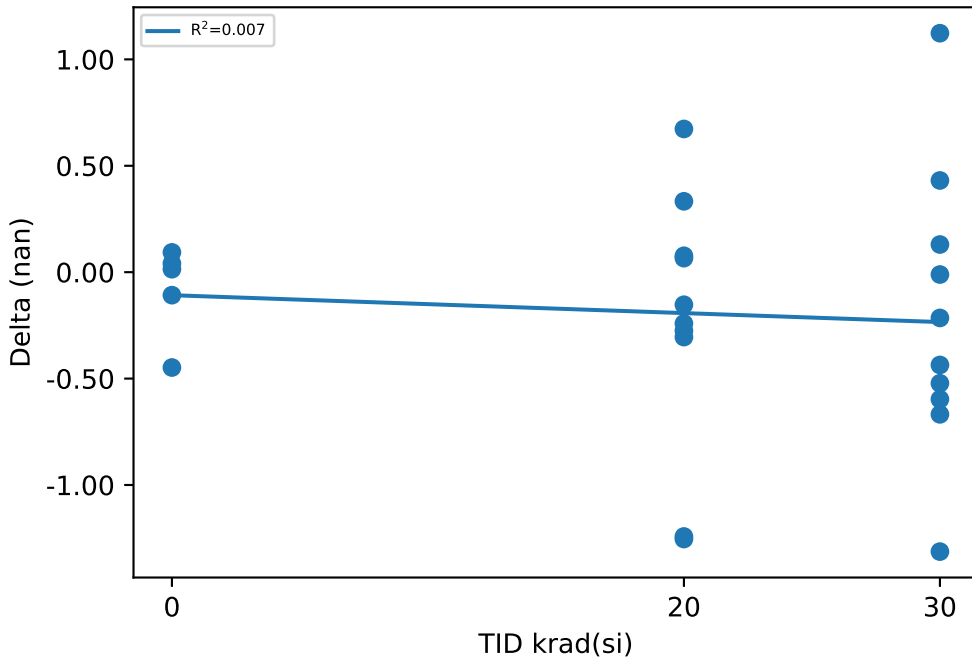

Test Statistics (nan)

krad(si)	Pre Exposure Min	Pre Exposure Avg	Pre Exposure Max	Pre Exposure Std	Post Exposure Min	Post Exposure Avg	Post Exposure Max	Post Exposure Std	Min Delta	Avg Delta	Max Delta	Std Delta
0	-2.717	-1.3766	-0.373	1.2282	-2.823	-1.4582	-0.359	1.198	-0.448	-0.0816	0.093	0.21772
20	-2.982	-1.6797	1.092	1.4351	-4.224	-1.9118	0.817	1.5799	-1.254	-0.2321	0.673	0.61469
30	-5.106	-1.1777	0.634	1.7484	-5.542	-1.3855	0.693	1.8772	-1.313	-0.2078	1.123	0.67227

Device Test: 11.20 UJET8J(KCL_P5A_CH3_UJET8J)

TID vs Result Stats

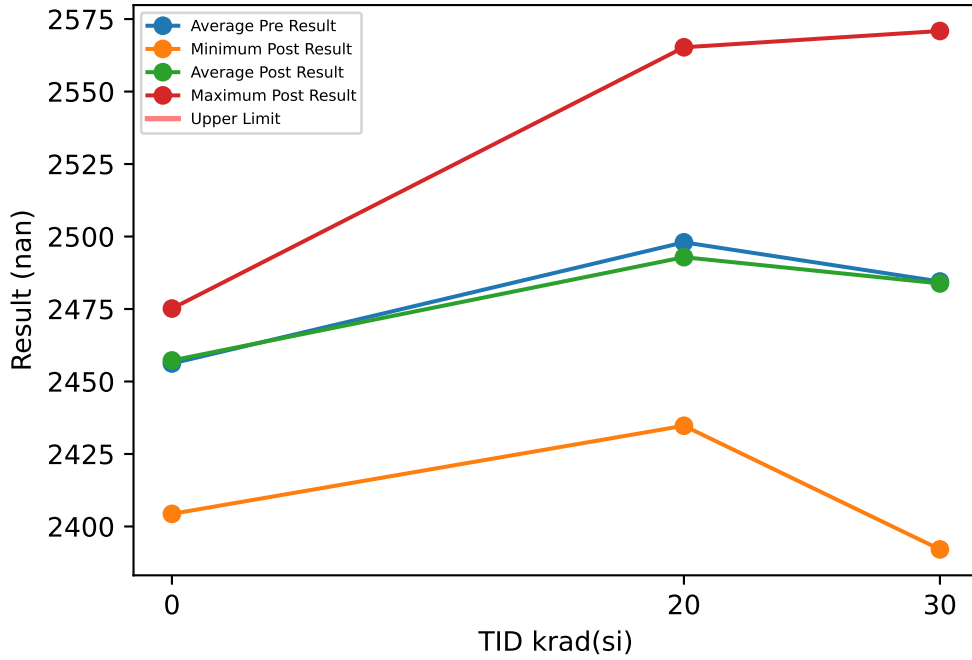

Test Results (No Limits Specified (nan))

Serial #	krad(si)	Exposure Conditions	Pre Result	Post Result	Delta
50	20	LDR biased	2563.4	2565.3	1.856
51	20	LDR biased	2541.5	2537.7	-3.85
52	20	LDR biased	2506.1	2508.2	2.124
53	20	LDR biased	2464.1	2463	-1.119
54	20	LDR biased	2448.2	2434.7	-13.481
55	30	LDR biased	2454.8	2433.3	-21.495
56	30	LDR biased	2524.9	2528.2	3.298
57	30	LDR biased	2499.7	2508.2	8.439
58	30	LDR biased	2403.8	2394.3	-9.46
59	30	LDR biased	2528	2523.8	-4.225
60	20	LDR unbiased	2512.2	2497.8	-14.462
61	20	LDR unbiased	2504.5	2488.6	-15.883
62	20	LDR unbiased	2476.1	2463.5	-12.658
63	20	LDR unbiased	2480.6	2482.6	1.94
64	20	LDR unbiased	2483.3	2487.5	4.212
65	30	LDR unbiased	2490.2	2505.4	15.229
66	30	LDR unbiased	2400.9	2392.1	-8.832
67	30	LDR unbiased	2569.4	2570.9	1.472
68	30	LDR unbiased	2493.1	2499.1	6.059
69	30	LDR unbiased	2480.1	2482.9	2.841
70	0	correlation	2472.1	2473.9	1.707
71	0	correlation	2468.3	2468.7	0.412
72	0	correlation	2477.8	2475.2	-2.666
73	0	correlation	2402.5	2404.3	1.809
74	0	correlation	2460.3	2464.2	3.976

TID vs Post - Pre Exposure Delta

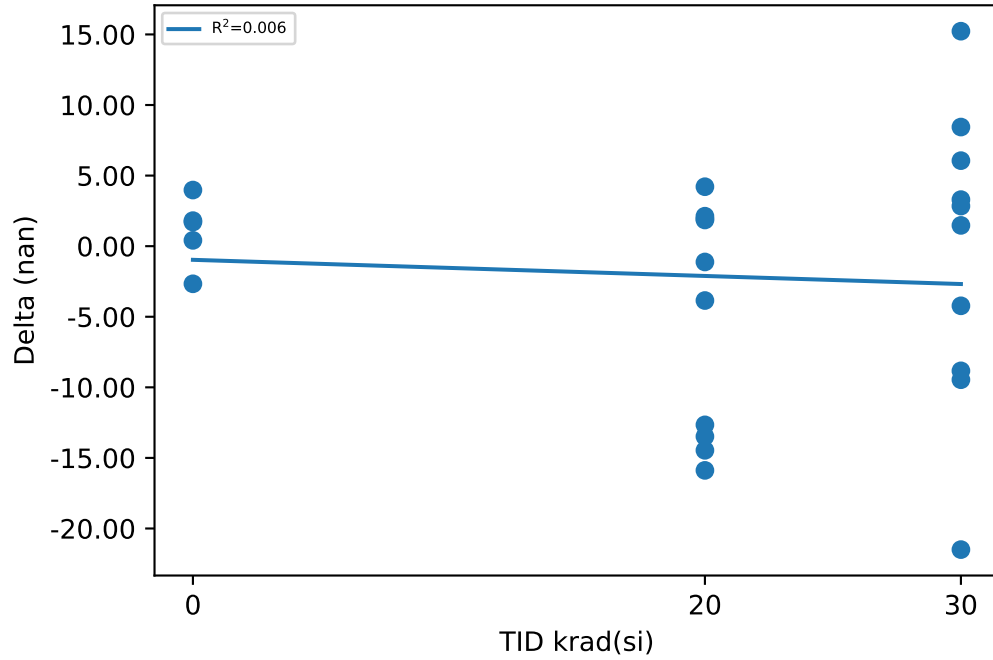

Test Statistics (nan)

krad(si)	Pre Exposure Min	Pre Exposure Avg	Pre Exposure Max	Pre Exposure Std	Post Exposure Min	Post Exposure Avg	Post Exposure Max	Post Exposure Std	Min Delta	Avg Delta	Max Delta	Std Delta
0	2402.5	2456.2	2477.8	30.68	2404.3	2457.3	2475.2	29.899	-2.666	1.0476	3.976	2.4385
20	2448.2	2498	2563.4	35.125	2434.7	2492.9	2565.3	37.707	-15.883	-5.1321	4.212	8.0659
30	2400.9	2484.5	2569.4	53.203	2392.1	2483.8	2570.9	59.085	-21.495	-0.6674	15.229	10.561

Device Test: 11.21 UJET8J(KCL_P25A_CH4_UJET8J)

TID vs Result Stats

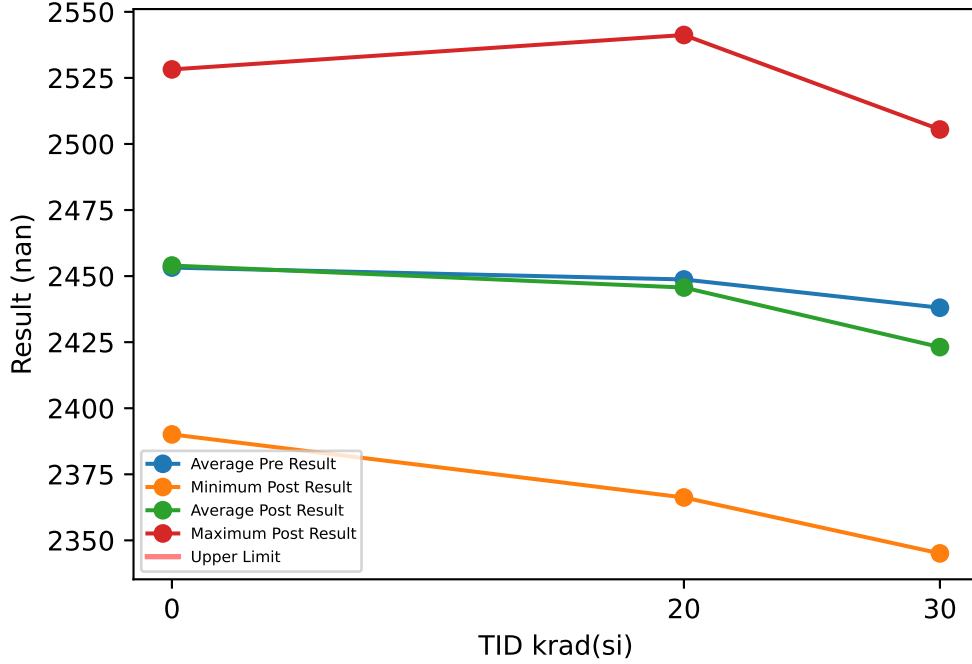

Test Results (No Limits Specified (nan))

Serial #	krad(si)	Exposure Conditions	Pre Result	Post Result	Delta
50	20	LDR biased	2436.2	2409	-27.197
51	20	LDR biased	2477.2	2525.8	48.575
52	20	LDR biased	2447.8	2424.2	-23.512
53	20	LDR biased	2438.3	2380.2	-58.148
54	20	LDR biased	2433	2409.6	-23.411
55	30	LDR biased	2452.6	2505.5	52.864
56	30	LDR biased	2496.8	2471.8	-25.052
57	30	LDR biased	2420.4	2377.5	-42.829
58	30	LDR biased	2443.9	2427.5	-16.423
59	30	LDR biased	2453.6	2383.1	-70.468
60	20	LDR unbiased	2473.1	2502.8	29.696
61	20	LDR unbiased	2460.7	2463.5	2.788
62	20	LDR unbiased	2524	2541.2	17.215
63	20	LDR unbiased	2438.3	2434.2	-4.083
64	20	LDR unbiased	2358.8	2366.2	7.426
65	30	LDR unbiased	2511.4	2487.2	-24.264
66	30	LDR unbiased	2390.7	2345.1	-45.609
67	30	LDR unbiased	2443.1	2449.8	6.619
68	30	LDR unbiased	2377.8	2393.6	15.799
69	30	LDR unbiased	2390	2390.4	0.354
70	0	correlation	2394.4	2393.9	-0.481
71	0	correlation	2473	2471	-2.094
72	0	correlation	2485.5	2486.8	1.38
73	0	correlation	2529.8	2528.2	-1.612
74	0	correlation	2383.4	2390.1	6.731

TID vs Post - Pre Exposure Delta

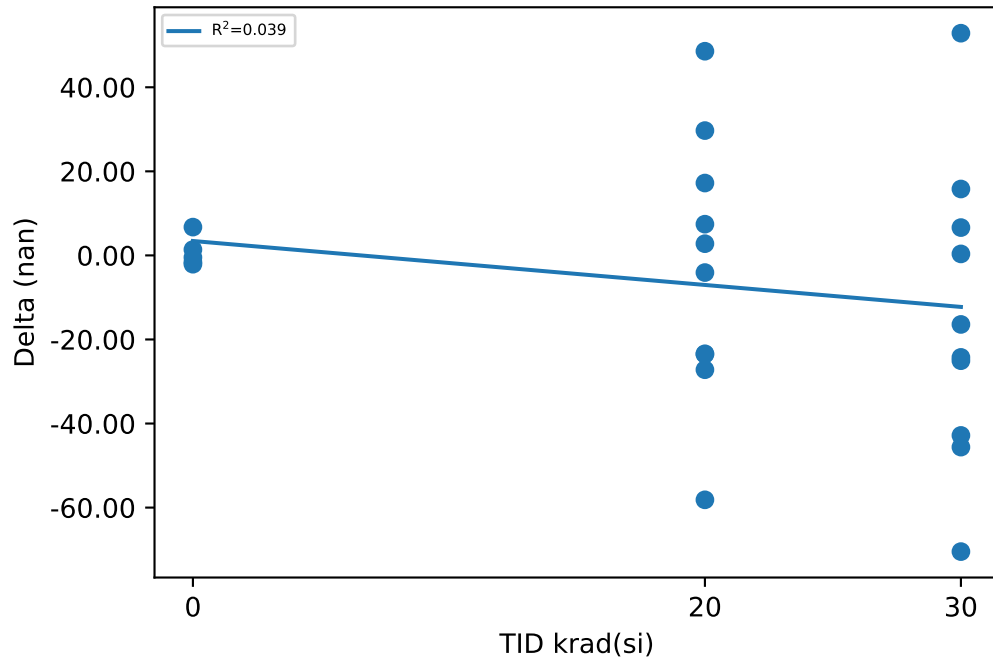

Test Statistics (nan)

krad(si)	Pre Exposure Min	Pre Exposure Avg	Pre Exposure Max	Pre Exposure Std	Post Exposure Min	Post Exposure Avg	Post Exposure Max	Post Exposure Std	Min Delta	Avg Delta	Max Delta	Std Delta
0	2383.4	2453.2	2529.8	62.525	2390.1	2454	2528.2	60.341	-2.094	0.7848	6.731	3.5828
20	2358.8	2448.7	2524	42.063	2366.2	2445.7	2541.2	60.519	-58.148	-3.0651	48.575	31.172
30	2377.8	2438	2511.4	44.543	2345.1	2423.1	2505.5	53.436	-70.468	-14.901	52.864	35.33

Device Test: 11.22 UJET8J(KCL_P5A_CH4_UJET8J)

TID vs Result Stats

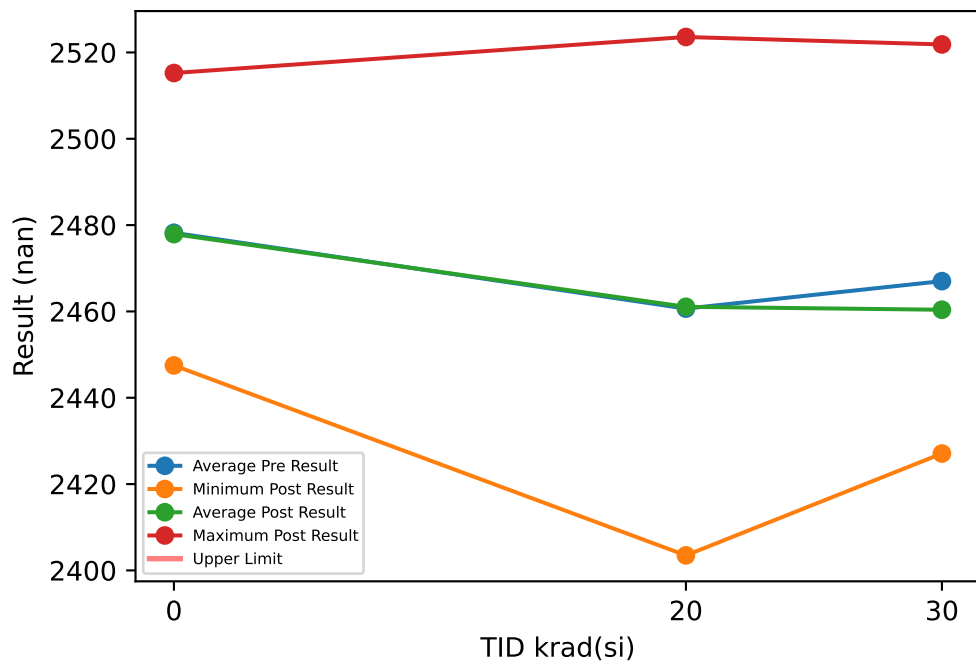

Test Results (No Limits Specified (nan))

Serial #	krad(si)	Exposure Conditions	Pre Result	Post Result	Delta
50	20	LDR biased	2486.3	2471.4	-14.927
51	20	LDR biased	2487.5	2515.3	27.707
52	20	LDR biased	2448.7	2439.2	-9.495
53	20	LDR biased	2442.7	2417.4	-25.247
54	20	LDR biased	2444.2	2434.1	-10.034
55	30	LDR biased	2447.2	2478.2	30.931
56	30	LDR biased	2463.6	2448.6	-15.016
57	30	LDR biased	2464.3	2443.2	-21.091
58	30	LDR biased	2483.6	2474.3	-9.351
59	30	LDR biased	2487.5	2452.1	-35.36
60	20	LDR unbiased	2495.1	2513.6	18.491
61	20	LDR unbiased	2423.3	2426.8	3.462
62	20	LDR unbiased	2514.6	2523.6	8.954
63	20	LDR unbiased	2406.5	2403.5	-3.033
64	20	LDR unbiased	2457.7	2466	8.258
65	30	LDR unbiased	2535.9	2521.9	-14.005
66	30	LDR unbiased	2472.9	2450.1	-22.886
67	30	LDR unbiased	2445.1	2451.4	6.349
68	30	LDR unbiased	2444.7	2457.1	12.468
69	30	LDR unbiased	2425.4	2427.1	1.699
70	0	correlation	2475.5	2477.6	2.164
71	0	correlation	2452.1	2447.5	-4.612
72	0	correlation	2500.7	2500.3	-0.32
73	0	correlation	2515.5	2515.2	-0.231
74	0	correlation	2447.4	2448.8	1.454

TID vs Post - Pre Exposure Delta

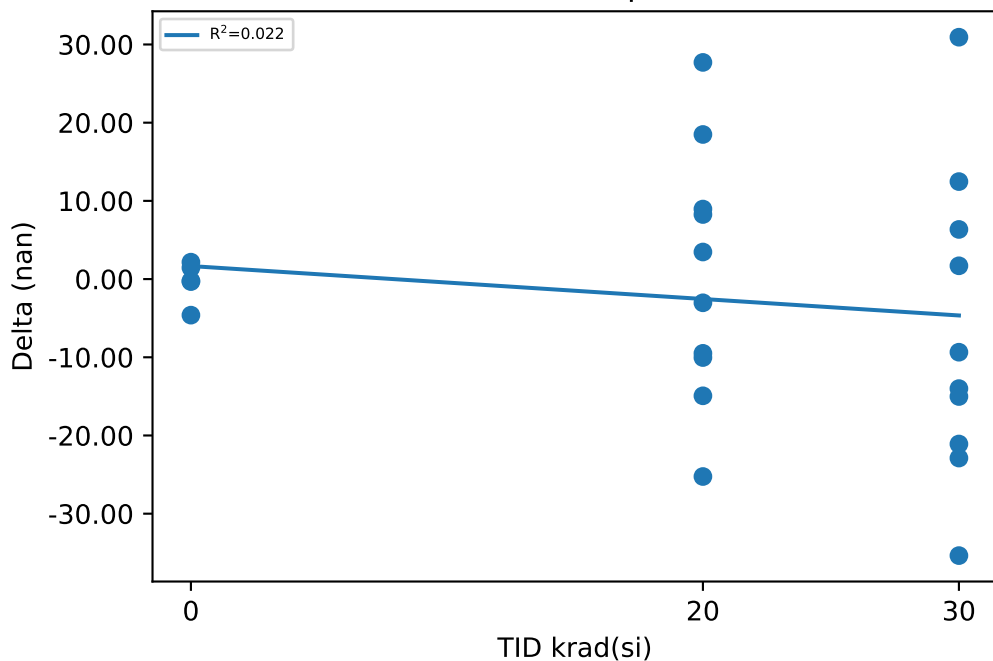

Test Statistics (nan)

krad(si)	Pre Exposure Min	Pre Exposure Avg	Pre Exposure Max	Pre Exposure Std	Post Exposure Min	Post Exposure Avg	Post Exposure Max	Post Exposure Std	Min Delta	Avg Delta	Max Delta	Std Delta
0	2447.4	2478.2	2515.5	29.709	2447.5	2477.9	2515.2	30.274	-4.612	-0.309	2.164	2.6337
20	2406.5	2460.7	2514.6	34.237	2403.5	2461.1	2523.6	43.882	-25.247	0.4136	27.707	16.085
30	2425.4	2467	2535.9	30.903	2427.1	2460.4	2521.9	26.027	-35.36	-6.6262	30.931	19.563

Device Test: 11.23 UJP0M9(dCLR_2A_CH1_UJP0M9)

TID vs Result Stats

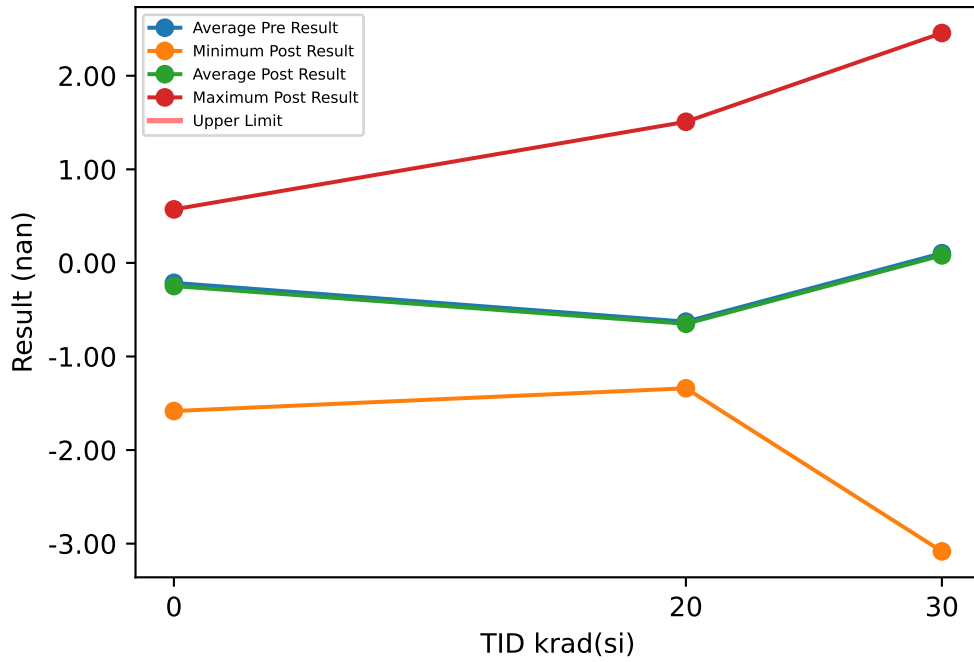

Test Results (No Limits Specified (nan))

Serial #	krad(si)	Exposure Conditions	Pre Result	Post Result	Delta
50	20	LDR biased	-0.801	-1.109	-0.308
51	20	LDR biased	1.495	1.508	0.013
52	20	LDR biased	-0.976	-1.34	-0.364
53	20	LDR biased	-1.16	-1.065	0.095
54	20	LDR biased	-0.977	-0.767	0.21
55	30	LDR biased	0.361	0.167	-0.194
56	30	LDR biased	-2.917	-3.083	-0.166
57	30	LDR biased	-1.326	-0.921	0.405
58	30	LDR biased	0.184	-0.102	-0.286
59	30	LDR biased	2.503	2.457	-0.046
60	20	LDR unbiased	-1.269	-1.179	0.09
61	20	LDR unbiased	-0.616	-0.582	0.034
62	20	LDR unbiased	-0.262	-0.246	0.016
63	20	LDR unbiased	-0.946	-0.999	-0.053
64	20	LDR unbiased	-0.766	-0.728	0.038
65	30	LDR unbiased	1.075	1.186	0.111
66	30	LDR unbiased	0.333	0.29	-0.043
67	30	LDR unbiased	1.967	2.056	0.089
68	30	LDR unbiased	-1.405	-1.461	-0.056
69	30	LDR unbiased	0.263	0.215	-0.048
70	0	correlation	0.791	0.572	-0.219
71	0	correlation	0.148	0.106	-0.042
72	0	correlation	-1.651	-1.583	0.068
73	0	correlation	-0.132	-0.171	-0.039
74	0	correlation	-0.221	-0.16	0.061

TID vs Post - Pre Exposure Delta

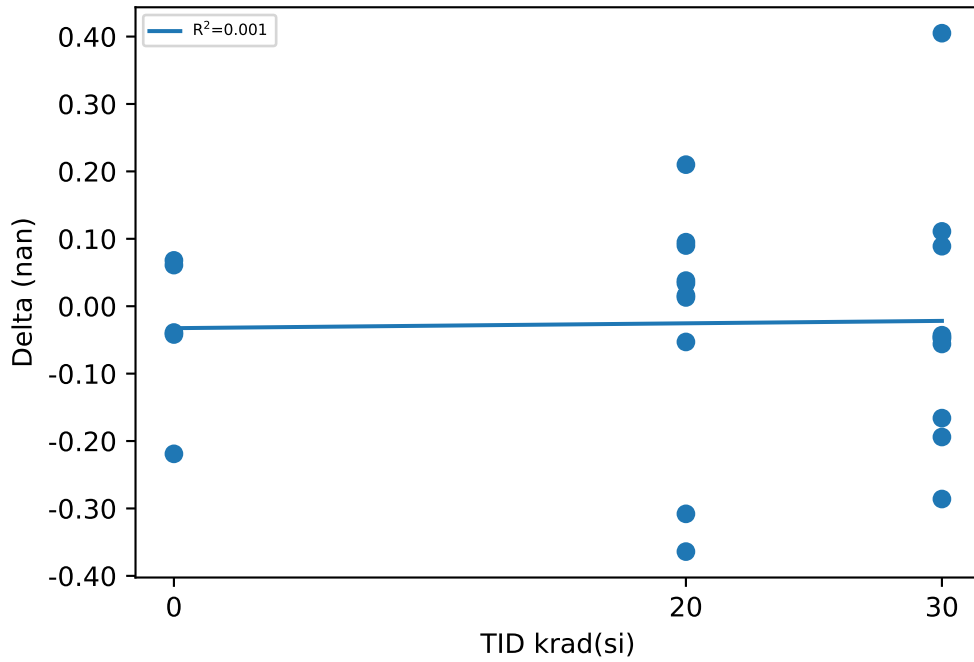

Test Statistics (nan)

krad(si)	Pre Exposure Min	Pre Exposure Avg	Pre Exposure Max	Pre Exposure Std	Post Exposure Min	Post Exposure Avg	Post Exposure Max	Post Exposure Std	Min Delta	Avg Delta	Max Delta	Std Delta
0	-1.651	-0.213	0.791	0.89622	-1.583	-0.2472	0.572	0.80523	-0.219	-0.0342	0.068	0.11591
20	-1.269	-0.6278	1.495	0.79778	-1.34	-0.6507	1.508	0.82362	-0.364	-0.0229	0.21	0.17925
30	-2.917	0.1038	2.503	1.6251	-3.083	0.0804	2.457	1.6419	-0.286	-0.0234	0.405	0.19298

Device Test: 11.24 UJP0M9(dCLR_2A_CH2_UJP0M9)

TID vs Result Stats

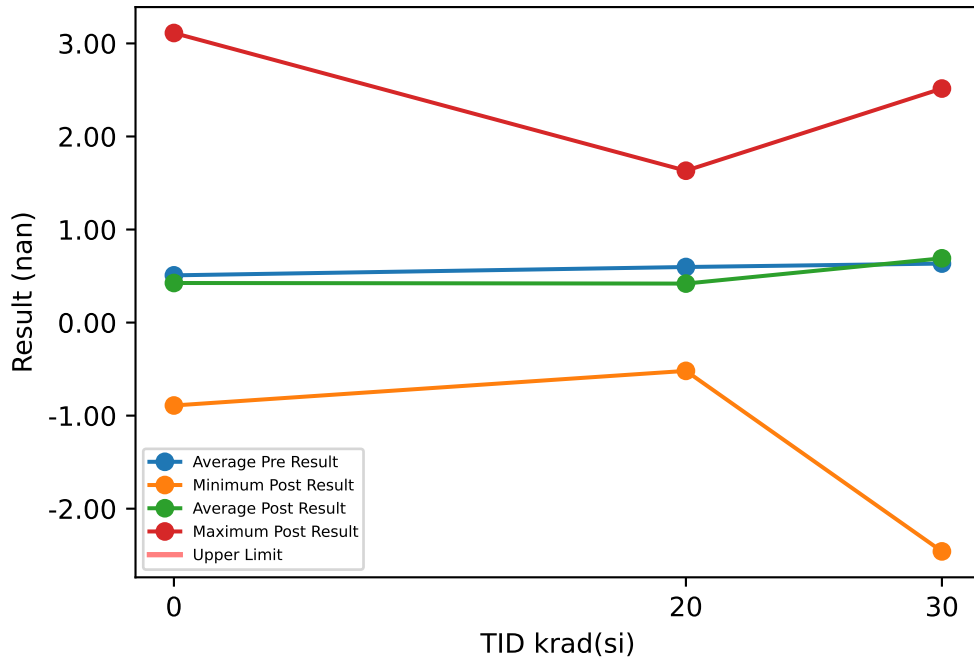

Test Results (No Limits Specified (nan))

Serial #	krad(si)	Exposure Conditions	Pre Result	Post Result	Delta
50	20	LDR biased	0.394	0.311	-0.083
51	20	LDR biased	0.386	0.297	-0.089
52	20	LDR biased	1.241	0.873	-0.368
53	20	LDR biased	0.833	0.683	-0.15
54	20	LDR biased	-0.097	-0.275	-0.178
55	30	LDR biased	-2.165	-2.459	-0.294
56	30	LDR biased	1.06	1.41	0.35
57	30	LDR biased	1.991	2.102	0.111
58	30	LDR biased	2.397	2.515	0.118
59	30	LDR biased	-1.793	-1.483	0.31
60	20	LDR unbiased	-0.045	-0.519	-0.474
61	20	LDR unbiased	0.333	0.166	-0.167
62	20	LDR unbiased	1.26	1.251	-0.009
63	20	LDR unbiased	-0.125	-0.228	-0.103
64	20	LDR unbiased	1.792	1.632	-0.16
65	30	LDR unbiased	2.393	2.111	-0.282
66	30	LDR unbiased	1.323	1.634	0.311
67	30	LDR unbiased	2.606	2.494	-0.112
68	30	LDR unbiased	-0.734	-0.573	0.161
69	30	LDR unbiased	-0.737	-0.844	-0.107
70	0	correlation	-0.851	-0.891	-0.04
71	0	correlation	-0.372	-0.384	-0.012
72	0	correlation	0.507	0.349	-0.158
73	0	correlation	3.313	3.112	-0.201
74	0	correlation	-0.059	-0.059	0

TID vs Post - Pre Exposure Delta

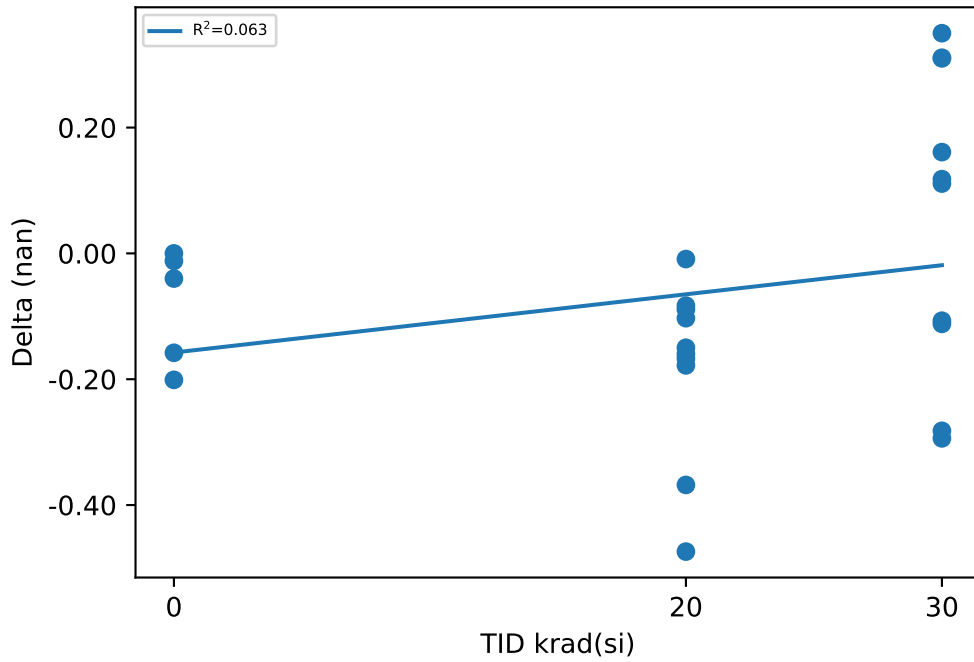

Test Statistics (nan)

krad(si)	Pre Exposure Min	Pre Exposure Avg	Pre Exposure Max	Pre Exposure Std	Post Exposure Min	Post Exposure Avg	Post Exposure Max	Post Exposure Std	Min Delta	Avg Delta	Max Delta	Std Delta
0	-0.851	0.5076	3.313	1.644	-0.891	0.4254	3.112	1.5689	-0.201	-0.0822	0	0.091275
20	-0.125	0.5972	1.792	0.659	-0.519	0.4191	1.632	0.69202	-0.474	-0.1781	-0.009	0.13987
30	-2.165	0.6341	2.606	1.8277	-2.459	0.6907	2.515	1.8437	-0.294	0.0566	0.35	0.24162

Device Test: 11.25 UJP0M9(dCLR_2A_CH3_UJP0M9)

TID vs Result Stats

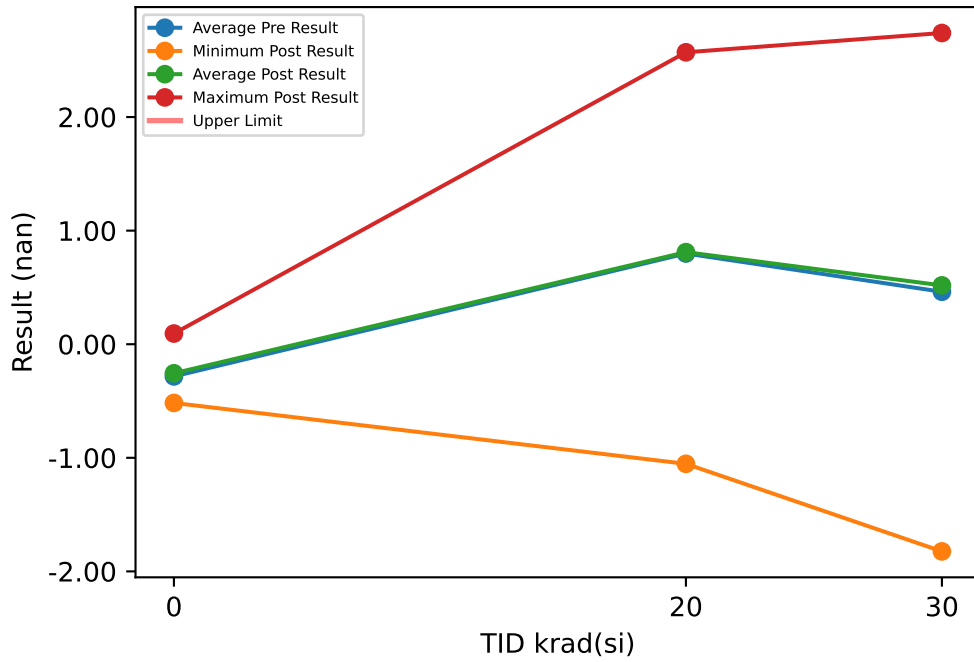

Test Results (No Limits Specified (nan))

Serial #	krad(si)	Exposure Conditions	Pre Result	Post Result	Delta
50	20	LDR biased	2.526	2.57	0.044
51	20	LDR biased	2.019	1.96	-0.059
52	20	LDR biased	1.159	1.141	-0.018
53	20	LDR biased	0.157	0.297	0.14
54	20	LDR biased	-0.976	-1.053	-0.077
55	30	LDR biased	-0.637	-0.839	-0.202
56	30	LDR biased	0.976	0.891	-0.085
57	30	LDR biased	0.946	1.073	0.127
58	30	LDR biased	-1.845	-1.824	0.021
59	30	LDR biased	1.969	2.011	0.042
60	20	LDR unbiased	0.581	0.527	-0.054
61	20	LDR unbiased	2.025	1.984	-0.041
62	20	LDR unbiased	-0.014	-0.111	-0.097
63	20	LDR unbiased	0.234	0.361	0.127
64	20	LDR unbiased	0.276	0.43	0.154
65	30	LDR unbiased	0.163	0.554	0.391
66	30	LDR unbiased	-1.765	-1.767	-0.002
67	30	LDR unbiased	2.626	2.74	0.114
68	30	LDR unbiased	1.338	1.391	0.053
69	30	LDR unbiased	0.847	0.949	0.102
70	0	correlation	0.137	0.094	-0.043
71	0	correlation	-0.487	-0.449	0.038
72	0	correlation	-0.148	-0.171	-0.023
73	0	correlation	-0.62	-0.517	0.103
74	0	correlation	-0.298	-0.237	0.061

TID vs Post - Pre Exposure Delta

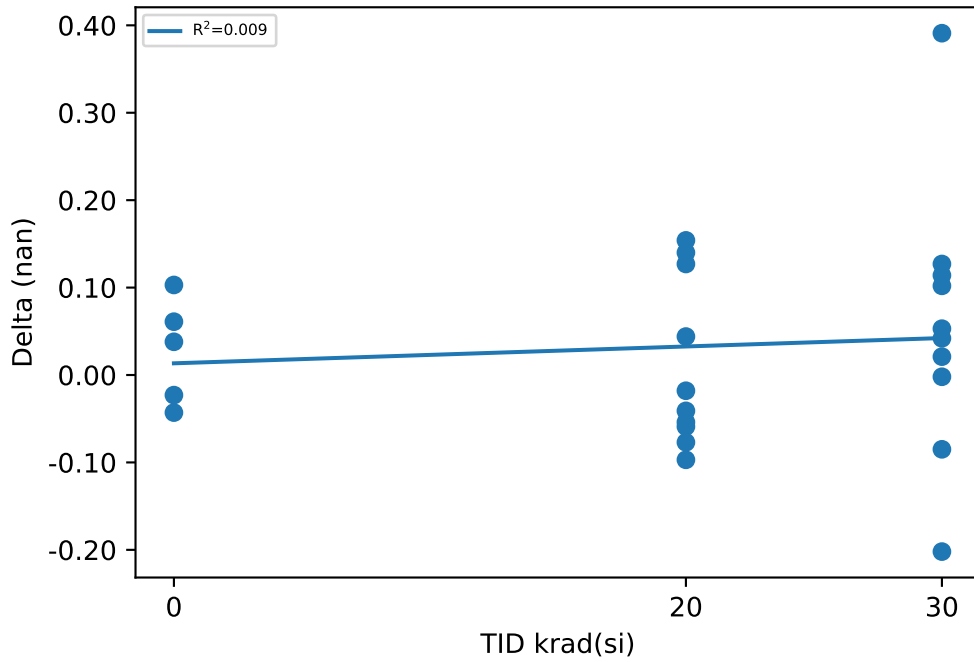

Test Statistics (nan)

krad(si)	Pre Exposure Min	Pre Exposure Avg	Pre Exposure Max	Pre Exposure Std	Post Exposure Min	Post Exposure Avg	Post Exposure Max	Post Exposure Std	Min Delta	Avg Delta	Max Delta	Std Delta
0	-0.62	-0.2832	0.137	0.29582	-0.517	-0.256	0.094	0.24262	-0.043	0.0272	0.103	0.06011
20	-0.976	0.7987	2.526	1.1039	-1.053	0.8106	2.57	1.1013	-0.097	0.0119	0.154	0.096439
30	-1.845	0.4618	2.626	1.4887	-1.824	0.5179	2.74	1.5315	-0.202	0.0561	0.391	0.1542

Device Test: 11.26 UJP0M9(dCLR_2A_CH4_UJP0M9)

TID vs Result Stats

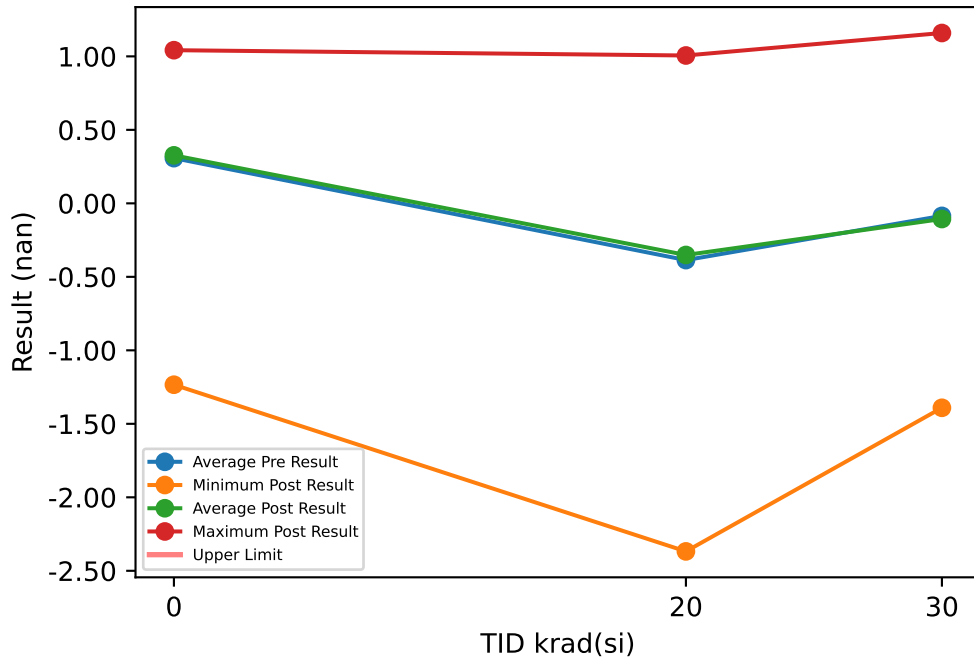

Test Results (No Limits Specified (nan))

Serial #	krad(si)	Exposure Conditions	Pre Result	Post Result	Delta
50	20	LDR biased	0.848	0.724	-0.124
51	20	LDR biased	0.184	0.453	0.269
52	20	LDR biased	-0.521	-0.503	0.018
53	20	LDR biased	-0.839	-1.164	-0.325
54	20	LDR biased	-0.884	-0.952	-0.068
55	30	LDR biased	-0.801	-0.521	0.28
56	30	LDR biased	-1.238	-1.391	-0.153
57	30	LDR biased	-0.275	-0.245	0.03
58	30	LDR biased	0.757	0.749	-0.008
59	30	LDR biased	0.986	0.649	-0.337
60	20	LDR unbiased	0.554	0.807	0.253
61	20	LDR unbiased	-2.193	-2.104	0.089
62	20	LDR unbiased	0.491	0.588	0.097
63	20	LDR unbiased	-2.288	-2.368	-0.08
64	20	LDR unbiased	0.787	1.006	0.219
65	30	LDR unbiased	1.319	1.159	-0.16
66	30	LDR unbiased	1.037	0.818	-0.219
67	30	LDR unbiased	-1.161	-1.116	0.045
68	30	LDR unbiased	-0.285	0.009	0.294
69	30	LDR unbiased	-1.193	-1.177	0.016
70	0	correlation	0.979	1.028	0.049
71	0	correlation	-1.233	-1.234	-0.001
72	0	correlation	1.038	1.042	0.004
73	0	correlation	0.364	0.394	0.03
74	0	correlation	0.39	0.403	0.013

TID vs Post - Pre Exposure Delta

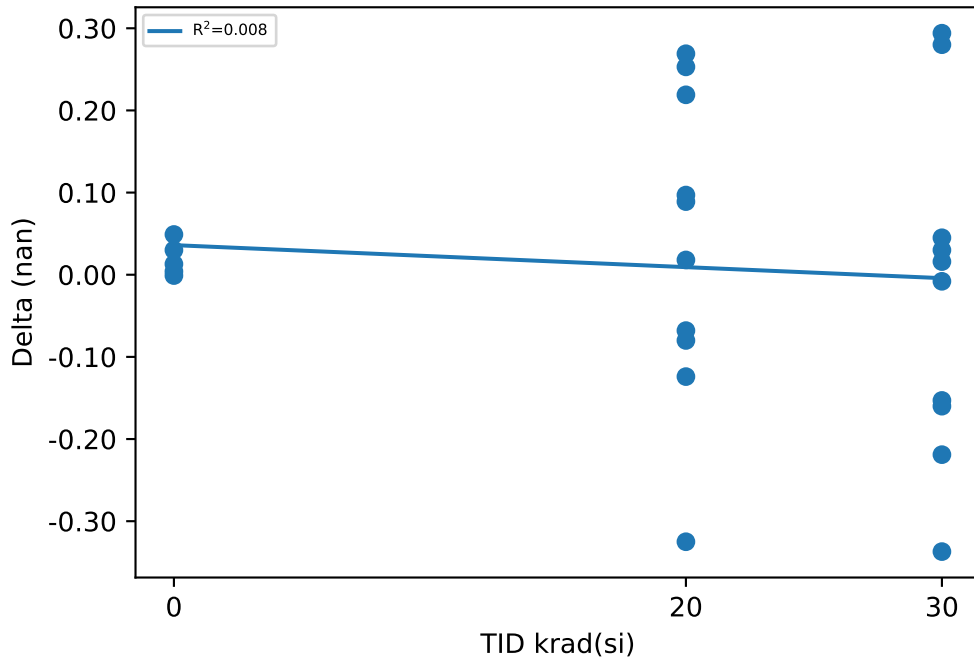

Test Statistics (nan)

krad(si)	Pre Exposure Min	Pre Exposure Avg	Pre Exposure Max	Pre Exposure Std	Post Exposure Min	Post Exposure Avg	Post Exposure Max	Post Exposure Std	Min Delta	Avg Delta	Max Delta	Std Delta
0	-1.233	0.3076	1.038	0.91756	-1.234	0.3266	1.042	0.92866	-0.001	0.019	0.049	0.020506
20	-2.288	-0.3861	0.848	1.1657	-2.368	-0.3513	1.006	1.2496	-0.325	0.0348	0.269	0.18912
30	-1.238	-0.0854	1.319	1.0214	-1.391	-0.1066	1.159	0.92965	-0.337	-0.0212	0.294	0.20389

Device Test: 11.27 UJP0M9(dCLR_3A_CH1_UJP0M9)

TID vs Result Stats

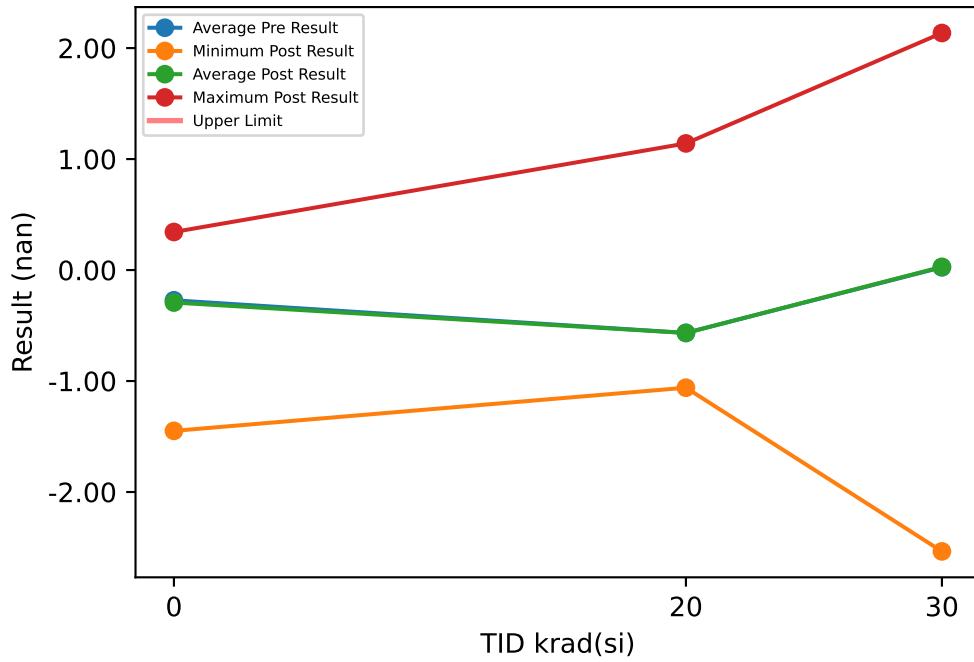

Test Results (No Limits Specified (nan))

Serial #	krad(si)	Exposure Conditions	Pre Result	Post Result	Delta
50	20	LDR biased	-0.824	-0.912	-0.088
51	20	LDR biased	1.169	1.141	-0.028
52	20	LDR biased	-0.845	-1.06	-0.215
53	20	LDR biased	-0.902	-0.838	0.064
54	20	LDR biased	-0.94	-0.754	0.186
55	30	LDR biased	0.392	0.263	-0.129
56	30	LDR biased	-2.476	-2.535	-0.059
57	30	LDR biased	-1.331	-1.042	0.289
58	30	LDR biased	-0.17	-0.358	-0.188
59	30	LDR biased	2.178	2.136	-0.042
60	20	LDR unbiased	-0.814	-0.781	0.033
61	20	LDR unbiased	-0.421	-0.368	0.053
62	20	LDR unbiased	-0.488	-0.446	0.042
63	20	LDR unbiased	-0.777	-0.85	-0.073
64	20	LDR unbiased	-0.822	-0.799	0.023
65	30	LDR unbiased	0.744	0.833	0.089
66	30	LDR unbiased	0.257	0.243	-0.014
67	30	LDR unbiased	1.692	1.777	0.085
68	30	LDR unbiased	-1.258	-1.235	0.023
69	30	LDR unbiased	0.218	0.207	-0.011
70	0	correlation	0.578	0.343	-0.235
71	0	correlation	0.099	0.089	-0.01
72	0	correlation	-1.541	-1.449	0.092
73	0	correlation	-0.378	-0.406	-0.028
74	0	correlation	-0.12	-0.041	0.079

TID vs Post - Pre Exposure Delta

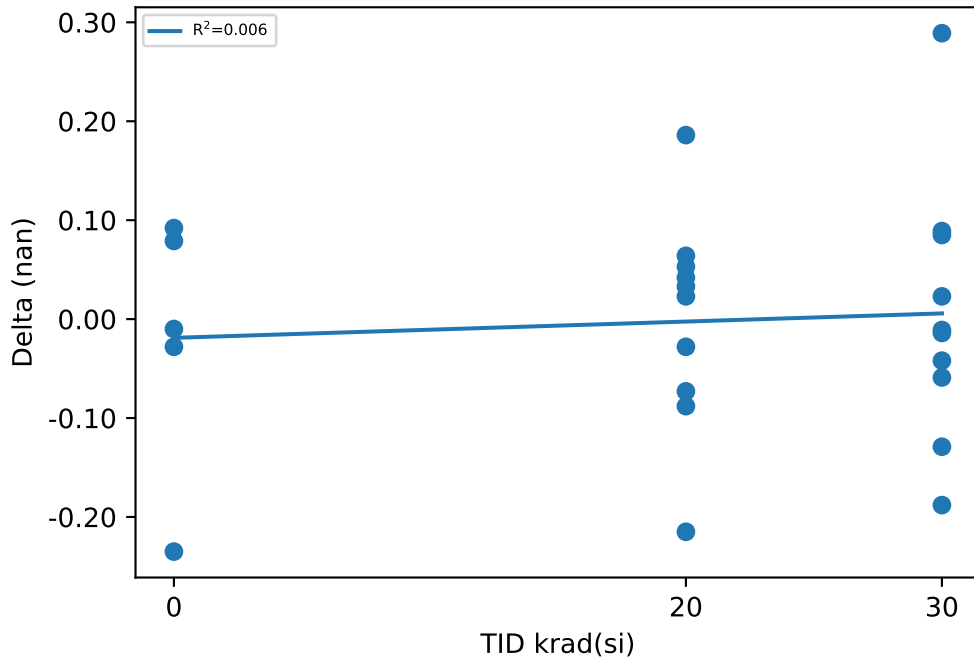

Test Statistics (nan)

krad(si)	Pre Exposure Min	Pre Exposure Avg	Pre Exposure Max	Pre Exposure Std	Post Exposure Min	Post Exposure Avg	Post Exposure Max	Post Exposure Std	Min Delta	Avg Delta	Max Delta	Std Delta
0	-1.541	-0.2724	0.578	0.79133	-1.449	-0.2928	0.343	0.70054	-0.235	-0.0204	0.092	0.13109
20	-0.94	-0.5664	1.169	0.63299	-1.06	-0.5667	1.141	0.63436	-0.215	-0.0003	0.186	0.10799
30	-2.476	0.0246	2.178	1.4117	-2.535	0.0289	2.136	1.404	-0.188	0.0043	0.289	0.13189

Device Test: 11.28 UJP0M9(dCLR_3A_CH2_UJP0M9)

TID vs Result Stats

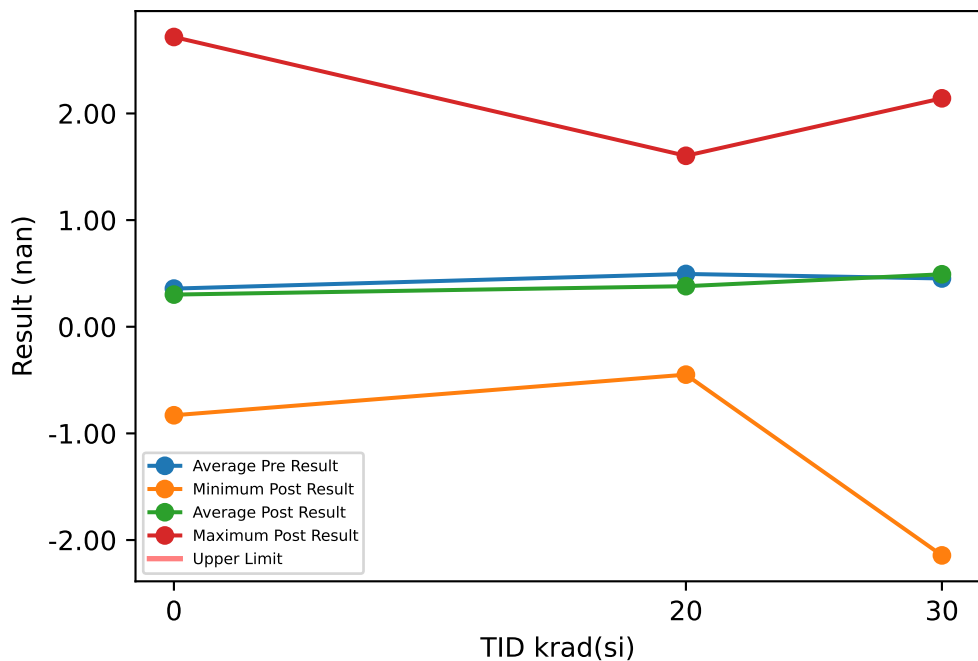

Test Results (No Limits Specified (nan))

Serial #	krad(si)	Exposure Conditions	Pre Result	Post Result	Delta
50	20	LDR biased	0.229	0.205	-0.024
51	20	LDR biased	0.319	0.308	-0.011
52	20	LDR biased	1.181	0.889	-0.292
53	20	LDR biased	0.739	0.573	-0.166
54	20	LDR biased	-0.133	-0.226	-0.093
55	30	LDR biased	-1.864	-2.144	-0.28
56	30	LDR biased	0.808	1.043	0.235
57	30	LDR biased	1.707	1.814	0.107
58	30	LDR biased	2.015	2.142	0.127
59	30	LDR biased	-1.661	-1.428	0.233
60	20	LDR unbiased	-0.117	-0.449	-0.332
61	20	LDR unbiased	0.244	0.145	-0.099
62	20	LDR unbiased	0.969	0.989	0.02
63	20	LDR unbiased	-0.145	-0.233	-0.088
64	20	LDR unbiased	1.665	1.603	-0.062
65	30	LDR unbiased	1.823	1.614	-0.209
66	30	LDR unbiased	0.863	1.205	0.342
67	30	LDR unbiased	2.181	2.043	-0.138
68	30	LDR unbiased	-0.625	-0.534	0.091
69	30	LDR unbiased	-0.72	-0.835	-0.115
70	0	correlation	-0.853	-0.83	0.023
71	0	correlation	-0.546	-0.627	-0.081
72	0	correlation	0.37	0.225	-0.145
73	0	correlation	2.811	2.717	-0.094
74	0	correlation	0.007	0.023	0.016

TID vs Post - Pre Exposure Delta

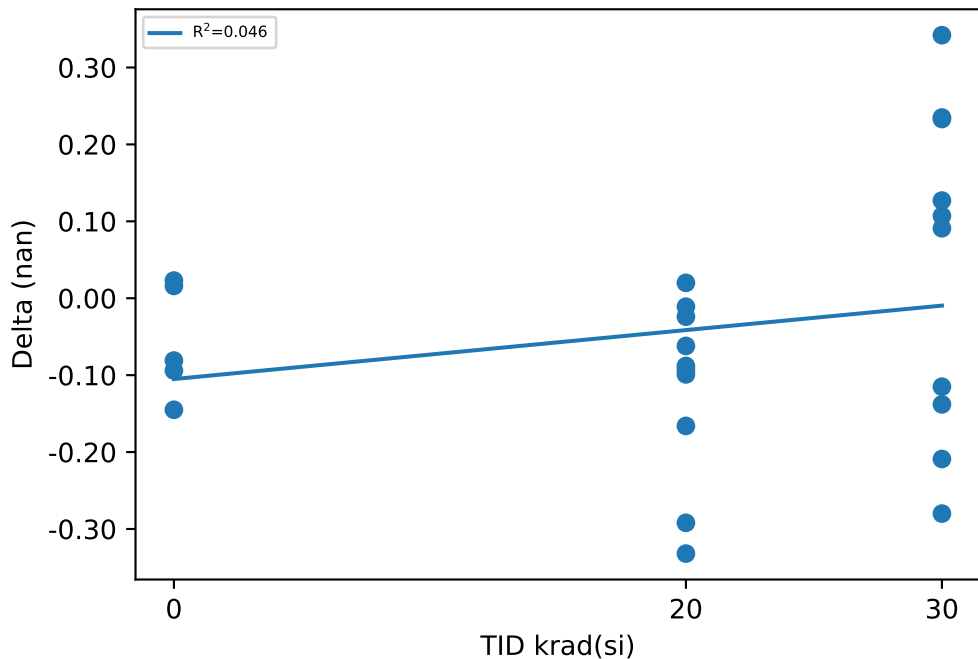

Test Statistics (nan)

krad(si)	Pre Exposure Min	Pre Exposure Avg	Pre Exposure Max	Pre Exposure Std	Post Exposure Min	Post Exposure Avg	Post Exposure Max	Post Exposure Std	Min Delta	Avg Delta	Max Delta	Std Delta
0	-0.853	0.3578	2.811	1.4512	-0.83	0.3016	2.717	1.4195	-0.145	-0.0562	0.023	0.073169
20	-0.145	0.4951	1.665	0.62066	-0.449	0.3804	1.603	0.63981	-0.332	-0.1147	0.02	0.11672
30	-1.864	0.4527	2.181	1.5472	-2.144	0.492	2.142	1.5775	-0.28	0.0393	0.342	0.21115

Device Test: 11.29 UJP0M9(dCLR_3A_CH3_UJP0M9)

TID vs Result Stats

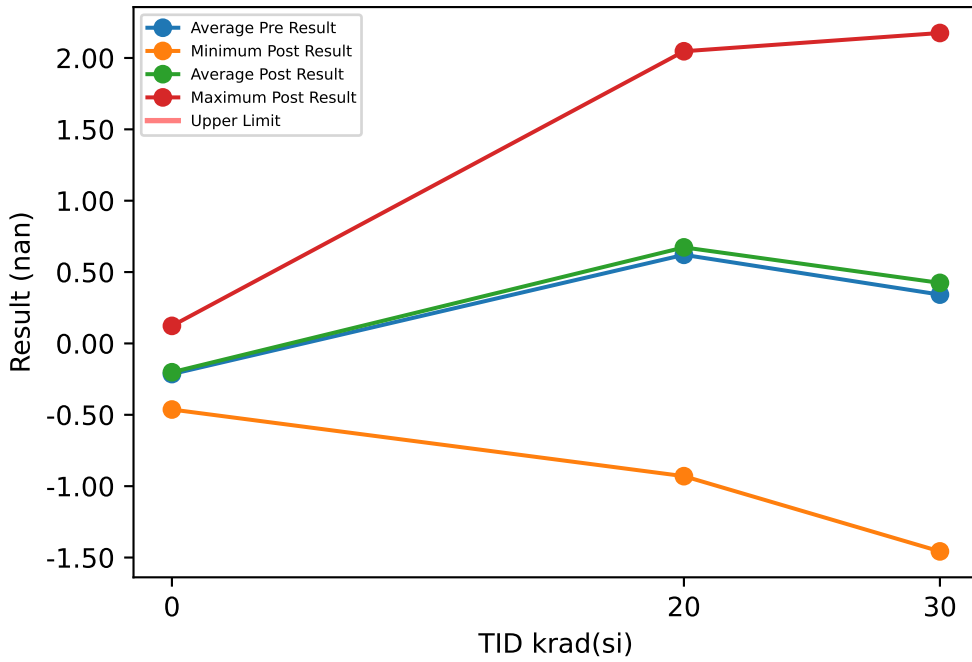

Test Results (No Limits Specified (nan))

Serial #	krad(si)	Exposure Conditions	Pre Result	Post Result	Delta
50	20	LDR biased	2.078	2.047	-0.031
51	20	LDR biased	1.665	1.715	0.05
52	20	LDR biased	0.825	0.798	-0.027
53	20	LDR biased	0.113	0.294	0.181
54	20	LDR biased	-0.94	-0.93	0.01
55	30	LDR biased	-0.565	-0.621	-0.056
56	30	LDR biased	0.785	0.764	-0.021
57	30	LDR biased	0.748	0.881	0.133
58	30	LDR biased	-1.489	-1.389	0.1
59	30	LDR biased	1.546	1.618	0.072
60	20	LDR unbiased	0.461	0.456	-0.005
61	20	LDR unbiased	1.771	1.802	0.031
62	20	LDR unbiased	-0.105	-0.057	0.048
63	20	LDR unbiased	0.258	0.352	0.094
64	20	LDR unbiased	0.083	0.253	0.17
65	30	LDR unbiased	0.001	0.296	0.295
66	30	LDR unbiased	-1.571	-1.457	0.114
67	30	LDR unbiased	2.15	2.175	0.025
68	30	LDR unbiased	1.13	1.179	0.049
69	30	LDR unbiased	0.686	0.796	0.11
70	0	correlation	0.13	0.123	-0.007
71	0	correlation	-0.482	-0.463	0.019
72	0	correlation	-0.055	-0.095	-0.04
73	0	correlation	-0.373	-0.301	0.072
74	0	correlation	-0.293	-0.273	0.02

TID vs Post - Pre Exposure Delta

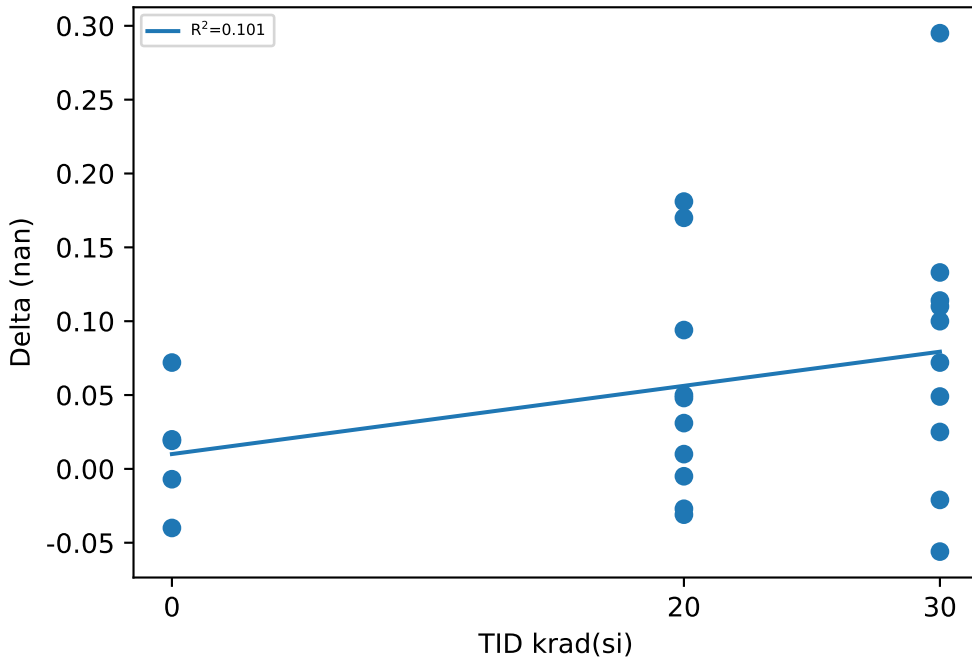

Test Statistics (nan)

krad(si)	Pre Exposure Min	Pre Exposure Avg	Pre Exposure Max	Pre Exposure Std	Post Exposure Min	Post Exposure Avg	Post Exposure Max	Post Exposure Std	Min Delta	Avg Delta	Max Delta	Std Delta
0	-0.482	-0.2146	0.13	0.24848	-0.463	-0.2018	0.123	0.22363	-0.04	0.0128	0.072	0.041155
20	-0.94	0.6209	2.078	0.95717	-0.93	0.673	2.047	0.93313	-0.031	0.0521	0.181	0.075228
30	-1.571	0.3421	2.15	1.2369	-1.457	0.4242	2.175	1.2228	-0.056	0.0821	0.295	0.09672

Device Test: 11.3 UJ9ZQ5(dCLR_P25A_CH2_UJ9ZQ5)

TID vs Result Stats

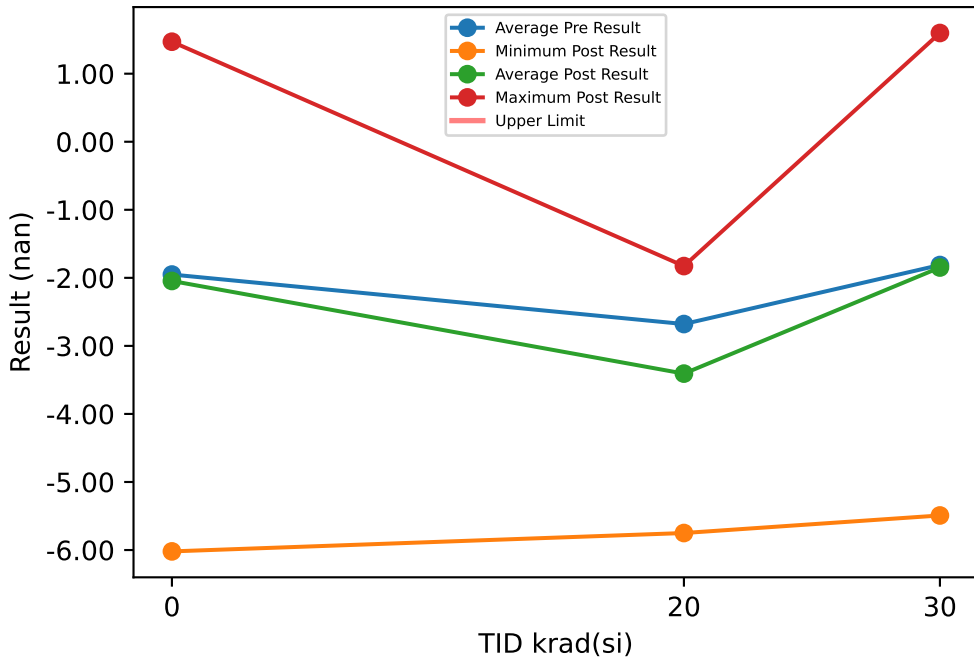

Test Results (No Limits Specified (nan))

Serial #	krad(si)	Exposure Conditions	Pre Result	Post Result	Delta
50	20	LDR biased	-2.015	-2.924	-0.909
51	20	LDR biased	-2.778	-2.965	-0.187
52	20	LDR biased	-1.416	-3.189	-1.773
53	20	LDR biased	-3.143	-3.201	-0.058
54	20	LDR biased	-4.532	-5.75	-1.218
55	30	LDR biased	-1.9	-3.449	-1.549
56	30	LDR biased	-3.643	-1.354	2.289
57	30	LDR biased	-0.488	-0.605	-0.117
58	30	LDR biased	-4.276	-3.493	0.783
59	30	LDR biased	-1.987	-1.675	0.312
60	20	LDR unbiased	-1.862	-4.355	-2.493
61	20	LDR unbiased	-2.976	-2.675	0.301
62	20	LDR unbiased	-1.837	-1.827	0.01
63	20	LDR unbiased	-1.777	-2.035	-0.258
64	20	LDR unbiased	-4.454	-5.153	-0.699
65	30	LDR unbiased	-1.902	-2.925	-1.023
66	30	LDR unbiased	0.808	1.384	0.576
67	30	LDR unbiased	-3.625	-5.492	-1.867
68	30	LDR unbiased	0.346	1.598	1.252
69	30	LDR unbiased	-1.45	-2.472	-1.022
70	0	correlation	1.624	1.47	-0.154
71	0	correlation	-1.133	-1.235	-0.102
72	0	correlation	-3.096	-3.057	0.039
73	0	correlation	-1.081	-1.388	-0.307
74	0	correlation	-6.071	-6.02	0.051

TID vs Post - Pre Exposure Delta

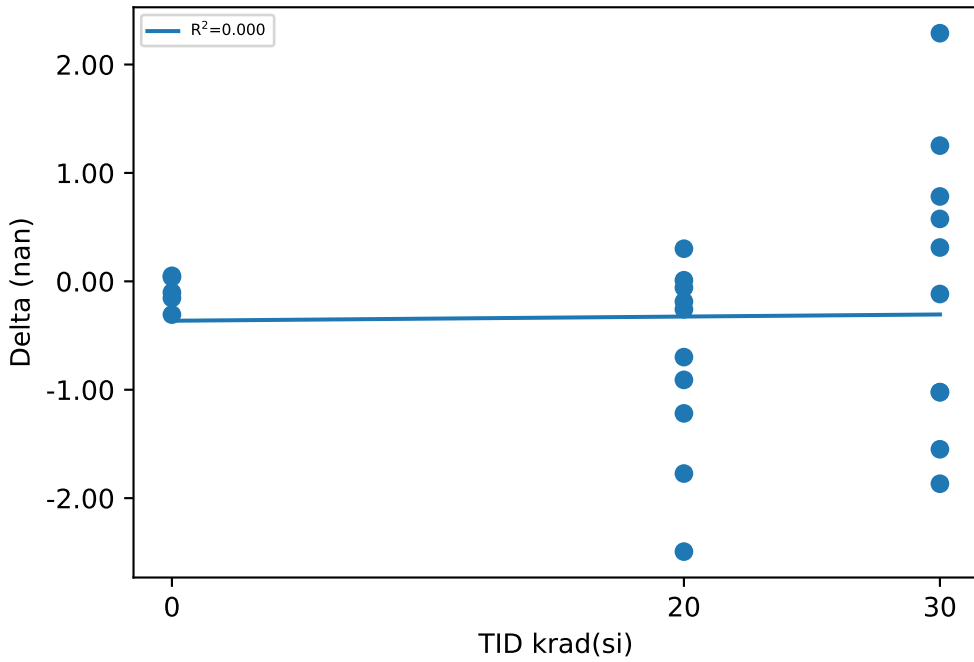

Test Statistics (nan)

krad(si)	Pre Exposure Min	Pre Exposure Avg	Pre Exposure Max	Pre Exposure Std	Post Exposure Min	Post Exposure Avg	Post Exposure Max	Post Exposure Std	Min Delta	Avg Delta	Max Delta	Std Delta
0	-6.071	-1.9514	1.624	2.8501	-6.02	-2.046	1.47	2.7508	-0.307	-0.0946	0.051	0.14811
20	-4.532	-2.679	-1.416	1.1117	-5.75	-3.4074	-1.827	1.2854	-2.493	-0.7284	0.301	0.88487
30	-4.276	-1.8117	0.808	1.705	-5.492	-1.8483	1.598	2.217	-1.867	-0.0366	2.289	1.326

Device Test: 11.30 UJP0M9(dCLR_3A_CH4_UJP0M9)

TID vs Result Stats

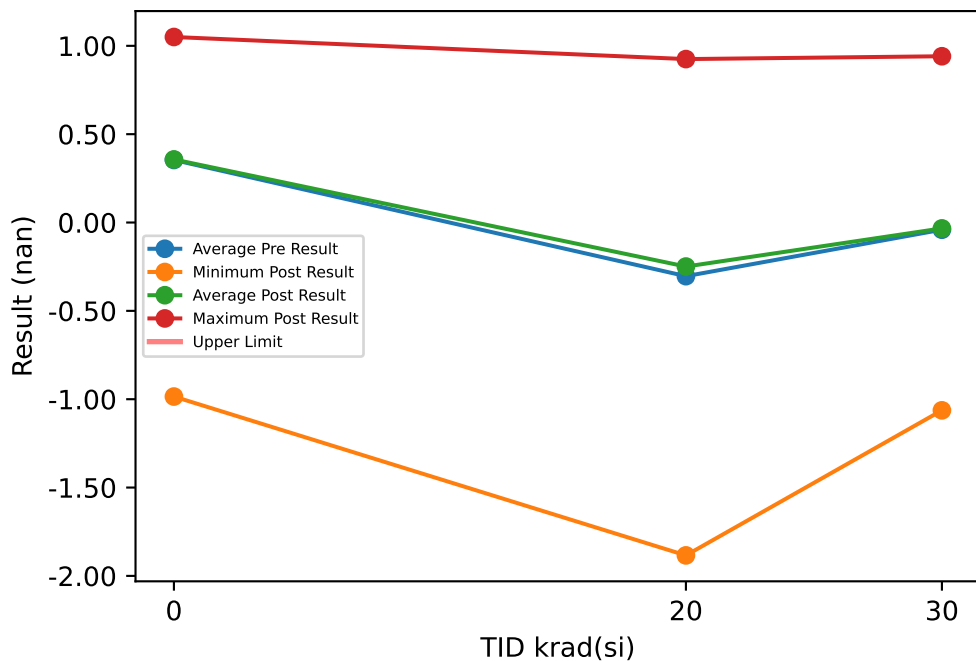

Test Results (No Limits Specified (nan))

Serial #	krad(si)	Exposure Conditions	Pre Result	Post Result	Delta
50	20	LDR biased	0.766	0.698	-0.068
51	20	LDR biased	0.02	0.276	0.256
52	20	LDR biased	-0.198	-0.232	-0.034
53	20	LDR biased	-0.623	-0.825	-0.202
54	20	LDR biased	-0.826	-0.788	0.038
55	30	LDR biased	-0.651	-0.379	0.272
56	30	LDR biased	-0.904	-1.063	-0.159
57	30	LDR biased	-0.325	-0.33	-0.005
58	30	LDR biased	0.789	0.757	-0.032
59	30	LDR biased	0.831	0.713	-0.118
60	20	LDR unbiased	0.477	0.657	0.18
61	20	LDR unbiased	-1.888	-1.799	0.089
62	20	LDR unbiased	0.307	0.48	0.173
63	20	LDR unbiased	-1.847	-1.884	-0.037
64	20	LDR unbiased	0.775	0.925	0.15
65	30	LDR unbiased	0.988	0.904	-0.084
66	30	LDR unbiased	1.032	0.941	-0.091
67	30	LDR unbiased	-0.978	-0.928	0.05
68	30	LDR unbiased	-0.22	-0.013	0.207
69	30	LDR unbiased	-0.969	-0.935	0.034
70	0	correlation	0.908	0.93	0.022
71	0	correlation	-0.95	-0.985	-0.035
72	0	correlation	1.053	1.05	-0.003
73	0	correlation	0.181	0.189	0.008
74	0	correlation	0.578	0.601	0.023

TID vs Post - Pre Exposure Delta

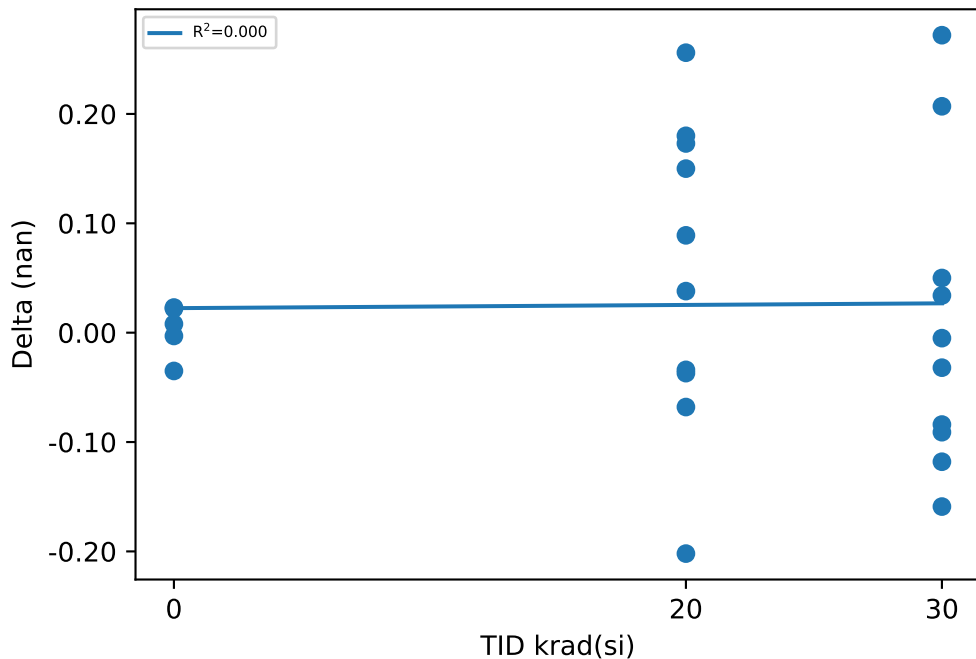

Test Statistics (nan)

krad(si)	Pre Exposure Min	Pre Exposure Avg	Pre Exposure Max	Pre Exposure Std	Post Exposure Min	Post Exposure Avg	Post Exposure Max	Post Exposure Std	Min Delta	Avg Delta	Max Delta	Std Delta
0	-0.95	0.354	1.053	0.8025	-0.985	0.357	1.05	0.82117	-0.035	0.003	0.023	0.023801
20	-1.888	-0.3037	0.775	0.98165	-1.884	-0.2492	0.925	1.0329	-0.202	0.0545	0.256	0.14063
30	-0.978	-0.0407	1.032	0.85817	-1.063	-0.0333	0.941	0.80905	-0.159	0.0074	0.272	0.13966

Device Test: 11.31 UJP0M9(dCLR_4A_CH1_UJP0M9)

TID vs Result Stats

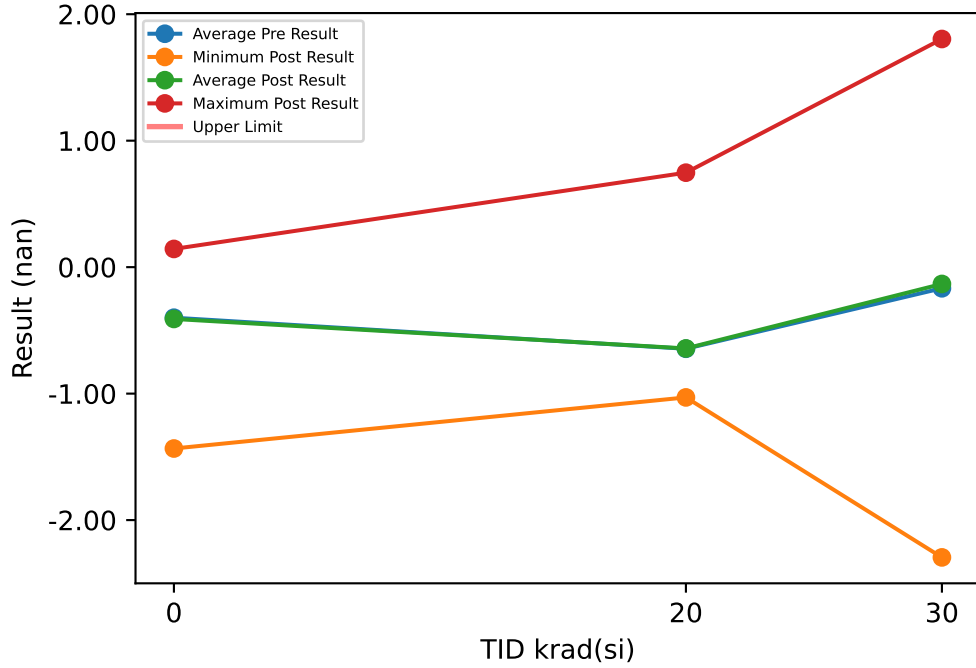

Test Results (No Limits Specified (nan))

Serial #	krad(si)	Exposure Conditions	Pre Result	Post Result	Delta
50	20	LDR biased	-0.864	-0.962	-0.098
51	20	LDR biased	0.76	0.747	-0.013
52	20	LDR biased	-0.878	-1.03	-0.152
53	20	LDR biased	-0.904	-0.82	0.084
54	20	LDR biased	-0.97	-0.871	0.099
55	30	LDR biased	0.275	0.184	-0.091
56	30	LDR biased	-2.259	-2.295	-0.036
57	30	LDR biased	-1.422	-1.162	0.26
58	30	LDR biased	-0.514	-0.63	-0.116
59	30	LDR biased	1.786	1.804	0.018
60	20	LDR unbiased	-0.619	-0.605	0.014
61	20	LDR unbiased	-0.476	-0.487	-0.011
62	20	LDR unbiased	-0.705	-0.633	0.072
63	20	LDR unbiased	-0.833	-0.863	-0.03
64	20	LDR unbiased	-0.964	-0.903	0.061
65	30	LDR unbiased	0.351	0.449	0.098
66	30	LDR unbiased	0.072	0.105	0.033
67	30	LDR unbiased	1.328	1.382	0.054
68	30	LDR unbiased	-1.327	-1.252	0.075
69	30	LDR unbiased	0.039	0.086	0.047
70	0	correlation	0.309	0.144	-0.165
71	0	correlation	-0.021	-0.027	-0.006
72	0	correlation	-1.514	-1.434	0.08
73	0	correlation	-0.606	-0.593	0.013
74	0	correlation	-0.167	-0.138	0.029

TID vs Post - Pre Exposure Delta

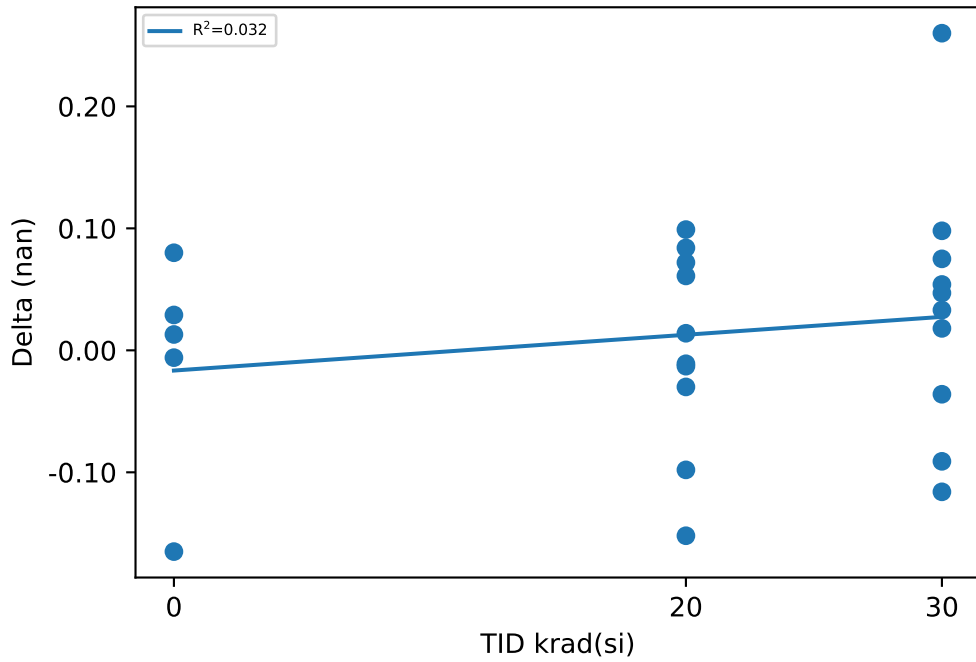

Test Statistics (nan)

krad(si)	Pre Exposure Min	Pre Exposure Avg	Pre Exposure Max	Pre Exposure Std	Post Exposure Min	Post Exposure Avg	Post Exposure Max	Post Exposure Std	Min Delta	Avg Delta	Max Delta	Std Delta
0	-1.514	-0.3998	0.309	0.70428	-1.434	-0.4096	0.144	0.63436	-0.165	-0.0098	0.08	0.092454
20	-0.97	-0.6453	0.76	0.51843	-1.03	-0.6427	0.747	0.51735	-0.152	0.0026	0.099	0.081506
30	-2.259	-0.1671	1.786	1.2486	-2.295	-0.1329	1.804	1.2393	-0.116	0.0342	0.26	0.10578

Device Test: 11.32 UJP0M9(dCLR_4A_CH2_UJP0M9)

TID vs Result Stats

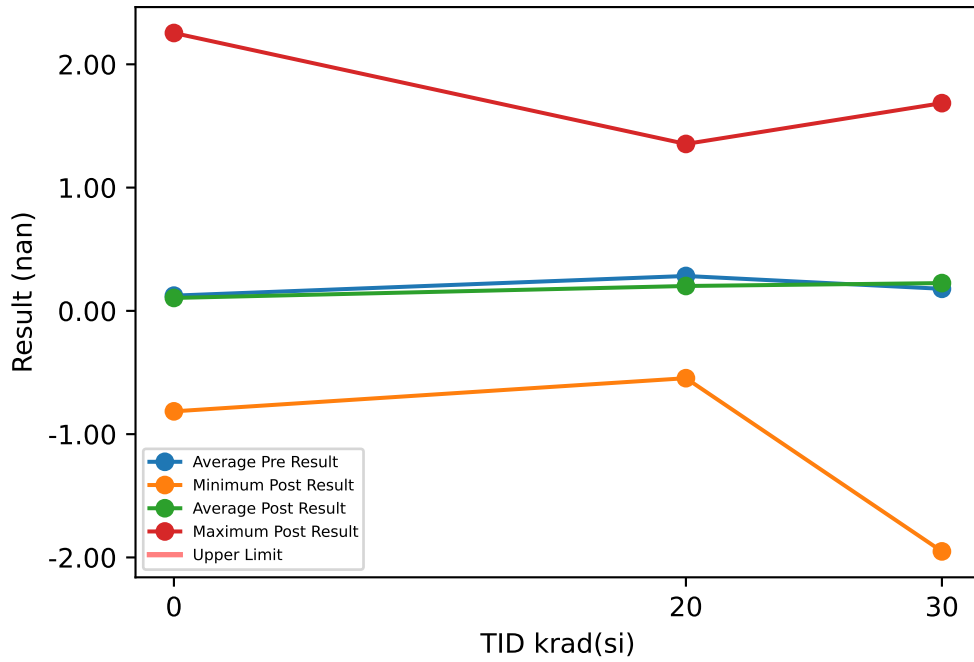

Test Results (No Limits Specified (nan))

Serial #	krad(si)	Exposure Conditions	Pre Result	Post Result	Delta
50	20	LDR biased	-0.025	0.031	0.056
51	20	LDR biased	0.185	0.116	-0.069
52	20	LDR biased	0.94	0.742	-0.198
53	20	LDR biased	0.44	0.374	-0.066
54	20	LDR biased	-0.314	-0.377	-0.063
55	30	LDR biased	-1.723	-1.951	-0.228
56	30	LDR biased	0.465	0.662	0.197
57	30	LDR biased	1.273	1.385	0.112
58	30	LDR biased	1.601	1.685	0.084
59	30	LDR biased	-1.589	-1.444	0.145
60	20	LDR unbiased	-0.348	-0.546	-0.198
61	20	LDR unbiased	0.037	-0.024	-0.061
62	20	LDR unbiased	0.707	0.681	-0.026
63	20	LDR unbiased	-0.205	-0.333	-0.128
64	20	LDR unbiased	1.414	1.354	-0.06
65	30	LDR unbiased	1.233	1.099	-0.134
66	30	LDR unbiased	0.469	0.745	0.276
67	30	LDR unbiased	1.659	1.563	-0.096
68	30	LDR unbiased	-0.71	-0.541	0.169
69	30	LDR unbiased	-0.889	-0.949	-0.06
70	0	correlation	-0.855	-0.814	0.041
71	0	correlation	-0.746	-0.815	-0.069
72	0	correlation	0.079	-0.01	-0.089
73	0	correlation	2.284	2.254	-0.03
74	0	correlation	-0.144	-0.091	0.053

TID vs Post - Pre Exposure Delta

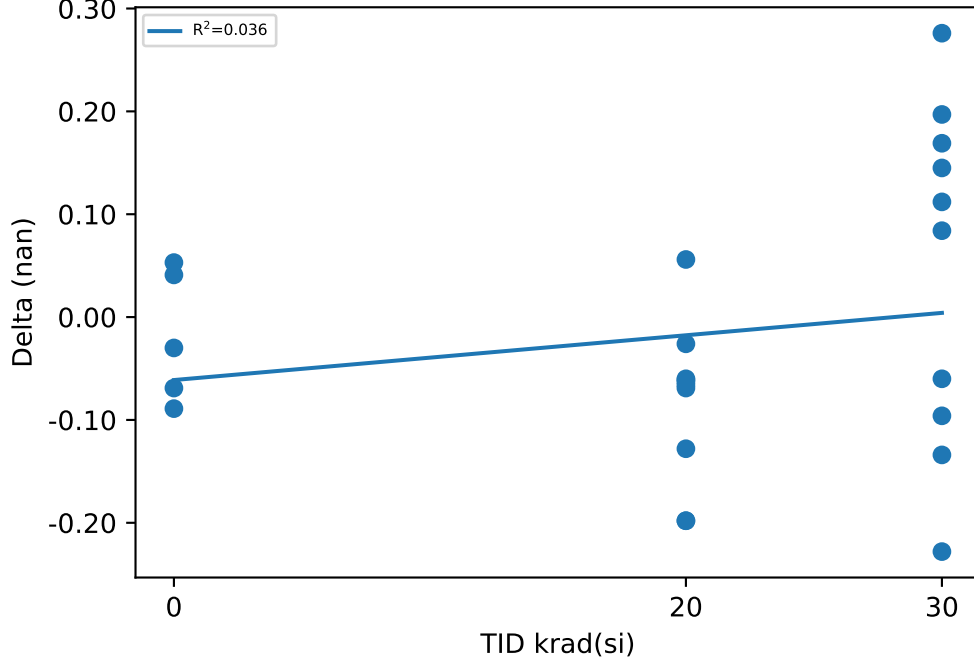

Test Statistics (nan)

krad(si)	Pre Exposure Min	Pre Exposure Avg	Pre Exposure Max	Pre Exposure Std	Post Exposure Min	Post Exposure Avg	Post Exposure Max	Post Exposure Std	Min Delta	Avg Delta	Max Delta	Std Delta
0	-0.855	0.1236	2.284	1.2703	-0.815	0.1048	2.254	1.261	-0.089	-0.0188	0.053	0.063845
20	-0.348	0.2831	1.414	0.58433	-0.546	0.2018	1.354	0.59127	-0.198	-0.0813	0.056	0.076677
30	-1.723	0.1789	1.659	1.3064	-1.951	0.2254	1.685	1.3324	-0.228	0.0465	0.276	0.16509

Device Test: 11.33 UJP0M9(dCLR_4A_CH3_UJP0M9)

TID vs Result Stats

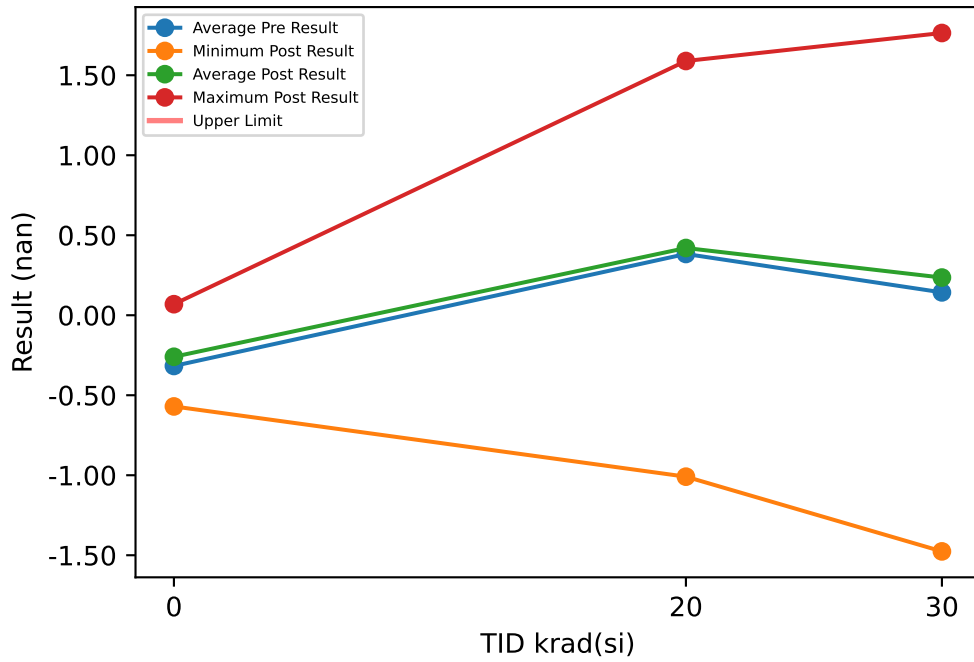

Test Results (No Limits Specified (nan))

Serial #	krad(si)	Exposure Conditions	Pre Result	Post Result	Delta
50	20	LDR biased	1.597	1.589	-0.008
51	20	LDR biased	1.29	1.34	0.05
52	20	LDR biased	0.522	0.477	-0.045
53	20	LDR biased	-0.057	0.117	0.174
54	20	LDR biased	-0.986	-1.009	-0.023
55	30	LDR biased	-0.586	-0.606	-0.02
56	30	LDR biased	0.592	0.599	0.007
57	30	LDR biased	0.474	0.603	0.129
58	30	LDR biased	-1.344	-1.252	0.092
59	30	LDR biased	1.094	1.147	0.053
60	20	LDR unbiased	0.221	0.199	-0.022
61	20	LDR unbiased	1.414	1.472	0.058
62	20	LDR unbiased	-0.183	-0.191	-0.008
63	20	LDR unbiased	0.119	0.21	0.091
64	20	LDR unbiased	-0.108	-0.002	0.106
65	30	LDR unbiased	-0.238	0.105	0.343
66	30	LDR unbiased	-1.517	-1.476	0.041
67	30	LDR unbiased	1.69	1.764	0.074
68	30	LDR unbiased	0.877	0.9	0.023
69	30	LDR unbiased	0.387	0.571	0.184
70	0	correlation	0.01	0.069	0.059
71	0	correlation	-0.663	-0.57	0.093
72	0	correlation	-0.084	-0.104	-0.02
73	0	correlation	-0.417	-0.301	0.116
74	0	correlation	-0.431	-0.392	0.039

TID vs Post - Pre Exposure Delta

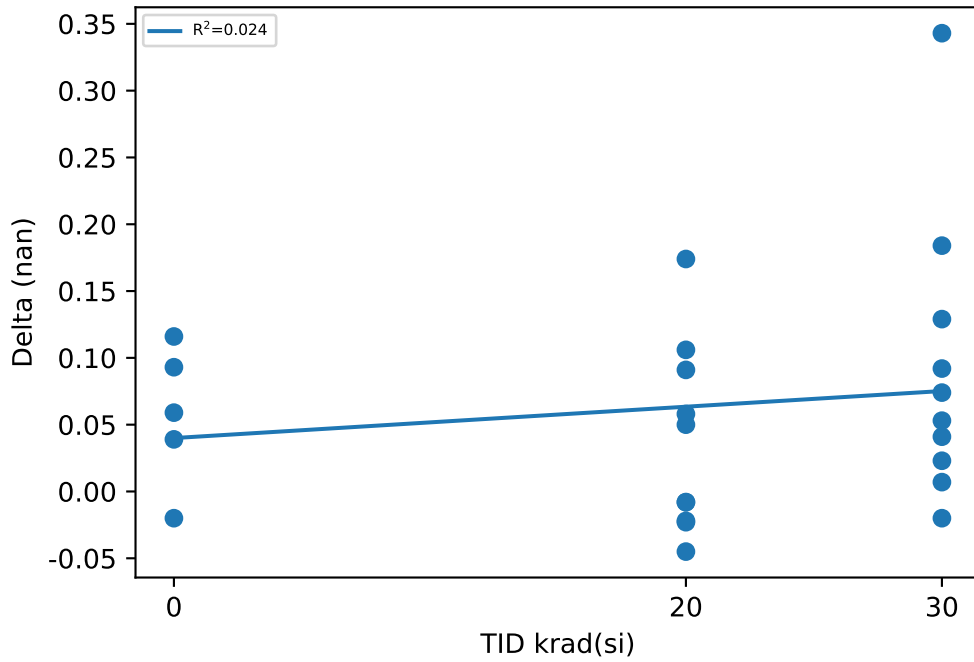

Test Statistics (nan)

krad(si)	Pre Exposure Min	Pre Exposure Avg	Pre Exposure Max	Pre Exposure Std	Post Exposure Min	Post Exposure Avg	Post Exposure Max	Post Exposure Std	Min Delta	Avg Delta	Max Delta	Std Delta
0	-0.663	-0.317	0.01	0.27565	-0.57	-0.2596	0.069	0.24889	-0.02	0.0574	0.116	0.05252
20	-0.986	0.3829	1.597	0.82353	-1.009	0.4202	1.589	0.82335	-0.045	0.0373	0.174	0.07064
30	-1.517	0.1429	1.69	1.0462	-1.476	0.2355	1.764	1.0464	-0.02	0.0926	0.343	0.10636

Device Test: 11.34 UJP0M9(dCLR_4A_CH4_UJP0M9)

TID vs Result Stats

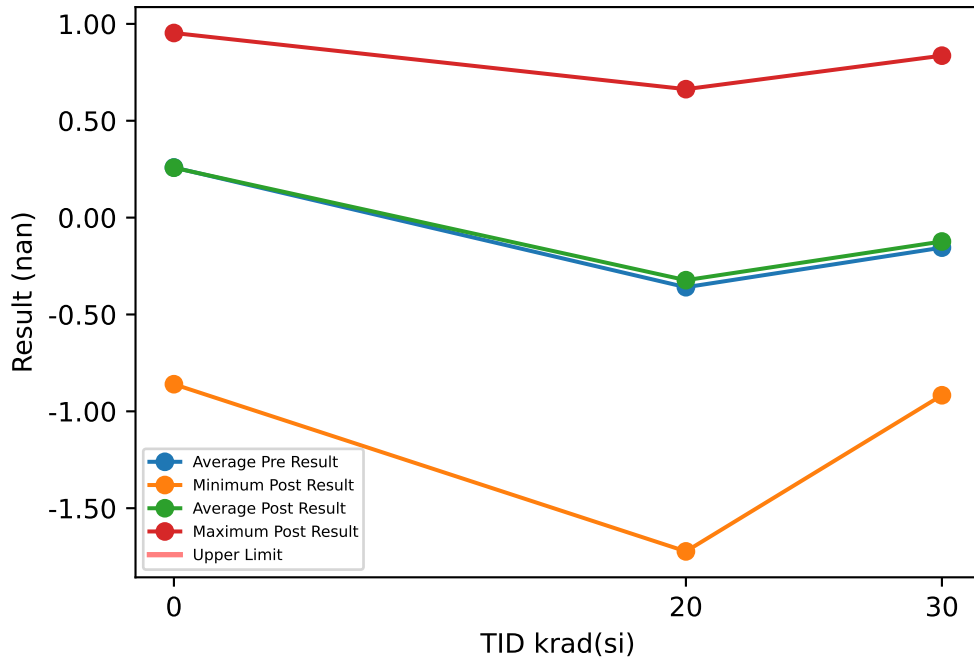

Test Results (No Limits Specified (nan))

Serial #	krad(si)	Exposure Conditions	Pre Result	Post Result	Delta
50	20	LDR biased	0.62	0.552	-0.068
51	20	LDR biased	-0.177	-0.018	0.159
52	20	LDR biased	-0.15	-0.184	-0.034
53	20	LDR biased	-0.567	-0.643	-0.076
54	20	LDR biased	-0.866	-0.849	0.017
55	30	LDR biased	-0.653	-0.44	0.213
56	30	LDR biased	-0.865	-0.906	-0.041
57	30	LDR biased	-0.531	-0.53	0.001
58	30	LDR biased	0.648	0.64	-0.008
59	30	LDR biased	0.627	0.55	-0.077
60	20	LDR unbiased	0.285	0.444	0.159
61	20	LDR unbiased	-1.732	-1.668	0.064
62	20	LDR unbiased	0.091	0.196	0.105
63	20	LDR unbiased	-1.656	-1.723	-0.067
64	20	LDR unbiased	0.559	0.663	0.104
65	30	LDR unbiased	0.595	0.578	-0.017
66	30	LDR unbiased	0.908	0.836	-0.072
67	30	LDR unbiased	-0.968	-0.862	0.106
68	30	LDR unbiased	-0.323	-0.182	0.141
69	30	LDR unbiased	-0.988	-0.917	0.071
70	0	correlation	0.699	0.717	0.018
71	0	correlation	-0.847	-0.86	-0.013
72	0	correlation	0.958	0.953	-0.005
73	0	correlation	-0.07	-0.048	0.022
74	0	correlation	0.554	0.526	-0.028

TID vs Post - Pre Exposure Delta

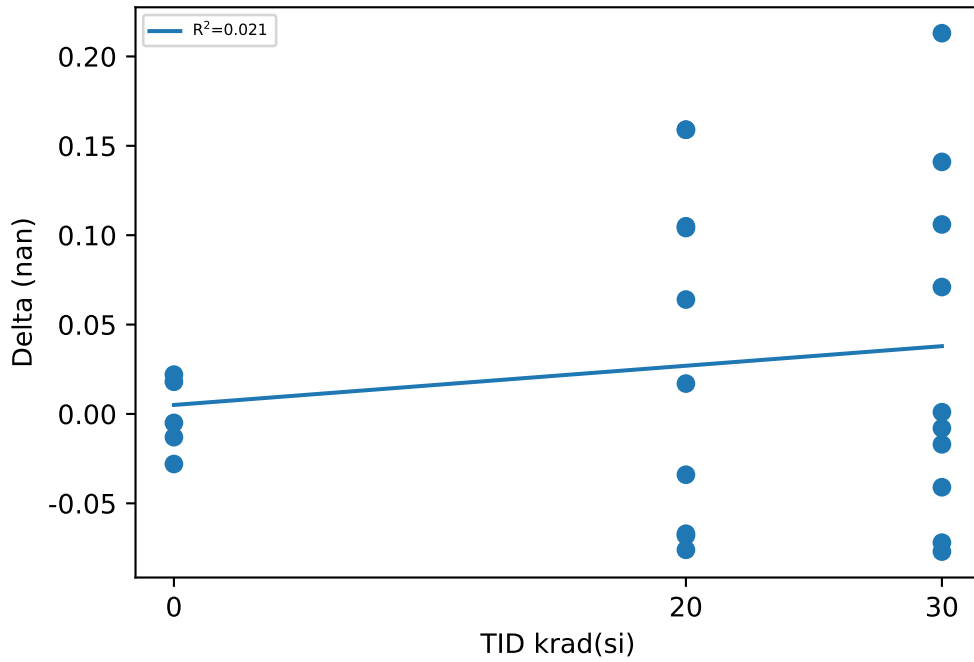

Test Statistics (nan)

krad(si)	Pre Exposure Min	Pre Exposure Avg	Pre Exposure Max	Pre Exposure Std	Post Exposure Min	Post Exposure Avg	Post Exposure Max	Post Exposure Std	Min Delta	Avg Delta	Max Delta	Std Delta
0	-0.847	0.2588	0.958	0.72469	-0.86	0.2576	0.953	0.72614	-0.028	-0.0012	0.022	0.021088
20	-1.732	-0.3593	0.62	0.84082	-1.723	-0.323	0.663	0.87279	-0.076	0.0363	0.159	0.094078
30	-0.988	-0.155	0.908	0.76197	-0.917	-0.1233	0.836	0.70753	-0.077	0.0317	0.213	0.096969

Device Test: 11.39 UJET8J(KCL_2A_CH1_UJET8J)

TID vs Result Stats

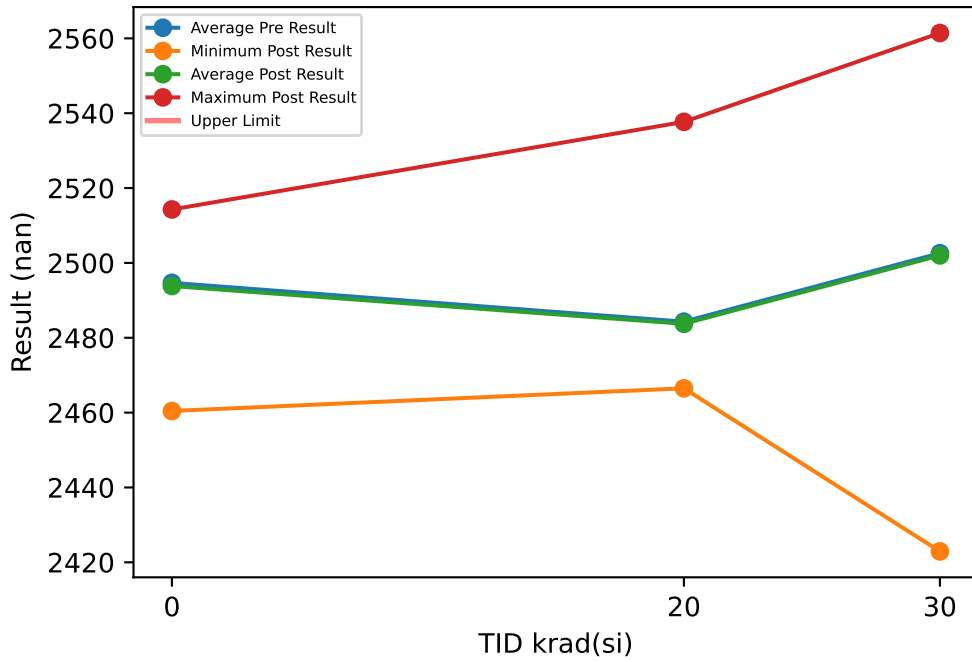

Test Results (No Limits Specified (nan))

Serial #	krad(si)	Exposure Conditions	Pre Result	Post Result	Delta
50	20	LDR biased	2480	2472.3	-7.689
51	20	LDR biased	2537.4	2537.7	0.302
52	20	LDR biased	2475.6	2466.5	-9.1
53	20	LDR biased	2471	2473.4	2.383
54	20	LDR biased	2475.6	2480.8	5.26
55	30	LDR biased	2509	2504.2	-4.841
56	30	LDR biased	2427.1	2422.9	-4.149
57	30	LDR biased	2466.9	2477	10.111
58	30	LDR biased	2504.6	2497.4	-7.15
59	30	LDR biased	2562.6	2561.4	-1.14
60	20	LDR unbiased	2468.3	2470.5	2.244
61	20	LDR unbiased	2484.6	2485.4	0.851
62	20	LDR unbiased	2493.4	2493.9	0.405
63	20	LDR unbiased	2476.3	2475	-1.319
64	20	LDR unbiased	2480.8	2481.8	0.962
65	30	LDR unbiased	2526.9	2529.7	2.773
66	30	LDR unbiased	2508.3	2507.3	-1.057
67	30	LDR unbiased	2549.2	2551.4	2.217
68	30	LDR unbiased	2464.9	2463.5	-1.391
69	30	LDR unbiased	2506.6	2505.4	-1.208
70	0	correlation	2519.8	2514.3	-5.479
71	0	correlation	2503.7	2502.7	-1.038
72	0	correlation	2458.7	2460.4	1.707
73	0	correlation	2496.7	2495.7	-0.971
74	0	correlation	2494.5	2496	1.528

TID vs Post - Pre Exposure Delta

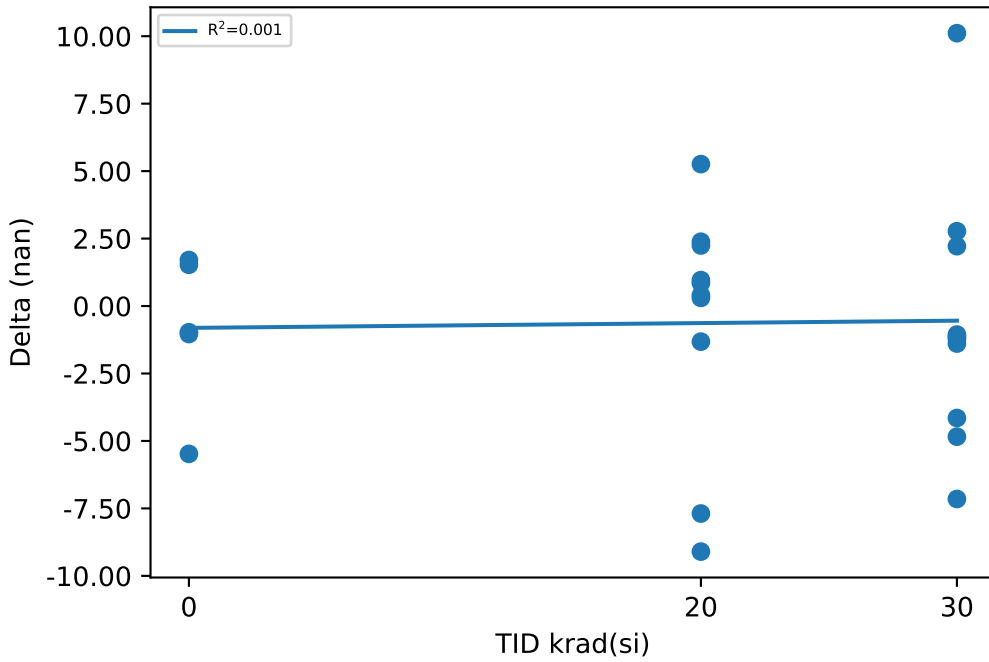

Test Statistics (nan)

krad(si)	Pre Exposure Min	Pre Exposure Avg	Pre Exposure Max	Pre Exposure Std	Post Exposure Min	Post Exposure Avg	Post Exposure Max	Post Exposure Std	Min Delta	Avg Delta	Max Delta	Std Delta
0	2458.7	2494.7	2519.8	22.402	2460.4	2493.8	2514.3	20.125	-5.479	-0.8506	1.707	2.9013
20	2468.3	2484.3	2537.4	19.949	2466.5	2483.7	2537.7	20.587	-9.1	-0.5701	5.26	4.4809
30	2427.1	2502.6	2562.6	40.627	2422.9	2502	2561.4	41.049	-7.15	-0.5835	10.111	4.8191

Device Test: 11.4 UJSYNT(dCLR_P5A_CH2_UJSYNT)

TID vs Result Stats

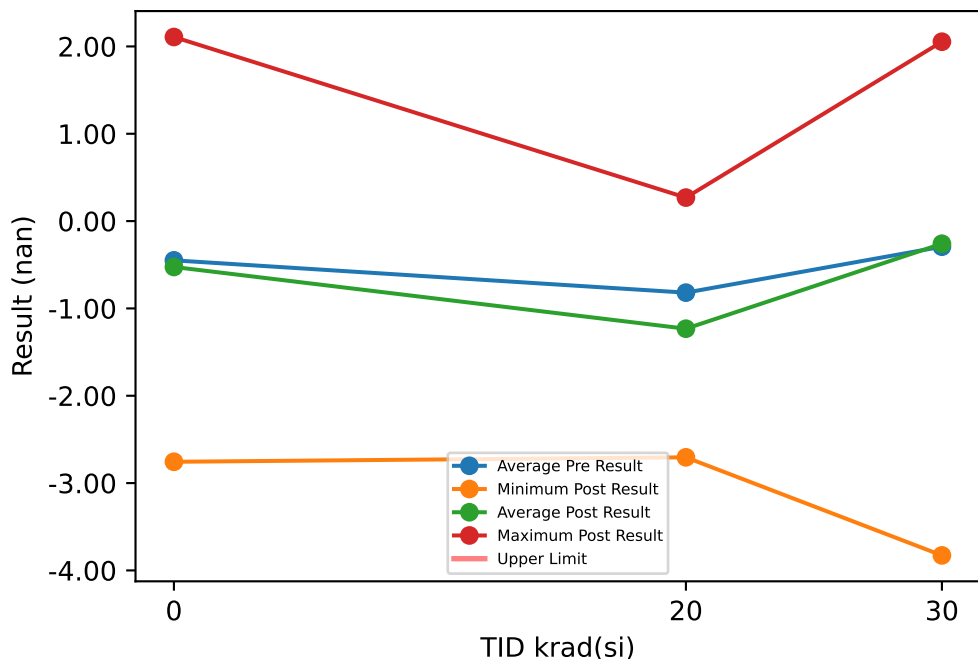

Test Results (No Limits Specified (nan))

Serial #	krad(si)	Exposure Conditions	Pre Result	Post Result	Delta
50	20	LDR biased	-0.555	-0.997	-0.442
51	20	LDR biased	-1.266	-1.286	-0.02
52	20	LDR biased	-0.084	-1.087	-1.003
53	20	LDR biased	-0.969	-1.136	-0.167
54	20	LDR biased	-1.97	-2.705	-0.735
55	30	LDR biased	-3.003	-3.828	-0.825
56	30	LDR biased	-0.448	0.767	1.215
57	30	LDR biased	1.031	1.08	0.049
58	30	LDR biased	0.37	0.807	0.437
59	30	LDR biased	-2.539	-2.341	0.198
60	20	LDR unbiased	-0.79	-2.133	-1.343
61	20	LDR unbiased	-1.143	-1.062	0.081
62	20	LDR unbiased	0.27	0.269	-0.001
63	20	LDR unbiased	-0.975	-1.221	-0.246
64	20	LDR unbiased	-0.711	-0.965	-0.254
65	30	LDR unbiased	1.531	1.028	-0.503
66	30	LDR unbiased	1.537	2.054	0.517
67	30	LDR unbiased	0.959	0.018	-0.941
68	30	LDR unbiased	-1.094	-0.357	0.737
69	30	LDR unbiased	-1.276	-1.821	-0.545
70	0	correlation	-0.367	-0.347	0.02
71	0	correlation	-0.678	-0.674	0.004
72	0	correlation	-0.851	-0.958	-0.107
73	0	correlation	2.458	2.108	-0.35
74	0	correlation	-2.809	-2.756	0.053

TID vs Post - Pre Exposure Delta

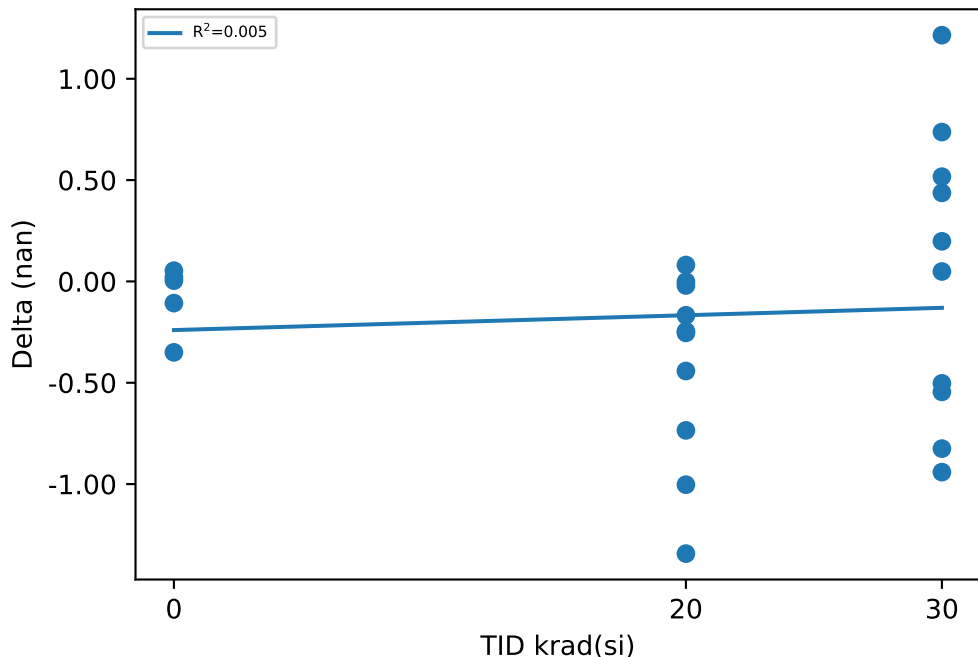

Test Statistics (nan)

krad(si)	Pre Exposure Min	Pre Exposure Avg	Pre Exposure Max	Pre Exposure Std	Post Exposure Min	Post Exposure Avg	Post Exposure Max	Post Exposure Std	Min Delta	Avg Delta	Max Delta	Std Delta
0	-2.809	-0.4494	2.458	1.8869	-2.756	-0.5254	2.108	1.7429	-0.35	-0.076	0.053	0.16454
20	-1.97	-0.8193	0.27	0.62225	-2.705	-1.2323	0.269	0.77626	-1.343	-0.413	0.081	0.47134
30	-3.003	-0.2932	1.537	1.6484	-3.828	-0.2593	2.054	1.8435	-0.941	0.0339	1.215	0.71678

Device Test: 11.40 UJET8J(KCL_2A_CH2_UJET8J)

TID vs Result Stats

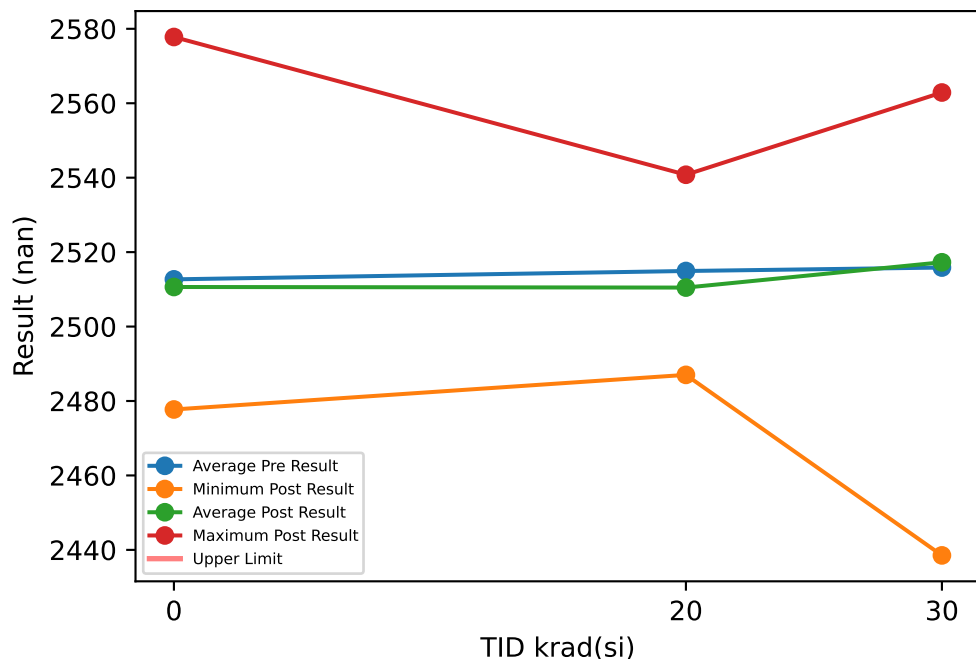

Test Results (No Limits Specified (nan))

Serial #	krad(si)	Exposure Conditions	Pre Result	Post Result	Delta
50	20	LDR biased	2509.8	2507.8	-2.067
51	20	LDR biased	2509.7	2507.4	-2.236
52	20	LDR biased	2531	2521.8	-9.193
53	20	LDR biased	2520.8	2517.1	-3.743
54	20	LDR biased	2497.6	2493.1	-4.444
55	30	LDR biased	2445.9	2438.5	-7.363
56	30	LDR biased	2526.5	2535.2	8.746
57	30	LDR biased	2549.8	2552.6	2.781
58	30	LDR biased	2559.9	2562.9	2.962
59	30	LDR biased	2455.2	2462.9	7.768
60	20	LDR unbiased	2498.9	2487	-11.846
61	20	LDR unbiased	2508.3	2504.1	-4.193
62	20	LDR unbiased	2531.5	2531.3	-0.224
63	20	LDR unbiased	2496.9	2494.3	-2.58
64	20	LDR unbiased	2544.8	2540.8	-4.009
65	30	LDR unbiased	2559.8	2552.8	-7.048
66	30	LDR unbiased	2533.1	2540.8	7.784
67	30	LDR unbiased	2565.2	2562.3	-2.818
68	30	LDR unbiased	2481.7	2485.7	4.023
69	30	LDR unbiased	2481.6	2478.9	-2.67
70	0	correlation	2478.7	2477.7	-0.989
71	0	correlation	2490.7	2490.4	-0.3
72	0	correlation	2512.7	2508.7	-3.967
73	0	correlation	2582.8	2577.8	-5.016
74	0	correlation	2498.5	2498.5	0.001

TID vs Post - Pre Exposure Delta

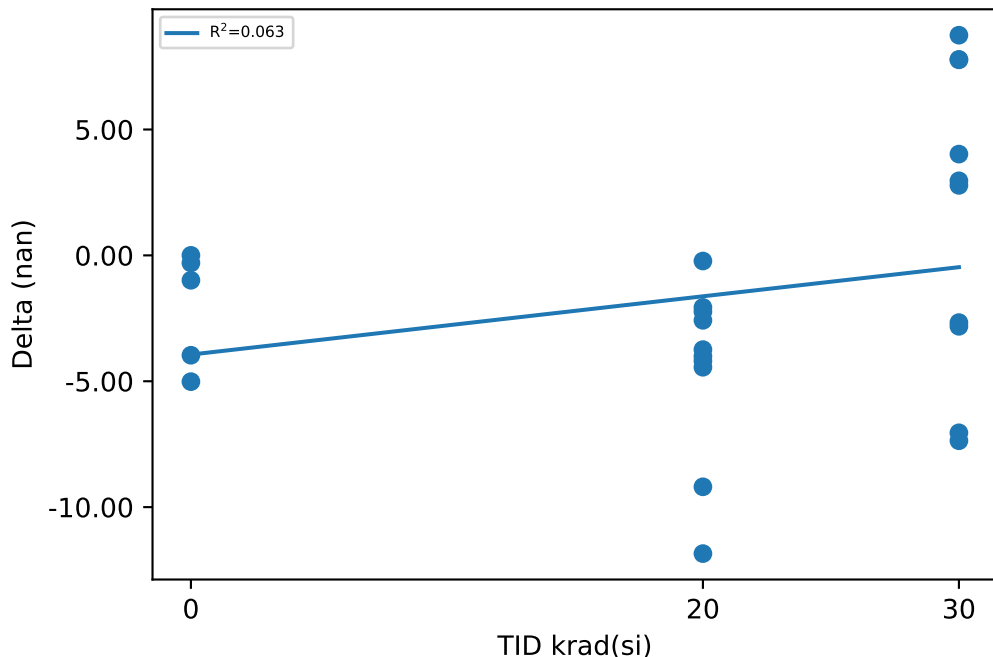

Test Statistics (nan)

krad(si)	Pre Exposure Min	Pre Exposure Avg	Pre Exposure Max	Pre Exposure Std	Post Exposure Min	Post Exposure Avg	Post Exposure Max	Post Exposure Std	Min Delta	Avg Delta	Max Delta	Std Delta
0	2478.7	2512.7	2582.8	41.098	2477.7	2510.6	2577.8	39.224	-5.016	-2.0542	0.001	2.284
20	2496.9	2514.9	2544.8	16.473	2487	2510.5	2540.8	17.298	-11.846	-4.4535	-0.224	3.4943
30	2445.9	2515.9	2565.2	45.693	2438.5	2517.3	2562.9	46.093	-7.363	1.4165	8.746	6.0462

Device Test: 11.41 UJET8J(KCL_2A_CH3_UJET8J)

TID vs Result Stats

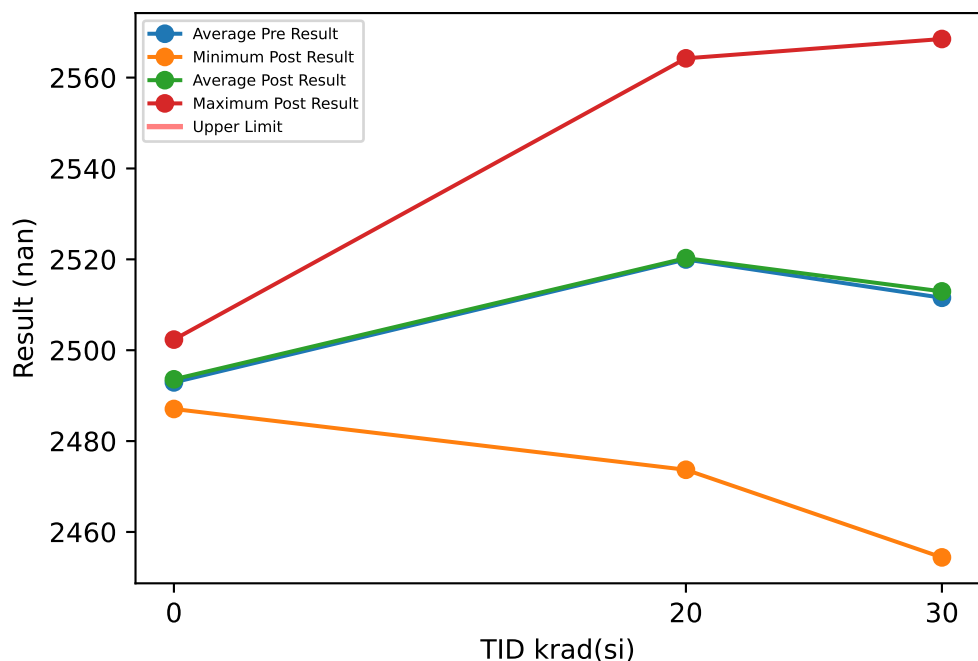

Test Results (No Limits Specified (nan))

Serial #	krad(si)	Exposure Conditions	Pre Result	Post Result	Delta
50	20	LDR biased	2563.2	2564.2	1.081
51	20	LDR biased	2550.5	2549	-1.465
52	20	LDR biased	2529	2528.5	-0.437
53	20	LDR biased	2503.9	2507.4	3.481
54	20	LDR biased	2475.6	2473.7	-1.923
55	30	LDR biased	2484.1	2479	-5.035
56	30	LDR biased	2524.4	2522.3	-2.108
57	30	LDR biased	2523.6	2526.8	3.187
58	30	LDR biased	2453.9	2454.4	0.518
59	30	LDR biased	2549.2	2550.3	1.052
60	20	LDR unbiased	2514.5	2513.2	-1.357
61	20	LDR unbiased	2550.6	2549.6	-1.032
62	20	LDR unbiased	2499.6	2497.2	-2.421
63	20	LDR unbiased	2505.8	2509	3.187
64	20	LDR unbiased	2506.9	2510.7	3.846
65	30	LDR unbiased	2504.1	2513.8	9.771
66	30	LDR unbiased	2455.9	2455.8	-0.046
67	30	LDR unbiased	2565.7	2568.5	2.836
68	30	LDR unbiased	2533.4	2534.8	1.32
69	30	LDR unbiased	2521.2	2523.7	2.542
70	0	correlation	2503.4	2502.3	-1.079
71	0	correlation	2487.8	2488.8	0.949
72	0	correlation	2496.3	2495.7	-0.575
73	0	correlation	2484.5	2487.1	2.575
74	0	correlation	2492.5	2494.1	1.53

TID vs Post - Pre Exposure Delta

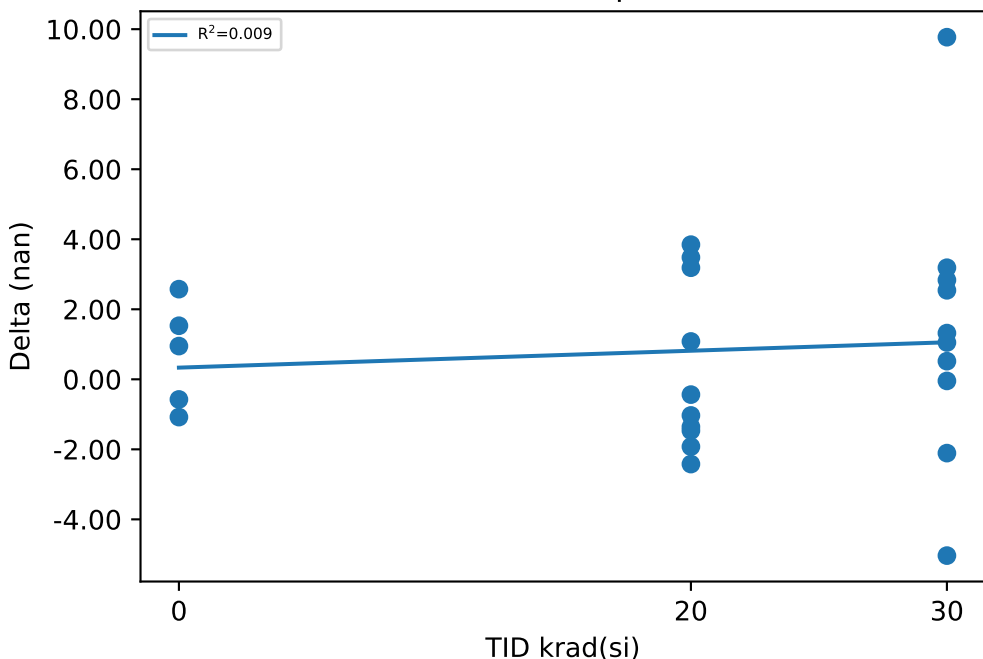

Test Statistics (nan)

krad(si)	Pre Exposure Min	Pre Exposure Avg	Pre Exposure Max	Pre Exposure Std	Post Exposure Min	Post Exposure Avg	Post Exposure Max	Post Exposure Std	Min Delta	Avg Delta	Max Delta	Std Delta
0	2484.5	2492.9	2503.4	7.3954	2487.1	2493.6	2502.3	6.0635	-1.079	0.68	2.575	1.5046
20	2475.6	2520	2563.2	27.597	2473.7	2520.3	2564.2	27.53	-2.421	0.296	3.846	2.4074
30	2453.9	2511.5	2565.7	37.219	2454.4	2512.9	2568.5	38.286	-5.035	1.4037	9.771	3.8492

Device Test: 11.42 UJET8J(KCL_2A_CH4_UJET8J)

TID vs Result Stats

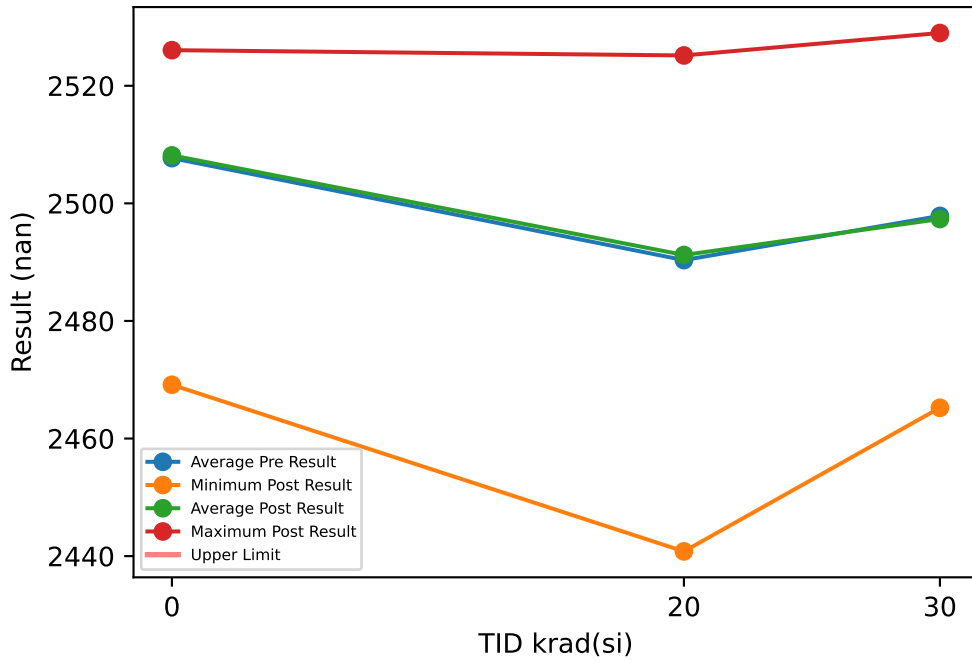

Test Results (No Limits Specified (nan))

Serial #	krad(si)	Exposure Conditions	Pre Result	Post Result	Delta
50	20	LDR biased	2521.2	2518.1	-3.1
51	20	LDR biased	2504.6	2511.3	6.735
52	20	LDR biased	2487	2487.4	0.44
53	20	LDR biased	2479	2470.9	-8.109
54	20	LDR biased	2477.9	2476.2	-1.712
55	30	LDR biased	2480	2487	6.994
56	30	LDR biased	2469	2465.2	-3.814
57	30	LDR biased	2493.1	2493.9	0.762
58	30	LDR biased	2518.9	2518.7	-0.184
59	30	LDR biased	2524.7	2516.2	-8.434
60	20	LDR unbiased	2513.9	2520.2	6.319
61	20	LDR unbiased	2445.2	2447.4	2.235
62	20	LDR unbiased	2512.3	2514.7	2.424
63	20	LDR unbiased	2442.8	2440.8	-1.996
64	20	LDR unbiased	2519.7	2525.2	5.478
65	30	LDR unbiased	2533	2529	-4.007
66	30	LDR unbiased	2525.9	2520.4	-5.479
67	30	LDR unbiased	2471	2472.1	1.128
68	30	LDR unbiased	2492.9	2500.2	7.366
69	30	LDR unbiased	2470.2	2470.6	0.392
70	0	correlation	2524.5	2525.7	1.212
71	0	correlation	2469.2	2469.1	-0.031
72	0	correlation	2526	2526.1	0.096
73	0	correlation	2509.1	2509.8	0.742
74	0	correlation	2509.8	2510.1	0.314

TID vs Post - Pre Exposure Delta

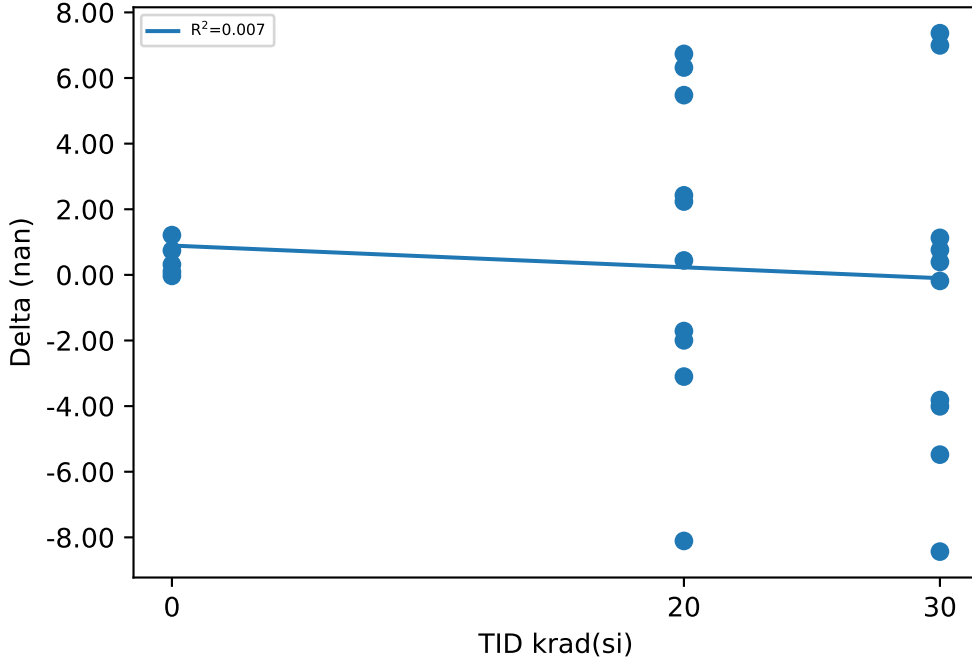

Test Statistics (nan)

krad(si)	Pre Exposure Min	Pre Exposure Avg	Pre Exposure Max	Pre Exposure Std	Post Exposure Min	Post Exposure Avg	Post Exposure Max	Post Exposure Std	Min Delta	Avg Delta	Max Delta	Std Delta
0	2469.2	2507.7	2526	22.943	2469.1	2508.2	2526.1	23.219	-0.031	0.4666	1.212	0.50983
20	2442.8	2490.3	2521.2	29.144	2440.8	2491.2	2525.2	31.238	-8.109	0.8714	6.735	4.7264
30	2469	2497.9	2533	25.536	2465.2	2497.3	2529	23.24	-8.434	-0.5276	7.366	5.101

Device Test: 11.43 UJET8J(KCL_3A_CH1_UJET8J)

TID vs Result Stats

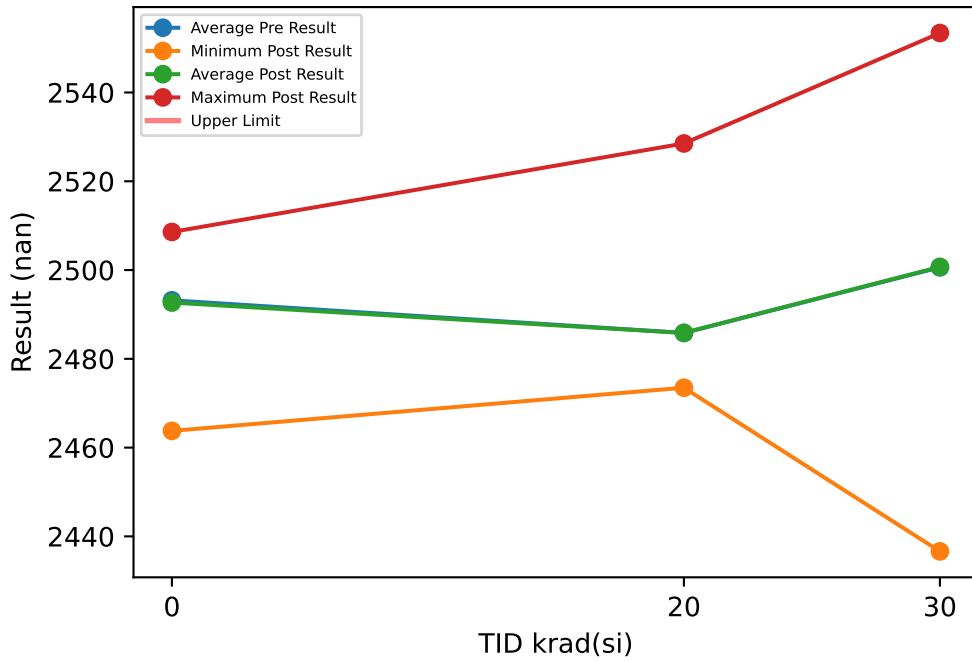

Test Results (No Limits Specified (nan))

Serial #	krad(si)	Exposure Conditions	Pre Result	Post Result	Delta
50	20	LDR biased	2479.4	2477.2	-2.194
51	20	LDR biased	2529.2	2528.5	-0.719
52	20	LDR biased	2478.9	2473.5	-5.377
53	20	LDR biased	2477.4	2479.1	1.616
54	20	LDR biased	2476.5	2481.2	4.66
55	30	LDR biased	2509.8	2506.6	-3.221
56	30	LDR biased	2438.1	2436.6	-1.474
57	30	LDR biased	2466.7	2473.9	7.214
58	30	LDR biased	2495.7	2491	-4.697
59	30	LDR biased	2554.4	2553.4	-1.043
60	20	LDR unbiased	2479.6	2480.5	0.819
61	20	LDR unbiased	2489.5	2490.8	1.322
62	20	LDR unbiased	2487.8	2488.8	1.044
63	20	LDR unbiased	2480.6	2478.8	-1.815
64	20	LDR unbiased	2479.4	2480	0.579
65	30	LDR unbiased	2518.6	2520.8	2.234
66	30	LDR unbiased	2506.4	2506.1	-0.345
67	30	LDR unbiased	2542.3	2544.4	2.126
68	30	LDR unbiased	2468.6	2469.1	0.56
69	30	LDR unbiased	2505.5	2505.2	-0.275
70	0	correlation	2514.4	2508.6	-5.87
71	0	correlation	2502.5	2502.2	-0.24
72	0	correlation	2461.5	2463.8	2.3
73	0	correlation	2490.6	2489.8	-0.709
74	0	correlation	2497	2499	1.977

TID vs Post - Pre Exposure Delta

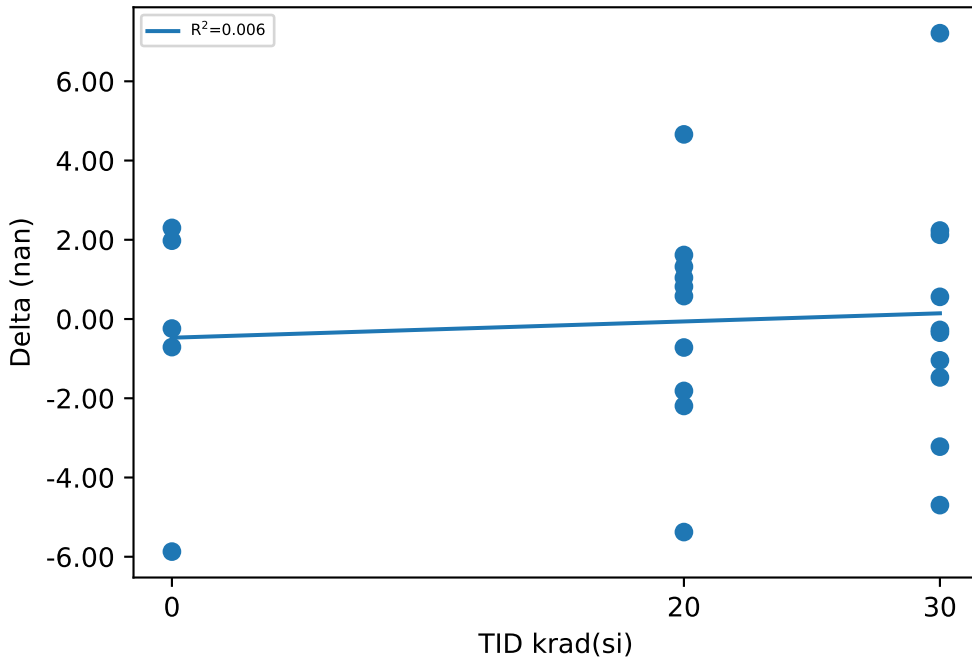

Test Statistics (nan)

krad(si)	Pre Exposure Min	Pre Exposure Avg	Pre Exposure Max	Pre Exposure Std	Post Exposure Min	Post Exposure Avg	Post Exposure Max	Post Exposure Std	Min Delta	Avg Delta	Max Delta	Std Delta
0	2461.5	2493.2	2514.4	19.785	2463.8	2492.7	2508.6	17.518	-5.87	-0.5084	2.3	3.2758
20	2476.5	2485.8	2529.2	15.83	2473.5	2485.8	2528.5	15.856	-5.377	-0.0065	4.66	2.702
30	2438.1	2500.6	2554.4	35.289	2436.6	2500.7	2553.4	35.103	-4.697	0.1079	7.214	3.2938

Device Test: 11.44 UJET8J(KCL_3A_CH2_UJET8J)

TID vs Result Stats

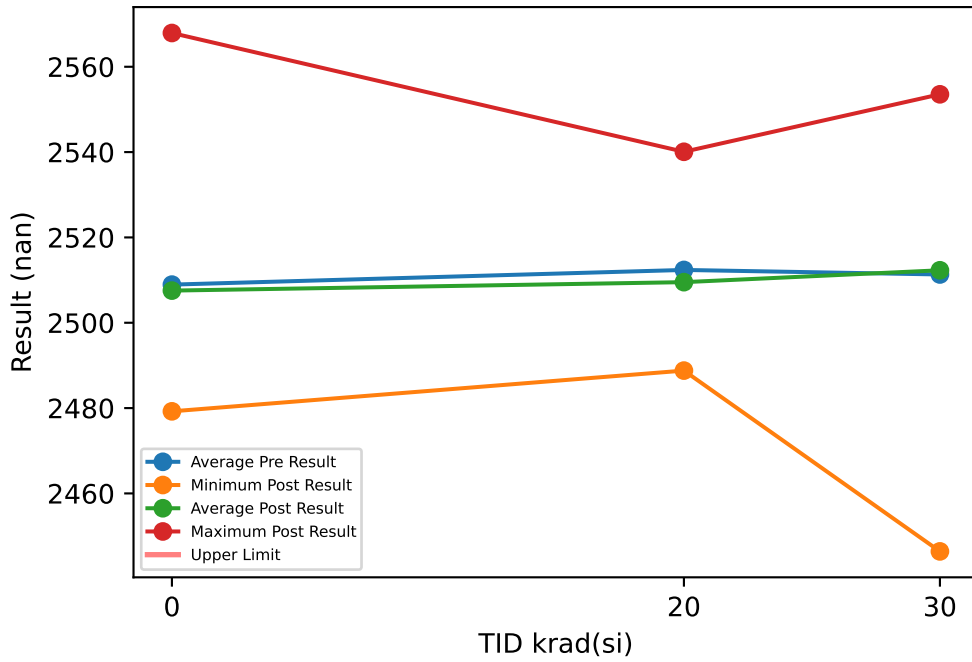

Test Results (No Limits Specified (nan))

Serial #	krad(si)	Exposure Conditions	Pre Result	Post Result	Delta
50	20	LDR biased	2505.7	2505.1	-0.6
51	20	LDR biased	2508	2507.7	-0.26
52	20	LDR biased	2529.5	2522.2	-7.287
53	20	LDR biased	2518.5	2514.3	-4.142
54	20	LDR biased	2496.7	2494.4	-2.303
55	30	LDR biased	2453.4	2446.4	-6.987
56	30	LDR biased	2520.2	2526.1	5.89
57	30	LDR biased	2542.7	2545.3	2.663
58	30	LDR biased	2550.4	2553.5	3.173
59	30	LDR biased	2458.5	2464.3	5.804
60	20	LDR unbiased	2497.1	2488.8	-8.289
61	20	LDR unbiased	2506.1	2503.6	-2.473
62	20	LDR unbiased	2524.2	2524.7	0.48
63	20	LDR unbiased	2496.4	2494.2	-2.199
64	20	LDR unbiased	2541.6	2540.1	-1.553
65	30	LDR unbiased	2545.6	2540.3	-5.241
66	30	LDR unbiased	2521.6	2530.1	8.542
67	30	LDR unbiased	2554.5	2551.1	-3.449
68	30	LDR unbiased	2484.4	2486.7	2.295
69	30	LDR unbiased	2482	2479.1	-2.876
70	0	correlation	2478.7	2479.2	0.565
71	0	correlation	2486.3	2484.3	-2.013
72	0	correlation	2509.2	2505.6	-3.631
73	0	correlation	2570.3	2567.9	-2.353
74	0	correlation	2500.2	2500.6	0.419

TID vs Post - Pre Exposure Delta

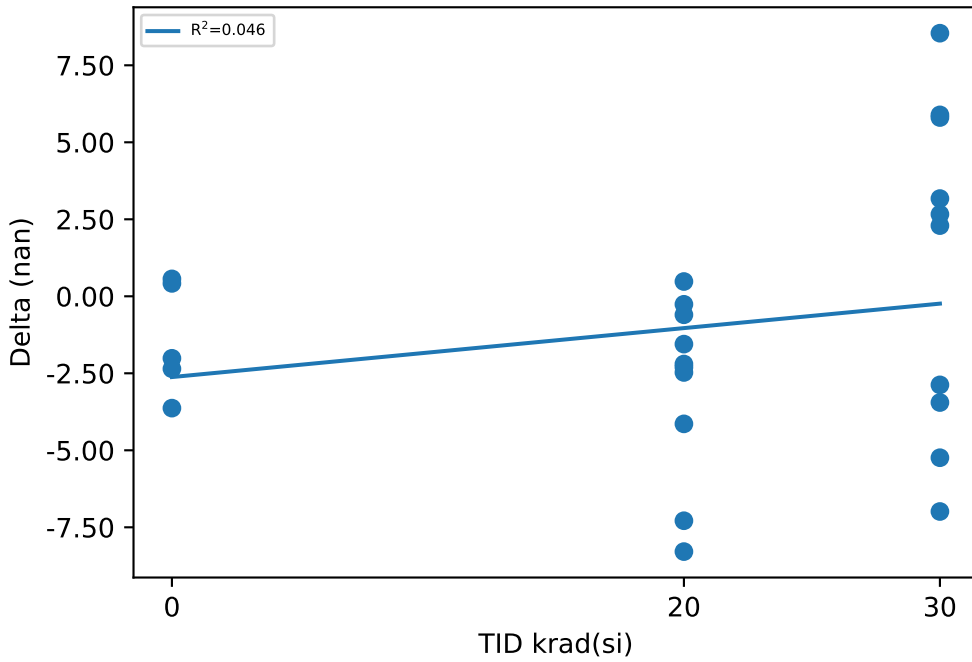

Test Statistics (nan)

krad(si)	Pre Exposure Min	Pre Exposure Avg	Pre Exposure Max	Pre Exposure Std	Post Exposure Min	Post Exposure Avg	Post Exposure Max	Post Exposure Std	Min Delta	Avg Delta	Max Delta	Std Delta
0	2478.7	2508.9	2570.3	36.279	2479.2	2507.5	2567.9	35.485	-3.631	-1.4026	0.565	1.8324
20	2496.4	2512.4	2541.6	15.516	2488.8	2509.5	2540.1	15.99	-8.289	-2.8626	0.48	2.9125
30	2453.4	2511.3	2554.5	38.682	2446.4	2512.3	2553.5	39.434	-6.987	0.9814	8.542	5.2767

Device Test: 11.45 UJET8J(KCL_3A_CH3_UJET8J)

TID vs Result Stats

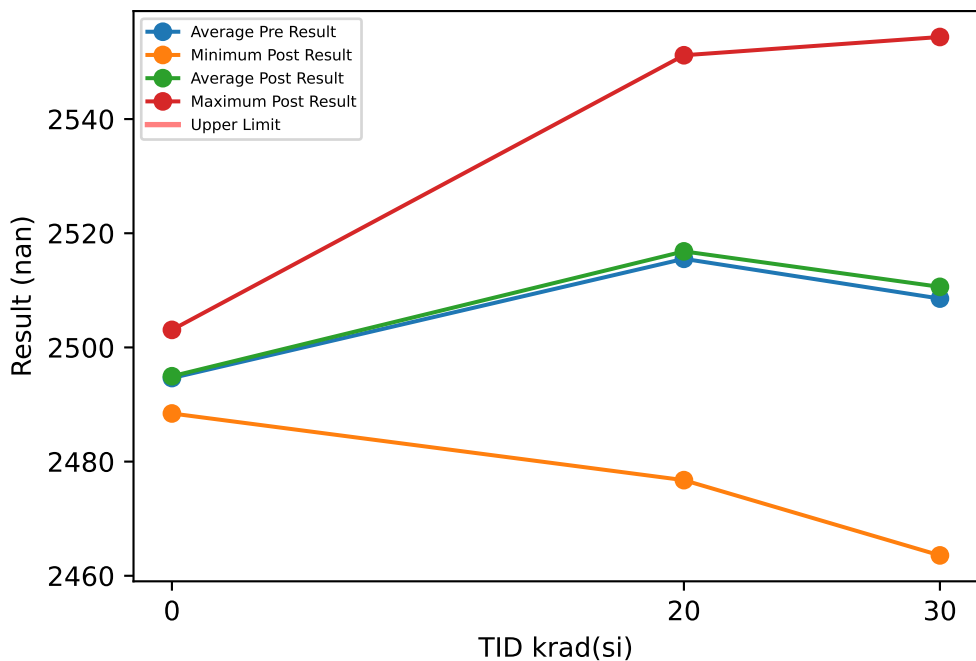

Test Results (No Limits Specified (nan))

Serial #	krad(si)	Exposure Conditions	Pre Result	Post Result	Delta
50	20	LDR biased	2552	2551.2	-0.78
51	20	LDR biased	2541.6	2542.9	1.258
52	20	LDR biased	2520.6	2520	-0.683
53	20	LDR biased	2502.8	2507.3	4.532
54	20	LDR biased	2476.5	2476.8	0.26
55	30	LDR biased	2485.9	2484.5	-1.391
56	30	LDR biased	2519.6	2519.1	-0.508
57	30	LDR biased	2518.7	2522	3.321
58	30	LDR biased	2462.8	2465.3	2.508
59	30	LDR biased	2538.6	2540.5	1.817
60	20	LDR unbiased	2511.5	2511.4	-0.125
61	20	LDR unbiased	2544.3	2545	0.776
62	20	LDR unbiased	2497.4	2498.6	1.192
63	20	LDR unbiased	2506.4	2508.8	2.344
64	20	LDR unbiased	2502.1	2506.3	4.261
65	30	LDR unbiased	2500	2507.4	7.376
66	30	LDR unbiased	2460.7	2463.6	2.833
67	30	LDR unbiased	2553.8	2554.4	0.619
68	30	LDR unbiased	2528.3	2529.5	1.213
69	30	LDR unbiased	2517.2	2519.9	2.738
70	0	correlation	2503.2	2503.1	-0.176
71	0	correlation	2488	2488.4	0.475
72	0	correlation	2498.6	2497.6	-1.01
73	0	correlation	2490.7	2492.5	1.806
74	0	correlation	2492.7	2493.2	0.484

TID vs Post - Pre Exposure Delta

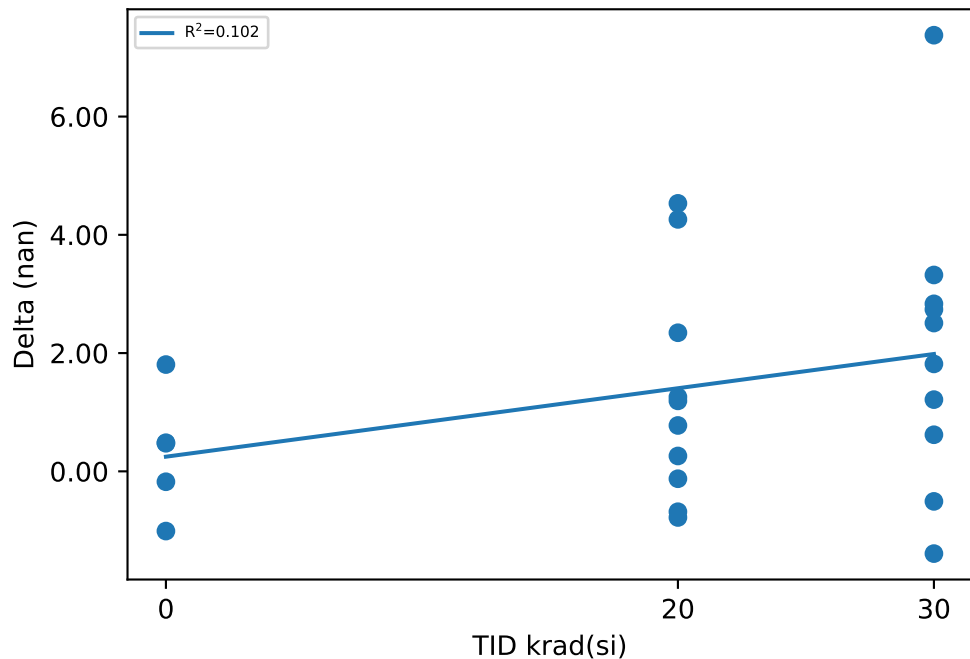

Test Statistics (nan)

krad(si)	Pre Exposure Min	Pre Exposure Avg	Pre Exposure Max	Pre Exposure Std	Post Exposure Min	Post Exposure Avg	Post Exposure Max	Post Exposure Std	Min Delta	Avg Delta	Max Delta	Std Delta
0	2488	2494.6	2503.2	6.2115	2488.4	2495	2503.1	5.5886	-1.01	0.3158	1.806	1.0337
20	2476.5	2515.5	2552	23.932	2476.8	2516.8	2551.2	23.329	-0.78	1.3035	4.532	1.8845
30	2460.7	2508.6	2553.8	30.922	2463.6	2510.6	2554.4	30.571	-1.391	2.0526	7.376	2.4144

Device Test: 11.46 UJET8J(KCL_3A_CH4_UJET8J)

TID vs Result Stats

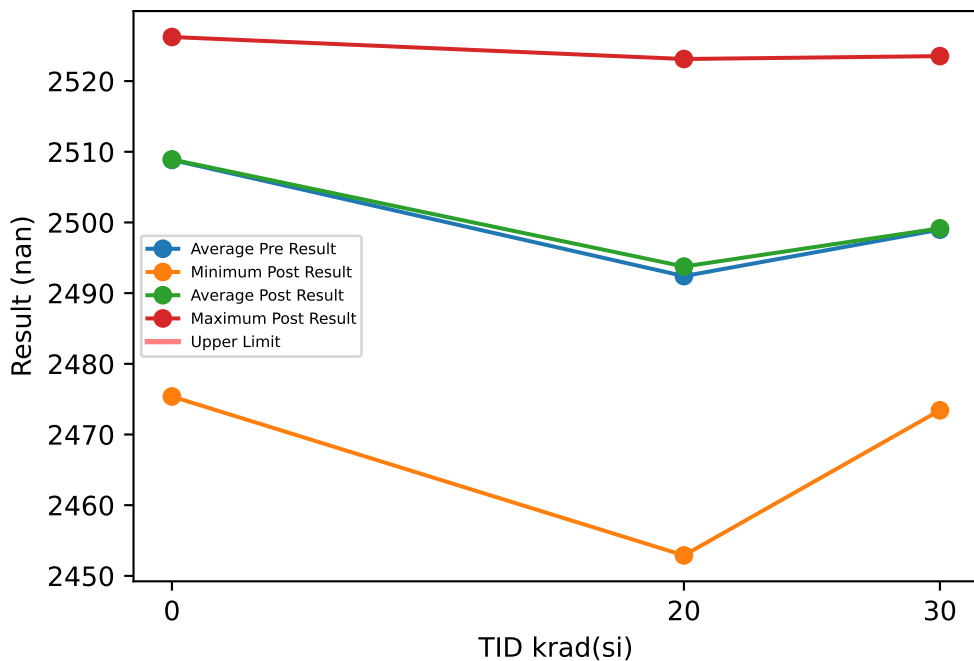

Test Results (No Limits Specified (nan))

Serial #	krad(si)	Exposure Conditions	Pre Result	Post Result	Delta
50	20	LDR biased	2519.1	2517.4	-1.709
51	20	LDR biased	2500.5	2506.9	6.398
52	20	LDR biased	2495	2494.2	-0.834
53	20	LDR biased	2484.4	2479.4	-5.049
54	20	LDR biased	2479.4	2480.3	0.929
55	30	LDR biased	2483.7	2490.5	6.81
56	30	LDR biased	2477.4	2473.4	-3.974
57	30	LDR biased	2491.9	2491.7	-0.12
58	30	LDR biased	2519.7	2518.9	-0.778
59	30	LDR biased	2520.8	2517.8	-2.957
60	20	LDR unbiased	2511.9	2516.4	4.485
61	20	LDR unbiased	2452.8	2455	2.21
62	20	LDR unbiased	2507.7	2512	4.312
63	20	LDR unbiased	2453.8	2452.9	-0.932
64	20	LDR unbiased	2519.4	2523.1	3.747
65	30	LDR unbiased	2524.7	2522.6	-2.105
66	30	LDR unbiased	2525.8	2523.5	-2.255
67	30	LDR unbiased	2475.6	2476.8	1.231
68	30	LDR unbiased	2494.5	2499.7	5.177
69	30	LDR unbiased	2475.8	2476.6	0.857
70	0	correlation	2522.7	2523.2	0.538
71	0	correlation	2476.3	2475.4	-0.871
72	0	correlation	2526.3	2526.2	-0.076
73	0	correlation	2504.5	2504.7	0.192
74	0	correlation	2514.4	2515	0.569

TID vs Post - Pre Exposure Delta

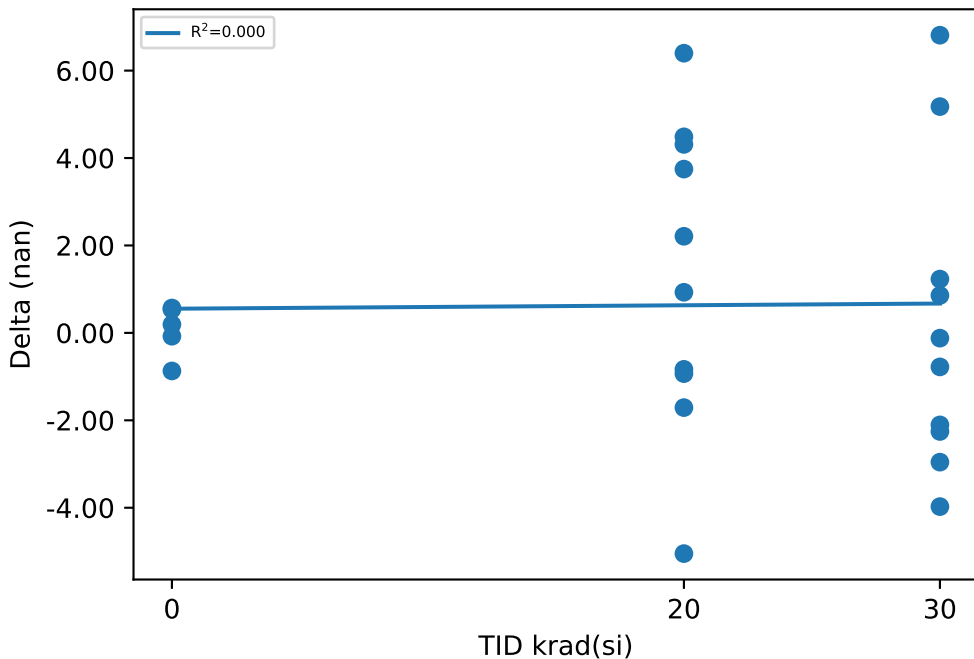

Test Statistics (nan)

krad(si)	Pre Exposure Min	Pre Exposure Avg	Pre Exposure Max	Pre Exposure Std	Post Exposure Min	Post Exposure Avg	Post Exposure Max	Post Exposure Std	Min Delta	Avg Delta	Max Delta	Std Delta
0	2476.3	2508.8	2526.3	20.061	2475.4	2508.9	2526.2	20.523	-0.871	0.0704	0.569	0.58943
20	2452.8	2492.4	2519.4	24.541	2452.9	2493.8	2523.1	25.823	-5.049	1.3557	6.398	3.5123
30	2475.6	2499	2525.8	21.452	2473.4	2499.2	2523.5	20.228	-3.974	0.1886	6.81	3.492

Device Test: 11.47 UJET8J(KCL_4A_CH1_UJET8J)

TID vs Result Stats

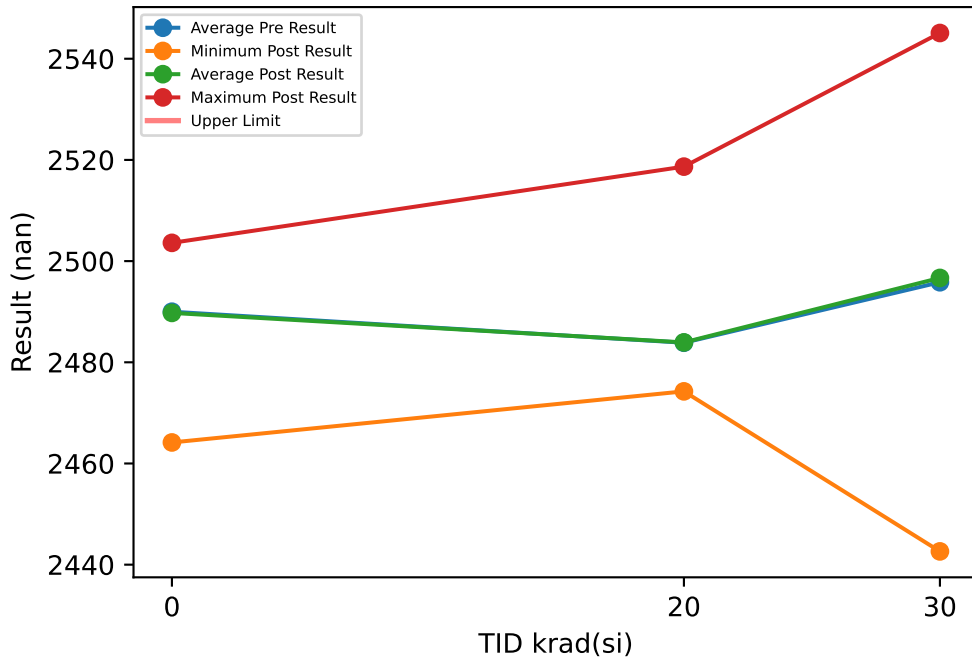

Test Results (No Limits Specified (nan))

Serial #	krad(si)	Exposure Conditions	Pre Result	Post Result	Delta
50	20	LDR biased	2478.4	2475.9	-2.453
51	20	LDR biased	2519	2518.7	-0.324
52	20	LDR biased	2478.1	2474.3	-3.798
53	20	LDR biased	2477.4	2479.5	2.084
54	20	LDR biased	2475.7	2478.2	2.495
55	30	LDR biased	2506.9	2504.6	-2.287
56	30	LDR biased	2443.5	2442.6	-0.895
57	30	LDR biased	2464.5	2470.9	6.497
58	30	LDR biased	2487.2	2484.2	-2.902
59	30	LDR biased	2544.6	2545.1	0.442
60	20	LDR unbiased	2484.5	2484.9	0.343
61	20	LDR unbiased	2488.1	2487.8	-0.289
62	20	LDR unbiased	2482.4	2484.2	1.815
63	20	LDR unbiased	2479.2	2478.4	-0.742
64	20	LDR unbiased	2475.9	2477.4	1.523
65	30	LDR unbiased	2508.8	2511.2	2.436
66	30	LDR unbiased	2501.8	2502.6	0.822
67	30	LDR unbiased	2533.2	2534.6	1.354
68	30	LDR unbiased	2466.8	2468.7	1.886
69	30	LDR unbiased	2501	2502.1	1.172
70	0	correlation	2507.7	2503.6	-4.108
71	0	correlation	2499.5	2499.3	-0.148
72	0	correlation	2462.2	2464.2	2.002
73	0	correlation	2484.8	2485.2	0.336
74	0	correlation	2495.8	2496.6	0.739

TID vs Post - Pre Exposure Delta

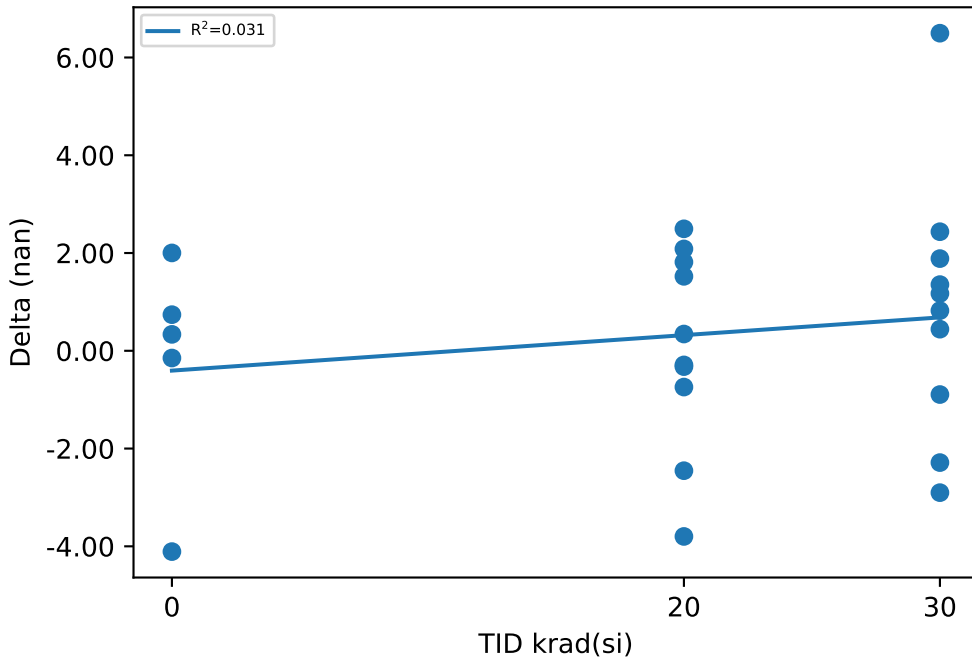

Test Statistics (nan)

krad(si)	Pre Exposure Min	Pre Exposure Avg	Pre Exposure Max	Pre Exposure Std	Post Exposure Min	Post Exposure Avg	Post Exposure Max	Post Exposure Std	Min Delta	Avg Delta	Max Delta	Std Delta
0	2462.2	2490	2507.7	17.602	2464.2	2489.8	2503.6	15.857	-4.108	-0.2358	2.002	2.3069
20	2475.7	2483.9	2519	12.962	2474.3	2483.9	2518.7	12.934	-3.798	0.0654	2.495	2.0395
30	2443.5	2495.8	2544.6	31.215	2442.6	2496.7	2545.1	30.98	-2.902	0.8525	6.497	2.645

Device Test: 11.48 UJET8J(KCL_4A_CH2_UJET8J)

TID vs Result Stats

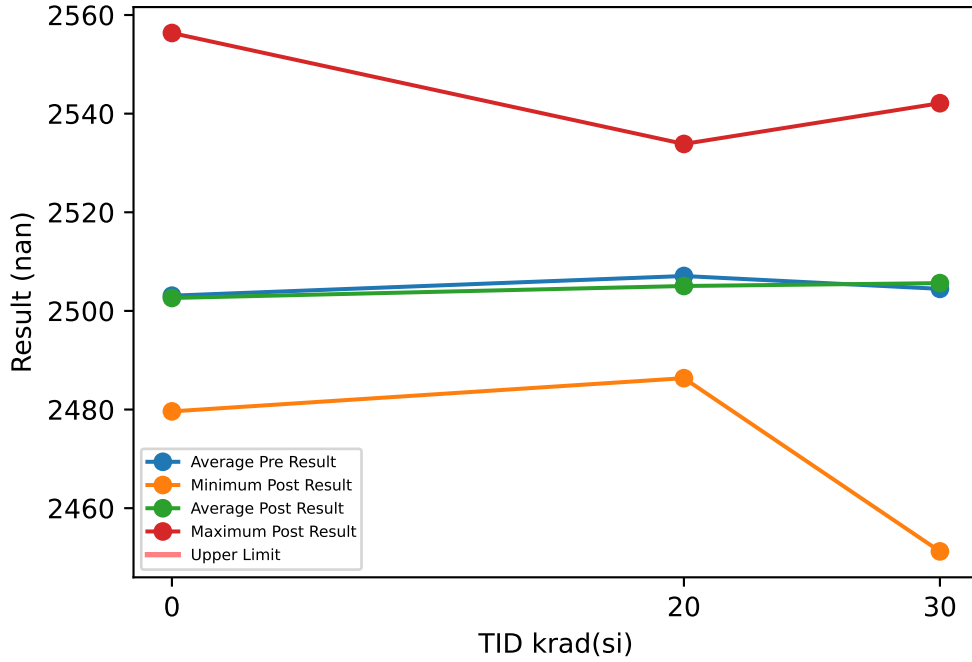

Test Results (No Limits Specified (nan))

Serial #	krad(si)	Exposure Conditions	Pre Result	Post Result	Delta
50	20	LDR biased	2499.4	2500.8	1.41
51	20	LDR biased	2504.6	2502.9	-1.708
52	20	LDR biased	2523.5	2518.5	-4.951
53	20	LDR biased	2511	2509.4	-1.654
54	20	LDR biased	2492.2	2490.6	-1.574
55	30	LDR biased	2456.9	2451.2	-5.697
56	30	LDR biased	2511.6	2516.5	4.913
57	30	LDR biased	2531.8	2534.6	2.806
58	30	LDR biased	2540	2542.1	2.087
59	30	LDR biased	2460.3	2463.9	3.638
60	20	LDR unbiased	2491.3	2486.4	-4.948
61	20	LDR unbiased	2500.9	2499.4	-1.522
62	20	LDR unbiased	2517.7	2517	-0.628
63	20	LDR unbiased	2494.9	2491.7	-3.209
64	20	LDR unbiased	2535.4	2533.9	-1.501
65	30	LDR unbiased	2530.8	2527.5	-3.35
66	30	LDR unbiased	2511.7	2518.6	6.909
67	30	LDR unbiased	2541.5	2539.1	-2.401
68	30	LDR unbiased	2482.2	2486.5	4.223
69	30	LDR unbiased	2477.8	2476.3	-1.481
70	0	correlation	2478.6	2479.6	1.03
71	0	correlation	2481.3	2479.6	-1.718
72	0	correlation	2502	2499.7	-2.241
73	0	correlation	2557.1	2556.4	-0.736
74	0	correlation	2496.4	2497.7	1.326

TID vs Post - Pre Exposure Delta

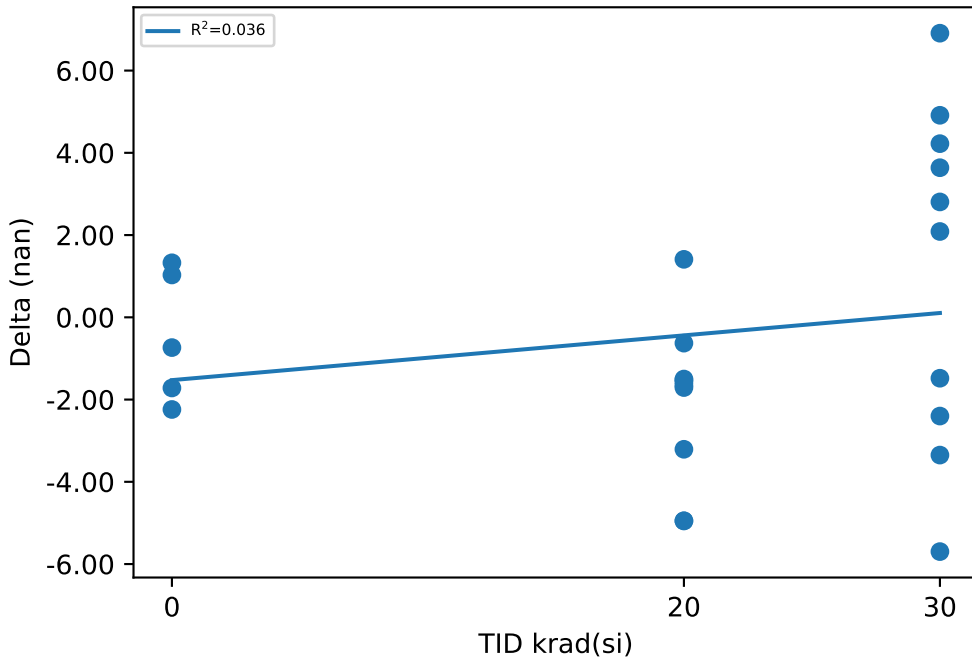

Test Statistics (nan)

krad(si)	Pre Exposure Min	Pre Exposure Avg	Pre Exposure Max	Pre Exposure Std	Post Exposure Min	Post Exposure Avg	Post Exposure Max	Post Exposure Std	Min Delta	Avg Delta	Max Delta	Std Delta
0	2478.6	2503.1	2557.1	31.756	2479.6	2502.6	2556.4	31.528	-2.241	-0.4678	1.326	1.6
20	2491.3	2507.1	2535.4	14.606	2486.4	2505	2533.9	14.781	-4.951	-2.0285	1.41	1.9214
30	2456.9	2504.5	2541.5	32.66	2451.2	2505.6	2542.1	33.305	-5.697	1.1647	6.909	4.1264

Device Test: 11.49 UJET8J(KCL_4A_CH3_UJET8J)

TID vs Result Stats

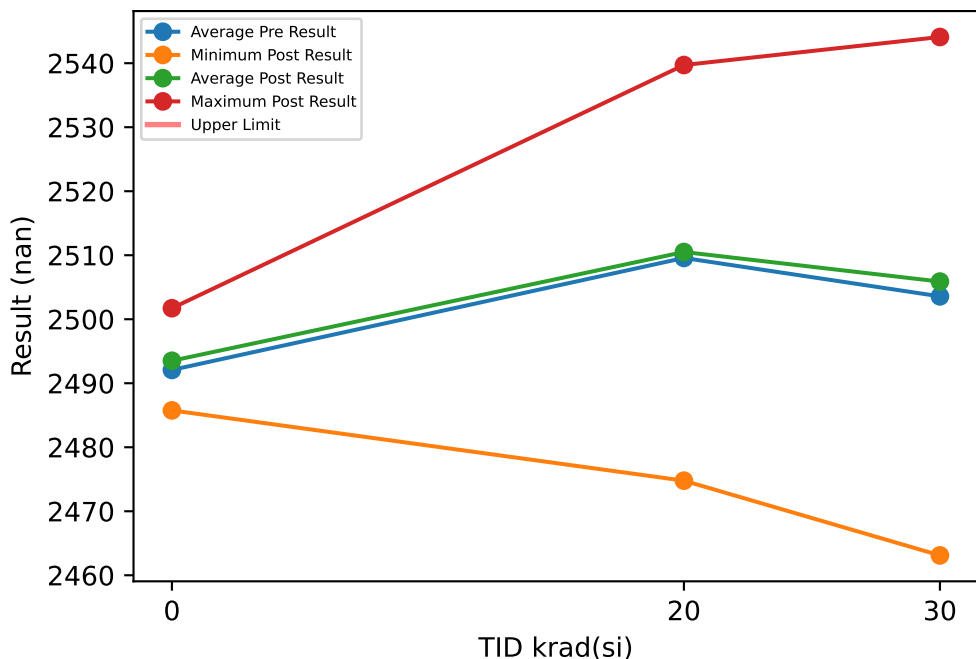

Test Results (No Limits Specified (nan))

Serial #	krad(si)	Exposure Conditions	Pre Result	Post Result	Delta
50	20	LDR biased	2539.9	2539.7	-0.203
51	20	LDR biased	2532.3	2533.5	1.235
52	20	LDR biased	2513	2511.9	-1.104
53	20	LDR biased	2498.6	2502.9	4.341
54	20	LDR biased	2475.4	2474.8	-0.582
55	30	LDR biased	2485.4	2484.9	-0.501
56	30	LDR biased	2514.8	2515	0.157
57	30	LDR biased	2511.8	2515.1	3.231
58	30	LDR biased	2466.4	2468.7	2.287
59	30	LDR biased	2527.4	2528.7	1.318
60	20	LDR unbiased	2505.5	2505	-0.55
61	20	LDR unbiased	2535.3	2536.8	1.457
62	20	LDR unbiased	2495.4	2495.2	-0.204
63	20	LDR unbiased	2503	2505.2	2.264
64	20	LDR unbiased	2497.3	2499.9	2.65
65	30	LDR unbiased	2494.1	2502.6	8.559
66	30	LDR unbiased	2462.1	2463.1	1.034
67	30	LDR unbiased	2542.2	2544.1	1.844
68	30	LDR unbiased	2521.9	2522.5	0.572
69	30	LDR unbiased	2509.7	2514.3	4.592
70	0	correlation	2500.3	2501.7	1.46
71	0	correlation	2483.4	2485.8	2.327
72	0	correlation	2497.9	2497.4	-0.513
73	0	correlation	2489.6	2492.5	2.902
74	0	correlation	2489.2	2490.2	0.99

TID vs Post - Pre Exposure Delta

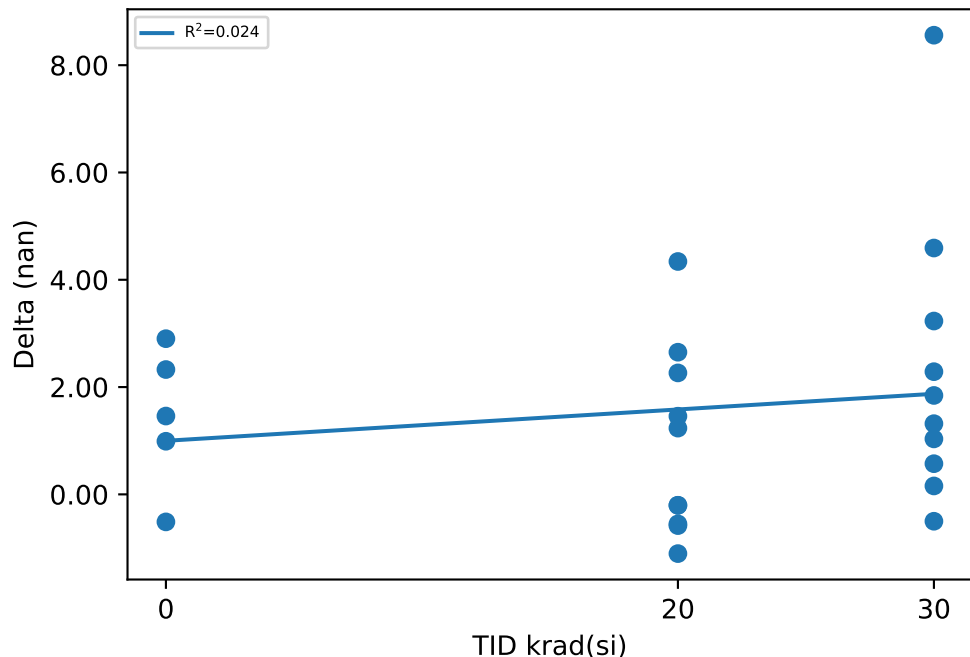

Test Statistics (nan)

krad(si)	Pre Exposure Min	Pre Exposure Avg	Pre Exposure Max	Pre Exposure Std	Post Exposure Min	Post Exposure Avg	Post Exposure Max	Post Exposure Std	Min Delta	Avg Delta	Max Delta	Std Delta
0	2483.4	2492.1	2500.3	6.894	2485.8	2493.5	2501.7	6.2156	-0.513	1.4332	2.902	1.3173
20	2475.4	2509.6	2539.9	20.584	2474.8	2510.5	2539.7	20.58	-1.104	0.9304	4.341	1.7615
30	2462.1	2503.6	2542.2	26.154	2463.1	2505.9	2544.1	26.159	-0.501	2.3093	8.559	2.6561

Device Test: 11.5 UJ9ZQ5(dCLR_P25A_CH3_UJ9ZQ5)

TID vs Result Stats

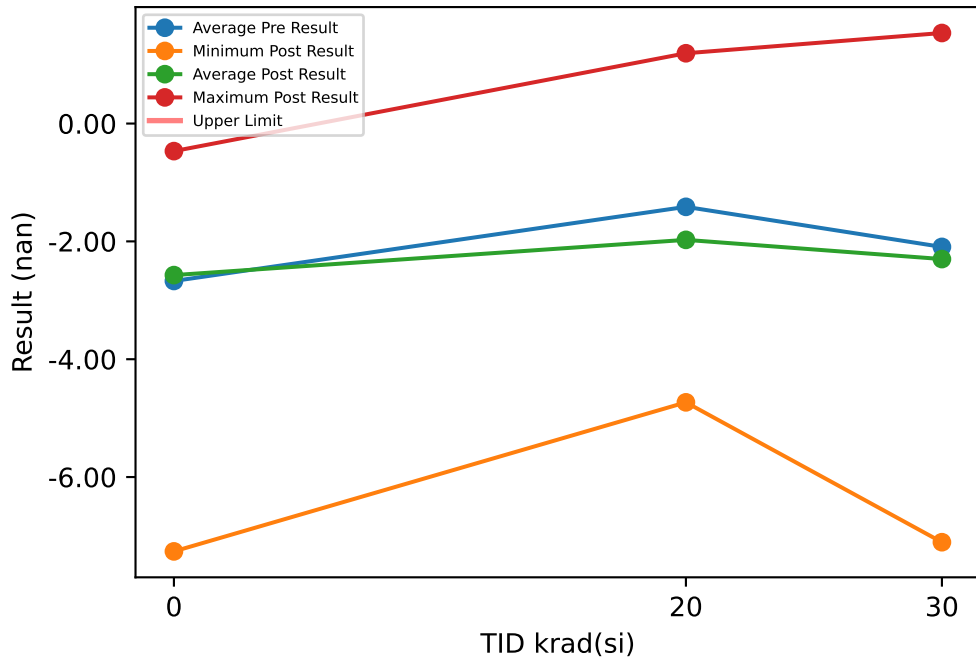

Test Results (No Limits Specified (nan))

Serial #	krad(si)	Exposure Conditions	Pre Result	Post Result	Delta
50	20	LDR biased	0.964	1.193	0.229
51	20	LDR biased	0.908	0.582	-0.326
52	20	LDR biased	-2.37	-2.124	0.246
53	20	LDR biased	-3.172	-3.403	-0.231
54	20	LDR biased	-2.825	-3.849	-1.024
55	30	LDR biased	-2.285	-4.015	-1.73
56	30	LDR biased	1.267	1.537	0.27
57	30	LDR biased	-1.453	-0.793	0.66
58	30	LDR biased	-4.266	-5.16	-0.894
59	30	LDR biased	-2.085	-2.459	-0.374
60	20	LDR unbiased	0.88	-0.645	-1.525
61	20	LDR unbiased	-3.343	-4.732	-1.389
62	20	LDR unbiased	-1.344	-2.837	-1.493
63	20	LDR unbiased	-1.435	-1.367	0.068
64	20	LDR unbiased	-2.401	-2.56	-0.159
65	30	LDR unbiased	-1.855	-0.798	1.057
66	30	LDR unbiased	-5.889	-7.106	-1.217
67	30	LDR unbiased	1.144	1.135	-0.009
68	30	LDR unbiased	-2.735	-2.174	0.561
69	30	LDR unbiased	-2.782	-3.168	-0.386
70	0	correlation	-1.893	-1.767	0.126
71	0	correlation	-1.183	-1.263	-0.08
72	0	correlation	-0.593	-0.468	0.125
73	0	correlation	-7.329	-7.262	0.067
74	0	correlation	-2.362	-2.102	0.26

TID vs Post - Pre Exposure Delta

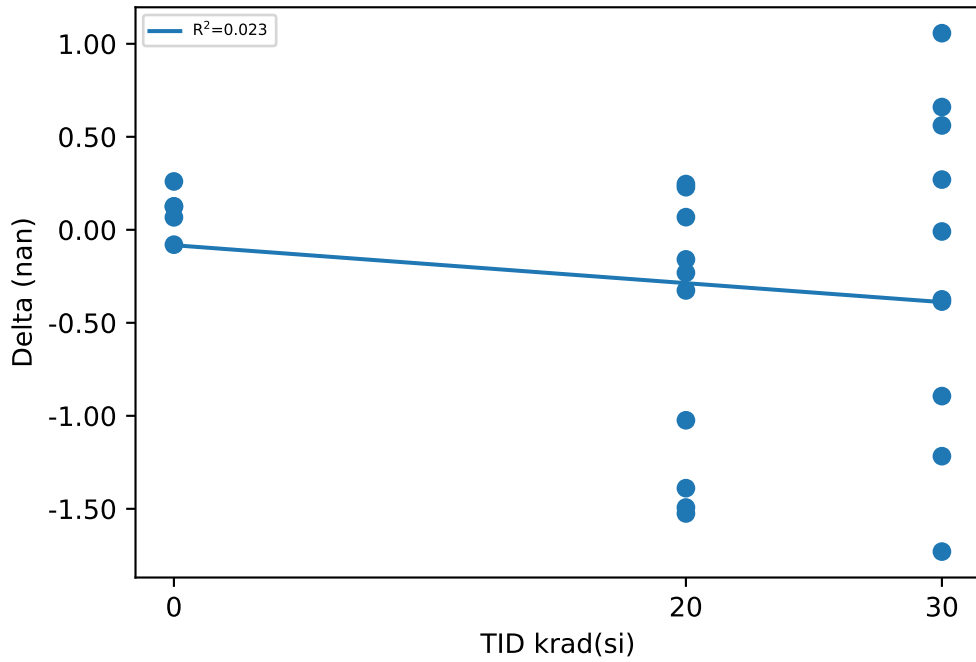

Test Statistics (nan)

krad(si)	Pre Exposure Min	Pre Exposure Avg	Pre Exposure Max	Pre Exposure Std	Post Exposure Min	Post Exposure Avg	Post Exposure Max	Post Exposure Std	Min Delta	Avg Delta	Max Delta	Std Delta
0	-7.329	-2.672	-0.593	2.6893	-7.262	-2.5724	-0.468	2.6928	-0.08	0.0996	0.26	0.12287
20	-3.343	-1.4138	0.964	1.7322	-4.732	-1.9742	1.193	1.9141	-1.525	-0.5604	0.246	0.72223
30	-5.889	-2.0939	1.267	2.1677	-7.106	-2.3001	1.537	2.7093	-1.73	-0.2062	1.057	0.88678

Device Test: 11.50 UJET8J(KCL_4A_CH4_UJET8J)

TID vs Result Stats

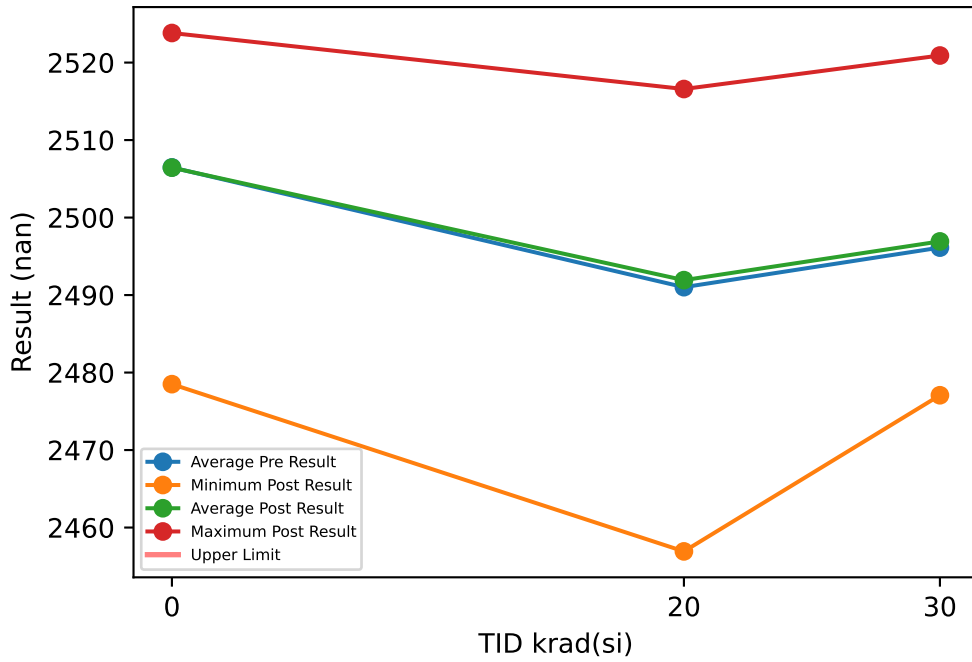

Test Results (No Limits Specified (nan))

Serial #	krad(si)	Exposure Conditions	Pre Result	Post Result	Delta
50	20	LDR biased	2515.5	2513.8	-1.709
51	20	LDR biased	2495.6	2499.5	3.974
52	20	LDR biased	2496.2	2495.4	-0.832
53	20	LDR biased	2485.8	2483.9	-1.908
54	20	LDR biased	2478.3	2478.8	0.427
55	30	LDR biased	2483.7	2489	5.33
56	30	LDR biased	2478.4	2477.4	-1.008
57	30	LDR biased	2486.7	2486.7	0.029
58	30	LDR biased	2516.2	2516	-0.203
59	30	LDR biased	2515.7	2513.8	-1.927
60	20	LDR unbiased	2507.1	2511.1	3.987
61	20	LDR unbiased	2456.7	2458.3	1.603
62	20	LDR unbiased	2502.3	2504.9	2.627
63	20	LDR unbiased	2458.6	2456.9	-1.689
64	20	LDR unbiased	2514	2516.6	2.605
65	30	LDR unbiased	2514.9	2514.5	-0.415
66	30	LDR unbiased	2522.7	2520.9	-1.783
67	30	LDR unbiased	2475.8	2478.5	2.667
68	30	LDR unbiased	2491.9	2495.5	3.541
69	30	LDR unbiased	2475.3	2477.1	1.776
70	0	correlation	2517.5	2517.9	0.45
71	0	correlation	2478.8	2478.5	-0.312
72	0	correlation	2523.9	2523.8	-0.123
73	0	correlation	2498.3	2498.8	0.543
74	0	correlation	2513.8	2513.2	-0.696

TID vs Post - Pre Exposure Delta

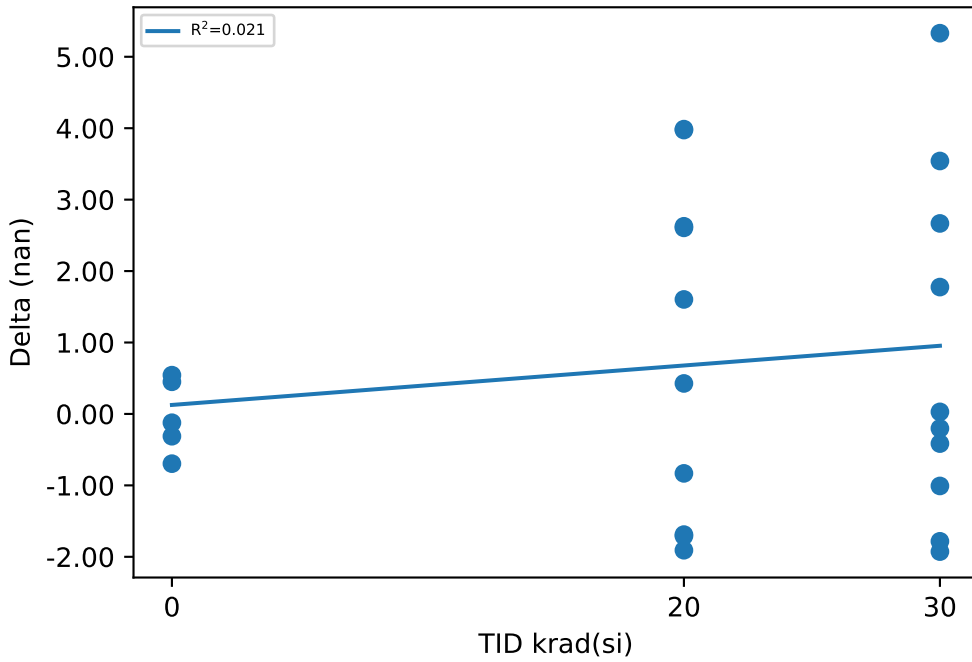

Test Statistics (nan)

krad(si)	Pre Exposure Min	Pre Exposure Avg	Pre Exposure Max	Pre Exposure Std	Post Exposure Min	Post Exposure Avg	Post Exposure Max	Post Exposure Std	Min Delta	Avg Delta	Max Delta	Std Delta
0	2478.8	2506.5	2523.9	18.119	2478.5	2506.4	2523.8	18.152	-0.696	-0.0276	0.543	0.52212
20	2456.7	2491	2515.5	21.023	2456.9	2491.9	2516.6	21.825	-1.908	0.9085	3.987	2.3566
30	2475.3	2496.1	2522.7	19.052	2477.1	2496.9	2520.9	17.69	-1.927	0.8007	5.33	2.425

Device Test: 11.6 UJSYNT(dCLR_P5A_CH3_UJSYNT)

TID vs Result Stats

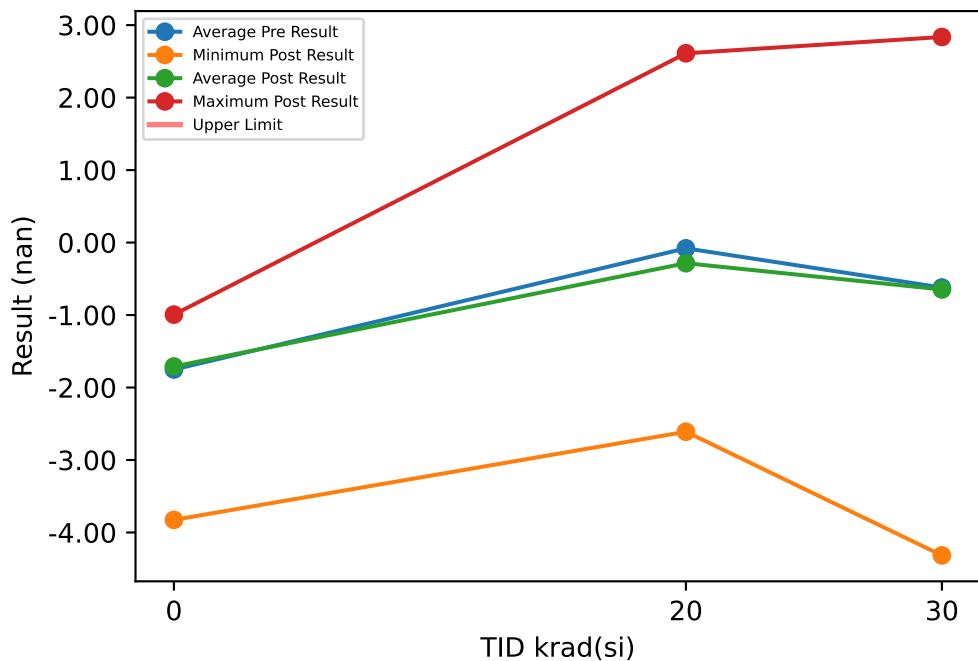

Test Results (No Limits Specified (nan))

Serial #	krad(si)	Exposure Conditions	Pre Result	Post Result	Delta
50	20	LDR biased	2.536	2.611	0.075
51	20	LDR biased	1.661	1.507	-0.154
52	20	LDR biased	0.243	0.328	0.085
53	20	LDR biased	-1.436	-1.481	-0.045
54	20	LDR biased	-2.071	-2.61	-0.539
55	30	LDR biased	-1.81	-2.669	-0.859
56	30	LDR biased	0.995	1.127	0.132
57	30	LDR biased	-0.01	0.327	0.337
58	30	LDR biased	-3.848	-4.227	-0.379
59	30	LDR biased	1.12	0.951	-0.169
60	20	LDR unbiased	0.489	-0.09	-0.579
61	20	LDR unbiased	0.178	-0.457	-0.635
62	20	LDR unbiased	-0.954	-1.46	-0.506
63	20	LDR unbiased	-0.774	-0.697	0.077
64	20	LDR unbiased	-0.668	-0.5	0.168
65	30	LDR unbiased	-0.391	0.218	0.609
66	30	LDR unbiased	-3.963	-4.316	-0.353
67	30	LDR unbiased	2.777	2.836	0.059
68	30	LDR unbiased	-0.278	-0.036	0.242
69	30	LDR unbiased	-0.797	-0.683	0.114
70	0	correlation	-1.114	-1.046	0.068
71	0	correlation	-1.267	-1.251	0.016
72	0	correlation	-0.887	-0.994	-0.107
73	0	correlation	-3.899	-3.826	0.073
74	0	correlation	-1.59	-1.431	0.159

TID vs Post - Pre Exposure Delta

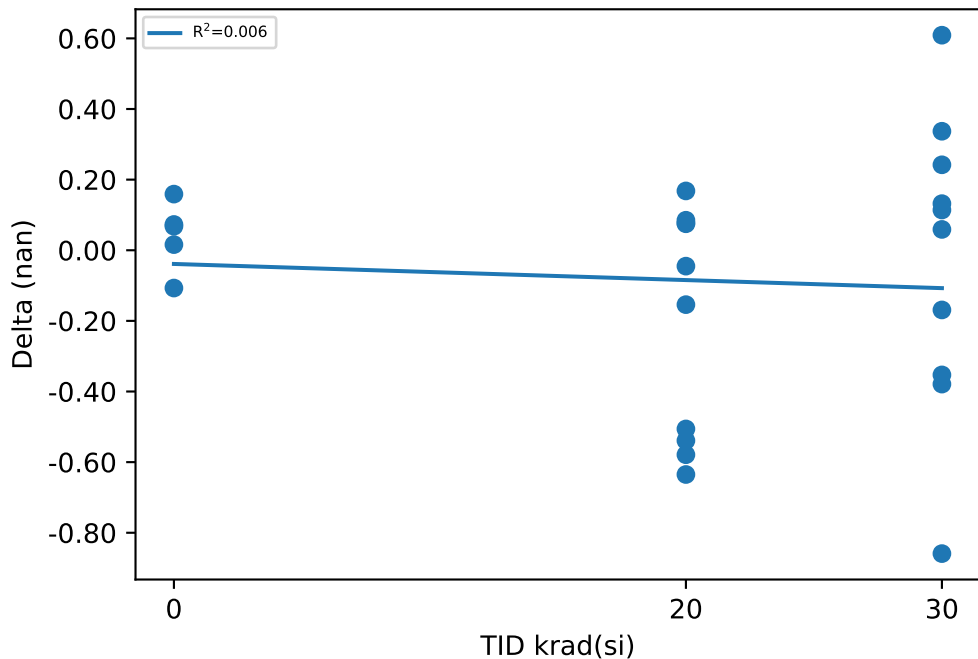

Test Statistics (nan)

krad(si)	Pre Exposure Min	Pre Exposure Avg	Pre Exposure Max	Pre Exposure Std	Post Exposure Min	Post Exposure Avg	Post Exposure Max	Post Exposure Std	Min Delta	Avg Delta	Max Delta	Std Delta
0	-3.899	-1.7514	-0.887	1.2274	-3.826	-1.7096	-0.994	1.1958	-0.107	0.0418	0.159	0.097728
20	-2.071	-0.0796	2.536	1.4049	-2.61	-0.2849	2.611	1.5083	-0.635	-0.2053	0.168	0.32254
30	-3.963	-0.6205	2.777	2.1281	-4.316	-0.6472	2.836	2.3634	-0.859	-0.0267	0.609	0.42223

Device Test: 11.7 UJ9ZQ5(dCLR_P25A_CH4_UJ9ZQ5)

TID vs Result Stats

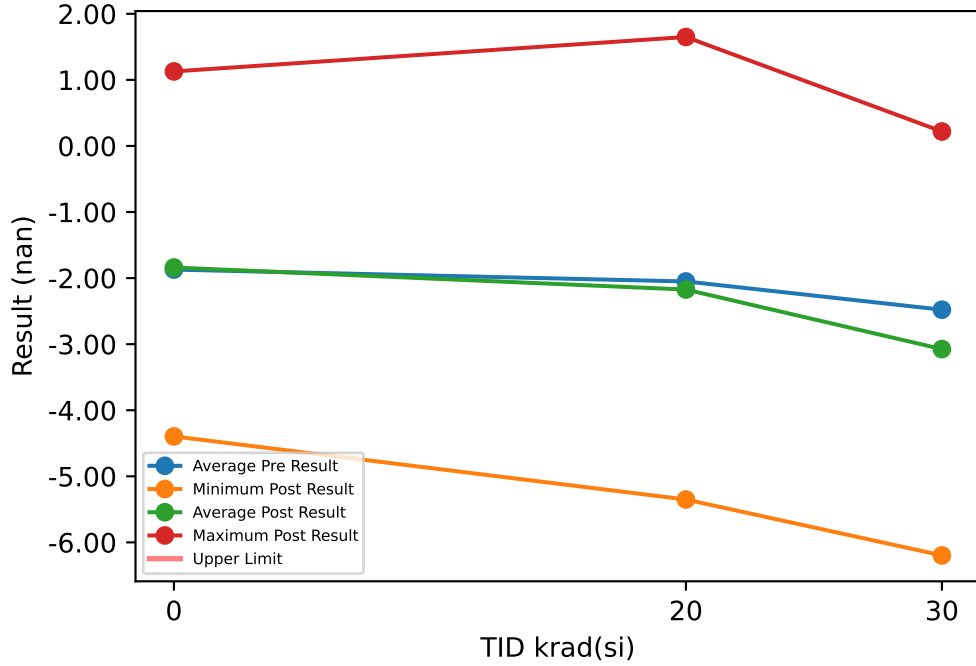

Test Results (No Limits Specified (nan))

Serial #	krad(si)	Exposure Conditions	Pre Result	Post Result	Delta
50	20	LDR biased	-2.552	-3.64	-1.088
51	20	LDR biased	-0.913	1.03	1.943
52	20	LDR biased	-2.09	-3.03	-0.94
53	20	LDR biased	-2.468	-4.794	-2.326
54	20	LDR biased	-2.679	-3.616	-0.937
55	30	LDR biased	-1.895	0.219	2.114
56	30	LDR biased	-0.127	-1.129	-1.002
57	30	LDR biased	-3.185	-4.898	-1.713
58	30	LDR biased	-2.242	-2.899	-0.657
59	30	LDR biased	-1.856	-4.675	-2.819
60	20	LDR unbiased	-1.078	0.11	1.188
61	20	LDR unbiased	-1.571	-1.459	0.112
62	20	LDR unbiased	0.961	1.649	0.688
63	20	LDR unbiased	-2.47	-2.633	-0.163
64	20	LDR unbiased	-5.648	-5.351	0.297
65	30	LDR unbiased	0.458	-0.513	-0.971
66	30	LDR unbiased	-4.373	-6.197	-1.824
67	30	LDR unbiased	-2.275	-2.01	0.265
68	30	LDR unbiased	-4.889	-4.257	0.632
69	30	LDR unbiased	-4.4	-4.386	0.014
70	0	correlation	-4.223	-4.242	-0.019
71	0	correlation	-1.078	-1.162	-0.084
72	0	correlation	-0.582	-0.526	0.056
73	0	correlation	1.193	1.128	-0.065
74	0	correlation	-4.665	-4.396	0.269

TID vs Post - Pre Exposure Delta

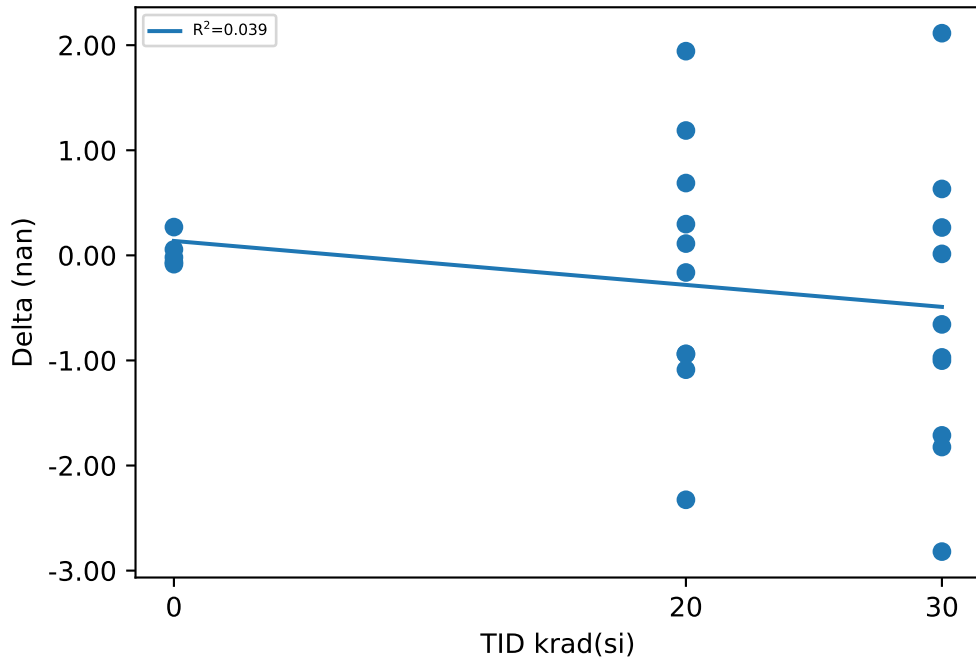

Test Statistics (nan)

krad(si)	Pre Exposure Min	Pre Exposure Avg	Pre Exposure Max	Pre Exposure Std	Post Exposure Min	Post Exposure Avg	Post Exposure Max	Post Exposure Std	Min Delta	Avg Delta	Max Delta	Std Delta
0	-4.665	-1.871	1.193	2.5008	-4.396	-1.8396	1.128	2.4134	-0.084	0.0314	0.269	0.14336
20	-5.648	-2.0508	0.961	1.6826	-5.351	-2.1734	1.649	2.4207	-2.326	-0.1226	1.943	1.2469
30	-4.889	-2.4784	0.458	1.7817	-6.197	-3.0745	0.219	2.1373	-2.819	-0.5961	2.114	1.4131

Device Test: 11.8 UJSYNT(dCLR_P5A_CH4_UJSYNT)

TID vs Result Stats

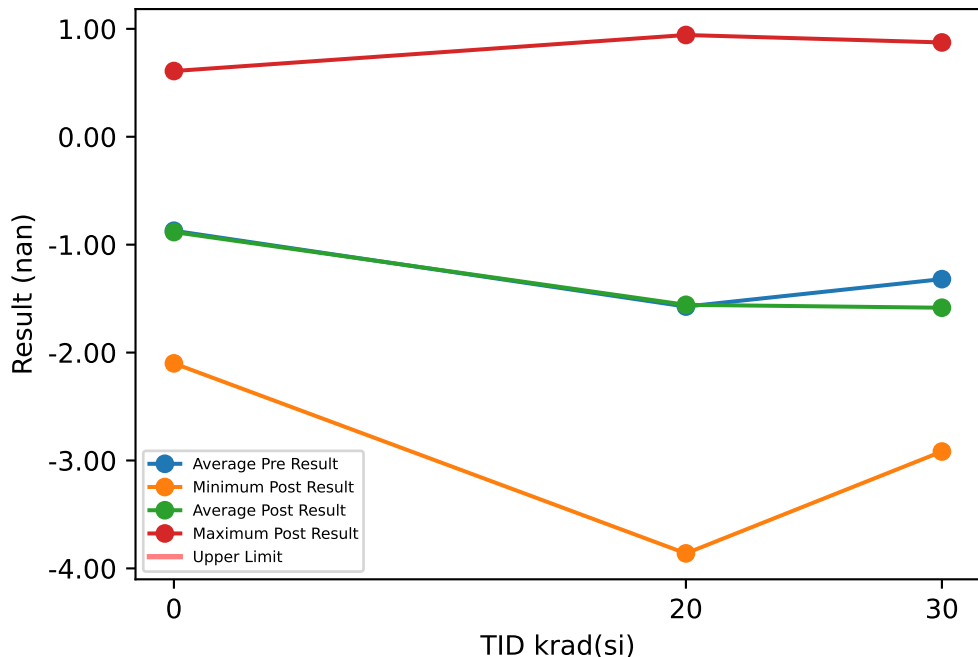

Test Results (No Limits Specified (nan))

Serial #	krad(si)	Exposure Conditions	Pre Result	Post Result	Delta
50	20	LDR biased	-0.549	-1.146	-0.597
51	20	LDR biased	-0.498	0.61	1.108
52	20	LDR biased	-2.052	-2.432	-0.38
53	20	LDR biased	-2.294	-3.304	-1.01
54	20	LDR biased	-2.233	-2.635	-0.402
55	30	LDR biased	-2.111	-0.874	1.237
56	30	LDR biased	-1.456	-2.056	-0.6
57	30	LDR biased	-1.427	-2.271	-0.844
58	30	LDR biased	-0.655	-1.029	-0.374
59	30	LDR biased	-0.501	-1.916	-1.415
60	20	LDR unbiased	-0.197	0.542	0.739
61	20	LDR unbiased	-3.067	-2.929	0.138
62	20	LDR unbiased	0.585	0.943	0.358
63	20	LDR unbiased	-3.74	-3.861	-0.121
64	20	LDR unbiased	-1.692	-1.362	0.33
65	30	LDR unbiased	1.434	0.874	-0.56
66	30	LDR unbiased	-1.082	-1.997	-0.915
67	30	LDR unbiased	-2.198	-1.944	0.254
68	30	LDR unbiased	-2.213	-1.714	0.499
69	30	LDR unbiased	-2.985	-2.917	0.068
70	0	correlation	-0.981	-0.894	0.087
71	0	correlation	-1.916	-2.1	-0.184
72	0	correlation	0.027	0.014	-0.013
73	0	correlation	0.619	0.609	-0.01
74	0	correlation	-2.104	-2.046	0.058

TID vs Post - Pre Exposure Delta

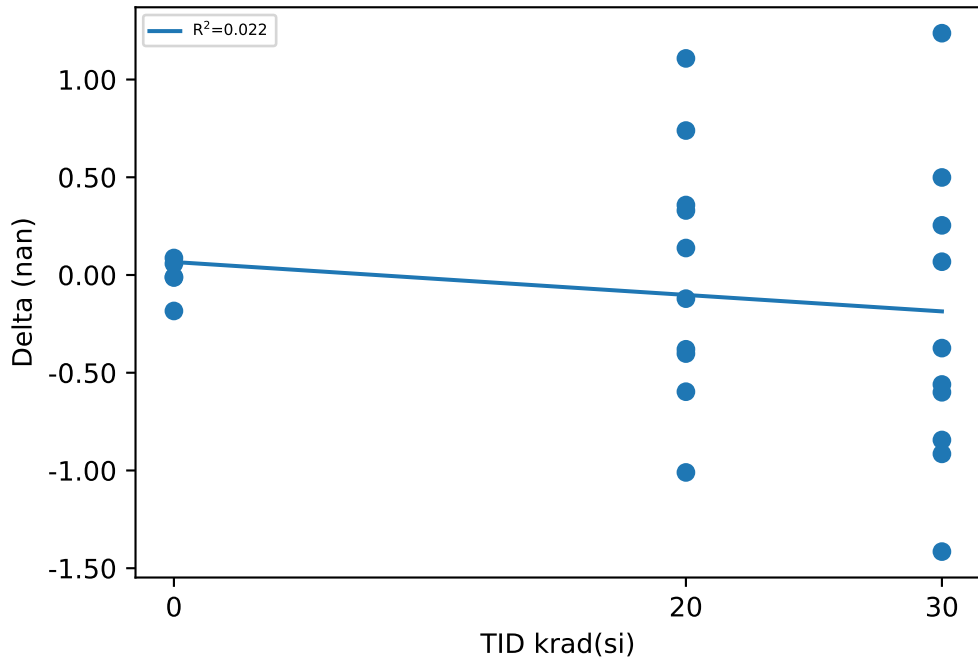

Test Statistics (nan)

krad(si)	Pre Exposure Min	Pre Exposure Avg	Pre Exposure Max	Pre Exposure Std	Post Exposure Min	Post Exposure Avg	Post Exposure Max	Post Exposure Std	Min Delta	Avg Delta	Max Delta	Std Delta
0	-2.104	-0.871	0.619	1.1886	-2.1	-0.8834	0.609	1.2108	-0.184	-0.0124	0.087	0.10522
20	-3.74	-1.5737	0.585	1.3696	-3.861	-1.5574	0.943	1.7553	-1.01	0.0163	1.108	0.64329
30	-2.985	-1.3194	1.434	1.236	-2.917	-1.5844	0.874	1.041	-1.415	-0.265	1.237	0.78254

Device Test: 11.9 UJPX6I(Delta_dCLR_P5A_CH1CH2_UJPX6I)

TID vs Result Stats

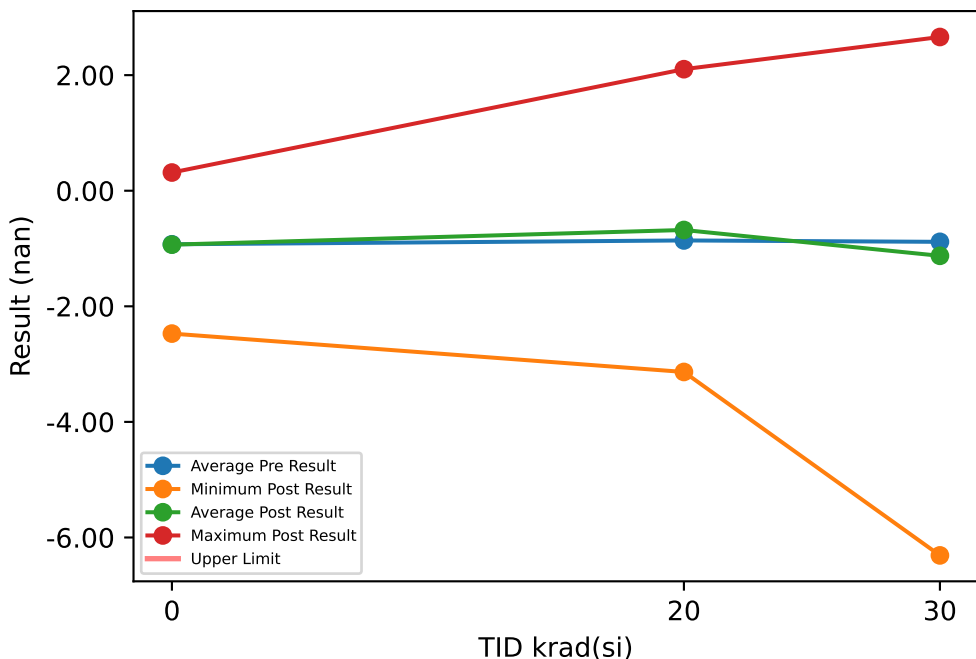

Test Results (No Limits Specified (nan))

Serial #	krad(si)	Exposure Conditions	Pre Result	Post Result	Delta
50	20	LDR biased	-0.804	-1.617	-0.813
51	20	LDR biased	2.358	2.103	-0.255
52	20	LDR biased	-2.898	-3.136	-0.238
53	20	LDR biased	-1.641	-1.14	0.501
54	20	LDR biased	0.36	1.768	1.408
55	30	LDR biased	2.304	2.46	0.156
56	30	LDR biased	-4.658	-6.31	-1.652
57	30	LDR biased	-3.014	-1.939	1.075
58	30	LDR biased	-0.328	-2.079	-1.751
59	30	LDR biased	2.727	2.66	-0.067
60	20	LDR unbiased	-2.107	-1.005	1.102
61	20	LDR unbiased	-1.721	-1.737	-0.016
62	20	LDR unbiased	-0.523	-0.826	-0.303
63	20	LDR unbiased	-1.959	-1.866	0.093
64	20	LDR unbiased	0.332	0.663	0.331
65	30	LDR unbiased	-1.269	-0.335	0.934
66	30	LDR unbiased	-2.627	-3.741	-1.114
67	30	LDR unbiased	-0.325	0.401	0.726
68	30	LDR unbiased	-1.66	-2.918	-1.258
69	30	LDR unbiased	0.007	0.54	0.533
70	0	correlation	-0.306	-0.775	-0.469
71	0	correlation	0.305	0.315	0.01
72	0	correlation	-1.865	-1.666	0.199
73	0	correlation	-2.863	-2.472	0.391
74	0	correlation	0.094	-0.067	-0.161

TID vs Post - Pre Exposure Delta

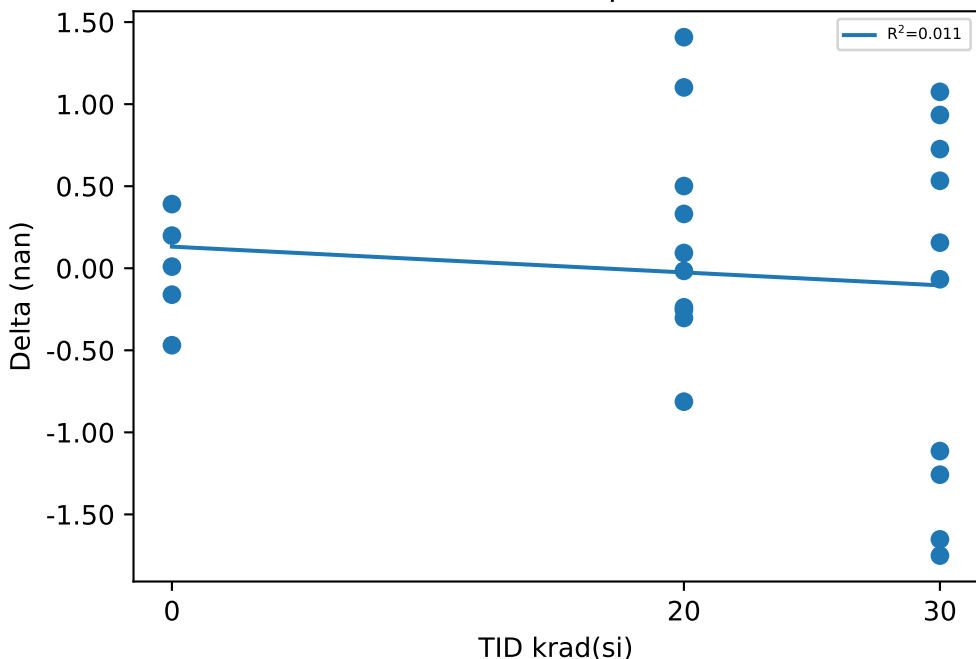

Test Statistics (nan)

krad(si)	Pre Exposure Min	Pre Exposure Avg	Pre Exposure Max	Pre Exposure Std	Post Exposure Min	Post Exposure Avg	Post Exposure Max	Post Exposure Std	Min Delta	Avg Delta	Max Delta	Std Delta
0	-2.863	-0.927	0.305	1.376	-2.472	-0.933	0.315	1.1444	-0.469	-0.006	0.391	0.33102
20	-2.898	-0.8603	2.358	1.551	-3.136	-0.6793	2.103	1.6771	-0.813	0.181	1.408	0.67603
30	-4.658	-0.8843	2.727	2.2897	-6.31	-1.1261	2.66	2.817	-1.751	-0.2418	1.075	1.1006

Device Test: 12.1 UJ4ZR4(RDSON_5V_OUT1_UJE410_UJ4ZR4)

TID vs Result Stats

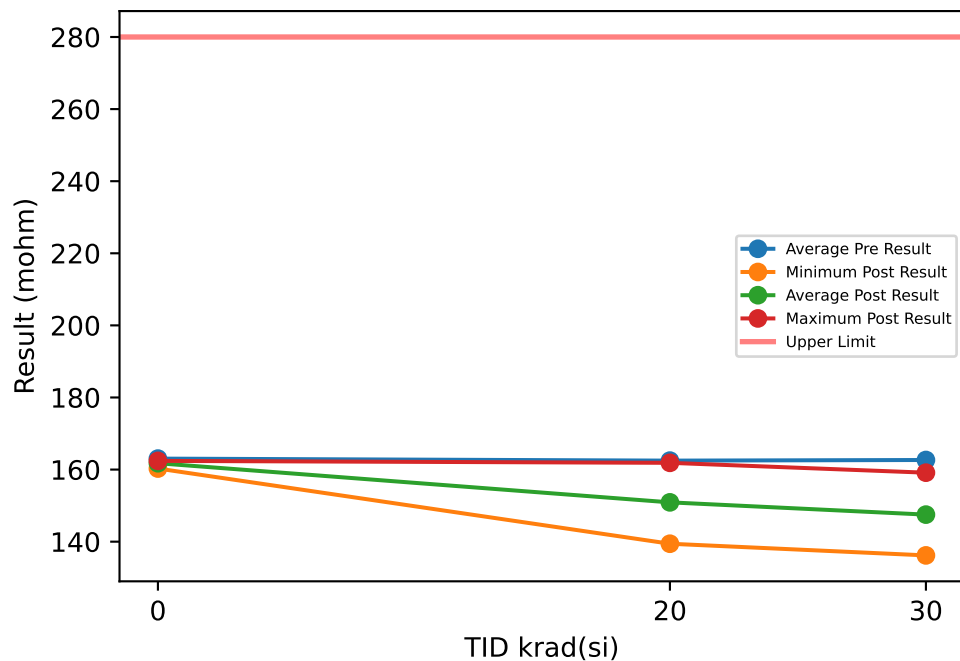

Test Results (Upper Limit = 280.0 (mohm))

Serial #	krad(si)	Exposure Conditions	Pre Result	Post Result	Delta
50	20	LDR biased	160.07	139.43	-20.645
51	20	LDR biased	162.96	141.6	-21.358
52	20	LDR biased	162.47	141.5	-20.977
53	20	LDR biased	162.15	141.07	-21.087
54	20	LDR biased	161.64	140.93	-20.71
55	30	LDR biased	163.12	136.53	-26.586
56	30	LDR biased	162.42	136.19	-26.225
57	30	LDR biased	161.8	136.26	-25.544
58	30	LDR biased	162.48	136.72	-25.764
59	30	LDR biased	164.21	137.78	-26.43
60	20	LDR unbiased	163.07	160.55	-2.5154
61	20	LDR unbiased	162.59	160.18	-2.4062
62	20	LDR unbiased	163.49	161.87	-1.6206
63	20	LDR unbiased	163.26	160.73	-2.5251
64	20	LDR unbiased	163.14	161.21	-1.9279
65	30	LDR unbiased	161.18	157.03	-4.1515
66	30	LDR unbiased	163.05	159.14	-3.907
67	30	LDR unbiased	164.11	159.14	-4.9743
68	30	LDR unbiased	161.94	158.01	-3.9303
69	30	LDR unbiased	162.26	158.27	-3.9923
70	0	correlation	161.65	160.29	-1.3635
71	0	correlation	164.12	162.24	-1.8744
72	0	correlation	163.44	162.17	-1.2753
73	0	correlation	163.59	162.41	-1.1754
74	0	correlation	162.42	161.72	-0.7041

TID vs Post - Pre Exposure Delta

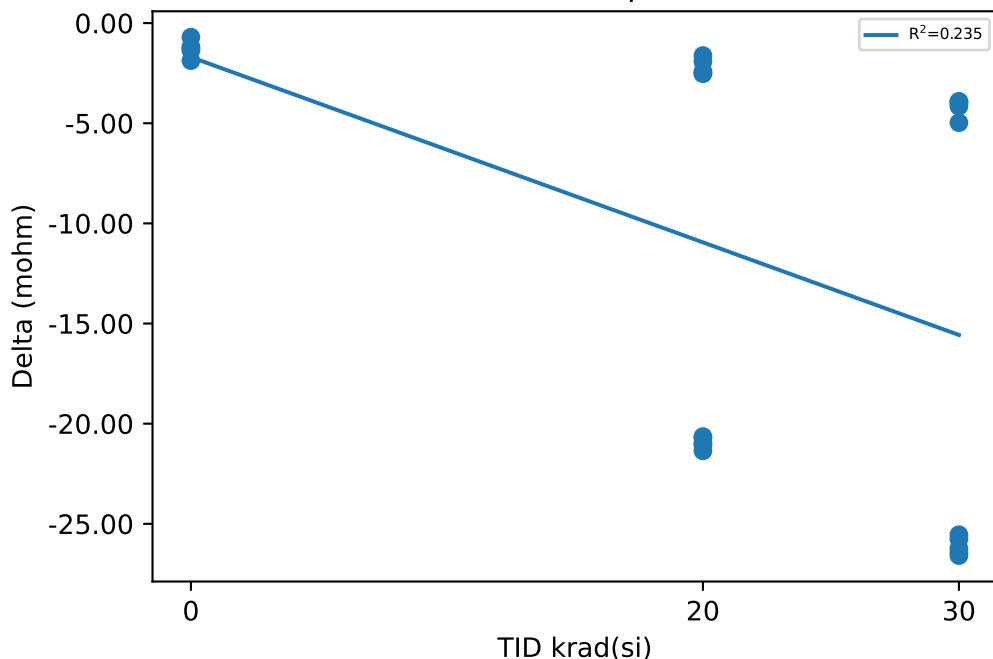

Test Statistics (mohm)

krad(si)	Pre Exposure Min	Pre Exposure Avg	Pre Exposure Max	Pre Exposure Std	Post Exposure Min	Post Exposure Avg	Post Exposure Max	Post Exposure Std	Min Delta	Avg Delta	Max Delta	Std Delta
0	161.65	163.04	164.12	0.99075	160.29	161.76	162.41	0.86464	-1.8744	-1.2785	-0.7041	0.41919
20	160.07	162.48	163.49	1.0137	139.43	150.91	161.87	10.569	-21.358	-11.577	-1.6206	9.891
30	161.18	162.66	164.21	0.97538	136.19	147.51	159.14	11.418	-26.586	-15.15	-3.907	11.56

Device Test: 12.10 UJ4ZR4(RDSON_12V_OUT3_UJE410_UJ4ZR4)

TID vs Result Stats

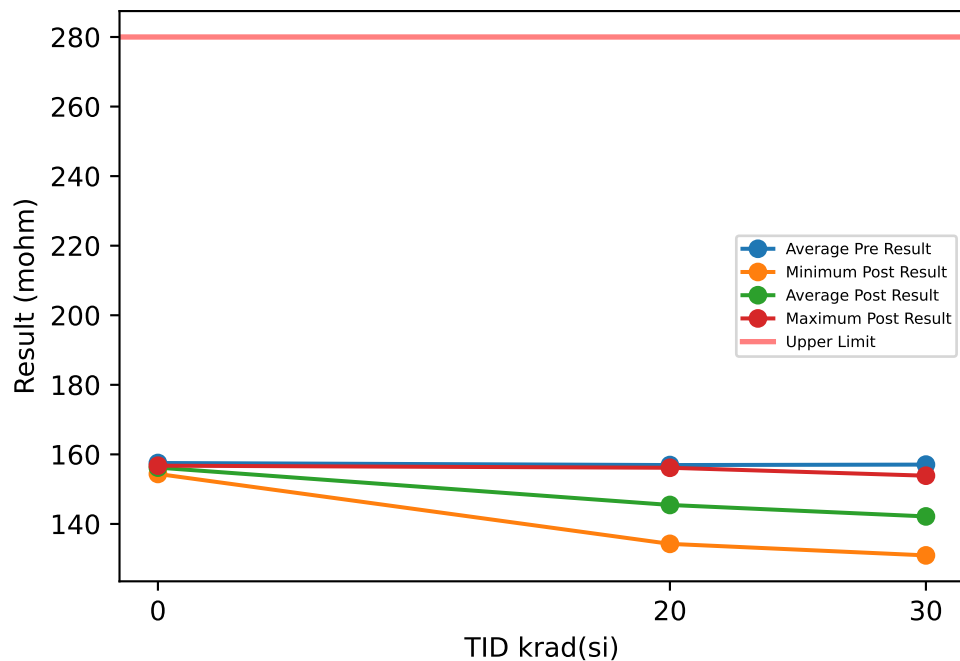

Test Results (Upper Limit = 280.0 (mohm))

Serial #	krad(si)	Exposure Conditions	Pre Result	Post Result	Delta
50	20	LDR biased	154.61	134.27	-20.334
51	20	LDR biased	158	136.86	-21.131
52	20	LDR biased	157.26	136.58	-20.681
53	20	LDR biased	156.9	136.15	-20.746
54	20	LDR biased	155.7	135.24	-20.459
55	30	LDR biased	157.28	130.96	-26.321
56	30	LDR biased	157.38	131.62	-25.76
57	30	LDR biased	156.23	131.28	-24.949
58	30	LDR biased	157.35	131.92	-25.424
59	30	LDR biased	160.05	133.72	-26.328
60	20	LDR unbiased	157.12	154.46	-2.6678
61	20	LDR unbiased	157.38	155	-2.3765
62	20	LDR unbiased	157.88	156.15	-1.7275
63	20	LDR unbiased	157.55	154.95	-2.6055
64	20	LDR unbiased	156.95	154.9	-2.0531
65	30	LDR unbiased	154.87	150.99	-3.8734
66	30	LDR unbiased	157.91	153.87	-4.0419
67	30	LDR unbiased	158.36	153.56	-4.7932
68	30	LDR unbiased	155.21	151.52	-3.6932
69	30	LDR unbiased	156	152.19	-3.8117
70	0	correlation	155.89	154.38	-1.5101
71	0	correlation	158.53	156.62	-1.9087
72	0	correlation	158.22	156.75	-1.4688
73	0	correlation	157.65	156.67	-0.9806
74	0	correlation	157.32	156.55	-0.7668

TID vs Post - Pre Exposure Delta

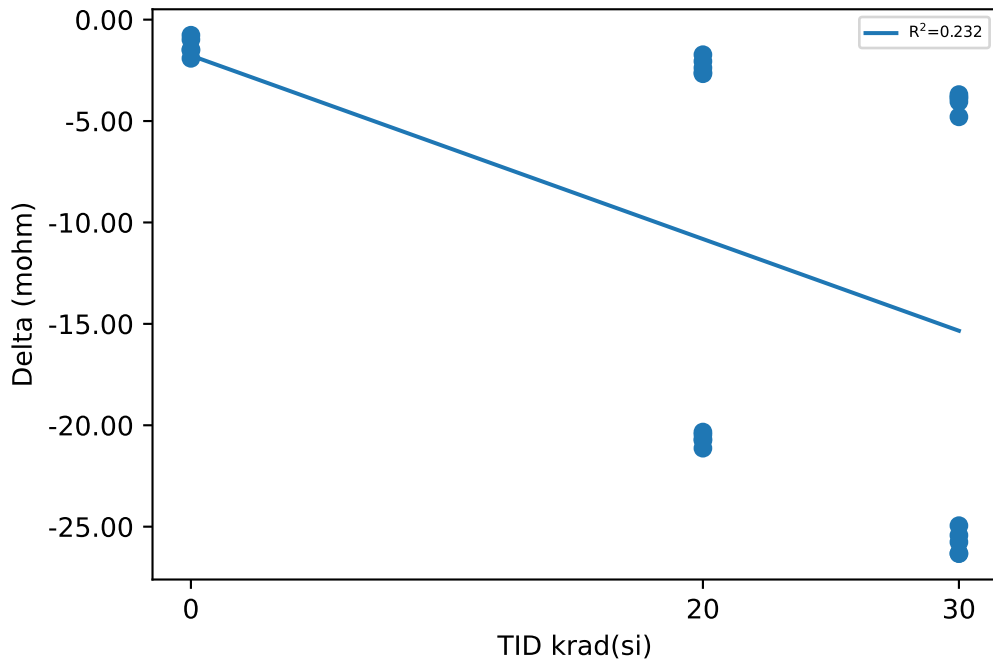

Test Statistics (mohm)

krad(si)	Pre Exposure Min	Pre Exposure Avg	Pre Exposure Max	Pre Exposure Std	Post Exposure Min	Post Exposure Avg	Post Exposure Max	Post Exposure Std	Min Delta	Avg Delta	Max Delta	Std Delta
0	155.89	157.52	158.53	1.0298	154.38	156.2	156.75	1.019	-1.9087	-1.327	-0.7668	0.45437
20	154.61	156.94	158	1.037	134.27	145.46	156.15	10.189	-21.131	-11.478	-1.7275	9.6949
30	154.87	157.06	160.05	1.5496	130.96	142.16	153.87	10.875	-26.328	-14.9	-3.6932	11.455

Device Test: 12.11 UJ4ZR4(RDSON_28V_OUT3_UJE410_UJ4ZR4)

TID vs Result Stats

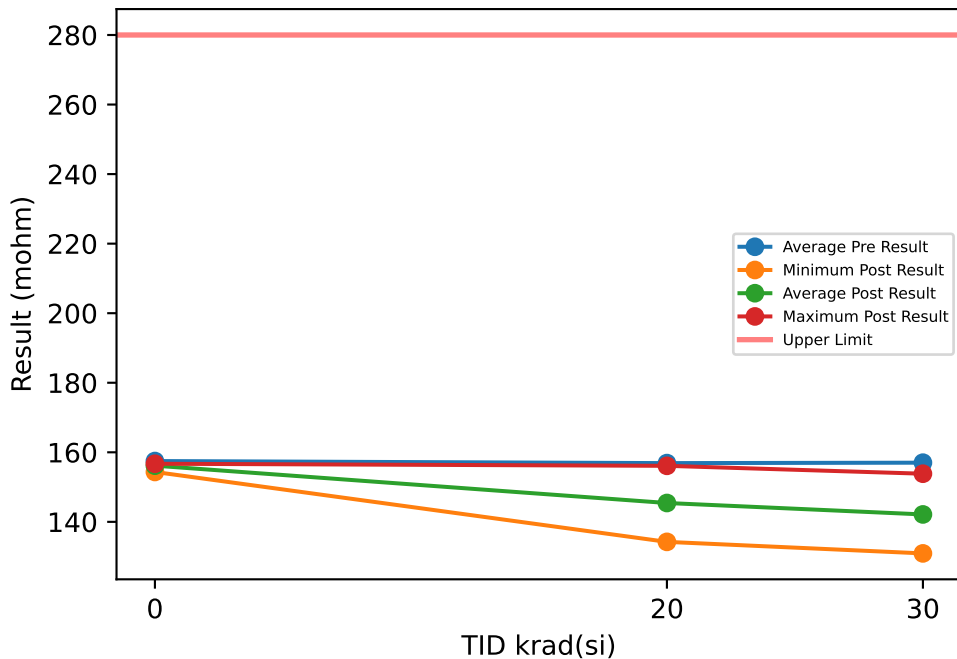

Test Results (Upper Limit = 280.0 (mohm))

Serial #	krad(si)	Exposure Conditions	Pre Result	Post Result	Delta
50	20	LDR biased	154.53	134.24	-20.288
51	20	LDR biased	157.96	136.84	-21.125
52	20	LDR biased	157.23	136.55	-20.686
53	20	LDR biased	156.87	136.13	-20.743
54	20	LDR biased	155.64	135.21	-20.431
55	30	LDR biased	157.23	130.93	-26.306
56	30	LDR biased	157.34	131.59	-25.748
57	30	LDR biased	156.19	131.25	-24.935
58	30	LDR biased	157.31	131.9	-25.404
59	30	LDR biased	159.99	133.69	-26.297
60	20	LDR unbiased	157.09	154.42	-2.6693
61	20	LDR unbiased	157.33	154.97	-2.3566
62	20	LDR unbiased	157.83	156.11	-1.7161
63	20	LDR unbiased	157.52	154.91	-2.6129
64	20	LDR unbiased	156.91	154.84	-2.0747
65	30	LDR unbiased	154.83	150.95	-3.8808
66	30	LDR unbiased	157.87	153.84	-4.0256
67	30	LDR unbiased	158.3	153.52	-4.7769
68	30	LDR unbiased	155.16	151.5	-3.6617
69	30	LDR unbiased	155.95	152.15	-3.798
70	0	correlation	155.85	154.35	-1.5045
71	0	correlation	158.5	156.58	-1.9186
72	0	correlation	158.18	156.71	-1.475
73	0	correlation	157.61	156.63	-0.9866
74	0	correlation	157.28	156.51	-0.7737

TID vs Post - Pre Exposure Delta

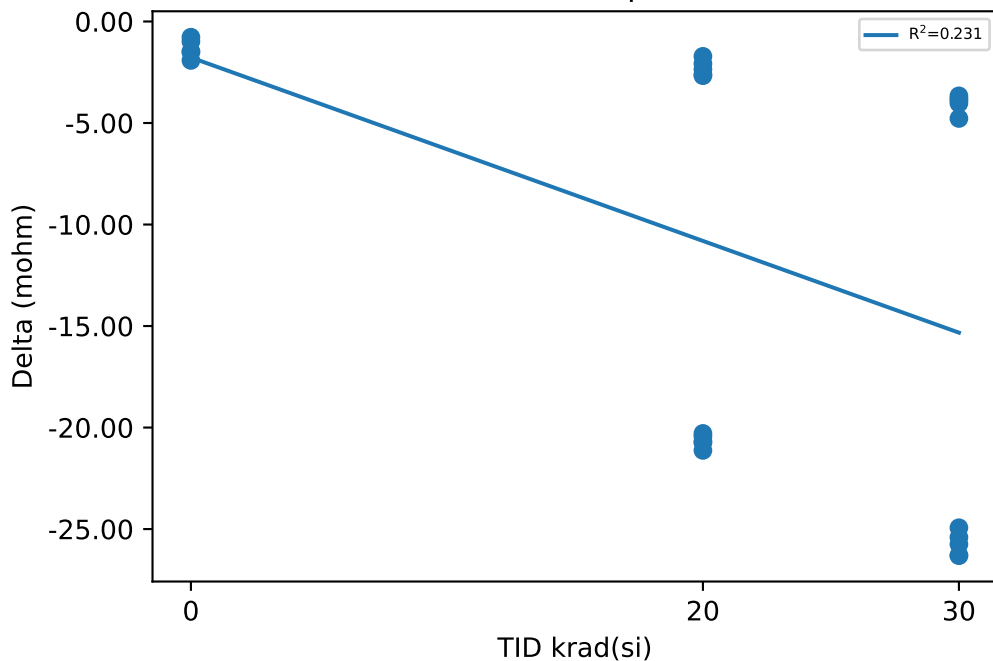

Test Statistics (mohm)

krad(si)	Pre Exposure Min	Pre Exposure Avg	Pre Exposure Max	Pre Exposure Std	Post Exposure Min	Post Exposure Avg	Post Exposure Max	Post Exposure Std	Min Delta	Avg Delta	Max Delta	Std Delta
0	155.85	157.49	158.5	1.0315	154.35	156.15	156.71	1.0138	-1.9186	-1.3317	-0.7737	0.45423
20	154.53	156.89	157.96	1.0486	134.24	145.42	156.11	10.182	-21.125	-11.47	-1.7161	9.6872
30	154.83	157.02	159.99	1.5454	130.93	142.13	153.84	10.871	-26.306	-14.883	-3.6617	11.452

Device Test: 12.12 UJ4ZR4(RDSON_32V_OUT3_UJE410_UJ4ZR4)

TID vs Result Stats

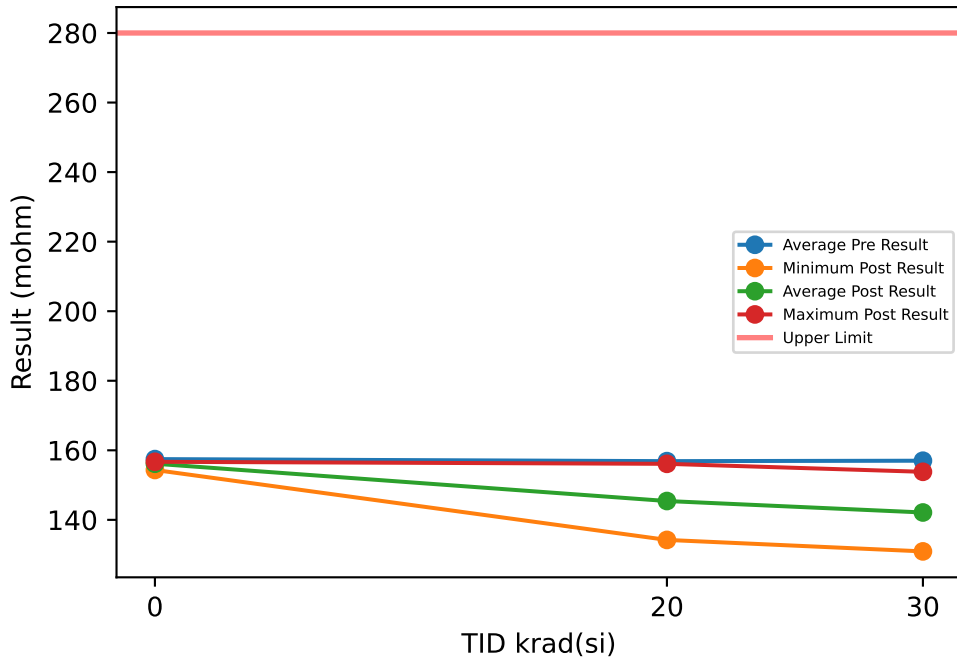

Test Results (Upper Limit = 280.0 (mohm))

Serial #	krad(si)	Exposure Conditions	Pre Result	Post Result	Delta
50	20	LDR biased	154.53	134.23	-20.299
51	20	LDR biased	157.97	136.82	-21.147
52	20	LDR biased	157.23	136.54	-20.69
53	20	LDR biased	156.87	136.12	-20.755
54	20	LDR biased	155.64	135.21	-20.432
55	30	LDR biased	157.25	130.93	-26.319
56	30	LDR biased	157.34	131.57	-25.767
57	30	LDR biased	156.15	131.25	-24.906
58	30	LDR biased	157.28	131.89	-25.397
59	30	LDR biased	159.99	133.66	-26.333
60	20	LDR unbiased	157.07	154.41	-2.6615
61	20	LDR unbiased	157.31	154.99	-2.3205
62	20	LDR unbiased	157.82	156.11	-1.7119
63	20	LDR unbiased	157.51	154.89	-2.6207
64	20	LDR unbiased	156.91	154.85	-2.0635
65	30	LDR unbiased	154.81	150.93	-3.873
66	30	LDR unbiased	157.85	153.82	-4.034
67	30	LDR unbiased	158.31	153.52	-4.7841
68	30	LDR unbiased	155.15	151.47	-3.6809
69	30	LDR unbiased	155.93	152.16	-3.7777
70	0	correlation	155.83	154.34	-1.4888
71	0	correlation	158.49	156.57	-1.923
72	0	correlation	158.17	156.69	-1.4776
73	0	correlation	157.6	156.62	-0.9878
74	0	correlation	157.26	156.5	-0.7595

TID vs Post - Pre Exposure Delta

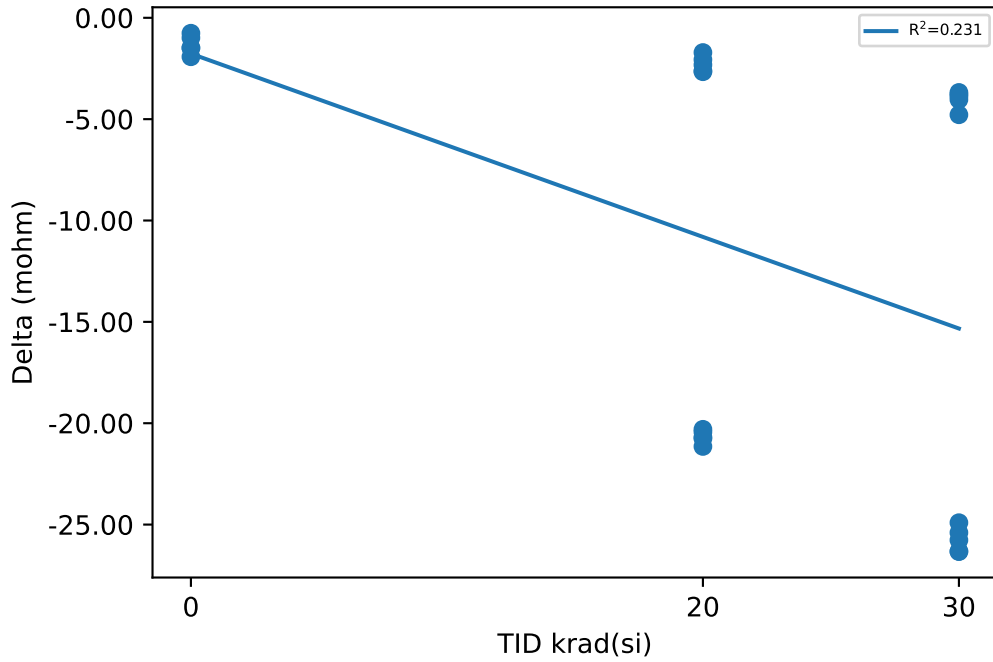

Test Statistics (mohm)

krad(si)	Pre Exposure Min	Pre Exposure Avg	Pre Exposure Max	Pre Exposure Std	Post Exposure Min	Post Exposure Avg	Post Exposure Max	Post Exposure Std	Min Delta	Avg Delta	Max Delta	Std Delta
0	155.83	157.47	158.49	1.0352	154.34	156.14	156.69	1.009	-1.923	-1.3273	-0.7595	0.45858
20	154.53	156.89	157.97	1.0478	134.23	145.42	156.11	10.188	-21.147	-11.47	-1.7119	9.6978
30	154.81	157.01	159.99	1.5537	130.93	142.12	153.82	10.871	-26.333	-14.887	-3.6809	11.456

Device Test: 12.13 UJ4ZR4(RDSON_5V_OUT4_UJE410_UJ4ZR4)

TID vs Result Stats

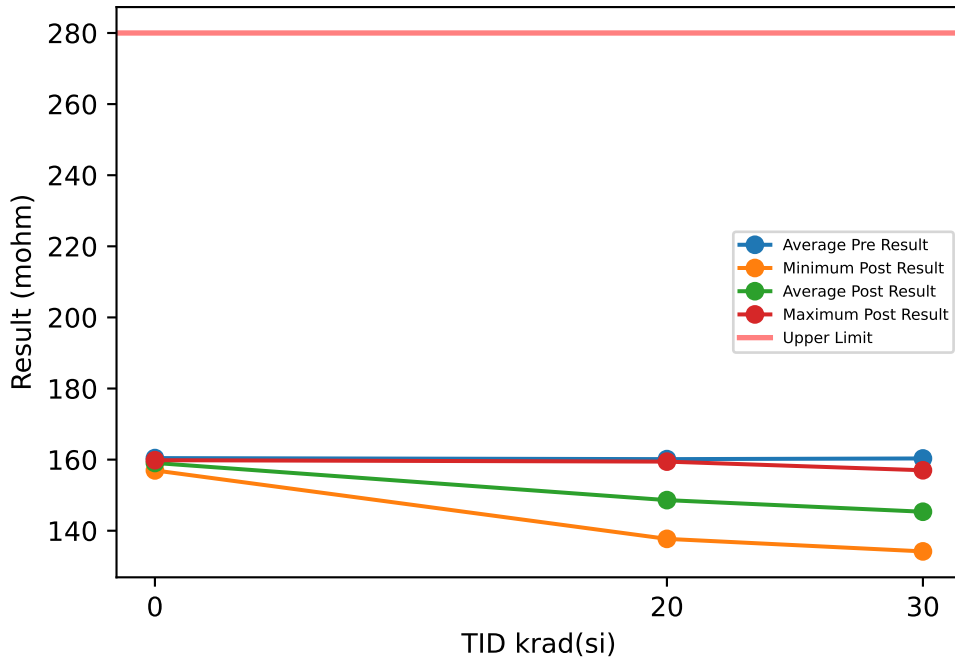

Test Results (Upper Limit = 280.0 (mohm))

Serial #	krad(si)	Exposure Conditions	Pre Result	Post Result	Delta
50	20	LDR biased	158.14	137.71	-20.433
51	20	LDR biased	160.84	139.64	-21.197
52	20	LDR biased	159.89	138.96	-20.93
53	20	LDR biased	160.31	139.45	-20.853
54	20	LDR biased	159.41	138.89	-20.525
55	30	LDR biased	160.62	134.19	-26.432
56	30	LDR biased	160.92	134.99	-25.931
57	30	LDR biased	159.39	134.27	-25.123
58	30	LDR biased	160.6	134.99	-25.611
59	30	LDR biased	162.7	136.36	-26.342
60	20	LDR unbiased	160.32	157.8	-2.5197
61	20	LDR unbiased	160.1	157.63	-2.4733
62	20	LDR unbiased	161.14	159.44	-1.7031
63	20	LDR unbiased	160.3	157.63	-2.6647
64	20	LDR unbiased	160.95	158.93	-2.0187
65	30	LDR unbiased	158.94	154.91	-4.0351
66	30	LDR unbiased	161.07	157	-4.0689
67	30	LDR unbiased	161.14	156.33	-4.8127
68	30	LDR unbiased	158.6	154.92	-3.6759
69	30	LDR unbiased	159.31	155.47	-3.8379
70	0	correlation	158.48	156.96	-1.5129
71	0	correlation	161.33	159.4	-1.9266
72	0	correlation	160.95	159.53	-1.4186
73	0	correlation	161.02	159.84	-1.1815
74	0	correlation	160.39	159.57	-0.8134

TID vs Post - Pre Exposure Delta

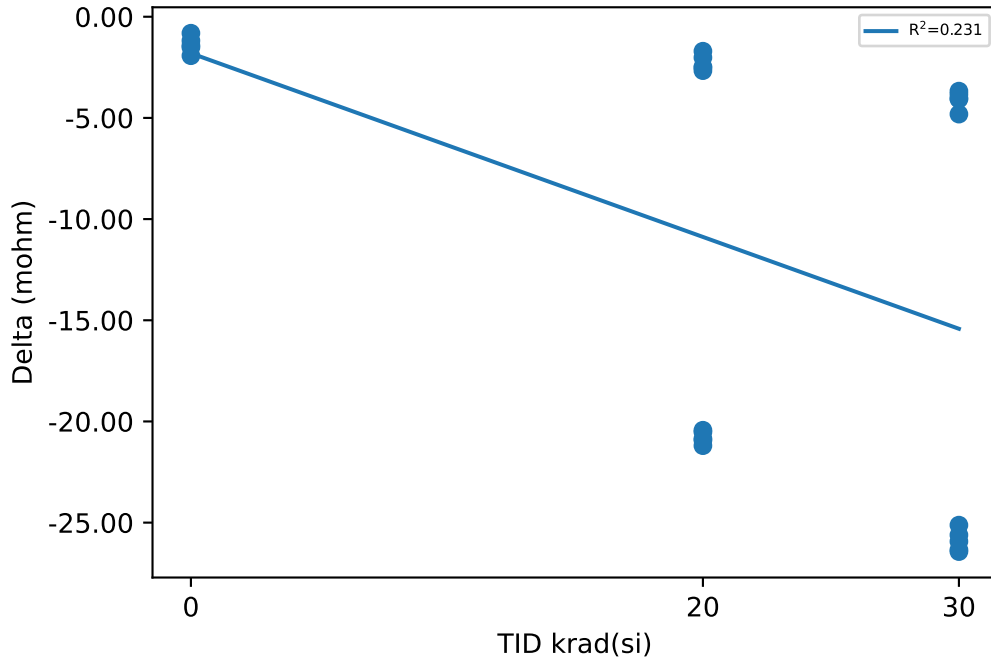

Test Statistics (mohm)

krad(si)	Pre Exposure Min	Pre Exposure Avg	Pre Exposure Max	Pre Exposure Std	Post Exposure Min	Post Exposure Avg	Post Exposure Max	Post Exposure Std	Min Delta	Avg Delta	Max Delta	Std Delta
0	158.48	160.43	161.33	1.1448	156.96	159.06	159.84	1.1832	-1.9266	-1.3706	-0.8134	0.41168
20	158.14	160.14	161.14	0.86974	137.71	148.61	159.44	10.23	-21.197	-11.532	-1.7031	9.7624
30	158.6	160.33	162.7	1.2558	134.19	145.34	157	10.977	-26.432	-14.987	-3.6759	11.5

Device Test: 12.14 UJ4ZR4(RDSON_12V_OUT4_UJE410_UJ4ZR4)

TID vs Result Stats

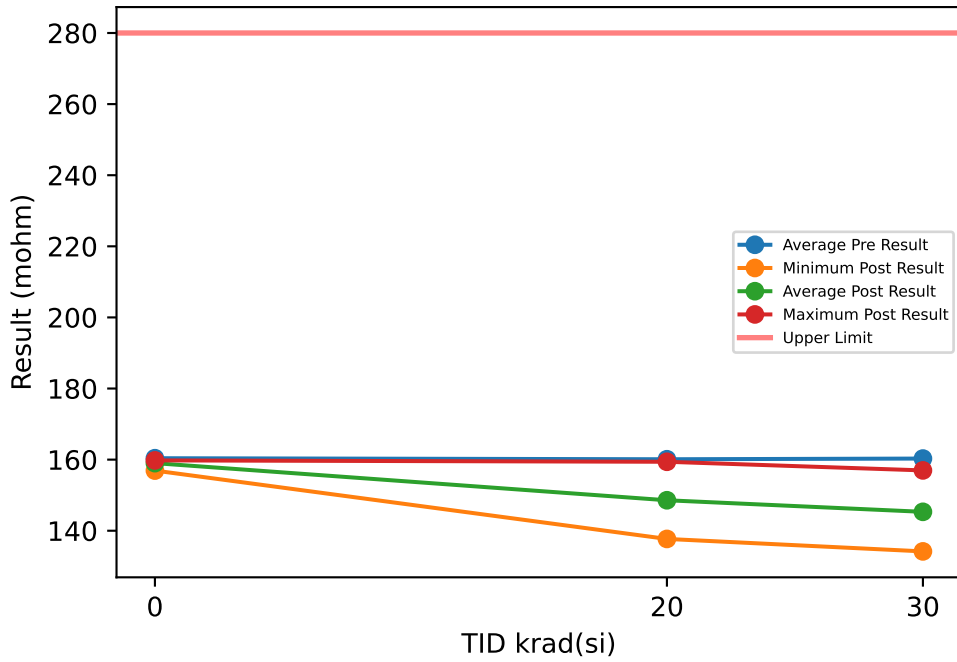

Test Results (Upper Limit = 280.0 (mohm))

Serial #	krad(si)	Exposure Conditions	Pre Result	Post Result	Delta
50	20	LDR biased	158.12	137.7	-20.427
51	20	LDR biased	160.81	139.61	-21.196
52	20	LDR biased	159.85	138.92	-20.93
53	20	LDR biased	160.29	139.43	-20.861
54	20	LDR biased	159.37	138.85	-20.529
55	30	LDR biased	160.58	134.19	-26.388
56	30	LDR biased	160.91	134.96	-25.945
57	30	LDR biased	159.37	134.24	-25.127
58	30	LDR biased	160.57	134.96	-25.605
59	30	LDR biased	162.67	136.36	-26.306
60	20	LDR unbiased	160.3	157.76	-2.5407
61	20	LDR unbiased	160.07	157.59	-2.4727
62	20	LDR unbiased	161.1	159.4	-1.7022
63	20	LDR unbiased	160.24	157.57	-2.6708
64	20	LDR unbiased	160.91	158.89	-2.0195
65	30	LDR unbiased	158.92	154.88	-4.0347
66	30	LDR unbiased	161.04	156.97	-4.0673
67	30	LDR unbiased	161.11	156.29	-4.8201
68	30	LDR unbiased	158.54	154.87	-3.6706
69	30	LDR unbiased	159.3	155.44	-3.8572
70	0	correlation	158.44	156.92	-1.5198
71	0	correlation	161.29	159.37	-1.9242
72	0	correlation	160.92	159.48	-1.4479
73	0	correlation	160.99	159.79	-1.206
74	0	correlation	160.35	159.52	-0.8326

TID vs Post - Pre Exposure Delta

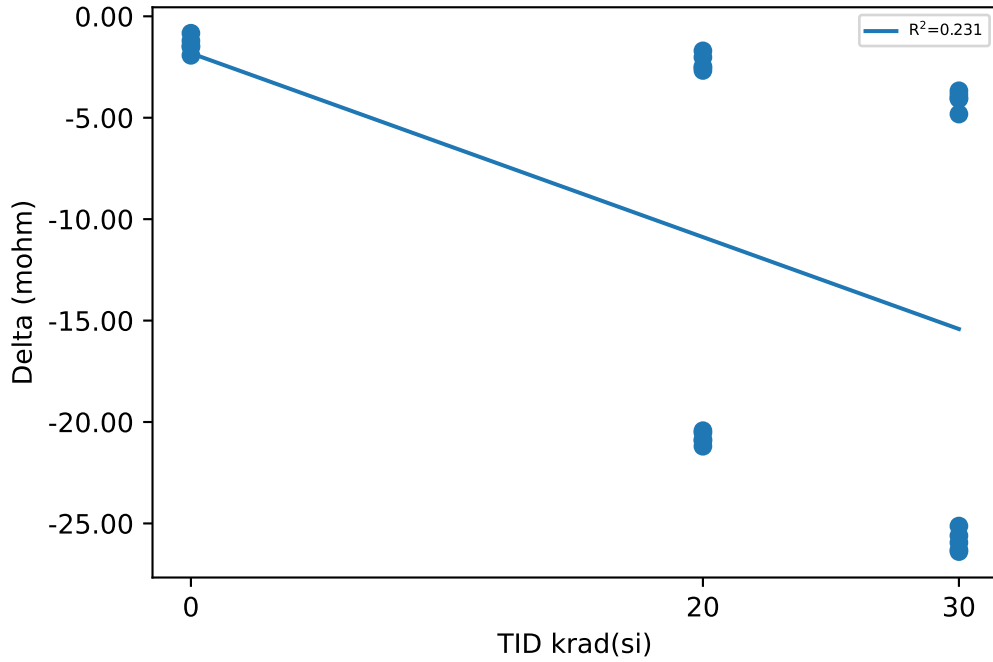

Test Statistics (mohm)

krad(si)	Pre Exposure Min	Pre Exposure Avg	Pre Exposure Max	Pre Exposure Std	Post Exposure Min	Post Exposure Avg	Post Exposure Max	Post Exposure Std	Min Delta	Avg Delta	Max Delta	Std Delta
0	158.44	160.4	161.29	1.1491	156.92	159.01	159.79	1.1827	-1.9242	-1.3861	-0.8326	0.40313
20	158.12	160.11	161.1	0.86599	137.7	148.57	159.4	10.222	-21.196	-11.535	-1.7022	9.7601
30	158.54	160.3	162.67	1.2559	134.19	145.32	156.97	10.968	-26.388	-14.982	-3.6706	11.49

Device Test: 12.15 UJ4ZR4(RDSON_28V_OUT4_UJE410_UJ4ZR4)

TID vs Result Stats

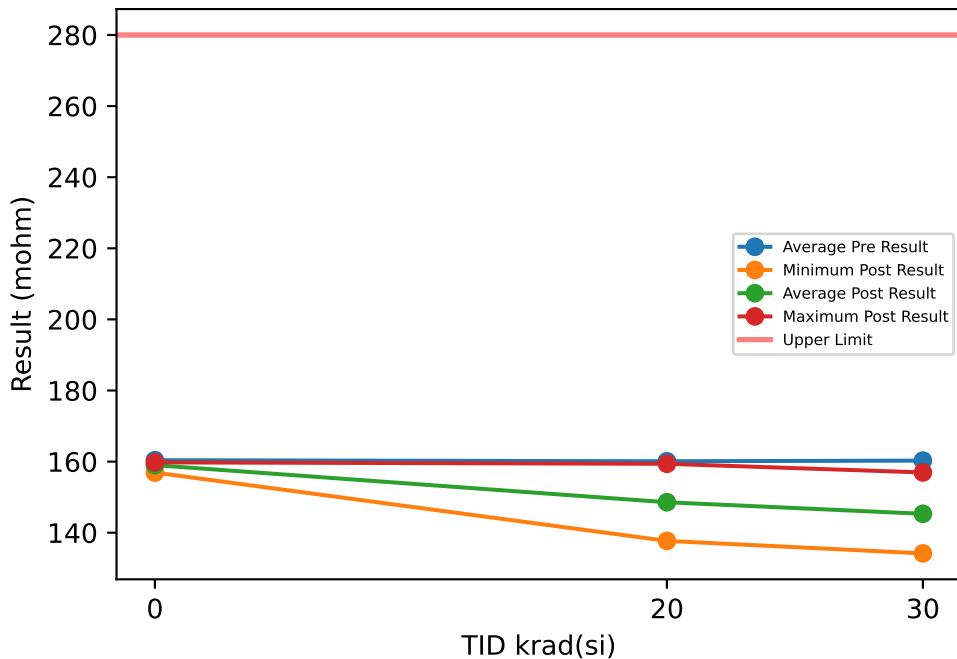

Test Results (Upper Limit = 280.0 (mohm))

Serial #	krad(si)	Exposure Conditions	Pre Result	Post Result	Delta
50	20	LDR biased	158.1	137.7	-20.406
51	20	LDR biased	160.8	139.61	-21.181
52	20	LDR biased	159.84	138.92	-20.918
53	20	LDR biased	160.27	139.44	-20.838
54	20	LDR biased	159.36	138.84	-20.517
55	30	LDR biased	160.56	134.18	-26.382
56	30	LDR biased	160.89	134.97	-25.916
57	30	LDR biased	159.35	134.24	-25.109
58	30	LDR biased	160.55	134.97	-25.58
59	30	LDR biased	162.65	136.35	-26.308
60	20	LDR unbiased	160.29	157.76	-2.5293
61	20	LDR unbiased	160.05	157.57	-2.4774
62	20	LDR unbiased	161.08	159.38	-1.7056
63	20	LDR unbiased	160.24	157.57	-2.6732
64	20	LDR unbiased	160.9	158.88	-2.0189
65	30	LDR unbiased	158.89	154.88	-4.0131
66	30	LDR unbiased	161.02	156.95	-4.0715
67	30	LDR unbiased	161.09	156.3	-4.7897
68	30	LDR unbiased	158.52	154.87	-3.6533
69	30	LDR unbiased	159.27	155.42	-3.8501
70	0	correlation	158.43	156.91	-1.5116
71	0	correlation	161.31	159.35	-1.9553
72	0	correlation	160.9	159.47	-1.4309
73	0	correlation	160.98	159.78	-1.1993
74	0	correlation	160.35	159.5	-0.8432

TID vs Post - Pre Exposure Delta

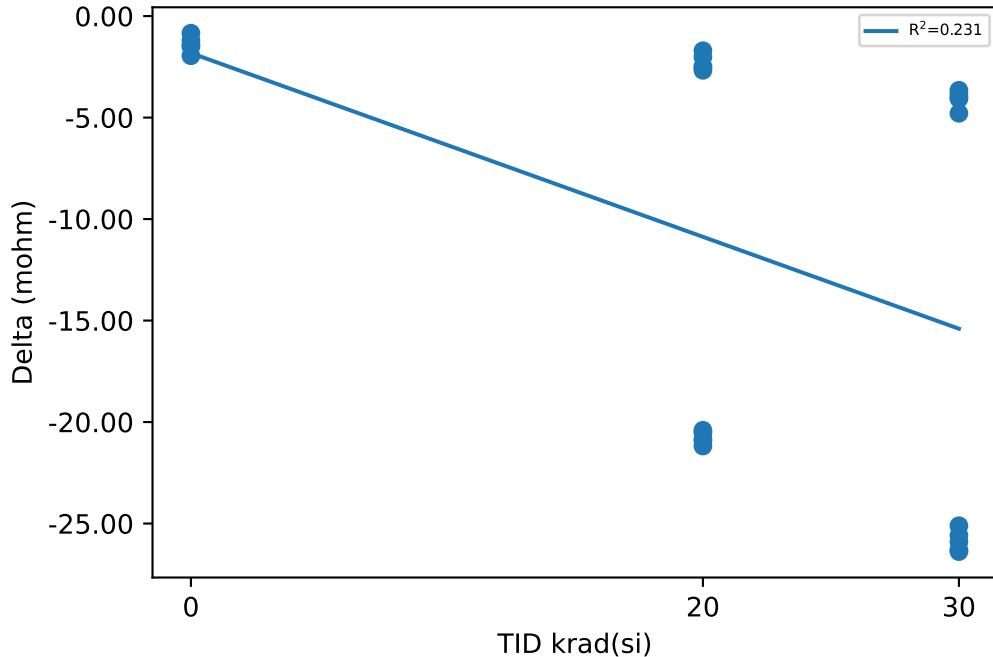

Test Statistics (mohm)

krad(si)	Pre Exposure Min	Pre Exposure Avg	Pre Exposure Max	Pre Exposure Std	Post Exposure Min	Post Exposure Avg	Post Exposure Max	Post Exposure Std	Min Delta	Avg Delta	Max Delta	Std Delta
0	158.43	160.39	161.31	1.1529	156.91	159	159.78	1.1795	-1.9553	-1.3881	-0.8432	0.40968
20	158.1	160.09	161.08	0.86821	137.7	148.57	159.38	10.215	-21.181	-11.526	-1.7056	9.7516
30	158.52	160.28	162.65	1.2598	134.18	145.31	156.95	10.964	-26.382	-14.967	-3.6533	11.49

Device Test: 12.16 UJ4ZR4(RDSON_32V_OUT4_UJE410_UJ4ZR4)

TID vs Result Stats

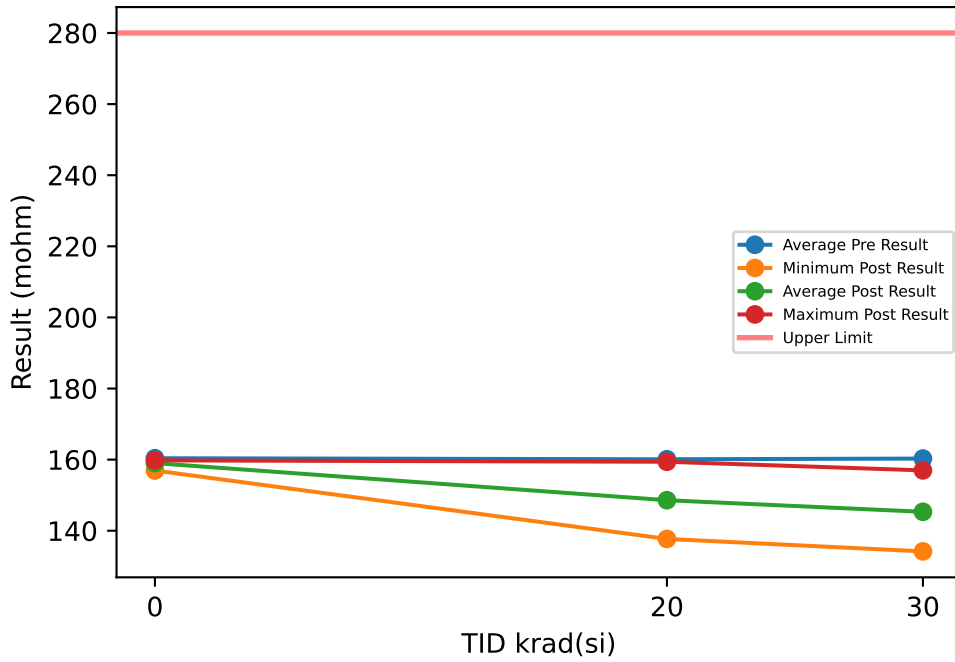

Test Results (Upper Limit = 280.0 (mohm))

Serial #	krad(si)	Exposure Conditions	Pre Result	Post Result	Delta
50	20	LDR biased	158.1	137.7	-20.405
51	20	LDR biased	160.8	139.63	-21.178
52	20	LDR biased	159.84	138.95	-20.895
53	20	LDR biased	160.29	139.44	-20.851
54	20	LDR biased	159.35	138.85	-20.498
55	30	LDR biased	160.57	134.19	-26.379
56	30	LDR biased	160.9	134.98	-25.926
57	30	LDR biased	159.37	134.24	-25.124
58	30	LDR biased	160.57	134.97	-25.602
59	30	LDR biased	162.68	136.36	-26.315
60	20	LDR unbiased	160.3	157.76	-2.5396
61	20	LDR unbiased	160.06	157.6	-2.4615
62	20	LDR unbiased	161.1	159.4	-1.6988
63	20	LDR unbiased	160.25	157.6	-2.6522
64	20	LDR unbiased	160.91	158.91	-2.0073
65	30	LDR unbiased	158.91	154.88	-4.0297
66	30	LDR unbiased	161.04	156.97	-4.0672
67	30	LDR unbiased	161.11	156.31	-4.7967
68	30	LDR unbiased	158.54	154.89	-3.6507
69	30	LDR unbiased	159.28	155.45	-3.8325
70	0	correlation	158.41	156.93	-1.4779
71	0	correlation	161.3	159.37	-1.9285
72	0	correlation	160.91	159.48	-1.4324
73	0	correlation	160.99	159.79	-1.2
74	0	correlation	160.36	159.52	-0.8387

TID vs Post - Pre Exposure Delta

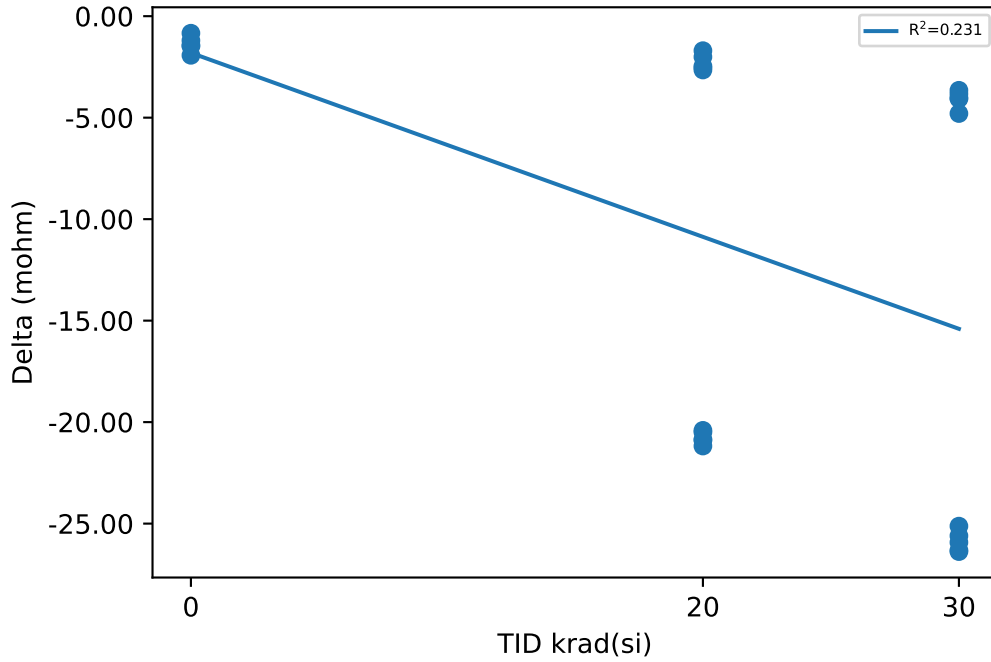

Test Statistics (mohm)

krad(si)	Pre Exposure Min	Pre Exposure Avg	Pre Exposure Max	Pre Exposure Std	Post Exposure Min	Post Exposure Avg	Post Exposure Max	Post Exposure Std	Min Delta	Avg Delta	Max Delta	Std Delta
0	158.41	160.39	161.3	1.159	156.93	159.02	159.79	1.1756	-1.9285	-1.3755	-0.8387	0.39953
20	158.1	160.1	161.1	0.87513	137.7	148.58	159.4	10.221	-21.178	-11.519	-1.6988	9.753
30	158.54	160.3	162.68	1.2607	134.19	145.32	156.97	10.97	-26.379	-14.972	-3.6507	11.495

Device Test: 12.17 UJJ3KD(Delta_RDSON_5V_CH1CH2_UJJ3KD)

TID vs Result Stats

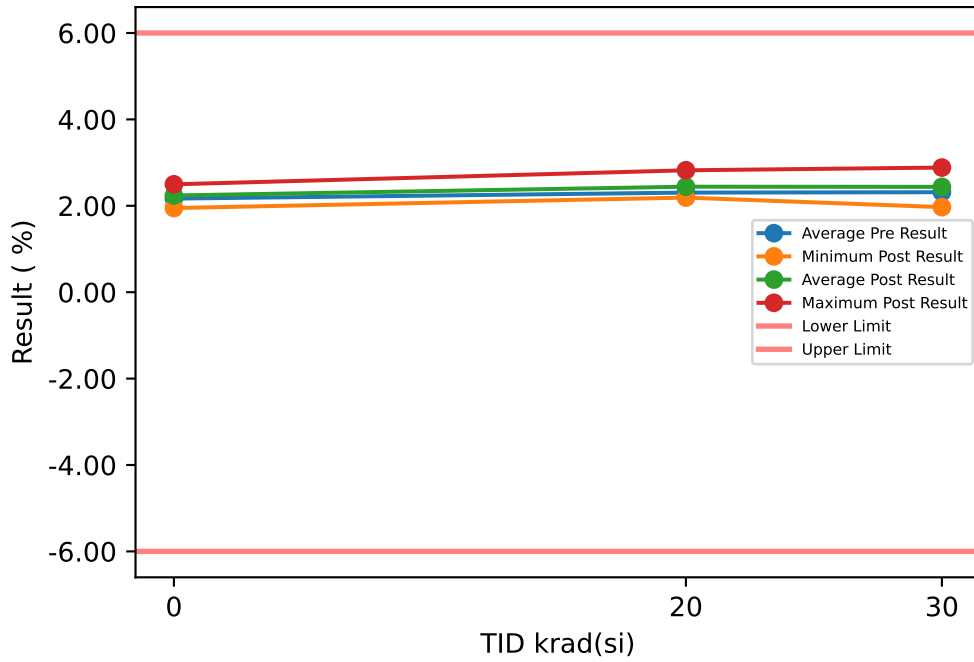

Test Results (Lower Limit = -6.0, Upper Limit = 6.0 (%))

Serial #	krad(si)	Exposure Conditions	Pre Result	Post Result	Delta
50	20	LDR biased	2.341	2.602	0.261
51	20	LDR biased	2.171	2.284	0.113
52	20	LDR biased	2.491	2.822	0.331
53	20	LDR biased	2.022	2.19	0.168
54	20	LDR biased	2.351	2.418	0.067
55	30	LDR biased	2.556	2.885	0.329
56	30	LDR biased	1.878	1.969	0.091
57	30	LDR biased	2.2	2.241	0.041
58	30	LDR biased	2.065	2.356	0.291
59	30	LDR biased	2.036	2.221	0.185
60	20	LDR unbiased	2.35	2.402	0.052
61	20	LDR unbiased	2.195	2.244	0.049
62	20	LDR unbiased	2.596	2.709	0.113
63	20	LDR unbiased	2.212	2.338	0.126
64	20	LDR unbiased	2.326	2.41	0.084
65	30	LDR unbiased	2.421	2.519	0.098
66	30	LDR unbiased	2.329	2.418	0.089
67	30	LDR unbiased	2.431	2.449	0.018
68	30	LDR unbiased	2.517	2.596	0.079
69	30	LDR unbiased	2.712	2.73	0.018
70	0	correlation	2.261	2.279	0.018
71	0	correlation	2.412	2.497	0.085
72	0	correlation	1.902	1.948	0.046
73	0	correlation	2.005	2.193	0.188
74	0	correlation	2.253	2.277	0.024

TID vs Post - Pre Exposure Delta

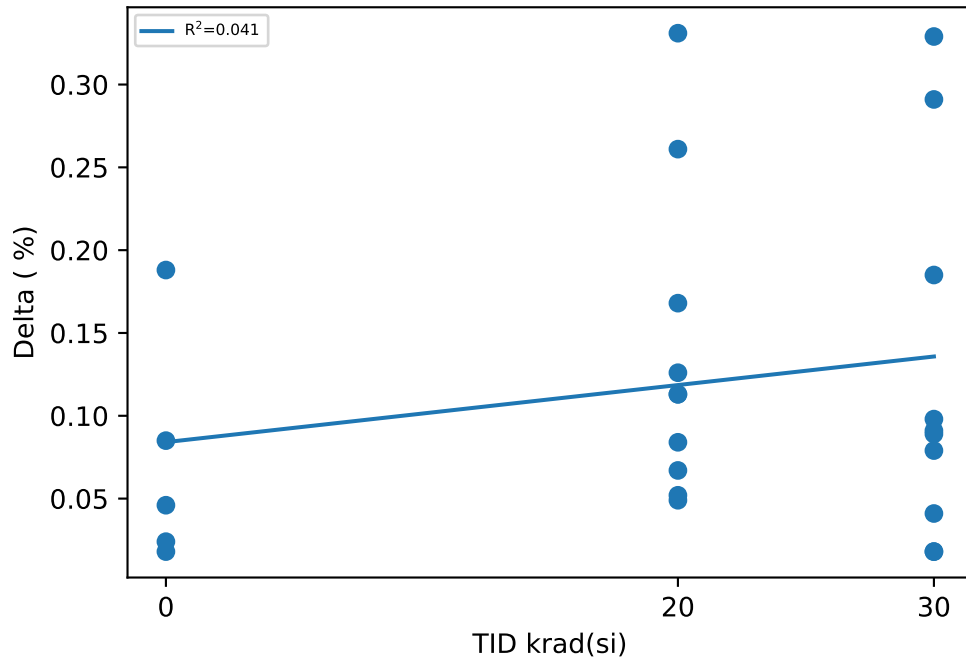

Test Statistics (%)

krad(si)	Pre Exposure Min	Pre Exposure Avg	Pre Exposure Max	Pre Exposure Std	Post Exposure Min	Post Exposure Avg	Post Exposure Max	Post Exposure Std	Min Delta	Avg Delta	Max Delta	Std Delta
0	1.902	2.1666	2.412	0.2078	1.948	2.2388	2.497	0.19774	0.018	0.0722	0.188	0.069858
20	2.022	2.3055	2.596	0.16464	2.19	2.4419	2.822	0.20628	0.049	0.1364	0.331	0.093047
30	1.878	2.3145	2.712	0.26372	1.969	2.4384	2.885	0.26451	0.018	0.1239	0.329	0.10955

Device Test: 12.18 UJJ3KD(Delta_RDSON_5V_CH1CH3_UJJ3KD)

TID vs Result Stats

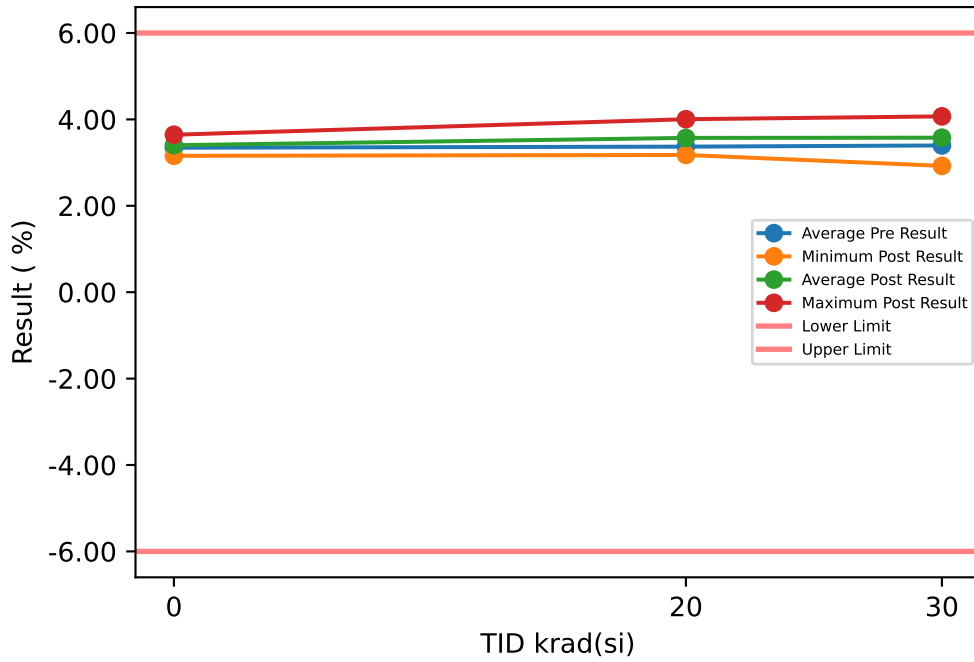

Test Results (Lower Limit = -6.0, Upper Limit = 6.0 (%))

Serial #	krad(si)	Exposure Conditions	Pre Result	Post Result	Delta
50	20	LDR biased	3.389	3.664	0.275
51	20	LDR biased	3	3.297	0.297
52	20	LDR biased	3.15	3.441	0.291
53	20	LDR biased	3.195	3.44	0.245
54	20	LDR biased	3.627	4.004	0.377
55	30	LDR biased	3.537	4.029	0.492
56	30	LDR biased	3.031	3.321	0.29
57	30	LDR biased	3.412	3.605	0.193
58	30	LDR biased	3.117	3.485	0.368
59	30	LDR biased	2.494	2.924	0.43
60	20	LDR unbiased	3.598	3.75	0.152
61	20	LDR unbiased	3.166	3.177	0.011
62	20	LDR unbiased	3.39	3.494	0.104
63	20	LDR unbiased	3.435	3.564	0.129
64	20	LDR unbiased	3.745	3.886	0.141
65	30	LDR unbiased	3.882	3.809	-0.073
66	30	LDR unbiased	3.093	3.254	0.161
67	30	LDR unbiased	3.465	3.46	-0.005
68	30	LDR unbiased	4.117	4.07	-0.047
69	30	LDR unbiased	3.821	3.804	-0.017
70	0	correlation	3.531	3.645	0.114
71	0	correlation	3.367	3.426	0.059
72	0	correlation	3.147	3.288	0.141
73	0	correlation	3.591	3.495	-0.096
74	0	correlation	3.086	3.157	0.071

TID vs Post - Pre Exposure Delta

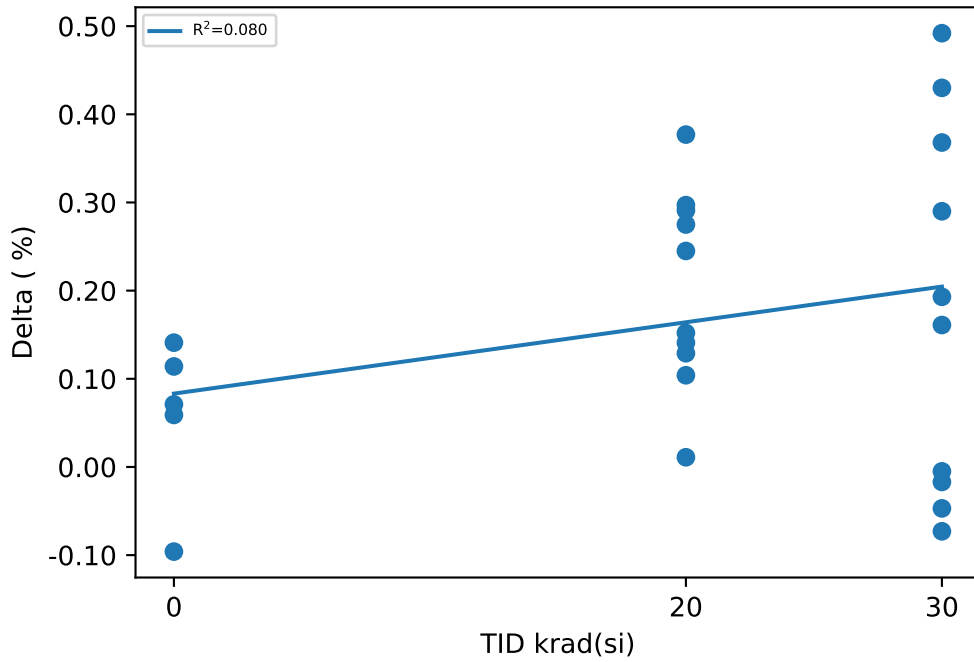

Test Statistics (%)

krad(si)	Pre Exposure Min	Pre Exposure Avg	Pre Exposure Max	Pre Exposure Std	Post Exposure Min	Post Exposure Avg	Post Exposure Max	Post Exposure Std	Min Delta	Avg Delta	Max Delta	Std Delta
0	3.086	3.3444	3.591	0.22465	3.157	3.4022	3.645	0.18795	-0.096	0.0578	0.141	0.092074
20	3	3.3695	3.745	0.24064	3.177	3.5717	4.004	0.25771	0.011	0.2022	0.377	0.11175
30	2.494	3.3969	4.117	0.48051	2.924	3.5761	4.07	0.36085	-0.073	0.1792	0.492	0.20986

Device Test: 12.19 UJJ3KD(Delta_RDSON_5V_CH1CH4_UJJ3KD)

TID vs Result Stats

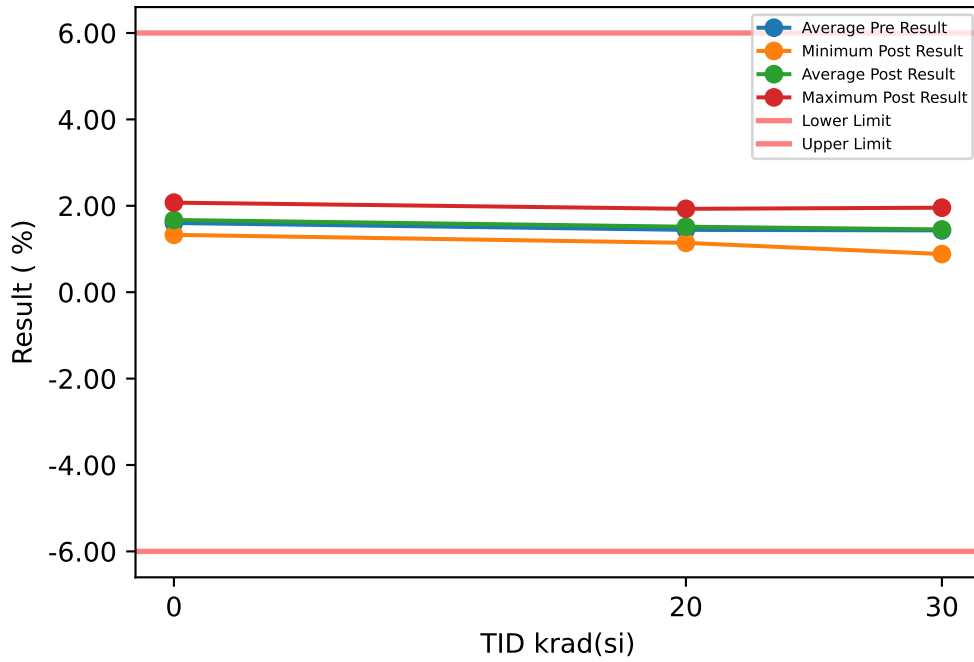

Test Results (Lower Limit = -6.0, Upper Limit = 6.0 (%))

Serial #	krad(si)	Exposure Conditions	Pre Result	Post Result	Delta
50	20	LDR biased	1.205	1.232	0.027
51	20	LDR biased	1.301	1.383	0.082
52	20	LDR biased	1.593	1.796	0.203
53	20	LDR biased	1.138	1.142	0.004
54	20	LDR biased	1.381	1.452	0.071
55	30	LDR biased	1.532	1.717	0.185
56	30	LDR biased	0.922	0.883	-0.039
57	30	LDR biased	1.487	1.457	-0.03
58	30	LDR biased	1.156	1.262	0.106
59	30	LDR biased	0.917	1.03	0.113
60	20	LDR unbiased	1.683	1.712	0.029
61	20	LDR unbiased	1.529	1.594	0.065
62	20	LDR unbiased	1.436	1.502	0.066
63	20	LDR unbiased	1.815	1.93	0.115
64	20	LDR unbiased	1.344	1.417	0.073
65	30	LDR unbiased	1.388	1.35	-0.038
66	30	LDR unbiased	1.21	1.341	0.131
67	30	LDR unbiased	1.811	1.766	-0.045
68	30	LDR unbiased	2.065	1.956	-0.109
69	30	LDR unbiased	1.818	1.767	-0.051
70	0	correlation	1.963	2.073	0.11
71	0	correlation	1.698	1.75	0.052
72	0	correlation	1.524	1.624	0.1
73	0	correlation	1.568	1.583	0.015
74	0	correlation	1.255	1.328	0.073

TID vs Post - Pre Exposure Delta

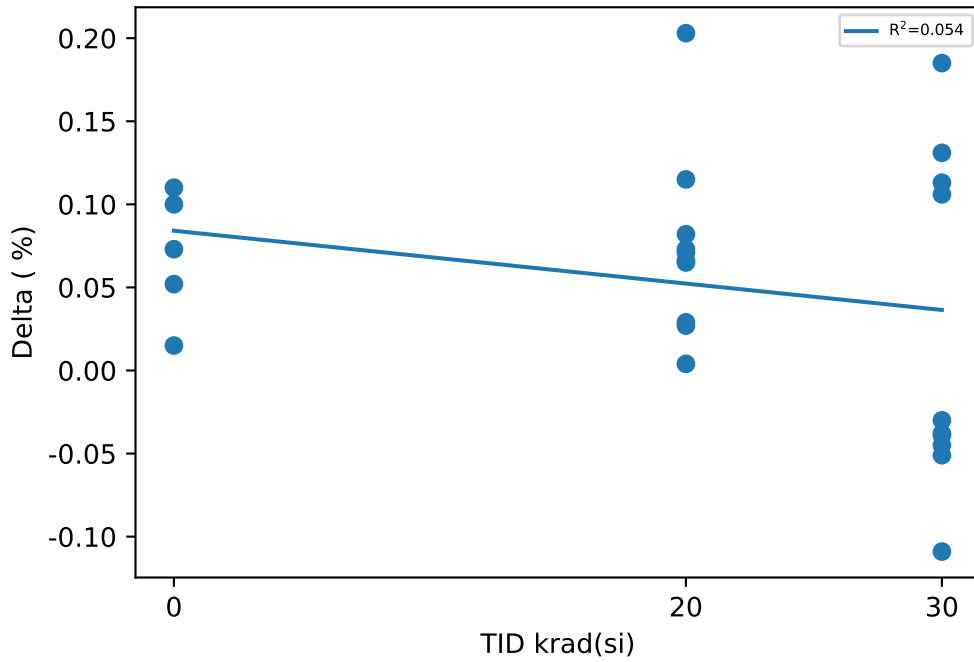

Test Statistics (%)

krad(si)	Pre Exposure Min	Pre Exposure Avg	Pre Exposure Max	Pre Exposure Std	Post Exposure Min	Post Exposure Avg	Post Exposure Max	Post Exposure Std	Min Delta	Avg Delta	Max Delta	Std Delta
0	1.255	1.6016	1.963	0.25845	1.328	1.6716	2.073	0.27177	0.015	0.07	0.11	0.038269
20	1.138	1.4425	1.815	0.21328	1.142	1.516	1.93	0.24644	0.004	0.0735	0.203	0.05545
30	0.917	1.4306	2.065	0.38859	0.883	1.4529	1.956	0.34685	-0.109	0.0223	0.185	0.10044

Device Test: 12.2 UJ4ZR4(RDSON_12V_OUT1_UJE410_UJ4ZR4)

TID vs Result Stats

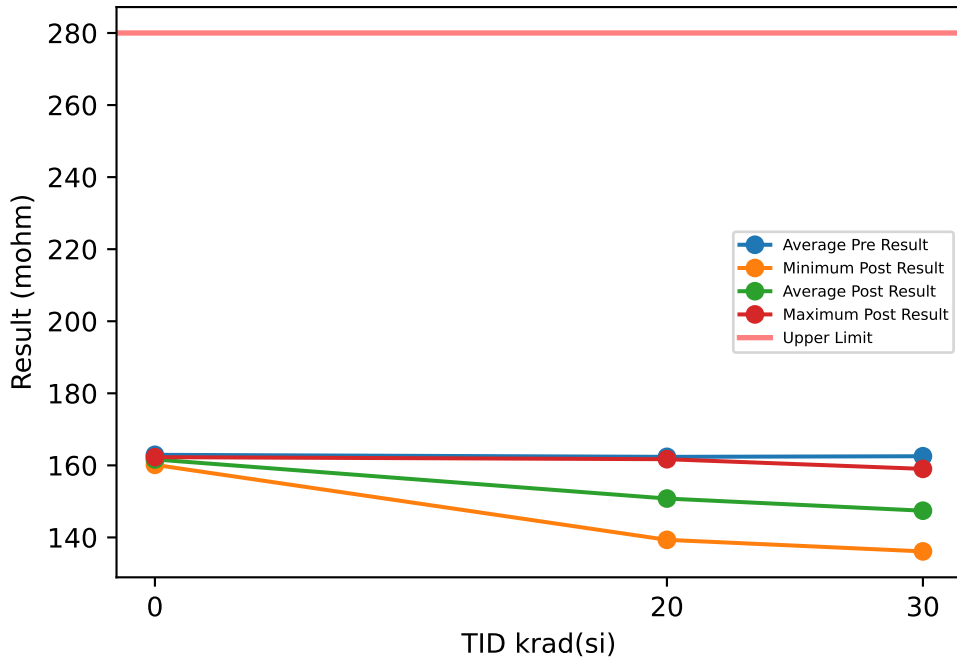

Test Results (Upper Limit = 280.0 (mohm))

Serial #	krad(si)	Exposure Conditions	Pre Result	Post Result	Delta
50	20	LDR biased	159.97	139.33	-20.643
51	20	LDR biased	162.83	141.5	-21.323
52	20	LDR biased	162.34	141.43	-20.914
53	20	LDR biased	162.03	140.98	-21.056
54	20	LDR biased	161.55	140.84	-20.712
55	30	LDR biased	163.01	136.49	-26.52
56	30	LDR biased	162.33	136.12	-26.208
57	30	LDR biased	161.65	136.17	-25.475
58	30	LDR biased	162.37	136.66	-25.71
59	30	LDR biased	164.11	137.72	-26.387
60	20	LDR unbiased	162.94	160.43	-2.5141
61	20	LDR unbiased	162.46	160.06	-2.402
62	20	LDR unbiased	163.35	161.71	-1.6355
63	20	LDR unbiased	163.14	160.58	-2.5573
64	20	LDR unbiased	163.04	161.08	-1.9576
65	30	LDR unbiased	161.05	156.92	-4.1297
66	30	LDR unbiased	162.92	159.03	-3.8881
67	30	LDR unbiased	163.99	159.03	-4.9643
68	30	LDR unbiased	161.77	157.89	-3.884
69	30	LDR unbiased	162.14	158.15	-3.9885
70	0	correlation	161.52	160.15	-1.3743
71	0	correlation	164.01	162.12	-1.8832
72	0	correlation	163.32	162.05	-1.2659
73	0	correlation	163.49	162.28	-1.2137
74	0	correlation	162.3	161.61	-0.6928

TID vs Post - Pre Exposure Delta

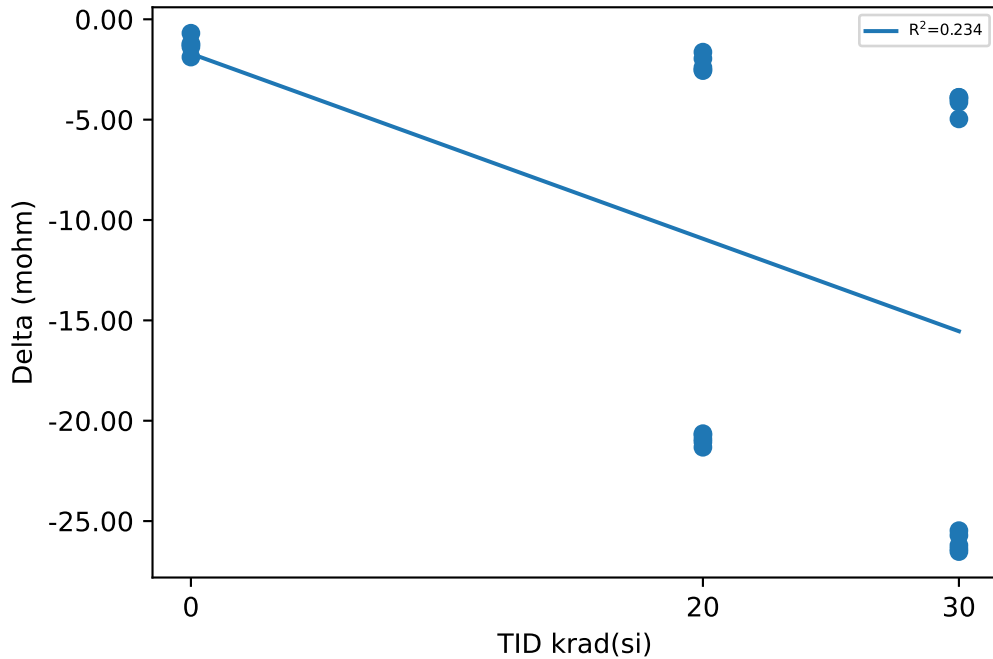

Test Statistics (mohm)

krad(si)	Pre Exposure Min	Pre Exposure Avg	Pre Exposure Max	Pre Exposure Std	Post Exposure Min	Post Exposure Avg	Post Exposure Max	Post Exposure Std	Min Delta	Avg Delta	Max Delta	Std Delta
0	161.52	162.93	164.01	1.0013	160.15	161.64	162.28	0.87271	-1.8832	-1.286	-0.6928	0.42484
20	159.97	162.37	163.35	1.0036	139.33	150.79	161.71	10.543	-21.323	-11.571	-1.6355	9.8697
30	161.05	162.53	164.11	0.98741	136.12	147.42	159.03	11.392	-26.52	-15.115	-3.884	11.544

Device Test: 12.20 UJJ3KD(Delta_RDSON_5V_CH2CH3_UJJ3KD)

TID vs Result Stats

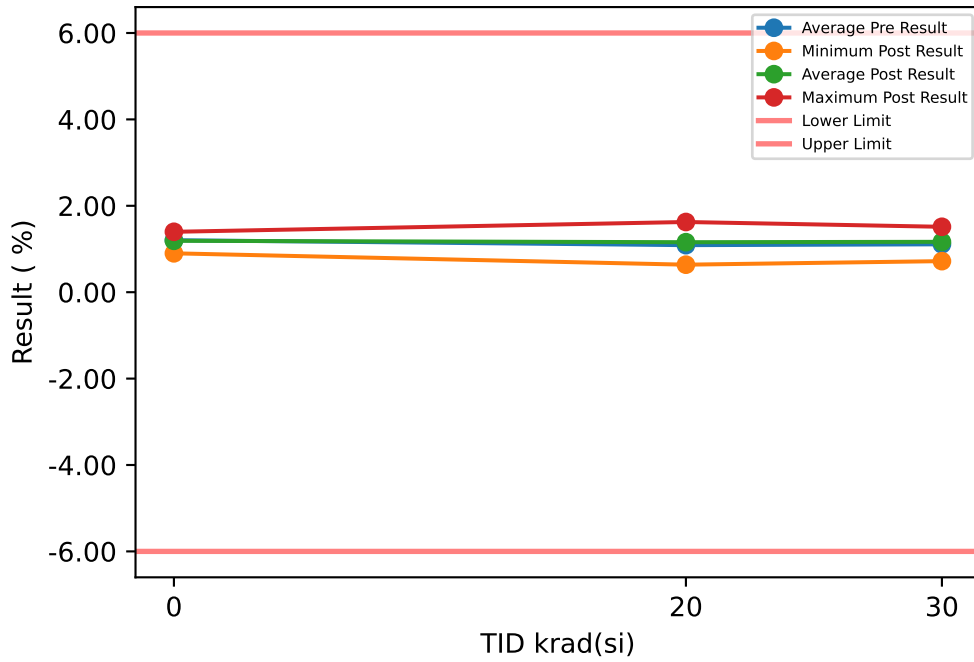

Test Results (Lower Limit = -6.0, Upper Limit = 6.0 (%))

Serial #	krad(si)	Exposure Conditions	Pre Result	Post Result	Delta
50	20	LDR biased	1.074	1.09	0.016
51	20	LDR biased	0.847	1.036	0.189
52	20	LDR biased	0.675	0.637	-0.038
53	20	LDR biased	1.198	1.278	0.08
54	20	LDR biased	1.307	1.625	0.318
55	30	LDR biased	1.007	1.178	0.171
56	30	LDR biased	1.174	1.379	0.205
57	30	LDR biased	1.24	1.395	0.155
58	30	LDR biased	1.074	1.156	0.082
59	30	LDR biased	0.468	0.719	0.251
60	20	LDR unbiased	1.277	1.381	0.104
61	20	LDR unbiased	0.993	0.954	-0.039
62	20	LDR unbiased	0.815	0.807	-0.008
63	20	LDR unbiased	1.25	1.256	0.006
64	20	LDR unbiased	1.453	1.512	0.059
65	30	LDR unbiased	1.497	1.323	-0.174
66	30	LDR unbiased	0.783	0.857	0.074
67	30	LDR unbiased	1.059	1.037	-0.022
68	30	LDR unbiased	1.641	1.514	-0.127
69	30	LDR unbiased	1.14	1.105	-0.035
70	0	correlation	1.299	1.398	0.099
71	0	correlation	0.979	0.952	-0.027
72	0	correlation	1.27	1.367	0.097
73	0	correlation	1.618	1.331	-0.287
74	0	correlation	0.852	0.9	0.048

TID vs Post - Pre Exposure Delta

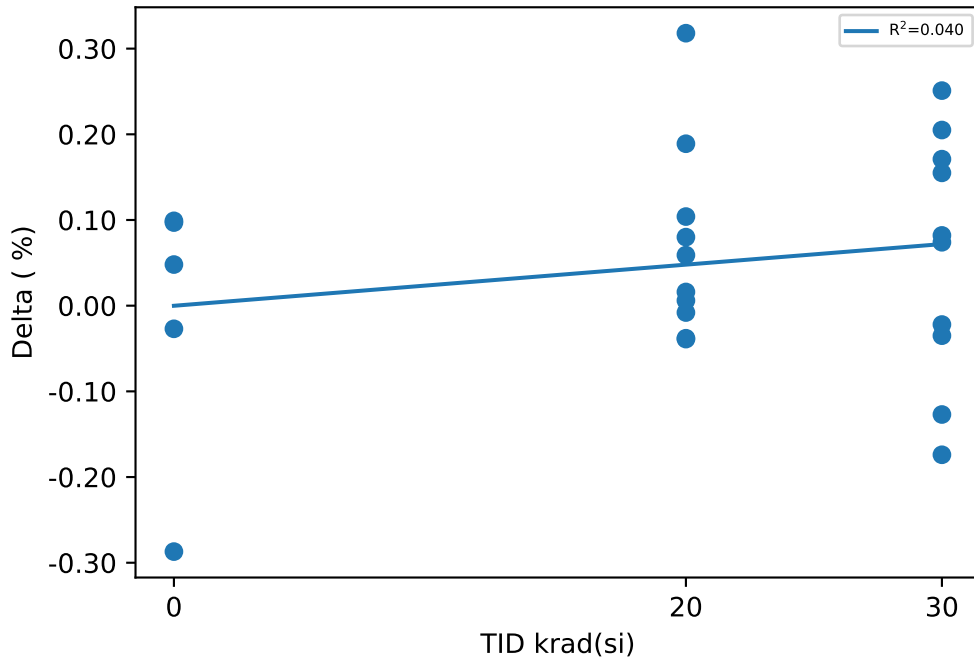

Test Statistics (%)

krad(si)	Pre Exposure Min	Pre Exposure Avg	Pre Exposure Max	Pre Exposure Std	Post Exposure Min	Post Exposure Avg	Post Exposure Max	Post Exposure Std	Min Delta	Avg Delta	Max Delta	Std Delta
0	0.852	1.2036	1.618	0.29971	0.9	1.1896	1.398	0.2425	-0.287	-0.014	0.099	0.16096
20	0.675	1.0889	1.453	0.25114	0.637	1.1576	1.625	0.31143	-0.039	0.0687	0.318	0.11238
30	0.468	1.1083	1.641	0.33119	0.719	1.1663	1.514	0.24932	-0.174	0.058	0.251	0.14336

Device Test: 12.21 UJJ3KD(Delta_RDSON_5V_CH2CH4_UJJ3KD)

TID vs Result Stats

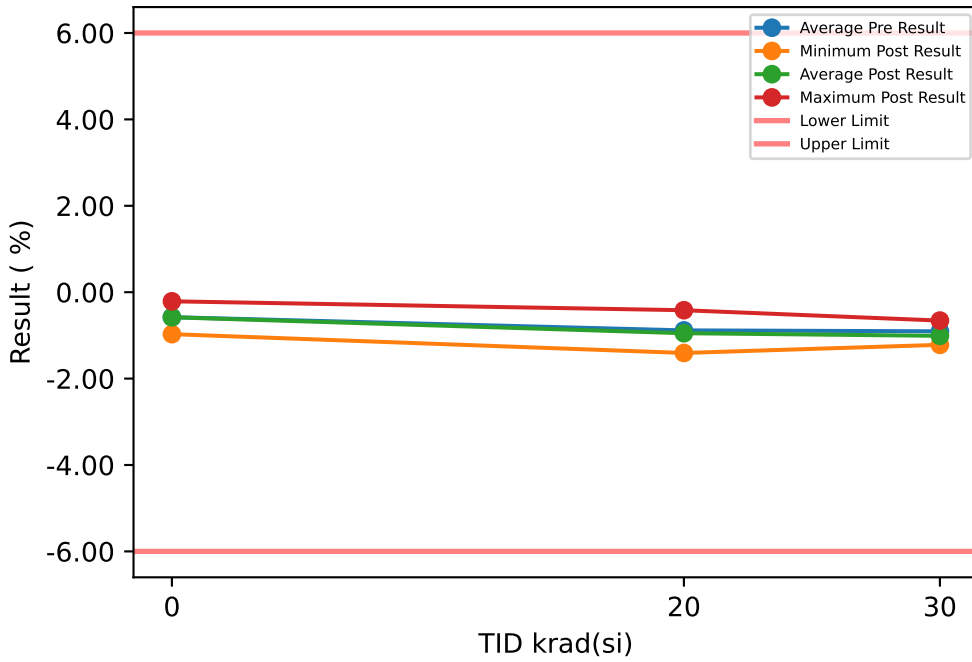

Test Results (Lower Limit = -6.0, Upper Limit = 6.0 (%))

Serial #	krad(si)	Exposure Conditions	Pre Result	Post Result	Delta
50	20	LDR biased	-1.163	-1.407	-0.244
51	20	LDR biased	-0.89	-0.922	-0.032
52	20	LDR biased	-0.921	-1.056	-0.135
53	20	LDR biased	-0.902	-1.071	-0.169
54	20	LDR biased	-0.994	-0.99	0.004
55	30	LDR biased	-1.051	-1.203	-0.152
56	30	LDR biased	-0.975	-1.108	-0.133
57	30	LDR biased	-0.729	-0.802	-0.073
58	30	LDR biased	-0.928	-1.12	-0.192
59	30	LDR biased	-1.142	-1.218	-0.076
60	20	LDR unbiased	-0.684	-0.708	-0.024
61	20	LDR unbiased	-0.681	-0.665	0.016
62	20	LDR unbiased	-1.19	-1.241	-0.051
63	20	LDR unbiased	-0.406	-0.417	-0.011
64	20	LDR unbiased	-1.005	-1.018	-0.013
65	30	LDR unbiased	-1.059	-1.199	-0.14
66	30	LDR unbiased	-1.146	-1.103	0.043
67	30	LDR unbiased	-0.636	-0.7	-0.064
68	30	LDR unbiased	-0.464	-0.657	-0.193
69	30	LDR unbiased	-0.919	-0.99	-0.071
70	0	correlation	-0.305	-0.211	0.094
71	0	correlation	-0.731	-0.767	-0.036
72	0	correlation	-0.385	-0.33	0.055
73	0	correlation	-0.447	-0.624	-0.177
74	0	correlation	-1.021	-0.971	0.05

TID vs Post - Pre Exposure Delta

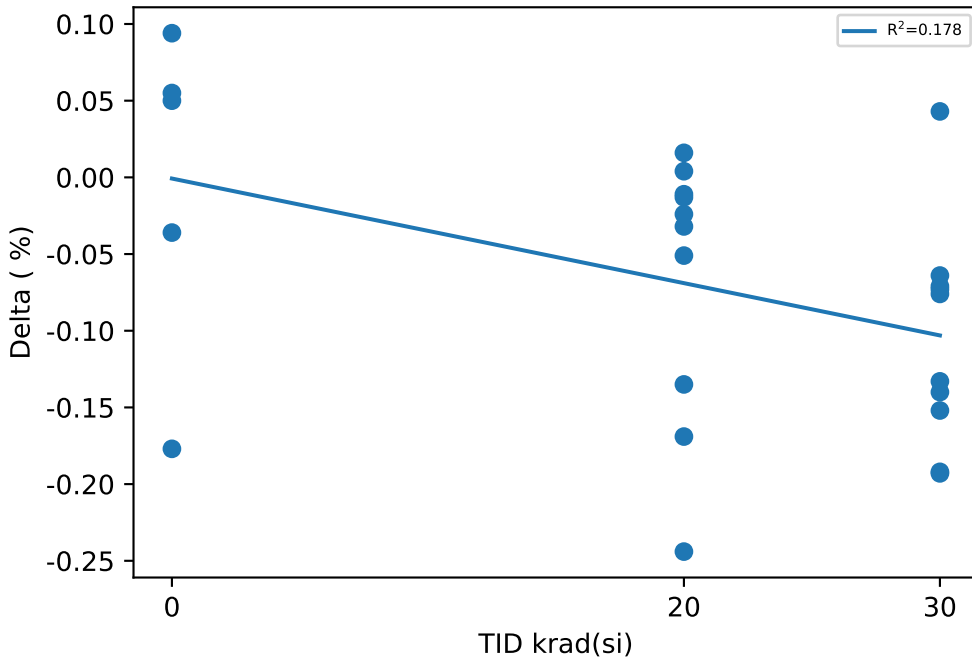

Test Statistics (%)

krad(si)	Pre Exposure Min	Pre Exposure Avg	Pre Exposure Max	Pre Exposure Std	Post Exposure Min	Post Exposure Avg	Post Exposure Max	Post Exposure Std	Min Delta	Avg Delta	Max Delta	Std Delta
0	-1.021	-0.5778	-0.305	0.29521	-0.971	-0.5806	-0.211	0.31163	-0.177	-0.0028	0.094	0.10834
20	-1.19	-0.8836	-0.406	0.23796	-1.407	-0.9495	-0.417	0.28873	-0.244	-0.0659	0.016	0.086703
30	-1.146	-0.9049	-0.464	0.22675	-1.218	-1.01	-0.657	0.21369	-0.193	-0.1051	0.043	0.071598

Device Test: 12.22 UJJ3KD(Delta_RDSON_5V_CH3CH4_UJJ3KD)

TID vs Result Stats

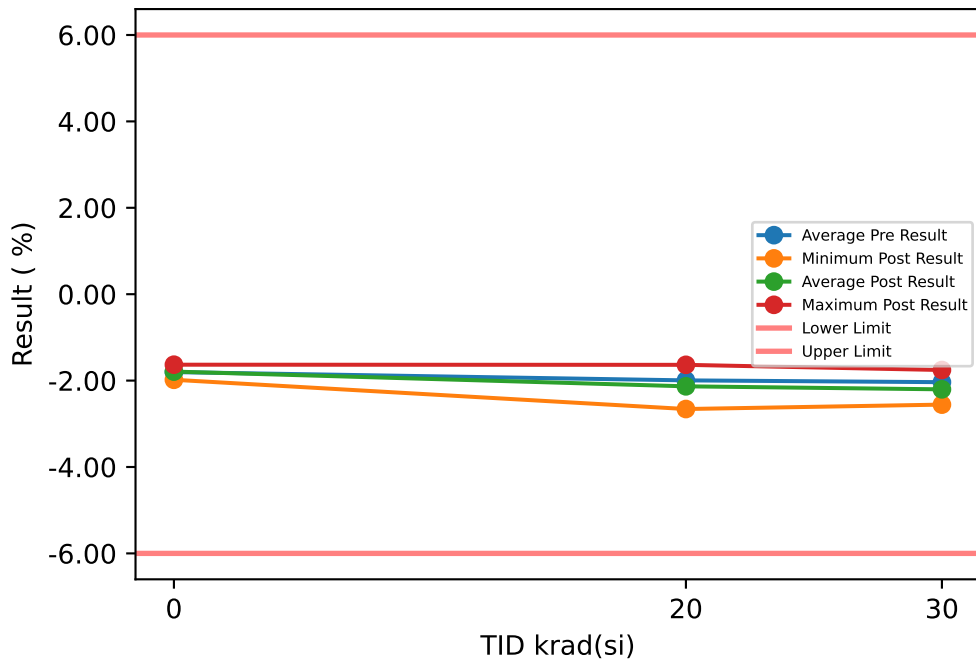

Test Results (Lower Limit = -6.0, Upper Limit = 6.0 (%))

Serial #	krad(si)	Exposure Conditions	Pre Result	Post Result	Delta
50	20	LDR biased	-2.261	-2.524	-0.263
51	20	LDR biased	-1.752	-1.979	-0.227
52	20	LDR biased	-1.607	-1.704	-0.097
53	20	LDR biased	-2.125	-2.38	-0.255
54	20	LDR biased	-2.331	-2.658	-0.327
55	30	LDR biased	-2.079	-2.409	-0.33
56	30	LDR biased	-2.175	-2.522	-0.347
57	30	LDR biased	-1.994	-2.228	-0.234
58	30	LDR biased	-2.024	-2.302	-0.278
59	30	LDR biased	-1.617	-1.951	-0.334
60	20	LDR unbiased	-1.987	-2.118	-0.131
61	20	LDR unbiased	-1.691	-1.635	0.056
62	20	LDR unbiased	-2.022	-2.065	-0.043
63	20	LDR unbiased	-1.678	-1.694	-0.016
64	20	LDR unbiased	-2.494	-2.569	-0.075
65	30	LDR unbiased	-2.595	-2.556	0.039
66	30	LDR unbiased	-1.944	-1.977	-0.033
67	30	LDR unbiased	-1.714	-1.755	-0.041
68	30	LDR unbiased	-2.14	-2.204	-0.064
69	30	LDR unbiased	-2.083	-2.118	-0.035
70	0	correlation	-1.626	-1.632	-0.006
71	0	correlation	-1.727	-1.735	-0.008
72	0	correlation	-1.676	-1.72	-0.044
73	0	correlation	-2.099	-1.981	0.118
74	0	correlation	-1.889	-1.888	0.001

TID vs Post - Pre Exposure Delta

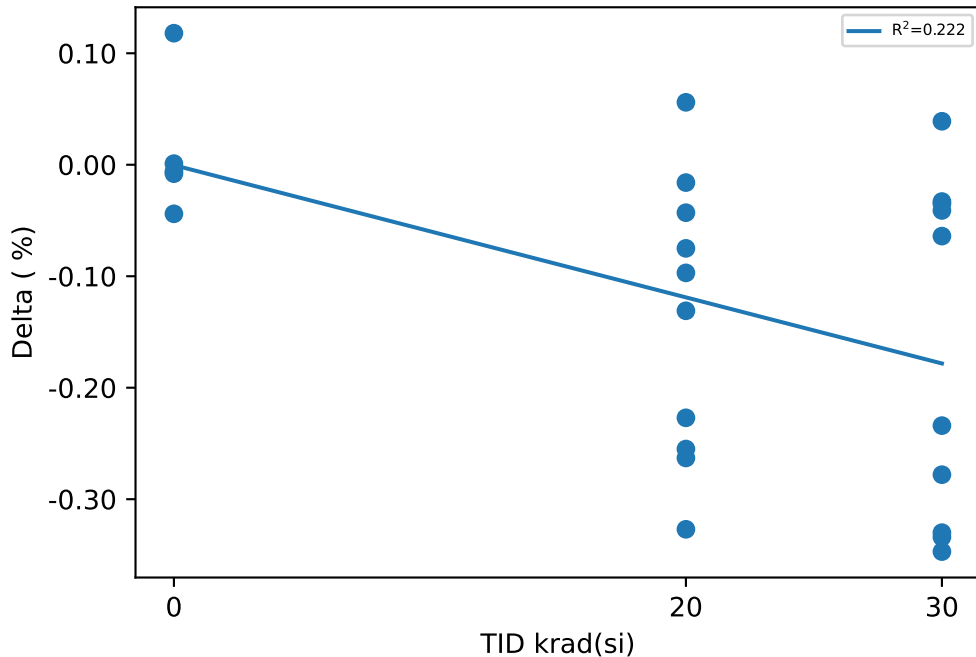

Test Statistics (%)

krad(si)	Pre Exposure Min	Pre Exposure Avg	Pre Exposure Max	Pre Exposure Std	Post Exposure Min	Post Exposure Avg	Post Exposure Max	Post Exposure Std	Min Delta	Avg Delta	Max Delta	Std Delta
0	-2.099	-1.8034	-1.626	0.19251	-1.981	-1.7912	-1.632	0.14051	-0.044	0.0122	0.118	0.061678
20	-2.494	-1.9948	-1.607	0.30783	-2.658	-2.1326	-1.635	0.38484	-0.327	-0.1378	0.056	0.12481
30	-2.595	-2.0365	-1.617	0.26589	-2.556	-2.2022	-1.755	0.25857	-0.347	-0.1657	0.039	0.15201

Device Test: 12.23 UJJ3KD(Delta_RDSON_12V_CH1CH2_UJJ3KD)

TID vs Result Stats

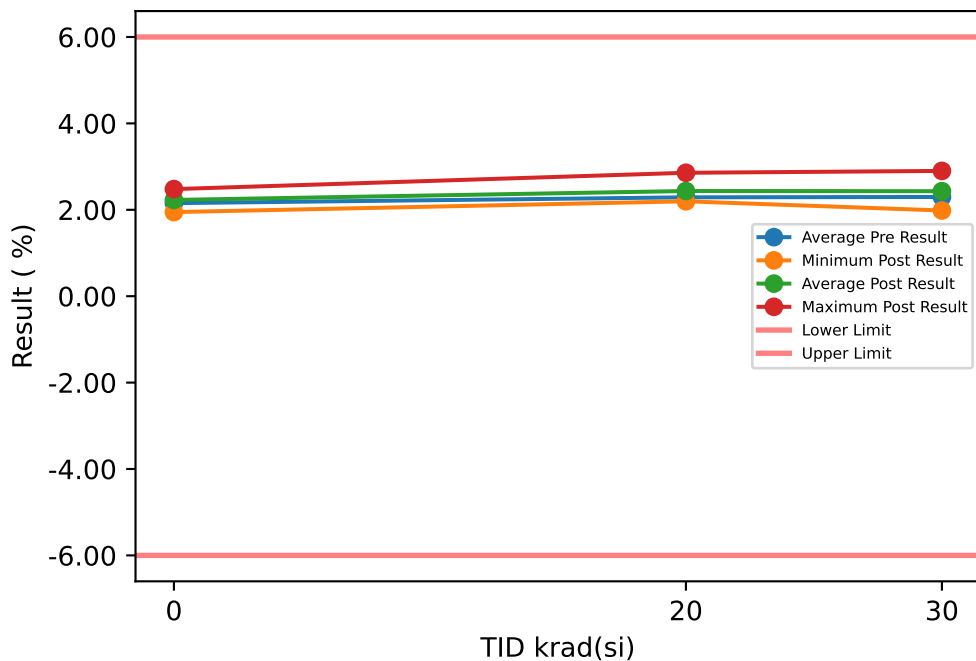

Test Results (Lower Limit = -6.0, Upper Limit = 6.0 (%))

Serial #	krad(si)	Exposure Conditions	Pre Result	Post Result	Delta
50	20	LDR biased	2.323	2.587	0.264
51	20	LDR biased	2.133	2.273	0.14
52	20	LDR biased	2.469	2.857	0.388
53	20	LDR biased	2.002	2.197	0.195
54	20	LDR biased	2.332	2.423	0.091
55	30	LDR biased	2.543	2.9	0.357
56	30	LDR biased	1.875	1.984	0.109
57	30	LDR biased	2.168	2.225	0.057
58	30	LDR biased	2.055	2.363	0.308
59	30	LDR biased	2.022	2.216	0.194
60	20	LDR unbiased	2.333	2.384	0.051
61	20	LDR unbiased	2.179	2.234	0.055
62	20	LDR unbiased	2.565	2.685	0.12
63	20	LDR unbiased	2.217	2.313	0.096
64	20	LDR unbiased	2.333	2.393	0.06
65	30	LDR unbiased	2.404	2.504	0.1
66	30	LDR unbiased	2.311	2.41	0.099
67	30	LDR unbiased	2.418	2.437	0.019
68	30	LDR unbiased	2.47	2.56	0.09
69	30	LDR unbiased	2.701	2.706	0.005
70	0	correlation	2.231	2.266	0.035
71	0	correlation	2.406	2.479	0.073
72	0	correlation	1.885	1.947	0.062
73	0	correlation	2.006	2.173	0.167
74	0	correlation	2.244	2.276	0.032

TID vs Post - Pre Exposure Delta

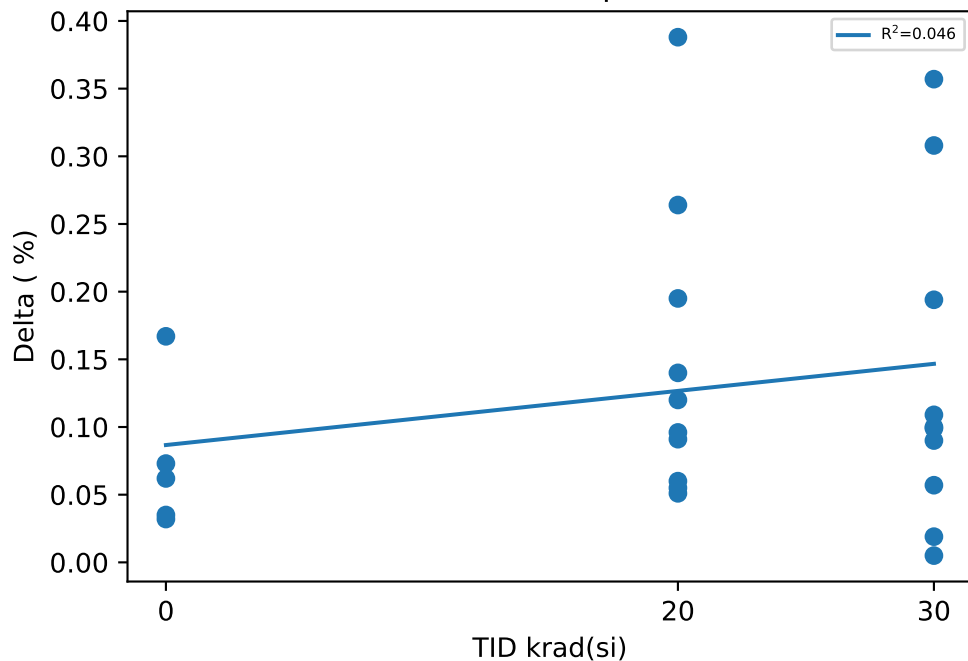

Test Statistics (%)

krad(si)	Pre Exposure Min	Pre Exposure Avg	Pre Exposure Max	Pre Exposure Std	Post Exposure Min	Post Exposure Avg	Post Exposure Max	Post Exposure Std	Min Delta	Avg Delta	Max Delta	Std Delta
0	1.885	2.1544	2.406	0.20724	1.947	2.2282	2.479	0.19283	0.032	0.0738	0.167	0.054952
20	2.002	2.2886	2.565	0.16311	2.197	2.4346	2.857	0.21249	0.051	0.146	0.388	0.10844
30	1.875	2.2967	2.701	0.2601	1.984	2.4305	2.9	0.26058	0.005	0.1338	0.357	0.11754

Device Test: 12.24 UJJ3KD(Delta_RDSON_12V_CH1CH3_UJJ3KD)

TID vs Result Stats

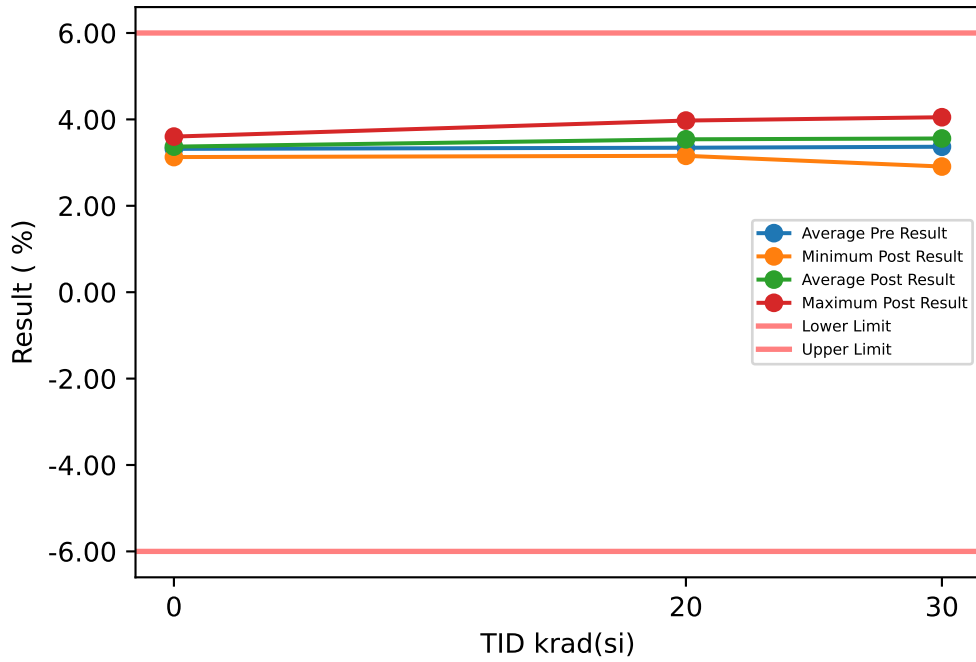

Test Results (Lower Limit = -6.0, Upper Limit = 6.0 (%))

Serial #	krad(si)	Exposure Conditions	Pre Result	Post Result	Delta
50	20	LDR biased	3.354	3.629	0.275
51	20	LDR biased	2.967	3.278	0.311
52	20	LDR biased	3.131	3.428	0.297
53	20	LDR biased	3.167	3.42	0.253
54	20	LDR biased	3.621	3.973	0.352
55	30	LDR biased	3.512	4.05	0.538
56	30	LDR biased	3.052	3.311	0.259
57	30	LDR biased	3.352	3.594	0.242
58	30	LDR biased	3.092	3.464	0.372
59	30	LDR biased	2.477	2.909	0.432
60	20	LDR unbiased	3.571	3.723	0.152
61	20	LDR unbiased	3.126	3.157	0.031
62	20	LDR unbiased	3.347	3.437	0.09
63	20	LDR unbiased	3.426	3.51	0.084
64	20	LDR unbiased	3.733	3.838	0.105
65	30	LDR unbiased	3.84	3.778	-0.062
66	30	LDR unbiased	3.069	3.241	0.172
67	30	LDR unbiased	3.436	3.435	-0.001
68	30	LDR unbiased	4.055	4.034	-0.021
69	30	LDR unbiased	3.786	3.769	-0.017
70	0	correlation	3.487	3.602	0.115
71	0	correlation	3.337	3.391	0.054
72	0	correlation	3.123	3.272	0.149
73	0	correlation	3.573	3.456	-0.117
74	0	correlation	3.069	3.128	0.059

TID vs Post - Pre Exposure Delta

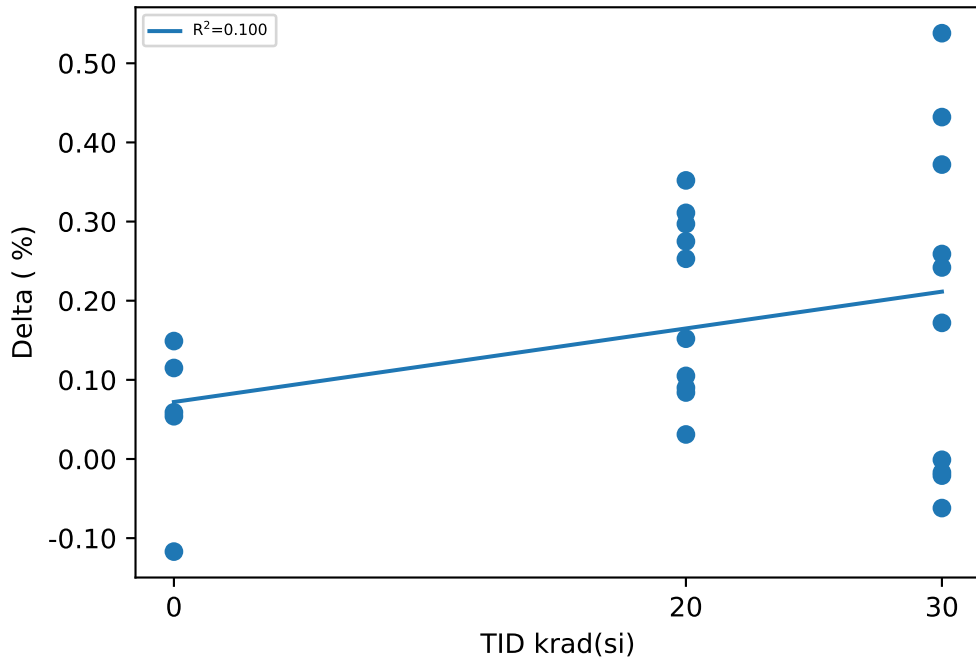

Test Statistics (%)

krad(si)	Pre Exposure Min	Pre Exposure Avg	Pre Exposure Max	Pre Exposure Std	Post Exposure Min	Post Exposure Avg	Post Exposure Max	Post Exposure Std	Min Delta	Avg Delta	Max Delta	Std Delta
0	3.069	3.3178	3.573	0.22021	3.128	3.3698	3.602	0.18016	-0.117	0.052	0.149	0.10246
20	2.967	3.3443	3.733	0.24783	3.157	3.5393	3.973	0.25199	0.031	0.195	0.352	0.11473
30	2.477	3.3671	4.055	0.466	2.909	3.5585	4.05	0.36048	-0.062	0.1914	0.538	0.21289

Device Test: 12.25 UJJ3KD(Delta_RDSON_12V_CH1CH4_UJJ3KD)

TID vs Result Stats

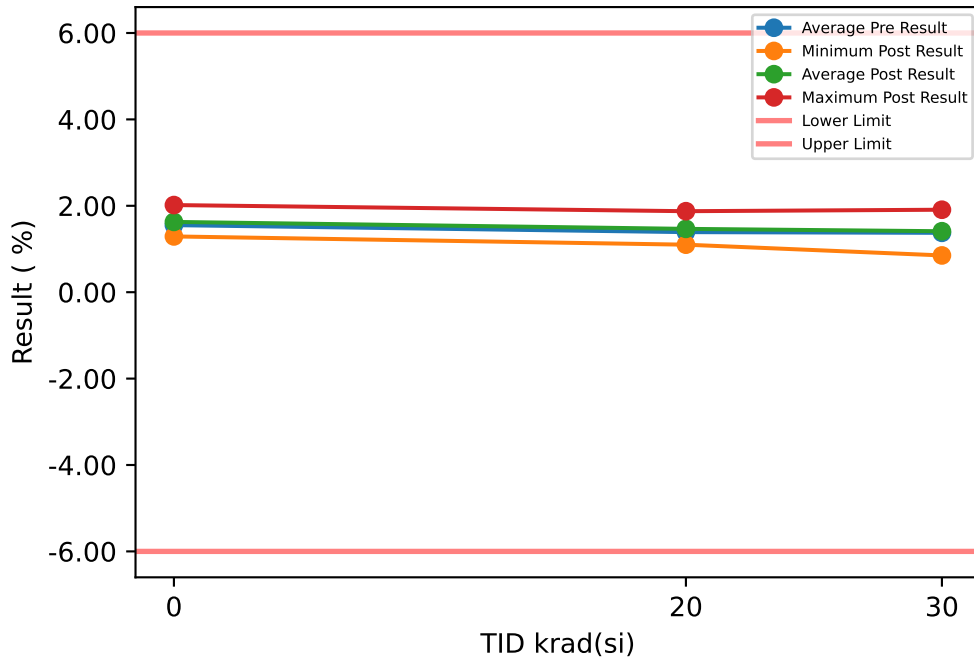

Test Results (Lower Limit = -6.0, Upper Limit = 6.0 (%))

Serial #	krad(si)	Exposure Conditions	Pre Result	Post Result	Delta
50	20	LDR biased	1.158	1.174	0.016
51	20	LDR biased	1.239	1.335	0.096
52	20	LDR biased	1.534	1.771	0.237
53	20	LDR biased	1.077	1.1	0.023
54	20	LDR biased	1.346	1.414	0.068
55	30	LDR biased	1.49	1.683	0.193
56	30	LDR biased	0.876	0.851	-0.025
57	30	LDR biased	1.41	1.419	0.009
58	30	LDR biased	1.109	1.24	0.131
59	30	LDR biased	0.879	0.989	0.11
60	20	LDR unbiased	1.621	1.663	0.042
61	20	LDR unbiased	1.472	1.538	0.066
62	20	LDR unbiased	1.375	1.431	0.056
63	20	LDR unbiased	1.776	1.875	0.099
64	20	LDR unbiased	1.307	1.361	0.054
65	30	LDR unbiased	1.325	1.299	-0.026
66	30	LDR unbiased	1.154	1.295	0.141
67	30	LDR unbiased	1.755	1.719	-0.036
68	30	LDR unbiased	1.995	1.909	-0.086
69	30	LDR unbiased	1.749	1.71	-0.039
70	0	correlation	1.91	2.017	0.107
71	0	correlation	1.655	1.7	0.045
72	0	correlation	1.467	1.591	0.124
73	0	correlation	1.53	1.536	0.006
74	0	correlation	1.199	1.291	0.092

TID vs Post - Pre Exposure Delta

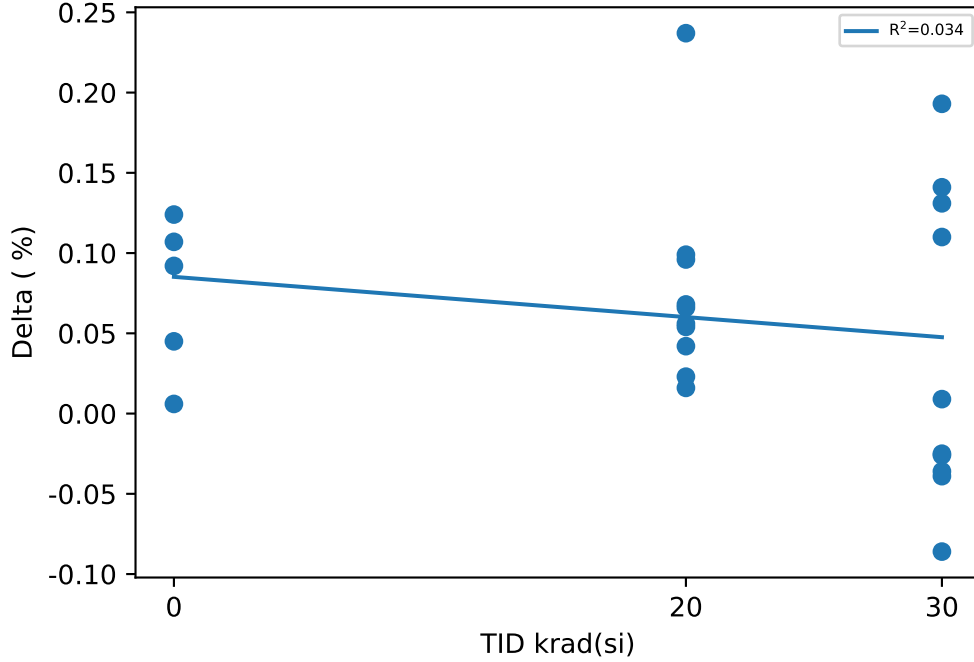

Test Statistics (%)

krad(si)	Pre Exposure Min	Pre Exposure Avg	Pre Exposure Max	Pre Exposure Std	Post Exposure Min	Post Exposure Avg	Post Exposure Max	Post Exposure Std	Min Delta	Avg Delta	Max Delta	Std Delta
0	1.199	1.5522	1.91	0.26033	1.291	1.627	2.017	0.26453	0.006	0.0748	0.124	0.048412
20	1.077	1.3905	1.776	0.21434	1.1	1.4662	1.875	0.24847	0.016	0.0757	0.237	0.062771
30	0.876	1.3742	1.995	0.38009	0.851	1.4114	1.909	0.34209	-0.086	0.0372	0.193	0.096694

Device Test: 12.26 UJJ3KD(Delta_RDSON_12V_CH2CH3_UJJ3KD)

TID vs Result Stats

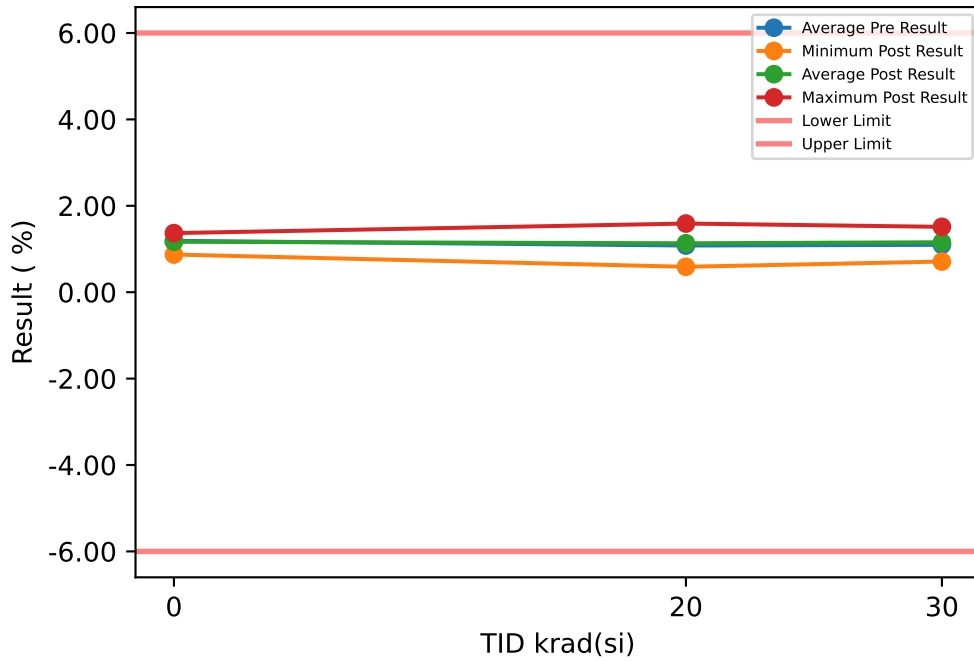

Test Results (Lower Limit = -6.0, Upper Limit = 6.0 (%))

Serial #	krad(si)	Exposure Conditions	Pre Result	Post Result	Delta
50	20	LDR biased	1.056	1.07	0.014
51	20	LDR biased	0.852	1.028	0.176
52	20	LDR biased	0.678	0.588	-0.09
53	20	LDR biased	1.189	1.251	0.062
54	20	LDR biased	1.32	1.589	0.269
55	30	LDR biased	0.994	1.184	0.19
56	30	LDR biased	1.2	1.354	0.154
57	30	LDR biased	1.211	1.4	0.189
58	30	LDR biased	1.059	1.128	0.069
59	30	LDR biased	0.465	0.709	0.244
60	20	LDR unbiased	1.267	1.372	0.105
61	20	LDR unbiased	0.968	0.945	-0.023
62	20	LDR unbiased	0.802	0.773	-0.029
63	20	LDR unbiased	1.236	1.225	-0.011
64	20	LDR unbiased	1.434	1.48	0.046
65	30	LDR unbiased	1.471	1.306	-0.165
66	30	LDR unbiased	0.776	0.851	0.075
67	30	LDR unbiased	1.043	1.023	-0.02
68	30	LDR unbiased	1.625	1.513	-0.112
69	30	LDR unbiased	1.115	1.093	-0.022
70	0	correlation	1.285	1.368	0.083
71	0	correlation	0.954	0.936	-0.018
72	0	correlation	1.262	1.352	0.09
73	0	correlation	1.599	1.311	-0.288
74	0	correlation	0.845	0.872	0.027

TID vs Post - Pre Exposure Delta

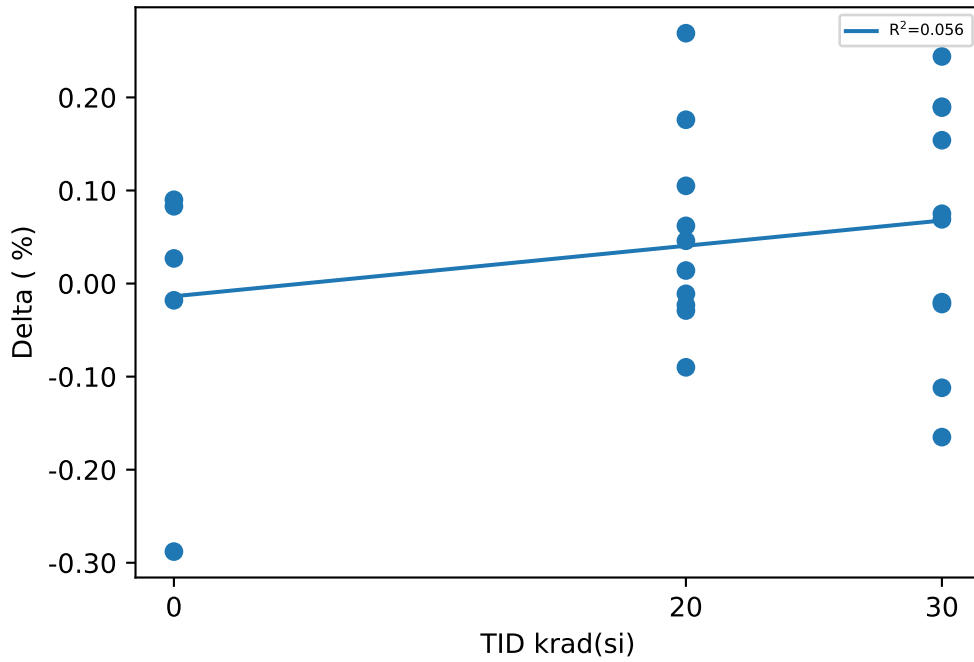

Test Statistics (%)

krad(si)	Pre Exposure Min	Pre Exposure Avg	Pre Exposure Max	Pre Exposure Std	Post Exposure Min	Post Exposure Avg	Post Exposure Max	Post Exposure Std	Min Delta	Avg Delta	Max Delta	Std Delta
0	0.845	1.189	1.599	0.29841	0.872	1.1678	1.368	0.24277	-0.288	-0.0212	0.09	0.15551
20	0.678	1.0802	1.434	0.24902	0.588	1.1321	1.589	0.31355	-0.09	0.0519	0.269	0.10707
30	0.465	1.0959	1.625	0.3266	0.709	1.1561	1.513	0.2505	-0.165	0.0602	0.244	0.13738

Device Test: 12.27 UJJ3KD(Delta_RDSON_12V_CH2CH4_UJJ3KD)

TID vs Result Stats

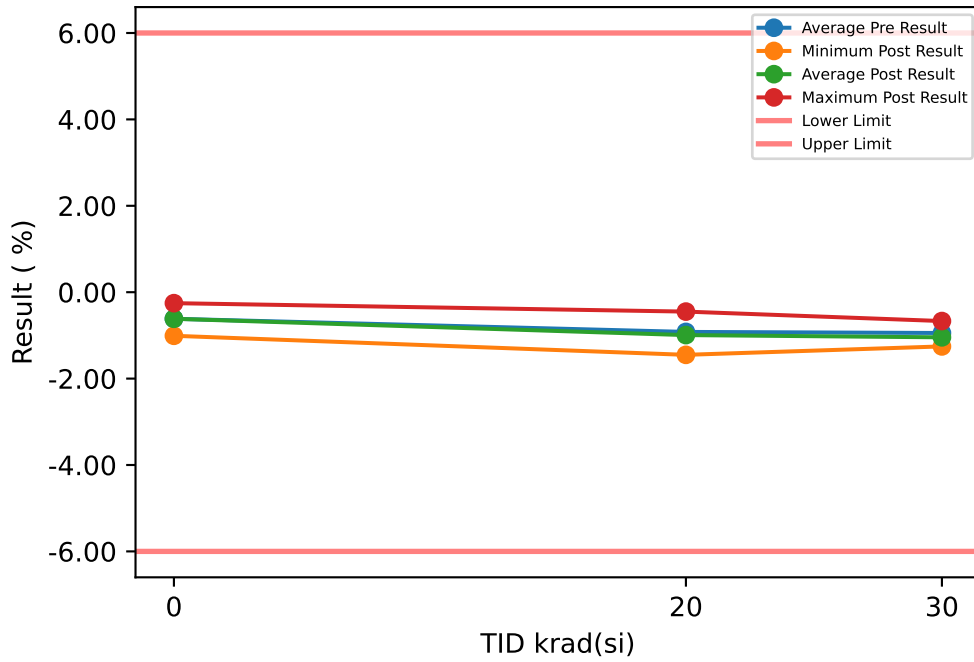

Test Results (Lower Limit = -6.0, Upper Limit = 6.0 (%))

Serial #	krad(si)	Exposure Conditions	Pre Result	Post Result	Delta
50	20	LDR biased	-1.193	-1.45	-0.257
51	20	LDR biased	-0.913	-0.96	-0.047
52	20	LDR biased	-0.959	-1.118	-0.159
53	20	LDR biased	-0.944	-1.122	-0.178
54	20	LDR biased	-1.009	-1.034	-0.025
55	30	LDR biased	-1.081	-1.253	-0.172
56	30	LDR biased	-1.018	-1.156	-0.138
57	30	LDR biased	-0.775	-0.825	-0.05
58	30	LDR biased	-0.966	-1.15	-0.184
59	30	LDR biased	-1.166	-1.255	-0.089
60	20	LDR unbiased	-0.729	-0.739	-0.01
61	20	LDR unbiased	-0.723	-0.711	0.012
62	20	LDR unbiased	-1.221	-1.289	-0.068
63	20	LDR unbiased	-0.451	-0.449	0.002
64	20	LDR unbiased	-1.05	-1.057	-0.007
65	30	LDR unbiased	-1.106	-1.236	-0.13
66	30	LDR unbiased	-1.185	-1.143	0.042
67	30	LDR unbiased	-0.679	-0.736	-0.057
68	30	LDR unbiased	-0.487	-0.668	-0.181
69	30	LDR unbiased	-0.978	-1.024	-0.046
70	0	correlation	-0.328	-0.254	0.074
71	0	correlation	-0.769	-0.799	-0.03
72	0	correlation	-0.426	-0.363	0.063
73	0	correlation	-0.486	-0.651	-0.165
74	0	correlation	-1.068	-1.009	0.059

TID vs Post - Pre Exposure Delta

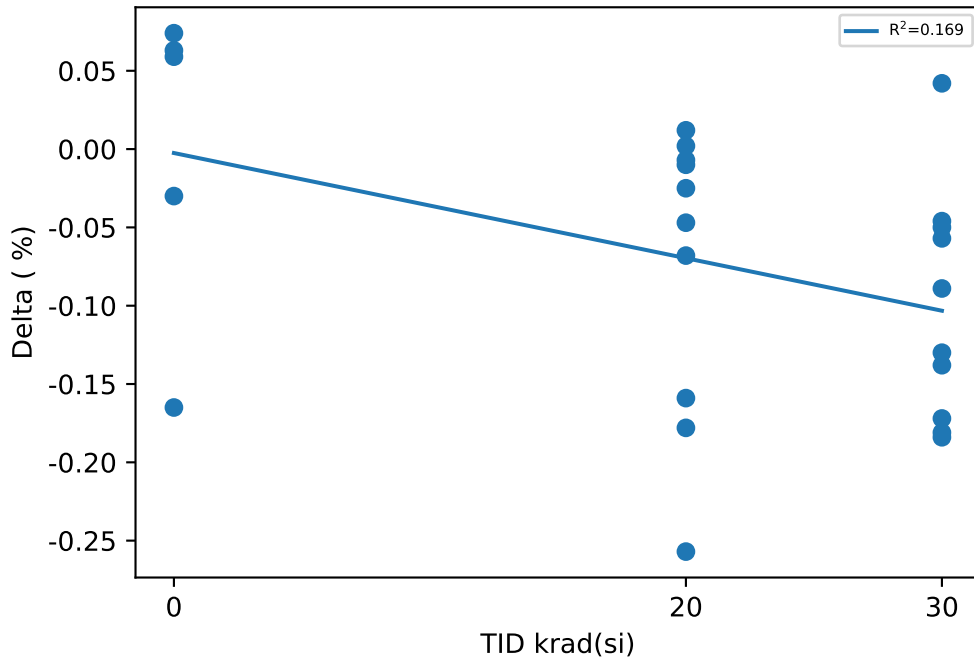

Test Statistics (%)

krad(si)	Pre Exposure Min	Pre Exposure Avg	Pre Exposure Max	Pre Exposure Std	Post Exposure Min	Post Exposure Avg	Post Exposure Max	Post Exposure Std	Min Delta	Avg Delta	Max Delta	Std Delta
0	-1.068	-0.6154	-0.328	0.30152	-1.009	-0.6152	-0.254	0.30992	-0.165	0.0002	0.074	0.1013
20	-1.221	-0.9192	-0.451	0.2327	-1.45	-0.9929	-0.449	0.29356	-0.257	-0.0737	0.012	0.092167
30	-1.185	-0.9441	-0.487	0.22782	-1.255	-1.0446	-0.668	0.22192	-0.184	-0.1005	0.042	0.073555

Device Test: 12.28 UJJ3KD(Delta_RDSON_12V_CH3CH4_UJJ3KD)

TID vs Result Stats

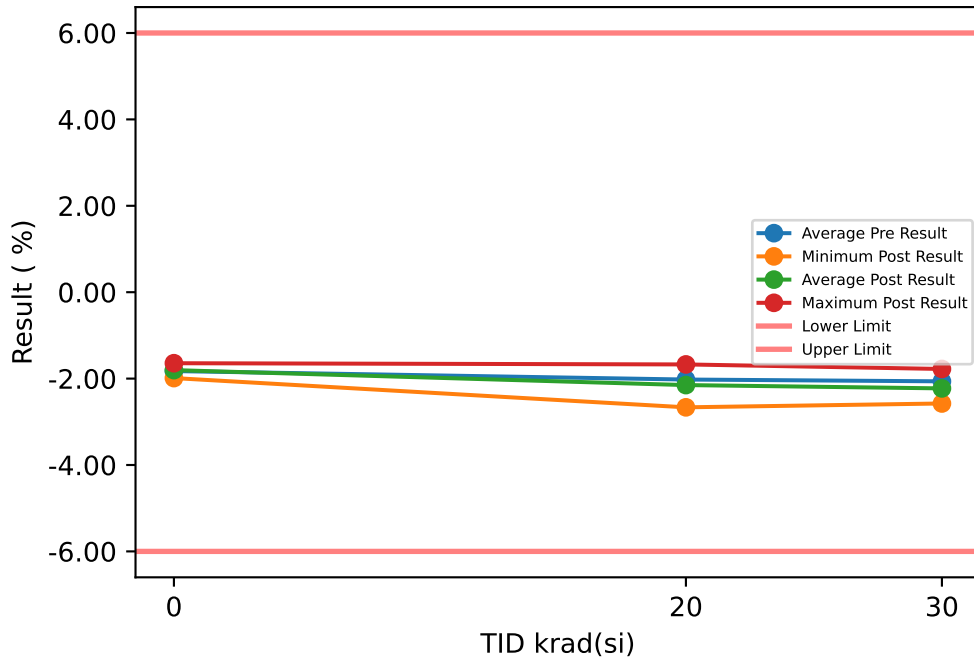

Test Results (Lower Limit = -6.0, Upper Limit = 6.0 (%))

Serial #	krad(si)	Exposure Conditions	Pre Result	Post Result	Delta
50	20	LDR biased	-2.272	-2.547	-0.275
51	20	LDR biased	-1.781	-2.009	-0.228
52	20	LDR biased	-1.649	-1.716	-0.067
53	20	LDR biased	-2.158	-2.403	-0.245
54	20	LDR biased	-2.36	-2.665	-0.305
55	30	LDR biased	-2.096	-2.466	-0.37
56	30	LDR biased	-2.245	-2.544	-0.299
57	30	LDR biased	-2.01	-2.256	-0.246
58	30	LDR biased	-2.047	-2.304	-0.257
59	30	LDR biased	-1.639	-1.977	-0.338
60	20	LDR unbiased	-2.022	-2.14	-0.118
61	20	LDR unbiased	-1.708	-1.672	0.036
62	20	LDR unbiased	-2.039	-2.078	-0.039
63	20	LDR unbiased	-1.708	-1.695	0.013
64	20	LDR unbiased	-2.52	-2.575	-0.055
65	30	LDR unbiased	-2.616	-2.576	0.04
66	30	LDR unbiased	-1.976	-2.012	-0.036
67	30	LDR unbiased	-1.74	-1.777	-0.037
68	30	LDR unbiased	-2.147	-2.214	-0.067
69	30	LDR unbiased	-2.117	-2.14	-0.023
70	0	correlation	-1.635	-1.644	-0.009
71	0	correlation	-1.739	-1.751	-0.012
72	0	correlation	-1.709	-1.738	-0.029
73	0	correlation	-2.118	-1.988	0.13
74	0	correlation	-1.929	-1.897	0.032

TID vs Post - Pre Exposure Delta

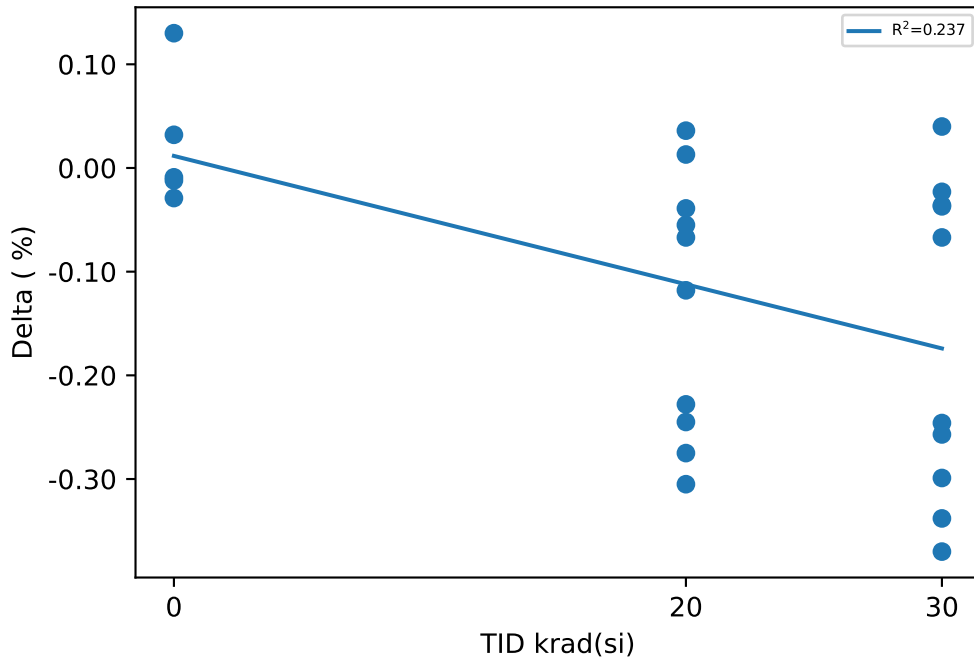

Test Statistics (%)

krad(si)	Pre Exposure Min	Pre Exposure Avg	Pre Exposure Max	Pre Exposure Std	Post Exposure Min	Post Exposure Avg	Post Exposure Max	Post Exposure Std	Min Delta	Avg Delta	Max Delta	Std Delta
0	-2.118	-1.826	-1.635	0.19597	-1.988	-1.8036	-1.644	0.13718	-0.029	0.0224	0.13	0.06419
20	-2.52	-2.0217	-1.649	0.30513	-2.665	-2.15	-1.672	0.38246	-0.305	-0.1283	0.036	0.12493
30	-2.616	-2.0633	-1.639	0.26765	-2.576	-2.2266	-1.777	0.2593	-0.37	-0.1633	0.04	0.15265

Device Test: 12.29 UJJ3KD(Delta_RDSON_28V_CH1CH2_UJJ3KD)

TID vs Result Stats

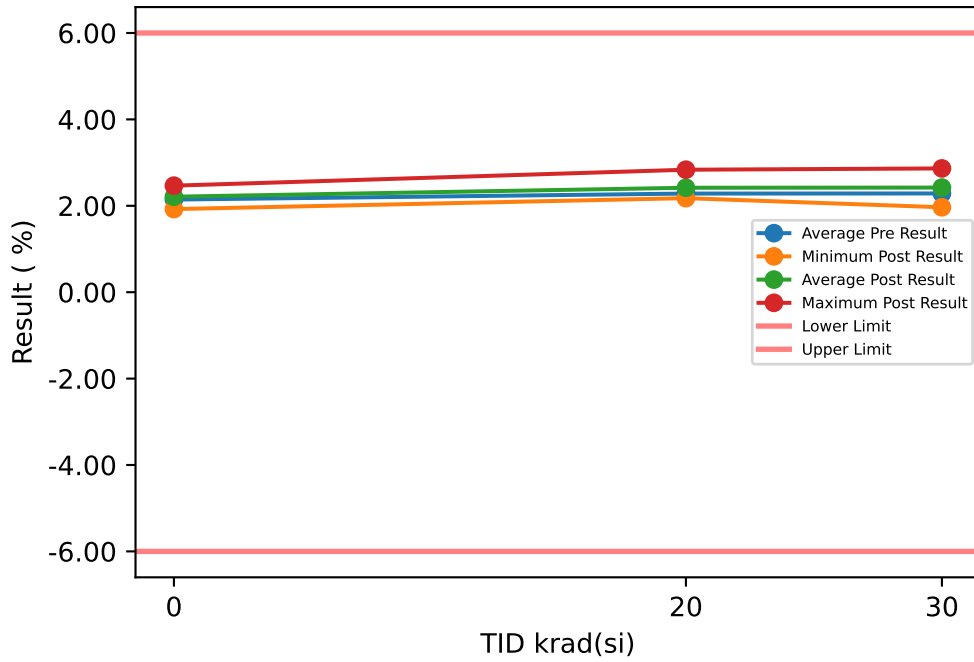

Test Results (Lower Limit = -6.0, Upper Limit = 6.0 (%))

Serial #	krad(si)	Exposure Conditions	Pre Result	Post Result	Delta
50	20	LDR biased	2.338	2.566	0.228
51	20	LDR biased	2.122	2.254	0.132
52	20	LDR biased	2.472	2.835	0.363
53	20	LDR biased	1.994	2.177	0.183
54	20	LDR biased	2.323	2.42	0.097
55	30	LDR biased	2.532	2.865	0.333
56	30	LDR biased	1.877	1.966	0.089
57	30	LDR biased	2.151	2.227	0.076
58	30	LDR biased	2.053	2.348	0.295
59	30	LDR biased	2.013	2.209	0.196
60	20	LDR unbiased	2.335	2.373	0.038
61	20	LDR unbiased	2.167	2.202	0.035
62	20	LDR unbiased	2.557	2.677	0.12
63	20	LDR unbiased	2.197	2.292	0.095
64	20	LDR unbiased	2.325	2.38	0.055
65	30	LDR unbiased	2.39	2.509	0.119
66	30	LDR unbiased	2.295	2.409	0.114
67	30	LDR unbiased	2.382	2.431	0.049
68	30	LDR unbiased	2.484	2.558	0.074
69	30	LDR unbiased	2.68	2.696	0.016
70	0	correlation	2.225	2.235	0.01
71	0	correlation	2.391	2.466	0.075
72	0	correlation	1.889	1.924	0.035
73	0	correlation	1.988	2.163	0.175
74	0	correlation	2.228	2.265	0.037

TID vs Post - Pre Exposure Delta

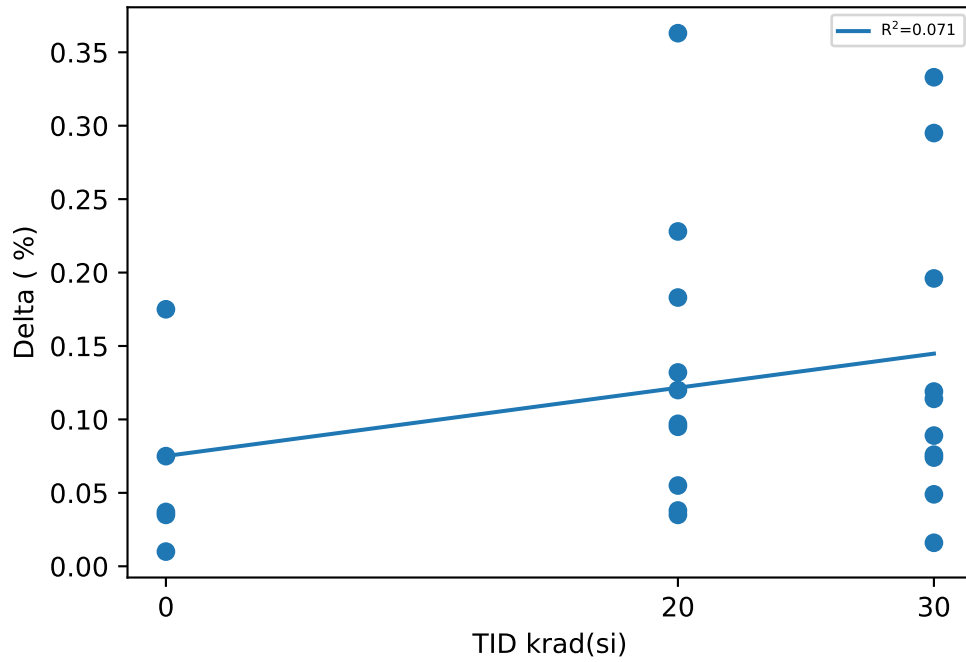

Test Statistics (%)

krad(si)	Pre Exposure Min	Pre Exposure Avg	Pre Exposure Max	Pre Exposure Std	Post Exposure Min	Post Exposure Avg	Post Exposure Max	Post Exposure Std	Min Delta	Avg Delta	Max Delta	Std Delta
0	1.889	2.1442	2.391	0.20248	1.924	2.2106	2.466	0.1957	0.01	0.0664	0.175	0.064998
20	1.994	2.283	2.557	0.16673	2.177	2.4176	2.835	0.21444	0.035	0.1346	0.363	0.10112
30	1.877	2.2857	2.68	0.25591	1.966	2.4218	2.865	0.257	0.016	0.1361	0.333	0.10545

Device Test: 12.3 UJ4ZR4(RDSON_28V_OUT1_UJE410_UJ4ZR4)

TID vs Result Stats

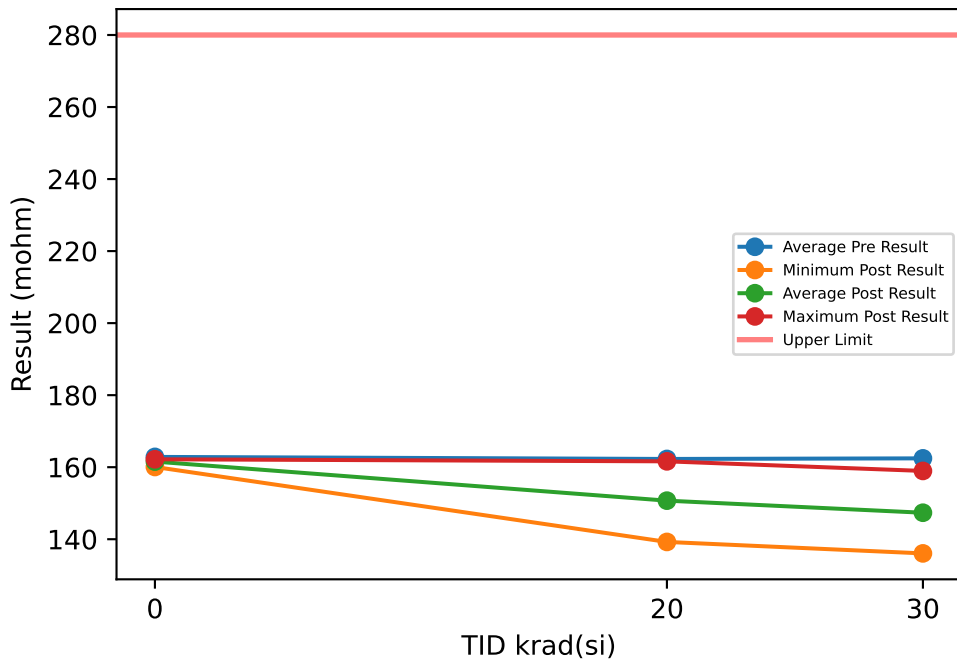

Test Results (Upper Limit = 280.0 (mohm))

Serial #	krad(si)	Exposure Conditions	Pre Result	Post Result	Delta
50	20	LDR biased	159.9	139.25	-20.652
51	20	LDR biased	162.74	141.43	-21.305
52	20	LDR biased	162.28	141.34	-20.941
53	20	LDR biased	161.96	140.89	-21.067
54	20	LDR biased	161.46	140.77	-20.691
55	30	LDR biased	162.93	136.42	-26.51
56	30	LDR biased	162.25	136.06	-26.186
57	30	LDR biased	161.57	136.13	-25.433
58	30	LDR biased	162.28	136.6	-25.682
59	30	LDR biased	164.02	137.66	-26.356
60	20	LDR unbiased	162.88	160.34	-2.5413
61	20	LDR unbiased	162.38	159.96	-2.4154
62	20	LDR unbiased	163.27	161.62	-1.6451
63	20	LDR unbiased	163.06	160.48	-2.5789
64	20	LDR unbiased	162.94	160.98	-1.9636
65	30	LDR unbiased	160.97	156.87	-4.0997
66	30	LDR unbiased	162.82	158.96	-3.8641
67	30	LDR unbiased	163.89	158.94	-4.9488
68	30	LDR unbiased	161.72	157.82	-3.9063
69	30	LDR unbiased	162.05	158.08	-3.9712
70	0	correlation	161.46	160.06	-1.4056
71	0	correlation	163.91	162.04	-1.8678
72	0	correlation	163.26	161.96	-1.3055
73	0	correlation	163.42	162.19	-1.2254
74	0	correlation	162.24	161.51	-0.7249

TID vs Post - Pre Exposure Delta

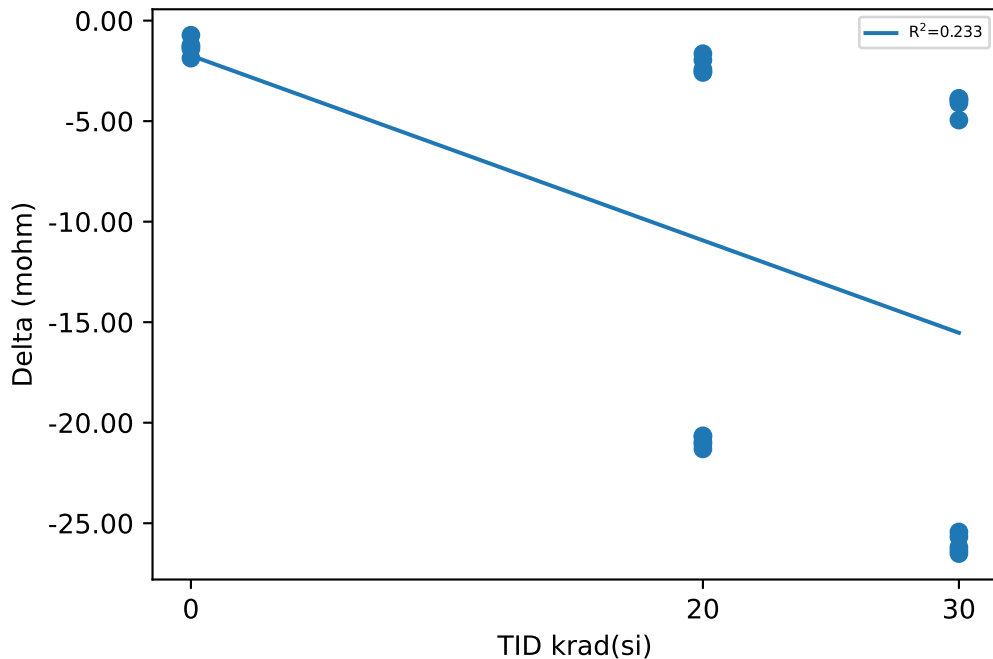

Test Statistics (mohm)

krad(si)	Pre Exposure Min	Pre Exposure Avg	Pre Exposure Max	Pre Exposure Std	Post Exposure Min	Post Exposure Avg	Post Exposure Max	Post Exposure Std	Min Delta	Avg Delta	Max Delta	Std Delta
0	161.46	162.86	163.91	0.98915	160.06	161.55	162.19	0.87374	-1.8678	-1.3058	-0.7249	0.40918
20	159.9	162.29	163.27	1.0027	139.25	150.71	161.62	10.535	-21.305	-11.58	-1.6451	9.8624
30	160.97	162.45	164.02	0.97776	136.06	147.35	158.96	11.385	-26.51	-15.096	-3.8641	11.537

Device Test: 12.30 UJJ3KD(Delta_RDSON_28V_CH1CH3_UJJ3KD)

TID vs Result Stats

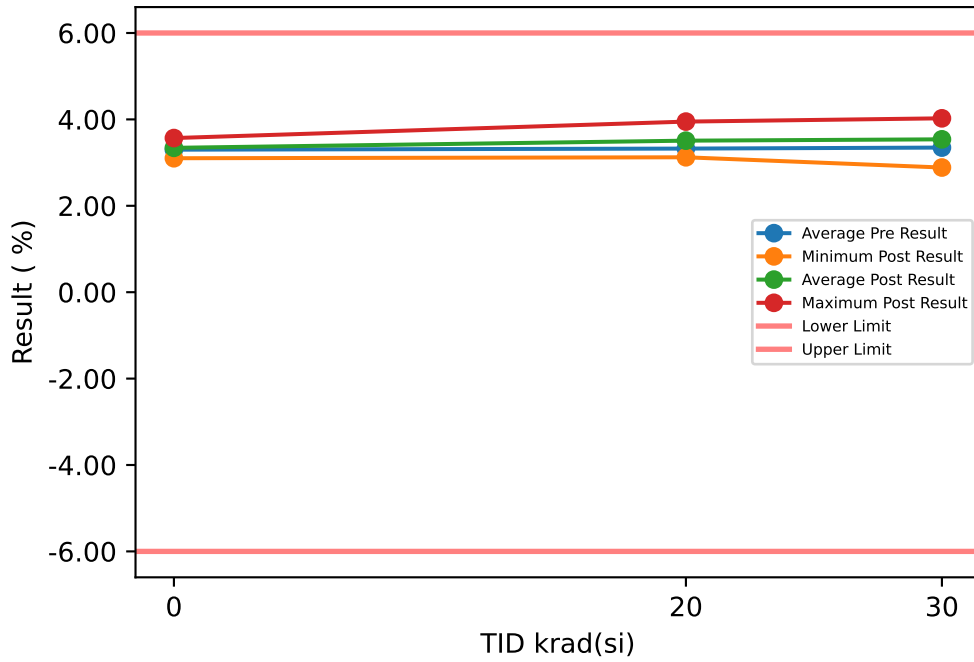

Test Results (Lower Limit = -6.0, Upper Limit = 6.0 (%))

Serial #	krad(si)	Exposure Conditions	Pre Result	Post Result	Delta
50	20	LDR biased	3.356	3.593	0.237
51	20	LDR biased	2.934	3.249	0.315
52	20	LDR biased	3.11	3.391	0.281
53	20	LDR biased	3.144	3.384	0.24
54	20	LDR biased	3.605	3.949	0.344
55	30	LDR biased	3.496	4.025	0.529
56	30	LDR biased	3.029	3.289	0.26
57	30	LDR biased	3.331	3.587	0.256
58	30	LDR biased	3.066	3.439	0.373
59	30	LDR biased	2.458	2.886	0.428
60	20	LDR unbiased	3.554	3.691	0.137
61	20	LDR unbiased	3.112	3.123	0.011
62	20	LDR unbiased	3.332	3.41	0.078
63	20	LDR unbiased	3.396	3.472	0.076
64	20	LDR unbiased	3.701	3.815	0.114
65	30	LDR unbiased	3.819	3.779	-0.04
66	30	LDR unbiased	3.044	3.219	0.175
67	30	LDR unbiased	3.41	3.408	-0.002
68	30	LDR unbiased	4.059	4.005	-0.054
69	30	LDR unbiased	3.764	3.749	-0.015
70	0	correlation	3.476	3.568	0.092
71	0	correlation	3.298	3.367	0.069
72	0	correlation	3.112	3.242	0.13
73	0	correlation	3.552	3.432	-0.12
74	0	correlation	3.057	3.101	0.044

TID vs Post - Pre Exposure Delta

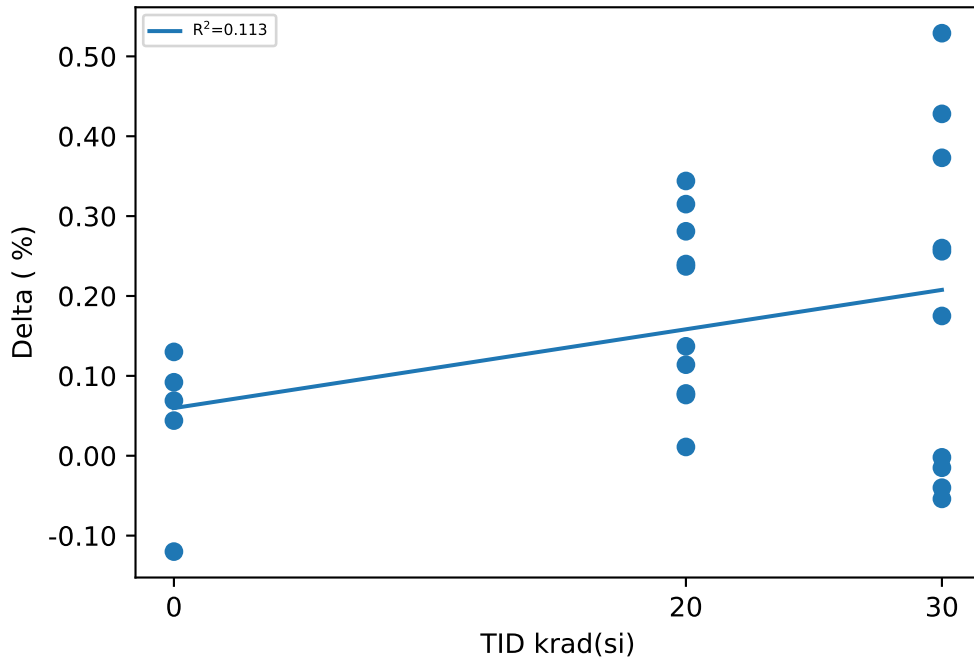

Test Statistics (%)

krad(si)	Pre Exposure Min	Pre Exposure Avg	Pre Exposure Max	Pre Exposure Std	Post Exposure Min	Post Exposure Avg	Post Exposure Max	Post Exposure Std	Min Delta	Avg Delta	Max Delta	Std Delta
0	3.057	3.299	3.552	0.2173	3.101	3.342	3.568	0.1788	-0.12	0.043	0.13	0.096457
20	2.934	3.3244	3.701	0.24844	3.123	3.5077	3.949	0.25489	0.011	0.1833	0.344	0.11453
30	2.458	3.3476	4.059	0.47049	2.886	3.5386	4.025	0.36145	-0.054	0.191	0.529	0.21235

Device Test: 12.31 UJJ3KD(Delta_RDSON_28V_CH1CH4_UJJ3KD)

TID vs Result Stats

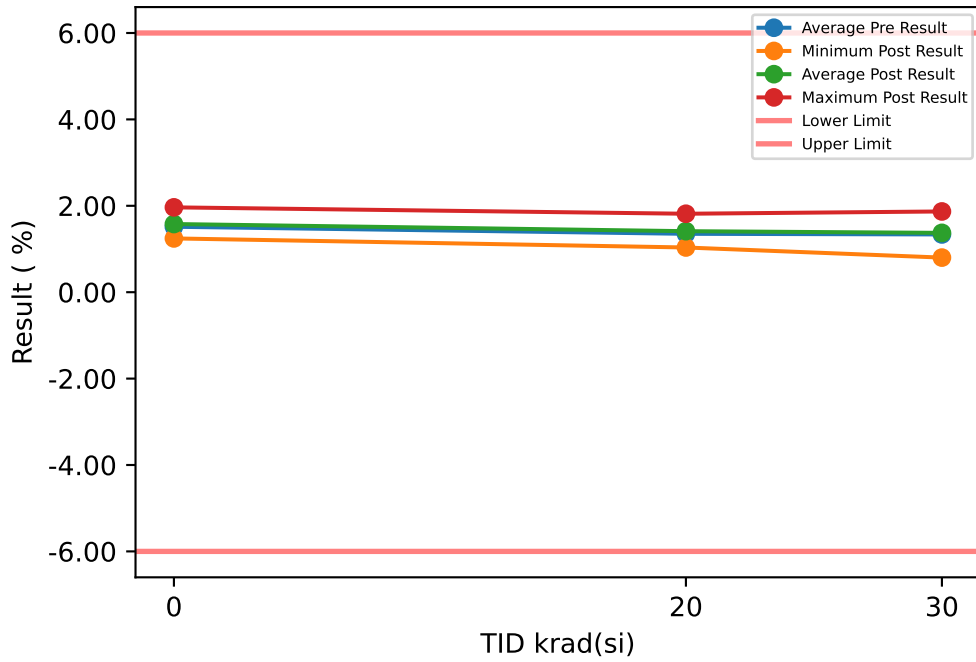

Test Results (Lower Limit = -6.0, Upper Limit = 6.0 (%))

Serial #	krad(si)	Exposure Conditions	Pre Result	Post Result	Delta
50	20	LDR biased	1.122	1.111	-0.011
51	20	LDR biased	1.193	1.285	0.092
52	20	LDR biased	1.504	1.711	0.207
53	20	LDR biased	1.042	1.035	-0.007
54	20	LDR biased	1.304	1.372	0.068
55	30	LDR biased	1.454	1.643	0.189
56	30	LDR biased	0.839	0.801	-0.038
57	30	LDR biased	1.37	1.388	0.018
58	30	LDR biased	1.071	1.197	0.126
59	30	LDR biased	0.831	0.954	0.123
60	20	LDR unbiased	1.592	1.609	0.017
61	20	LDR unbiased	1.435	1.495	0.06
62	20	LDR unbiased	1.337	1.388	0.051
63	20	LDR unbiased	1.73	1.816	0.086
64	20	LDR unbiased	1.254	1.303	0.049
65	30	LDR unbiased	1.295	1.274	-0.021
66	30	LDR unbiased	1.106	1.263	0.157
67	30	LDR unbiased	1.707	1.66	-0.047
68	30	LDR unbiased	1.98	1.869	-0.111
69	30	LDR unbiased	1.717	1.684	-0.033
70	0	correlation	1.881	1.964	0.083
71	0	correlation	1.587	1.659	0.072
72	0	correlation	1.447	1.536	0.089
73	0	correlation	1.491	1.486	-0.005
74	0	correlation	1.167	1.245	0.078

TID vs Post - Pre Exposure Delta

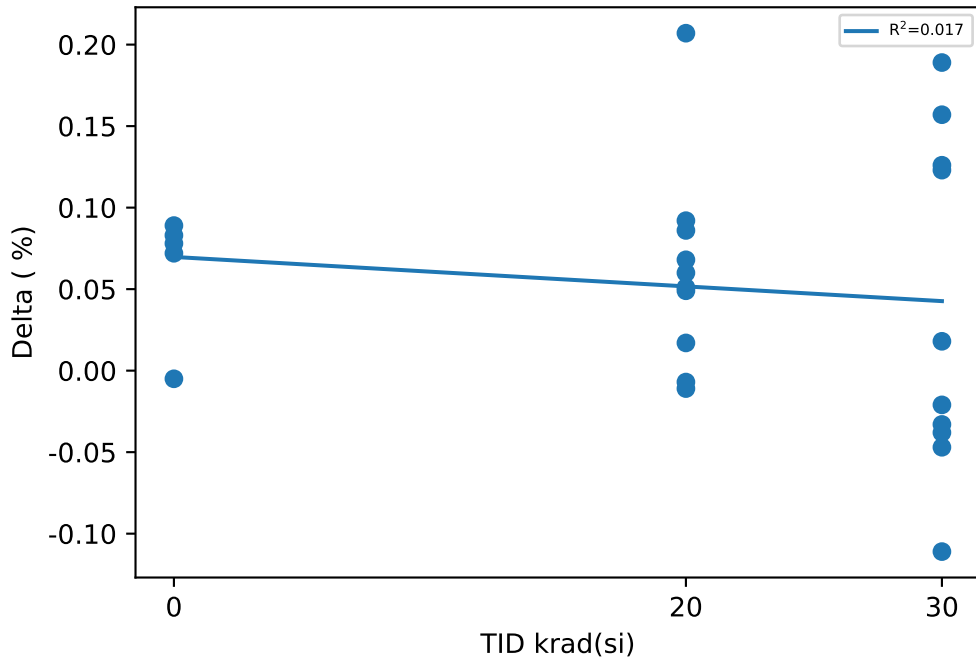

Test Statistics (%)

krad(si)	Pre Exposure Min	Pre Exposure Avg	Pre Exposure Max	Pre Exposure Std	Post Exposure Min	Post Exposure Avg	Post Exposure Max	Post Exposure Std	Min Delta	Avg Delta	Max Delta	Std Delta
0	1.167	1.5146	1.881	0.25761	1.245	1.578	1.964	0.263	-0.005	0.0634	0.089	0.038747
20	1.042	1.3513	1.73	0.21522	1.035	1.4125	1.816	0.24972	-0.011	0.0612	0.207	0.062307
30	0.831	1.337	1.98	0.38578	0.801	1.3733	1.869	0.34219	-0.111	0.0363	0.189	0.10329

Device Test: 12.32 UJJ3KD(Delta_RDSON_28V_CH2CH3_UJJ3KD)

TID vs Result Stats

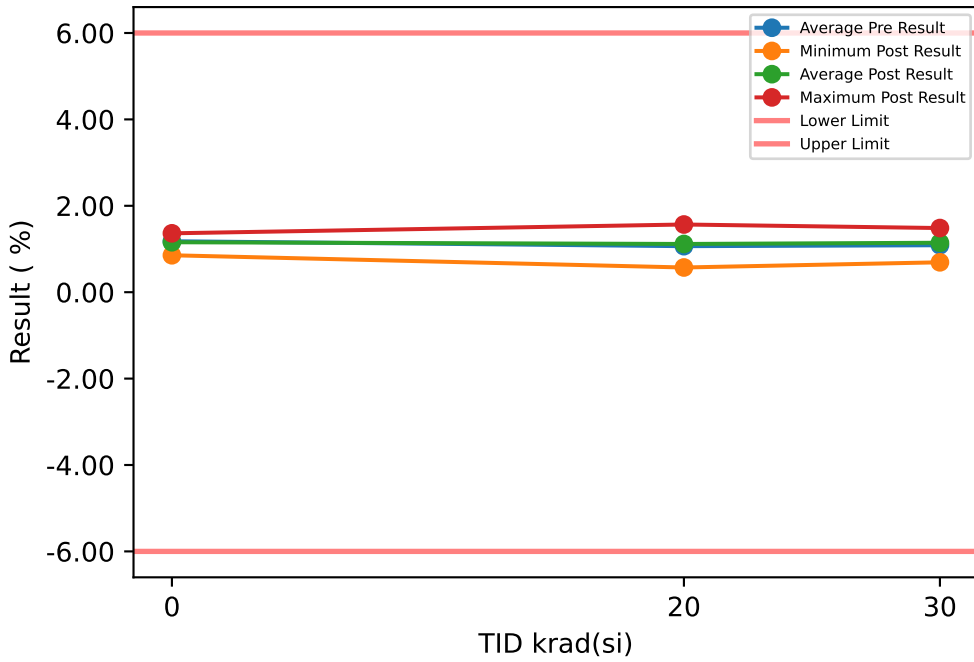

TID vs Post - Pre Exposure Delta

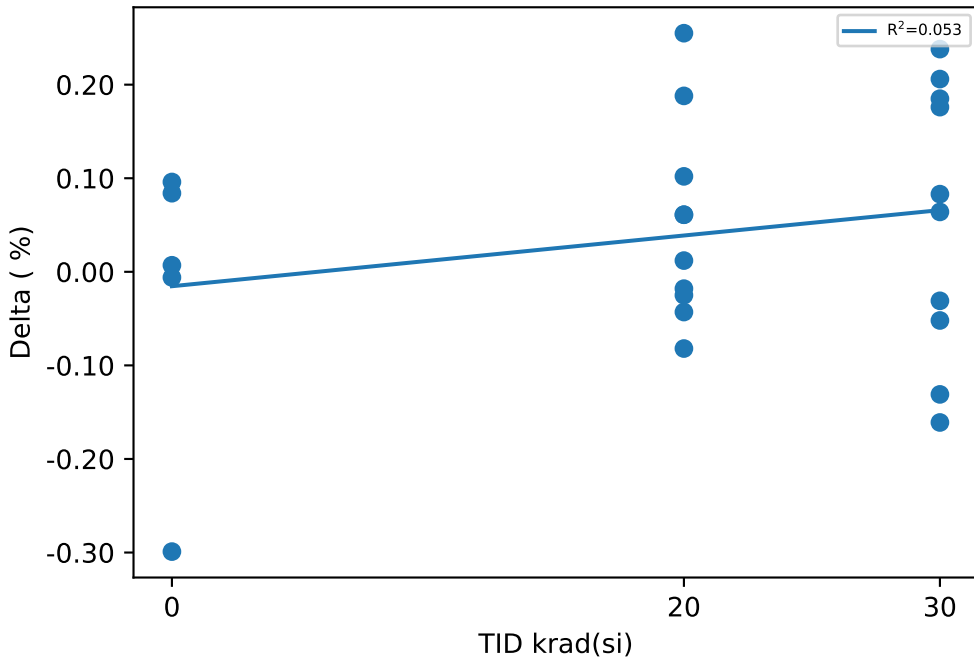

Test Results (Lower Limit = -6.0, Upper Limit = 6.0 (%))

Serial #	krad(si)	Exposure Conditions	Pre Result	Post Result	Delta
50	20	LDR biased	1.042	1.054	0.012
51	20	LDR biased	0.829	1.017	0.188
52	20	LDR biased	0.654	0.572	-0.082
53	20	LDR biased	1.173	1.234	0.061
54	20	LDR biased	1.312	1.567	0.255
55	30	LDR biased	0.989	1.195	0.206
56	30	LDR biased	1.174	1.35	0.176
57	30	LDR biased	1.206	1.391	0.185
58	30	LDR biased	1.034	1.117	0.083
59	30	LDR biased	0.454	0.692	0.238
60	20	LDR unbiased	1.248	1.35	0.102
61	20	LDR unbiased	0.966	0.941	-0.025
62	20	LDR unbiased	0.796	0.753	-0.043
63	20	LDR unbiased	1.226	1.208	-0.018
64	20	LDR unbiased	1.409	1.47	0.061
65	30	LDR unbiased	1.464	1.303	-0.161
66	30	LDR unbiased	0.766	0.83	0.064
67	30	LDR unbiased	1.053	1.001	-0.052
68	30	LDR unbiased	1.616	1.485	-0.131
69	30	LDR unbiased	1.114	1.083	-0.031
70	0	correlation	1.279	1.363	0.084
71	0	correlation	0.929	0.923	-0.006
72	0	correlation	1.247	1.343	0.096
73	0	correlation	1.596	1.297	-0.299
74	0	correlation	0.848	0.855	0.007

Test Statistics (%)

krad(si)	Pre Exposure Min	Pre Exposure Avg	Pre Exposure Max	Pre Exposure Std	Post Exposure Min	Post Exposure Avg	Post Exposure Max	Post Exposure Std	Min Delta	Avg Delta	Max Delta	Std Delta
0	0.848	1.1798	1.596	0.30024	0.855	1.1562	1.363	0.24627	-0.299	-0.0236	0.096	0.16045
20	0.654	1.0655	1.409	0.24894	0.572	1.1166	1.567	0.31231	-0.082	0.0511	0.255	0.10634
30	0.454	1.087	1.616	0.32689	0.692	1.1447	1.485	0.25285	-0.161	0.0577	0.238	0.14481

Device Test: 12.33 UJJ3KD(Delta_RDSON_28V_CH2CH4_UJJ3KD)

TID vs Result Stats

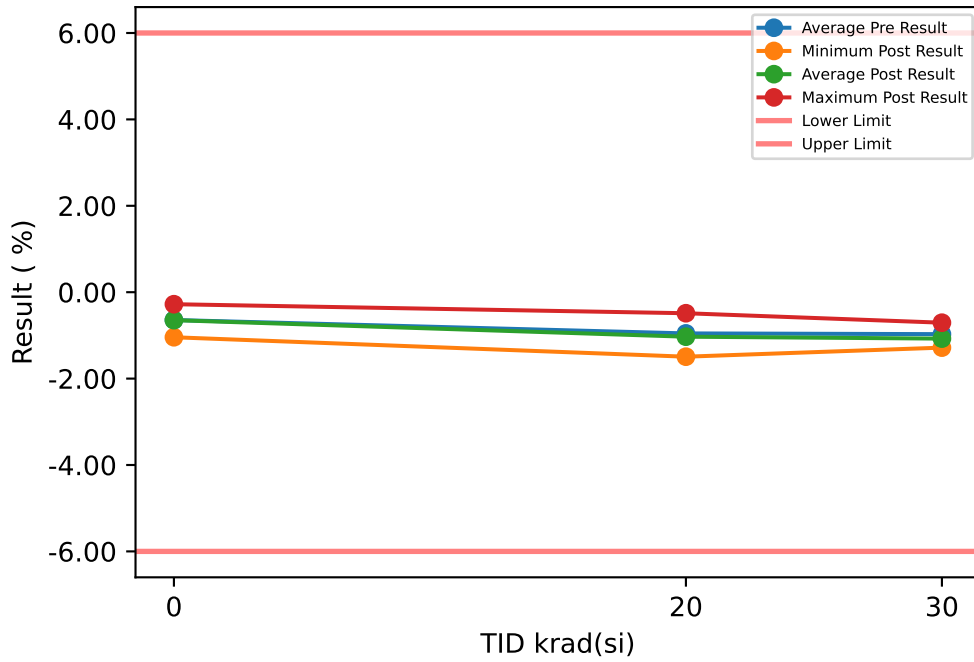

Test Results (Lower Limit = -6.0, Upper Limit = 6.0 (%))

Serial #	krad(si)	Exposure Conditions	Pre Result	Post Result	Delta
50	20	LDR biased	-1.246	-1.493	-0.247
51	20	LDR biased	-0.949	-0.991	-0.042
52	20	LDR biased	-0.992	-1.157	-0.165
53	20	LDR biased	-0.972	-1.167	-0.195
54	20	LDR biased	-1.043	-1.075	-0.032
55	30	LDR biased	-1.106	-1.258	-0.152
56	30	LDR biased	-1.058	-1.188	-0.13
57	30	LDR biased	-0.798	-0.858	-0.06
58	30	LDR biased	-1.003	-1.179	-0.176
59	30	LDR biased	-1.207	-1.283	-0.076
60	20	LDR unbiased	-0.761	-0.782	-0.021
61	20	LDR unbiased	-0.748	-0.723	0.025
62	20	LDR unbiased	-1.252	-1.324	-0.072
63	20	LDR unbiased	-0.478	-0.487	-0.009
64	20	LDR unbiased	-1.097	-1.103	-0.006
65	30	LDR unbiased	-1.122	-1.267	-0.145
66	30	LDR unbiased	-1.217	-1.174	0.043
67	30	LDR unbiased	-0.691	-0.79	-0.099
68	30	LDR unbiased	-0.516	-0.706	-0.19
69	30	LDR unbiased	-0.99	-1.04	-0.05
70	0	correlation	-0.352	-0.278	0.074
71	0	correlation	-0.824	-0.828	-0.004
72	0	correlation	-0.45	-0.396	0.054
73	0	correlation	-0.507	-0.692	-0.185
74	0	correlation	-1.085	-1.043	0.042

TID vs Post - Pre Exposure Delta

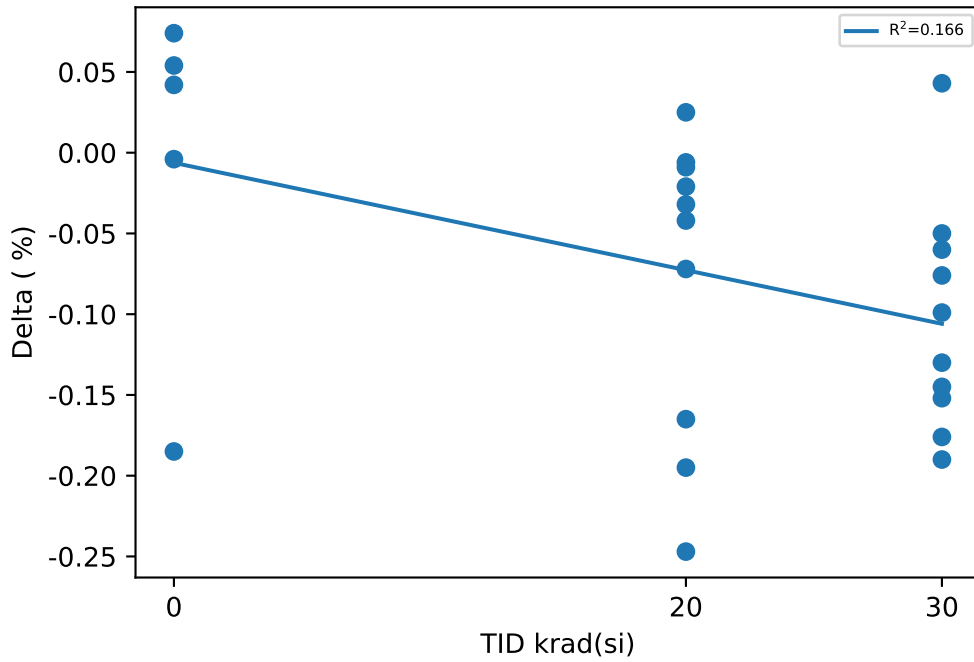

Test Statistics (%)

krad(si)	Pre Exposure Min	Pre Exposure Avg	Pre Exposure Max	Pre Exposure Std	Post Exposure Min	Post Exposure Avg	Post Exposure Max	Post Exposure Std	Min Delta	Avg Delta	Max Delta	Std Delta
0	-1.085	-0.6436	-0.352	0.30354	-1.043	-0.6474	-0.278	0.31256	-0.185	-0.0038	0.074	0.10527
20	-1.252	-0.9538	-0.478	0.23816	-1.493	-1.0302	-0.487	0.29724	-0.247	-0.0764	0.025	0.092523
30	-1.217	-0.9708	-0.516	0.23131	-1.283	-1.0743	-0.706	0.21414	-0.19	-0.1035	0.043	0.070323

Device Test: 12.34 UJJ3KD(Delta_RDSON_28V_CH3CH4_UJJ3KD)

TID vs Result Stats

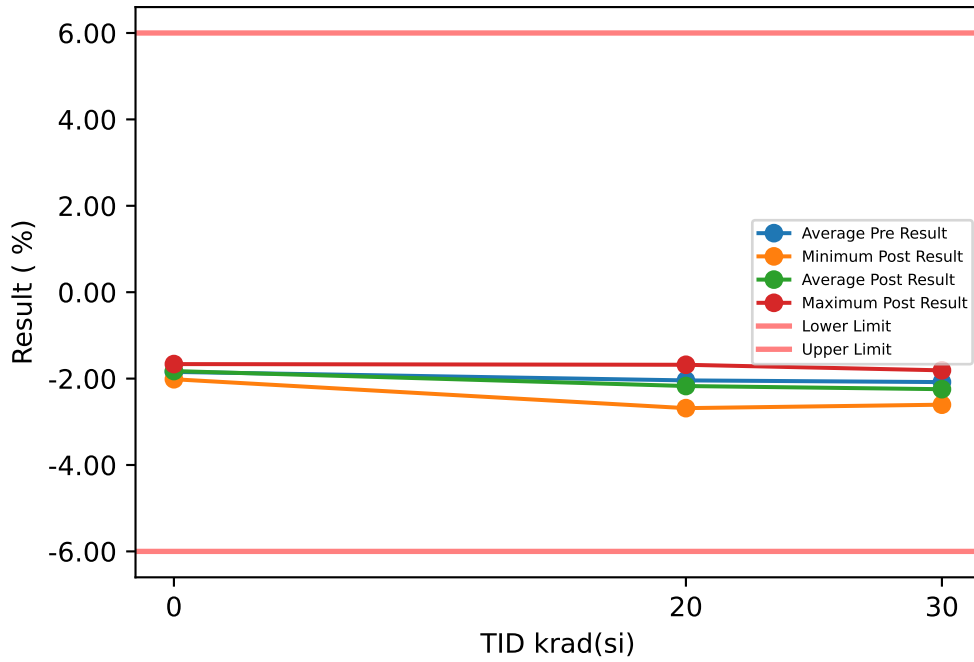

Test Results (Lower Limit = -6.0, Upper Limit = 6.0 (%))

Serial #	krad(si)	Exposure Conditions	Pre Result	Post Result	Delta
50	20	LDR biased	-2.312	-2.574	-0.262
51	20	LDR biased	-1.793	-2.029	-0.236
52	20	LDR biased	-1.657	-1.739	-0.082
53	20	LDR biased	-2.171	-2.432	-0.261
54	20	LDR biased	-2.387	-2.684	-0.297
55	30	LDR biased	-2.116	-2.483	-0.367
56	30	LDR biased	-2.259	-2.573	-0.314
57	30	LDR biased	-2.028	-2.281	-0.253
58	30	LDR biased	-2.058	-2.321	-0.263
59	30	LDR biased	-1.669	-1.989	-0.32
60	20	LDR unbiased	-2.035	-2.161	-0.126
61	20	LDR unbiased	-1.731	-1.68	0.051
62	20	LDR unbiased	-2.064	-2.094	-0.03
63	20	LDR unbiased	-1.725	-1.716	0.009
64	20	LDR unbiased	-2.541	-2.611	-0.07
65	30	LDR unbiased	-2.624	-2.604	0.02
66	30	LDR unbiased	-1.999	-2.021	-0.022
67	30	LDR unbiased	-1.763	-1.809	-0.046
68	30	LDR unbiased	-2.167	-2.225	-0.058
69	30	LDR unbiased	-2.127	-2.146	-0.019
70	0	correlation	-1.652	-1.664	-0.012
71	0	correlation	-1.769	-1.767	0.002
72	0	correlation	-1.719	-1.763	-0.044
73	0	correlation	-2.137	-2.015	0.122
74	0	correlation	-1.95	-1.915	0.035

TID vs Post - Pre Exposure Delta

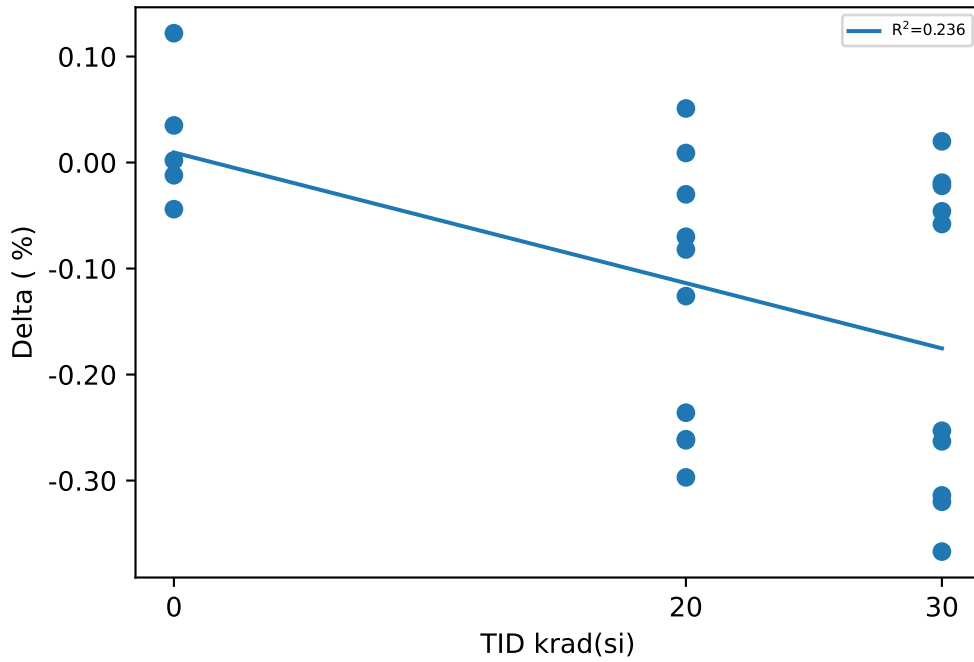

Test Statistics (%)

krad(si)	Pre Exposure Min	Pre Exposure Avg	Pre Exposure Max	Pre Exposure Std	Post Exposure Min	Post Exposure Avg	Post Exposure Max	Post Exposure Std	Min Delta	Avg Delta	Max Delta	Std Delta
0	-2.137	-1.8454	-1.652	0.19697	-2.015	-1.8248	-1.664	0.13904	-0.044	0.0206	0.122	0.063386
20	-2.541	-2.0416	-1.657	0.31011	-2.684	-2.172	-1.68	0.38704	-0.297	-0.1304	0.051	0.12548
30	-2.624	-2.081	-1.669	0.26209	-2.604	-2.2452	-1.809	0.26166	-0.367	-0.1642	0.02	0.15128

Device Test: 12.35 UJJ3KD(Delta_RDSON_32V_CH1CH2_UJJ3KD)

TID vs Result Stats

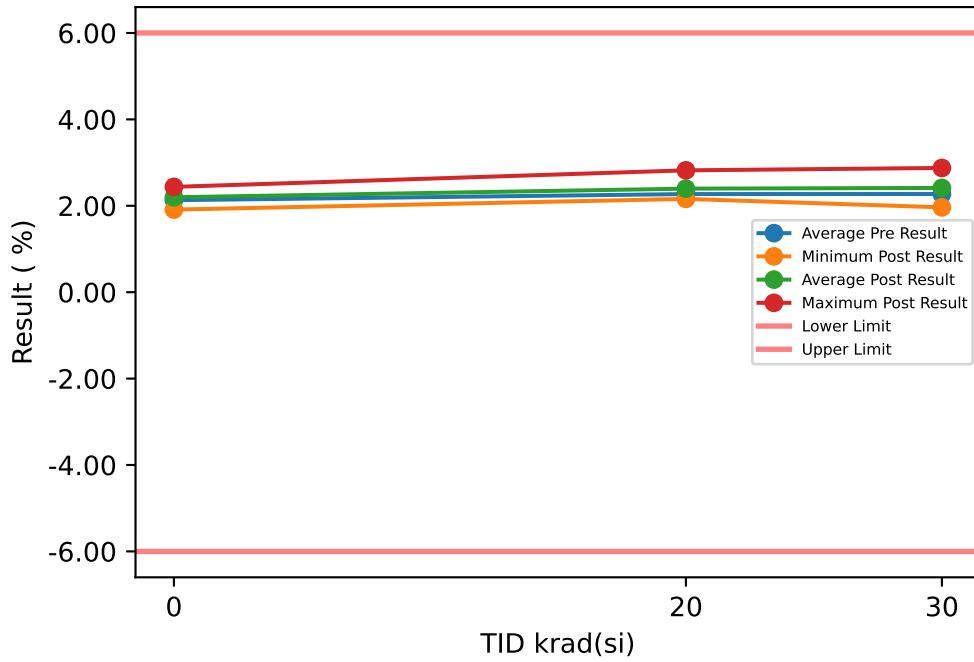

Test Results (Lower Limit = -6.0, Upper Limit = 6.0 (%))

Serial #	krad(si)	Exposure Conditions	Pre Result	Post Result	Delta
50	20	LDR biased	2.313	2.537	0.224
51	20	LDR biased	2.116	2.247	0.131
52	20	LDR biased	2.463	2.821	0.358
53	20	LDR biased	1.974	2.16	0.186
54	20	LDR biased	2.328	2.379	0.051
55	30	LDR biased	2.518	2.876	0.358
56	30	LDR biased	1.851	1.964	0.113
57	30	LDR biased	2.14	2.219	0.079
58	30	LDR biased	2.025	2.334	0.309
59	30	LDR biased	1.982	2.199	0.217
60	20	LDR unbiased	2.316	2.352	0.036
61	20	LDR unbiased	2.144	2.173	0.029
62	20	LDR unbiased	2.559	2.67	0.111
63	20	LDR unbiased	2.194	2.283	0.089
64	20	LDR unbiased	2.308	2.35	0.042
65	30	LDR unbiased	2.39	2.501	0.111
66	30	LDR unbiased	2.273	2.397	0.124
67	30	LDR unbiased	2.396	2.422	0.026
68	30	LDR unbiased	2.464	2.54	0.076
69	30	LDR unbiased	2.688	2.683	-0.005
70	0	correlation	2.211	2.239	0.028
71	0	correlation	2.374	2.438	0.064
72	0	correlation	1.87	1.912	0.042
73	0	correlation	1.978	2.149	0.171
74	0	correlation	2.217	2.249	0.032

TID vs Post - Pre Exposure Delta

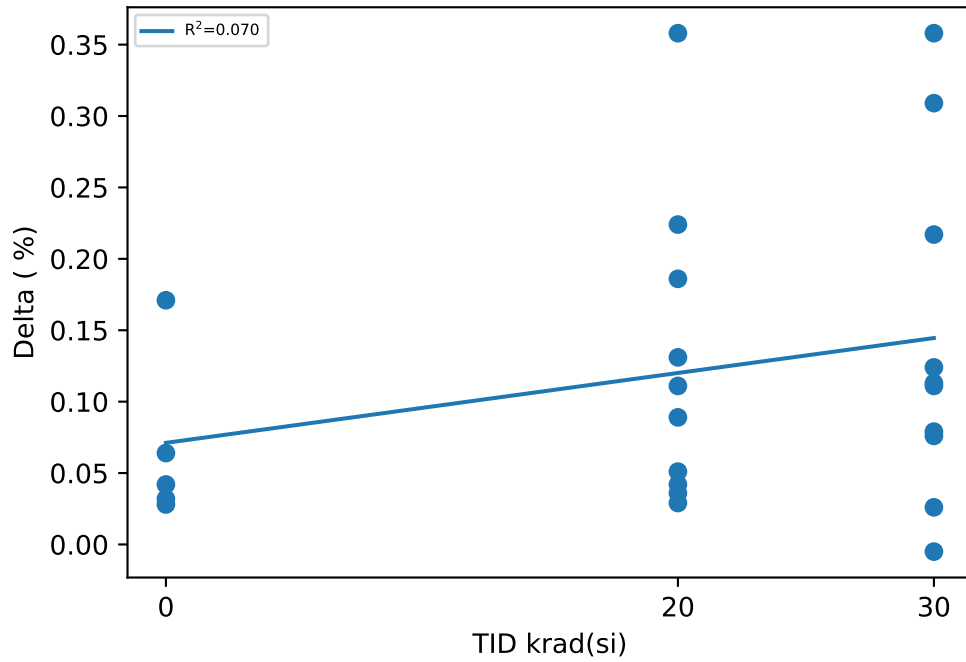

Test Statistics (%)

krad(si)	Pre Exposure Min	Pre Exposure Avg	Pre Exposure Max	Pre Exposure Std	Post Exposure Min	Post Exposure Avg	Post Exposure Max	Post Exposure Std	Min Delta	Avg Delta	Max Delta	Std Delta
0	1.87	2.13	2.374	0.20271	1.912	2.1974	2.438	0.1911	0.028	0.0674	0.171	0.059572
20	1.974	2.2715	2.559	0.17078	2.16	2.3972	2.821	0.2161	0.029	0.1257	0.358	0.10479
30	1.851	2.2727	2.688	0.26656	1.964	2.4135	2.876	0.25879	-0.005	0.1408	0.358	0.11817

Device Test: 12.36 UJJ3KD(Delta_RDSON_32V_CH1CH3_UJJ3KD)

TID vs Result Stats

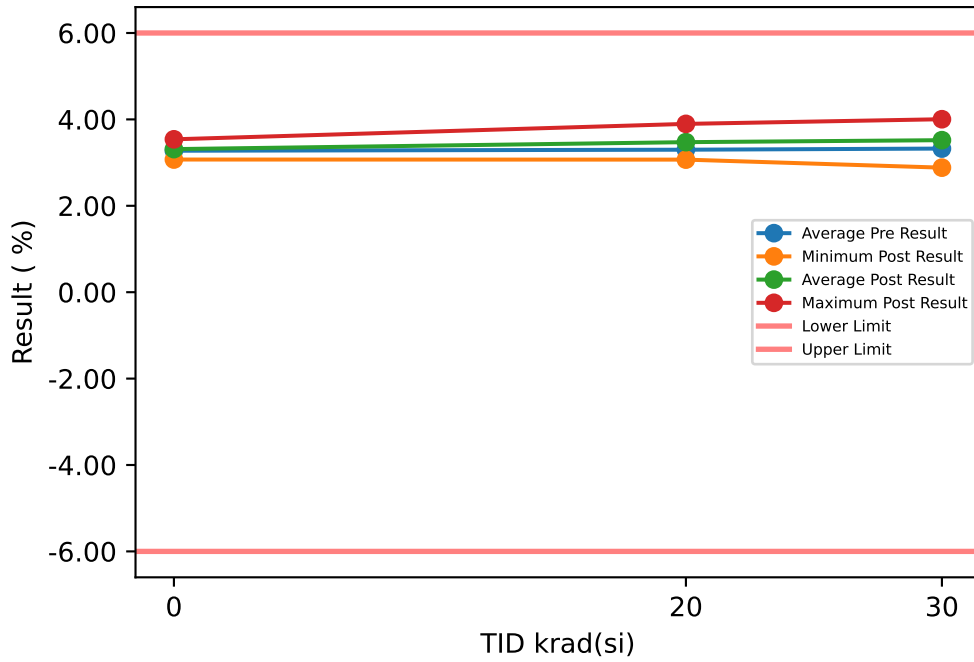

Test Results (Lower Limit = -6.0, Upper Limit = 6.0 (%))

Serial #	krad(si)	Exposure Conditions	Pre Result	Post Result	Delta
50	20	LDR biased	3.314	3.555	0.241
51	20	LDR biased	2.904	3.235	0.331
52	20	LDR biased	3.083	3.354	0.271
53	20	LDR biased	3.108	3.364	0.256
54	20	LDR biased	3.587	3.896	0.309
55	30	LDR biased	3.459	4.004	0.545
56	30	LDR biased	2.986	3.283	0.297
57	30	LDR biased	3.321	3.557	0.236
58	30	LDR biased	3.039	3.42	0.381
59	30	LDR biased	2.417	2.883	0.466
60	20	LDR unbiased	3.535	3.66	0.125
61	20	LDR unbiased	3.093	3.069	-0.024
62	20	LDR unbiased	3.309	3.377	0.068
63	20	LDR unbiased	3.379	3.449	0.07
64	20	LDR unbiased	3.673	3.772	0.099
65	30	LDR unbiased	3.81	3.748	-0.062
66	30	LDR unbiased	3.02	3.195	0.175
67	30	LDR unbiased	3.392	3.386	-0.006
68	30	LDR unbiased	4.036	3.998	-0.038
69	30	LDR unbiased	3.766	3.716	-0.05
70	0	correlation	3.458	3.539	0.081
71	0	correlation	3.278	3.328	0.05
72	0	correlation	3.077	3.218	0.141
73	0	correlation	3.525	3.405	-0.12
74	0	correlation	3.034	3.071	0.037

TID vs Post - Pre Exposure Delta

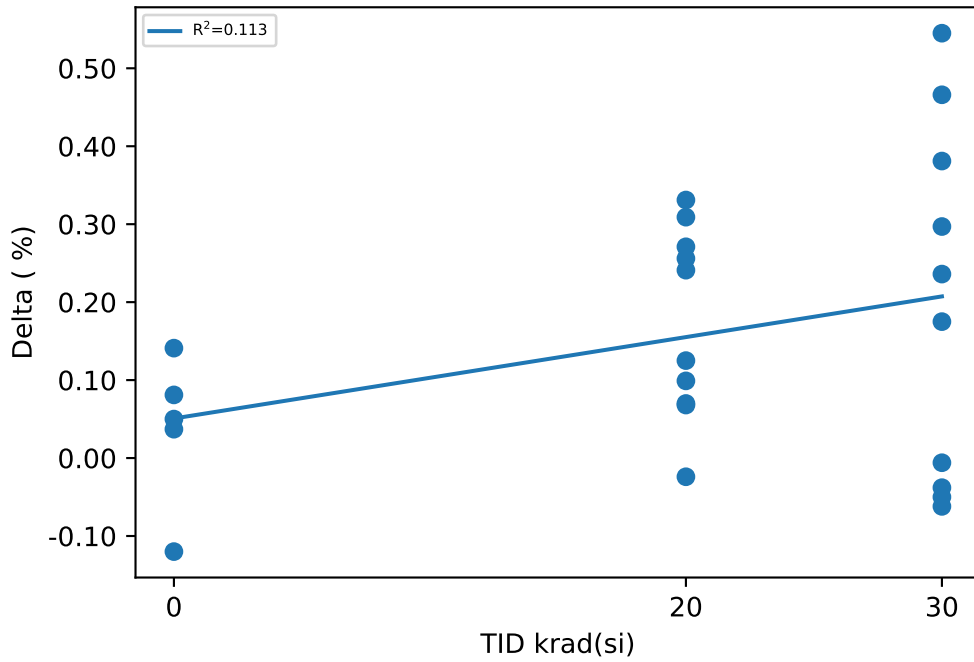

Test Statistics (%)

krad(si)	Pre Exposure Min	Pre Exposure Avg	Pre Exposure Max	Pre Exposure Std	Post Exposure Min	Post Exposure Avg	Post Exposure Max	Post Exposure Std	Min Delta	Avg Delta	Max Delta	Std Delta
0	3.034	3.2744	3.525	0.21982	3.071	3.3122	3.539	0.17843	-0.12	0.0378	0.141	0.096911
20	2.904	3.2985	3.673	0.25096	3.069	3.4731	3.896	0.25071	-0.024	0.1746	0.331	0.12146
30	2.417	3.3246	4.036	0.4798	2.883	3.519	4.004	0.35746	-0.062	0.1944	0.545	0.22701

Device Test: 12.37 UJJ3KD(Delta_RDSON_32V_CH1CH4_UJJ3KD)

TID vs Result Stats

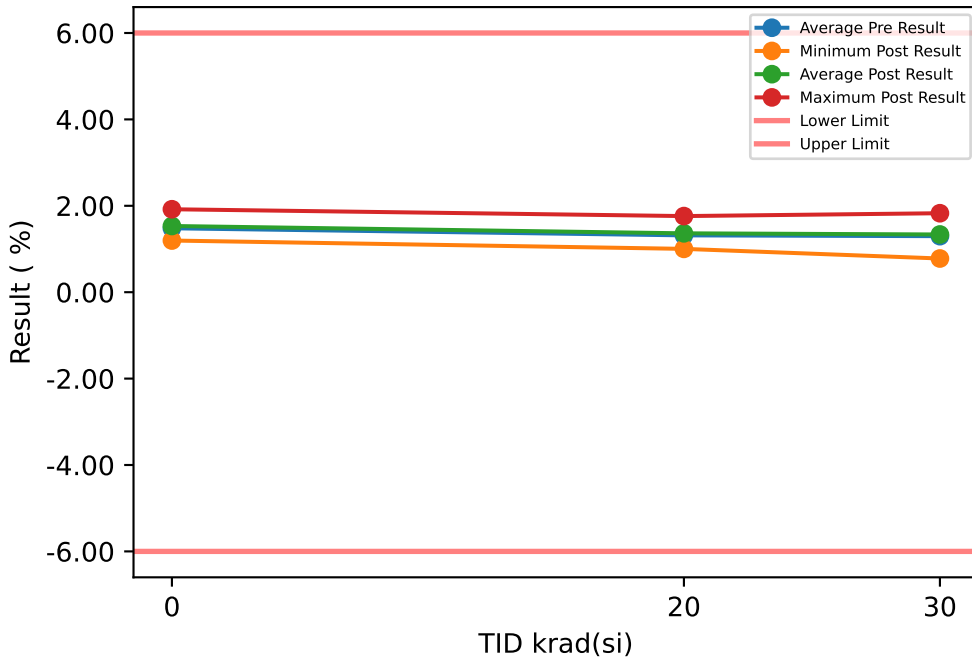

Test Results (Lower Limit = -6.0, Upper Limit = 6.0 (%))

Serial #	krad(si)	Exposure Conditions	Pre Result	Post Result	Delta
50	20	LDR biased	1.079	1.065	-0.014
51	20	LDR biased	1.16	1.25	0.09
52	20	LDR biased	1.47	1.647	0.177
53	20	LDR biased	0.993	1.003	0.01
54	20	LDR biased	1.289	1.306	0.017
55	30	LDR biased	1.423	1.616	0.193
56	30	LDR biased	0.789	0.78	-0.009
57	30	LDR biased	1.33	1.355	0.025
58	30	LDR biased	1.013	1.164	0.151
59	30	LDR biased	0.778	0.917	0.139
60	20	LDR unbiased	1.553	1.57	0.017
61	20	LDR unbiased	1.398	1.437	0.039
62	20	LDR unbiased	1.301	1.34	0.039
63	20	LDR unbiased	1.699	1.762	0.063
64	20	LDR unbiased	1.215	1.249	0.034
65	30	LDR unbiased	1.26	1.231	-0.029
66	30	LDR unbiased	1.061	1.209	0.148
67	30	LDR unbiased	1.68	1.629	-0.051
68	30	LDR unbiased	1.937	1.828	-0.109
69	30	LDR unbiased	1.699	1.632	-0.067
70	0	correlation	1.86	1.92	0.06
71	0	correlation	1.564	1.597	0.033
72	0	correlation	1.4	1.501	0.101
73	0	correlation	1.454	1.449	-0.005
74	0	correlation	1.119	1.196	0.077

TID vs Post - Pre Exposure Delta

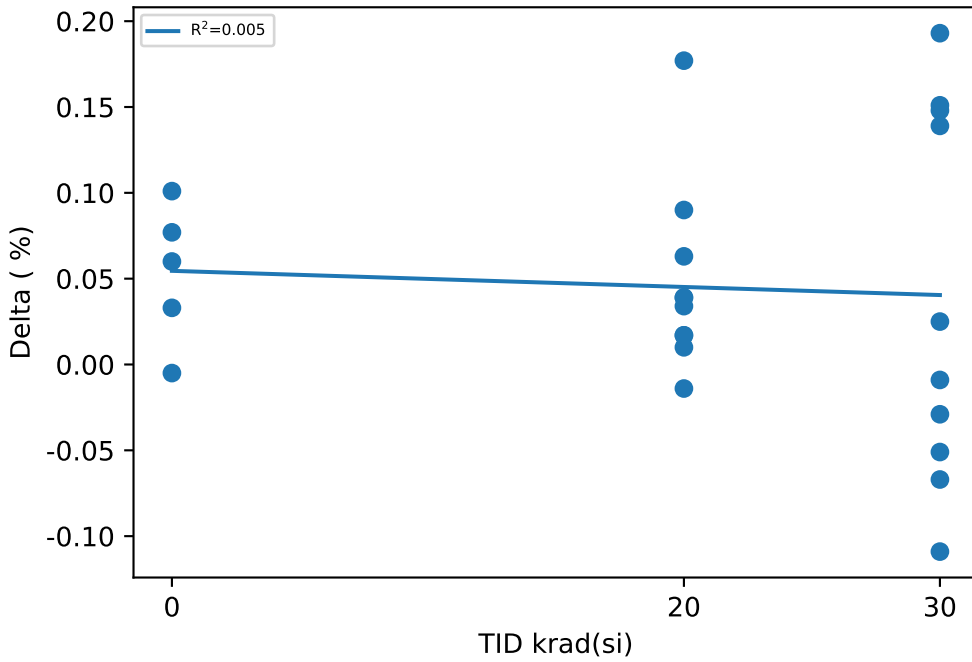

Test Statistics (%)

krad(si)	Pre Exposure Min	Pre Exposure Avg	Pre Exposure Max	Pre Exposure Std	Post Exposure Min	Post Exposure Avg	Post Exposure Max	Post Exposure Std	Min Delta	Avg Delta	Max Delta	Std Delta
0	1.119	1.4794	1.86	0.26872	1.196	1.5326	1.92	0.26245	-0.005	0.0532	0.101	0.040905
20	0.993	1.3157	1.699	0.2184	1.003	1.3629	1.762	0.24407	-0.014	0.0472	0.177	0.053946
30	0.778	1.297	1.937	0.39441	0.78	1.3361	1.828	0.33924	-0.109	0.0391	0.193	0.10878

Device Test: 12.38 UJJ3KD(Delta_RDSON_32V_CH2CH3_UJJ3KD)

TID vs Result Stats

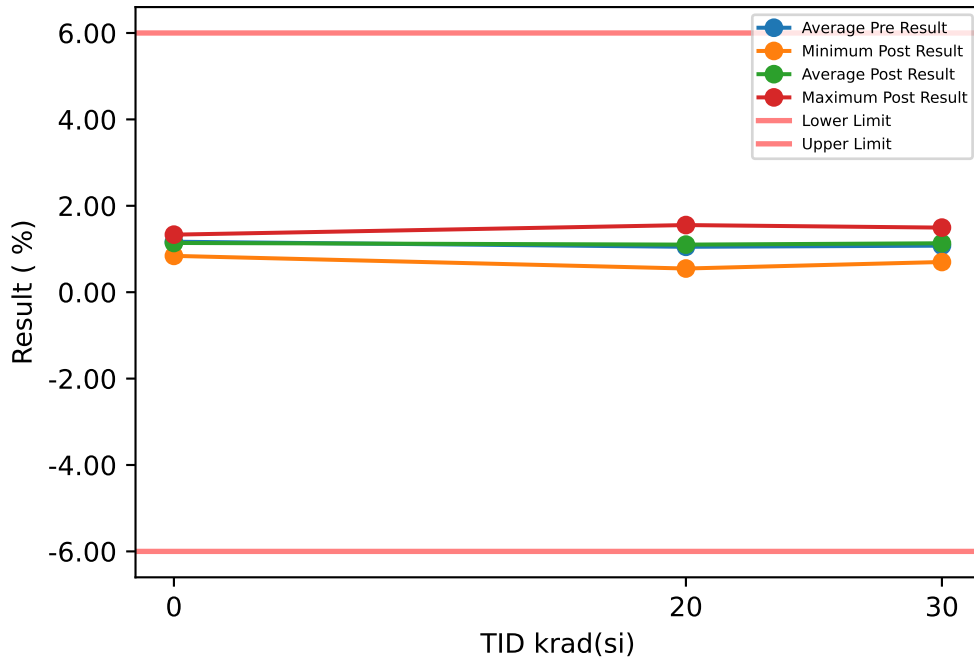

Test Results (Lower Limit = -6.0, Upper Limit = 6.0 (%))

Serial #	krad(si)	Exposure Conditions	Pre Result	Post Result	Delta
50	20	LDR biased	1.025	1.044	0.019
51	20	LDR biased	0.805	1.01	0.205
52	20	LDR biased	0.636	0.548	-0.088
53	20	LDR biased	1.156	1.231	0.075
54	20	LDR biased	1.289	1.554	0.265
55	30	LDR biased	0.966	1.161	0.195
56	30	LDR biased	1.157	1.346	0.189
57	30	LDR biased	1.207	1.368	0.161
58	30	LDR biased	1.034	1.112	0.078
59	30	LDR biased	0.444	0.699	0.255
60	20	LDR unbiased	1.247	1.339	0.092
61	20	LDR unbiased	0.97	0.916	-0.054
62	20	LDR unbiased	0.77	0.726	-0.044
63	20	LDR unbiased	1.211	1.193	-0.018
64	20	LDR unbiased	1.398	1.456	0.058
65	30	LDR unbiased	1.455	1.278	-0.177
66	30	LDR unbiased	0.764	0.818	0.054
67	30	LDR unbiased	1.021	0.988	-0.033
68	30	LDR unbiased	1.611	1.495	-0.116
69	30	LDR unbiased	1.107	1.062	-0.045
70	0	correlation	1.275	1.329	0.054
71	0	correlation	0.926	0.912	-0.014
72	0	correlation	1.23	1.332	0.102
73	0	correlation	1.578	1.283	-0.295
74	0	correlation	0.835	0.841	0.006

TID vs Post - Pre Exposure Delta

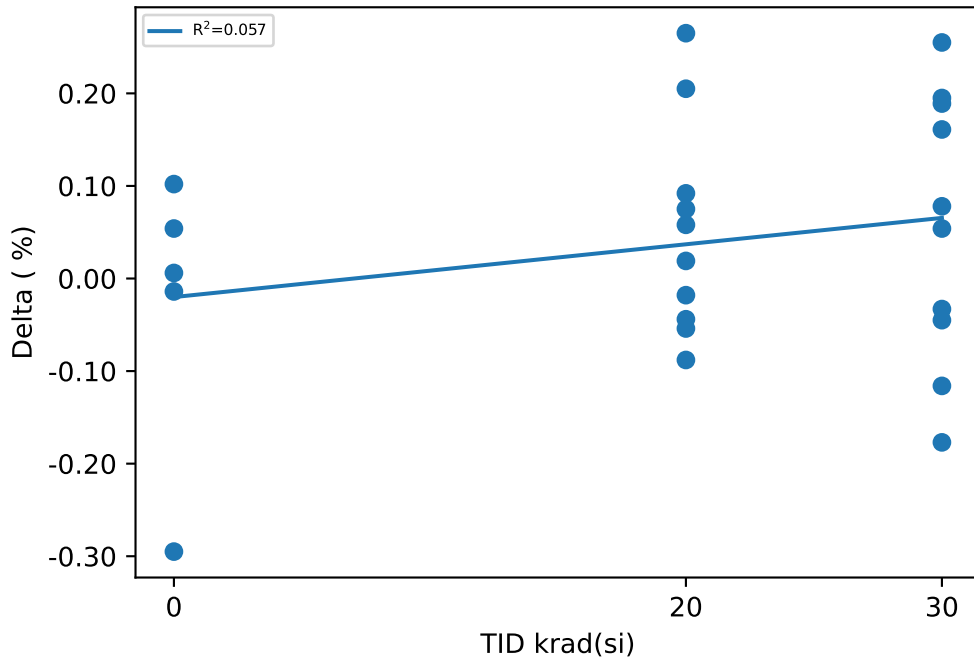

Test Statistics (%)

krad(si)	Pre Exposure Min	Pre Exposure Avg	Pre Exposure Max	Pre Exposure Std	Post Exposure Min	Post Exposure Avg	Post Exposure Max	Post Exposure Std	Min Delta	Avg Delta	Max Delta	Std Delta
0	0.835	1.1688	1.578	0.297	0.841	1.1394	1.332	0.24208	-0.295	-0.0294	0.102	0.15513
20	0.636	1.0507	1.398	0.25189	0.548	1.1017	1.554	0.31718	-0.088	0.051	0.265	0.114
30	0.444	1.0766	1.611	0.32799	0.699	1.1327	1.495	0.25112	-0.177	0.0561	0.255	0.14534

Device Test: 12.39 UJJ3KD(Delta_RDSON_32V_CH2CH4_UJJ3KD)

TID vs Result Stats

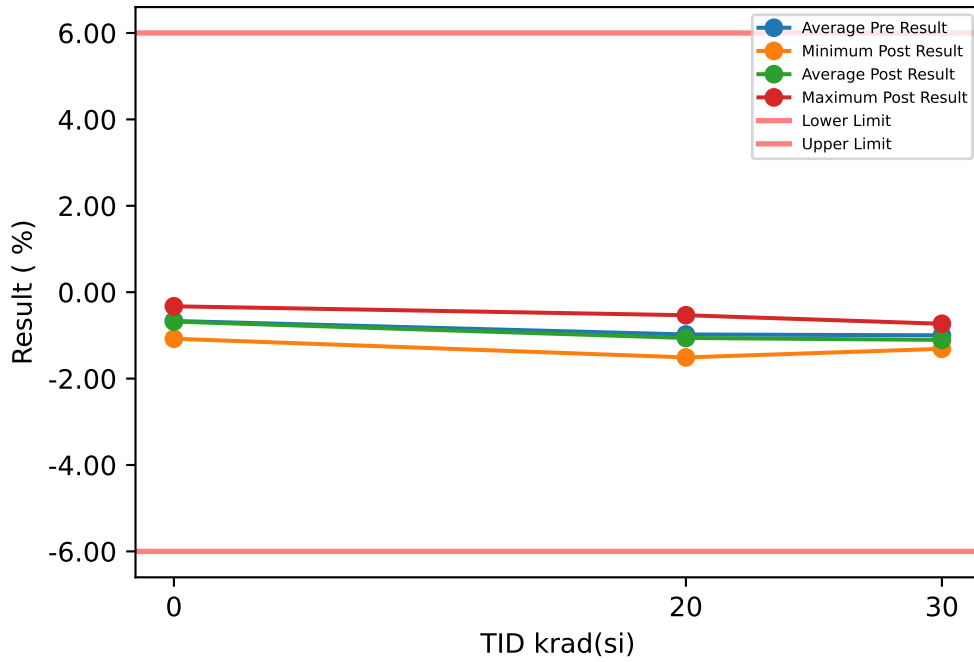

TID vs Post - Pre Exposure Delta

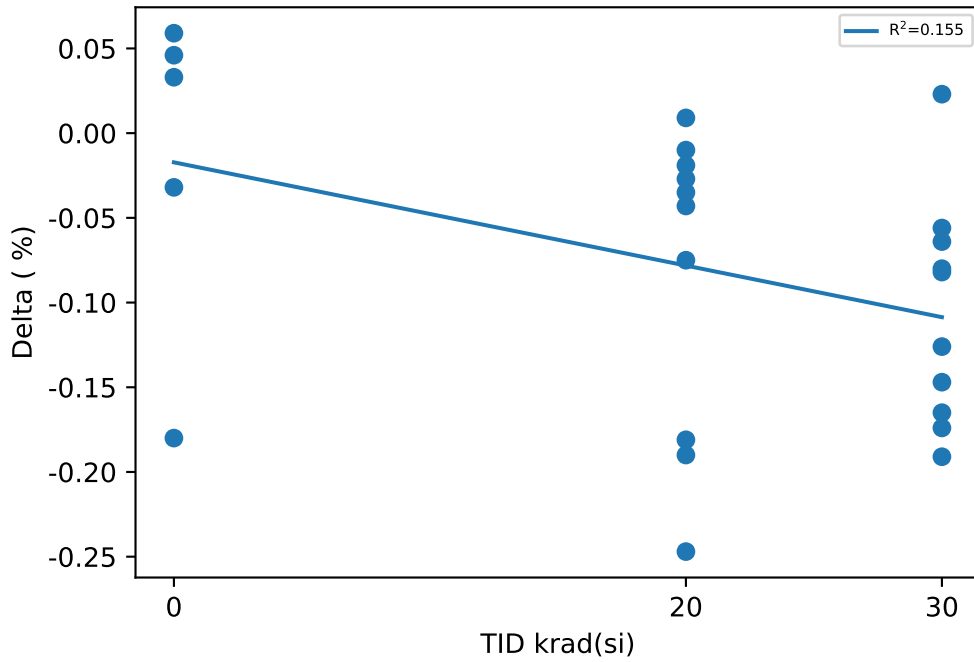

Test Results (Lower Limit = -6.0, Upper Limit = 6.0 (%))

Serial #	krad(si)	Exposure Conditions	Pre Result	Post Result	Delta
50	20	LDR biased	-1.263	-1.51	-0.247
51	20	LDR biased	-0.977	-1.02	-0.043
52	20	LDR biased	-1.018	-1.208	-0.19
53	20	LDR biased	-1.001	-1.182	-0.181
54	20	LDR biased	-1.064	-1.099	-0.035
55	30	LDR biased	-1.124	-1.298	-0.174
56	30	LDR biased	-1.081	-1.207	-0.126
57	30	LDR biased	-0.828	-0.884	-0.056
58	30	LDR biased	-1.033	-1.198	-0.165
59	30	LDR biased	-1.229	-1.311	-0.082
60	20	LDR unbiased	-0.781	-0.8	-0.019
61	20	LDR unbiased	-0.762	-0.753	0.009
62	20	LDR unbiased	-1.291	-1.366	-0.075
63	20	LDR unbiased	-0.506	-0.533	-0.027
64	20	LDR unbiased	-1.118	-1.128	-0.01
65	30	LDR unbiased	-1.157	-1.304	-0.147
66	30	LDR unbiased	-1.24	-1.217	0.023
67	30	LDR unbiased	-0.733	-0.813	-0.08
68	30	LDR unbiased	-0.54	-0.731	-0.191
69	30	LDR unbiased	-1.016	-1.08	-0.064
70	0	correlation	-0.359	-0.326	0.033
71	0	correlation	-0.83	-0.862	-0.032
72	0	correlation	-0.479	-0.42	0.059
73	0	correlation	-0.535	-0.715	-0.18
74	0	correlation	-1.123	-1.077	0.046

Test Statistics (%)

krad(si)	Pre Exposure Min	Pre Exposure Avg	Pre Exposure Max	Pre Exposure Std	Post Exposure Min	Post Exposure Avg	Post Exposure Max	Post Exposure Std	Min Delta	Avg Delta	Max Delta	Std Delta
0	-1.123	-0.6652	-0.359	0.30908	-1.077	-0.68	-0.326	0.31019	-0.18	-0.0148	0.059	0.098761
20	-1.291	-0.9781	-0.506	0.23958	-1.51	-1.0599	-0.533	0.29444	-0.247	-0.0818	0.009	0.090017
30	-1.24	-0.9981	-0.54	0.22862	-1.311	-1.1043	-0.731	0.21743	-0.191	-0.1062	0.023	0.066305

Device Test: 12.4 UJ4ZR4(RDSON_32V_OUT1_UJE410_UJ4ZR4)

TID vs Result Stats

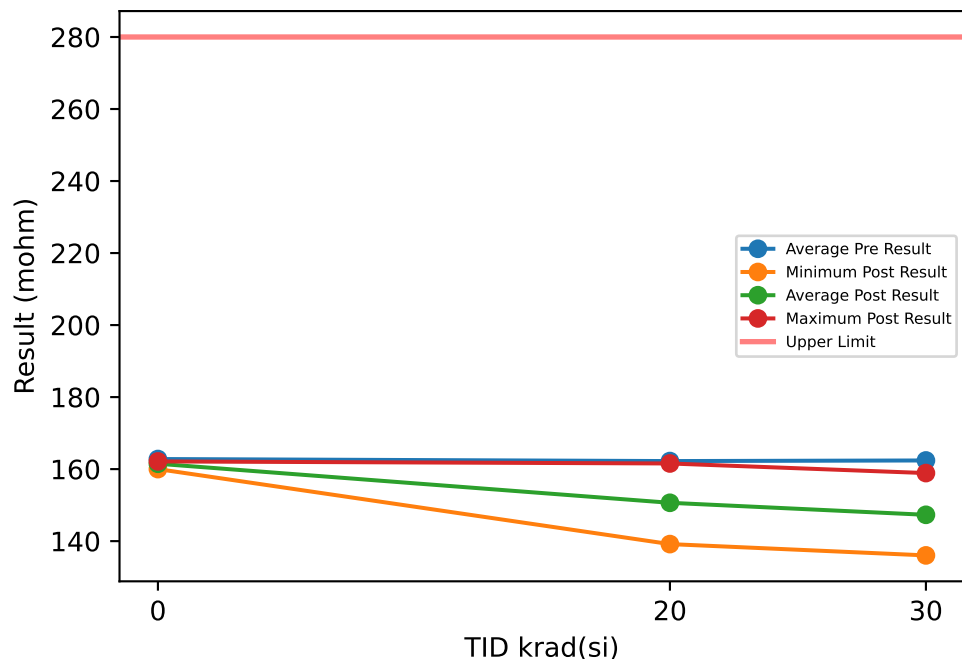

Test Results (Upper Limit = 280.0 (mohm))

Serial #	krad(si)	Exposure Conditions	Pre Result	Post Result	Delta
50	20	LDR biased	159.83	139.18	-20.647
51	20	LDR biased	162.69	141.39	-21.297
52	20	LDR biased	162.23	141.28	-20.953
53	20	LDR biased	161.9	140.85	-21.047
54	20	LDR biased	161.43	140.69	-20.742
55	30	LDR biased	162.88	136.39	-26.493
56	30	LDR biased	162.18	136.04	-26.144
57	30	LDR biased	161.52	136.09	-25.428
58	30	LDR biased	162.21	136.56	-25.655
59	30	LDR biased	163.95	137.63	-26.328
60	20	LDR unbiased	162.83	160.28	-2.5511
61	20	LDR unbiased	162.33	159.89	-2.4338
62	20	LDR unbiased	163.22	161.57	-1.6571
63	20	LDR unbiased	163.02	160.42	-2.5956
64	20	LDR unbiased	162.89	160.92	-1.977
65	30	LDR unbiased	160.94	156.81	-4.1284
66	30	LDR unbiased	162.77	158.89	-3.872
67	30	LDR unbiased	163.86	158.9	-4.9621
68	30	LDR unbiased	161.67	157.77	-3.8986
69	30	LDR unbiased	162.03	158.03	-4.0069
70	0	correlation	161.41	160.01	-1.4079
71	0	correlation	163.87	161.96	-1.905
72	0	correlation	163.19	161.91	-1.2878
73	0	correlation	163.36	162.14	-1.2258
74	0	correlation	162.18	161.45	-0.7211

TID vs Post - Pre Exposure Delta

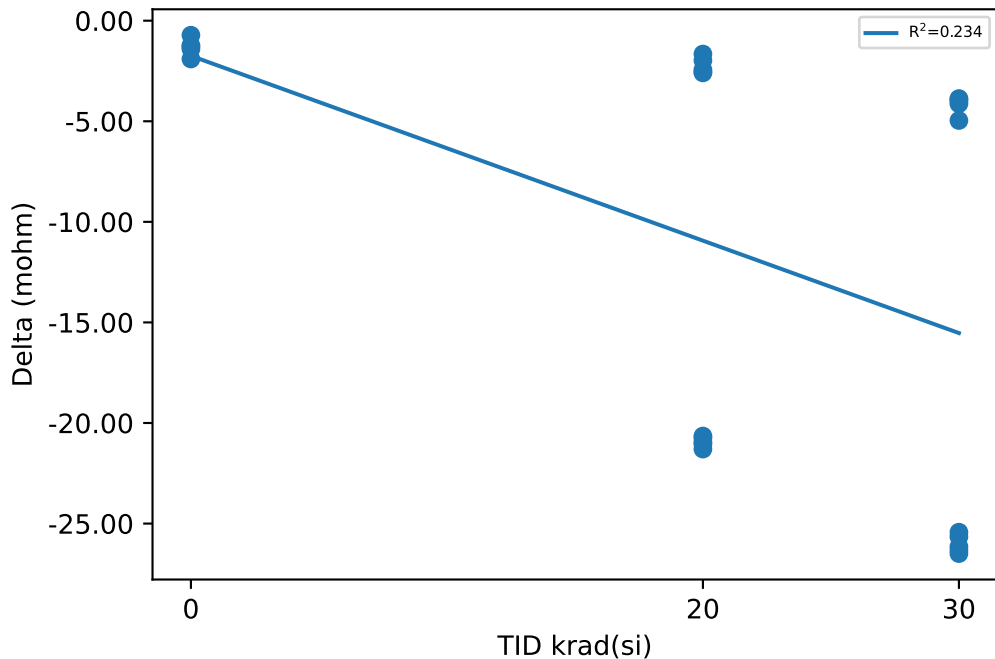

Test Statistics (mohm)

krad(si)	Pre Exposure Min	Pre Exposure Avg	Pre Exposure Max	Pre Exposure Std	Post Exposure Min	Post Exposure Avg	Post Exposure Max	Post Exposure Std	Min Delta	Avg Delta	Max Delta	Std Delta
0	161.41	162.8	163.87	0.98944	160.01	161.49	162.14	0.86801	-1.905	-1.3095	-0.7211	0.42367
20	159.83	162.24	163.22	1.0093	139.18	150.65	161.57	10.534	-21.297	-11.59	-1.6571	9.8581
30	160.94	162.4	163.95	0.97661	136.04	147.31	158.9	11.376	-26.493	-15.092	-3.872	11.517

Device Test: 12.40 UJJ3KD(Delta_RDSON_32V_CH3CH4_UJJ3KD)

TID vs Result Stats

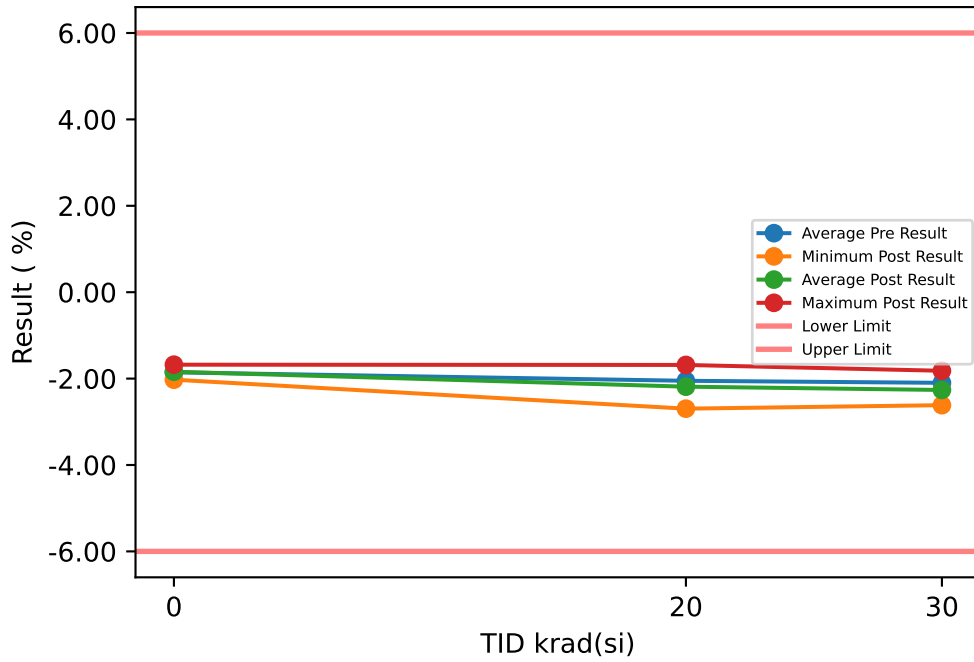

Test Results (Lower Limit = -6.0, Upper Limit = 6.0 (%))

Serial #	krad(si)	Exposure Conditions	Pre Result	Post Result	Delta
50	20	LDR biased	-2.311	-2.582	-0.271
51	20	LDR biased	-1.796	-2.051	-0.255
52	20	LDR biased	-1.665	-1.766	-0.101
53	20	LDR biased	-2.182	-2.444	-0.262
54	20	LDR biased	-2.384	-2.696	-0.312
55	30	LDR biased	-2.11	-2.488	-0.378
56	30	LDR biased	-2.265	-2.587	-0.322
57	30	LDR biased	-2.059	-2.284	-0.225
58	30	LDR biased	-2.089	-2.336	-0.247
59	30	LDR biased	-1.68	-2.025	-0.345
60	20	LDR unbiased	-2.054	-2.169	-0.115
61	20	LDR unbiased	-1.749	-1.684	0.065
62	20	LDR unbiased	-2.077	-2.108	-0.031
63	20	LDR unbiased	-1.738	-1.748	-0.01
64	20	LDR unbiased	-2.551	-2.622	-0.071
65	30	LDR unbiased	-2.651	-2.615	0.036
66	30	LDR unbiased	-2.02	-2.052	-0.032
67	30	LDR unbiased	-1.772	-1.819	-0.047
68	30	LDR unbiased	-2.187	-2.26	-0.073
69	30	LDR unbiased	-2.147	-2.164	-0.017
70	0	correlation	-1.655	-1.678	-0.023
71	0	correlation	-1.772	-1.79	-0.018
72	0	correlation	-1.73	-1.775	-0.045
73	0	correlation	-2.147	-2.025	0.122
74	0	correlation	-1.975	-1.934	0.041

TID vs Post - Pre Exposure Delta

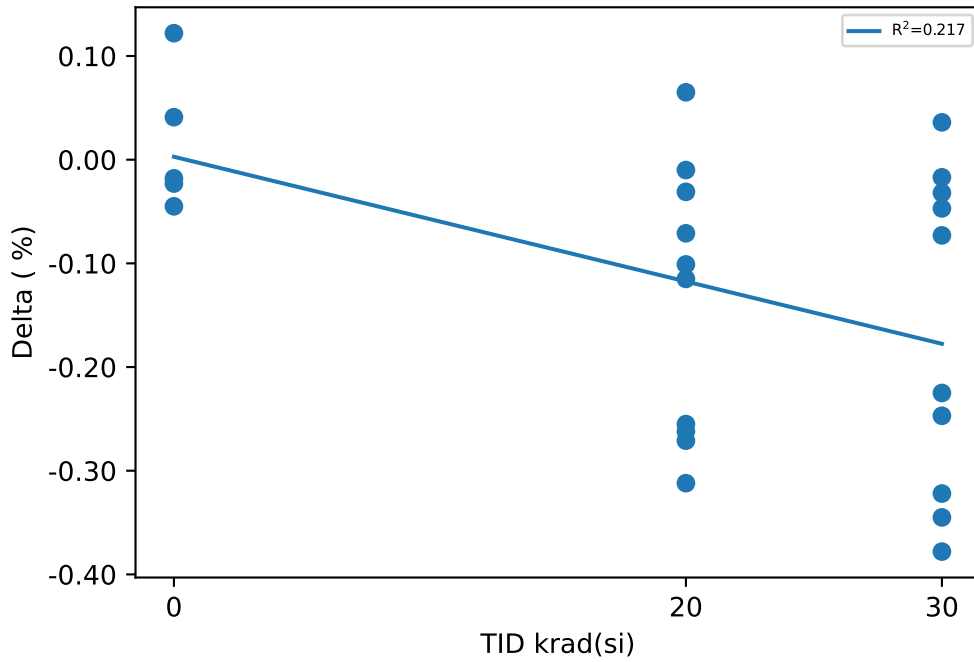

Test Statistics (%)

krad(si)	Pre Exposure Min	Pre Exposure Avg	Pre Exposure Max	Pre Exposure Std	Post Exposure Min	Post Exposure Avg	Post Exposure Max	Post Exposure Std	Min Delta	Avg Delta	Max Delta	Std Delta
0	-2.147	-1.8558	-1.655	0.20135	-2.025	-1.8404	-1.678	0.13787	-0.045	0.0154	0.122	0.06756
20	-2.551	-2.0507	-1.665	0.30723	-2.696	-2.187	-1.684	0.38274	-0.312	-0.1363	0.065	0.13014
30	-2.651	-2.098	-1.68	0.26517	-2.615	-2.263	-1.819	0.25677	-0.378	-0.165	0.036	0.1546

Device Test: 12.5 UJ4ZR4(RDSON_5V_OUT2_UJE410_UJ4ZR4)

TID vs Result Stats

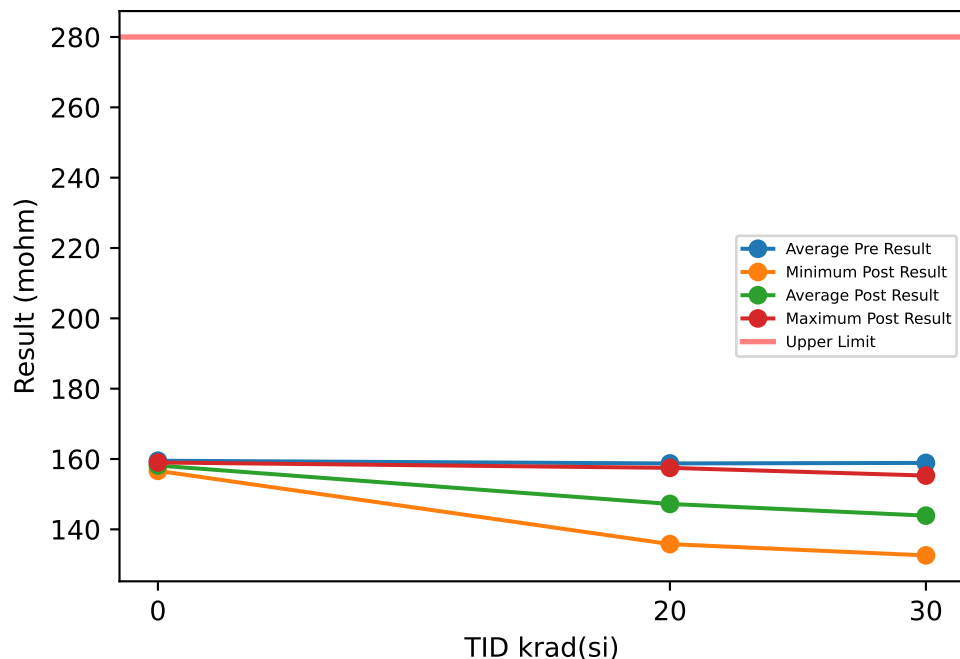

Test Results (Upper Limit = 280.0 (mohm))

Serial #	krad(si)	Exposure Conditions	Pre Result	Post Result	Delta
50	20	LDR biased	156.33	135.8	-20.526
51	20	LDR biased	159.42	138.36	-21.055
52	20	LDR biased	158.43	137.5	-20.923
53	20	LDR biased	158.87	137.98	-20.897
54	20	LDR biased	157.84	137.53	-20.317
55	30	LDR biased	158.95	132.59	-26.356
56	30	LDR biased	159.37	133.51	-25.856
57	30	LDR biased	158.24	133.2	-25.039
58	30	LDR biased	159.13	133.5	-25.629
59	30	LDR biased	160.87	134.72	-26.147
60	20	LDR unbiased	159.23	156.69	-2.5399
61	20	LDR unbiased	159.02	156.59	-2.4319
62	20	LDR unbiased	159.25	157.49	-1.7616
63	20	LDR unbiased	159.65	156.98	-2.6704
64	20	LDR unbiased	159.35	157.33	-2.0184
65	30	LDR unbiased	157.28	153.07	-4.2043
66	30	LDR unbiased	159.25	155.29	-3.9574
67	30	LDR unbiased	160.12	155.24	-4.8808
68	30	LDR unbiased	157.86	153.91	-3.9549
69	30	LDR unbiased	157.86	153.95	-3.9115
70	0	correlation	158	156.63	-1.3604
71	0	correlation	160.16	158.19	-1.9685
72	0	correlation	160.33	159.01	-1.3251
73	0	correlation	160.3	158.85	-1.4566
74	0	correlation	158.76	158.04	-0.727

TID vs Post - Pre Exposure Delta

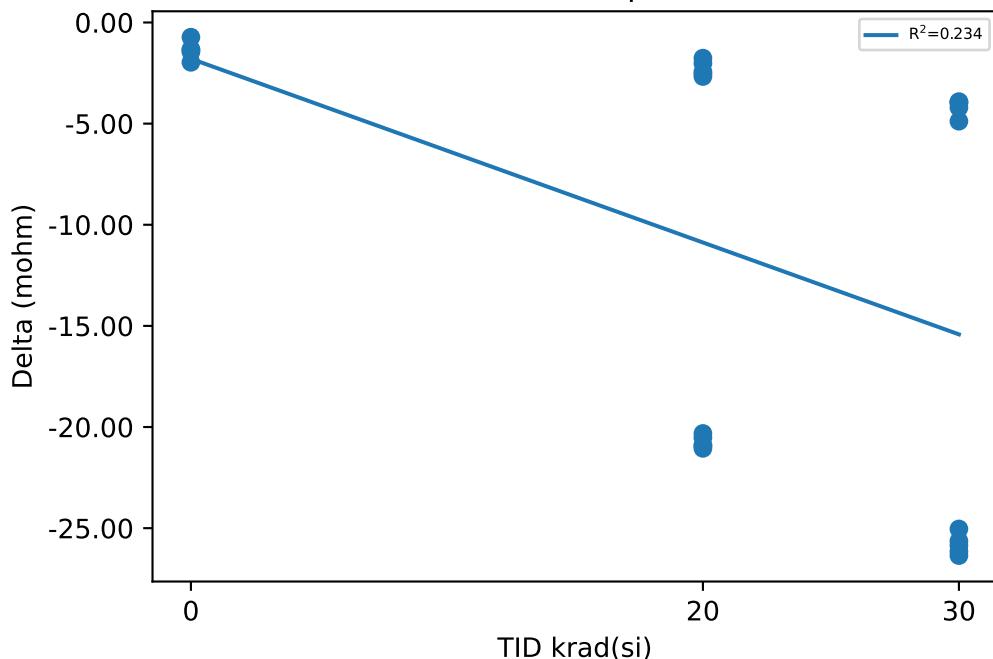

Test Statistics (mohm)

krad(si)	Pre Exposure Min	Pre Exposure Avg	Pre Exposure Max	Pre Exposure Std	Post Exposure Min	Post Exposure Avg	Post Exposure Max	Post Exposure Std	Min Delta	Avg Delta	Max Delta	Std Delta
0	158	159.51	160.33	1.0701	156.63	158.14	159.01	0.93995	-1.9685	-1.3675	-0.727	0.44194
20	156.33	158.74	159.65	0.99839	135.8	147.22	157.49	10.344	-21.055	-11.514	-1.7616	9.7343
30	157.28	158.89	160.87	1.1044	132.59	143.9	155.29	10.987	-26.356	-14.994	-3.9115	11.405

Device Test: 12.6 UJ4ZR4(RDSON_12V_OUT2_UJE410_UJ4ZR4)

TID vs Result Stats

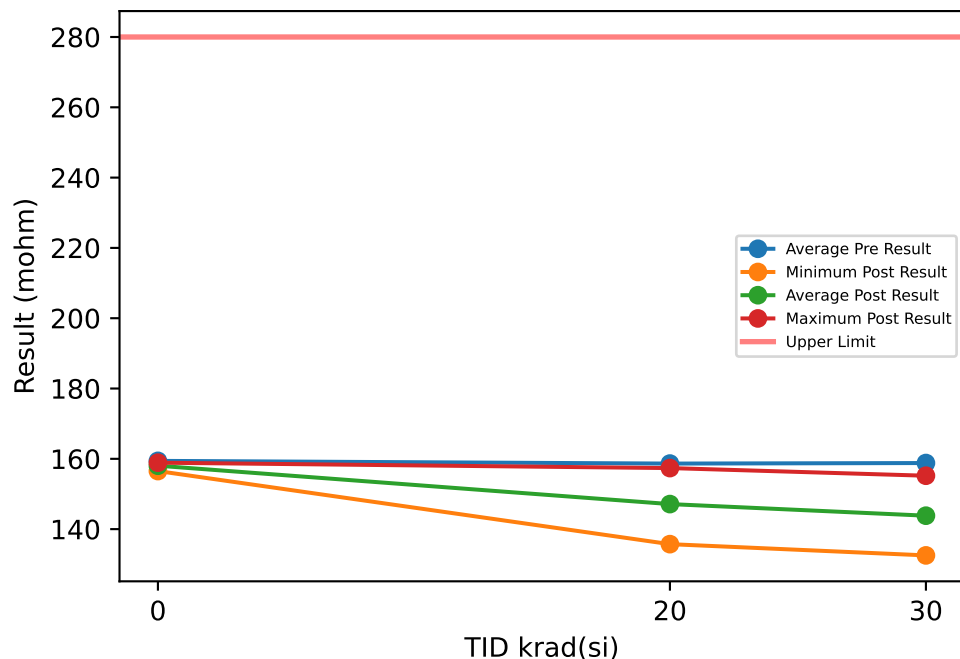

Test Results (Upper Limit = 280.0 (mohm))

Serial #	krad(si)	Exposure Conditions	Pre Result	Post Result	Delta
50	20	LDR biased	156.26	135.73	-20.531
51	20	LDR biased	159.35	138.29	-21.067
52	20	LDR biased	158.33	137.39	-20.946
53	20	LDR biased	158.79	137.88	-20.909
54	20	LDR biased	157.78	137.43	-20.358
55	30	LDR biased	158.86	132.53	-26.332
56	30	LDR biased	159.29	133.42	-25.865
57	30	LDR biased	158.14	133.14	-25.001
58	30	LDR biased	159.03	133.43	-25.603
59	30	LDR biased	160.79	134.67	-26.12
60	20	LDR unbiased	159.14	156.6	-2.5369
61	20	LDR unbiased	158.92	156.48	-2.4368
62	20	LDR unbiased	159.16	157.37	-1.7866
63	20	LDR unbiased	159.53	156.87	-2.6551
64	20	LDR unbiased	159.23	157.23	-2.0089
65	30	LDR unbiased	157.18	152.99	-4.1869
66	30	LDR unbiased	159.15	155.19	-3.9559
67	30	LDR unbiased	160.03	155.15	-4.876
68	30	LDR unbiased	157.78	153.85	-3.9299
69	30	LDR unbiased	157.76	153.87	-3.8897
70	0	correlation	157.92	156.52	-1.3993
71	0	correlation	160.06	158.1	-1.9555
72	0	correlation	160.24	158.9	-1.3428
73	0	correlation	160.21	158.75	-1.4609
74	0	correlation	158.66	157.93	-0.7303

TID vs Post - Pre Exposure Delta

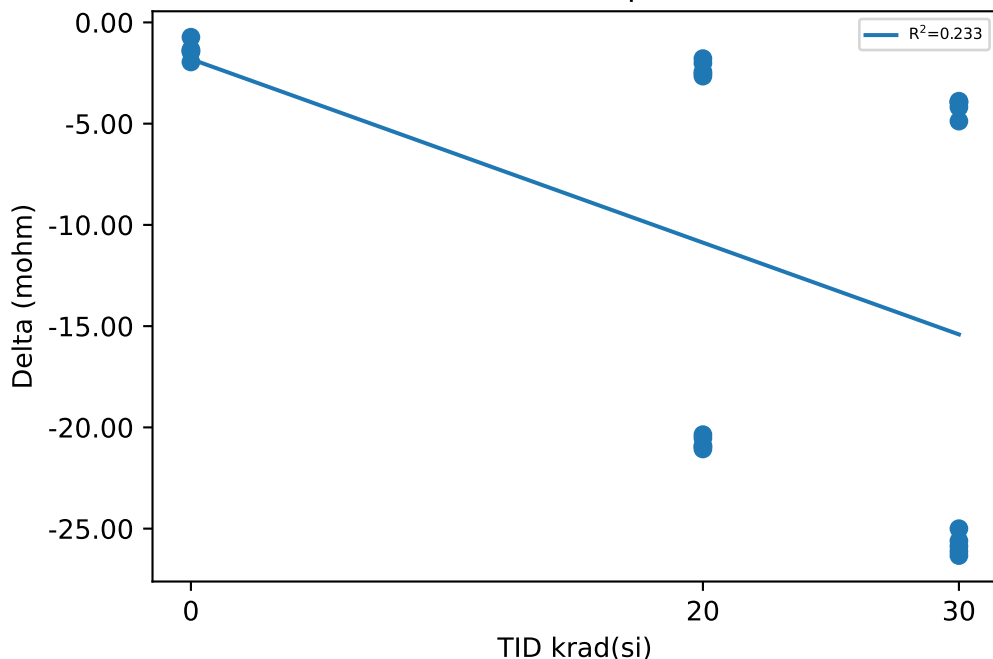

Test Statistics (mohm)

krad(si)	Pre Exposure Min	Pre Exposure Avg	Pre Exposure Max	Pre Exposure Std	Post Exposure Min	Post Exposure Avg	Post Exposure Max	Post Exposure Std	Min Delta	Avg Delta	Max Delta	Std Delta
0	157.92	159.42	160.24	1.0671	156.52	158.04	158.9	0.94623	-1.9555	-1.3778	-0.7303	0.43634
20	156.26	158.65	159.53	0.98675	135.73	147.13	157.37	10.337	-21.067	-11.524	-1.7866	9.7436
30	157.18	158.8	160.79	1.1102	132.53	143.82	155.19	10.978	-26.332	-14.976	-3.8897	11.401

Device Test: 12.7 UJ4ZR4(RDSON_28V_OUT2_UJE410_UJ4ZR4)

TID vs Result Stats

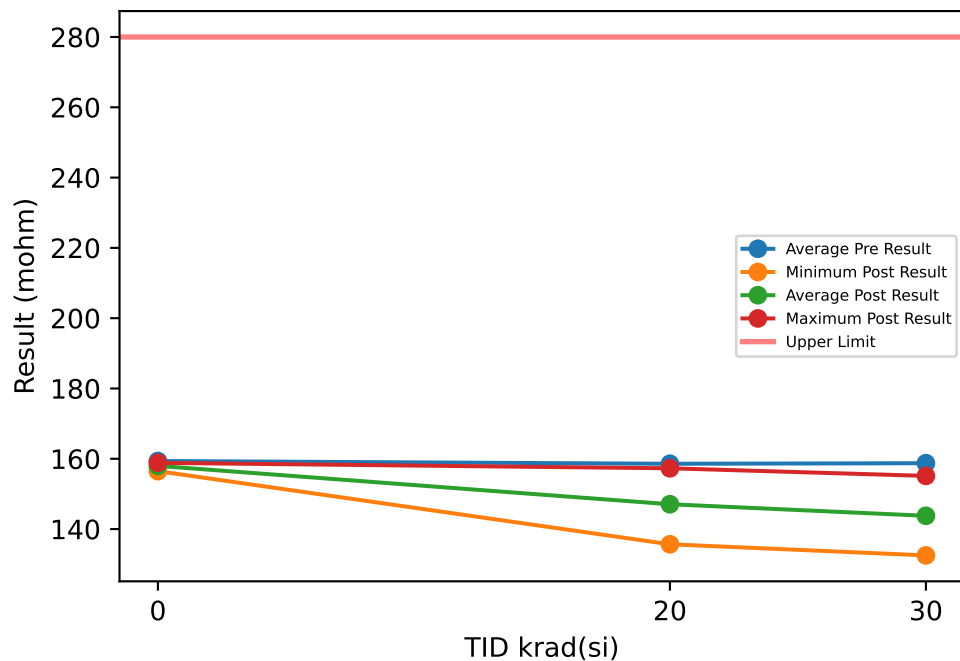

Test Results (Upper Limit = 280.0 (mohm))

Serial #	krad(si)	Exposure Conditions	Pre Result	Post Result	Delta
50	20	LDR biased	156.16	135.67	-20.486
51	20	LDR biased	159.28	138.24	-21.04
52	20	LDR biased	158.27	137.33	-20.936
53	20	LDR biased	158.73	137.83	-20.904
54	20	LDR biased	157.71	137.37	-20.348
55	30	LDR biased	158.8	132.51	-26.293
56	30	LDR biased	159.21	133.39	-25.817
57	30	LDR biased	158.09	133.1	-24.99
58	30	LDR biased	158.95	133.39	-25.558
59	30	LDR biased	160.72	134.62	-26.096
60	20	LDR unbiased	159.08	156.53	-2.5425
61	20	LDR unbiased	158.86	156.44	-2.4192
62	20	LDR unbiased	159.09	157.3	-1.7971
63	20	LDR unbiased	159.48	156.8	-2.6745
64	20	LDR unbiased	159.16	157.15	-2.0067
65	30	LDR unbiased	157.13	152.94	-4.188
66	30	LDR unbiased	159.09	155.13	-3.9562
67	30	LDR unbiased	159.98	155.07	-4.909
68	30	LDR unbiased	157.71	153.78	-3.926
69	30	LDR unbiased	157.71	153.82	-3.8887
70	0	correlation	157.87	156.48	-1.391
71	0	correlation	159.99	158.04	-1.9454
72	0	correlation	160.18	158.84	-1.3383
73	0	correlation	160.17	158.69	-1.4853
74	0	correlation	158.62	157.86	-0.7687

TID vs Post - Pre Exposure Delta

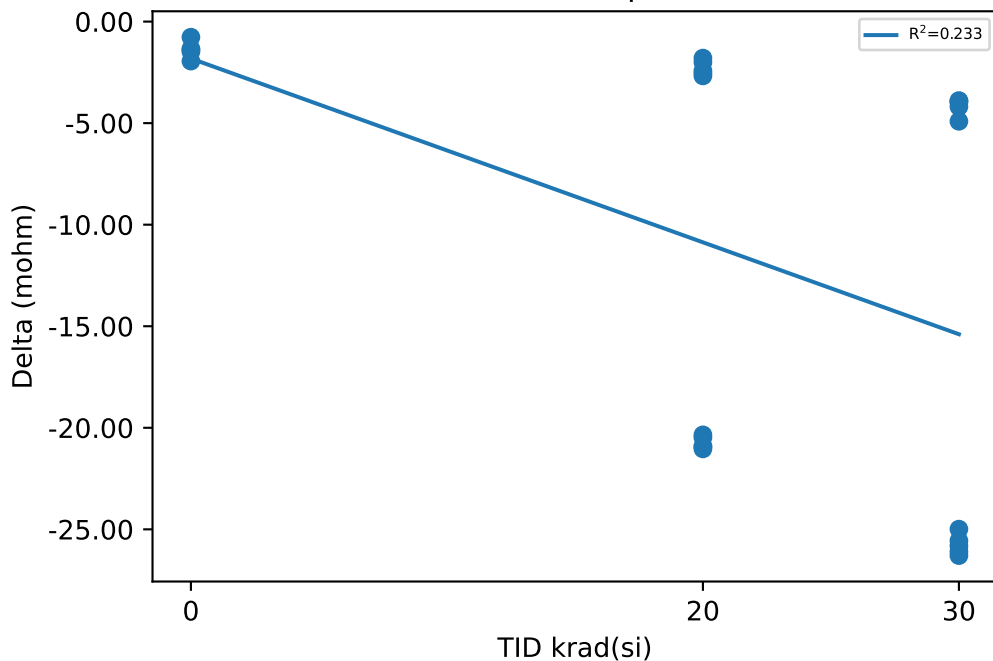

Test Statistics (mohm)

krad(si)	Pre Exposure Min	Pre Exposure Avg	Pre Exposure Max	Pre Exposure Std	Post Exposure Min	Post Exposure Avg	Post Exposure Max	Post Exposure Std	Min Delta	Avg Delta	Max Delta	Std Delta
0	157.87	159.37	160.18	1.0592	156.48	157.98	158.84	0.93729	-1.9454	-1.3857	-0.7687	0.42016
20	156.16	158.58	159.48	0.99759	135.67	147.07	157.3	10.331	-21.04	-11.515	-1.7971	9.7318
30	157.13	158.74	160.72	1.1051	132.51	143.78	155.13	10.964	-26.293	-14.962	-3.8887	11.381

Device Test: 12.8 UJ4ZR4(RDSON_32V_OUT2_UJE410_UJ4ZR4)

TID vs Result Stats

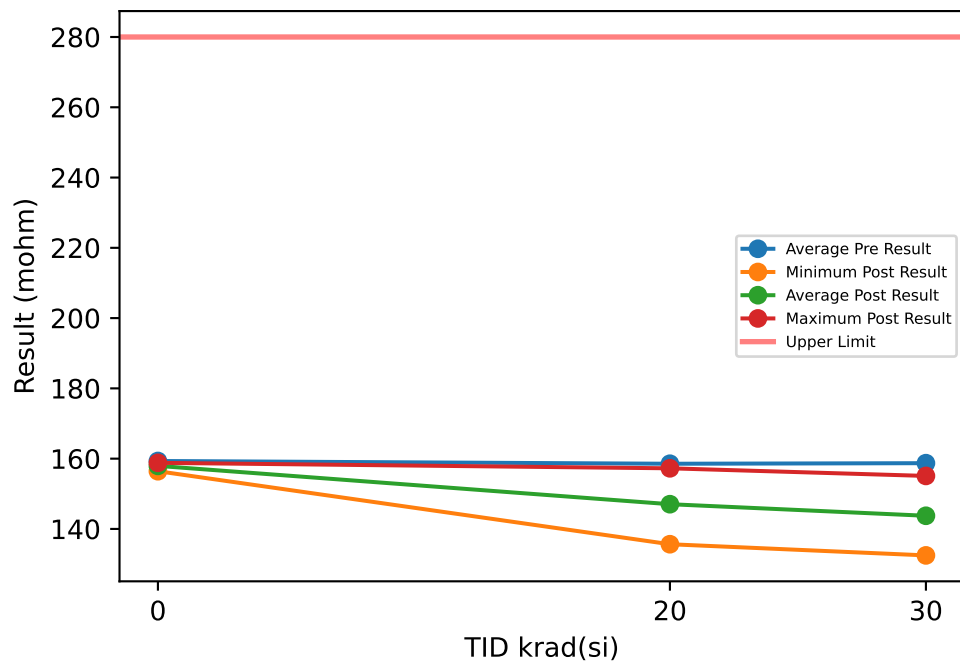

Test Results (Upper Limit = 280.0 (mohm))

Serial #	krad(si)	Exposure Conditions	Pre Result	Post Result	Delta
50	20	LDR biased	156.13	135.65	-20.483
51	20	LDR biased	159.25	138.22	-21.032
52	20	LDR biased	158.23	137.29	-20.944
53	20	LDR biased	158.7	137.81	-20.892
54	20	LDR biased	157.67	137.34	-20.33
55	30	LDR biased	158.78	132.47	-26.314
56	30	LDR biased	159.18	133.37	-25.815
57	30	LDR biased	158.06	133.07	-24.993
58	30	LDR biased	158.93	133.37	-25.558
59	30	LDR biased	160.7	134.6	-26.105
60	20	LDR unbiased	159.06	156.51	-2.5494
61	20	LDR unbiased	158.85	156.42	-2.4289
62	20	LDR unbiased	159.05	157.25	-1.7942
63	20	LDR unbiased	159.44	156.76	-2.6813
64	20	LDR unbiased	159.14	157.14	-1.9999
65	30	LDR unbiased	157.09	152.89	-4.2053
66	30	LDR unbiased	159.07	155.09	-3.9812
67	30	LDR unbiased	159.94	155.05	-4.8839
68	30	LDR unbiased	157.69	153.76	-3.9225
69	30	LDR unbiased	157.68	153.79	-3.8911
70	0	correlation	157.84	156.42	-1.4218
71	0	correlation	159.97	158.01	-1.964
72	0	correlation	160.14	158.81	-1.3325
73	0	correlation	160.13	158.65	-1.4786
74	0	correlation	158.58	157.82	-0.7565

TID vs Post - Pre Exposure Delta

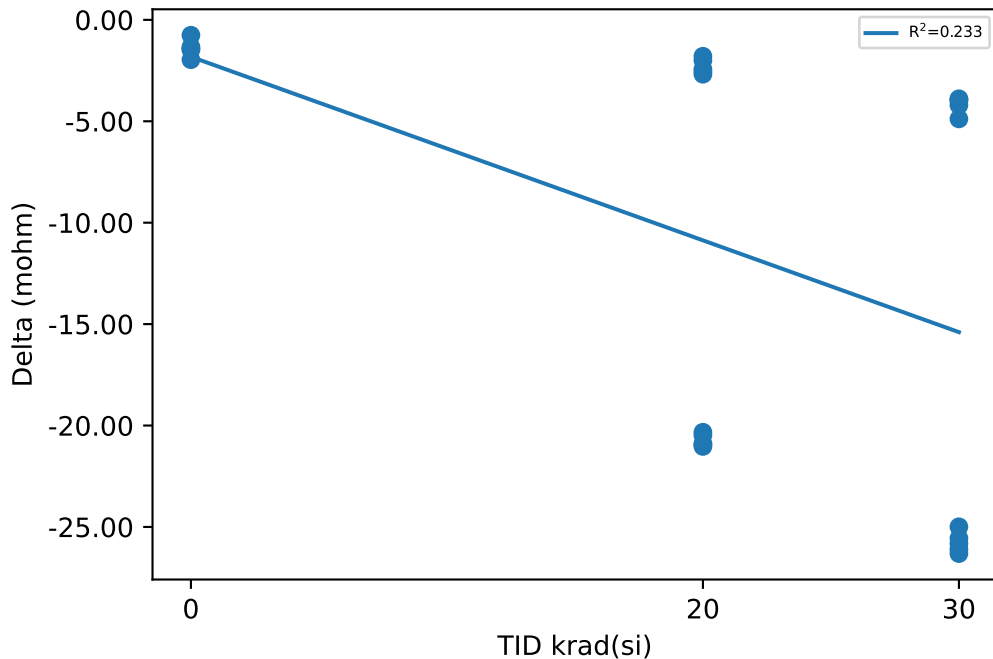

Test Statistics (mohm)

krad(si)	Pre Exposure Min	Pre Exposure Avg	Pre Exposure Max	Pre Exposure Std	Post Exposure Min	Post Exposure Avg	Post Exposure Max	Post Exposure Std	Min Delta	Avg Delta	Max Delta	Std Delta
0	157.84	159.33	160.14	1.0588	156.42	157.94	158.81	0.94636	-1.964	-1.3907	-0.7565	0.43098
20	156.13	158.55	159.44	0.99895	135.65	147.04	157.25	10.33	-21.032	-11.513	-1.7942	9.7269
30	157.09	158.71	160.7	1.107	132.47	143.75	155.09	10.962	-26.314	-14.967	-3.8911	11.382

Device Test: 12.9 UJ4ZR4(RDSON_5V_OUT3_UJE410_UJ4ZR4)

TID vs Result Stats

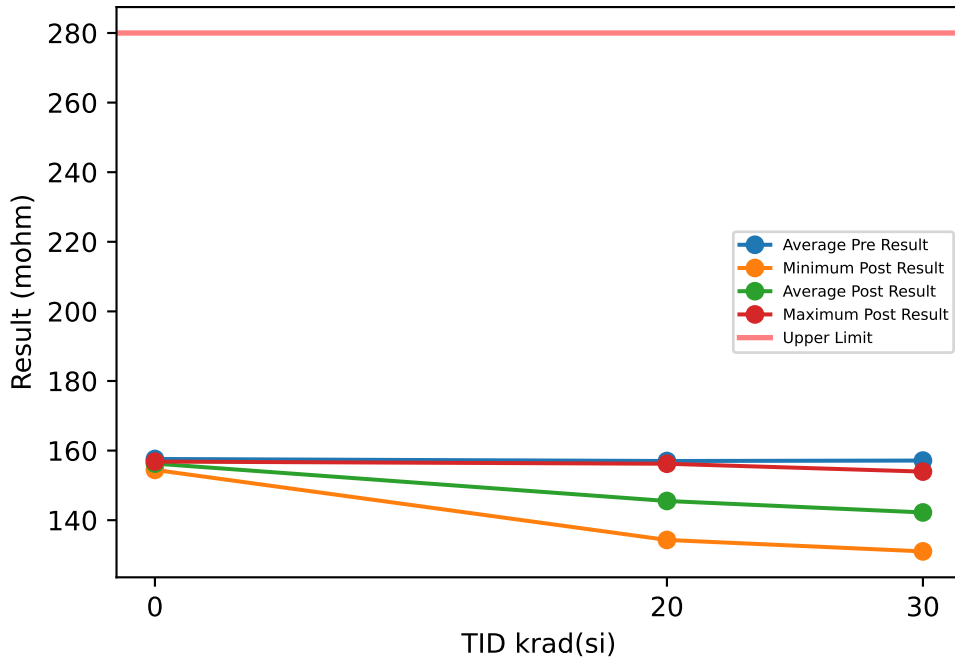

Test Results (Upper Limit = 280.0 (mohm))

Serial #	krad(si)	Exposure Conditions	Pre Result	Post Result	Delta
50	20	LDR biased	154.65	134.32	-20.328
51	20	LDR biased	158.07	136.93	-21.138
52	20	LDR biased	157.36	136.63	-20.729
53	20	LDR biased	156.97	136.21	-20.758
54	20	LDR biased	155.78	135.29	-20.49
55	30	LDR biased	157.35	131.03	-26.318
56	30	LDR biased	157.49	131.67	-25.825
57	30	LDR biased	156.28	131.34	-24.935
58	30	LDR biased	157.42	131.95	-25.463
59	30	LDR biased	160.11	133.75	-26.363
60	20	LDR unbiased	157.2	154.53	-2.669
61	20	LDR unbiased	157.44	155.09	-2.3474
62	20	LDR unbiased	157.95	156.22	-1.7346
63	20	LDR unbiased	157.65	155	-2.6455
64	20	LDR unbiased	157.03	154.95	-2.0828
65	30	LDR unbiased	154.92	151.05	-3.8753
66	30	LDR unbiased	158	153.96	-4.0422
67	30	LDR unbiased	158.42	153.63	-4.7945
68	30	LDR unbiased	155.27	151.58	-3.6938
69	30	LDR unbiased	156.06	152.25	-3.8129
70	0	correlation	155.94	154.44	-1.4976
71	0	correlation	158.59	156.68	-1.9063
72	0	correlation	158.3	156.83	-1.4629
73	0	correlation	157.71	156.73	-0.9772
74	0	correlation	157.41	156.61	-0.7969

TID vs Post - Pre Exposure Delta

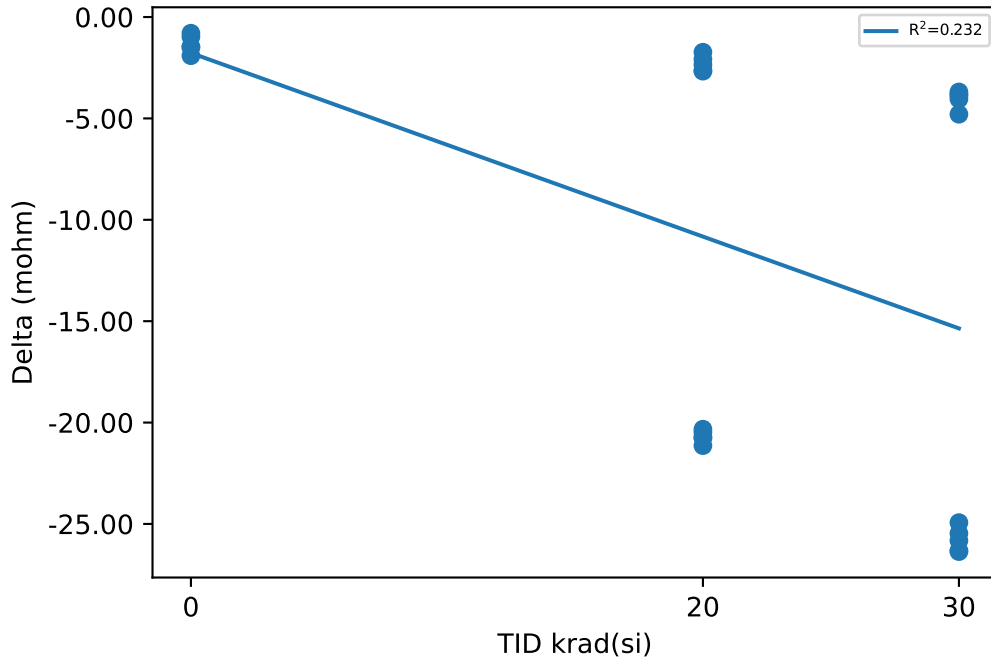

Test Statistics (mohm)

krad(si)	Pre Exposure Min	Pre Exposure Avg	Pre Exposure Max	Pre Exposure Std	Post Exposure Min	Post Exposure Avg	Post Exposure Max	Post Exposure Std	Min Delta	Avg Delta	Max Delta	Std Delta
0	155.94	157.59	158.59	1.0322	154.44	156.26	156.83	1.0192	-1.9063	-1.3282	-0.7969	0.44343
20	154.65	157.01	158.07	1.0456	134.32	145.52	156.22	10.196	-21.138	-11.492	-1.7346	9.6996
30	154.92	157.13	160.11	1.5562	131.03	142.22	153.96	10.883	-26.363	-14.912	-3.6938	11.467

Device Test: 14.2 UJUUDV(VDS_CLAMP_CH1_UJUUDV)

TID vs Result Stats

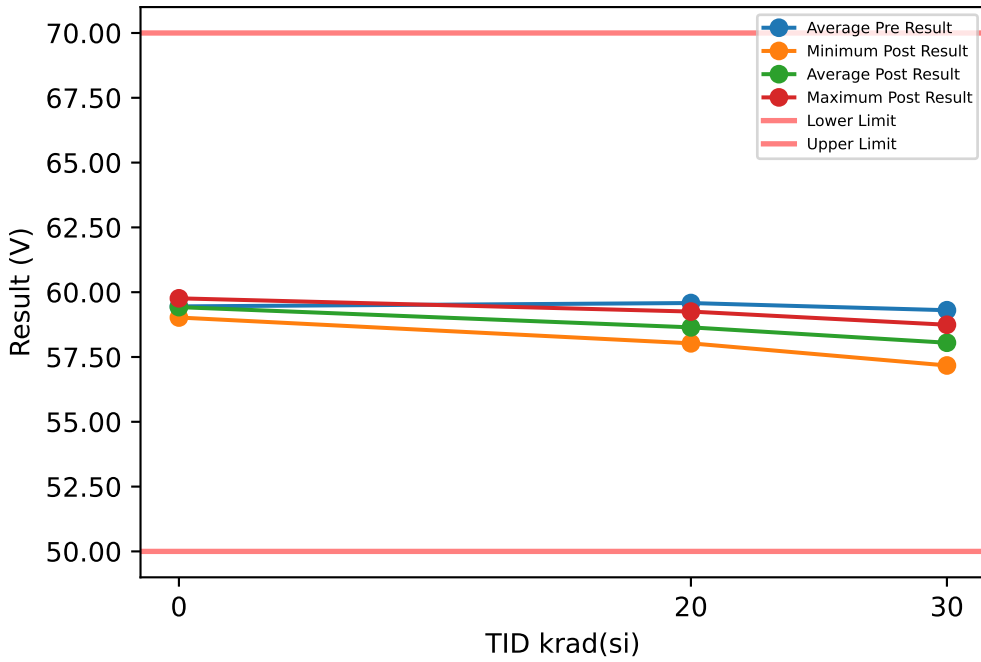

Test Results (Lower Limit = 50.0, Upper Limit = 70.0 (V))

Serial #	krad(si)	Exposure Conditions	Pre Result	Post Result	Delta
50	20	LDR biased	59.384	58.145	-1.239
51	20	LDR biased	59.641	58.435	-1.206
52	20	LDR biased	60.227	59.103	-1.124
53	20	LDR biased	59.591	58.549	-1.042
54	20	LDR biased	59.114	58.027	-1.087
55	30	LDR biased	59.671	57.863	-1.808
56	30	LDR biased	59.756	58.303	-1.453
57	30	LDR biased	59.362	57.913	-1.449
58	30	LDR biased	59.698	57.933	-1.765
59	30	LDR biased	59.513	57.936	-1.577
60	20	LDR unbiased	60.018	59.167	-0.851
61	20	LDR unbiased	59.602	58.923	-0.679
62	20	LDR unbiased	59.158	58.428	-0.73
63	20	LDR unbiased	59.133	58.404	-0.729
64	20	LDR unbiased	59.952	59.253	-0.699
65	30	LDR unbiased	58.509	57.591	-0.918
66	30	LDR unbiased	59.584	58.744	-0.84
67	30	LDR unbiased	59.62	58.687	-0.933
68	30	LDR unbiased	58.125	57.173	-0.952
69	30	LDR unbiased	59.209	58.359	-0.85
70	0	correlation	59.679	59.642	-0.037
71	0	correlation	59.487	59.439	-0.048
72	0	correlation	59.04	59.023	-0.017
73	0	correlation	59.782	59.764	-0.018
74	0	correlation	59.276	59.252	-0.024

TID vs Post - Pre Exposure Delta

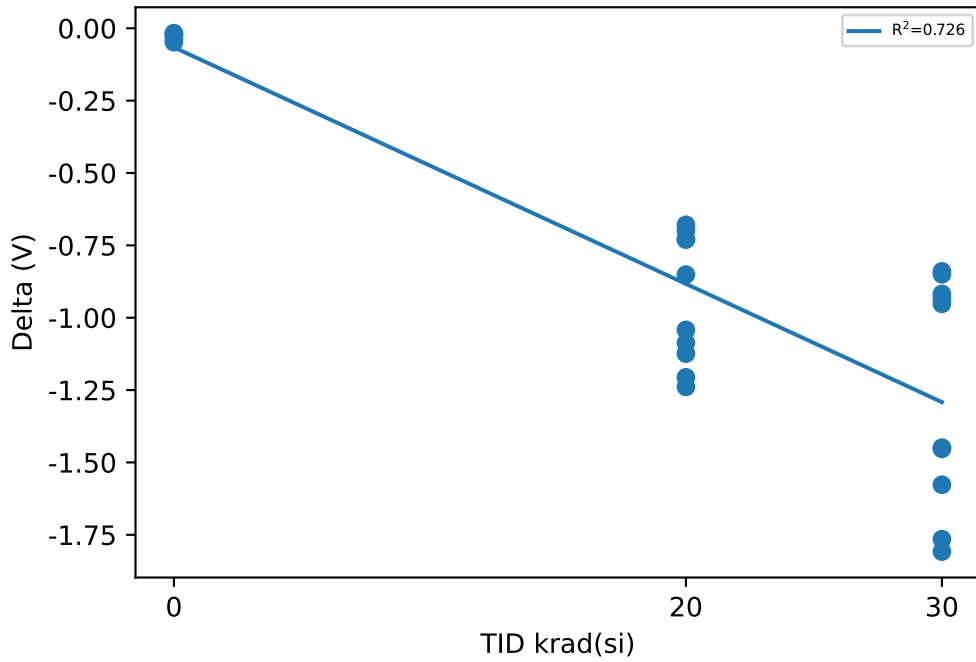

Test Statistics (V)

krad(si)	Pre Exposure Min	Pre Exposure Avg	Pre Exposure Max	Pre Exposure Std	Post Exposure Min	Post Exposure Avg	Post Exposure Max	Post Exposure Std	Min Delta	Avg Delta	Max Delta	Std Delta
0	59.04	59.453	59.782	0.30099	59.023	59.424	59.764	0.29738	-0.048	-0.0288	-0.017	0.013368
20	59.114	59.582	60.227	0.39251	58.027	58.643	59.253	0.43711	-1.239	-0.9386	-0.679	0.2233
30	58.125	59.305	59.756	0.55283	57.173	58.05	58.744	0.48386	-1.808	-1.2545	-0.84	0.39324

Device Test: 14.4 UJUUDV(VDS_CLAMP_CH2_UJUUDV)

TID vs Result Stats

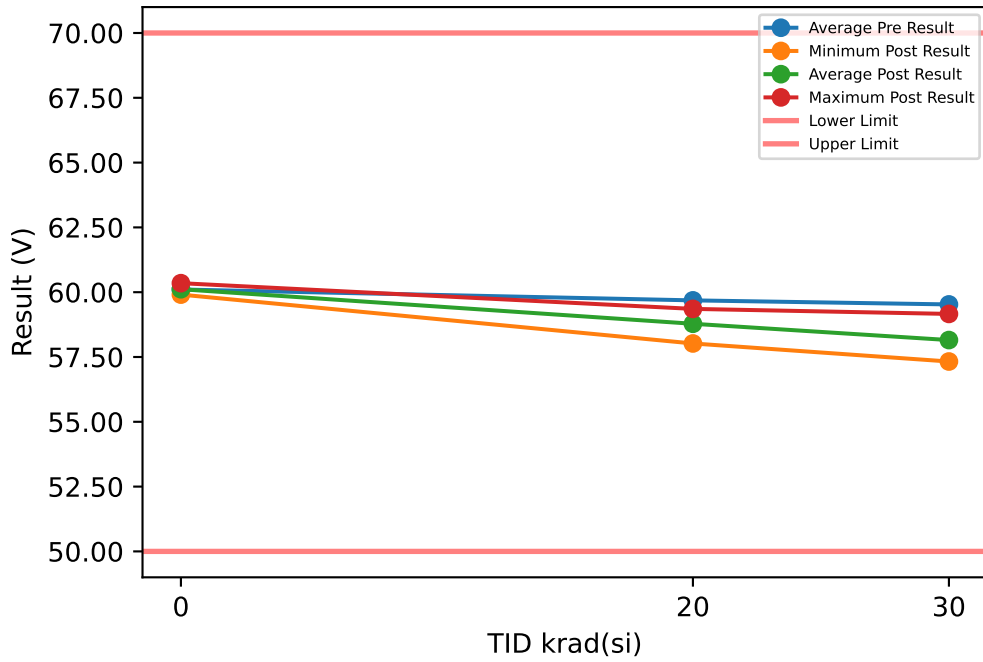

Test Results (Lower Limit = 50.0, Upper Limit = 70.0 (V))

Serial #	krad(si)	Exposure Conditions	Pre Result	Post Result	Delta
50	20	LDR biased	59.165	58.022	-1.143
51	20	LDR biased	59.417	58.292	-1.125
52	20	LDR biased	59.547	58.685	-0.862
53	20	LDR biased	59.484	58.496	-0.988
54	20	LDR biased	59.661	58.49	-1.171
55	30	LDR biased	59.513	57.705	-1.808
56	30	LDR biased	60.223	58.466	-1.757
57	30	LDR biased	59.311	57.957	-1.354
58	30	LDR biased	59.157	57.473	-1.684
59	30	LDR biased	59.119	57.326	-1.793
60	20	LDR unbiased	59.454	58.747	-0.707
61	20	LDR unbiased	60.061	59.356	-0.705
62	20	LDR unbiased	60.004	59.188	-0.816
63	20	LDR unbiased	60.081	59.21	-0.871
64	20	LDR unbiased	59.972	59.332	-0.64
65	30	LDR unbiased	59.023	58.087	-0.936
66	30	LDR unbiased	60.199	58.999	-1.2
67	30	LDR unbiased	60.29	59.162	-1.128
68	30	LDR unbiased	58.741	57.77	-0.971
69	30	LDR unbiased	59.71	58.589	-1.121
70	0	correlation	59.975	59.936	-0.039
71	0	correlation	60.23	60.139	-0.091
72	0	correlation	59.798	59.907	0.109
73	0	correlation	60.155	60.245	0.09
74	0	correlation	60.367	60.348	-0.019

TID vs Post - Pre Exposure Delta

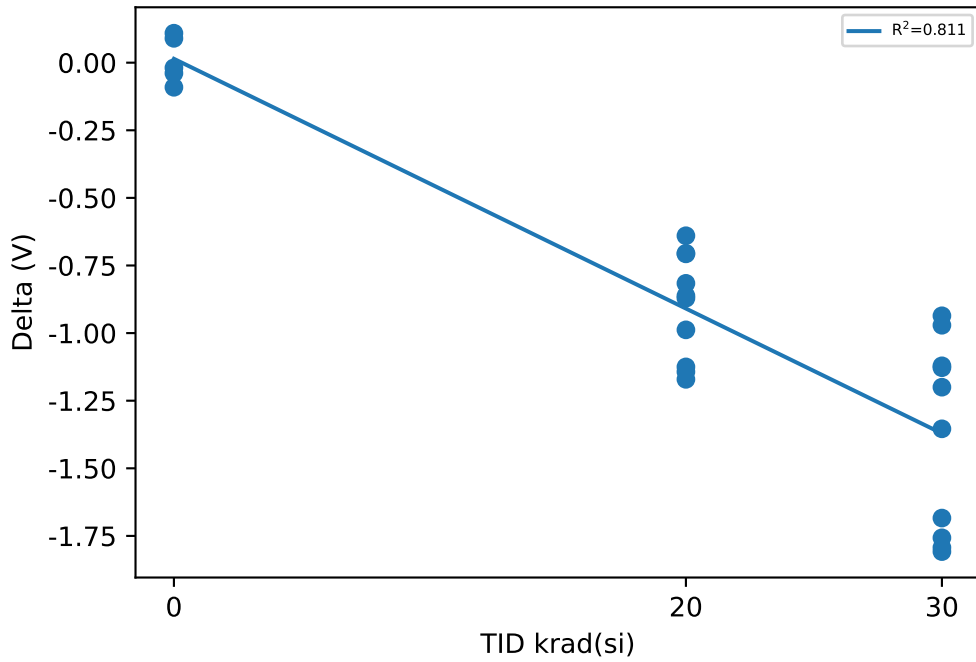

Test Statistics (V)

krad(si)	Pre Exposure Min	Pre Exposure Avg	Pre Exposure Max	Pre Exposure Std	Post Exposure Min	Post Exposure Avg	Post Exposure Max	Post Exposure Std	Min Delta	Avg Delta	Max Delta	Std Delta
0	59.798	60.105	60.367	0.22244	59.907	60.115	60.348	0.19175	-0.091	0.01	0.109	0.086087
20	59.165	59.685	60.081	0.32282	58.022	58.782	59.356	0.4685	-1.171	-0.9028	-0.64	0.19522
30	58.741	59.529	60.29	0.55514	57.326	58.153	59.162	0.62879	-1.808	-1.3752	-0.936	0.35216

Device Test: 14.6 UJUUDV(VDS_CLAMP_CH3_UJUUDV)

TID vs Result Stats

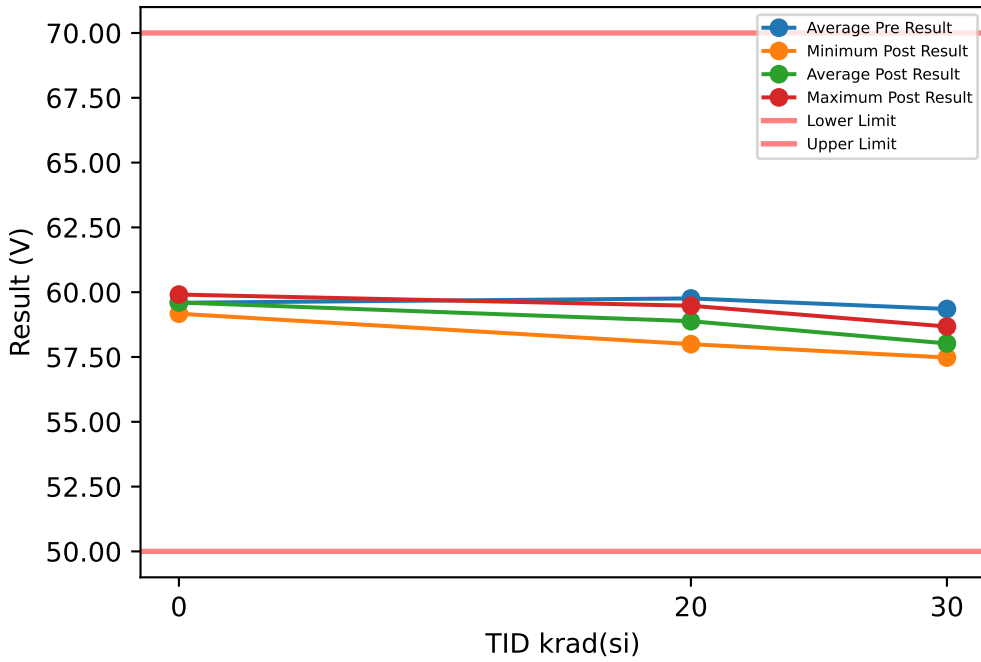

Test Results (Lower Limit = 50.0, Upper Limit = 70.0 (V))

Serial #	krad(si)	Exposure Conditions	Pre Result	Post Result	Delta
50	20	LDR biased	59.668	58.422	-1.246
51	20	LDR biased	59.803	58.752	-1.051
52	20	LDR biased	60.284	59.182	-1.102
53	20	LDR biased	59.923	58.864	-1.059
54	20	LDR biased	59.093	57.996	-1.097
55	30	LDR biased	59.765	57.94	-1.825
56	30	LDR biased	59.816	58.144	-1.672
57	30	LDR biased	59.333	57.848	-1.485
58	30	LDR biased	59.847	58.037	-1.81
59	30	LDR biased	59.513	57.839	-1.674
60	20	LDR unbiased	60.126	59.356	-0.77
61	20	LDR unbiased	59.666	59.156	-0.51
62	20	LDR unbiased	59.507	58.765	-0.742
63	20	LDR unbiased	59.397	58.844	-0.553
64	20	LDR unbiased	60.13	59.478	-0.652
65	30	LDR unbiased	58.425	57.576	-0.849
66	30	LDR unbiased	59.761	58.676	-1.085
67	30	LDR unbiased	59.563	58.603	-0.96
68	30	LDR unbiased	58.504	57.478	-1.026
69	30	LDR unbiased	59.004	58.087	-0.917
70	0	correlation	59.987	59.909	-0.078
71	0	correlation	59.506	59.57	0.064
72	0	correlation	59.212	59.17	-0.042
73	0	correlation	59.568	59.681	0.113
74	0	correlation	59.695	59.681	-0.014

TID vs Post - Pre Exposure Delta

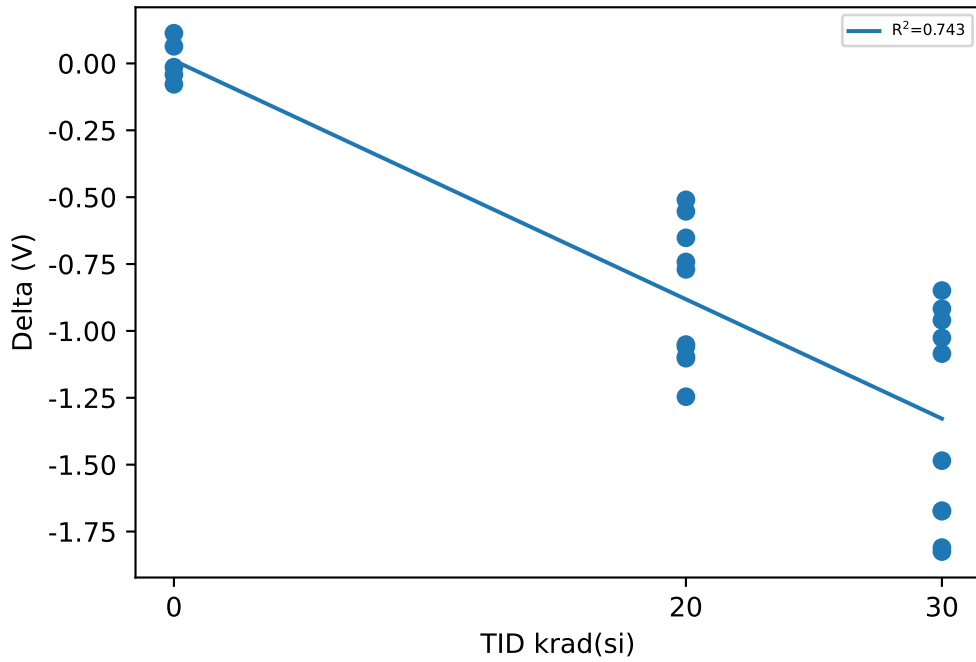

Test Statistics (V)

krad(si)	Pre Exposure Min	Pre Exposure Avg	Pre Exposure Max	Pre Exposure Std	Post Exposure Min	Post Exposure Avg	Post Exposure Max	Post Exposure Std	Min Delta	Avg Delta	Max Delta	Std Delta
0	59.212	59.594	59.987	0.2824	59.17	59.602	59.909	0.27128	-0.078	0.0086	0.113	0.078325
20	59.093	59.76	60.284	0.36996	57.996	58.882	59.478	0.44396	-1.246	-0.8782	-0.51	0.26216
30	58.425	59.353	59.847	0.53422	57.478	58.023	58.676	0.38729	-1.825	-1.3303	-0.849	0.39805

Device Test: 14.8 UJUUDV(VDS_CLAMP_CH4_UJUUDV)

TID vs Result Stats

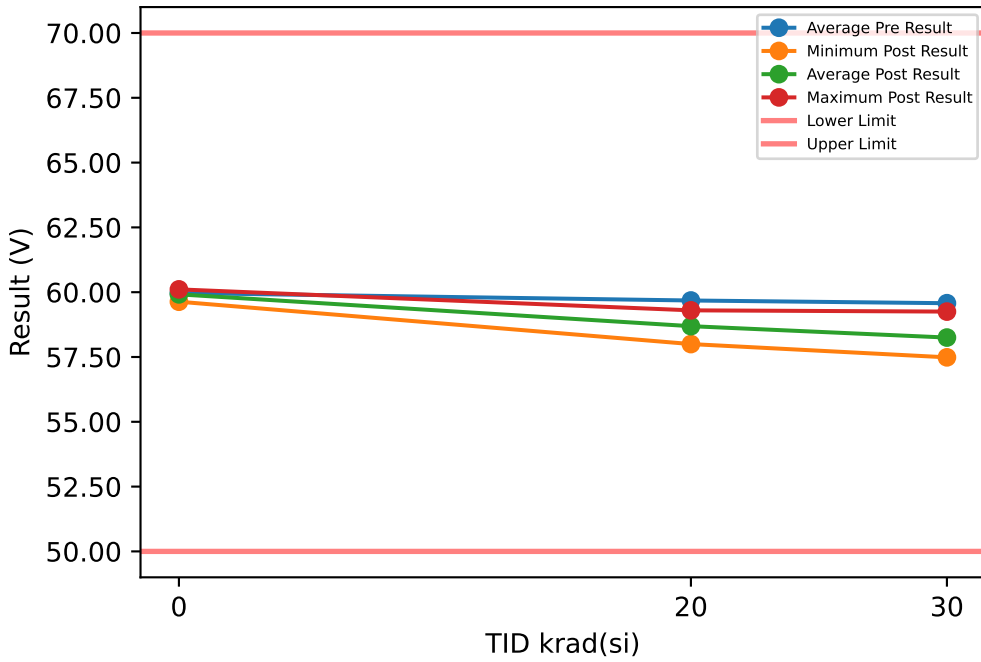

Test Results (Lower Limit = 50.0, Upper Limit = 70.0 (V))

Serial #	krad(si)	Exposure Conditions	Pre Result	Post Result	Delta
50	20	LDR biased	59.129	57.999	-1.13
51	20	LDR biased	59.301	58.184	-1.117
52	20	LDR biased	59.861	58.689	-1.172
53	20	LDR biased	59.518	58.397	-1.121
54	20	LDR biased	59.577	58.389	-1.188
55	30	LDR biased	59.449	57.741	-1.708
56	30	LDR biased	60.375	58.593	-1.782
57	30	LDR biased	59.385	57.889	-1.496
58	30	LDR biased	59.304	57.715	-1.589
59	30	LDR biased	59.01	57.487	-1.523
60	20	LDR unbiased	59.66	58.74	-0.92
61	20	LDR unbiased	60.072	59.3	-0.772
62	20	LDR unbiased	59.769	58.976	-0.793
63	20	LDR unbiased	59.898	59.118	-0.78
64	20	LDR unbiased	60.015	59.1	-0.915
65	30	LDR unbiased	59.065	57.999	-1.066
66	30	LDR unbiased	60.209	59.226	-0.983
67	30	LDR unbiased	60.242	59.252	-0.99
68	30	LDR unbiased	59.202	58.027	-1.175
69	30	LDR unbiased	59.512	58.571	-0.941
70	0	correlation	59.674	59.633	-0.041
71	0	correlation	60.098	60.061	-0.037
72	0	correlation	59.989	59.83	-0.159
73	0	correlation	60.113	60.109	-0.004
74	0	correlation	59.968	59.952	-0.016

TID vs Post - Pre Exposure Delta

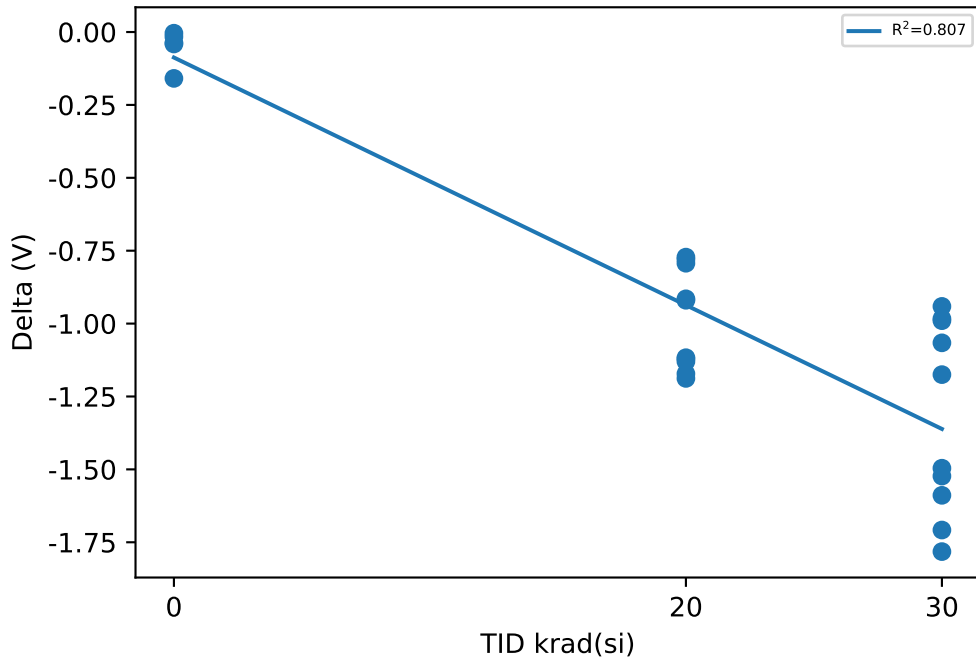

Test Statistics (V)

krad(si)	Pre Exposure Min	Pre Exposure Avg	Pre Exposure Max	Pre Exposure Std	Post Exposure Min	Post Exposure Avg	Post Exposure Max	Post Exposure Std	Min Delta	Avg Delta	Max Delta	Std Delta
0	59.674	59.968	60.113	0.17664	59.633	59.917	60.109	0.19174	-0.159	-0.0514	-0.004	0.062035
20	59.129	59.68	60.072	0.30525	57.999	58.689	59.3	0.43686	-1.188	-0.9908	-0.772	0.17197
30	59.01	59.575	60.375	0.50932	57.487	58.25	59.252	0.62785	-1.782	-1.3253	-0.941	0.32658

Device Test: 15.1 UJ33GQ(TON_DELAY_CH1_UJ33GQ)

TID vs Result Stats

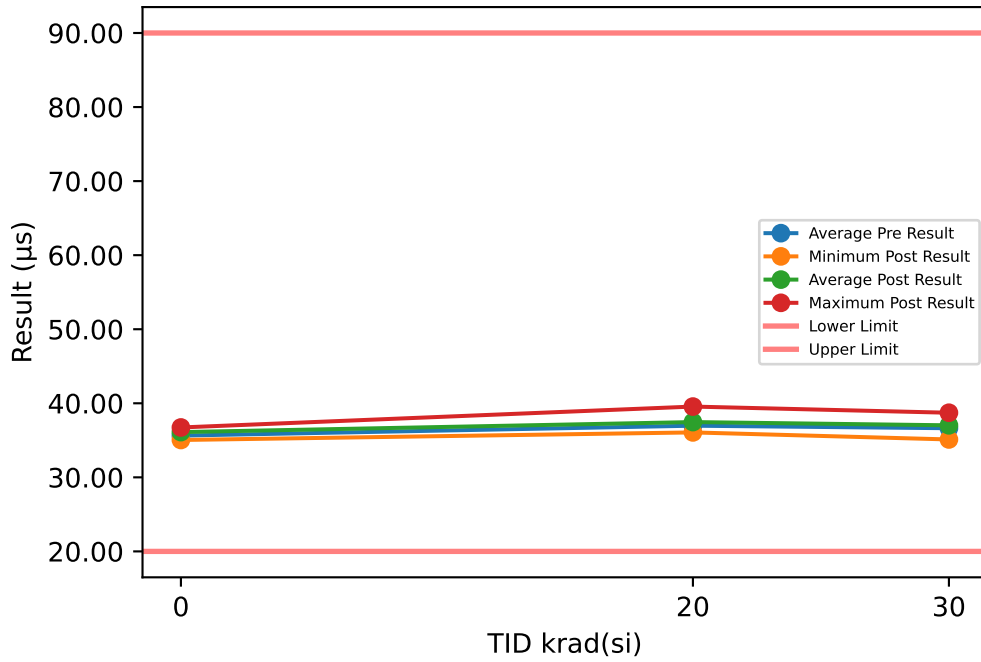

TID vs Post - Pre Exposure Delta

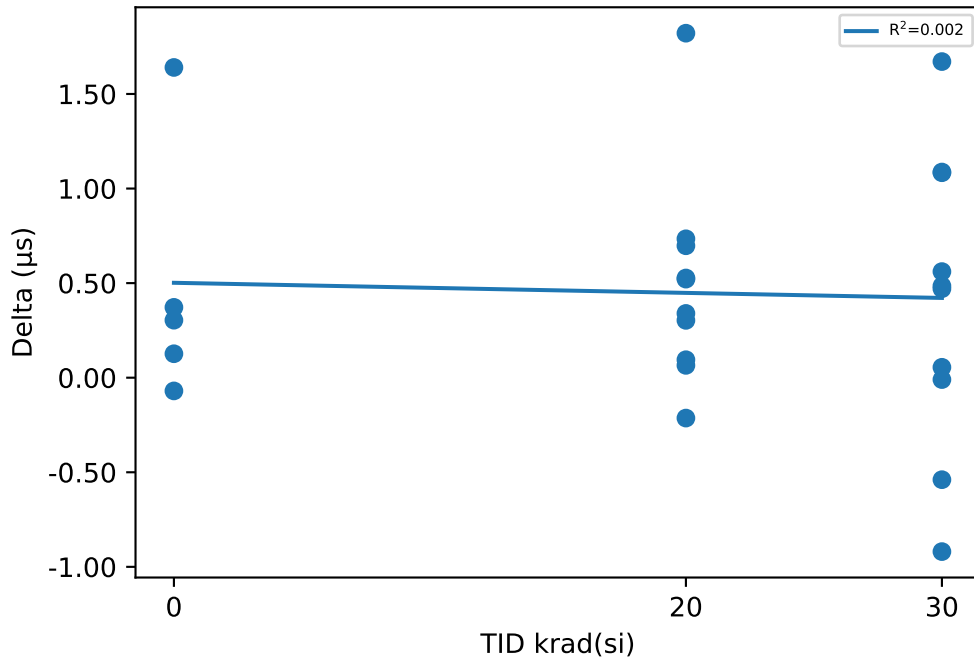

Test Results (Lower Limit = 20.0, Upper Limit = 90.0 (µs))

Serial #	krad(si)	Exposure Conditions	Pre Result	Post Result	Delta
50	20	LDR biased	35.333	36.067	0.7343
51	20	LDR biased	37.607	37.947	0.3398
52	20	LDR biased	36.312	38.133	1.8213
53	20	LDR biased	38.018	38.539	0.5211
54	20	LDR biased	38.859	39.556	0.6975
55	30	LDR biased	38.063	38.053	-0.0099
56	30	LDR biased	34.786	36.458	1.6713
57	30	LDR biased	35.976	35.437	-0.5392
58	30	LDR biased	36.983	37.468	0.485
59	30	LDR biased	36.257	36.727	0.4703
60	20	LDR unbiased	35.611	36.138	0.5271
61	20	LDR unbiased	37.46	37.526	0.0652
62	20	LDR unbiased	37.147	36.934	-0.2135
63	20	LDR unbiased	36.549	36.644	0.095
64	20	LDR unbiased	36.836	37.139	0.3031
65	30	LDR unbiased	36.955	37.516	0.561
66	30	LDR unbiased	36.291	36.346	0.055
67	30	LDR unbiased	37.33	38.413	1.0836
68	30	LDR unbiased	37.636	38.723	1.0873
69	30	LDR unbiased	36.035	35.116	-0.9194
70	0	correlation	36.1	36.03	-0.0699
71	0	correlation	35.094	36.734	1.6402
72	0	correlation	34.672	35.044	0.3719
73	0	correlation	36.31	36.614	0.304
74	0	correlation	35.996	36.122	0.1266

Test Statistics (µs)

krad(si)	Pre Exposure Min	Pre Exposure Avg	Pre Exposure Max	Pre Exposure Std	Post Exposure Min	Post Exposure Avg	Post Exposure Max	Post Exposure Std	Min Delta	Avg Delta	Max Delta	Std Delta
0	34.672	35.634	36.31	0.71116	35.044	36.109	36.734	0.66833	-0.0699	0.47456	1.6402	0.67377
20	35.333	36.973	38.859	1.0801	36.067	37.462	39.556	1.1049	-0.2135	0.48909	1.8213	0.55441
30	34.786	36.631	38.063	0.95557	35.116	37.026	38.723	1.2176	-0.9194	0.3945	1.6713	0.78199

Device Test: 15.10 UJP09Y(TRISE_CH2_UJP09Y)

TID vs Result Stats

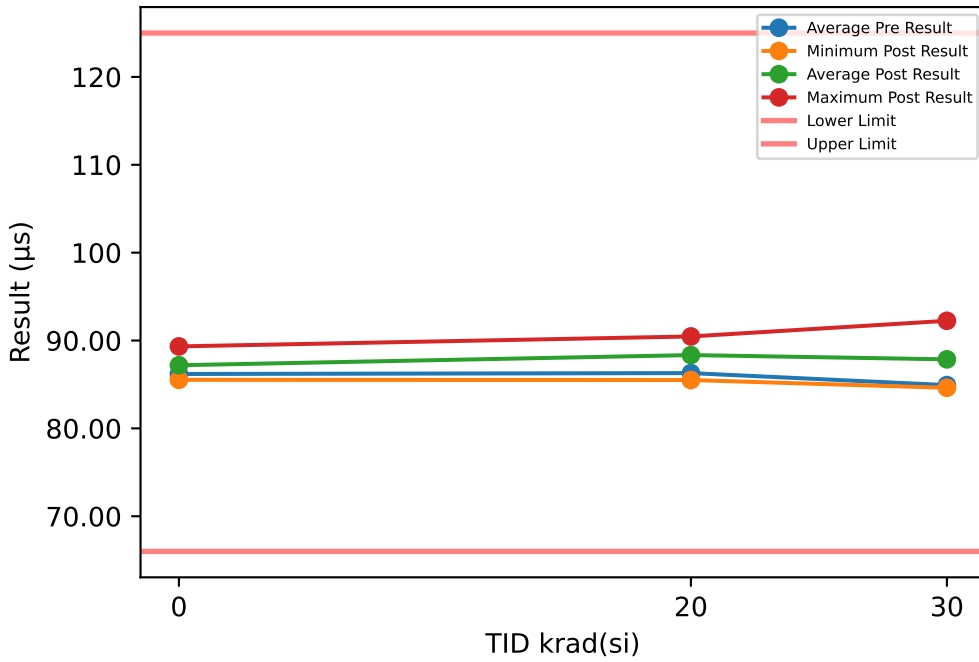

Test Results (Lower Limit = 66.0, Upper Limit = 125.0 (µs))

Serial #	krad(si)	Exposure Conditions	Pre Result	Post Result	Delta
50	20	LDR biased	86.141	88.207	2.0664
51	20	LDR biased	84.031	86.361	2.3301
52	20	LDR biased	82.282	85.503	3.2214
53	20	LDR biased	89.258	89.701	0.4437
54	20	LDR biased	88.519	90.255	1.7364
55	30	LDR biased	82.449	86.966	4.5168
56	30	LDR biased	85.503	86.653	1.1501
57	30	LDR biased	83.944	86.868	2.9239
58	30	LDR biased	90.405	92.244	1.839
59	30	LDR biased	81.513	84.619	3.1052
60	20	LDR unbiased	87.207	90.426	3.2193
61	20	LDR unbiased	88.715	90.463	1.7486
62	20	LDR unbiased	84.413	85.809	1.396
63	20	LDR unbiased	85.26	87.002	1.742
64	20	LDR unbiased	87.1	89.71	2.6104
65	30	LDR unbiased	87.834	91.313	3.4796
66	30	LDR unbiased	83.564	84.897	1.3329
67	30	LDR unbiased	85.642	90.573	4.9308
68	30	LDR unbiased	83.858	88.173	4.3152
69	30	LDR unbiased	84.535	86.275	1.7403
70	0	correlation	85.06	85.526	0.4661
71	0	correlation	84.716	86.695	1.9787
72	0	correlation	83.795	85.635	1.8402
73	0	correlation	88.334	88.738	0.4038
74	0	correlation	89.052	89.331	0.2796

TID vs Post - Pre Exposure Delta

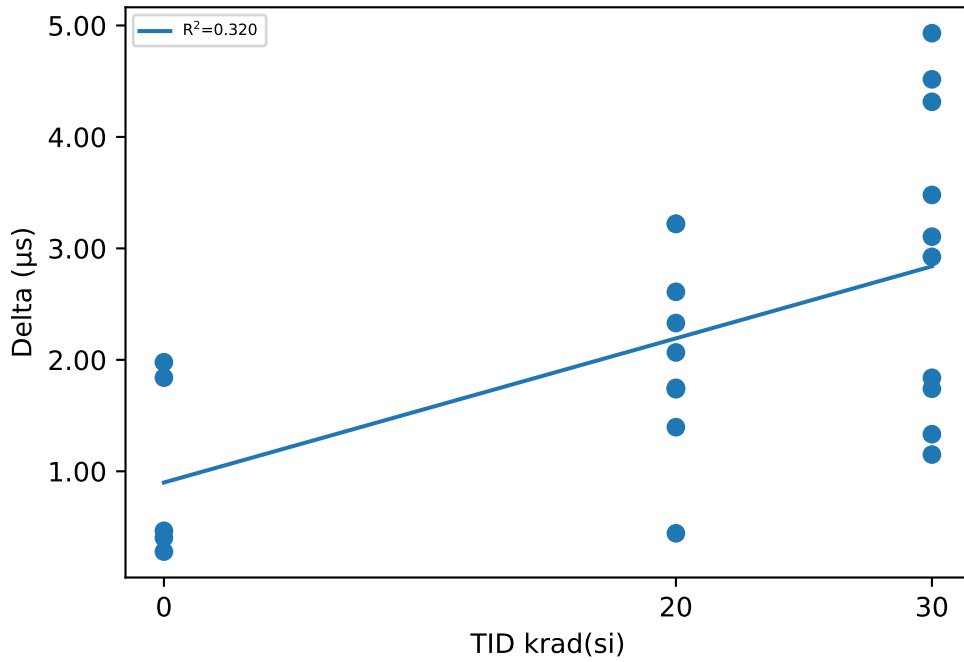

Test Statistics (µs)

krad(si)	Pre Exposure Min	Pre Exposure Avg	Pre Exposure Max	Pre Exposure Std	Post Exposure Min	Post Exposure Avg	Post Exposure Max	Post Exposure Std	Min Delta	Avg Delta	Max Delta	Std Delta
0	83.795	86.191	89.052	2.3437	85.526	87.185	89.331	1.7616	0.2796	0.99368	1.9787	0.8401
20	82.282	86.292	89.258	2.2835	85.503	88.344	90.463	2.0122	0.4437	2.0514	3.2214	0.84486
30	81.513	84.925	90.405	2.6081	84.619	87.858	92.244	2.6592	1.1501	2.9334	4.9308	1.3783

Device Test: 15.11 UJ6AIM(TFALL_CH2_UJ6AIM)

TID vs Result Stats

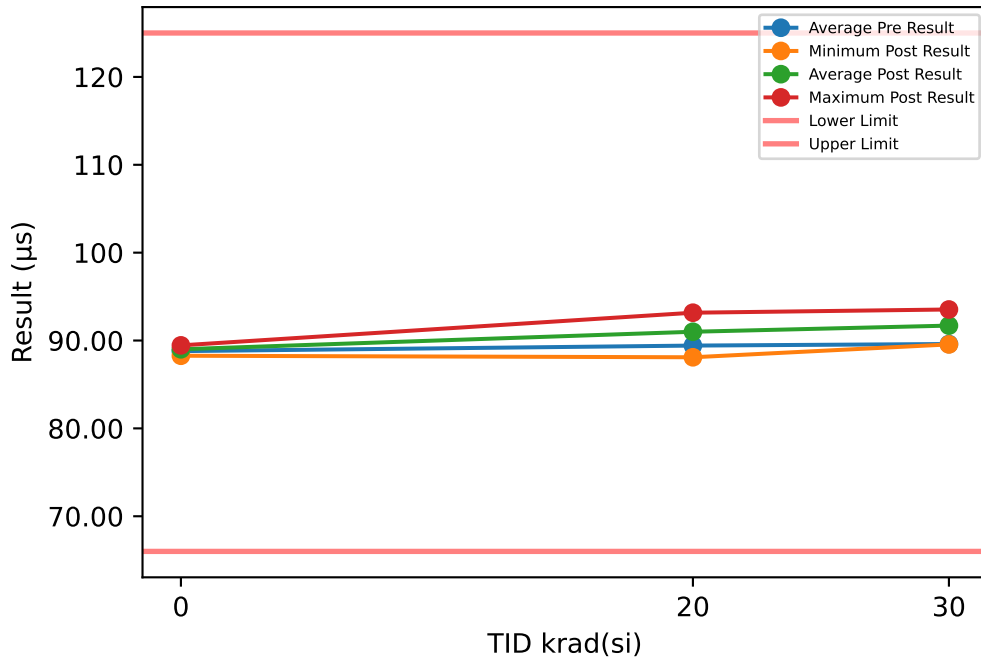

TID vs Post - Pre Exposure Delta

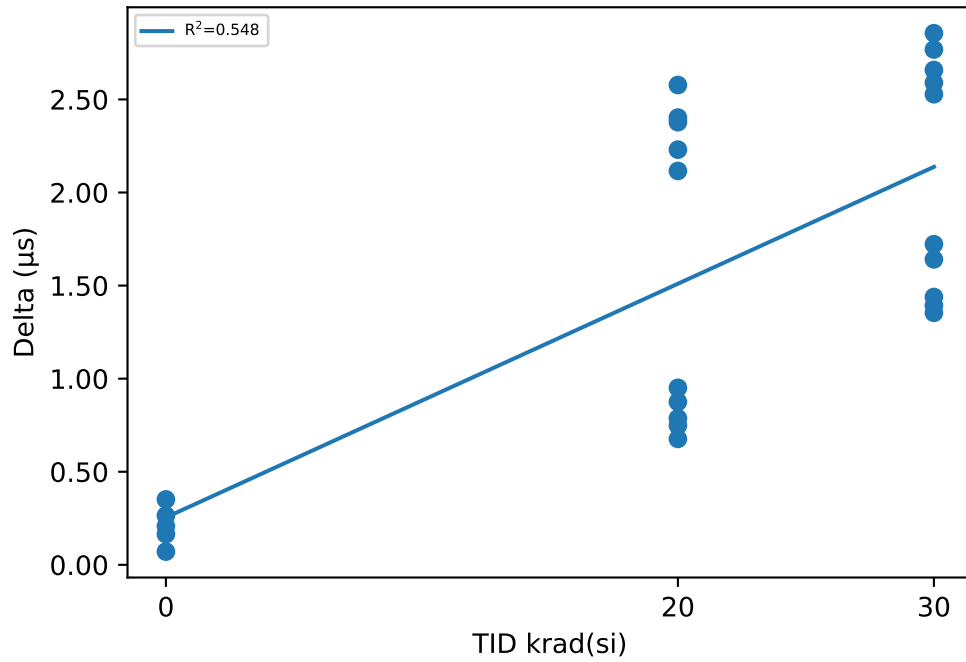

Test Results (Lower Limit = 66.0, Upper Limit = 125.0 (µs))

Serial #	krad(si)	Exposure Conditions	Pre Result	Post Result	Delta
50	20	LDR biased	90.417	92.533	2.1159
51	20	LDR biased	89.866	92.244	2.3777
52	20	LDR biased	90.588	93.165	2.5775
53	20	LDR biased	88.444	90.846	2.4024
54	20	LDR biased	90.253	92.483	2.2303
55	30	LDR biased	89.054	91.581	2.5279
56	30	LDR biased	88.644	91.5	2.8558
57	30	LDR biased	90.943	93.533	2.5899
58	30	LDR biased	88.166	90.935	2.7683
59	30	LDR biased	90.099	92.757	2.6581
60	20	LDR unbiased	87.681	88.632	0.9508
61	20	LDR unbiased	88.667	89.543	0.8754
62	20	LDR unbiased	91.07	91.856	0.7868
63	20	LDR unbiased	89.839	90.588	0.749
64	20	LDR unbiased	87.417	88.094	0.6764
65	30	LDR unbiased	90.964	92.605	1.6409
66	30	LDR unbiased	88.468	89.861	1.3931
67	30	LDR unbiased	88.203	89.557	1.3538
68	30	LDR unbiased	90.676	92.399	1.7224
69	30	LDR unbiased	90.806	92.245	1.4386
70	0	correlation	88.838	89.189	0.3513
71	0	correlation	89.241	89.448	0.2075
72	0	correlation	88.104	88.268	0.1648
73	0	correlation	89.115	89.38	0.2647
74	0	correlation	88.666	88.737	0.0711

Test Statistics (µs)

krad(si)	Pre Exposure Min	Pre Exposure Avg	Pre Exposure Max	Pre Exposure Std	Post Exposure Min	Post Exposure Avg	Post Exposure Max	Post Exposure Std	Min Delta	Avg Delta	Max Delta	Std Delta
0	88.104	88.793	89.241	0.44661	88.268	89.005	89.448	0.49637	0.0711	0.21188	0.3513	0.10522
20	87.417	89.424	91.07	1.2781	88.094	90.998	93.165	1.7604	0.6764	1.5742	2.5775	0.81962
30	88.166	89.602	90.964	1.203	89.557	91.697	93.533	1.2778	1.3538	2.0949	2.8558	0.63241

Device Test: 15.12 UJPEEL(SLEWRATE_ON_CH2_UJPEEL)

TID vs Result Stats

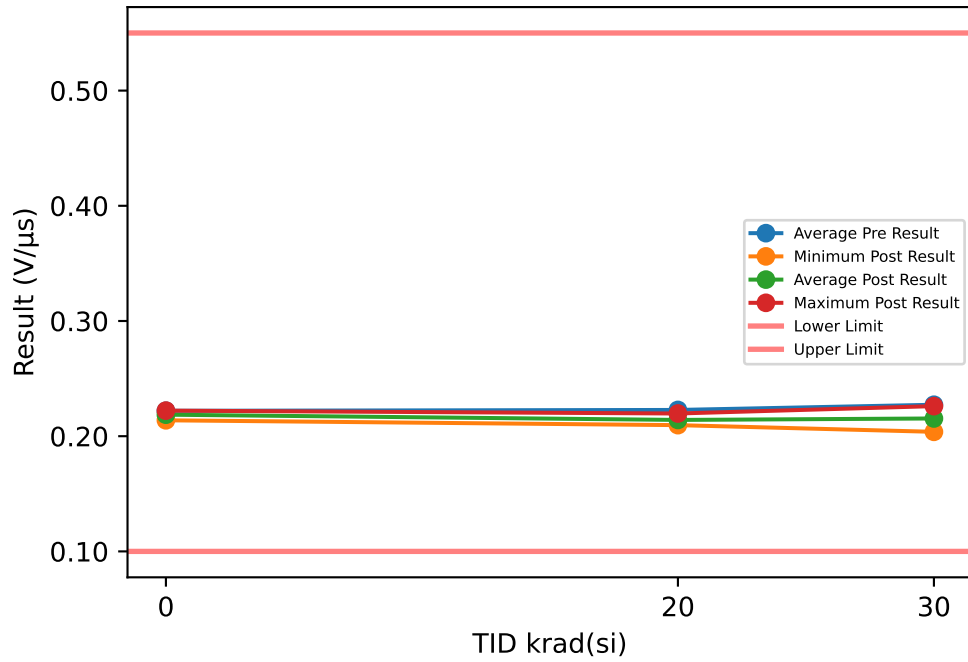

Test Results (Lower Limit = 0.1, Upper Limit = 0.55 (V/μs))

Serial #	krad(si)	Exposure Conditions	Pre Result	Post Result	Delta
50	20	LDR biased	0.2228	0.217	-0.0058
51	20	LDR biased	0.2309	0.2195	-0.0114
52	20	LDR biased	0.2308	0.2197	-0.0111
53	20	LDR biased	0.2176	0.2121	-0.0055
54	20	LDR biased	0.217	0.21	-0.007
55	30	LDR biased	0.2362	0.2181	-0.0181
56	30	LDR biased	0.2273	0.2199	-0.0074
57	30	LDR biased	0.2269	0.2155	-0.0114
58	30	LDR biased	0.2123	0.2038	-0.0085
59	30	LDR biased	0.2383	0.2261	-0.0122
60	20	LDR unbiased	0.2213	0.2096	-0.0117
61	20	LDR unbiased	0.2174	0.2116	-0.0058
62	20	LDR unbiased	0.2228	0.2158	-0.007
63	20	LDR unbiased	0.2259	0.2148	-0.0111
64	20	LDR unbiased	0.2214	0.2111	-0.0103
65	30	LDR unbiased	0.2189	0.2045	-0.0144
66	30	LDR unbiased	0.2279	0.2233	-0.0046
67	30	LDR unbiased	0.2199	0.2041	-0.0158
68	30	LDR unbiased	0.2338	0.216	-0.0178
69	30	LDR unbiased	0.2314	0.2226	-0.0088
70	0	correlation	0.2237	0.2222	-0.0015
71	0	correlation	0.2276	0.2208	-0.0068
72	0	correlation	0.2263	0.2206	-0.0057
73	0	correlation	0.2157	0.2138	-0.0019
74	0	correlation	0.2169	0.216	-0.0009

TID vs Post - Pre Exposure Delta

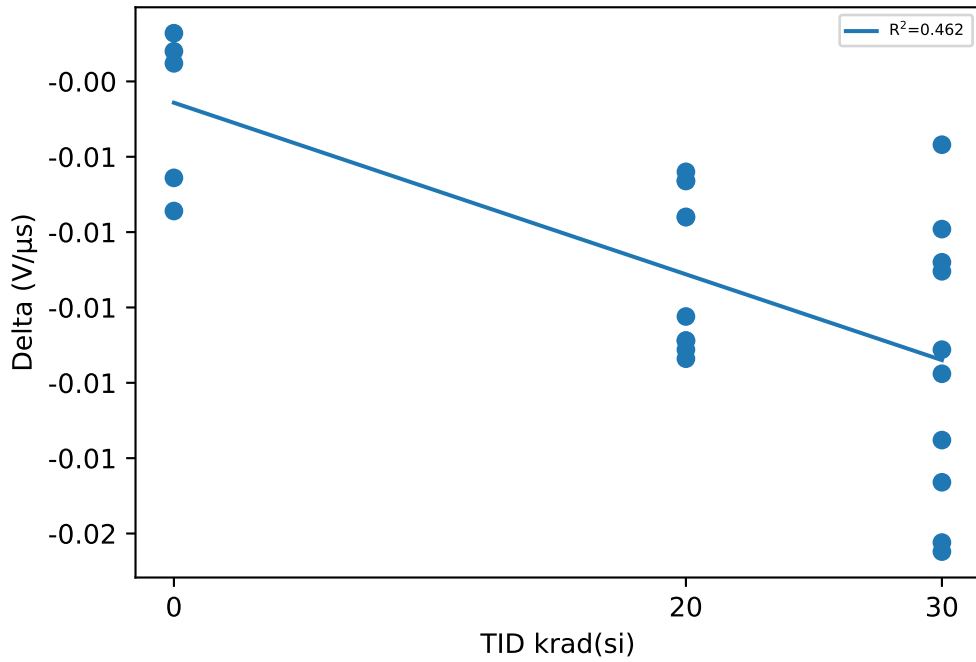

Test Statistics (V/μs)

krad(si)	Pre Exposure Min	Pre Exposure Avg	Pre Exposure Max	Pre Exposure Std	Post Exposure Min	Post Exposure Avg	Post Exposure Max	Post Exposure Std	Min Delta	Avg Delta	Max Delta	Std Delta
0	0.2157	0.22204	0.2276	0.0054413	0.2138	0.21868	0.2222	0.0035905	-0.0068	-0.00336	-0.0009	0.0026904
20	0.217	0.22279	0.2309	0.005091	0.2096	0.21412	0.2197	0.0037803	-0.0117	-0.00867	-0.0055	0.00265
30	0.2123	0.22729	0.2383	0.0082335	0.2038	0.21539	0.2261	0.0084176	-0.0181	-0.0119	-0.0046	0.0045918

Device Test: 15.13 UJD80I(SLEWRATE_OFF_CH2_UJD80I)

TID vs Result Stats

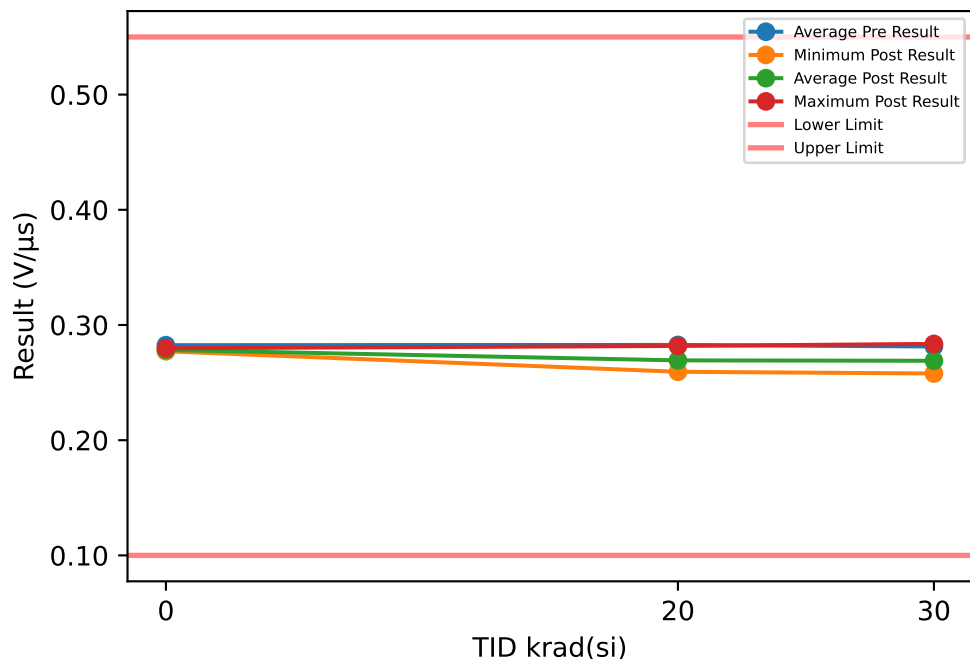

TID vs Post - Pre Exposure Delta

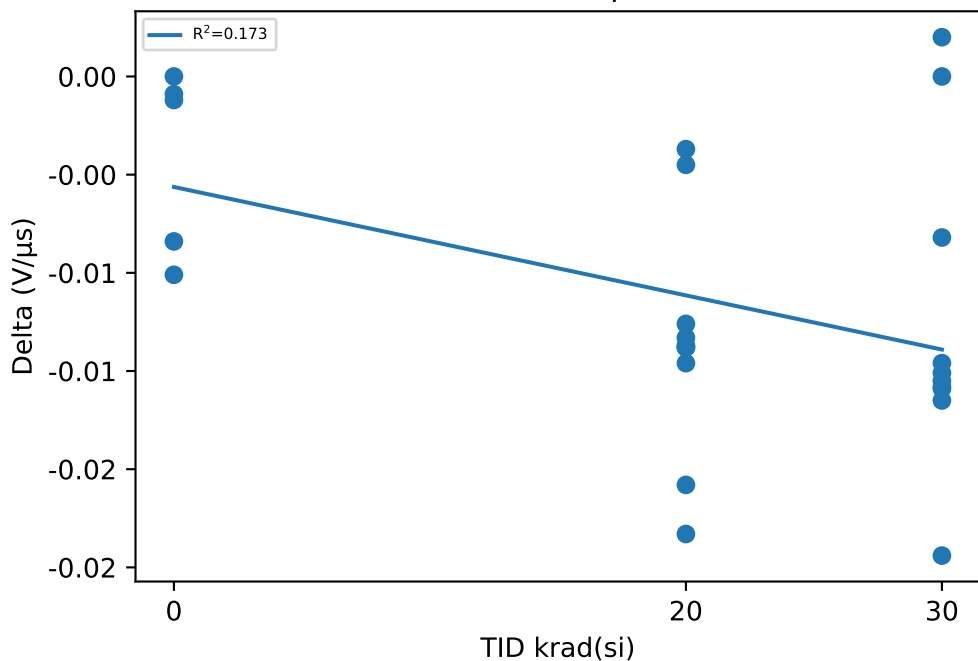

Test Results (Lower Limit = 0.1, Upper Limit = 0.55 (V/μs))

Serial #	krad(si)	Exposure Conditions	Pre Result	Post Result	Delta
50	20	LDR biased	0.2833	0.2695	-0.0138
51	20	LDR biased	0.2827	0.2594	-0.0233
52	20	LDR biased	0.2827	0.2619	-0.0208
53	20	LDR biased	0.2795	0.2658	-0.0137
54	20	LDR biased	0.2749	0.2611	-0.0138
55	30	LDR biased	0.2891	0.2647	-0.0244
56	30	LDR biased	0.2882	0.2727	-0.0155
57	30	LDR biased	0.273	0.2579	-0.0151
58	30	LDR biased	0.281	0.2652	-0.0158
59	30	LDR biased	0.2786	0.2621	-0.0165
60	20	LDR unbiased	0.2928	0.2795	-0.0133
61	20	LDR unbiased	0.2815	0.277	-0.0045
62	20	LDR unbiased	0.27	0.2663	-0.0037
63	20	LDR unbiased	0.2831	0.2705	-0.0126
64	20	LDR unbiased	0.2964	0.2818	-0.0146
65	30	LDR unbiased	0.2761	0.2679	-0.0082
66	30	LDR unbiased	0.2816	0.2836	0.002
67	30	LDR unbiased	0.292	0.2761	-0.0159
68	30	LDR unbiased	0.2772	0.2626	-0.0146
69	30	LDR unbiased	0.2766	0.2766	0
70	0	correlation	0.2784	0.2772	-0.0012
71	0	correlation	0.2879	0.2778	-0.0101
72	0	correlation	0.2882	0.2798	-0.0084
73	0	correlation	0.2778	0.2778	0
74	0	correlation	0.2801	0.2792	-0.0009

Test Statistics (V/μs)

krad(si)	Pre Exposure Min	Pre Exposure Avg	Pre Exposure Max	Pre Exposure Std	Post Exposure Min	Post Exposure Avg	Post Exposure Max	Post Exposure Std	Min Delta	Avg Delta	Max Delta	Std Delta
0	0.2778	0.28248	0.2882	0.0051553	0.2772	0.27836	0.2798	0.00109	-0.0101	-0.00412	0	0.004742
20	0.27	0.28269	0.2964	0.0076306	0.2594	0.26928	0.2818	0.0079044	-0.0233	-0.01341	-0.0037	0.0060422
30	0.273	0.28134	0.292	0.0063703	0.2579	0.26894	0.2836	0.008034	-0.0244	-0.0124	0.002	0.0080631

Device Test: 15.14 UJHGWM(TMATCH_CH2_UJHGWM)

TID vs Result Stats

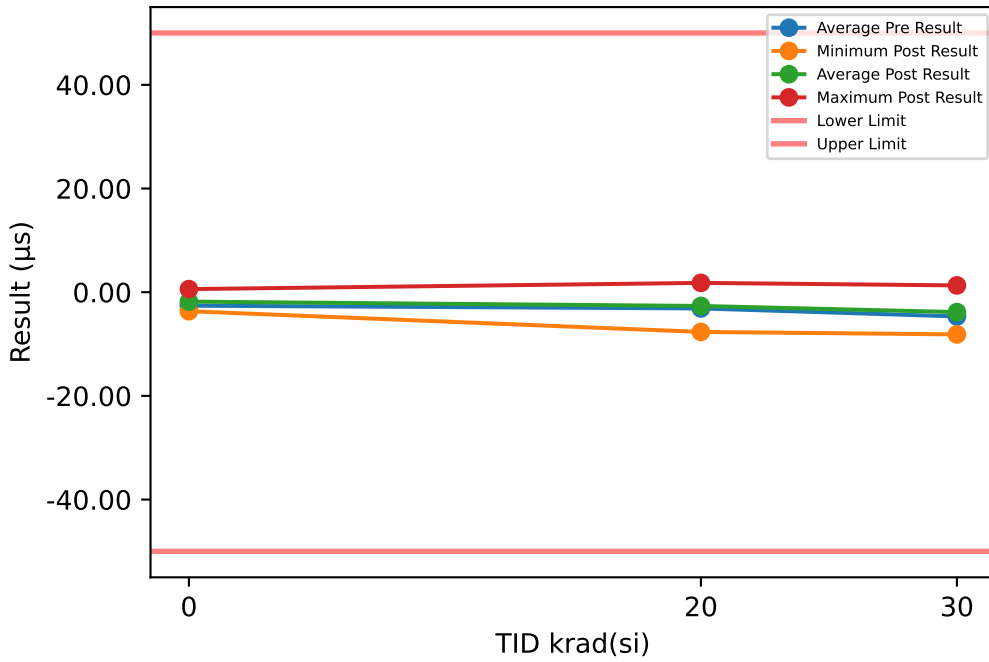

TID vs Post - Pre Exposure Delta

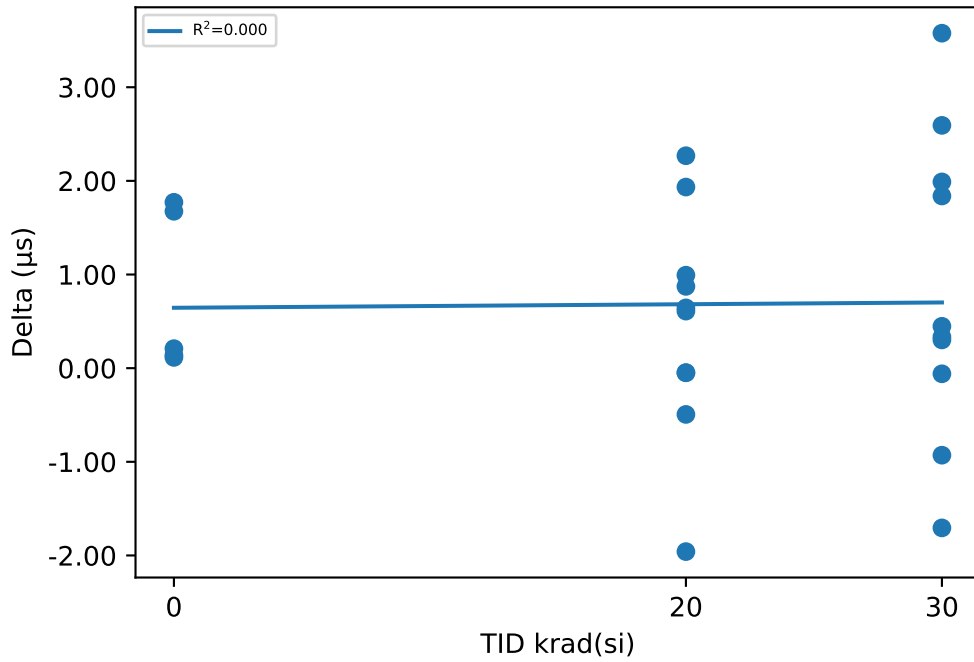

Test Results (Lower Limit = -50.0, Upper Limit = 50.0 (µs))

Serial #	krad(si)	Exposure Conditions	Pre Result	Post Result	Delta
50	20	LDR biased	-4.2764	-4.3258	-0.0494
51	20	LDR biased	-5.8357	-5.8834	-0.0477
52	20	LDR biased	-8.3058	-7.662	0.6438
53	20	LDR biased	0.8139	-1.1449	-1.9588
54	20	LDR biased	-1.7339	-2.2278	-0.4939
55	30	LDR biased	-6.6047	-4.6157	1.989
56	30	LDR biased	-3.1412	-4.8469	-1.7057
57	30	LDR biased	-6.9984	-6.6643	0.3341
58	30	LDR biased	2.2389	1.3096	-0.9293
59	30	LDR biased	-8.5856	-8.1385	0.4471
60	20	LDR unbiased	-0.474	1.7945	2.2685
61	20	LDR unbiased	0.0472	0.9205	0.8733
62	20	LDR unbiased	-6.6567	-6.0475	0.6092
63	20	LDR unbiased	-4.5794	-3.5863	0.9931
64	20	LDR unbiased	-0.3173	1.6168	1.9341
65	30	LDR unbiased	-3.1302	-1.2915	1.8387
66	30	LDR unbiased	-4.904	-4.9642	-0.0602
67	30	LDR unbiased	-2.5606	1.0164	3.577
68	30	LDR unbiased	-6.8184	-4.2256	2.5928
69	30	LDR unbiased	-6.2711	-5.9694	0.3017
70	0	correlation	-3.7782	-3.6634	0.1148
71	0	correlation	-4.5246	-2.7533	1.7713
72	0	correlation	-4.3087	-2.6334	1.6753
73	0	correlation	-0.7816	-0.6425	0.1391
74	0	correlation	0.3858	0.5942	0.2084

Test Statistics (µs)

krad(si)	Pre Exposure Min	Pre Exposure Avg	Pre Exposure Max	Pre Exposure Std	Post Exposure Min	Post Exposure Avg	Post Exposure Max	Post Exposure Std	Min Delta	Avg Delta	Max Delta	Std Delta
0	-4.5246	-2.6015	0.3858	2.2491	-3.6634	-1.8197	0.5942	1.7425	0.1148	0.78178	1.7713	0.86084
20	-8.3058	-3.1318	0.8139	3.2063	-7.662	-2.6546	1.7945	3.3986	-1.9588	0.47722	2.2685	1.2124
30	-8.5856	-4.6775	2.2389	3.1379	-8.1385	-3.839	1.3096	3.173	-1.7057	0.83852	3.577	1.6331

Device Test: 15.15 UJ33GQ(TON_DELAY_CH3_UJ33GQ)

TID vs Result Stats

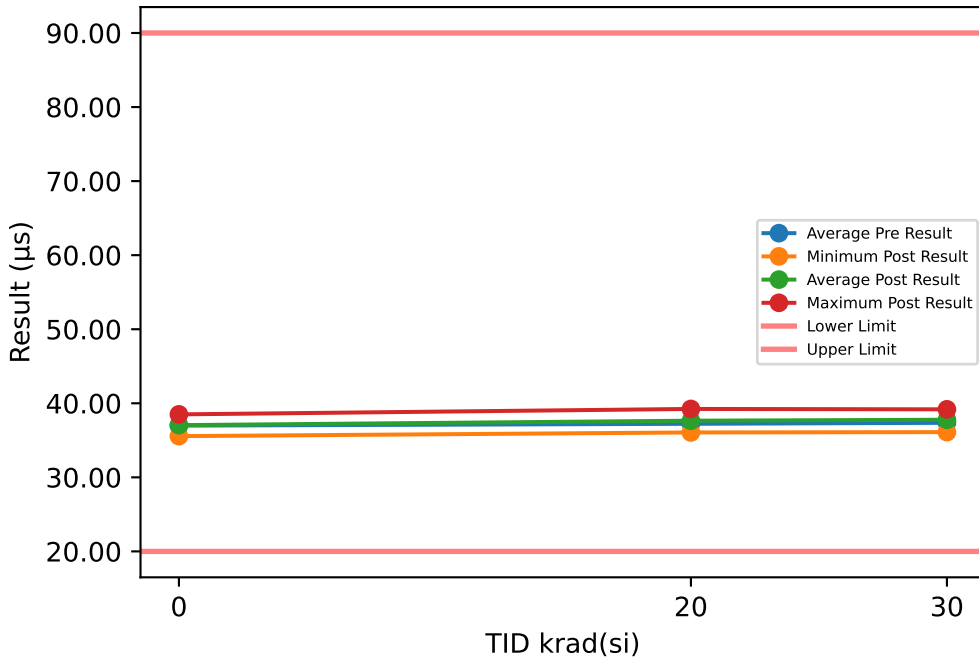

Test Results (Lower Limit = 20.0, Upper Limit = 90.0 (µs))

Serial #	krad(si)	Exposure Conditions	Pre Result	Post Result	Delta
50	20	LDR biased	35.764	36.063	0.2989
51	20	LDR biased	36.303	37.05	0.7475
52	20	LDR biased	37.989	38.1	0.1112
53	20	LDR biased	37.428	38.087	0.6583
54	20	LDR biased	37.548	38.283	0.7354
55	30	LDR biased	36.05	36.615	0.5651
56	30	LDR biased	36.475	37.549	1.0742
57	30	LDR biased	38.922	39.025	0.103
58	30	LDR biased	37.781	38.595	0.8137
59	30	LDR biased	36.497	37.168	0.6711
60	20	LDR unbiased	36.99	37.89	0.8999
61	20	LDR unbiased	37.828	37.45	-0.3779
62	20	LDR unbiased	39.093	39.236	0.1427
63	20	LDR unbiased	37.359	37.545	0.1858
64	20	LDR unbiased	35.985	36.772	0.7876
65	30	LDR unbiased	37.428	36.86	-0.5676
66	30	LDR unbiased	37.519	37.969	0.4498
67	30	LDR unbiased	38.946	39.183	0.2376
68	30	LDR unbiased	38.175	38.691	0.5157
69	30	LDR unbiased	35.85	36.108	0.2576
70	0	correlation	35.629	35.564	-0.065
71	0	correlation	36.661	36.763	0.102
72	0	correlation	36.552	36.966	0.4138
73	0	correlation	37.512	37.447	-0.0653
74	0	correlation	38.571	38.501	-0.0696

TID vs Post - Pre Exposure Delta

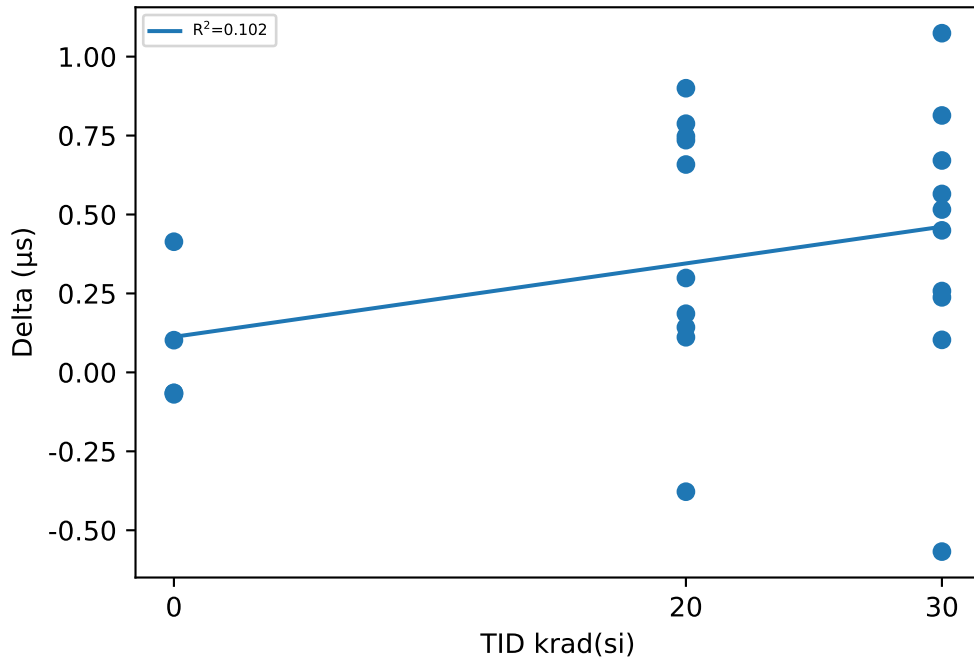

Test Statistics (µs)

krad(si)	Pre Exposure Min	Pre Exposure Avg	Pre Exposure Max	Pre Exposure Std	Post Exposure Min	Post Exposure Avg	Post Exposure Max	Post Exposure Std	Min Delta	Avg Delta	Max Delta	Std Delta
0	35.629	36.985	38.571	1.1095	35.564	37.048	38.501	1.0678	-0.0696	0.06318	0.4138	0.20917
20	35.764	37.229	39.093	1.0099	36.063	37.648	39.236	0.88619	-0.3779	0.41894	0.8999	0.40925
30	35.85	37.364	38.946	1.123	36.108	37.776	39.183	1.079	-0.5676	0.41202	1.0742	0.4487

Device Test: 15.16 UJZB3P(TOFF_DELAY_CH3_UJZB3P)

TID vs Result Stats

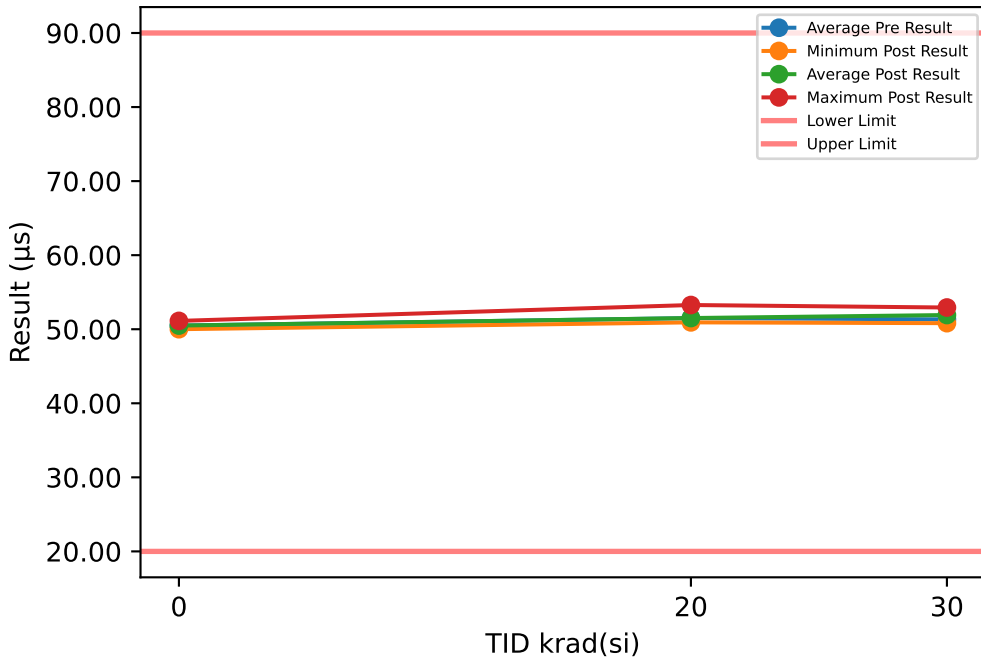

Test Results (Lower Limit = 20.0, Upper Limit = 90.0 (µs))

Serial #	krad(si)	Exposure Conditions	Pre Result	Post Result	Delta
50	20	LDR biased	52.727	53.269	0.5419
51	20	LDR biased	51.22	51.002	-0.2184
52	20	LDR biased	51.699	51.011	-0.6883
53	20	LDR biased	50.272	51.293	1.021
54	20	LDR biased	52.333	52.503	0.1699
55	30	LDR biased	51.45	51.671	0.2214
56	30	LDR biased	51.837	52.554	0.7161
57	30	LDR biased	50.874	51.352	0.4784
58	30	LDR biased	50.97	51.475	0.5055
59	30	LDR biased	50.226	51.296	1.0695
60	20	LDR unbiased	51.615	50.999	-0.616
61	20	LDR unbiased	50.615	51.087	0.4714
62	20	LDR unbiased	51.306	51.448	0.1424
63	20	LDR unbiased	50.981	50.926	-0.0552
64	20	LDR unbiased	52.248	51.574	-0.6745
65	30	LDR unbiased	51.915	52.932	1.0172
66	30	LDR unbiased	50.215	51.756	1.5405
67	30	LDR unbiased	51.354	50.818	-0.5357
68	30	LDR unbiased	53.374	52.79	-0.5848
69	30	LDR unbiased	51.077	52.524	1.4467
70	0	correlation	50.201	50.367	0.1661
71	0	correlation	50.871	50.67	-0.2005
72	0	correlation	50.817	50.303	-0.5143
73	0	correlation	50.605	51.123	0.5181
74	0	correlation	49.997	50.002	0.0053

TID vs Post - Pre Exposure Delta

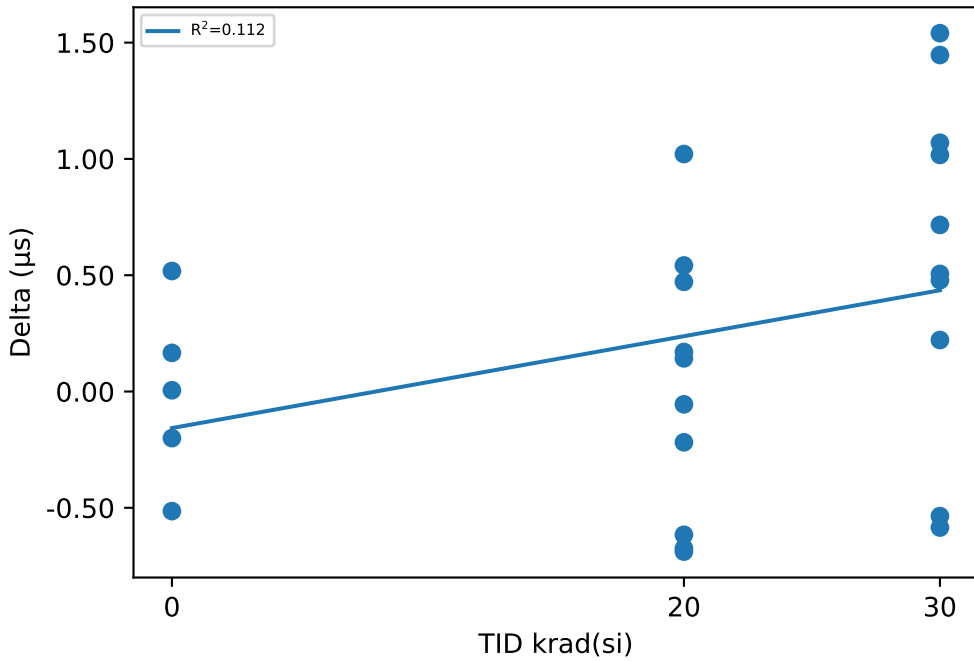

Test Statistics (µs)

krad(si)	Pre Exposure Min	Pre Exposure Avg	Pre Exposure Max	Pre Exposure Std	Post Exposure Min	Post Exposure Avg	Post Exposure Max	Post Exposure Std	Min Delta	Avg Delta	Max Delta	Std Delta
0	49.997	50.498	50.871	0.38465	50.002	50.493	51.123	0.4247	-0.5143	-0.00506	0.5181	0.3875
20	50.272	51.502	52.727	0.78099	50.926	51.511	53.269	0.7764	-0.6883	0.00942	1.021	0.57402
30	50.215	51.329	53.374	0.92238	50.818	51.917	52.932	0.72721	-0.5848	0.58748	1.5405	0.73549

Device Test: 15.17 UJP09Y(TRISE_CH3_UJP09Y)

TID vs Result Stats

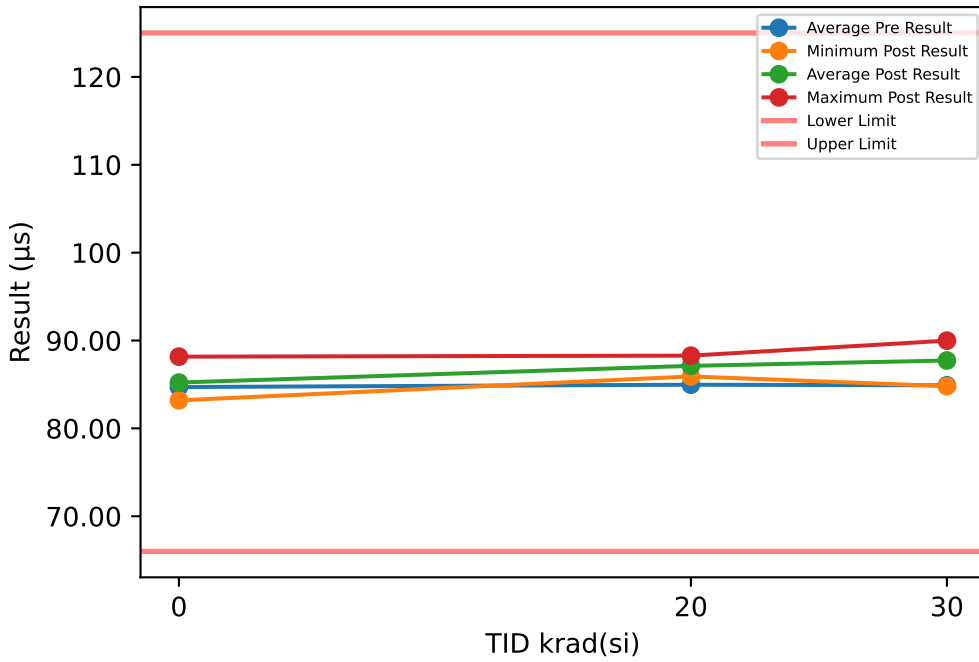

Test Results (Lower Limit = 66.0, Upper Limit = 125.0 (µs))

Serial #	krad(si)	Exposure Conditions	Pre Result	Post Result	Delta
50	20	LDR biased	84.766	86.27	1.5038
51	20	LDR biased	84.2	86.183	1.9829
52	20	LDR biased	86.49	88.279	1.789
53	20	LDR biased	86.009	87.606	1.5969
54	20	LDR biased	84.06	86.672	2.6121
55	30	LDR biased	83.727	87.367	3.6405
56	30	LDR biased	82.497	85.704	3.2069
57	30	LDR biased	87.294	89.631	2.3375
58	30	LDR biased	85.804	88.849	3.0459
59	30	LDR biased	84.898	87.926	3.0277
60	20	LDR unbiased	83.709	86.939	3.2302
61	20	LDR unbiased	86.668	88.031	1.363
62	20	LDR unbiased	85.589	87.597	2.0087
63	20	LDR unbiased	85.44	87.67	2.2299
64	20	LDR unbiased	82.775	85.913	3.1386
65	30	LDR unbiased	85.344	87.428	2.0842
66	30	LDR unbiased	84.385	86.425	2.0405
67	30	LDR unbiased	86	89.136	3.1356
68	30	LDR unbiased	85.852	89.985	4.1336
69	30	LDR unbiased	83.217	84.806	1.5884
70	0	correlation	83.041	83.187	0.1456
71	0	correlation	83.452	84.115	0.6629
72	0	correlation	83.069	84.411	1.3417
73	0	correlation	85.928	86.21	0.2821
74	0	correlation	88.038	88.164	0.1258

TID vs Post - Pre Exposure Delta

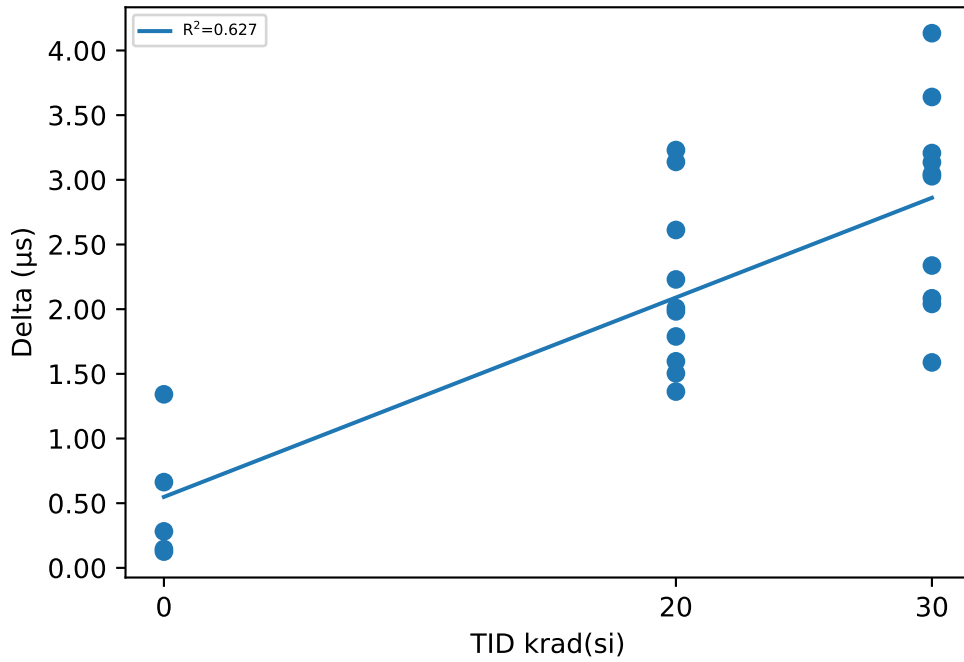

Test Statistics (µs)

krad(si)	Pre Exposure Min	Pre Exposure Avg	Pre Exposure Max	Pre Exposure Std	Post Exposure Min	Post Exposure Avg	Post Exposure Max	Post Exposure Std	Min Delta	Avg Delta	Max Delta	Std Delta
0	83.041	84.706	88.038	2.2145	83.187	85.217	88.164	1.9782	0.1258	0.51162	1.3417	0.51172
20	82.775	84.971	86.668	1.2802	85.913	87.116	88.279	0.83204	1.363	2.1455	3.2302	0.65701
30	82.497	84.902	87.294	1.4571	84.806	87.726	89.985	1.7176	1.5884	2.8241	4.1336	0.79167

Device Test: 15.18 UJ6AIM(TFALL_CH3_UJ6AIM)

TID vs Result Stats

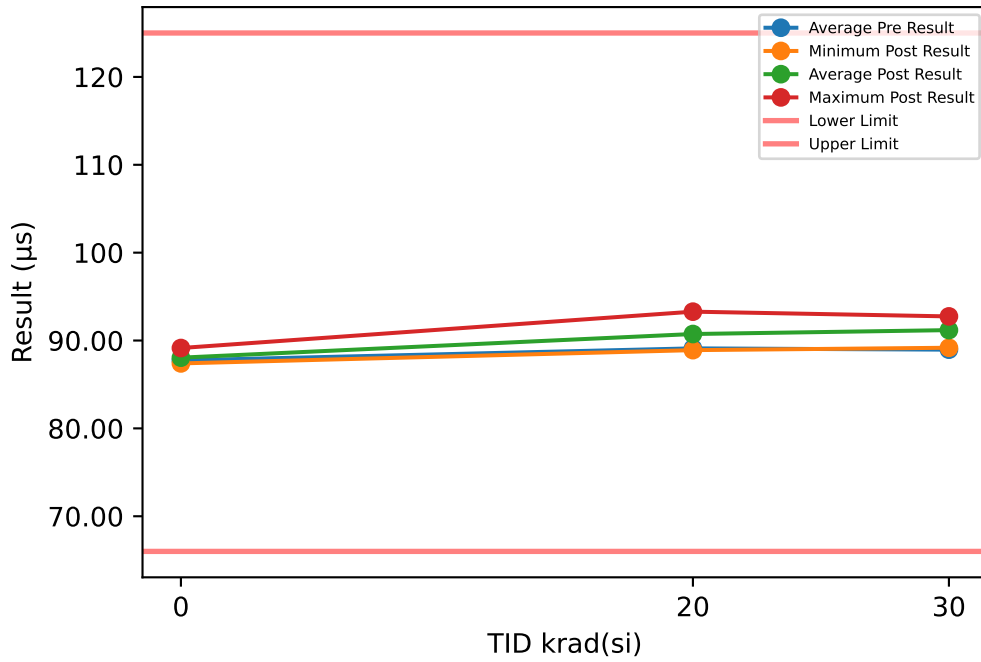

Test Results (Lower Limit = 66.0, Upper Limit = 125.0 (µs))

Serial #	krad(si)	Exposure Conditions	Pre Result	Post Result	Delta
50	20	LDR biased	90.056	92.329	2.2729
51	20	LDR biased	89.523	92.007	2.4841
52	20	LDR biased	88.766	90.839	2.0724
53	20	LDR biased	88.333	91.018	2.6845
54	20	LDR biased	90.928	93.284	2.3561
55	30	LDR biased	88.714	91.558	2.8438
56	30	LDR biased	88.843	91.616	2.7732
57	30	LDR biased	89.349	92.304	2.9545
58	30	LDR biased	88.345	91.253	2.9076
59	30	LDR biased	87.996	90.972	2.9763
60	20	LDR unbiased	88.013	88.906	0.8928
61	20	LDR unbiased	88.209	89.309	1.1004
62	20	LDR unbiased	90.096	90.75	0.6535
63	20	LDR unbiased	88.895	89.648	0.7531
64	20	LDR unbiased	88.264	89.313	1.0492
65	30	LDR unbiased	90.204	92.006	1.8013
66	30	LDR unbiased	87.582	89.177	1.5956
67	30	LDR unbiased	88.229	89.65	1.4205
68	30	LDR unbiased	91.343	92.746	1.4029
69	30	LDR unbiased	88.986	90.554	1.5679
70	0	correlation	87.33	87.704	0.3742
71	0	correlation	88.091	88.3	0.2083
72	0	correlation	87.101	87.395	0.2945
73	0	correlation	88.664	89.147	0.4828
74	0	correlation	87.517	87.706	0.1894

TID vs Post - Pre Exposure Delta

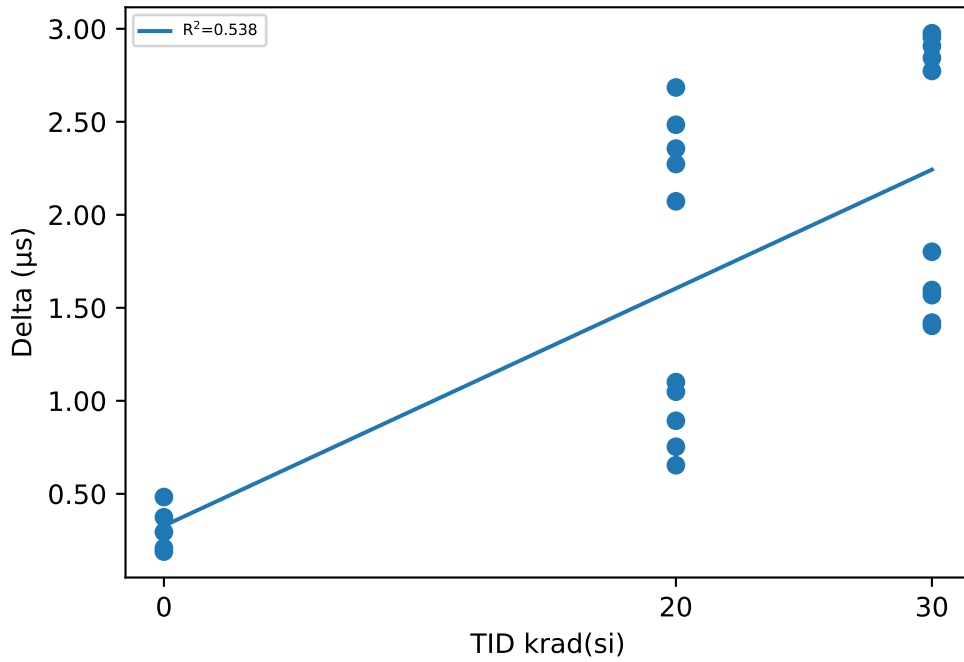

Test Statistics (µs)

krad(si)	Pre Exposure Min	Pre Exposure Avg	Pre Exposure Max	Pre Exposure Std	Post Exposure Min	Post Exposure Avg	Post Exposure Max	Post Exposure Std	Min Delta	Avg Delta	Max Delta	Std Delta
0	87.101	87.741	88.664	0.63323	87.395	88.05	89.147	0.69498	0.1894	0.30984	0.4828	0.12156
20	88.013	89.108	90.928	0.99131	88.906	90.74	93.284	1.4656	0.6535	1.6319	2.6845	0.80701
30	87.582	88.959	91.343	1.1152	89.177	91.183	92.746	1.1315	1.4029	2.2244	2.9763	0.71309

Device Test: 15.19 UJPEEL(SLEWRATE_ON_CH3_UJPEEL)

TID vs Result Stats

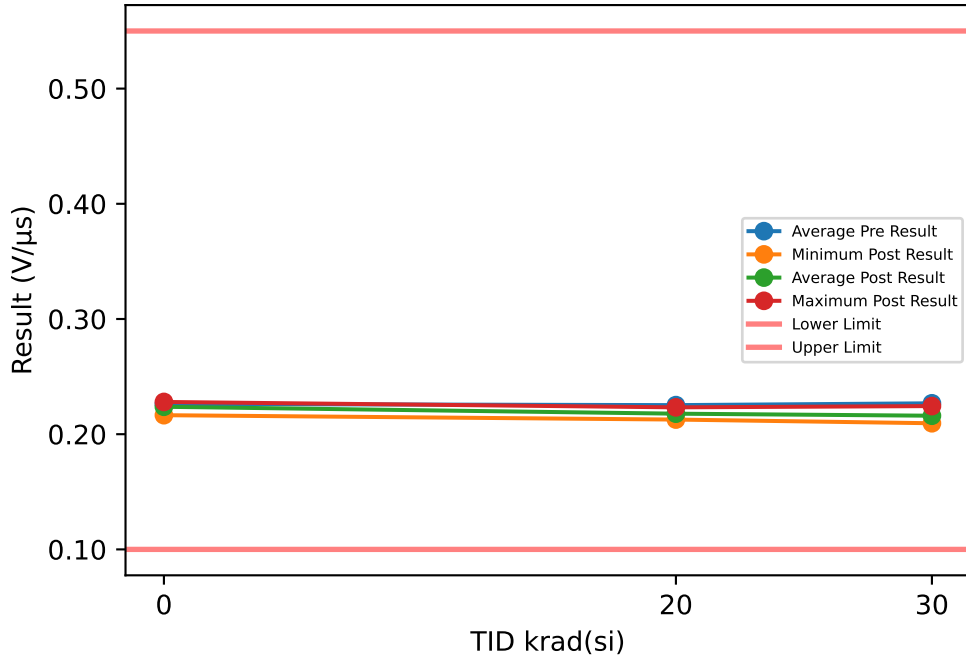

Test Results (Lower Limit = 0.1, Upper Limit = 0.55 (V/μs))

Serial #	krad(si)	Exposure Conditions	Pre Result	Post Result	Delta
50	20	LDR biased	0.2193	0.215	-0.0043
51	20	LDR biased	0.2253	0.2186	-0.0067
52	20	LDR biased	0.2223	0.2146	-0.0077
53	20	LDR biased	0.2209	0.2158	-0.0051
54	20	LDR biased	0.23	0.2228	-0.0072
55	30	LDR biased	0.2263	0.2138	-0.0125
56	30	LDR biased	0.2345	0.2244	-0.0101
57	30	LDR biased	0.223	0.2129	-0.0101
58	30	LDR biased	0.2248	0.2143	-0.0105
59	30	LDR biased	0.2215	0.2134	-0.0081
60	20	LDR unbiased	0.2312	0.2195	-0.0117
61	20	LDR unbiased	0.2195	0.2127	-0.0068
62	20	LDR unbiased	0.2317	0.2233	-0.0084
63	20	LDR unbiased	0.2227	0.215	-0.0077
64	20	LDR unbiased	0.2295	0.2208	-0.0087
65	30	LDR unbiased	0.2248	0.2139	-0.0109
66	30	LDR unbiased	0.23	0.222	-0.008
67	30	LDR unbiased	0.2286	0.2154	-0.0132
68	30	LDR unbiased	0.2261	0.2095	-0.0166
69	30	LDR unbiased	0.2286	0.2208	-0.0078
70	0	correlation	0.2269	0.2254	-0.0015
71	0	correlation	0.2315	0.228	-0.0035
72	0	correlation	0.2334	0.2278	-0.0056
73	0	correlation	0.2229	0.2213	-0.0016
74	0	correlation	0.2165	0.2165	0

TID vs Post - Pre Exposure Delta

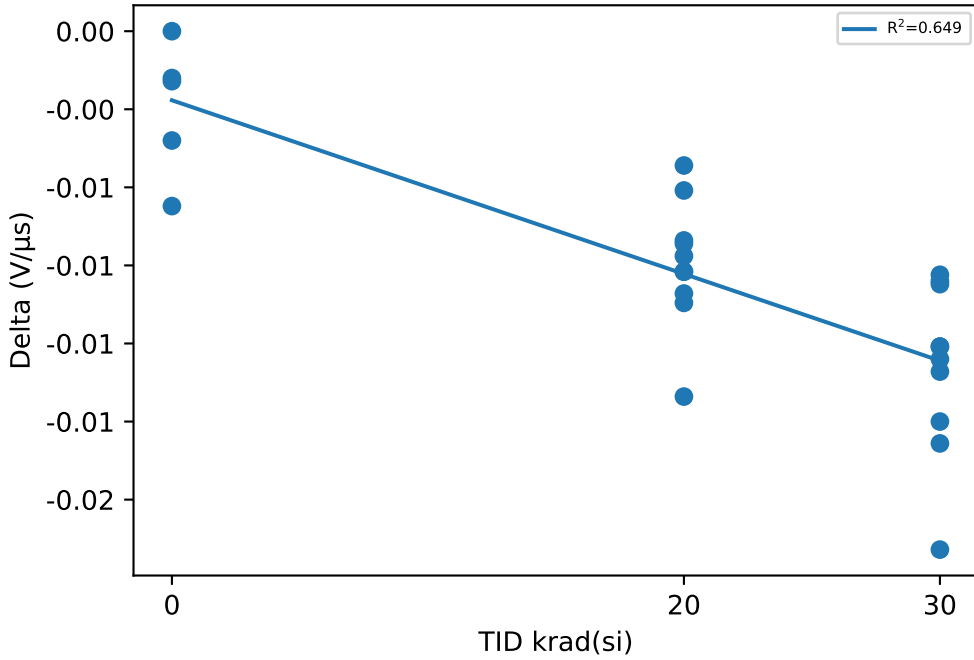

Test Statistics (V/μs)

krad(si)	Pre Exposure Min	Pre Exposure Avg	Pre Exposure Max	Pre Exposure Std	Post Exposure Min	Post Exposure Avg	Post Exposure Max	Post Exposure Std	Min Delta	Avg Delta	Max Delta	Std Delta
0	0.2165	0.22624	0.2334	0.0068079	0.2165	0.2238	0.228	0.0048923	-0.0056	-0.00244	0	0.0021594
20	0.2193	0.22524	0.2317	0.0049466	0.2127	0.21781	0.2233	0.0037075	-0.0117	-0.00743	-0.0043	0.0020314
30	0.2215	0.22682	0.2345	0.0037606	0.2095	0.21604	0.2244	0.0047223	-0.0166	-0.01078	-0.0078	0.0027385

Device Test: 15.2 UJZB3P(TOFF_DELAY_CH1_UJZB3P)

TID vs Result Stats

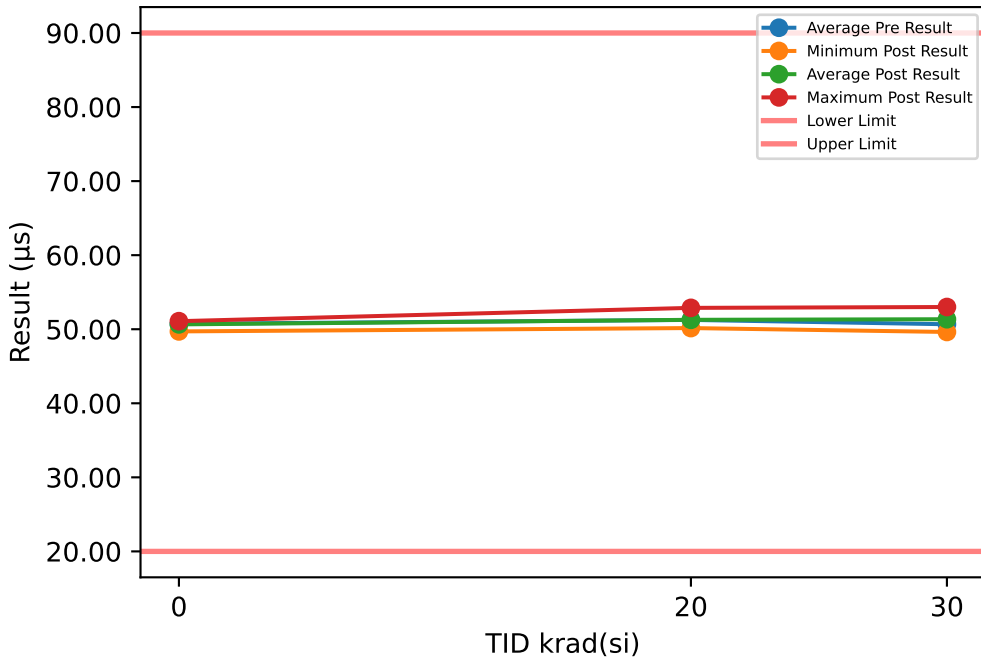

Test Results (Lower Limit = 20.0, Upper Limit = 90.0 (µs))

Serial #	krad(si)	Exposure Conditions	Pre Result	Post Result	Delta
50	20	LDR biased	52.702	52.884	0.1822
51	20	LDR biased	50.828	51.062	0.2332
52	20	LDR biased	52.387	51.361	-1.0266
53	20	LDR biased	50.616	51.546	0.9301
54	20	LDR biased	51.286	51.822	0.5357
55	30	LDR biased	50.016	50.509	0.493
56	30	LDR biased	52.816	53	0.1836
57	30	LDR biased	50.472	51.186	0.7137
58	30	LDR biased	50.607	50.895	0.288
59	30	LDR biased	49.597	51.608	2.0114
60	20	LDR unbiased	51.785	50.861	-0.9245
61	20	LDR unbiased	50.485	51.661	1.1755
62	20	LDR unbiased	50.78	50.992	0.2123
63	20	LDR unbiased	50.268	50.157	-0.1113
64	20	LDR unbiased	51.432	50.371	-1.0613
65	30	LDR unbiased	50.986	52.049	1.0625
66	30	LDR unbiased	50.404	52.062	1.6581
67	30	LDR unbiased	49.946	49.631	-0.315
68	30	LDR unbiased	51.82	49.952	-1.8681
69	30	LDR unbiased	50.042	52.607	2.5655
70	0	correlation	49.715	49.706	-0.01
71	0	correlation	50.816	50.963	0.1467
72	0	correlation	51.749	50.457	-1.292
73	0	correlation	50.342	51.086	0.7443
74	0	correlation	51.019	51.06	0.0412

TID vs Post - Pre Exposure Delta

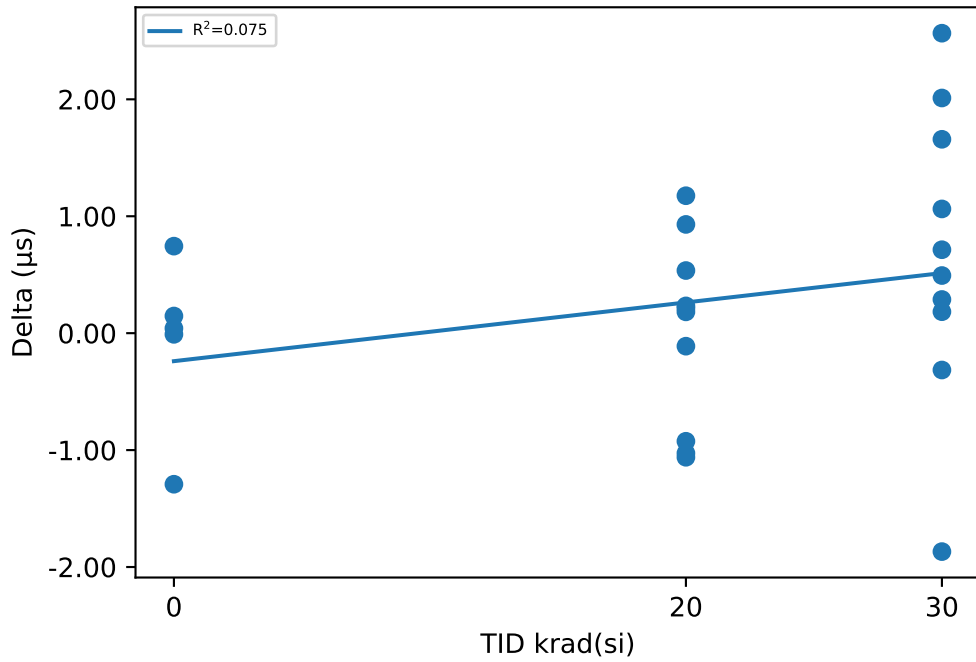

Test Statistics (µs)

krad(si)	Pre Exposure Min	Pre Exposure Avg	Pre Exposure Max	Pre Exposure Std	Post Exposure Min	Post Exposure Avg	Post Exposure Max	Post Exposure Std	Min Delta	Avg Delta	Max Delta	Std Delta
0	49.715	50.728	51.749	0.75975	49.706	50.654	51.086	0.58855	-1.292	-0.07396	0.7443	0.74485
20	50.268	51.257	52.702	0.82132	50.157	51.272	52.884	0.78056	-1.0613	0.01453	1.1755	0.79664
30	49.597	50.671	52.816	0.97996	49.631	51.35	53	1.1165	-1.8681	0.67927	2.5655	1.2627

Device Test: 15.20 UJD80I(SLEWRATE_OFF_CH3_UJD80I)

TID vs Result Stats

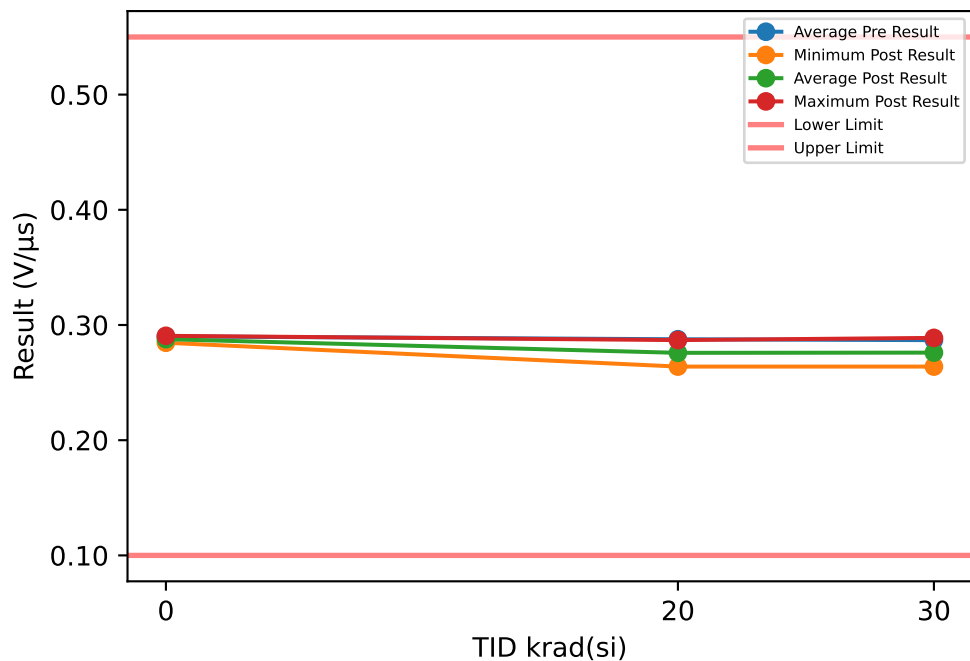

Test Results (Lower Limit = 0.1, Upper Limit = 0.55 (V/μs))

Serial #	krad(si)	Exposure Conditions	Pre Result	Post Result	Delta
50	20	LDR biased	0.2903	0.2761	-0.0142
51	20	LDR biased	0.2816	0.2639	-0.0177
52	20	LDR biased	0.2916	0.2703	-0.0213
53	20	LDR biased	0.2845	0.2714	-0.0131
54	20	LDR biased	0.2801	0.2658	-0.0143
55	30	LDR biased	0.2888	0.2716	-0.0172
56	30	LDR biased	0.2935	0.2781	-0.0154
57	30	LDR biased	0.2807	0.2639	-0.0168
58	30	LDR biased	0.2885	0.2733	-0.0152
59	30	LDR biased	0.2851	0.2744	-0.0107
60	20	LDR unbiased	0.297	0.2867	-0.0103
61	20	LDR unbiased	0.2863	0.2833	-0.003
62	20	LDR unbiased	0.2786	0.275	-0.0036
63	20	LDR unbiased	0.2873	0.2789	-0.0084
64	20	LDR unbiased	0.299	0.2869	-0.0121
65	30	LDR unbiased	0.2818	0.2758	-0.006
66	30	LDR unbiased	0.2888	0.2888	0
67	30	LDR unbiased	0.2925	0.2784	-0.0141
68	30	LDR unbiased	0.2842	0.27	-0.0142
69	30	LDR unbiased	0.2845	0.2859	0.0014
70	0	correlation	0.2906	0.2894	-0.0012
71	0	correlation	0.2901	0.2863	-0.0038
72	0	correlation	0.2984	0.2906	-0.0078
73	0	correlation	0.2839	0.2846	0.0007
74	0	correlation	0.2876	0.2875	-0.0001

TID vs Post - Pre Exposure Delta

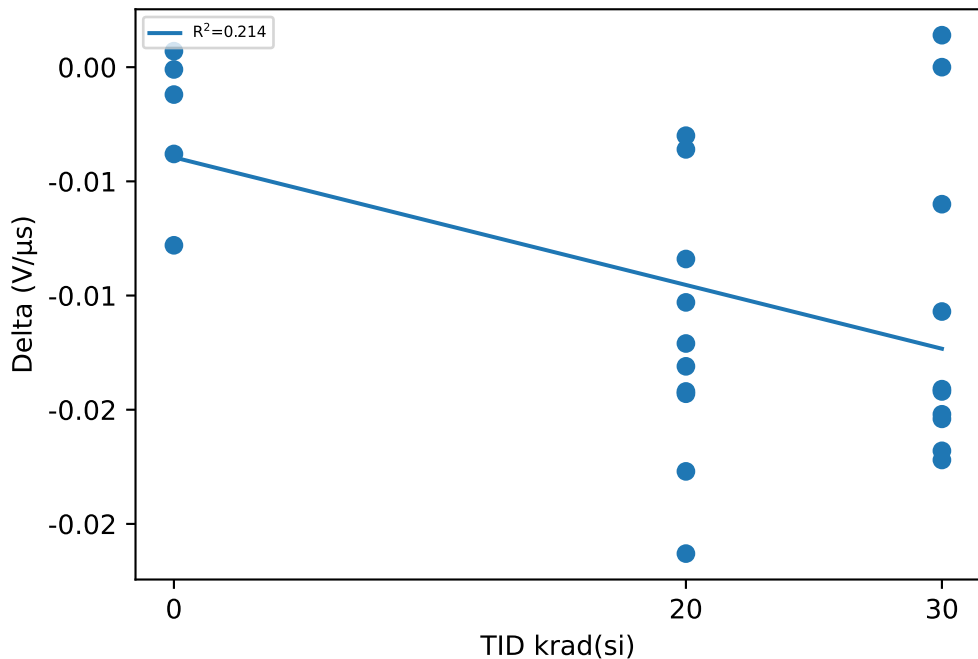

Test Statistics (V/μs)

krad(si)	Pre Exposure Min	Pre Exposure Avg	Pre Exposure Max	Pre Exposure Std	Post Exposure Min	Post Exposure Avg	Post Exposure Max	Post Exposure Std	Min Delta	Avg Delta	Max Delta	Std Delta
0	0.2839	0.29012	0.2984	0.0053345	0.2846	0.28768	0.2906	0.0023931	-0.0078	-0.00244	0.0007	0.0034443
20	0.2786	0.28763	0.299	0.0068819	0.2639	0.27583	0.2869	0.0081637	-0.0213	-0.0118	-0.003	0.0057478
30	0.2807	0.28684	0.2935	0.004287	0.2639	0.27602	0.2888	0.0073309	-0.0172	-0.01082	0.0014	0.0068997

Device Test: 15.21 UJHGWM(TMATCH_CH3_UJHGWM)

TID vs Result Stats

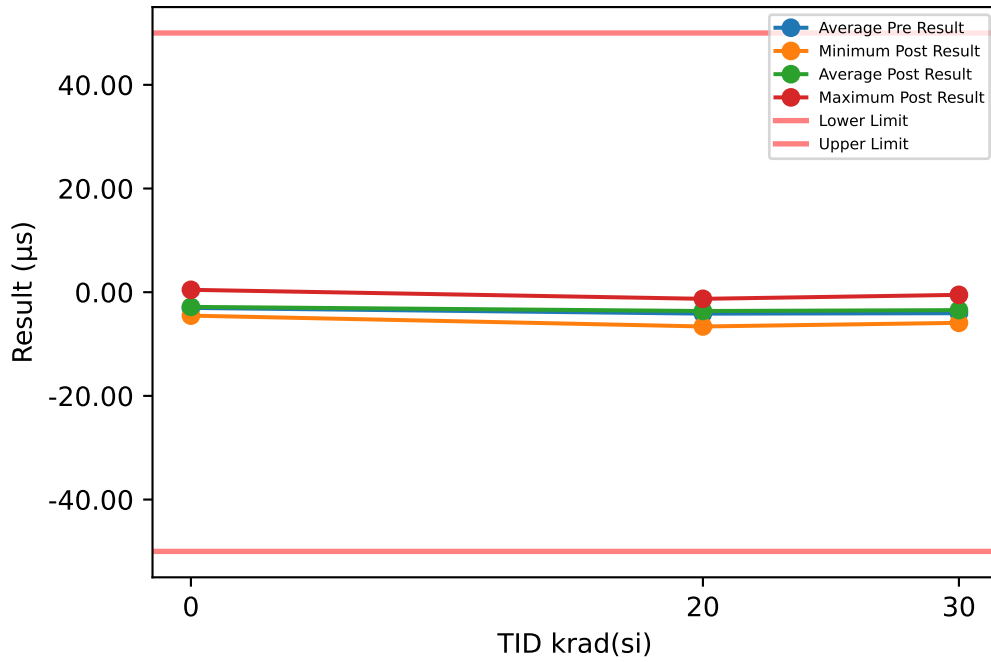

Test Results (Lower Limit = -50.0, Upper Limit = 50.0 (µs))

Serial #	krad(si)	Exposure Conditions	Pre Result	Post Result	Delta
50	20	LDR biased	-5.2904	-6.0595	-0.7691
51	20	LDR biased	-5.3232	-5.8245	-0.5013
52	20	LDR biased	-2.2761	-2.5595	-0.2834
53	20	LDR biased	-2.3245	-3.4122	-1.0877
54	20	LDR biased	-6.8682	-6.6121	0.2561
55	30	LDR biased	-4.9876	-4.1909	0.7967
56	30	LDR biased	-6.3458	-5.912	0.4338
57	30	LDR biased	-2.0555	-2.6725	-0.617
58	30	LDR biased	-2.5419	-2.4035	0.1384
59	30	LDR biased	-3.0978	-3.0465	0.0513
60	20	LDR unbiased	-4.3049	-1.9676	2.3373
61	20	LDR unbiased	-1.5405	-1.2778	0.2627
62	20	LDR unbiased	-4.5075	-3.1523	1.3552
63	20	LDR unbiased	-3.4544	-1.9777	1.4767
64	20	LDR unbiased	-5.4892	-3.3998	2.0894
65	30	LDR unbiased	-4.8609	-4.5781	0.2828
66	30	LDR unbiased	-3.1967	-2.7519	0.4448
67	30	LDR unbiased	-2.2292	-0.514	1.7152
68	30	LDR unbiased	-5.4909	-2.7602	2.7307
69	30	LDR unbiased	-5.7688	-5.7483	0.0205
70	0	correlation	-4.2886	-4.5172	-0.2286
71	0	correlation	-4.6391	-4.1845	0.4546
72	0	correlation	-4.0314	-2.9842	1.0472
73	0	correlation	-2.7358	-2.9365	-0.2007
74	0	correlation	0.5214	0.4578	-0.0636

TID vs Post - Pre Exposure Delta

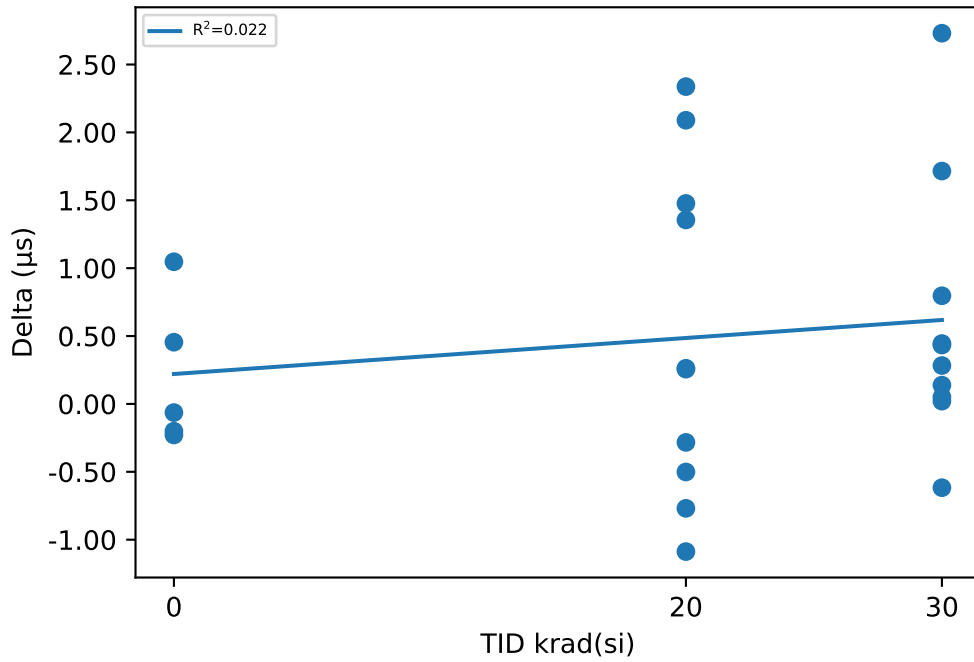

Test Statistics (µs)

krad(si)	Pre Exposure Min	Pre Exposure Avg	Pre Exposure Max	Pre Exposure Std	Post Exposure Min	Post Exposure Avg	Post Exposure Max	Post Exposure Std	Min Delta	Avg Delta	Max Delta	Std Delta
0	-4.6391	-3.0347	0.5214	2.1139	-4.5172	-2.8329	0.4578	1.9702	-0.2286	0.20178	1.0472	0.54688
20	-6.8682	-4.1379	-1.5405	1.7045	-6.6121	-3.6243	-1.2778	1.8889	-1.0877	0.51359	2.3373	1.2224
30	-6.3458	-4.0575	-2.0555	1.6	-5.912	-3.4578	-0.514	1.6536	-0.617	0.59972	2.7307	0.96065

Device Test: 15.22 UJ33GQ(TON_DELAY_CH4_UJ33GQ)

TID vs Result Stats

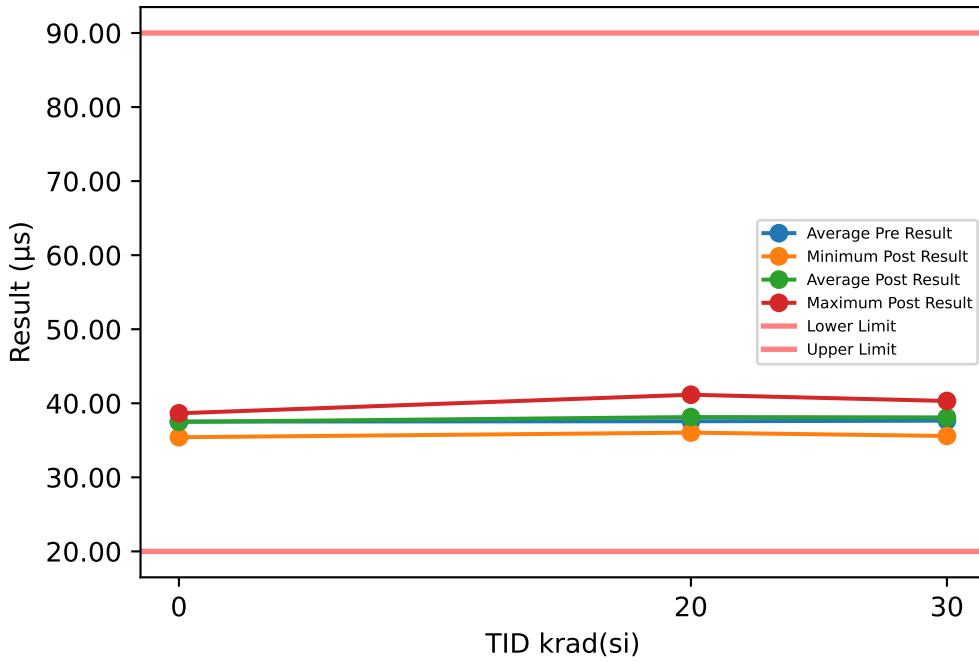

TID vs Post - Pre Exposure Delta

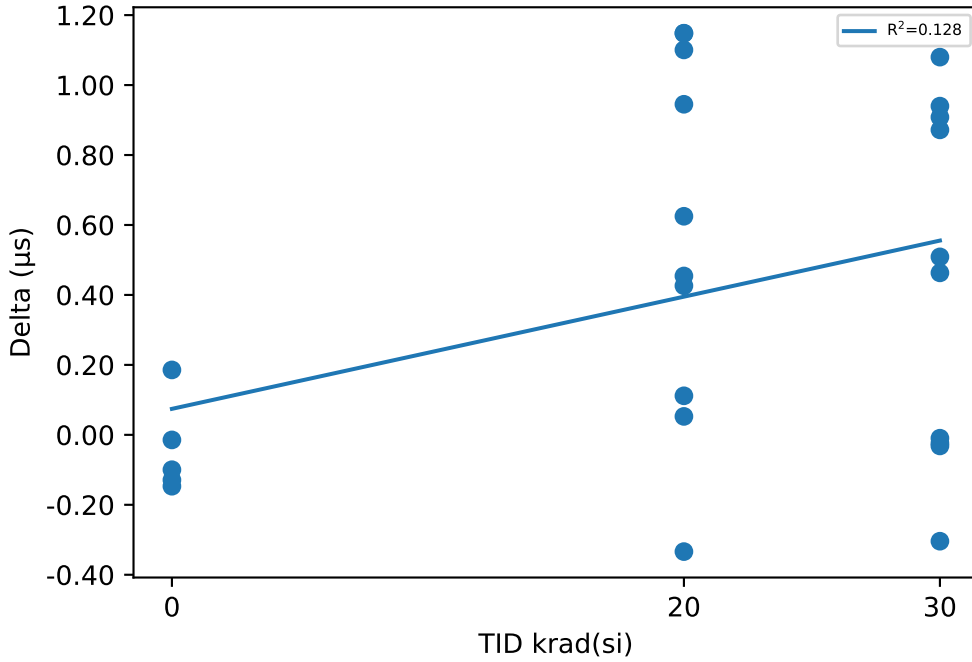

Test Results (Lower Limit = 20.0, Upper Limit = 90.0 (µs))

Serial #	krad(si)	Exposure Conditions	Pre Result	Post Result	Delta
50	20	LDR biased	35.611	36.038	0.4263
51	20	LDR biased	36.007	36.059	0.0527
52	20	LDR biased	39.622	40.77	1.1479
53	20	LDR biased	40.532	41.157	0.6249
54	20	LDR biased	36.236	37.385	1.1483
55	30	LDR biased	37.728	37.696	-0.0317
56	30	LDR biased	38.039	38.911	0.8719
57	30	LDR biased	38.269	39.349	1.0799
58	30	LDR biased	35.944	36.852	0.9082
59	30	LDR biased	37.439	37.43	-0.0096
60	20	LDR unbiased	37.169	38.269	1.1005
61	20	LDR unbiased	37.309	37.763	0.4542
62	20	LDR unbiased	37.603	37.269	-0.3338
63	20	LDR unbiased	39.757	39.869	0.1116
64	20	LDR unbiased	35.878	36.823	0.9451
65	30	LDR unbiased	36.885	37.825	0.9398
66	30	LDR unbiased	35.611	35.587	-0.0242
67	30	LDR unbiased	37.44	37.903	0.4631
68	30	LDR unbiased	39.803	40.312	0.5088
69	30	LDR unbiased	39.357	39.053	-0.3041
70	0	correlation	37.969	37.954	-0.0145
71	0	correlation	35.561	35.414	-0.1469
72	0	correlation	36.827	37.012	0.1856
73	0	correlation	38.777	38.648	-0.129
74	0	correlation	38.518	38.418	-0.0997

Test Statistics (µs)

krad(si)	Pre Exposure Min	Pre Exposure Avg	Pre Exposure Max	Pre Exposure Std	Post Exposure Min	Post Exposure Avg	Post Exposure Max	Post Exposure Std	Min Delta	Avg Delta	Max Delta	Std Delta
0	35.561	37.53	38.777	1.332	35.414	37.489	38.648	1.3189	-0.1469	-0.0409	0.1856	0.13643
20	35.611	37.572	40.532	1.7926	36.038	38.14	41.157	1.8552	-0.3338	0.56777	1.1483	0.51877
30	35.611	37.651	39.803	1.3263	35.587	38.092	40.312	1.3589	-0.3041	0.44021	1.0799	0.50156

Device Test: 15.23 UJZB3P(TOFF_DELAY_CH4_UJZB3P)

TID vs Result Stats

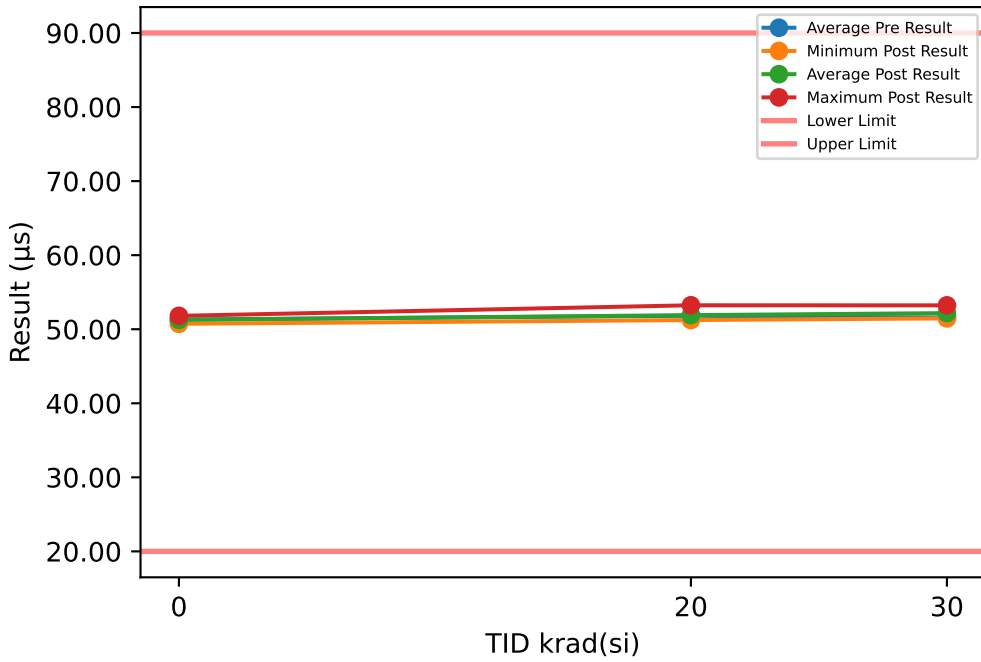

TID vs Post - Pre Exposure Delta

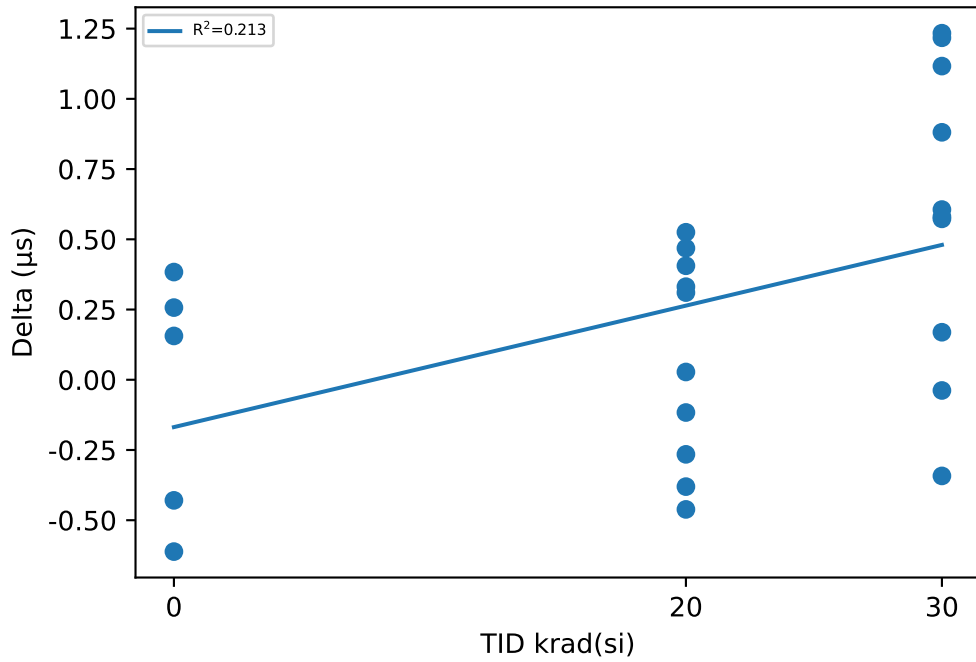

Test Results (Lower Limit = 20.0, Upper Limit = 90.0 (µs))

Serial #	krad(si)	Exposure Conditions	Pre Result	Post Result	Delta
50	20	LDR biased	52.925	53.235	0.3103
51	20	LDR biased	51.261	51.288	0.0277
52	20	LDR biased	52.987	52.526	-0.4615
53	20	LDR biased	51.075	51.6	0.5251
54	20	LDR biased	51.817	52.223	0.4058
55	30	LDR biased	51.546	51.715	0.1692
56	30	LDR biased	51.822	52.428	0.6059
57	30	LDR biased	52.045	52.618	0.5728
58	30	LDR biased	51.078	51.659	0.5806
59	30	LDR biased	50.549	51.666	1.1166
60	20	LDR unbiased	52.016	51.636	-0.3804
61	20	LDR unbiased	51.572	52.04	0.4683
62	20	LDR unbiased	51.34	51.671	0.3313
63	20	LDR unbiased	51.835	51.569	-0.2655
64	20	LDR unbiased	51.358	51.241	-0.1166
65	30	LDR unbiased	51.656	52.537	0.8809
66	30	LDR unbiased	50.869	52.103	1.2337
67	30	LDR unbiased	51.504	51.466	-0.0381
68	30	LDR unbiased	52.661	52.319	-0.3423
69	30	LDR unbiased	52.005	53.223	1.2174
70	0	correlation	51.652	51.808	0.156
71	0	correlation	51.859	51.247	-0.6117
72	0	correlation	51.542	51.112	-0.4293
73	0	correlation	51.033	51.417	0.3834
74	0	correlation	50.476	50.733	0.2569

Test Statistics (µs)

krad(si)	Pre Exposure Min	Pre Exposure Avg	Pre Exposure Max	Pre Exposure Std	Post Exposure Min	Post Exposure Avg	Post Exposure Max	Post Exposure Std	Min Delta	Avg Delta	Max Delta	Std Delta
0	50.476	51.312	51.859	0.55776	50.733	51.263	51.808	0.39538	-0.6117	-0.04894	0.3834	0.44267
20	51.075	51.819	52.987	0.66631	51.241	51.903	53.235	0.61711	-0.4615	0.08445	0.5251	0.37073
30	50.549	51.574	52.661	0.61975	51.466	52.173	53.223	0.55329	-0.3423	0.59967	1.2337	0.53856

Device Test: 15.24 UJP09Y(TRISE_CH4_UJP09Y)

TID vs Result Stats

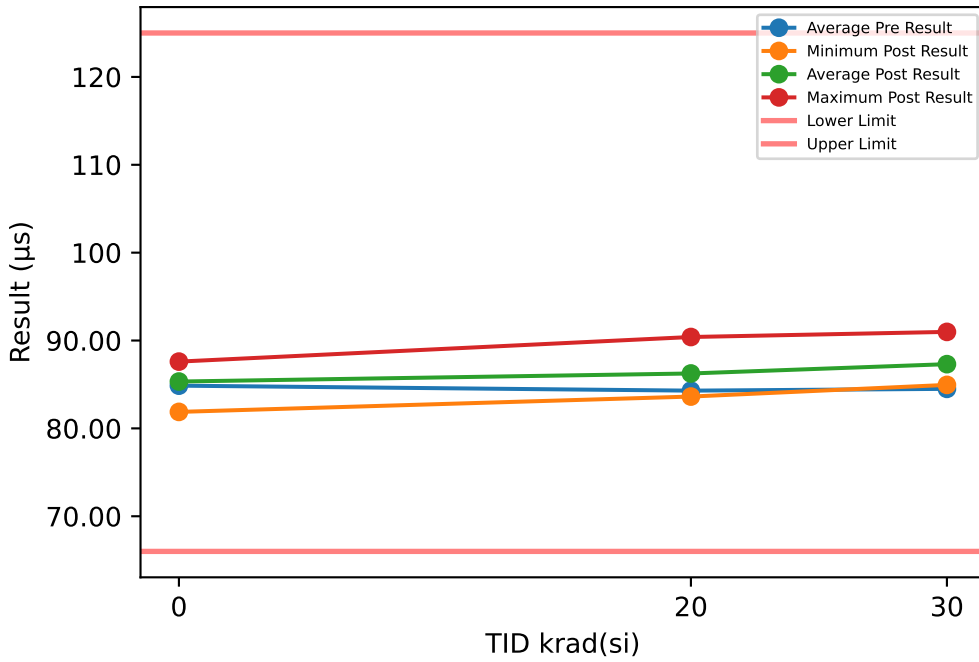

Test Results (Lower Limit = 66.0, Upper Limit = 125.0 (µs))

Serial #	krad(si)	Exposure Conditions	Pre Result	Post Result	Delta
50	20	LDR biased	83.566	85.275	1.7097
51	20	LDR biased	82.43	83.889	1.459
52	20	LDR biased	85.57	88.589	3.0193
53	20	LDR biased	88.174	90.4	2.226
54	20	LDR biased	83.663	86.285	2.6222
55	30	LDR biased	83.331	85.385	2.0548
56	30	LDR biased	83.786	86.615	2.8289
57	30	LDR biased	85.72	89.274	3.5542
58	30	LDR biased	84.028	87.244	3.2158
59	30	LDR biased	83.377	85.979	2.6022
60	20	LDR unbiased	84.545	87.36	2.8148
61	20	LDR unbiased	82.194	83.622	1.4286
62	20	LDR unbiased	83.637	84.613	0.976
63	20	LDR unbiased	85.396	86.319	0.9229
64	20	LDR unbiased	83.789	86.141	2.3521
65	30	LDR unbiased	84.641	88.403	3.7615
66	30	LDR unbiased	83.12	84.95	1.8305
67	30	LDR unbiased	83.556	86.603	3.0476
68	30	LDR unbiased	87.379	90.982	3.6031
69	30	LDR unbiased	86.055	87.661	1.606
70	0	correlation	86.422	86.801	0.3795
71	0	correlation	81.385	81.876	0.4914
72	0	correlation	84.105	84.99	0.8845
73	0	correlation	85.077	85.392	0.315
74	0	correlation	87.323	87.601	0.2778

TID vs Post - Pre Exposure Delta

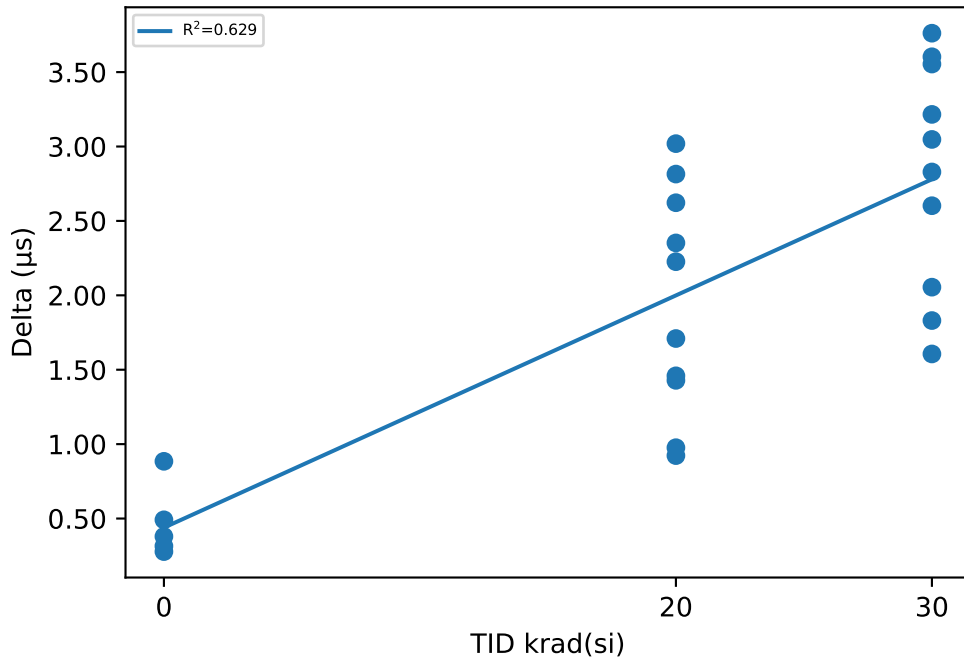

Test Statistics (µs)

krad(si)	Pre Exposure Min	Pre Exposure Avg	Pre Exposure Max	Pre Exposure Std	Post Exposure Min	Post Exposure Avg	Post Exposure Max	Post Exposure Std	Min Delta	Avg Delta	Max Delta	Std Delta
0	81.385	84.862	87.323	2.3021	81.876	85.332	87.601	2.2005	0.2778	0.46964	0.8845	0.24567
20	82.194	84.296	88.174	1.7467	83.622	86.249	90.4	2.1095	0.9229	1.9531	3.0193	0.75684
30	83.12	84.499	87.379	1.4288	84.95	87.31	90.982	1.8466	1.606	2.8105	3.7615	0.76972

Device Test: 15.27 UJD80I(SLEWRATE_OFF_CH4_UJD80I)

TID vs Result Stats

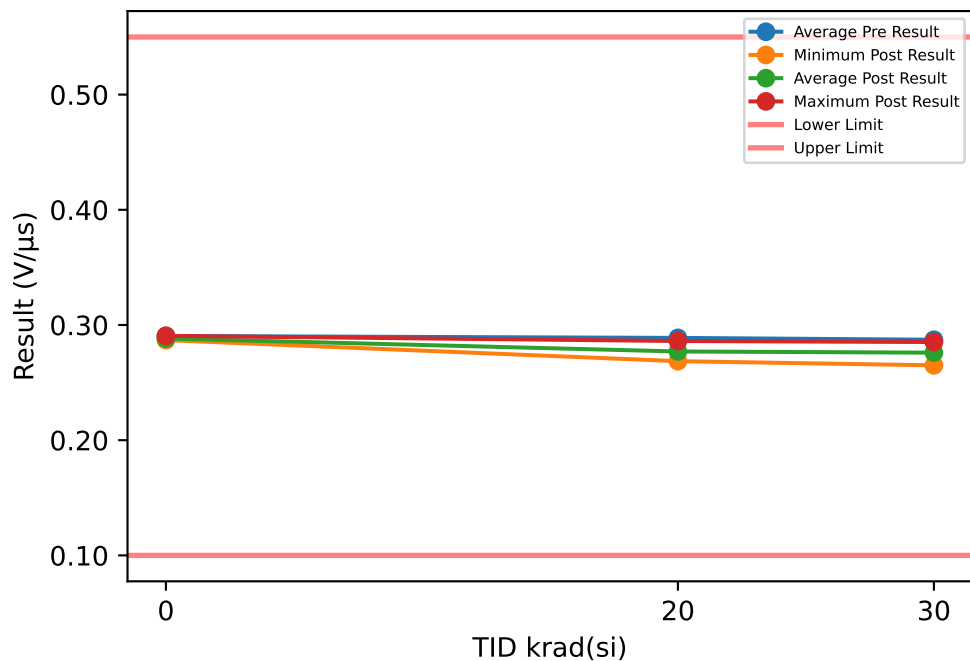

Test Results (Lower Limit = 0.1, Upper Limit = 0.55 (V/μs))

Serial #	krad(si)	Exposure Conditions	Pre Result	Post Result	Delta
50	20	LDR biased	0.2913	0.2766	-0.0147
51	20	LDR biased	0.2866	0.2686	-0.018
52	20	LDR biased	0.2894	0.2716	-0.0178
53	20	LDR biased	0.2848	0.2714	-0.0134
54	20	LDR biased	0.2866	0.2719	-0.0147
55	30	LDR biased	0.2925	0.2736	-0.0189
56	30	LDR biased	0.2894	0.2753	-0.0141
57	30	LDR biased	0.2804	0.265	-0.0154
58	30	LDR biased	0.2908	0.2753	-0.0155
59	30	LDR biased	0.286	0.2724	-0.0136
60	20	LDR unbiased	0.2928	0.2824	-0.0104
61	20	LDR unbiased	0.2882	0.2839	-0.0043
62	20	LDR unbiased	0.2835	0.2793	-0.0042
63	20	LDR unbiased	0.2894	0.2784	-0.011
64	20	LDR unbiased	0.2954	0.2861	-0.0093
65	30	LDR unbiased	0.2827	0.2758	-0.0069
66	30	LDR unbiased	0.2885	0.2852	-0.0033
67	30	LDR unbiased	0.2945	0.2827	-0.0118
68	30	LDR unbiased	0.2851	0.2727	-0.0124
69	30	LDR unbiased	0.2821	0.2818	-0.0003
70	0	correlation	0.2891	0.2879	-0.0012
71	0	correlation	0.2907	0.2882	-0.0025
72	0	correlation	0.2956	0.2906	-0.005
73	0	correlation	0.2875	0.2869	-0.0006
74	0	correlation	0.2894	0.2879	-0.0015

TID vs Post - Pre Exposure Delta

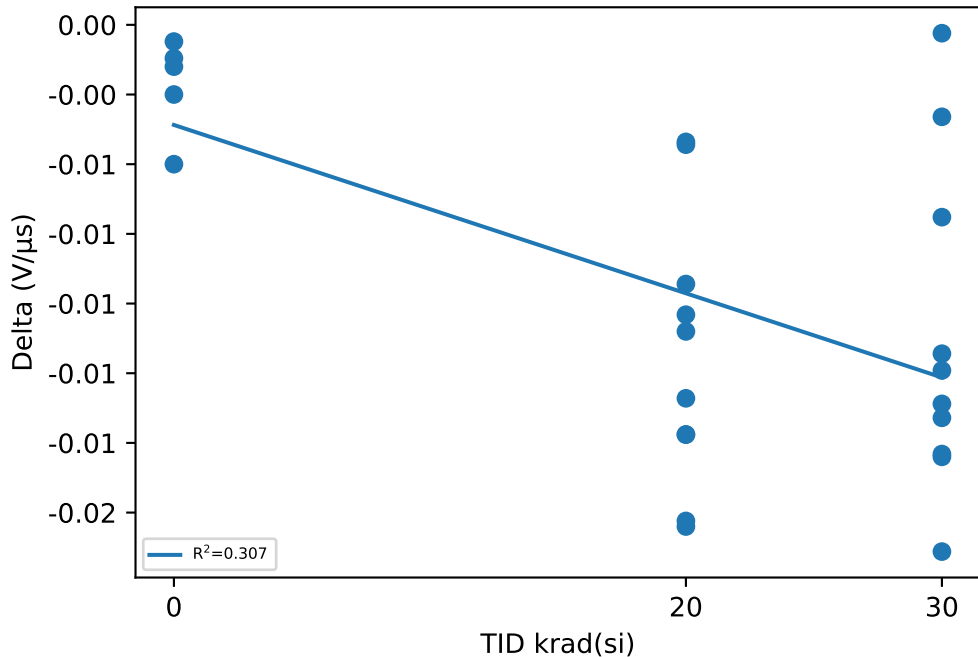

Test Statistics (V/μs)

krad(si)	Pre Exposure Min	Pre Exposure Avg	Pre Exposure Max	Pre Exposure Std	Post Exposure Min	Post Exposure Avg	Post Exposure Max	Post Exposure Std	Min Delta	Avg Delta	Max Delta	Std Delta
0	0.2875	0.29046	0.2956	0.0030908	0.2869	0.2883	0.2906	0.0013766	-0.005	-0.00216	-0.0006	0.00173
20	0.2835	0.2888	0.2954	0.0036615	0.2686	0.27702	0.2861	0.0060007	-0.018	-0.01178	-0.0042	0.0049066
30	0.2804	0.2872	0.2945	0.0047048	0.265	0.27598	0.2852	0.0059142	-0.0189	-0.01122	-0.0003	0.0058793

Device Test: 15.28 UJHGWM(TMATCH_CH4_UJHGWM)

TID vs Result Stats

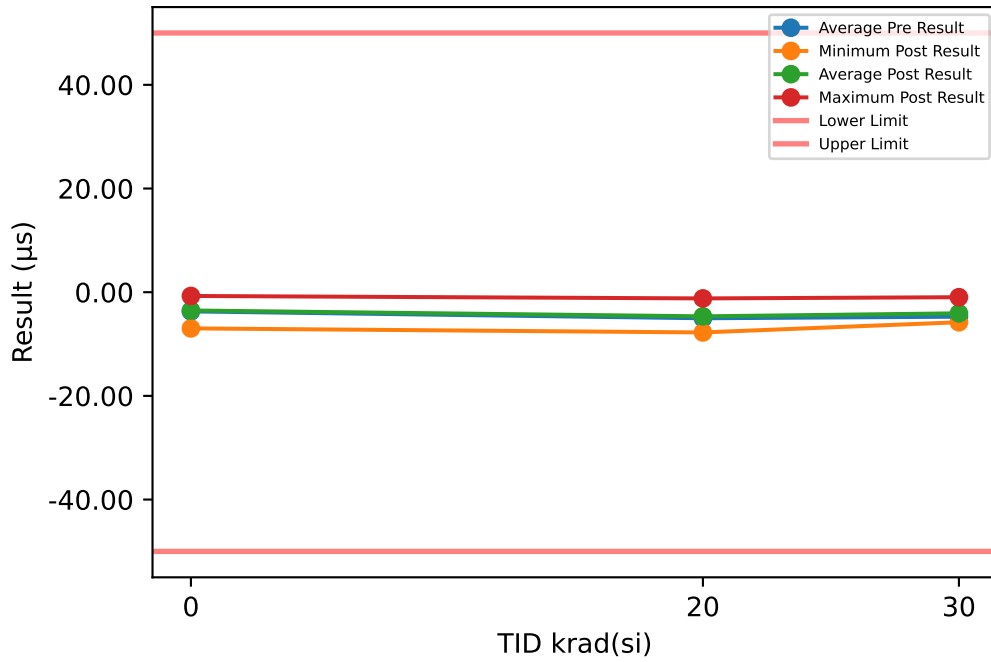

TID vs Post - Pre Exposure Delta

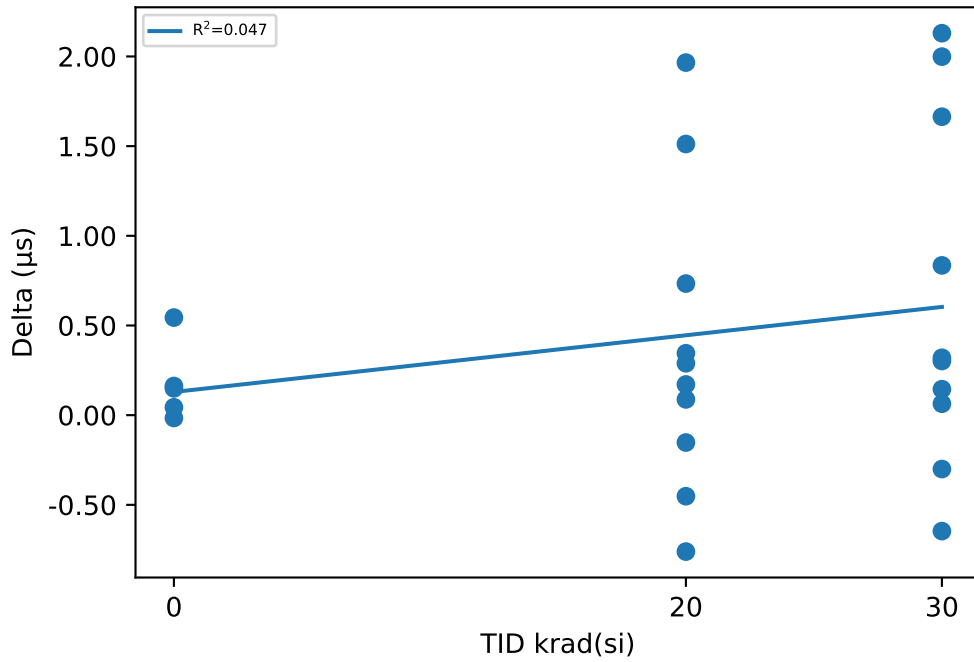

Test Results (Lower Limit = -50.0, Upper Limit = 50.0 (µs))

Serial #	krad(si)	Exposure Conditions	Pre Result	Post Result	Delta
50	20	LDR biased	-6.4249	-6.8768	-0.4519
51	20	LDR biased	-7.0034	-7.7641	-0.7607
52	20	LDR biased	-4.592	-3.8582	0.7338
53	20	LDR biased	-1.0473	-1.1998	-0.1525
54	20	LDR biased	-5.8046	-5.4593	0.3453
55	30	LDR biased	-5.1479	-5.7944	-0.6465
56	30	LDR biased	-5.4573	-5.3124	0.1449
57	30	LDR biased	-4.878	-4.0429	0.8351
58	30	LDR biased	-4.1169	-3.815	0.3019
59	30	LDR biased	-4.866	-5.1664	-0.3004
60	20	LDR unbiased	-4.543	-2.5772	1.9658
61	20	LDR unbiased	-6.8849	-6.5955	0.2894
62	20	LDR unbiased	-5.8466	-5.6754	0.1712
63	20	LDR unbiased	-3.9622	-3.8743	0.0879
64	20	LDR unbiased	-4.1944	-2.6825	1.5119
65	30	LDR unbiased	-5.3577	-3.3586	1.9991
66	30	LDR unbiased	-5.2581	-4.9382	0.3199
67	30	LDR unbiased	-4.7833	-3.1193	1.664
68	30	LDR unbiased	-3.0976	-0.9679	2.1297
69	30	LDR unbiased	-4.2812	-4.2173	0.0639
70	0	correlation	-2.5416	-2.3921	0.1495
71	0	correlation	-7.1427	-6.9801	0.1626
72	0	correlation	-4.1457	-3.6016	0.5441
73	0	correlation	-3.9079	-3.9235	-0.0156
74	0	correlation	-0.7708	-0.7269	0.0439

Test Statistics (µs)

krad(si)	Pre Exposure Min	Pre Exposure Avg	Pre Exposure Max	Pre Exposure Std	Post Exposure Min	Post Exposure Avg	Post Exposure Max	Post Exposure Std	Min Delta	Avg Delta	Max Delta	Std Delta
0	-7.1427	-3.7017	-0.7708	2.3461	-6.9801	-3.5248	-0.7269	2.303	-0.0156	0.1769	0.5441	0.21825
20	-7.0034	-5.0303	-1.0473	1.785	-7.7641	-4.6563	-1.1998	2.146	-0.7607	0.37402	1.9658	0.83904
30	-5.4573	-4.7244	-3.0976	0.71968	-5.7944	-4.0732	-0.9679	1.3981	-0.6465	0.65116	2.1297	0.97097

Device Test: 15.29 UJD1II(TCL_DEGLITCH1_UJD1II)

TID vs Result Stats

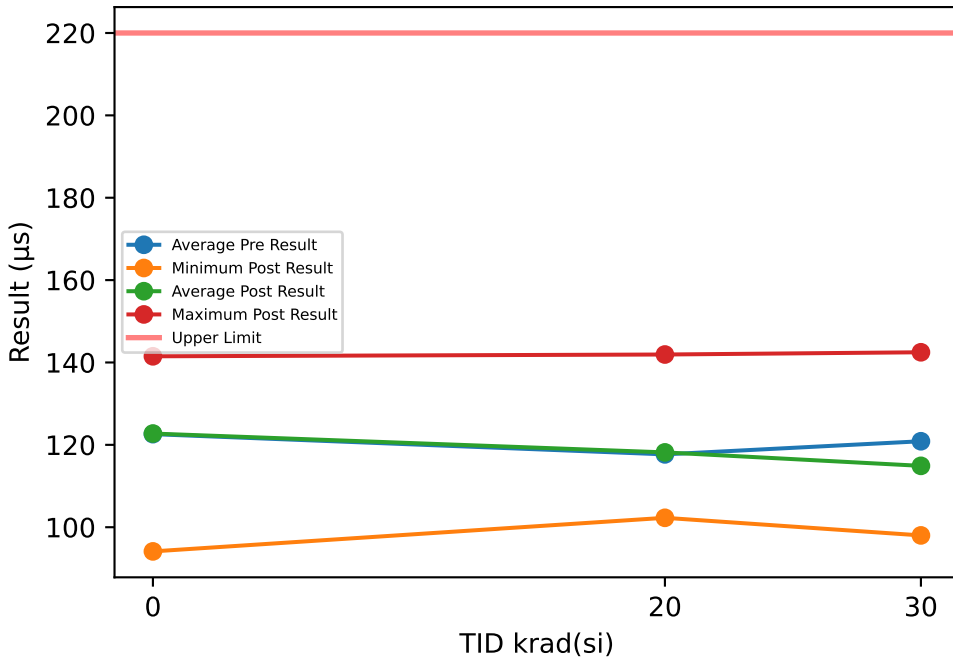

Test Results (Upper Limit = 220.0 (µs))

Serial #	krad(si)	Exposure Conditions	Pre Result	Post Result	Delta
50	20	LDR biased	127.61	103.77	-23.842
51	20	LDR biased	106.49	125.12	18.629
52	20	LDR biased	106.71	115.82	9.1126
53	20	LDR biased	122.5	124.37	1.8761
54	20	LDR biased	111.22	119.86	8.6339
55	30	LDR biased	139.63	110.72	-28.915
56	30	LDR biased	136.31	107.22	-29.093
57	30	LDR biased	110.67	142.48	31.803
58	30	LDR biased	103.45	102.15	-1.3021
59	30	LDR biased	115.82	98.012	-17.808
60	20	LDR unbiased	109.06	102.28	-6.7724
61	20	LDR unbiased	123.62	141.94	18.319
62	20	LDR unbiased	116.37	131.98	15.611
63	20	LDR unbiased	125.44	108.88	-16.564
64	20	LDR unbiased	127.86	107.68	-20.178
65	30	LDR unbiased	123.17	113.25	-9.916
66	30	LDR unbiased	103.35	117.44	14.093
67	30	LDR unbiased	112.79	132.17	19.387
68	30	LDR unbiased	135.42	119.63	-15.791
69	30	LDR unbiased	128.1	105.94	-22.16
70	0	correlation	119.59	122.04	2.4448
71	0	correlation	98.424	119.93	21.503
72	0	correlation	143.62	94.129	-49.491
73	0	correlation	139.89	141.5	1.6101
74	0	correlation	111.47	136.14	24.663

TID vs Post - Pre Exposure Delta

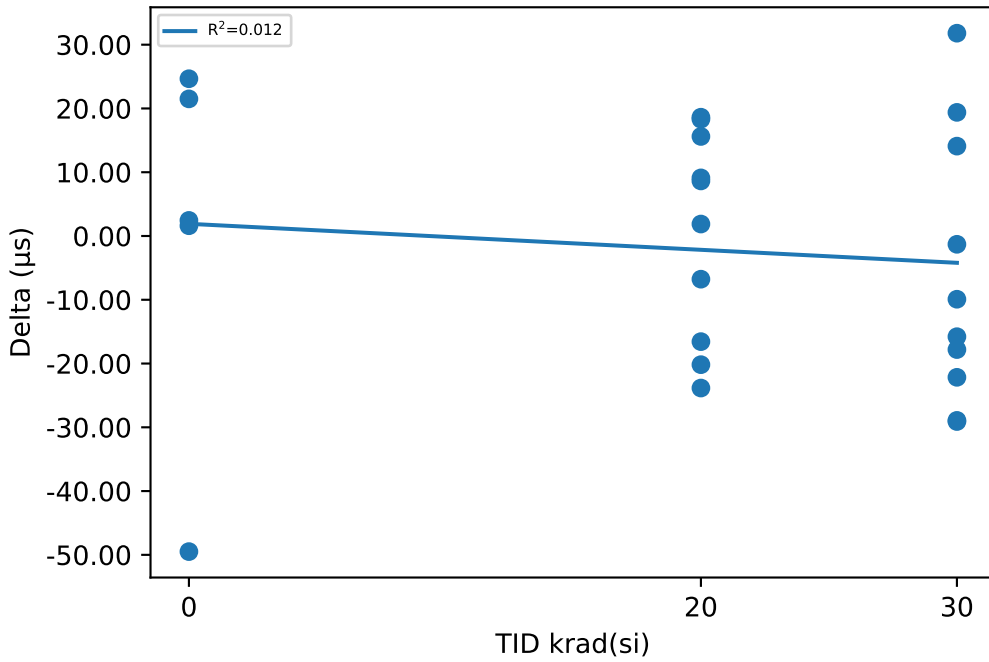

Test Statistics (µs)

krad(si)	Pre Exposure Min	Pre Exposure Avg	Pre Exposure Max	Pre Exposure Std	Post Exposure Min	Post Exposure Avg	Post Exposure Max	Post Exposure Std	Min Delta	Avg Delta	Max Delta	Std Delta
0	98.424	122.6	143.62	19.092	94.129	122.75	141.5	18.428	-49.491	0.14602	24.663	29.7
20	106.49	117.69	127.86	8.7208	102.28	118.17	141.94	12.939	-23.842	0.48256	18.629	16.265
30	103.35	120.87	139.63	13.601	98.012	114.9	142.48	13.723	-29.093	-5.9702	31.803	21.264

Device Test: 15.3 UJP09Y(TRISE_CH1_UJP09Y)

TID vs Result Stats

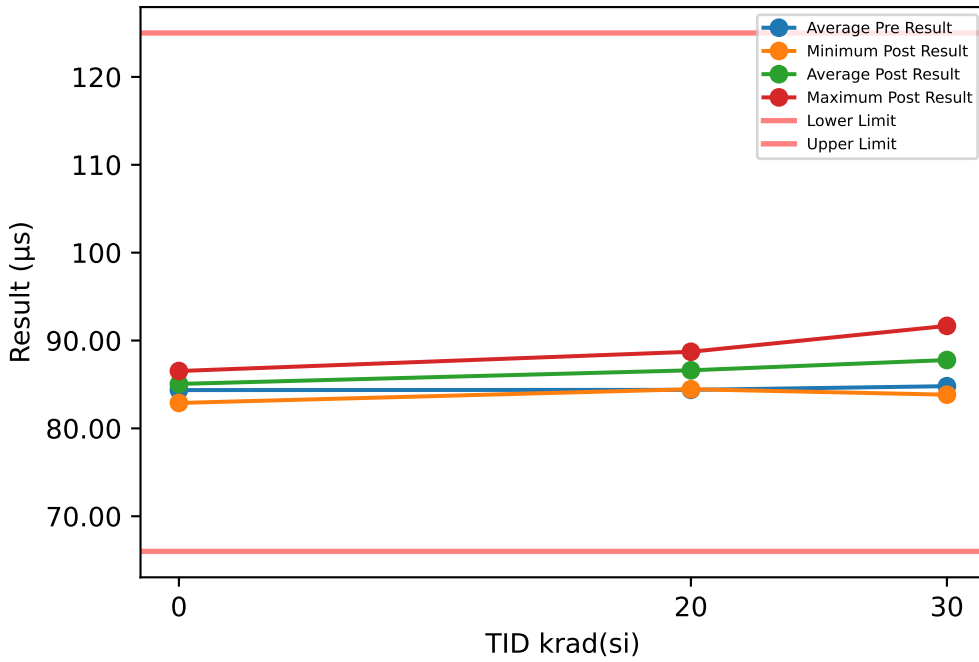

Test Results (Lower Limit = 66.0, Upper Limit = 125.0 (µs))

Serial #	krad(si)	Exposure Conditions	Pre Result	Post Result	Delta
50	20	LDR biased	82.471	85.079	2.6083
51	20	LDR biased	85.302	87.246	1.9432
52	20	LDR biased	84.046	88.24	4.1936
53	20	LDR biased	86.893	88.053	1.1606
54	20	LDR biased	86.716	88.721	2.0048
55	30	LDR biased	87.268	90.091	2.8226
56	30	LDR biased	80.261	83.834	3.5736
57	30	LDR biased	83.368	85.357	1.9894
58	30	LDR biased	85.134	88.387	3.253
59	30	LDR biased	84.937	86.79	1.8521
60	20	LDR unbiased	81.367	84.459	3.0919
61	20	LDR unbiased	85.017	86.349	1.3317
62	20	LDR unbiased	83.444	85.042	1.598
63	20	LDR unbiased	85.568	87.451	1.883
64	20	LDR unbiased	83.026	85.463	2.4372
65	30	LDR unbiased	85.943	89.263	3.3193
66	30	LDR unbiased	84.484	86.658	2.174
67	30	LDR unbiased	88.022	91.665	3.6432
68	30	LDR unbiased	83.792	90.509	6.7165
69	30	LDR unbiased	84.83	85.24	0.4102
70	0	correlation	85.047	86.528	1.4811
71	0	correlation	85.14	85.62	0.4796
72	0	correlation	81.051	82.894	1.8421
73	0	correlation	86.135	85.903	-0.2323
74	0	correlation	84.421	84.348	-0.0728

TID vs Post - Pre Exposure Delta

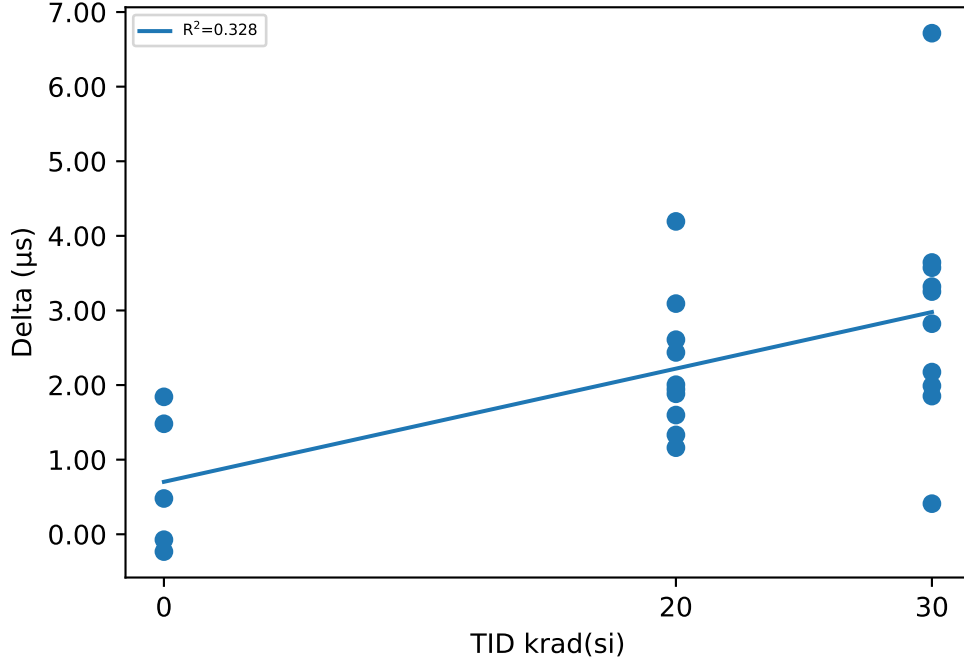

Test Statistics (µs)

krad(si)	Pre Exposure Min	Pre Exposure Avg	Pre Exposure Max	Pre Exposure Std	Post Exposure Min	Post Exposure Avg	Post Exposure Max	Post Exposure Std	Min Delta	Avg Delta	Max Delta	Std Delta
0	81.051	84.359	86.135	1.9481	82.894	85.058	86.528	1.4473	-0.2323	0.69954	1.8421	0.92594
20	81.367	84.385	86.893	1.8252	84.459	86.61	88.721	1.5318	1.1606	2.2252	4.1936	0.90602
30	80.261	84.804	88.022	2.152	83.834	87.779	91.665	2.5943	0.4102	2.9754	6.7165	1.6491

Device Test: 15.4 UJ6AIM(TFALL_CH1_UJ6AIM)

TID vs Result Stats

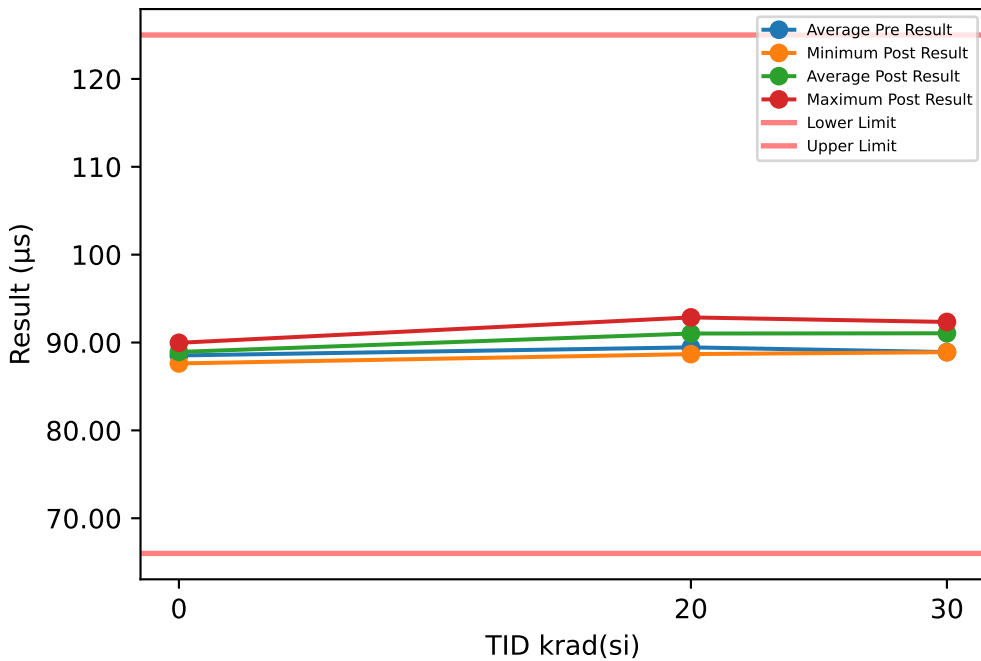

TID vs Post - Pre Exposure Delta

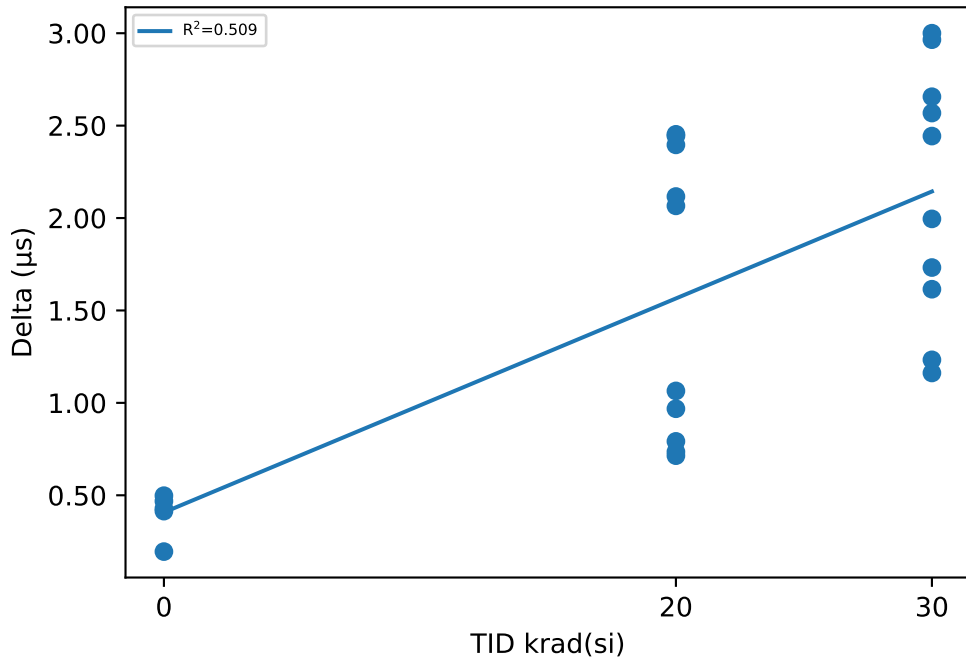

Test Results (Lower Limit = 66.0, Upper Limit = 125.0 (µs))

Serial #	krad(si)	Exposure Conditions	Pre Result	Post Result	Delta
50	20	LDR biased	90.742	92.859	2.1165
51	20	LDR biased	89.707	92.103	2.3959
52	20	LDR biased	90.044	92.109	2.0659
53	20	LDR biased	89.574	92.027	2.453
54	20	LDR biased	90.198	92.642	2.4442
55	30	LDR biased	88.205	90.649	2.4435
56	30	LDR biased	89.773	92.341	2.5681
57	30	LDR biased	89.306	92.306	3.0001
58	30	LDR biased	88.405	91.061	2.6564
59	30	LDR biased	88.508	91.473	2.965
60	20	LDR unbiased	88.38	89.348	0.9682
61	20	LDR unbiased	89.078	90.143	1.0647
62	20	LDR unbiased	90.324	91.038	0.7143
63	20	LDR unbiased	88.558	89.294	0.7354
64	20	LDR unbiased	87.891	88.683	0.7917
65	30	LDR unbiased	90.109	92.104	1.9954
66	30	LDR unbiased	88.354	89.516	1.1618
67	30	LDR unbiased	87.666	88.899	1.2328
68	30	LDR unbiased	90.172	91.787	1.6149
69	30	LDR unbiased	88.637	90.369	1.7322
70	0	correlation	87.204	87.619	0.4142
71	0	correlation	89.044	89.512	0.4683
72	0	correlation	87.552	88.05	0.4979
73	0	correlation	89.539	89.967	0.4281
74	0	correlation	89.297	89.493	0.1953

Test Statistics (µs)

krad(si)	Pre Exposure Min	Pre Exposure Avg	Pre Exposure Max	Pre Exposure Std	Post Exposure Min	Post Exposure Avg	Post Exposure Max	Post Exposure Std	Min Delta	Avg Delta	Max Delta	Std Delta
0	87.204	88.527	89.539	1.0706	87.619	88.928	89.967	1.0278	0.1953	0.40076	0.4979	0.11952
20	87.891	89.45	90.742	0.93901	88.683	91.025	92.859	1.5418	0.7143	1.575	2.453	0.7762
30	87.666	88.913	90.172	0.86766	88.899	91.05	92.341	1.1872	1.1618	2.137	3.0001	0.68355

Device Test: 15.5 UJPEEL(SLEWRATE_ON_CH1_UJPEEL)

TID vs Result Stats

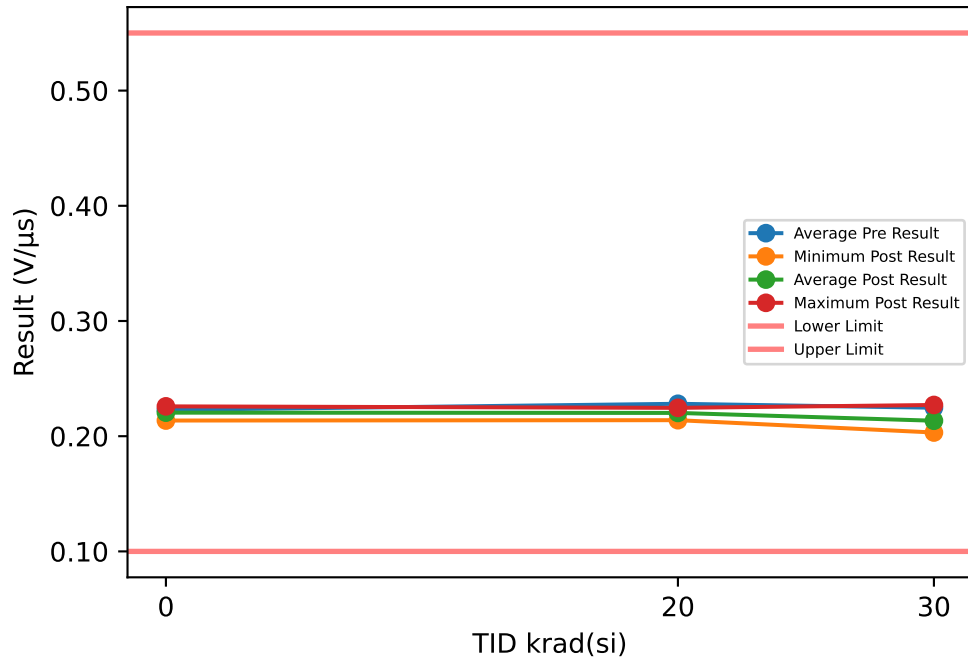

Test Results (Lower Limit = 0.1, Upper Limit = 0.55 (V/μs))

Serial #	krad(si)	Exposure Conditions	Pre Result	Post Result	Delta
50	20	LDR biased	0.2288	0.2208	-0.008
51	20	LDR biased	0.2261	0.2202	-0.0059
52	20	LDR biased	0.2275	0.2148	-0.0127
53	20	LDR biased	0.2217	0.219	-0.0027
54	20	LDR biased	0.2254	0.2195	-0.0059
55	30	LDR biased	0.2199	0.2083	-0.0116
56	30	LDR biased	0.2381	0.2271	-0.011
57	30	LDR biased	0.2261	0.216	-0.0101
58	30	LDR biased	0.2244	0.2124	-0.012
59	30	LDR biased	0.223	0.2171	-0.0059
60	20	LDR unbiased	0.236	0.2237	-0.0123
61	20	LDR unbiased	0.2254	0.2219	-0.0035
62	20	LDR unbiased	0.2338	0.2246	-0.0092
63	20	LDR unbiased	0.2206	0.2139	-0.0067
64	20	LDR unbiased	0.236	0.2237	-0.0123
65	30	LDR unbiased	0.2208	0.2096	-0.0112
66	30	LDR unbiased	0.2244	0.217	-0.0074
67	30	LDR unbiased	0.2153	0.2032	-0.0121
68	30	LDR unbiased	0.2336	0.2085	-0.0251
69	30	LDR unbiased	0.2215	0.2151	-0.0064
70	0	correlation	0.2151	0.2136	-0.0015
71	0	correlation	0.2235	0.2211	-0.0024
72	0	correlation	0.2332	0.2259	-0.0073
73	0	correlation	0.2183	0.2186	0.0003
74	0	correlation	0.2241	0.223	-0.0011

TID vs Post - Pre Exposure Delta

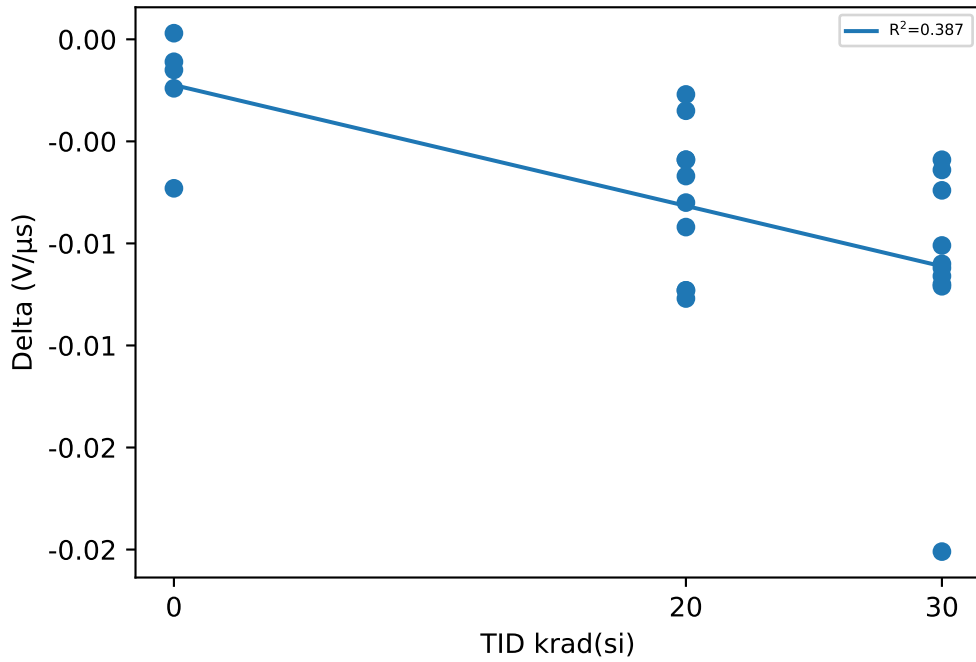

Test Statistics (V/μs)

krad(si)	Pre Exposure Min	Pre Exposure Avg	Pre Exposure Max	Pre Exposure Std	Post Exposure Min	Post Exposure Avg	Post Exposure Max	Post Exposure Std	Min Delta	Avg Delta	Max Delta	Std Delta
0	0.2151	0.22284	0.2332	0.0068897	0.2136	0.22044	0.2259	0.0046629	-0.0073	-0.0024	0.0003	0.0029069
20	0.2206	0.22813	0.236	0.0055171	0.2139	0.22021	0.2246	0.0036192	-0.0127	-0.00792	-0.0027	0.0036408
30	0.2153	0.22471	0.2381	0.0066721	0.2032	0.21343	0.2271	0.0066121	-0.0251	-0.01128	-0.0059	0.0053911

Device Test: 15.6 UJD80I(SLEWRATE_OFF_CH1_UJD80I)

TID vs Result Stats

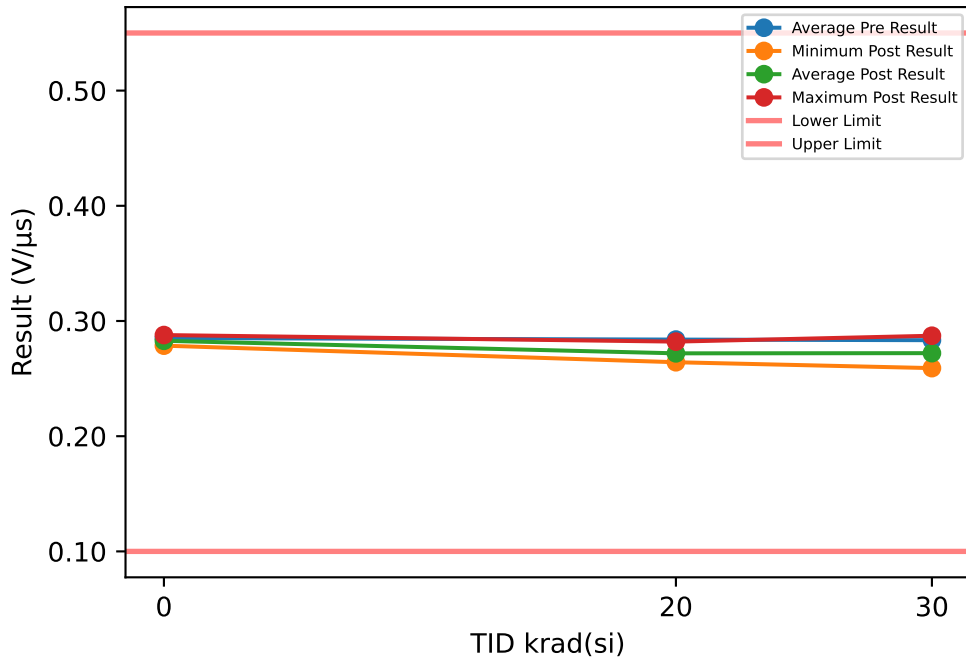

Test Results (Lower Limit = 0.1, Upper Limit = 0.55 (V/μs))

Serial #	krad(si)	Exposure Conditions	Pre Result	Post Result	Delta
50	20	LDR biased	0.2848	0.2703	-0.0145
51	20	LDR biased	0.2807	0.2642	-0.0165
52	20	LDR biased	0.2897	0.2657	-0.024
53	20	LDR biased	0.2764	0.2665	-0.0099
54	20	LDR biased	0.2778	0.2645	-0.0133
55	30	LDR biased	0.283	0.2673	-0.0157
56	30	LDR biased	0.2919	0.2766	-0.0153
57	30	LDR biased	0.2769	0.2616	-0.0153
58	30	LDR biased	0.286	0.2703	-0.0157
59	30	LDR biased	0.2816	0.2709	-0.0107
60	20	LDR unbiased	0.2945	0.2801	-0.0144
61	20	LDR unbiased	0.2807	0.2798	-0.0009
62	20	LDR unbiased	0.2749	0.2703	-0.0046
63	20	LDR unbiased	0.2828	0.2758	-0.007
64	20	LDR unbiased	0.2964	0.2821	-0.0143
65	30	LDR unbiased	0.2761	0.2687	-0.0074
66	30	LDR unbiased	0.2866	0.2872	0.0006
67	30	LDR unbiased	0.2891	0.275	-0.0141
68	30	LDR unbiased	0.2824	0.2591	-0.0233
69	30	LDR unbiased	0.2798	0.2842	0.0044
70	0	correlation	0.2878	0.2869	-0.0009
71	0	correlation	0.2824	0.2801	-0.0023
72	0	correlation	0.2987	0.2878	-0.0109
73	0	correlation	0.2752	0.2786	0.0034
74	0	correlation	0.2818	0.2807	-0.0011

TID vs Post - Pre Exposure Delta

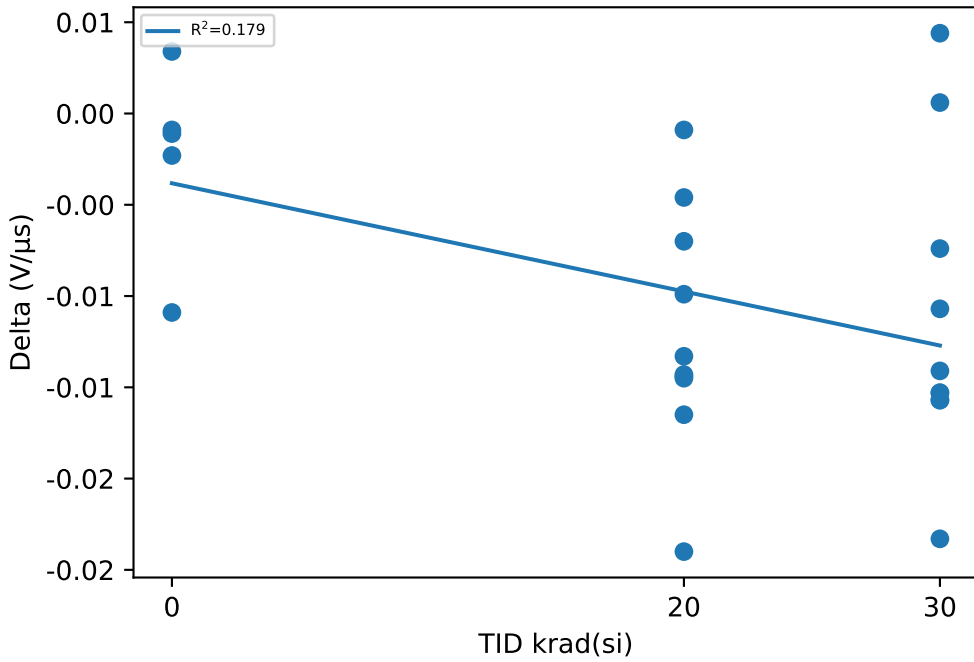

Test Statistics (V/μs)

krad(si)	Pre Exposure Min	Pre Exposure Avg	Pre Exposure Max	Pre Exposure Std	Post Exposure Min	Post Exposure Avg	Post Exposure Max	Post Exposure Std	Min Delta	Avg Delta	Max Delta	Std Delta
0	0.2752	0.28518	0.2987	0.0087808	0.2786	0.28282	0.2878	0.0042175	-0.0109	-0.00236	0.0034	0.00524
20	0.2749	0.28387	0.2964	0.0074476	0.2642	0.27193	0.2821	0.0069575	-0.024	-0.01194	-0.0009	0.0065877
30	0.2761	0.28334	0.2919	0.0051056	0.2591	0.27209	0.2872	0.0089543	-0.0233	-0.01125	0.0044	0.0083414

Device Test: 15.7 UJHGWM(TMATCH_CH1_UJHGWM)

TID vs Result Stats

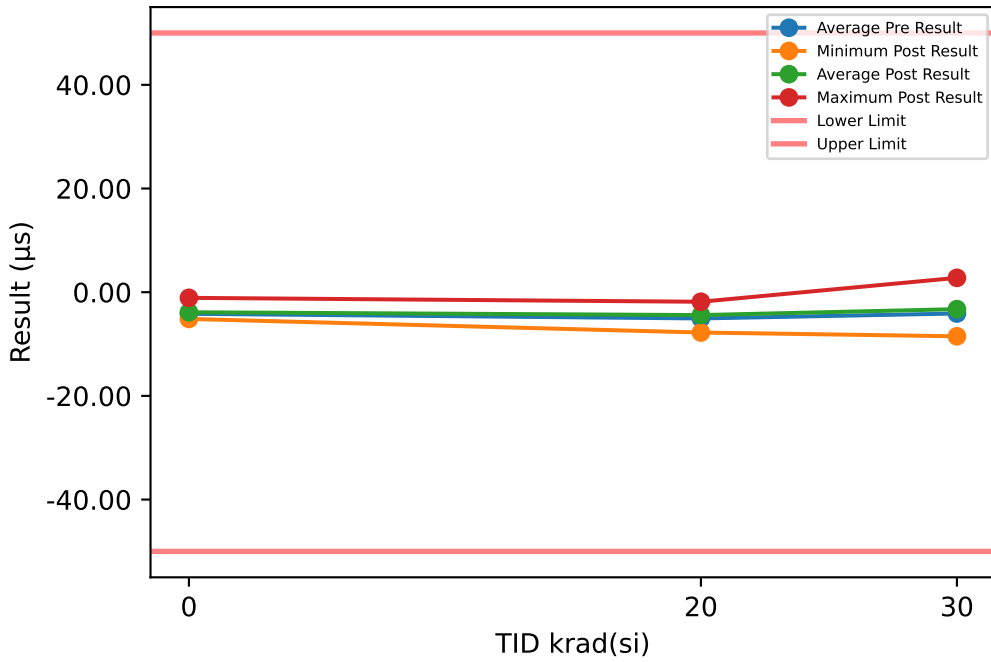

Test Results (Lower Limit = -50.0, Upper Limit = 50.0 (µs))

Serial #	krad(si)	Exposure Conditions	Pre Result	Post Result	Delta
50	20	LDR biased	-8.2711	-7.7793	0.4918
51	20	LDR biased	-4.4049	-4.8576	-0.4527
52	20	LDR biased	-5.9977	-3.8699	2.1278
53	20	LDR biased	-2.6813	-3.9737	-1.2924
54	20	LDR biased	-3.4813	-3.9207	-0.4394
55	30	LDR biased	-0.9373	-0.5581	0.3792
56	30	LDR biased	-9.5122	-8.5067	1.0055
57	30	LDR biased	-5.9384	-6.9491	-1.0107
58	30	LDR biased	-3.2708	-2.6742	0.5966
59	30	LDR biased	-3.5705	-4.6834	-1.1129
60	20	LDR unbiased	-7.0125	-4.8889	2.1236
61	20	LDR unbiased	-4.0612	-3.7942	0.267
62	20	LDR unbiased	-6.88	-5.9963	0.8837
63	20	LDR unbiased	-2.9901	-1.8425	1.1476
64	20	LDR unbiased	-4.8653	-3.2197	1.6456
65	30	LDR unbiased	-4.1654	-2.8415	1.3239
66	30	LDR unbiased	-3.87	-2.8577	1.0123
67	30	LDR unbiased	0.3558	2.7662	2.4104
68	30	LDR unbiased	-6.3796	-1.278	5.1016
69	30	LDR unbiased	-3.8072	-5.1292	-1.322
70	0	correlation	-2.1578	-1.091	1.0668
71	0	correlation	-3.904	-3.8927	0.0113
72	0	correlation	-6.5005	-5.1564	1.3441
73	0	correlation	-3.4038	-4.0642	-0.6604
74	0	correlation	-4.8767	-5.1448	-0.2681

TID vs Post - Pre Exposure Delta

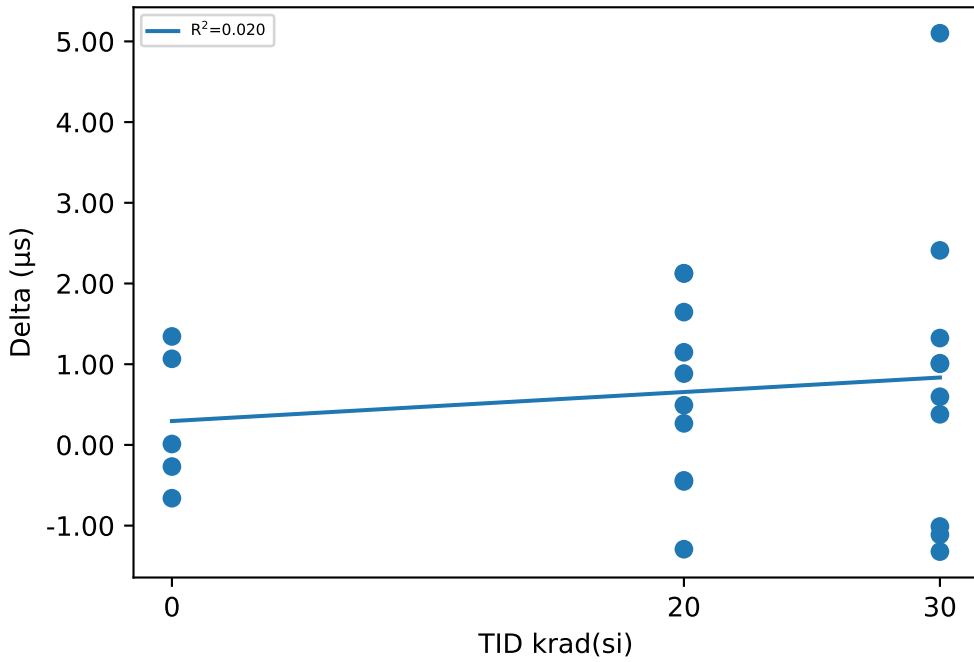

Test Statistics (µs)

krad(si)	Pre Exposure Min	Pre Exposure Avg	Pre Exposure Max	Pre Exposure Std	Post Exposure Min	Post Exposure Avg	Post Exposure Max	Post Exposure Std	Min Delta	Avg Delta	Max Delta	Std Delta
0	-6.5005	-4.1686	-2.1578	1.6308	-5.1564	-3.8698	-1.091	1.6614	-0.6604	0.29874	1.3441	0.86697
20	-8.2711	-5.0645	-2.6813	1.8919	-7.7793	-4.4143	-1.8425	1.6127	-1.2924	0.65026	2.1278	1.1545
30	-9.5122	-4.1096	0.3558	2.7656	-8.5067	-3.2712	2.7662	3.2469	-1.322	0.83839	5.1016	1.9178

Device Test: 15.8 UJ33GQ(TON_DELAY_CH2_UJ33GQ)

TID vs Result Stats

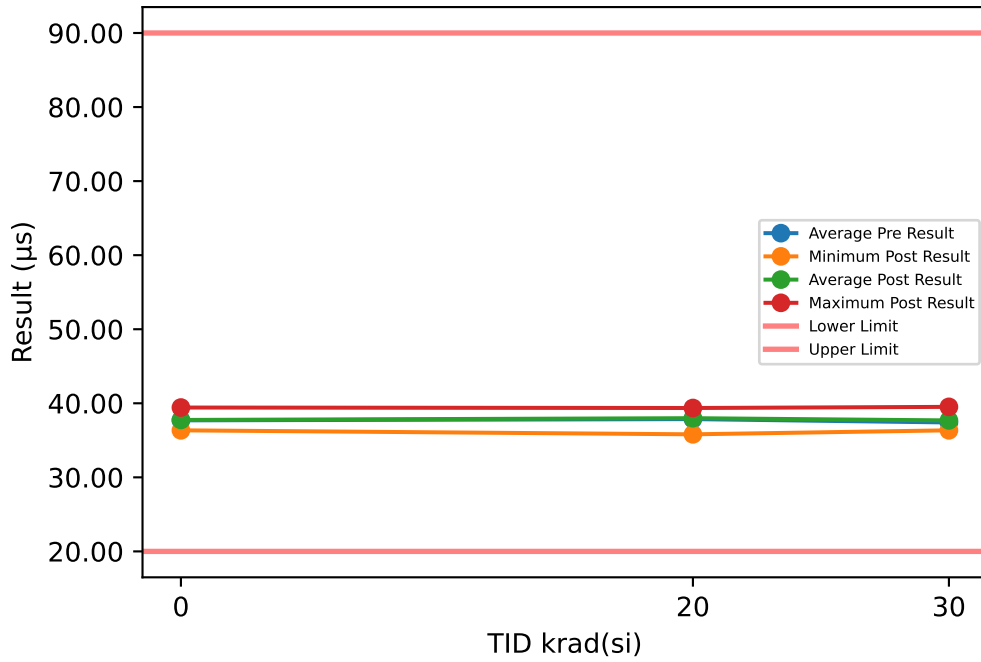

TID vs Post - Pre Exposure Delta

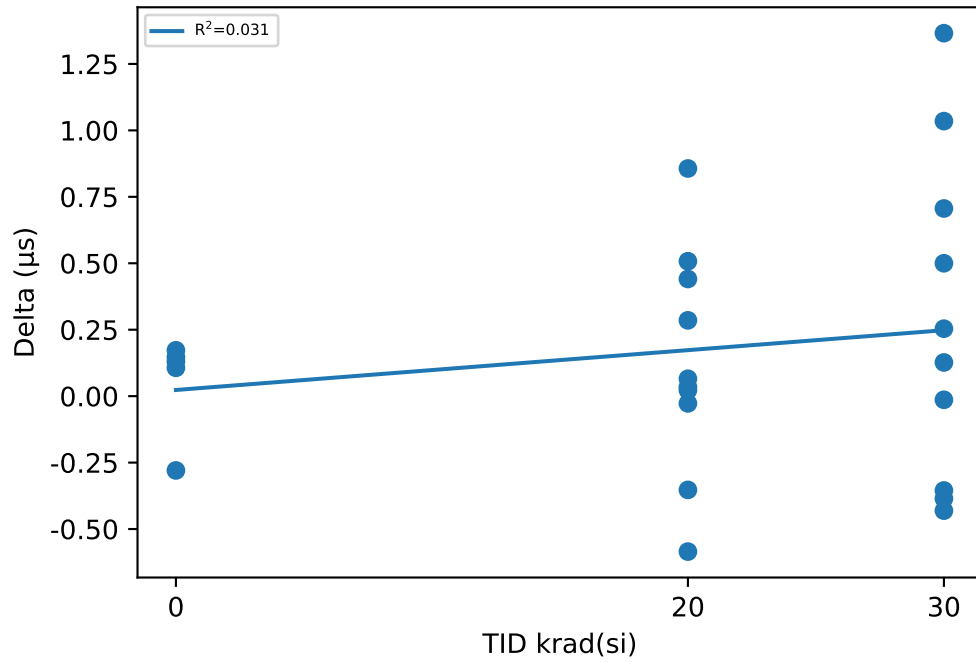

Test Results (Lower Limit = 20.0, Upper Limit = 90.0 (µs))

Serial #	krad(si)	Exposure Conditions	Pre Result	Post Result	Delta
50	20	LDR biased	37.657	38.165	0.5076
51	20	LDR biased	37.372	37.438	0.0655
52	20	LDR biased	35.655	36.511	0.8567
53	20	LDR biased	39.494	38.909	-0.5849
54	20	LDR biased	38.82	38.855	0.0347
55	30	LDR biased	37.148	37.854	0.7062
56	30	LDR biased	37.837	37.452	-0.3856
57	30	LDR biased	36.168	36.668	0.5
58	30	LDR biased	39.39	39.517	0.1268
59	30	LDR biased	36.085	37.12	1.0349
60	20	LDR unbiased	38.683	39.124	0.4409
61	20	LDR unbiased	39.078	39.363	0.2853
62	20	LDR unbiased	35.786	35.809	0.0223
63	20	LDR unbiased	37.367	37.015	-0.3528
64	20	LDR unbiased	38.72	38.693	-0.0272
65	30	LDR unbiased	38.759	38.404	-0.3549
66	30	LDR unbiased	36.364	36.35	-0.0137
67	30	LDR unbiased	36.419	37.784	1.3657
68	30	LDR unbiased	37.835	38.089	0.2539
69	30	LDR unbiased	38.075	37.644	-0.4308
70	0	correlation	36.899	37.005	0.1066
71	0	correlation	37.777	37.949	0.1726
72	0	correlation	36.201	36.348	0.1471
73	0	correlation	38.299	38.02	-0.2795
74	0	correlation	39.296	39.426	0.1302

Test Statistics (µs)

krad(si)	Pre Exposure Min	Pre Exposure Avg	Pre Exposure Max	Pre Exposure Std	Post Exposure Min	Post Exposure Avg	Post Exposure Max	Post Exposure Std	Min Delta	Avg Delta	Max Delta	Std Delta
0	36.201	37.694	39.296	1.2041	36.348	37.75	39.426	1.1662	-0.2795	0.0554	0.1726	0.18876
20	35.655	37.863	39.494	1.3406	35.809	37.988	39.363	1.2242	-0.5849	0.12481	0.8567	0.41964
30	36.085	37.408	39.39	1.1542	36.35	37.688	39.517	0.89852	-0.4308	0.28025	1.3657	0.61828

Device Test: 15.9 UJZB3P(TOFF_DELAY_CH2_UJZB3P)

TID vs Result Stats

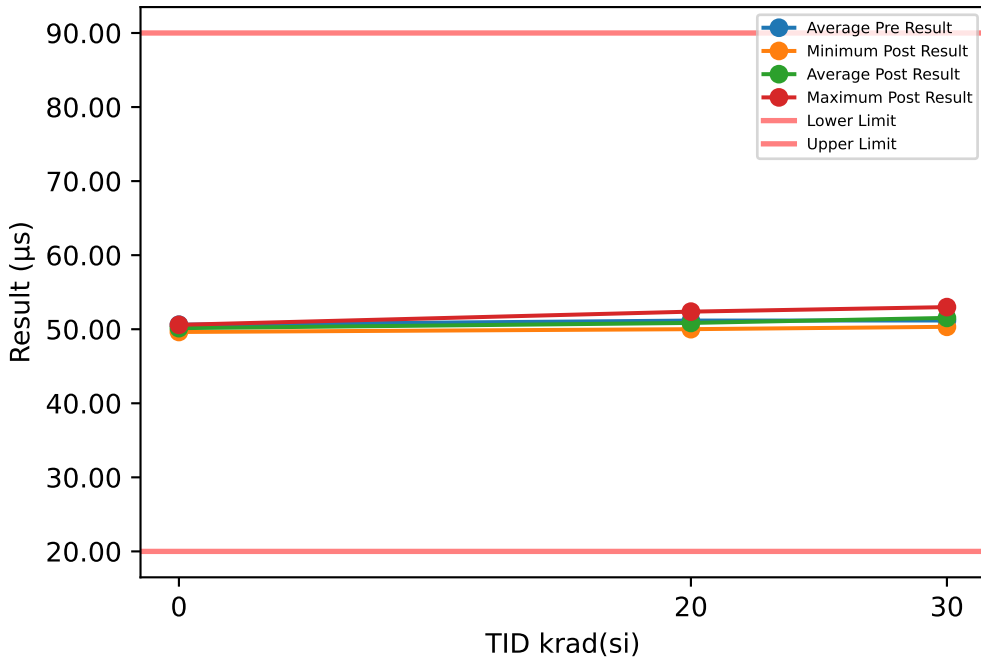

Test Results (Lower Limit = 20.0, Upper Limit = 90.0 (µs))

Serial #	krad(si)	Exposure Conditions	Pre Result	Post Result	Delta
50	20	LDR biased	52.18	52.375	0.1952
51	20	LDR biased	51.633	50.6	-1.0335
52	20	LDR biased	52.507	51.89	-0.617
53	20	LDR biased	49.873	50.282	0.4092
54	20	LDR biased	50.679	50.989	0.3105
55	30	LDR biased	51.457	50.565	-0.8914
56	30	LDR biased	51.498	52.009	0.5106
57	30	LDR biased	51.226	51.797	0.5715
58	30	LDR biased	49.68	50.324	0.6442
59	30	LDR biased	51.404	51.744	0.3401
60	20	LDR unbiased	50.929	50.007	-0.9226
61	20	LDR unbiased	50.378	50.574	0.1956
62	20	LDR unbiased	51.108	51.192	0.084
63	20	LDR unbiased	51.566	50.551	-1.0144
64	20	LDR unbiased	50.834	50.028	-0.8064
65	30	LDR unbiased	51.826	52.381	0.5556
66	30	LDR unbiased	49.935	51.739	1.8049
67	30	LDR unbiased	51.133	50.409	-0.7244
68	30	LDR unbiased	51.732	51.332	-0.3998
69	30	LDR unbiased	51.901	52.986	1.0848
70	0	correlation	49.991	50.085	0.0935
71	0	correlation	51.816	50.591	-1.2246
72	0	correlation	50.95	49.627	-1.3227
73	0	correlation	50.209	50.303	0.0946
74	0	correlation	50.085	50.117	0.0315

TID vs Post - Pre Exposure Delta

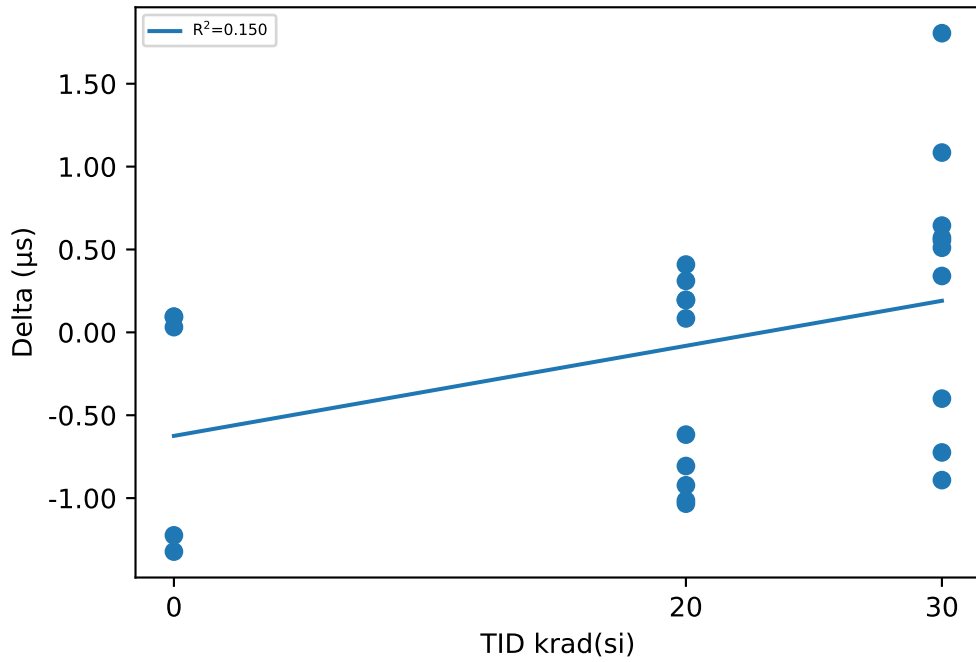

Test Statistics (µs)

krad(si)	Pre Exposure Min	Pre Exposure Avg	Pre Exposure Max	Pre Exposure Std	Post Exposure Min	Post Exposure Avg	Post Exposure Max	Post Exposure Std	Min Delta	Avg Delta	Max Delta	Std Delta
0	49.991	50.61	51.816	0.77271	49.627	50.145	50.591	0.35228	-1.3227	-0.46554	0.0946	0.73896
20	49.873	51.169	52.507	0.81	50.007	50.849	52.375	0.7805	-1.0335	-0.31994	0.4092	0.6058
30	49.68	51.179	51.901	0.76555	50.324	51.529	52.986	0.87655	-0.8914	0.34961	1.8049	0.82449

Device Test: 16.1 UJY13V(TCS_OFF1_UJY13V)

TID vs Result Stats

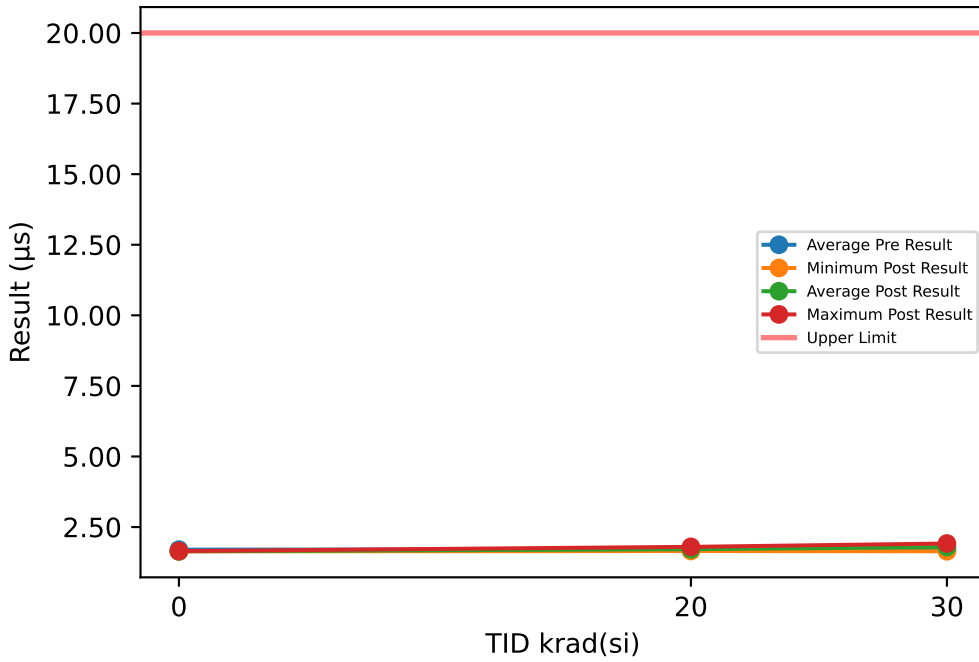

Test Results (Upper Limit = 20.0 (µs))

Serial #	krad(si)	Exposure Conditions	Pre Result	Post Result	Delta
50	20	LDR biased	1.612	1.761	0.149
51	20	LDR biased	1.814	1.68	-0.134
52	20	LDR biased	1.704	1.697	-0.007
53	20	LDR biased	1.76	1.799	0.039
54	20	LDR biased	1.593	1.731	0.138
55	30	LDR biased	1.84	1.843	0.003
56	30	LDR biased	1.705	1.917	0.212
57	30	LDR biased	1.599	1.803	0.204
58	30	LDR biased	1.608	1.837	0.229
59	30	LDR biased	1.83	1.803	-0.027
60	20	LDR unbiased	1.721	1.693	-0.028
61	20	LDR unbiased	1.721	1.652	-0.069
62	20	LDR unbiased	1.563	1.69	0.127
63	20	LDR unbiased	1.829	1.704	-0.125
64	20	LDR unbiased	1.759	1.745	-0.014
65	30	LDR unbiased	1.68	1.642	-0.038
66	30	LDR unbiased	1.627	1.839	0.212
67	30	LDR unbiased	1.816	1.801	-0.015
68	30	LDR unbiased	1.634	1.675	0.041
69	30	LDR unbiased	1.751	1.761	0.01
70	0	correlation	1.606	1.65	0.044
71	0	correlation	1.815	1.64	-0.175
72	0	correlation	1.722	1.641	-0.081
73	0	correlation	1.71	1.638	-0.072
74	0	correlation	1.648	1.639	-0.009

TID vs Post - Pre Exposure Delta

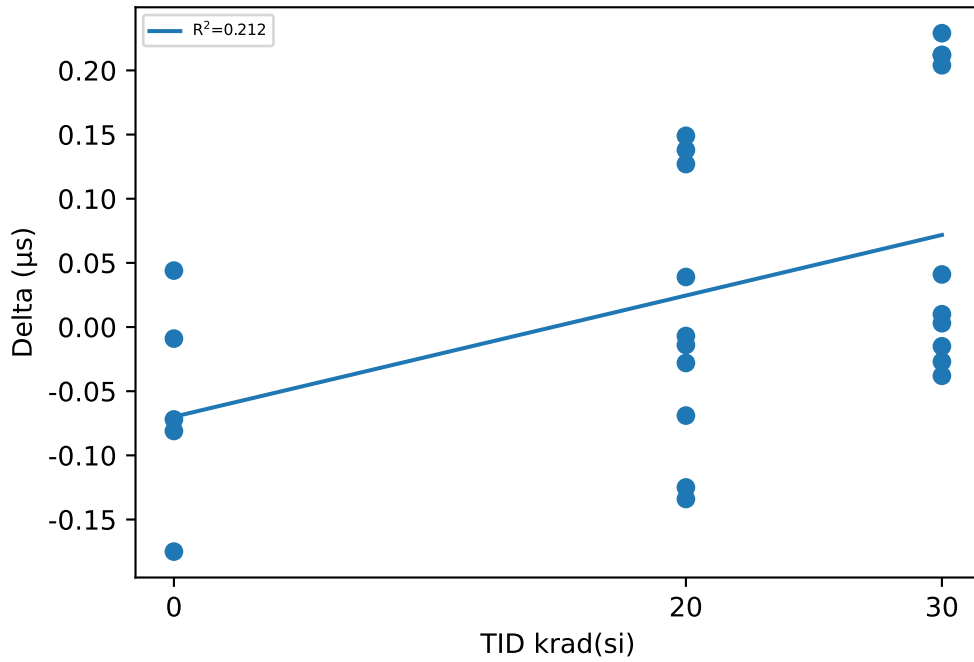

Test Statistics (µs)

krad(si)	Pre Exposure Min	Pre Exposure Avg	Pre Exposure Max	Pre Exposure Std	Post Exposure Min	Post Exposure Avg	Post Exposure Max	Post Exposure Std	Min Delta	Avg Delta	Max Delta	Std Delta
0	1.606	1.7002	1.815	0.079607	1.638	1.6416	1.65	0.004827	-0.175	-0.0586	0.044	0.082488
20	1.563	1.7076	1.829	0.091287	1.652	1.7152	1.799	0.043558	-0.134	0.0076	0.149	0.10418
30	1.599	1.709	1.84	0.094588	1.642	1.7921	1.917	0.081604	-0.038	0.0831	0.229	0.11503

Device Test: 16.2 UJXNQ0(TCS_ON1_UJXNQ0)

TID vs Result Stats

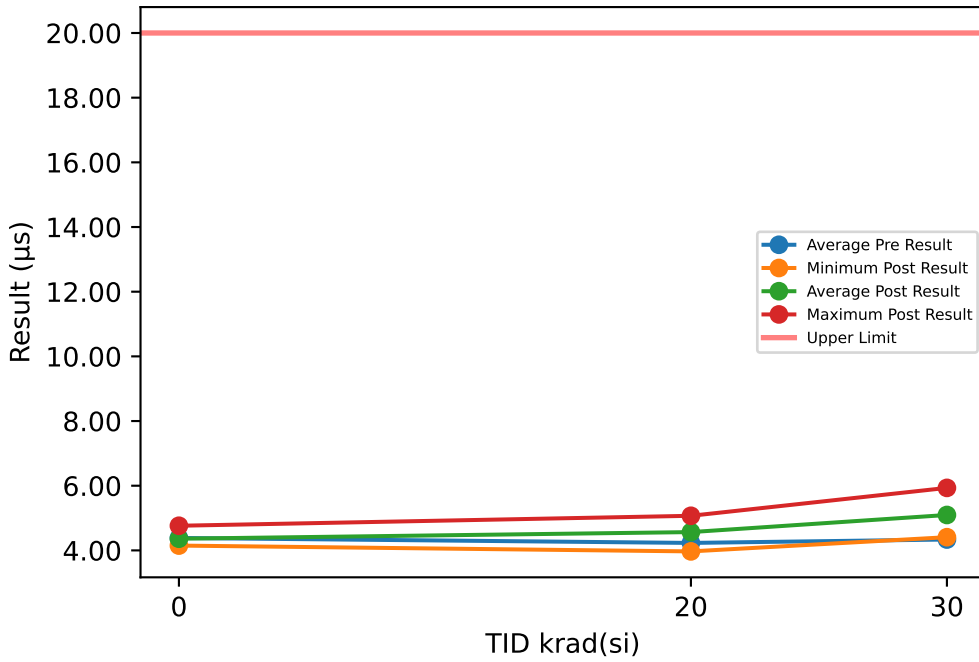

Test Results (Upper Limit = 20.0 (µs))

Serial #	krad(si)	Exposure Conditions	Pre Result	Post Result	Delta
50	20	LDR biased	4.04	4.496	0.456
51	20	LDR biased	4.48	4.865	0.385
52	20	LDR biased	4.105	4.681	0.576
53	20	LDR biased	4.401	5.07	0.669
54	20	LDR biased	4.251	4.85	0.599
55	30	LDR biased	4.56	5.933	1.373
56	30	LDR biased	4.305	5.562	1.257
57	30	LDR biased	4.403	5.524	1.121
58	30	LDR biased	4.321	5.361	1.04
59	30	LDR biased	4.44	5.479	1.039
60	20	LDR unbiased	4.178	4.366	0.188
61	20	LDR unbiased	4.202	4.36	0.158
62	20	LDR unbiased	4.172	4.324	0.152
63	20	LDR unbiased	4.575	4.678	0.103
64	20	LDR unbiased	3.906	3.969	0.063
65	30	LDR unbiased	4.19	4.543	0.353
66	30	LDR unbiased	4.388	4.899	0.511
67	30	LDR unbiased	4.281	4.482	0.201
68	30	LDR unbiased	4.322	4.762	0.44
69	30	LDR unbiased	4.152	4.408	0.256
70	0	correlation	4.192	4.233	0.041
71	0	correlation	4.481	4.365	-0.116
72	0	correlation	4.171	4.149	-0.022
73	0	correlation	4.347	4.298	-0.049
74	0	correlation	4.731	4.762	0.031

TID vs Post - Pre Exposure Delta

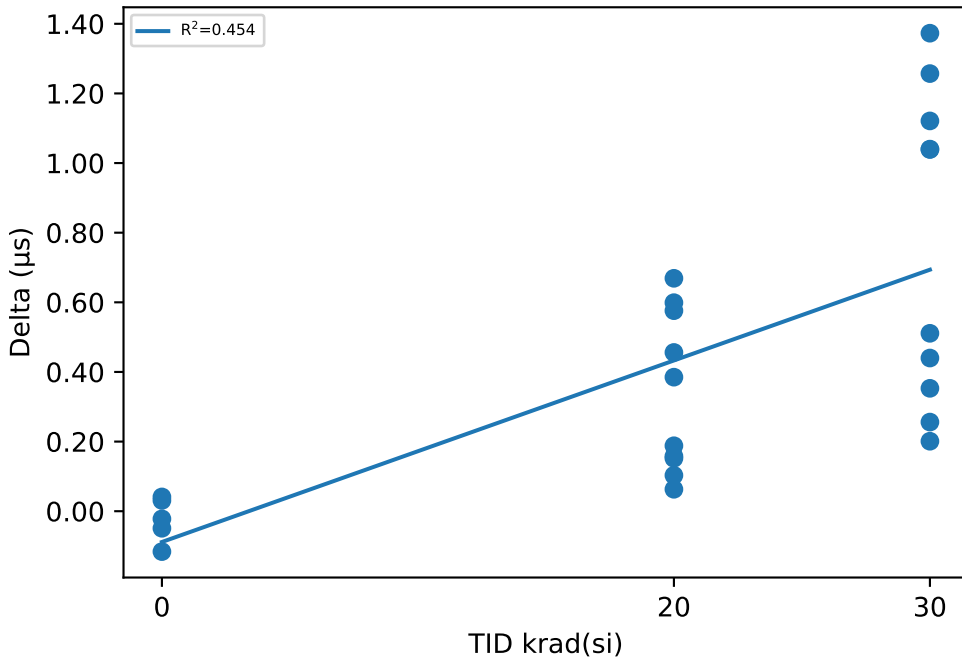

Test Statistics (µs)

krad(si)	Pre Exposure Min	Pre Exposure Avg	Pre Exposure Max	Pre Exposure Std	Post Exposure Min	Post Exposure Avg	Post Exposure Max	Post Exposure Std	Min Delta	Avg Delta	Max Delta	Std Delta
0	4.171	4.3844	4.731	0.23099	4.149	4.3614	4.762	0.23776	-0.116	-0.023	0.041	0.06391
20	3.906	4.231	4.575	0.20406	3.969	4.5659	5.07	0.32526	0.063	0.3349	0.669	0.22869
30	4.152	4.3362	4.56	0.11915	4.408	5.0953	5.933	0.53999	0.201	0.7591	1.373	0.44794

Device Test: 16.3 UJRKCS(TCS_OFF2_UJRKCS)

TID vs Result Stats

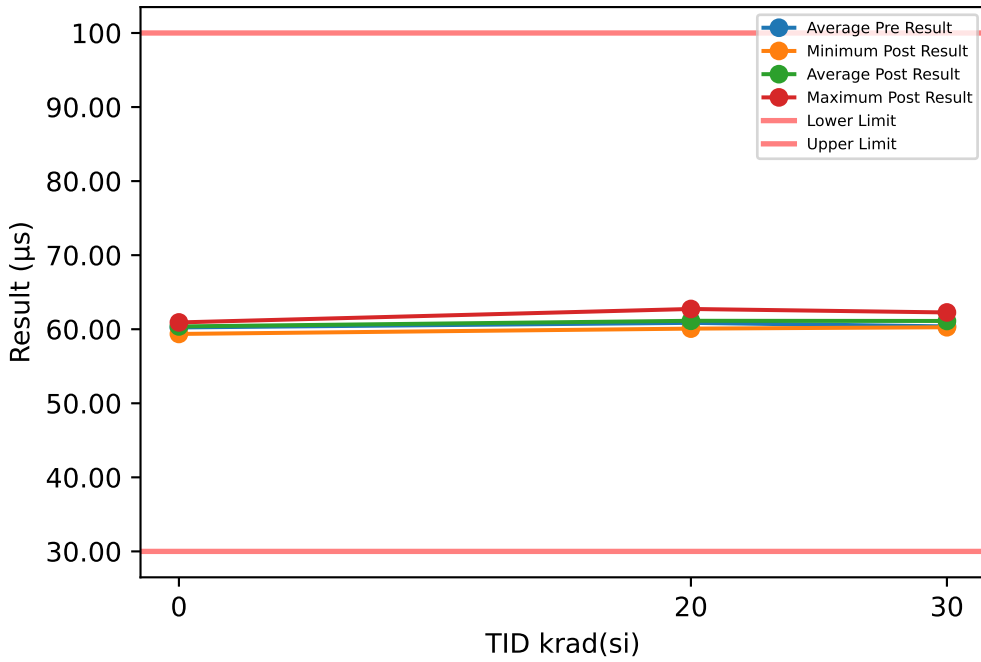

TID vs Post - Pre Exposure Delta

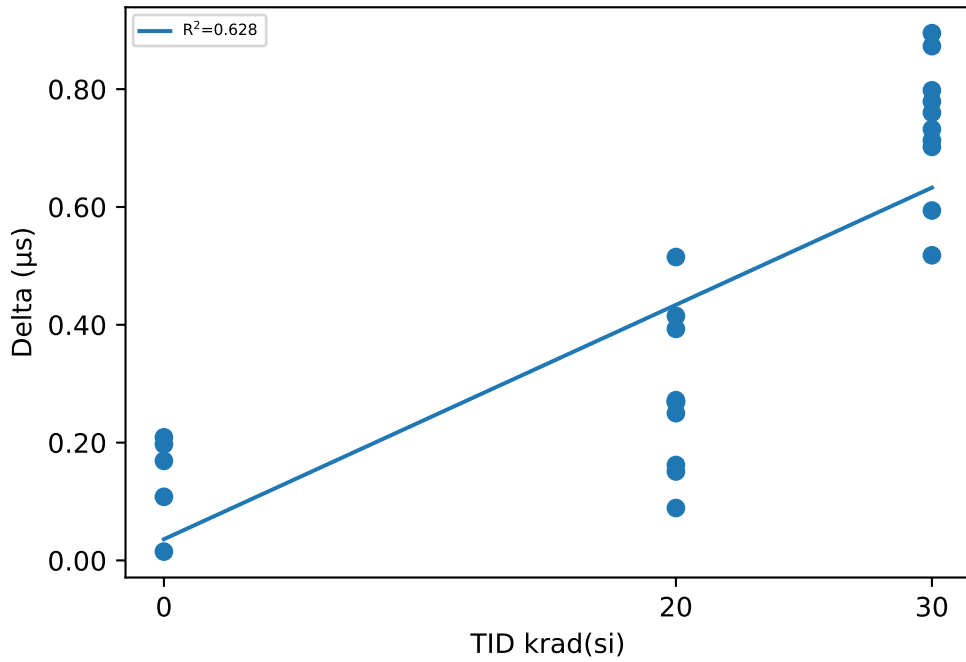

Test Results (Lower Limit = 30.0, Upper Limit = 100.0 (µs))

Serial #	krad(si)	Exposure Conditions	Pre Result	Post Result	Delta
50	20	LDR biased	62.342	62.735	0.393
51	20	LDR biased	60.692	60.942	0.25
52	20	LDR biased	61.167	61.436	0.269
53	20	LDR biased	61.186	61.275	0.089
54	20	LDR biased	61.22	61.735	0.515
55	30	LDR biased	59.829	60.347	0.518
56	30	LDR biased	61.198	61.958	0.76
57	30	LDR biased	60.828	61.723	0.895
58	30	LDR biased	60.086	60.884	0.798
59	30	LDR biased	59.656	60.529	0.873
60	20	LDR unbiased	60.222	60.494	0.272
61	20	LDR unbiased	61.089	61.251	0.162
62	20	LDR unbiased	60.87	61.139	0.269
63	20	LDR unbiased	59.931	60.082	0.151
64	20	LDR unbiased	59.882	60.297	0.415
65	30	LDR unbiased	61.553	62.266	0.713
66	30	LDR unbiased	59.996	60.728	0.732
67	30	LDR unbiased	59.672	60.266	0.594
68	30	LDR unbiased	60.579	61.358	0.779
69	30	LDR unbiased	60.401	61.103	0.702
70	0	correlation	59.256	59.364	0.108
71	0	correlation	60.435	60.632	0.197
72	0	correlation	59.916	60.125	0.209
73	0	correlation	60.903	60.918	0.015
74	0	correlation	60.679	60.848	0.169

Test Statistics (µs)

krad(si)	Pre Exposure Min	Pre Exposure Avg	Pre Exposure Max	Pre Exposure Std	Post Exposure Min	Post Exposure Avg	Post Exposure Max	Post Exposure Std	Min Delta	Avg Delta	Max Delta	Std Delta
0	59.256	60.238	60.903	0.66021	59.364	60.377	60.918	0.64599	0.015	0.1396	0.209	0.079842
20	59.882	60.86	62.342	0.73286	60.082	61.139	62.735	0.76759	0.089	0.2785	0.515	0.131
30	59.656	60.38	61.553	0.65394	60.266	61.116	62.266	0.69294	0.518	0.7364	0.895	0.11533

Device Test: 16.4 UJJ1V5(TCS_ON2_UJJ1V5)

TID vs Result Stats

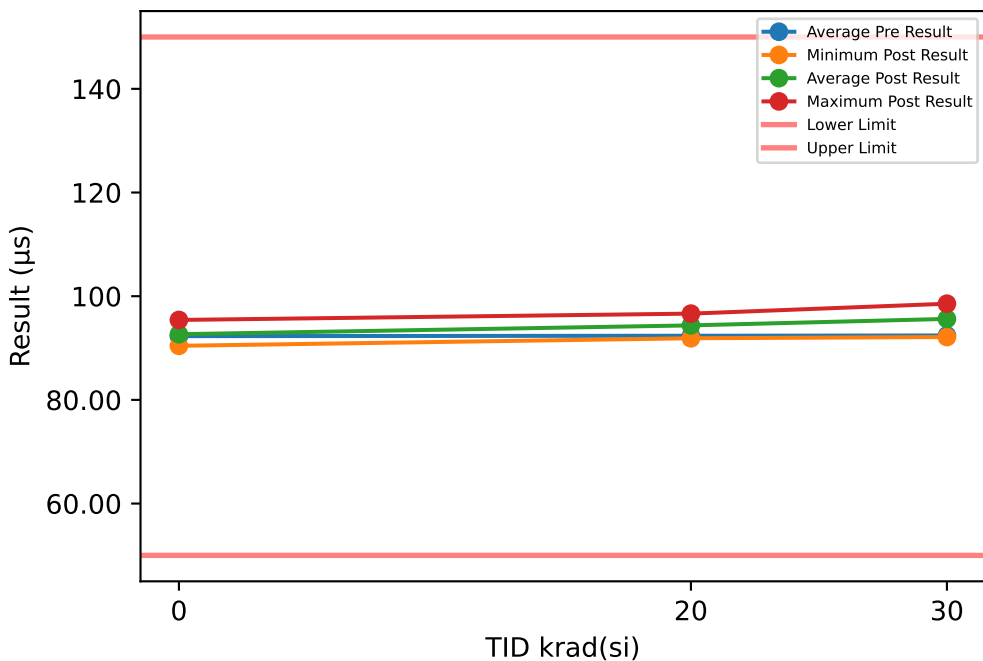

Test Results (Lower Limit = 50.0, Upper Limit = 150.0 (µs))

Serial #	krad(si)	Exposure Conditions	Pre Result	Post Result	Delta
50	20	LDR biased	89.665	92.66	2.995
51	20	LDR biased	93.071	96.049	2.978
52	20	LDR biased	92.523	95.448	2.925
53	20	LDR biased	94.063	95.612	1.549
54	20	LDR biased	94.424	96.637	2.213
55	30	LDR biased	93.754	96.577	2.823
56	30	LDR biased	88.934	92.121	3.187
57	30	LDR biased	91.202	92.856	1.654
58	30	LDR biased	91.562	94.508	2.946
59	30	LDR biased	93.926	97.418	3.492
60	20	LDR unbiased	90.229	91.886	1.657
61	20	LDR unbiased	92.286	93.524	1.238
62	20	LDR unbiased	92.042	93.54	1.498
63	20	LDR unbiased	93.195	95.063	1.868
64	20	LDR unbiased	92.221	93.267	1.046
65	30	LDR unbiased	92.418	95.804	3.386
66	30	LDR unbiased	91.792	95.904	4.112
67	30	LDR unbiased	95.037	98.55	3.513
68	30	LDR unbiased	94.151	98.326	4.175
69	30	LDR unbiased	91.488	94.115	2.627
70	0	correlation	94.941	95.418	0.477
71	0	correlation	92.473	93.022	0.549
72	0	correlation	90.452	90.429	-0.023
73	0	correlation	93.078	93.041	-0.037
74	0	correlation	90.514	91.411	0.897

TID vs Post - Pre Exposure Delta

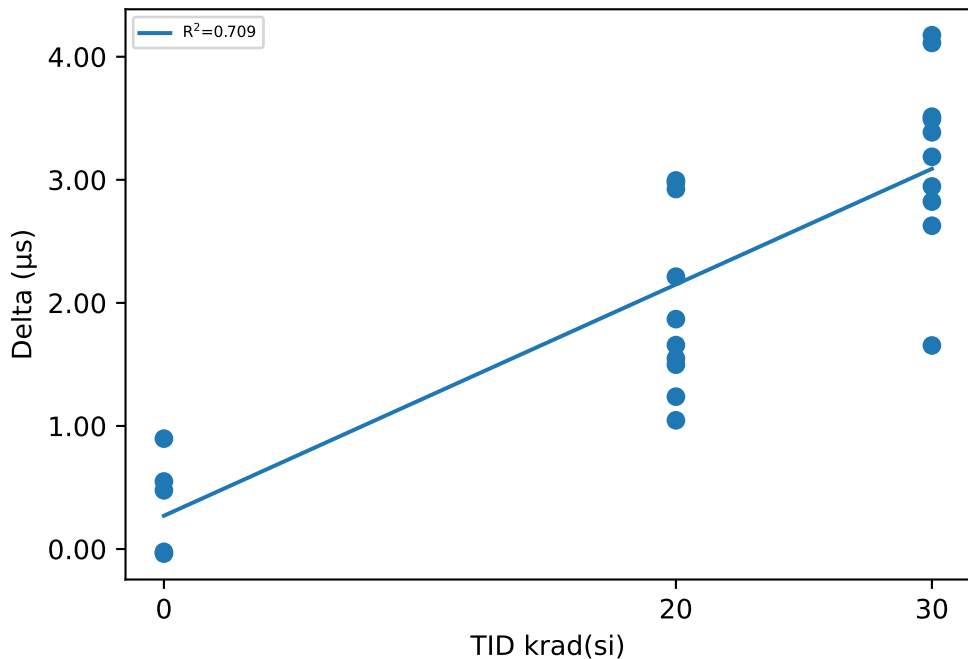

Test Statistics (µs)

krad(si)	Pre Exposure Min	Pre Exposure Avg	Pre Exposure Max	Pre Exposure Std	Post Exposure Min	Post Exposure Avg	Post Exposure Max	Post Exposure Std	Min Delta	Avg Delta	Max Delta	Std Delta
0	90.452	92.292	94.941	1.8851	90.429	92.664	95.418	1.8987	-0.037	0.3726	0.897	0.4004
20	89.665	92.372	94.424	1.5025	91.886	94.369	96.637	1.5937	1.046	1.9967	2.995	0.74002
30	88.934	92.426	95.037	1.8113	92.121	95.618	98.55	2.1999	1.654	3.1915	4.175	0.73972

Device Test: 16.5 UJSI7E(TMUX_UJSI7E)

TID vs Result Stats

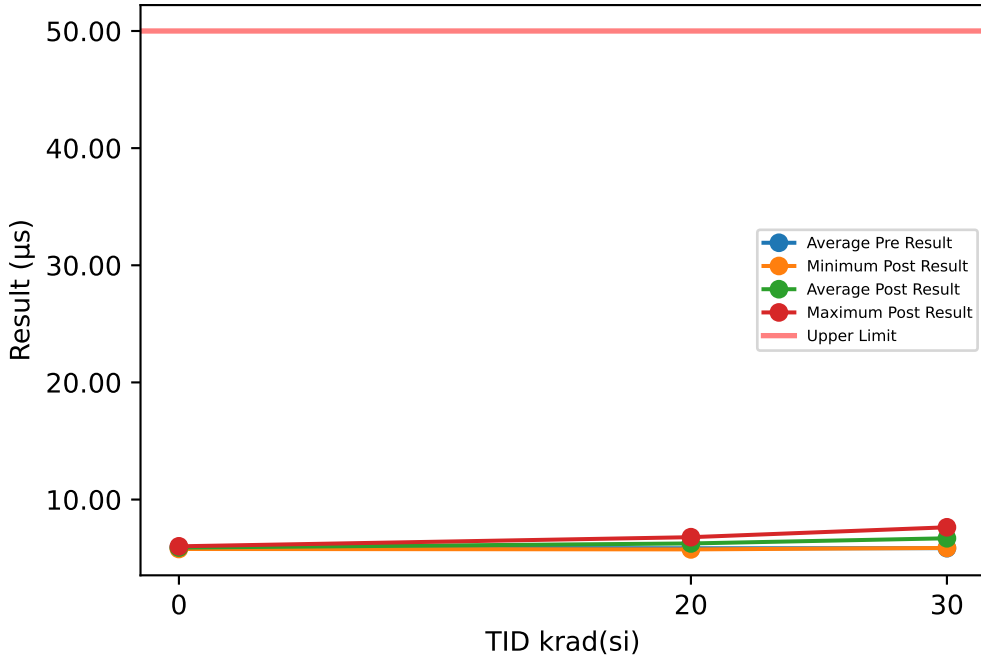

Test Results (Upper Limit = 50.0 (µs))

Serial #	krad(si)	Exposure Conditions	Pre Result	Post Result	Delta
50	20	LDR biased	5.771	6.407	0.636
51	20	LDR biased	6.037	6.593	0.556
52	20	LDR biased	5.783	6.546	0.763
53	20	LDR biased	5.968	6.787	0.819
54	20	LDR biased	5.77	6.643	0.873
55	30	LDR biased	5.984	7.632	1.648
56	30	LDR biased	5.897	7.443	1.546
57	30	LDR biased	5.826	7.315	1.489
58	30	LDR biased	5.795	7.336	1.541
59	30	LDR biased	5.863	7.006	1.143
60	20	LDR unbiased	5.751	6.072	0.321
61	20	LDR unbiased	5.851	5.993	0.142
62	20	LDR unbiased	5.717	5.766	0.049
63	20	LDR unbiased	6.047	5.97	-0.077
64	20	LDR unbiased	5.705	5.745	0.04
65	30	LDR unbiased	5.803	5.868	0.065
66	30	LDR unbiased	5.804	6.039	0.235
67	30	LDR unbiased	5.892	6.035	0.143
68	30	LDR unbiased	5.886	6.354	0.468
69	30	LDR unbiased	5.757	5.907	0.15
70	0	correlation	5.76	5.872	0.112
71	0	correlation	6.018	5.88	-0.138
72	0	correlation	5.821	5.966	0.145
73	0	correlation	5.916	5.78	-0.136
74	0	correlation	5.986	6.008	0.022

TID vs Post - Pre Exposure Delta

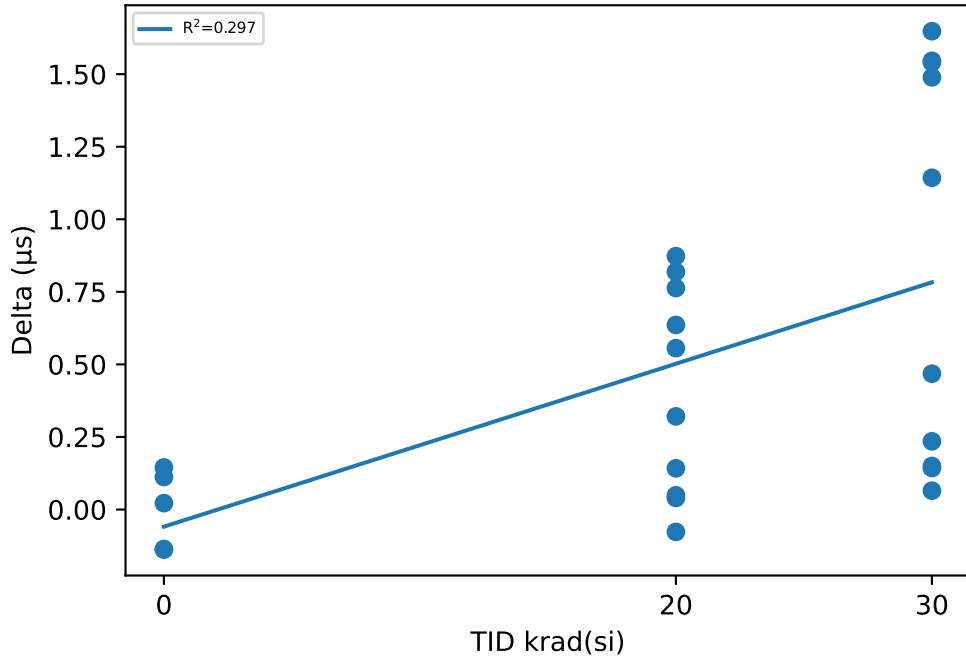

Test Statistics (µs)

krad(si)	Pre Exposure Min	Pre Exposure Avg	Pre Exposure Max	Pre Exposure Std	Post Exposure Min	Post Exposure Avg	Post Exposure Max	Post Exposure Std	Min Delta	Avg Delta	Max Delta	Std Delta
0	5.76	5.9002	6.018	0.10888	5.78	5.9012	6.008	0.088877	-0.138	0.001	0.145	0.13378
20	5.705	5.84	6.047	0.13011	5.745	6.2522	6.787	0.38559	-0.077	0.4122	0.873	0.35943
30	5.757	5.8507	5.984	0.066637	5.868	6.6935	7.632	0.7162	0.065	0.8428	1.648	0.68496

Device Test: 5.1 UJTKLS(Iop_5V_UJTKLS)

TID vs Result Stats

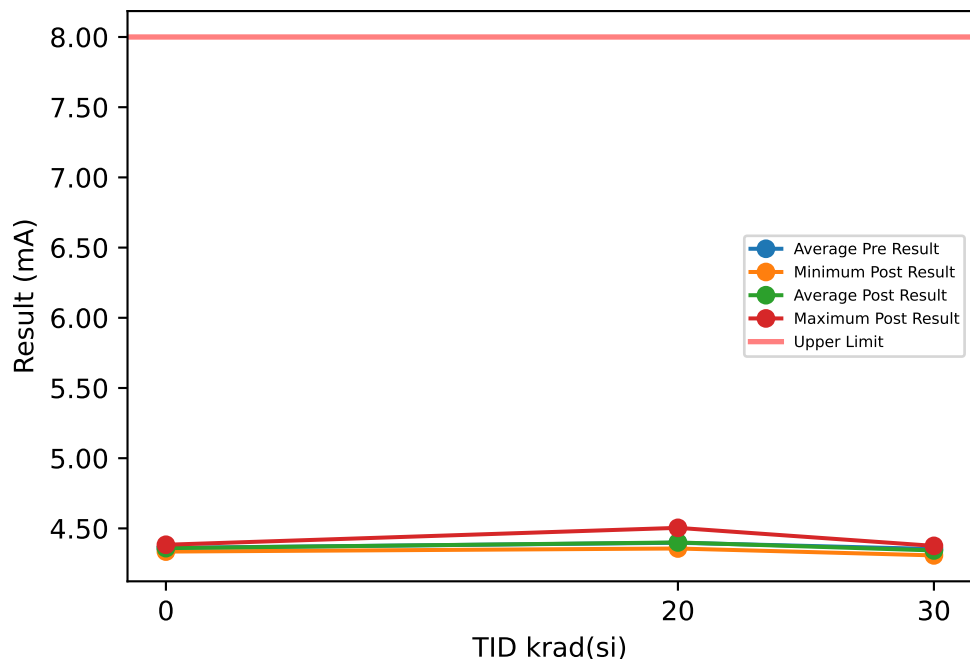

Test Results (Upper Limit = 8.0 (mA))

Serial #	krad(si)	Exposure Conditions	Pre Result	Post Result	Delta
50	20	LDR biased	4.5059	4.5039	-0.002
51	20	LDR biased	4.3459	4.3568	0.0109
52	20	LDR biased	4.3775	4.3751	-0.0024
53	20	LDR biased	4.387	4.3975	0.0105
54	20	LDR biased	4.3722	4.366	-0.0062
55	30	LDR biased	4.3748	4.3755	0.0007
56	30	LDR biased	4.3118	4.3077	-0.0041
57	30	LDR biased	4.3519	4.3468	-0.0051
58	30	LDR biased	4.3278	4.3169	-0.0109
59	30	LDR biased	4.3475	4.3424	-0.0051
60	20	LDR unbiased	4.372	4.3724	0.0004
61	20	LDR unbiased	4.3675	4.366	-0.0015
62	20	LDR unbiased	4.4385	4.4316	-0.0069
63	20	LDR unbiased	4.4151	4.4254	0.0103
64	20	LDR unbiased	4.3962	4.4051	0.0089
65	30	LDR unbiased	4.3677	4.343	-0.0247
66	30	LDR unbiased	4.3681	4.3508	-0.0173
67	30	LDR unbiased	4.359	4.3468	-0.0122
68	30	LDR unbiased	4.3313	4.3268	-0.0045
69	30	LDR unbiased	4.3938	4.3718	-0.022
70	0	correlation	4.3921	4.3835	-0.0086
71	0	correlation	4.3531	4.3553	0.0022
72	0	correlation	4.3287	4.3348	0.0061
73	0	correlation	4.3443	4.3405	-0.0038
74	0	correlation	4.3876	4.3825	-0.0051

TID vs Post - Pre Exposure Delta

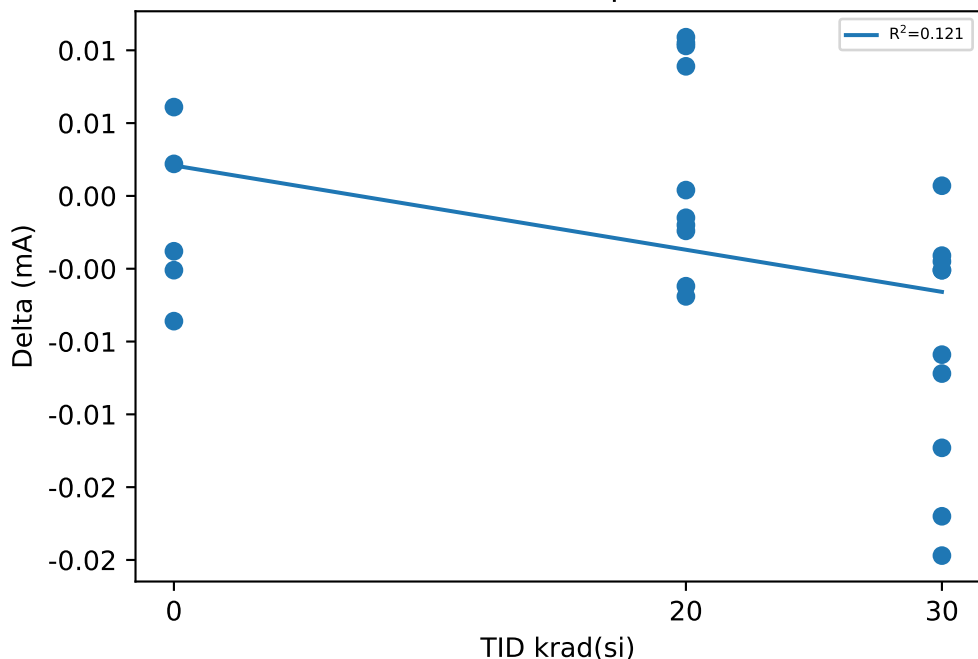

Test Statistics (mA)

krad(si)	Pre Exposure Min	Pre Exposure Avg	Pre Exposure Max	Pre Exposure Std	Post Exposure Min	Post Exposure Avg	Post Exposure Max	Post Exposure Std	Min Delta	Avg Delta	Max Delta	Std Delta
0	4.3287	4.3612	4.3921	0.027655	4.3348	4.3593	4.3835	0.022878	-0.0086	-0.00184	0.0061	0.0059062
20	4.3459	4.3978	4.5059	0.046074	4.3568	4.4	4.5039	0.04476	-0.0069	0.0022	0.0109	0.0071816
30	4.3118	4.3534	4.3938	0.024616	4.3077	4.3429	4.3755	0.021513	-0.0247	-0.01052	0.0007	0.0084584

Device Test: 5.10 UJKFAE(IQ_12V_UJKFAE)

TID vs Result Stats

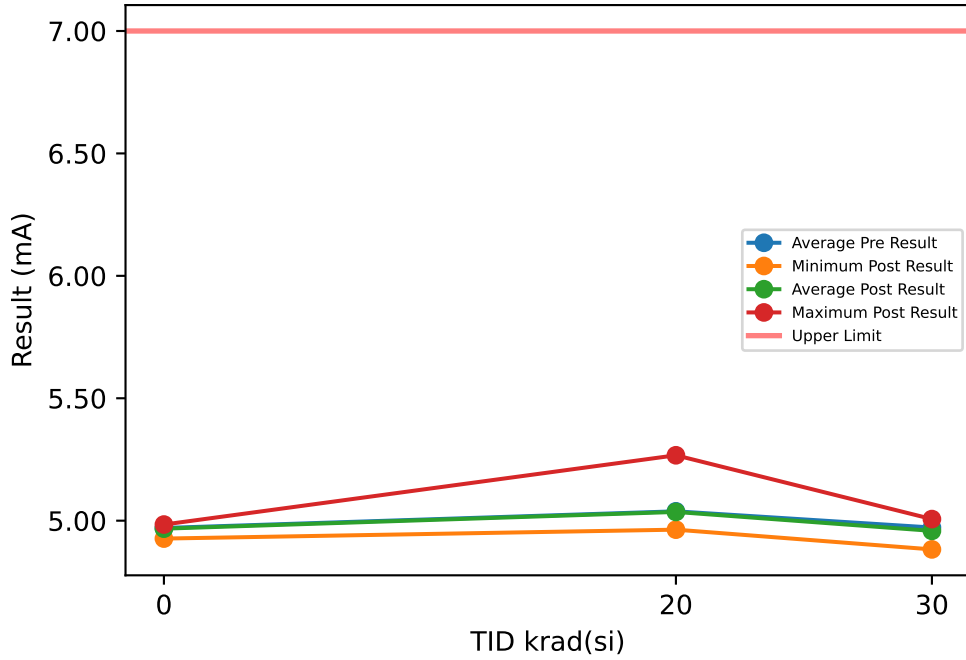

Test Results (Upper Limit = 7.0 (mA))

Serial #	krad(si)	Exposure Conditions	Pre Result	Post Result	Delta
50	20	LDR biased	5.2711	5.2671	-0.004
51	20	LDR biased	4.9816	4.9748	-0.0068
52	20	LDR biased	5.0014	4.9934	-0.008
53	20	LDR biased	4.9611	4.9633	0.0022
54	20	LDR biased	5.0018	5.0035	0.0017
55	30	LDR biased	5.0279	5.0031	-0.0248
56	30	LDR biased	4.8953	4.8827	-0.0126
57	30	LDR biased	4.9715	4.9667	-0.0048
58	30	LDR biased	4.9346	4.9152	-0.0194
59	30	LDR biased	4.9342	4.9366	0.0024
60	20	LDR unbiased	5.001	4.9904	-0.0106
61	20	LDR unbiased	5.017	5.0138	-0.0032
62	20	LDR unbiased	5.0689	5.0612	-0.0077
63	20	LDR unbiased	5.0455	5.045	-0.0005
64	20	LDR unbiased	5.0332	5.0443	0.0111
65	30	LDR unbiased	5.0279	5.0065	-0.0214
66	30	LDR unbiased	5.0073	4.9908	-0.0165
67	30	LDR unbiased	4.952	4.9441	-0.0079
68	30	LDR unbiased	4.9612	4.9455	-0.0157
69	30	LDR unbiased	5.0087	4.993	-0.0157
70	0	correlation	4.9752	4.9709	-0.0043
71	0	correlation	4.9874	4.9842	-0.0032
72	0	correlation	4.9788	4.98	0.0012
73	0	correlation	4.9319	4.9269	-0.005
74	0	correlation	4.9777	4.9748	-0.0029

TID vs Post - Pre Exposure Delta

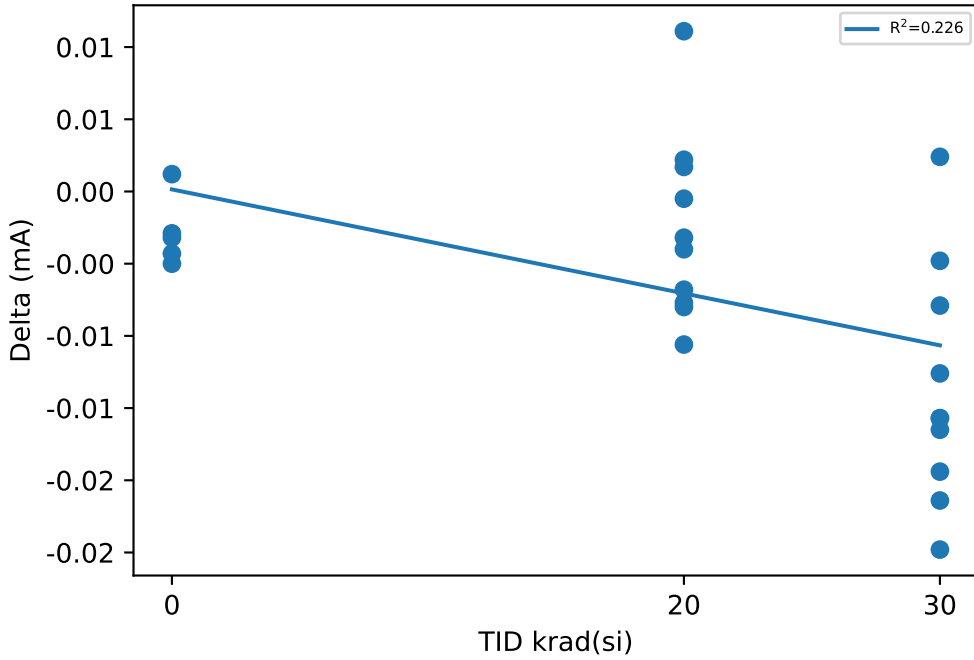

Test Statistics (mA)

krad(si)	Pre Exposure Min	Pre Exposure Avg	Pre Exposure Max	Pre Exposure Std	Post Exposure Min	Post Exposure Avg	Post Exposure Max	Post Exposure Std	Min Delta	Avg Delta	Max Delta	Std Delta
0	4.9319	4.9702	4.9874	0.021897	4.9269	4.9674	4.9842	0.023175	-0.005	-0.00284	0.0012	0.002411
20	4.9611	5.0383	5.2711	0.087511	4.9633	5.0357	5.2671	0.087347	-0.0106	-0.00258	0.0111	0.0064356
30	4.8953	4.9721	5.0279	0.044808	4.8827	4.9584	5.0065	0.04092	-0.0248	-0.01364	0.0024	0.0081926

Device Test: 5.11 UJKFAE(IQ_28V_UJKFAE)

TID vs Result Stats

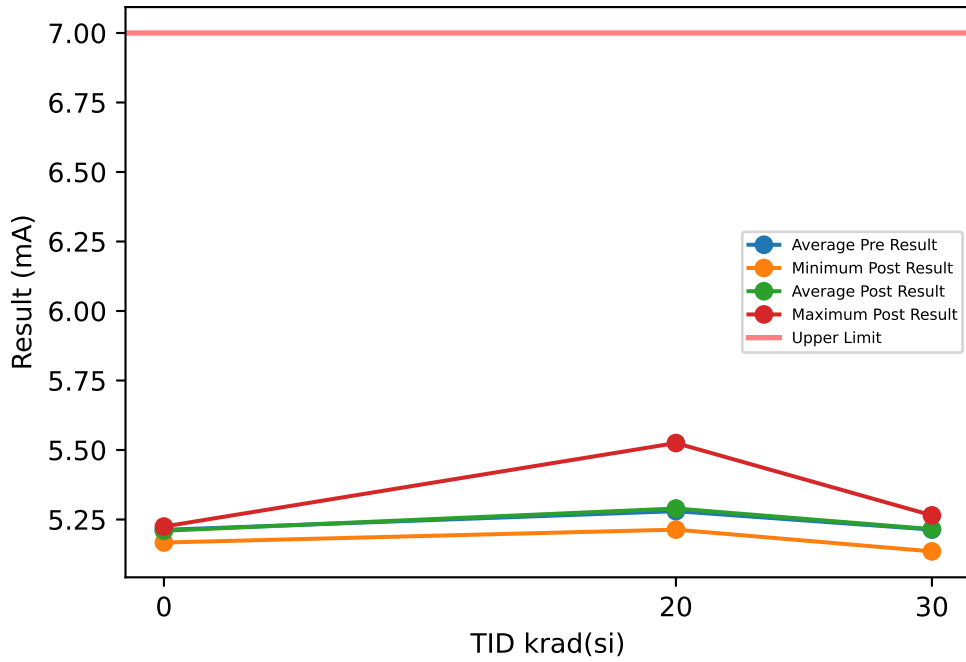

Test Results (Upper Limit = 7.0 (mA))

Serial #	krad(si)	Exposure Conditions	Pre Result	Post Result	Delta
50	20	LDR biased	5.5179	5.5251	0.0072
51	20	LDR biased	5.2185	5.2226	0.0041
52	20	LDR biased	5.2411	5.2426	0.0015
53	20	LDR biased	5.1979	5.2136	0.0157
54	20	LDR biased	5.2442	5.2605	0.0163
55	30	LDR biased	5.2704	5.2598	-0.0106
56	30	LDR biased	5.1334	5.1353	0.0019
57	30	LDR biased	5.2112	5.2231	0.0119
58	30	LDR biased	5.1776	5.1728	-0.0048
59	30	LDR biased	5.1739	5.1913	0.0174
60	20	LDR unbiased	5.243	5.2435	0.0005
61	20	LDR unbiased	5.2589	5.2669	0.008
62	20	LDR unbiased	5.3098	5.315	0.0052
63	20	LDR unbiased	5.2893	5.3016	0.0123
64	20	LDR unbiased	5.279	5.3045	0.0255
65	30	LDR unbiased	5.2702	5.2649	-0.0053
66	30	LDR unbiased	5.2528	5.252	-0.0008
67	30	LDR unbiased	5.1939	5.2008	0.0069
68	30	LDR unbiased	5.202	5.2024	0.0004
69	30	LDR unbiased	5.2515	5.2517	0.0002
70	0	correlation	5.2207	5.2152	-0.0055
71	0	correlation	5.2269	5.2226	-0.0043
72	0	correlation	5.225	5.2247	-0.0003
73	0	correlation	5.1728	5.1672	-0.0056
74	0	correlation	5.2191	5.2181	-0.001

TID vs Post - Pre Exposure Delta

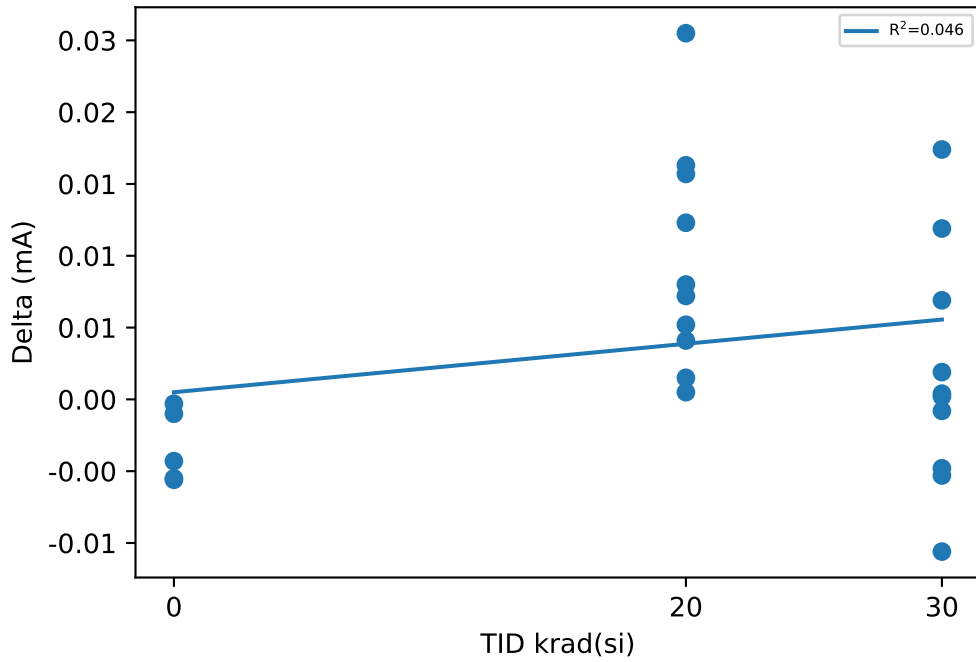

Test Statistics (mA)

krad(si)	Pre Exposure Min	Pre Exposure Avg	Pre Exposure Max	Pre Exposure Std	Post Exposure Min	Post Exposure Avg	Post Exposure Max	Post Exposure Std	Min Delta	Avg Delta	Max Delta	Std Delta
0	5.1728	5.2129	5.2269	0.022637	5.1672	5.2096	5.2247	0.023971	-0.0056	-0.00334	-0.0003	0.0025205
20	5.1979	5.28	5.5179	0.089879	5.2136	5.2896	5.5251	0.089711	0.0005	0.00963	0.0255	0.007807
30	5.1334	5.2137	5.2704	0.04623	5.1353	5.2154	5.2649	0.042599	-0.0106	0.00172	0.0174	0.0083688

Device Test: 5.12 UJKFAE(IQ_32V_UJKFAE)

TID vs Result Stats

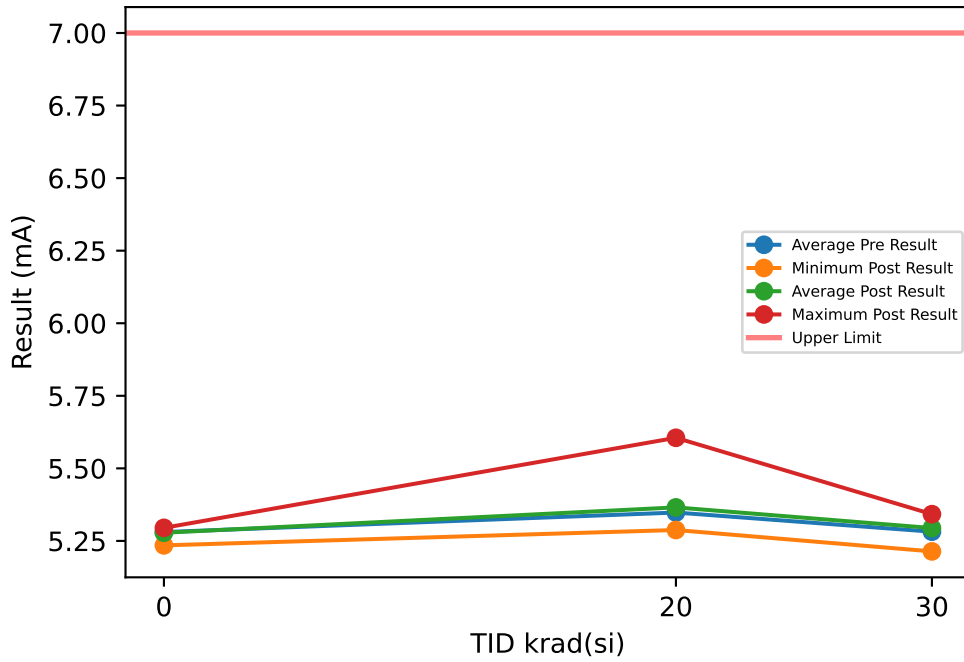

Test Results (Upper Limit = 7.0 (mA))

Serial #	krad(si)	Exposure Conditions	Pre Result	Post Result	Delta
50	20	LDR biased	5.5866	5.6053	0.0187
51	20	LDR biased	5.2826	5.2946	0.012
52	20	LDR biased	5.3081	5.319	0.0109
53	20	LDR biased	5.2663	5.2876	0.0213
54	20	LDR biased	5.3132	5.3379	0.0247
55	30	LDR biased	5.3391	5.3405	0.0014
56	30	LDR biased	5.2024	5.2139	0.0115
57	30	LDR biased	5.2782	5.3013	0.0231
58	30	LDR biased	5.2463	5.2537	0.0074
59	30	LDR biased	5.2403	5.2691	0.0288
60	20	LDR unbiased	5.311	5.3197	0.0087
61	20	LDR unbiased	5.3258	5.3422	0.0164
62	20	LDR unbiased	5.3769	5.3886	0.0117
63	20	LDR unbiased	5.3578	5.3786	0.0208
64	20	LDR unbiased	5.3496	5.3818	0.0322
65	30	LDR unbiased	5.3389	5.3422	0.0033
66	30	LDR unbiased	5.3229	5.3316	0.0087
67	30	LDR unbiased	5.2601	5.2792	0.0191
68	30	LDR unbiased	5.2704	5.2811	0.0107
69	30	LDR unbiased	5.3197	5.3315	0.0118
70	0	correlation	5.2902	5.2848	-0.0054
71	0	correlation	5.2923	5.2904	-0.0019
72	0	correlation	5.2948	5.295	0.0002
73	0	correlation	5.2381	5.2347	-0.0034
74	0	correlation	5.2871	5.2857	-0.0014

TID vs Post - Pre Exposure Delta

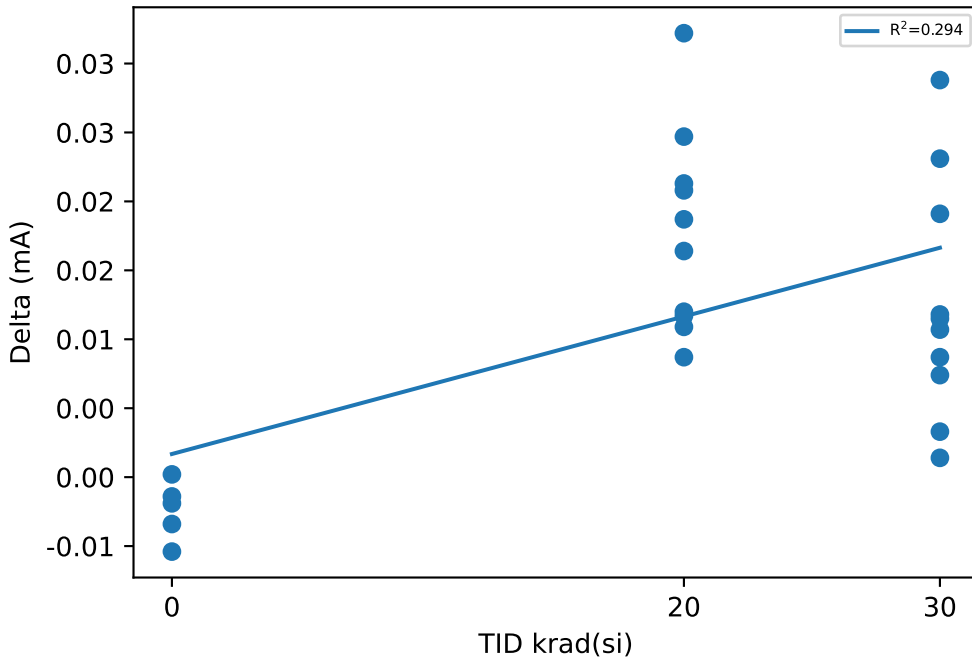

Test Statistics (mA)

krad(si)	Pre Exposure Min	Pre Exposure Avg	Pre Exposure Max	Pre Exposure Std	Post Exposure Min	Post Exposure Avg	Post Exposure Max	Post Exposure Std	Min Delta	Avg Delta	Max Delta	Std Delta
0	5.2381	5.2805	5.2948	0.02387	5.2347	5.2781	5.295	0.024613	-0.0054	-0.00238	0.0002	0.0021218
20	5.2663	5.3478	5.5866	0.090357	5.2876	5.3655	5.6053	0.091369	0.0087	0.01774	0.0322	0.0073047
30	5.2024	5.2818	5.3391	0.046631	5.2139	5.2944	5.3422	0.042691	0.0014	0.01258	0.0288	0.0086575

Device Test: 5.13 UJSQ47(ISD_5V_UJSQ47)

TID vs Result Stats

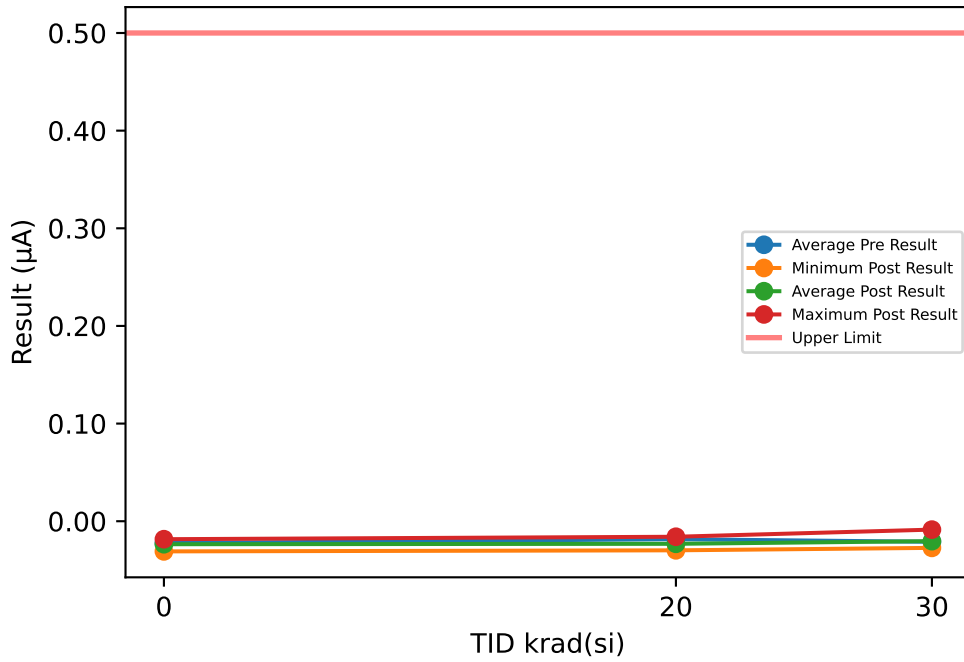

Test Results (Upper Limit = 0.5 (µA))

Serial #	krad(si)	Exposure Conditions	Pre Result	Post Result	Delta
50	20	LDR biased	-0.022	-0.0254	-0.0034
51	20	LDR biased	-0.0173	-0.0199	-0.0026
52	20	LDR biased	-0.0167	-0.0287	-0.012
53	20	LDR biased	-0.0226	-0.0223	0.0003
54	20	LDR biased	-0.0232	-0.0258	-0.0026
55	30	LDR biased	-0.0151	-0.0213	-0.0062
56	30	LDR biased	-0.0183	-0.0198	-0.0015
57	30	LDR biased	-0.025	-0.0273	-0.0023
58	30	LDR biased	-0.0282	-0.0215	0.0067
59	30	LDR biased	-0.0111	-0.0086	0.0025
60	20	LDR unbiased	-0.0176	-0.0241	-0.0065
61	20	LDR unbiased	-0.0265	-0.0298	-0.0033
62	20	LDR unbiased	-0.0074	-0.0159	-0.0085
63	20	LDR unbiased	-0.0133	-0.0186	-0.0053
64	20	LDR unbiased	-0.0175	-0.0208	-0.0033
65	30	LDR unbiased	-0.025	-0.0224	0.0026
66	30	LDR unbiased	-0.0268	-0.0181	0.0087
67	30	LDR unbiased	-0.0179	-0.027	-0.0091
68	30	LDR unbiased	-0.0168	-0.0201	-0.0033
69	30	LDR unbiased	-0.0263	-0.0181	0.0082
70	0	correlation	-0.0275	-0.0231	0.0044
71	0	correlation	-0.0189	-0.0212	-0.0023
72	0	correlation	-0.0132	-0.0184	-0.0052
73	0	correlation	-0.0236	-0.0309	-0.0073
74	0	correlation	-0.0288	-0.0242	0.0046

TID vs Post - Pre Exposure Delta

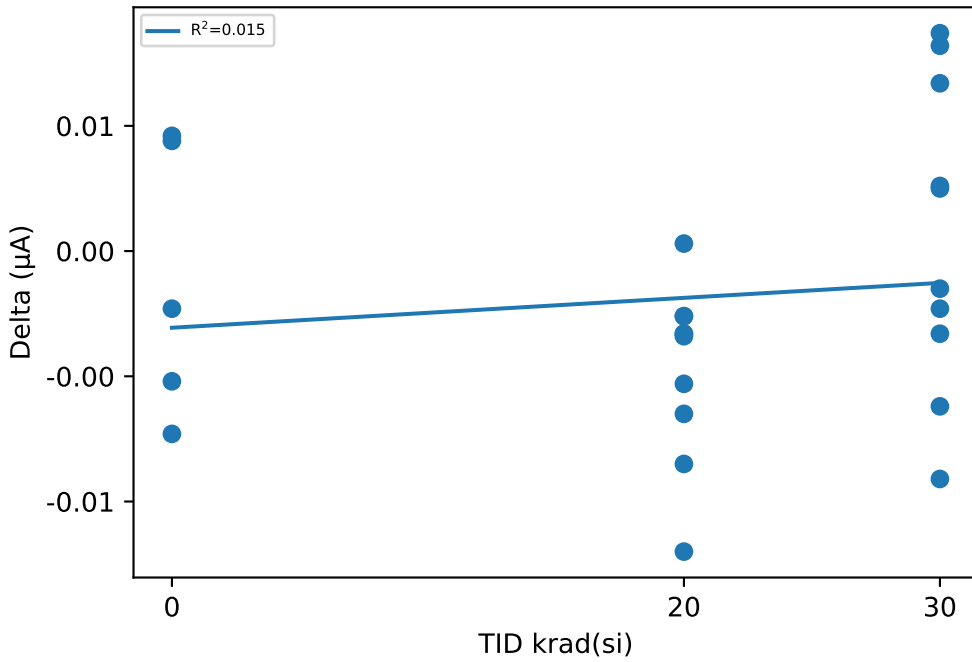

Test Statistics (µA)

krad(si)	Pre Exposure Min	Pre Exposure Avg	Pre Exposure Max	Pre Exposure Std	Post Exposure Min	Post Exposure Avg	Post Exposure Max	Post Exposure Std	Min Delta	Avg Delta	Max Delta	Std Delta
0	-0.0288	-0.0224	-0.0132	0.0064285	-0.0309	-0.02356	-0.0184	0.0046554	-0.0073	-0.00116	0.0046	0.0054638
20	-0.0265	-0.01841	-0.0074	0.0054955	-0.0298	-0.02313	-0.0159	0.0044482	-0.012	-0.00472	0.0003	0.003508
30	-0.0282	-0.02105	-0.0111	0.0058964	-0.0273	-0.02042	-0.0086	0.0052436	-0.0091	0.00063	0.0087	0.006115

Device Test: 5.14 UJSQ47(ISD_12V_UJSQ47)

TID vs Result Stats

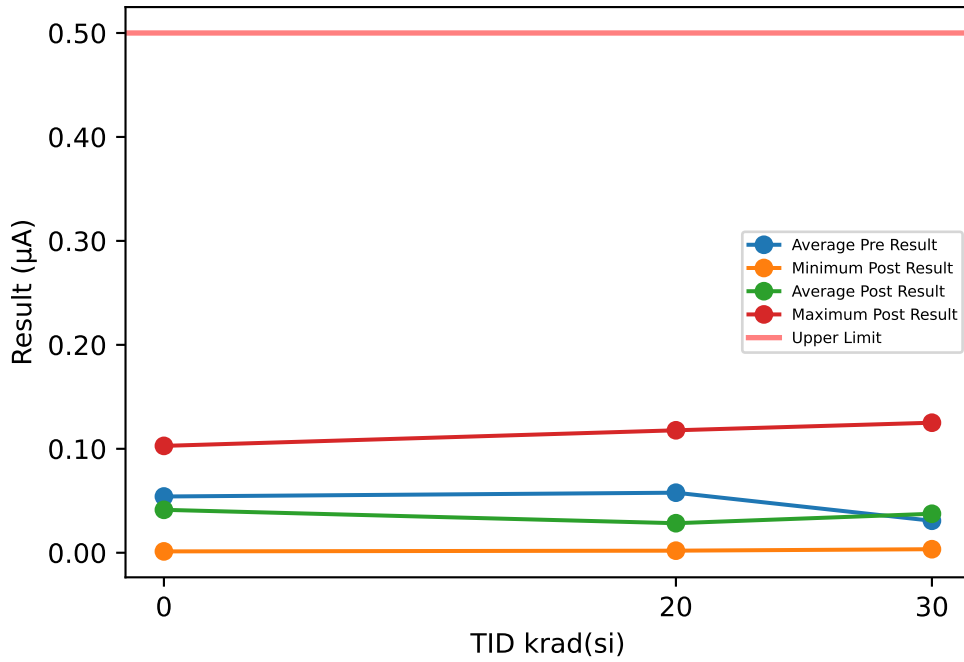

Test Results (Upper Limit = 0.5 (µA))

Serial #	krad(si)	Exposure Conditions	Pre Result	Post Result	Delta
50	20	LDR biased	0.0019	0.0059	0.004
51	20	LDR biased	0.1156	0.0033	-0.1123
52	20	LDR biased	0.0296	0.0098	-0.0198
53	20	LDR biased	0.0755	0.002	-0.0735
54	20	LDR biased	0.066	0.0083	-0.0577
55	30	LDR biased	0.0083	0.0034	-0.0049
56	30	LDR biased	0.0128	0.0114	-0.0014
57	30	LDR biased	0.0071	0.0053	-0.0018
58	30	LDR biased	0.0042	0.0056	0.0014
59	30	LDR biased	0.0196	0.0237	0.0041
60	20	LDR unbiased	0.012	0.0064	-0.0056
61	20	LDR unbiased	0.006	0.0066	0.0006
62	20	LDR unbiased	0.1066	0.1178	0.0112
63	20	LDR unbiased	0.1548	0.1149	-0.0399
64	20	LDR unbiased	0.0097	0.0091	-0.0006
65	30	LDR unbiased	0.0595	0.0694	0.0099
66	30	LDR unbiased	0.0535	0.1251	0.0716
67	30	LDR unbiased	0.1303	0.1111	-0.0192
68	30	LDR unbiased	0.0103	0.0035	-0.0068
69	30	LDR unbiased	0.0022	0.0165	0.0143
70	0	correlation	0.007	0.0013	-0.0057
71	0	correlation	0.009	0.0049	-0.0041
72	0	correlation	0.1512	0.0916	-0.0596
73	0	correlation	0.1005	0.1028	0.0023
74	0	correlation	0.0029	0.0059	0.003

TID vs Post - Pre Exposure Delta

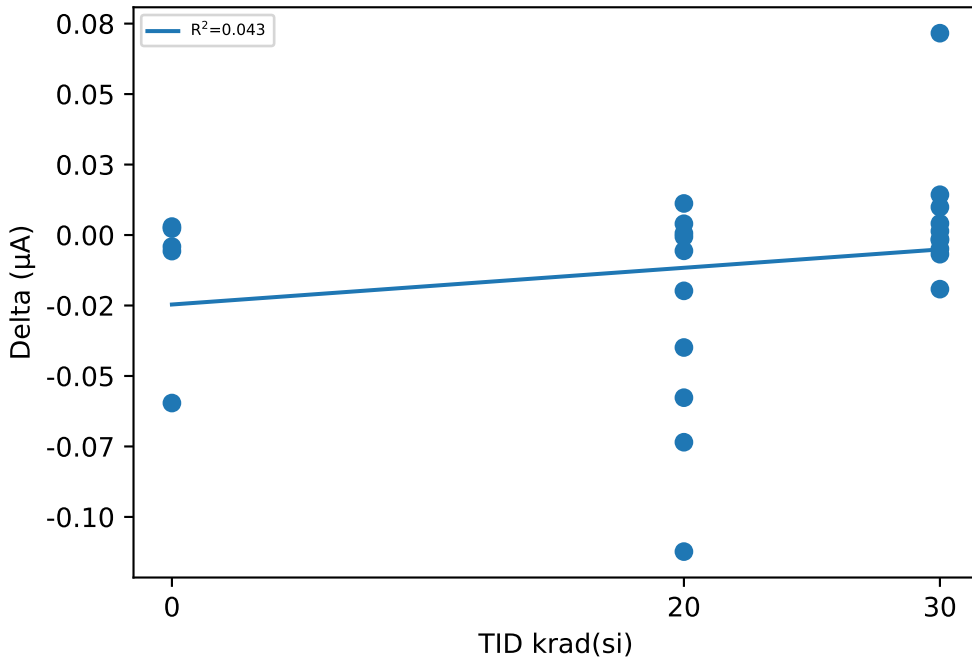

Test Statistics (µA)

krad(si)	Pre Exposure Min	Pre Exposure Avg	Pre Exposure Max	Pre Exposure Std	Post Exposure Min	Post Exposure Avg	Post Exposure Max	Post Exposure Std	Min Delta	Avg Delta	Max Delta	Std Delta
0	0.0029	0.05412	0.1512	0.067925	0.0013	0.0413	0.1028	0.051211	-0.0596	-0.01282	0.003	0.026429
20	0.0019	0.05777	0.1548	0.05429	0.002	0.02841	0.1178	0.046415	-0.1123	-0.02936	0.0112	0.040662
30	0.0022	0.03078	0.1303	0.040418	0.0034	0.0375	0.1251	0.046897	-0.0192	0.00672	0.0716	0.024586

Device Test: 5.15 UJSQ47(ISD_28V_UJSQ47)

TID vs Result Stats

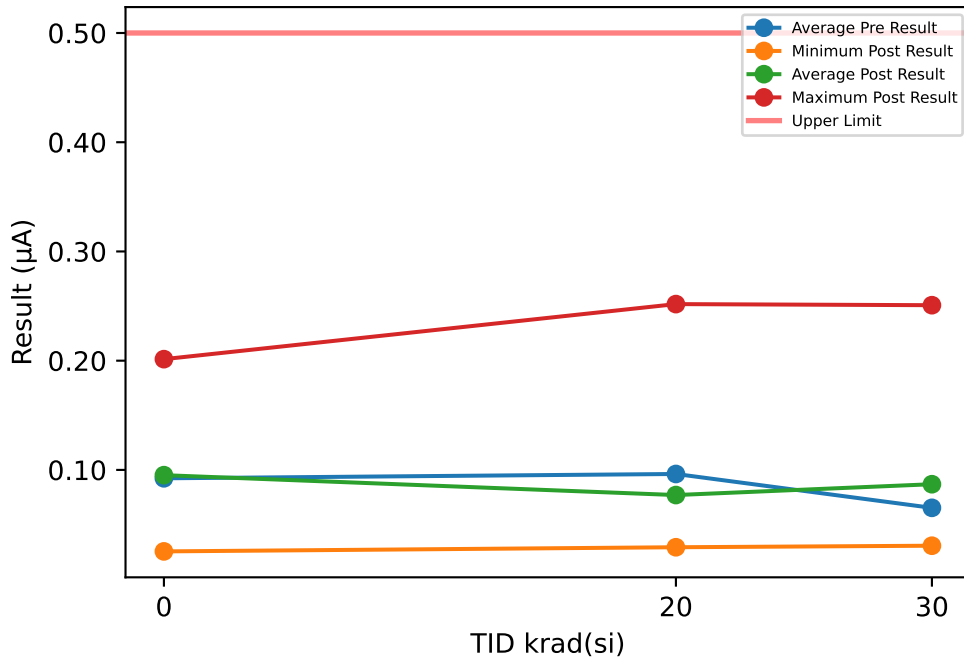

Test Results (Upper Limit = 0.5 (µA))

Serial #	krad(si)	Exposure Conditions	Pre Result	Post Result	Delta
50	20	LDR biased	0.0293	0.0356	0.0063
51	20	LDR biased	0.1721	0.0389	-0.1332
52	20	LDR biased	0.031	0.0292	-0.0018
53	20	LDR biased	0.1143	0.0365	-0.0778
54	20	LDR biased	0.1113	0.0345	-0.0768
55	30	LDR biased	0.0272	0.0388	0.0116
56	30	LDR biased	0.0267	0.0354	0.0087
57	30	LDR biased	0.0318	0.0408	0.009
58	30	LDR biased	0.0291	0.0417	0.0126
59	30	LDR biased	0.0407	0.0511	0.0104
60	20	LDR unbiased	0.0317	0.0369	0.0052
61	20	LDR unbiased	0.0327	0.0307	-0.002
62	20	LDR unbiased	0.2067	0.2439	0.0372
63	20	LDR unbiased	0.2083	0.2518	0.0435
64	20	LDR unbiased	0.0253	0.0319	0.0066
65	30	LDR unbiased	0.1239	0.1755	0.0516
66	30	LDR unbiased	0.1099	0.1691	0.0592
67	30	LDR unbiased	0.2035	0.2508	0.0473
68	30	LDR unbiased	0.0291	0.0352	0.0061
69	30	LDR unbiased	0.0309	0.0306	-0.0003
70	0	correlation	0.0259	0.034	0.0081
71	0	correlation	0.0257	0.0335	0.0078
72	0	correlation	0.1809	0.1817	0.0008
73	0	correlation	0.2004	0.2014	0.001
74	0	correlation	0.0287	0.0254	-0.0033

TID vs Post - Pre Exposure Delta

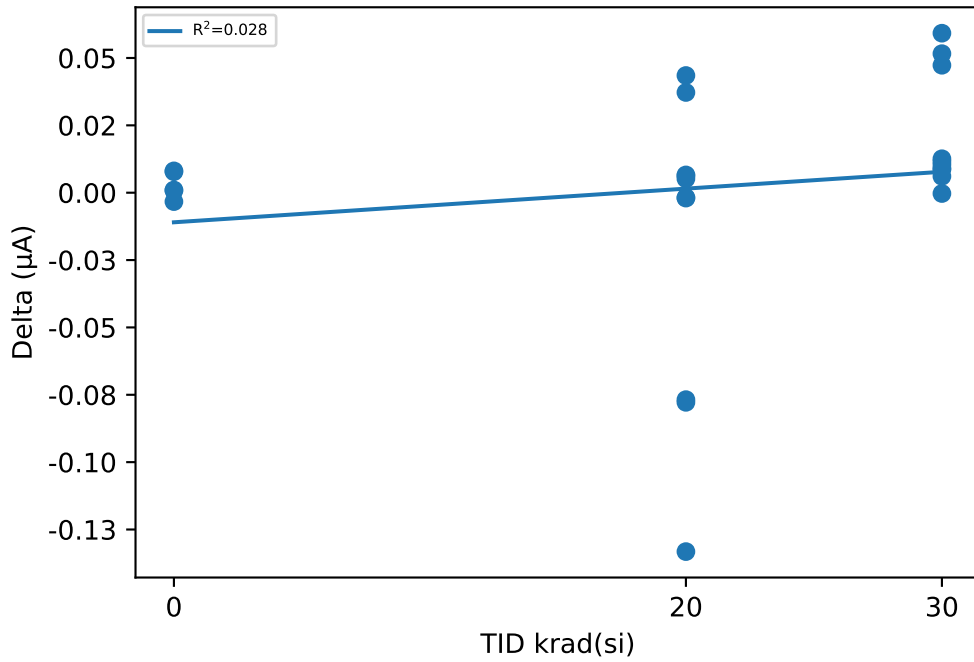

Test Statistics (µA)

krad(si)	Pre Exposure Min	Pre Exposure Avg	Pre Exposure Max	Pre Exposure Std	Post Exposure Min	Post Exposure Avg	Post Exposure Max	Post Exposure Std	Min Delta	Avg Delta	Max Delta	Std Delta
0	0.0257	0.09232	0.2004	0.090035	0.0254	0.0952	0.2014	0.088296	-0.0033	0.00288	0.0081	0.0049373
20	0.0253	0.09627	0.2083	0.076767	0.0292	0.07699	0.2518	0.090119	-0.1332	-0.01928	0.0435	0.057125
30	0.0267	0.06528	0.2035	0.060549	0.0306	0.0869	0.2508	0.080089	-0.0003	0.02162	0.0592	0.021923

Device Test: 5.16 UJSQ47(ISD_32V_UJSQ47)

TID vs Result Stats

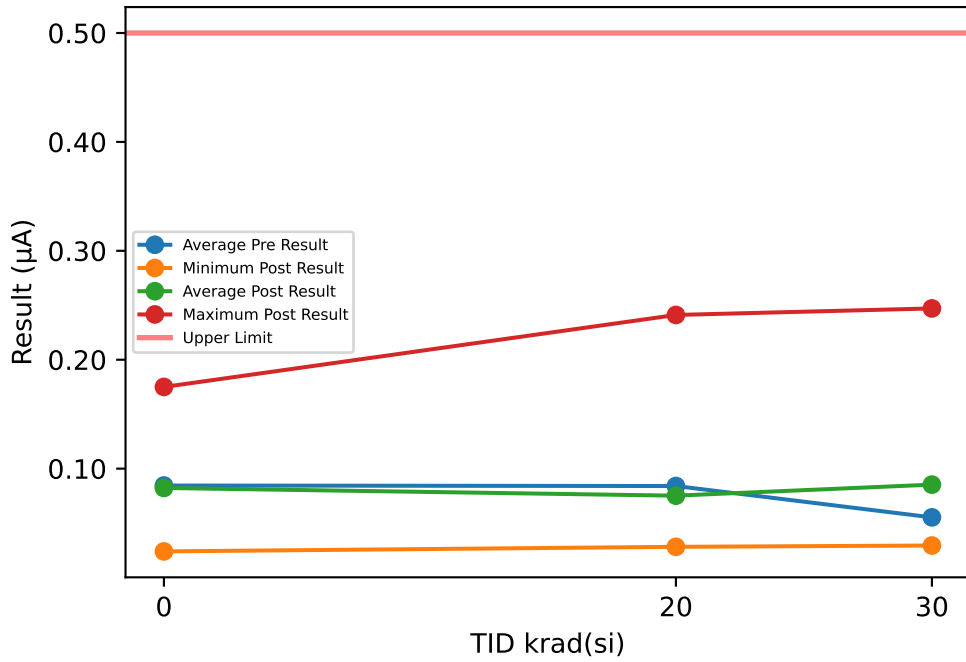

Test Results (Upper Limit = 0.5 (µA))

Serial #	krad(si)	Exposure Conditions	Pre Result	Post Result	Delta
50	20	LDR biased	0.0269	0.0413	0.0144
51	20	LDR biased	0.1546	0.0357	-0.1189
52	20	LDR biased	0.0321	0.0334	0.0013
53	20	LDR biased	0.0721	0.036	-0.0361
54	20	LDR biased	0.0623	0.0298	-0.0325
55	30	LDR biased	0.0268	0.0414	0.0146
56	30	LDR biased	0.0306	0.0435	0.0129
57	30	LDR biased	0.0353	0.0511	0.0158
58	30	LDR biased	0.0281	0.0407	0.0126
59	30	LDR biased	0.0435	0.0681	0.0246
60	20	LDR unbiased	0.0304	0.0351	0.0047
61	20	LDR unbiased	0.0322	0.0282	-0.004
62	20	LDR unbiased	0.1851	0.2411	0.056
63	20	LDR unbiased	0.215	0.2399	0.0249
64	20	LDR unbiased	0.0296	0.0312	0.0016
65	30	LDR unbiased	0.072	0.1401	0.0681
66	30	LDR unbiased	0.0603	0.1577	0.0974
67	30	LDR unbiased	0.2029	0.2471	0.0442
68	30	LDR unbiased	0.0274	0.0294	0.002
69	30	LDR unbiased	0.0256	0.0339	0.0083
70	0	correlation	0.0295	0.0332	0.0037
71	0	correlation	0.0281	0.0318	0.0037
72	0	correlation	0.1644	0.1472	-0.0172
73	0	correlation	0.1757	0.175	-0.0007
74	0	correlation	0.0248	0.024	-0.0008

TID vs Post - Pre Exposure Delta

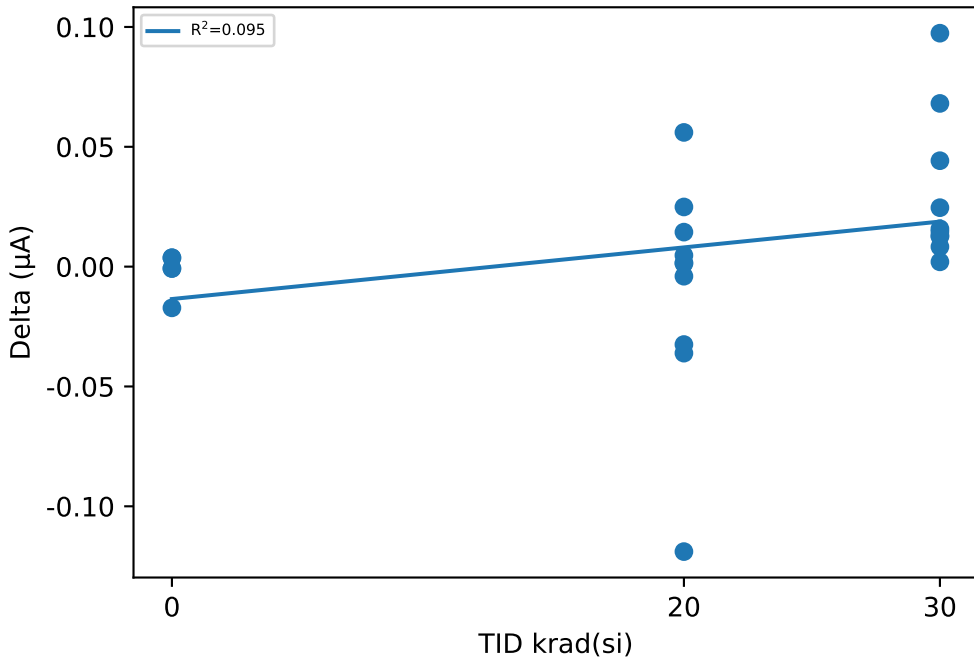

Test Statistics (µA)

krad(si)	Pre Exposure Min	Pre Exposure Avg	Pre Exposure Max	Pre Exposure Std	Post Exposure Min	Post Exposure Avg	Post Exposure Max	Post Exposure Std	Min Delta	Avg Delta	Max Delta	Std Delta
0	0.0248	0.0845	0.1757	0.078217	0.024	0.08224	0.175	0.072741	-0.0172	-0.00226	0.0037	0.0086431
20	0.0269	0.08403	0.215	0.072609	0.0282	0.07517	0.2411	0.087214	-0.1189	-0.00886	0.056	0.046806
30	0.0256	0.05525	0.2029	0.054213	0.0294	0.0853	0.2471	0.07251	0.002	0.03005	0.0974	0.030757

Device Test: 5.17 UJ4UM7(ISD_Diag_5V_UJ4UM7)

TID vs Result Stats

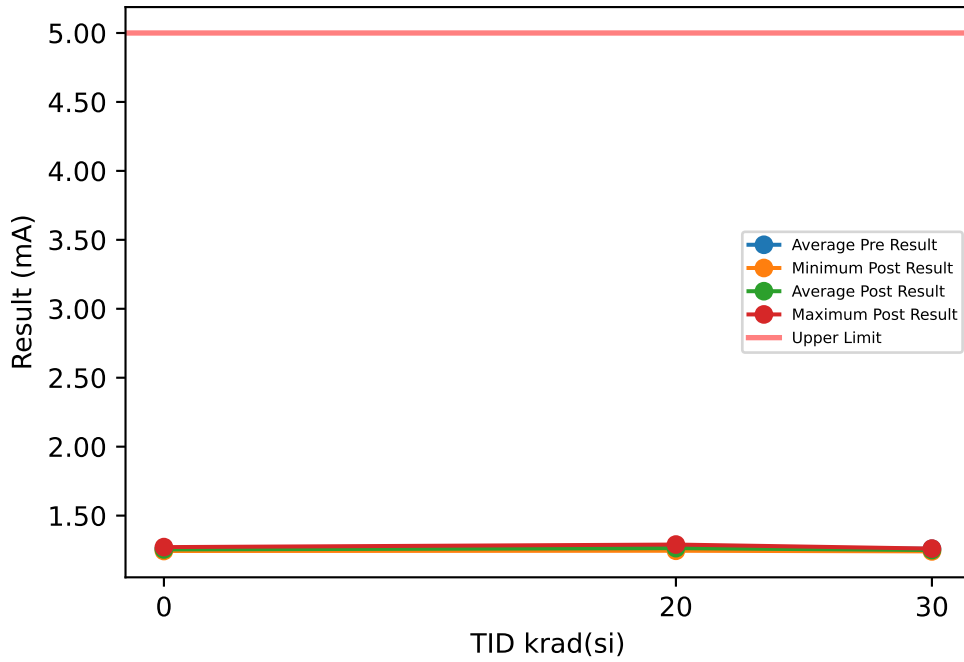

Test Results (Upper Limit = 5.0 (mA))

Serial #	krad(si)	Exposure Conditions	Pre Result	Post Result	Delta
50	20	LDR biased	1.2936	1.2902	-0.0034
51	20	LDR biased	1.2468	1.245	-0.0018
52	20	LDR biased	1.2678	1.2609	-0.0069
53	20	LDR biased	1.2561	1.2524	-0.0037
54	20	LDR biased	1.2601	1.2564	-0.0037
55	30	LDR biased	1.2643	1.2568	-0.0075
56	30	LDR biased	1.2501	1.2435	-0.0066
57	30	LDR biased	1.2566	1.2507	-0.0059
58	30	LDR biased	1.25	1.2453	-0.0047
59	30	LDR biased	1.2514	1.244	-0.0074
60	20	LDR unbiased	1.272	1.2654	-0.0066
61	20	LDR unbiased	1.2635	1.259	-0.0045
62	20	LDR unbiased	1.2772	1.2703	-0.0069
63	20	LDR unbiased	1.268	1.2617	-0.0063
64	20	LDR unbiased	1.2822	1.2795	-0.0027
65	30	LDR unbiased	1.2621	1.2478	-0.0143
66	30	LDR unbiased	1.2707	1.2609	-0.0098
67	30	LDR unbiased	1.2645	1.253	-0.0115
68	30	LDR unbiased	1.2529	1.2405	-0.0124
69	30	LDR unbiased	1.2715	1.2599	-0.0116
70	0	correlation	1.2769	1.2716	-0.0053
71	0	correlation	1.2497	1.2433	-0.0064
72	0	correlation	1.2572	1.2523	-0.0049
73	0	correlation	1.252	1.2473	-0.0047
74	0	correlation	1.2633	1.2595	-0.0038

TID vs Post - Pre Exposure Delta

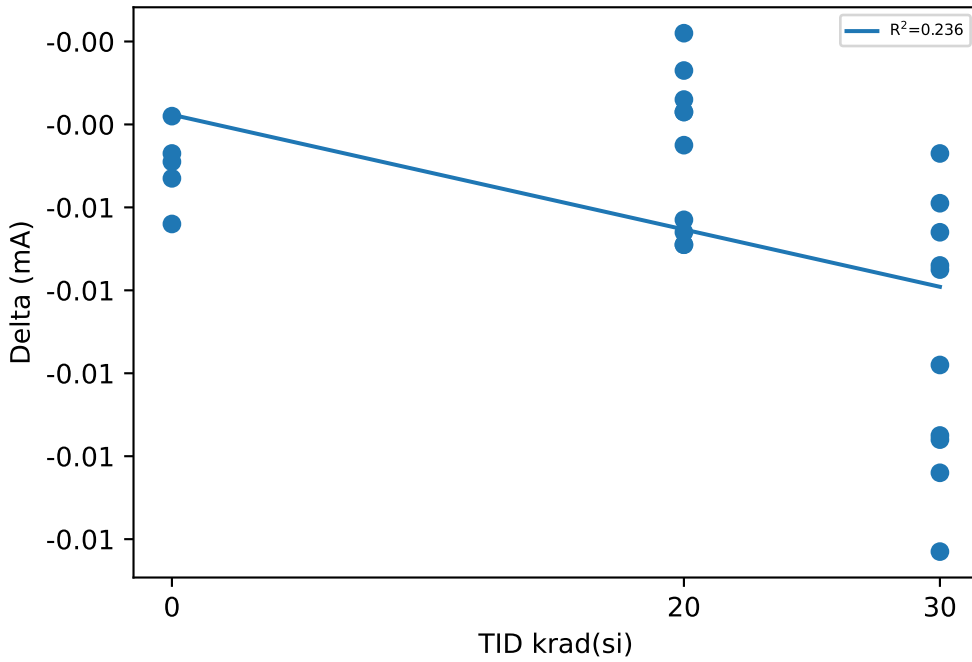

Test Statistics (mA)

krad(si)	Pre Exposure Min	Pre Exposure Avg	Pre Exposure Max	Pre Exposure Std	Post Exposure Min	Post Exposure Avg	Post Exposure Max	Post Exposure Std	Min Delta	Avg Delta	Max Delta	Std Delta
0	1.2497	1.2598	1.2769	0.010889	1.2433	1.2548	1.2716	0.01117	-0.0064	-0.00502	-0.0038	0.0009471
20	1.2468	1.2687	1.2936	0.013441	1.245	1.2641	1.2902	0.013172	-0.0069	-0.00465	-0.0018	0.0018846
30	1.25	1.2594	1.2715	0.0083023	1.2405	1.2502	1.2609	0.0072065	-0.0143	-0.00917	-0.0047	0.0031917

Device Test: 5.18 UJ4UM7(ISD_Diag_12V_UJ4UM7)

TID vs Result Stats

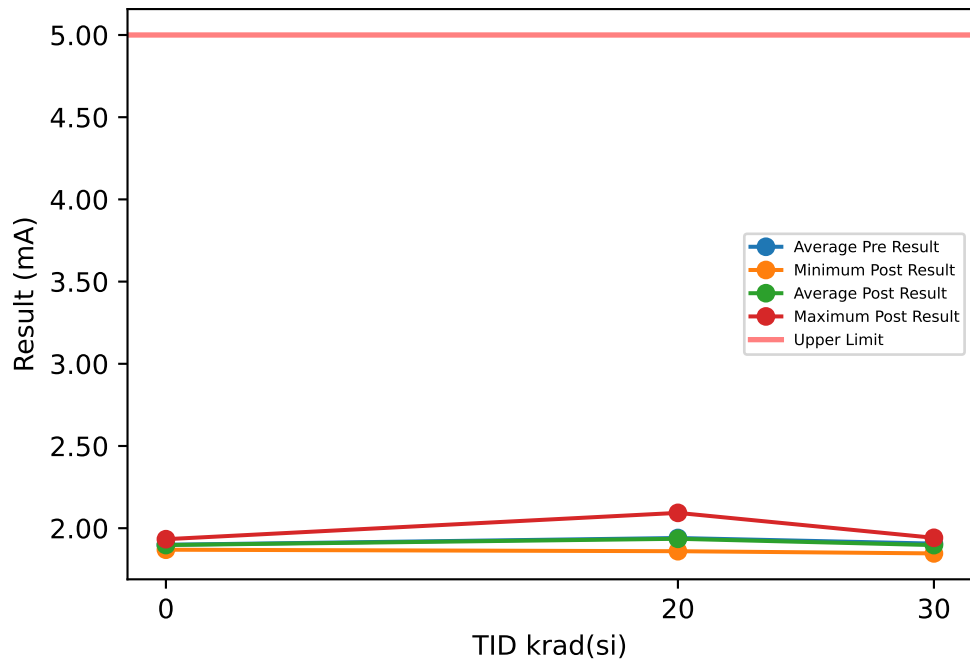

Test Results (Upper Limit = 5.0 (mA))

Serial #	krad(si)	Exposure Conditions	Pre Result	Post Result	Delta
50	20	LDR biased	2.0961	2.0932	-0.0029
51	20	LDR biased	1.9106	1.8995	-0.0111
52	20	LDR biased	1.9165	1.9127	-0.0038
53	20	LDR biased	1.8659	1.86	-0.0059
54	20	LDR biased	1.929	1.9303	0.0013
55	30	LDR biased	1.9443	1.9228	-0.0215
56	30	LDR biased	1.857	1.8467	-0.0103
57	30	LDR biased	1.9102	1.9092	-0.001
58	30	LDR biased	1.888	1.8765	-0.0115
59	30	LDR biased	1.8665	1.8716	0.0051
60	20	LDR unbiased	1.9254	1.9138	-0.0116
61	20	LDR unbiased	1.9458	1.939	-0.0068
62	20	LDR unbiased	1.9444	1.9364	-0.008
63	20	LDR unbiased	1.9271	1.9211	-0.006
64	20	LDR unbiased	1.9436	1.9489	0.0053
65	30	LDR unbiased	1.9541	1.9415	-0.0126
66	30	LDR unbiased	1.9362	1.9235	-0.0127
67	30	LDR unbiased	1.8835	1.8824	-0.0011
68	30	LDR unbiased	1.9037	1.8872	-0.0165
69	30	LDR unbiased	1.9194	1.9099	-0.0095
70	0	correlation	1.8952	1.8924	-0.0028
71	0	correlation	1.9107	1.9089	-0.0018
72	0	correlation	1.9314	1.9331	0.0017
73	0	correlation	1.873	1.8691	-0.0039
74	0	correlation	1.8858	1.8839	-0.0019

TID vs Post - Pre Exposure Delta

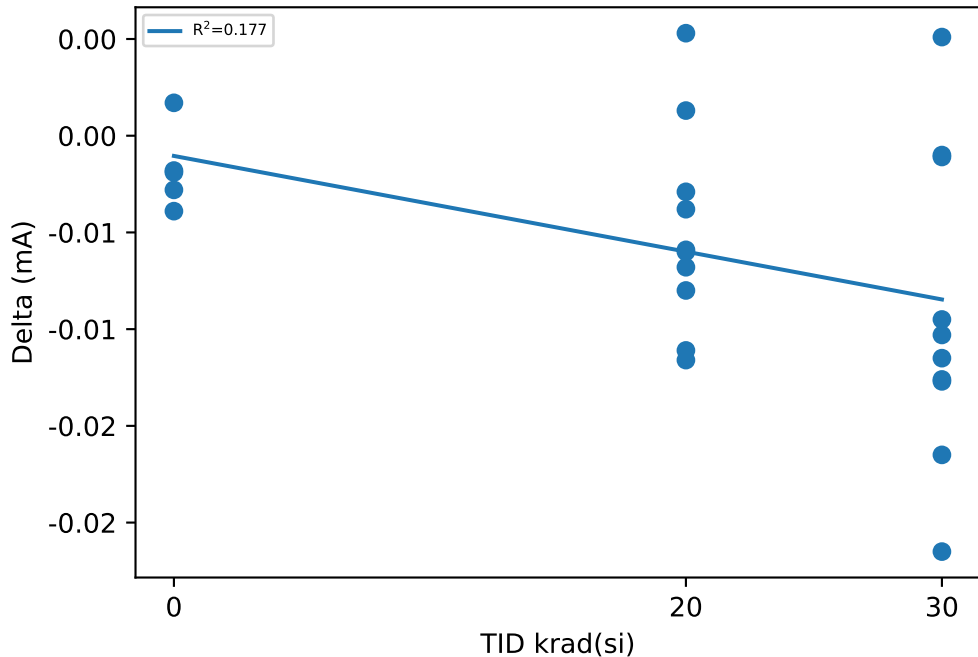

Test Statistics (mA)

krad(si)	Pre Exposure Min	Pre Exposure Avg	Pre Exposure Max	Pre Exposure Std	Post Exposure Min	Post Exposure Avg	Post Exposure Max	Post Exposure Std	Min Delta	Avg Delta	Max Delta	Std Delta
0	1.873	1.8992	1.9314	0.022644	1.8691	1.8975	1.9331	0.024571	-0.0039	-0.00174	0.0017	0.0021007
20	1.8659	1.9404	2.0961	0.059478	1.86	1.9355	2.0932	0.060812	-0.0116	-0.00495	0.0053	0.0052326
30	1.857	1.9063	1.9541	0.032805	1.8467	1.8971	1.9415	0.028998	-0.0215	-0.00916	0.0051	0.0079743

Device Test: 5.19 UJ4UM7(ISD_Diag_28V_UJ4UM7)

TID vs Result Stats

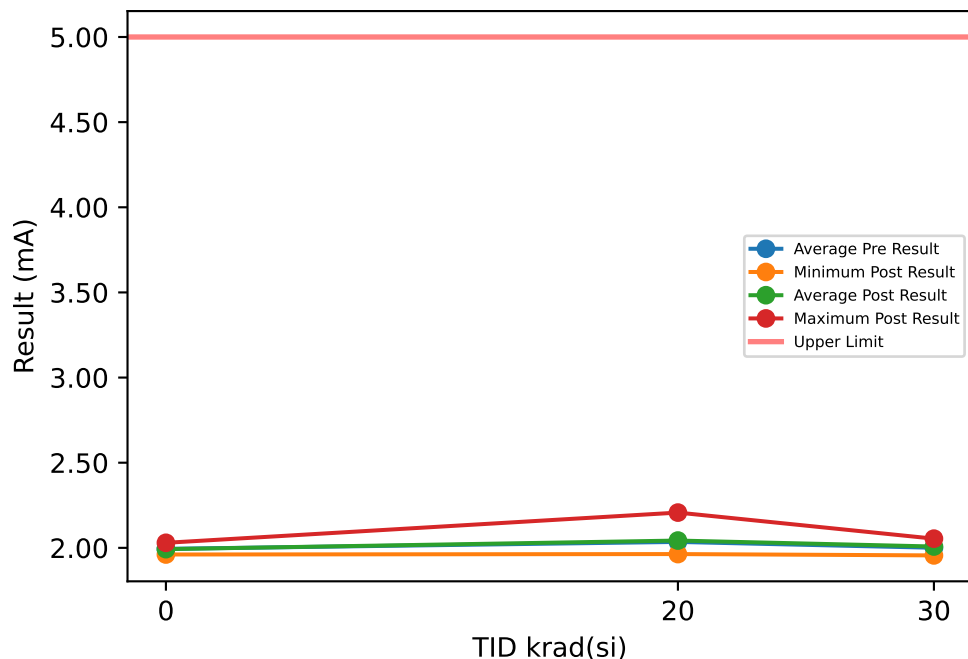

Test Results (Upper Limit = 5.0 (mA))

Serial #	krad(si)	Exposure Conditions	Pre Result	Post Result	Delta
50	20	LDR biased	2.1953	2.2071	0.0118
51	20	LDR biased	2.0001	2.0007	0.0006
52	20	LDR biased	2.0083	2.0178	0.0095
53	20	LDR biased	1.9586	1.9635	0.0049
54	20	LDR biased	2.0245	2.0408	0.0163
55	30	LDR biased	2.0398	2.0349	-0.0049
56	30	LDR biased	1.9499	1.9557	0.0058
57	30	LDR biased	2.0025	2.0186	0.0161
58	30	LDR biased	1.9845	1.9883	0.0038
59	30	LDR biased	1.9552	1.9769	0.0217
60	20	LDR unbiased	2.0197	2.0216	0.0019
61	20	LDR unbiased	2.0413	2.047	0.0057
62	20	LDR unbiased	2.0377	2.0411	0.0034
63	20	LDR unbiased	2.0225	2.0302	0.0077
64	20	LDR unbiased	2.04	2.0592	0.0192
65	30	LDR unbiased	2.0492	2.054	0.0048
66	30	LDR unbiased	2.034	2.0381	0.0041
67	30	LDR unbiased	1.9785	1.9943	0.0158
68	30	LDR unbiased	1.997	1.9976	0.0006
69	30	LDR unbiased	2.0145	2.0204	0.0059
70	0	correlation	1.9935	1.9912	-0.0023
71	0	correlation	2.0026	2.0005	-0.0021
72	0	correlation	2.0291	2.0296	0.0005
73	0	correlation	1.9654	1.961	-0.0044
74	0	correlation	1.9805	1.9796	-0.0009

TID vs Post - Pre Exposure Delta

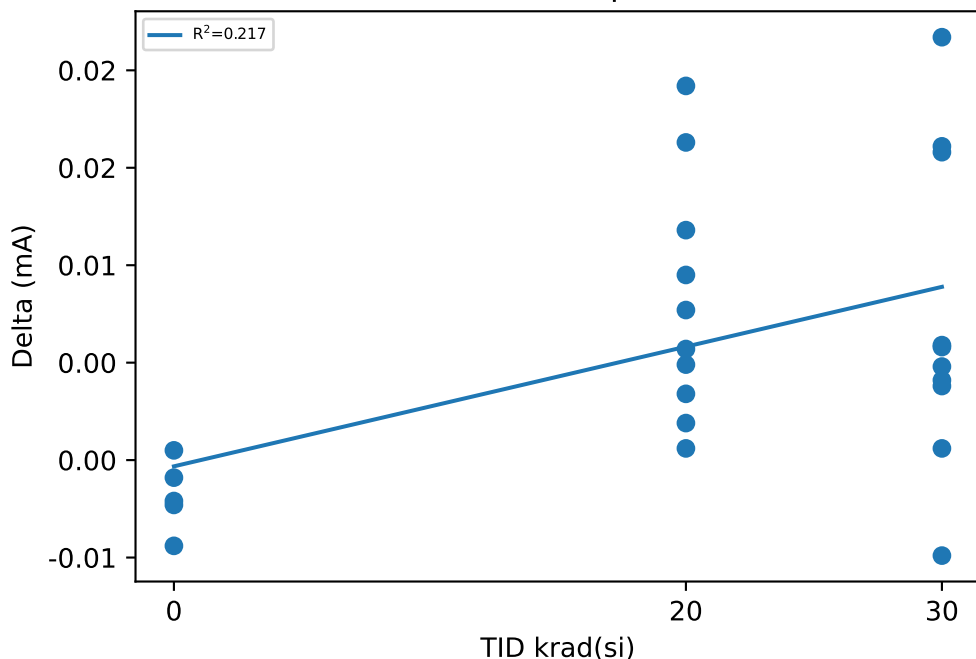

Test Statistics (mA)

krad(si)	Pre Exposure Min	Pre Exposure Avg	Pre Exposure Max	Pre Exposure Std	Post Exposure Min	Post Exposure Avg	Post Exposure Max	Post Exposure Std	Min Delta	Avg Delta	Max Delta	Std Delta
0	1.9654	1.9942	2.0291	0.024011	1.961	1.9924	2.0296	0.025498	-0.0044	-0.00184	0.0005	0.001816
20	1.9586	2.0348	2.1953	0.061496	1.9635	2.0429	2.2071	0.063755	0.0006	0.0081	0.0192	0.0061377
30	1.9499	2.0005	2.0492	0.034324	1.9557	2.0079	2.054	0.030547	-0.0049	0.00737	0.0217	0.0080532

Device Test: 5.2 UJTKLS(Iop_12V_UJTKLS)

TID vs Result Stats

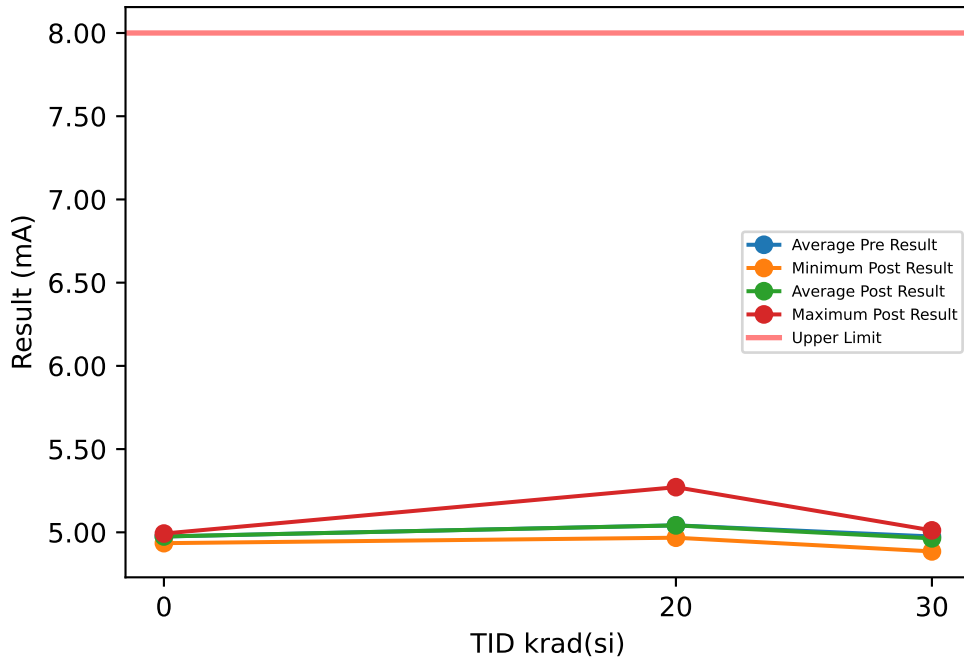

Test Results (Upper Limit = 8.0 (mA))

Serial #	krad(si)	Exposure Conditions	Pre Result	Post Result	Delta
50	20	LDR biased	5.2747	5.2712	-0.0035
51	20	LDR biased	4.9835	4.9805	-0.003
52	20	LDR biased	5.0009	4.9998	-0.0011
53	20	LDR biased	4.9684	4.9676	-0.0008
54	20	LDR biased	5.0099	5.0105	0.0006
55	30	LDR biased	5.0297	5.0117	-0.018
56	30	LDR biased	4.8944	4.8854	-0.009
57	30	LDR biased	4.9762	4.9736	-0.0026
58	30	LDR biased	4.9394	4.9238	-0.0156
59	30	LDR biased	4.9356	4.9396	0.004
60	20	LDR unbiased	5.0015	4.9965	-0.005
61	20	LDR unbiased	5.0255	5.0193	-0.0062
62	20	LDR unbiased	5.0742	5.0695	-0.0047
63	20	LDR unbiased	5.0482	5.053	0.0048
64	20	LDR unbiased	5.0333	5.0483	0.015
65	30	LDR unbiased	5.0329	5.0109	-0.022
66	30	LDR unbiased	5.0121	4.9912	-0.0209
67	30	LDR unbiased	4.9537	4.9514	-0.0023
68	30	LDR unbiased	4.9616	4.9538	-0.0078
69	30	LDR unbiased	5.0155	4.9955	-0.02
70	0	correlation	4.9826	4.9776	-0.005
71	0	correlation	4.9878	4.9926	0.0048
72	0	correlation	4.9799	4.9891	0.0092
73	0	correlation	4.9393	4.9349	-0.0044
74	0	correlation	4.9848	4.9811	-0.0037

TID vs Post - Pre Exposure Delta

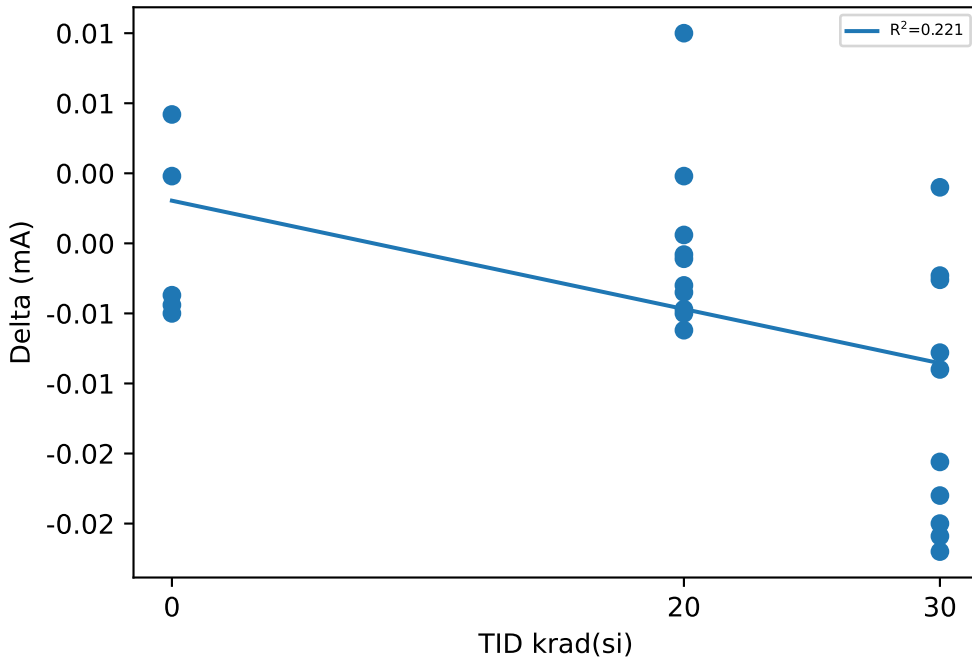

Test Statistics (mA)

krad(si)	Pre Exposure Min	Pre Exposure Avg	Pre Exposure Max	Pre Exposure Std	Post Exposure Min	Post Exposure Avg	Post Exposure Max	Post Exposure Std	Min Delta	Avg Delta	Max Delta	Std Delta
0	4.9393	4.9749	4.9878	0.0201	4.9349	4.9751	4.9926	0.023241	-0.005	0.00018	0.0092	0.0064337
20	4.9684	5.042	5.2747	0.087414	4.9676	5.0416	5.2712	0.087002	-0.0062	-0.00039	0.015	0.006285
30	4.8944	4.9751	5.0329	0.046322	4.8854	4.9637	5.0117	0.040757	-0.022	-0.01142	0.004	0.0091524

Device Test: 5.20 UJ4UM7(ISD_Diag_32V_UJ4UM7)

TID vs Result Stats

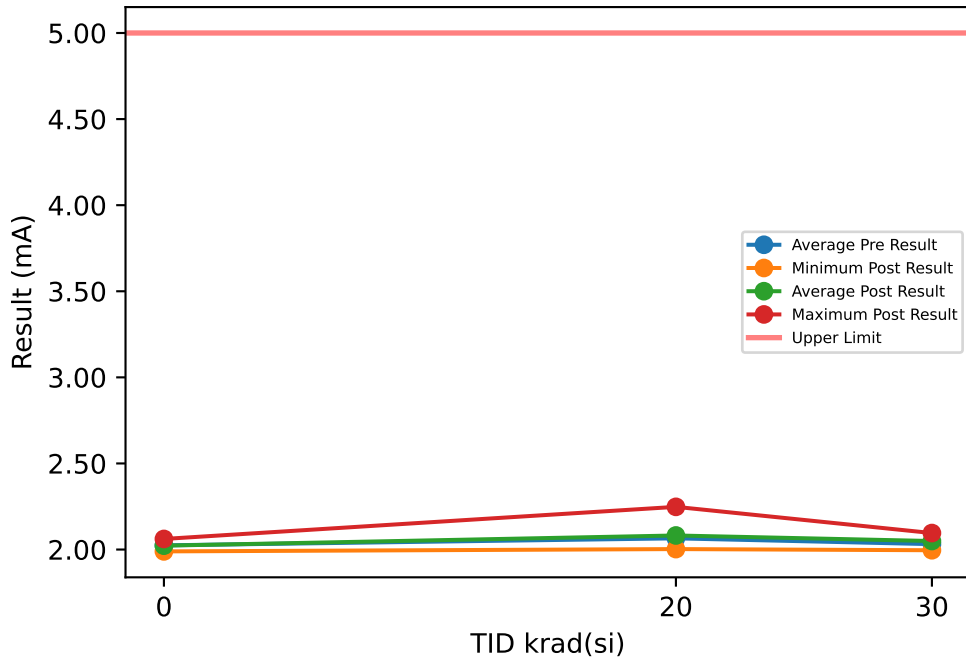

Test Results (Upper Limit = 5.0 (mA))

Serial #	krad(si)	Exposure Conditions	Pre Result	Post Result	Delta
50	20	LDR biased	2.2281	2.2479	0.0198
51	20	LDR biased	2.0274	2.035	0.0076
52	20	LDR biased	2.0372	2.0565	0.0193
53	20	LDR biased	1.9879	2.0026	0.0147
54	20	LDR biased	2.0547	2.0831	0.0284
55	30	LDR biased	2.0711	2.0767	0.0056
56	30	LDR biased	1.9806	1.9959	0.0153
57	30	LDR biased	2.0326	2.0605	0.0279
58	30	LDR biased	2.0156	2.0331	0.0175
59	30	LDR biased	1.9841	2.0177	0.0336
60	20	LDR unbiased	2.0511	2.0591	0.008
61	20	LDR unbiased	2.0714	2.0853	0.0139
62	20	LDR unbiased	2.0661	2.0787	0.0126
63	20	LDR unbiased	2.053	2.0679	0.0149
64	20	LDR unbiased	2.073	2.1009	0.0279
65	30	LDR unbiased	2.0806	2.0958	0.0152
66	30	LDR unbiased	2.0664	2.081	0.0146
67	30	LDR unbiased	2.0089	2.0352	0.0263
68	30	LDR unbiased	2.0276	2.0375	0.0099
69	30	LDR unbiased	2.0457	2.0615	0.0158
70	0	correlation	2.0255	2.0226	-0.0029
71	0	correlation	2.0313	2.0287	-0.0026
72	0	correlation	2.0611	2.0615	0.0004
73	0	correlation	1.9938	1.9892	-0.0046
74	0	correlation	2.0103	2.0104	0.0001

TID vs Post - Pre Exposure Delta

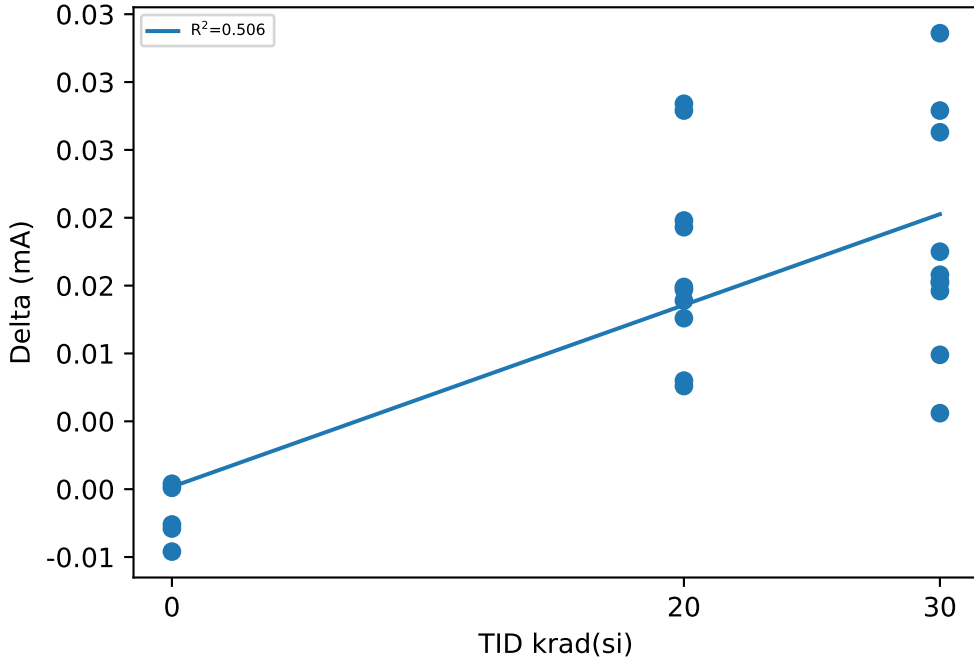

Test Statistics (mA)

krad(si)	Pre Exposure Min	Pre Exposure Avg	Pre Exposure Max	Pre Exposure Std	Post Exposure Min	Post Exposure Avg	Post Exposure Max	Post Exposure Std	Min Delta	Avg Delta	Max Delta	Std Delta
0	1.9938	2.0244	2.0611	0.025154	1.9892	2.0225	2.0615	0.026527	-0.0046	-0.00192	0.0004	0.0021253
20	1.9879	2.065	2.2281	0.062612	2.0026	2.0817	2.2479	0.064798	0.0076	0.01671	0.0284	0.0072195
30	1.9806	2.0313	2.0806	0.034985	1.9959	2.0495	2.0958	0.030988	0.0056	0.01817	0.0336	0.0085708

Device Test: 5.21 UJ3WW2(IF1_5V_UJ3WW2)

TID vs Result Stats

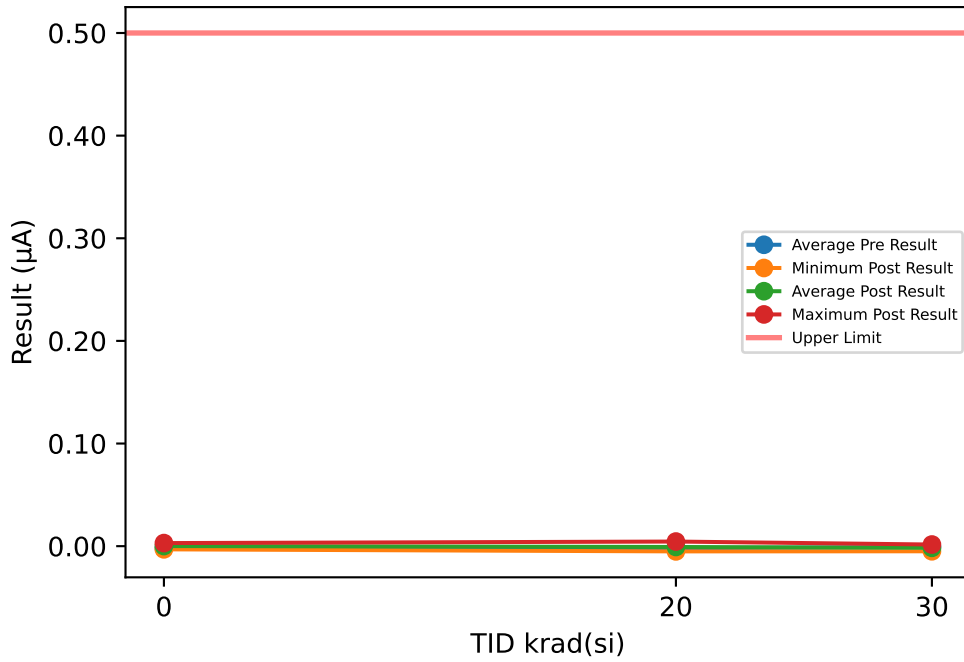

Test Results (Upper Limit = 0.5 (µA))

Serial #	krad(si)	Exposure Conditions	Pre Result	Post Result	Delta
50	20	LDR biased	0.0004	-0.0012	-0.0016
51	20	LDR biased	-0.0008	-0.0047	-0.0039
52	20	LDR biased	-0.005	-0.0018	0.0032
53	20	LDR biased	-0.0026	-0.0004	0.0022
54	20	LDR biased	-0.0033	0.0045	0.0078
55	30	LDR biased	-0.0024	-0.0006	0.0018
56	30	LDR biased	-0.0056	-0.005	0.0006
57	30	LDR biased	0.0003	-0.0042	-0.0045
58	30	LDR biased	0.0061	0.0016	-0.0045
59	30	LDR biased	-0.0014	-0.0039	-0.0025
60	20	LDR unbiased	-0.0031	-0.0018	0.0013
61	20	LDR unbiased	-0.0015	-0.0051	-0.0036
62	20	LDR unbiased	0.0014	0.0006	-0.0008
63	20	LDR unbiased	0.0001	-0.0006	-0.0007
64	20	LDR unbiased	-0.0058	0.0026	0.0084
65	30	LDR unbiased	-0.0003	0.0016	0.0019
66	30	LDR unbiased	-0.0023	-0.0015	0.0008
67	30	LDR unbiased	-0.0003	0.0009	0.0012
68	30	LDR unbiased	-0.0003	-0.0025	-0.0022
69	30	LDR unbiased	-0.0013	-0.0025	-0.0012
70	0	correlation	-0.0014	0.0006	0.002
71	0	correlation	-0.0024	0.001	0.0034
72	0	correlation	-0.0035	-0.001	0.0025
73	0	correlation	-0.0036	0.003	0.0066
74	0	correlation	0.0014	-0.0031	-0.0045

TID vs Post - Pre Exposure Delta

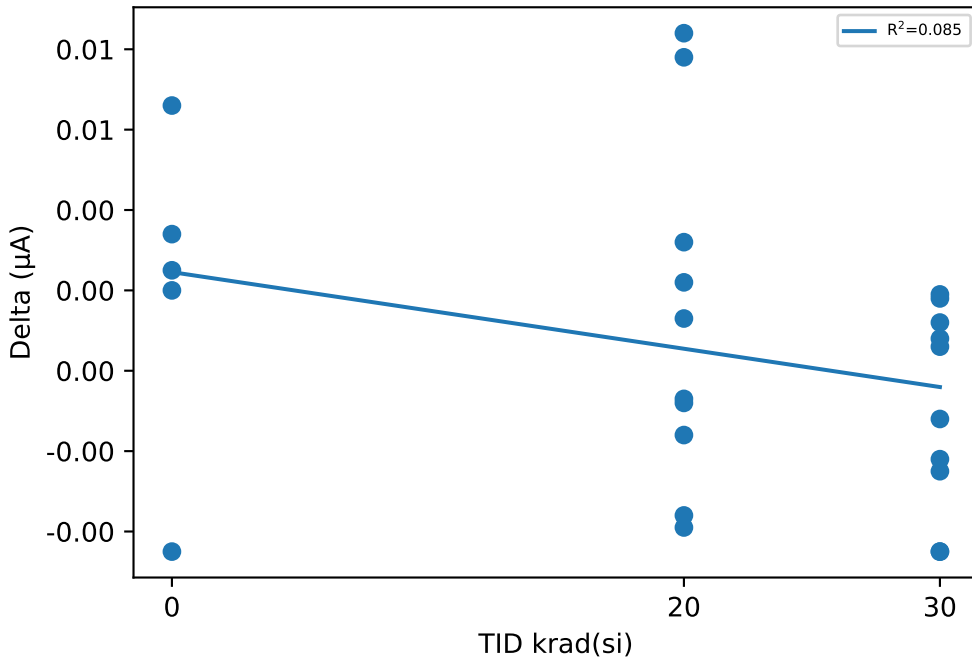

Test Statistics (µA)

krad(si)	Pre Exposure Min	Pre Exposure Avg	Pre Exposure Max	Pre Exposure Std	Post Exposure Min	Post Exposure Avg	Post Exposure Max	Post Exposure Std	Min Delta	Avg Delta	Max Delta	Std Delta
0	-0.0036	-0.0019	0.0014	0.0020518	-0.0031	0.0001	0.003	0.0022869	-0.0045	0.002	0.0066	0.0040503
20	-0.0058	-0.00202	0.0014	0.0023598	-0.0051	-0.00079	0.0045	0.0029377	-0.0039	0.00123	0.0084	0.0042805
30	-0.0056	-0.00075	0.0061	0.002944	-0.005	-0.00161	0.0016	0.002426	-0.0045	-0.00086	0.0019	0.0024704

Device Test: 5.22 UJ3WW2(IF1_12V_UJ3WW2)

TID vs Result Stats

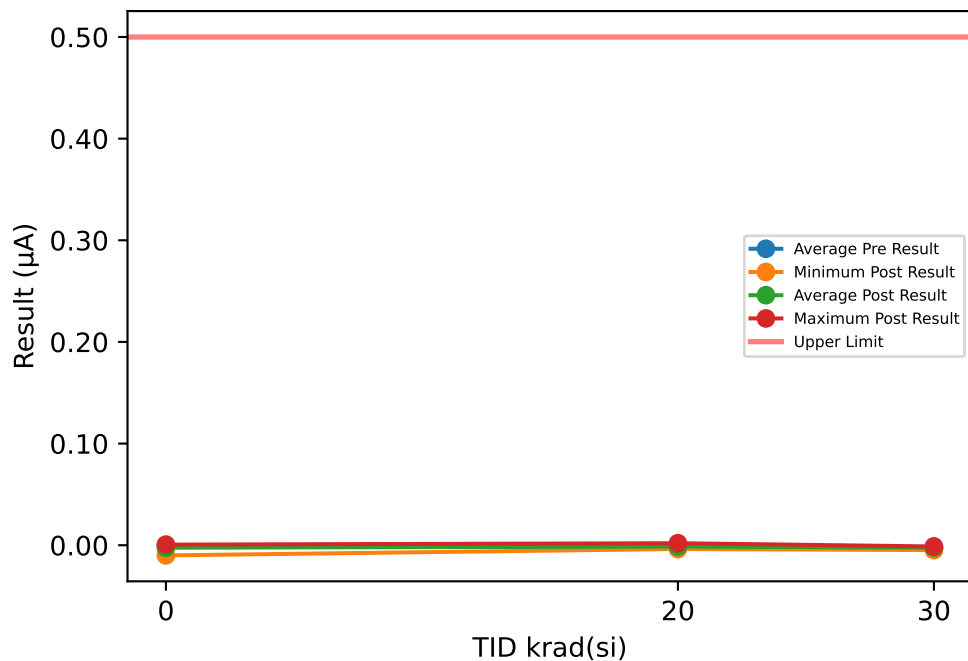

Test Results (Upper Limit = 0.5 (µA))

Serial #	krad(si)	Exposure Conditions	Pre Result	Post Result	Delta
50	20	LDR biased	-0.0057	0.002	0.0077
51	20	LDR biased	-0.0028	-0.001	0.0018
52	20	LDR biased	-0.0025	-0.002	0.0005
53	20	LDR biased	-0.0015	-0.0018	-0.0003
54	20	LDR biased	-0.0027	-0.0006	0.0021
55	30	LDR biased	-0.0024	-0.0033	-0.0009
56	30	LDR biased	-0.005	-0.0039	0.0011
57	30	LDR biased	-0.0023	-0.0013	0.001
58	30	LDR biased	-0.0023	-0.0016	0.0007
59	30	LDR biased	-0.0014	-0.0048	-0.0034
60	20	LDR unbiased	-0.0017	0.0016	0.0033
61	20	LDR unbiased	-0.0017	-0.0035	-0.0018
62	20	LDR unbiased	-0.0008	-0.0037	-0.0029
63	20	LDR unbiased	-0.0012	-0.0018	-0.0006
64	20	LDR unbiased	0.0005	-0.0027	-0.0032
65	30	LDR unbiased	0.0009	-0.0016	-0.0025
66	30	LDR unbiased	-0.0014	-0.0025	-0.0011
67	30	LDR unbiased	-0.0044	-0.0021	0.0023
68	30	LDR unbiased	-0.0007	-0.0012	-0.0005
69	30	LDR unbiased	-0.0011	-0.0019	-0.0008
70	0	correlation	-0.0035	-0.01	-0.0065
71	0	correlation	0.0025	-0.001	-0.0035
72	0	correlation	-0.0007	0.0006	0.0013
73	0	correlation	0.0007	-0.0022	-0.0029
74	0	correlation	0.0004	0.0004	0

TID vs Post - Pre Exposure Delta

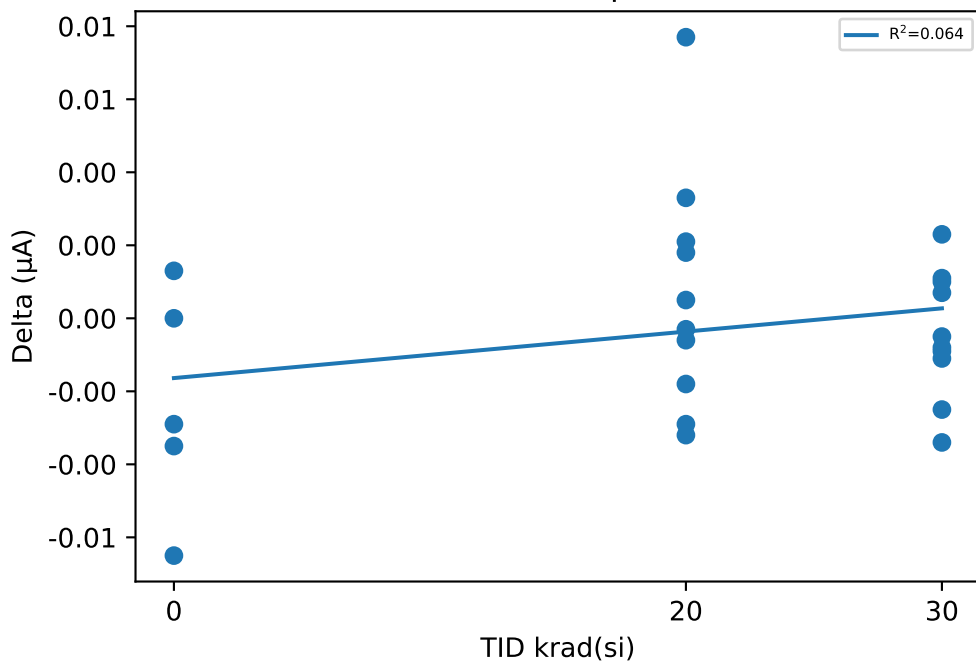

Test Statistics (µA)

krad(si)	Pre Exposure Min	Pre Exposure Avg	Pre Exposure Max	Pre Exposure Std	Post Exposure Min	Post Exposure Avg	Post Exposure Max	Post Exposure Std	Min Delta	Avg Delta	Max Delta	Std Delta
0	-0.0035	-0.00012	0.0025	0.0022118	-0.01	-0.00244	0.0006	0.0043758	-0.0065	-0.00232	0.0013	0.0030695
20	-0.0057	-0.00201	0.0005	0.0016272	-0.0037	-0.00135	0.002	0.0019266	-0.0032	0.00066	0.0077	0.0032671
30	-0.005	-0.00201	0.0009	0.0017233	-0.0048	-0.00242	-0.0012	0.0012063	-0.0034	-0.00041	0.0023	0.001733

Device Test: 5.23 UJ3WW2(IF1_28V_UJ3WW2)

TID vs Result Stats

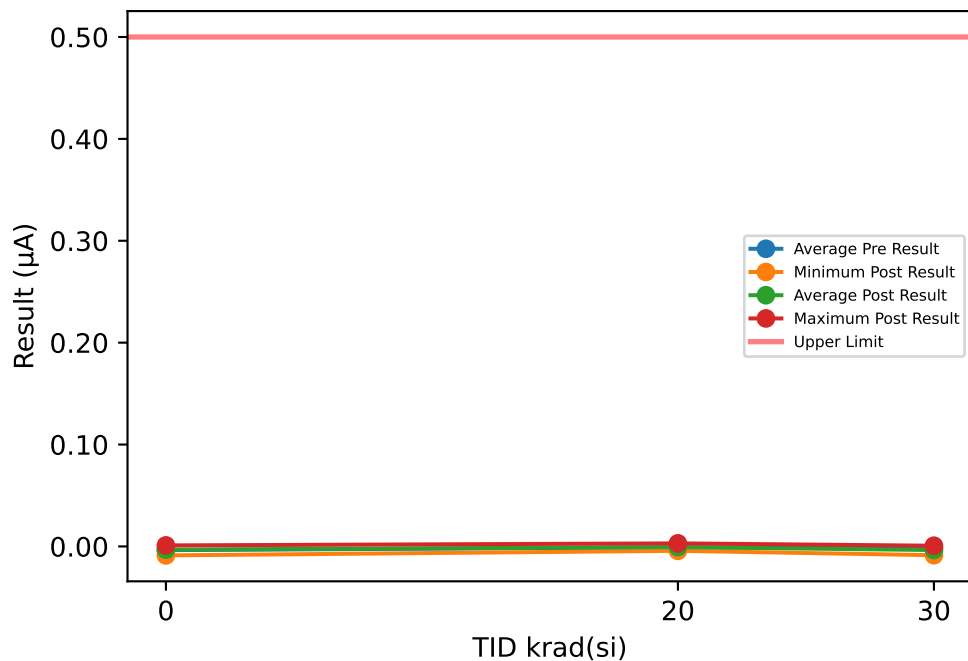

Test Results (Upper Limit = 0.5 (µA))

Serial #	krad(si)	Exposure Conditions	Pre Result	Post Result	Delta
50	20	LDR biased	-0.0006	0.003	0.0036
51	20	LDR biased	-0.0014	-0.0018	-0.0004
52	20	LDR biased	-0.0001	-0.0016	-0.0015
53	20	LDR biased	-0.0001	0	0.0001
54	20	LDR biased	-0.0033	0.0004	0.0037
55	30	LDR biased	-0.0018	-0.0053	-0.0035
56	30	LDR biased	-0.0031	-0.006	-0.0029
57	30	LDR biased	-0.0015	-0.005	-0.0035
58	30	LDR biased	-0.0082	-0.0086	-0.0004
59	30	LDR biased	-0.0026	-0.0029	-0.0003
60	20	LDR unbiased	-0.0056	-0.0037	0.0019
61	20	LDR unbiased	0.004	-0.0043	-0.0083
62	20	LDR unbiased	0.0014	-0.0022	-0.0036
63	20	LDR unbiased	-0.003	0.003	0.006
64	20	LDR unbiased	0.0003	0.0006	0.0003
65	30	LDR unbiased	0.0034	0.0006	-0.0028
66	30	LDR unbiased	-0.0014	-0.0046	-0.0032
67	30	LDR unbiased	-0.004	0.0007	0.0047
68	30	LDR unbiased	-0.0015	-0.0037	-0.0022
69	30	LDR unbiased	0.0007	-0.0007	-0.0014
70	0	correlation	-0.0029	-0.0088	-0.0059
71	0	correlation	-0.0014	-0.0059	-0.0045
72	0	correlation	-0.0058	-0.0016	0.0042
73	0	correlation	-0.0025	0.001	0.0035
74	0	correlation	-0.0057	-0.0004	0.0053

TID vs Post - Pre Exposure Delta

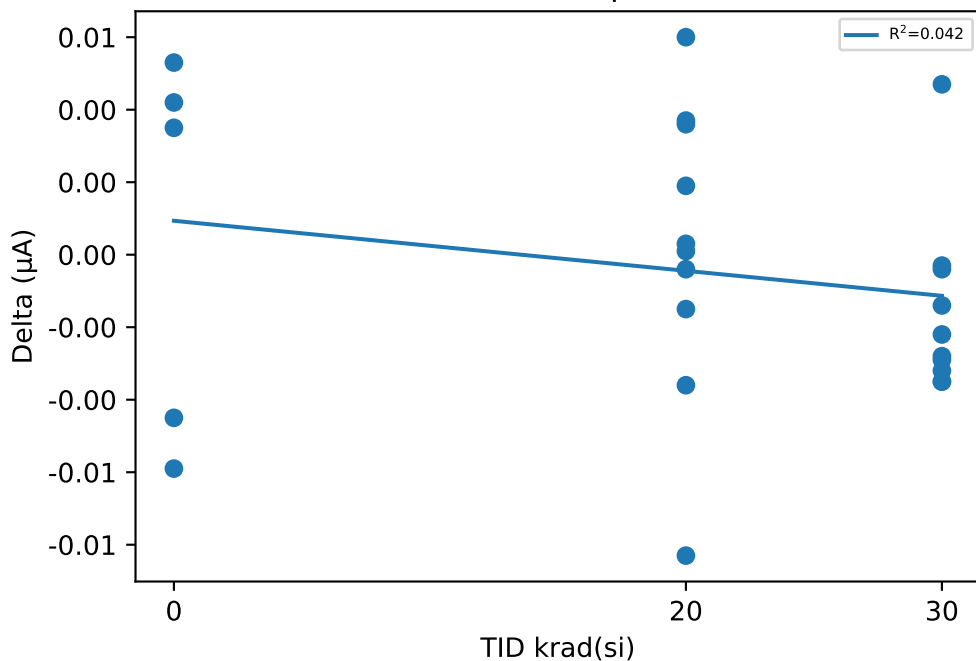

Test Statistics (µA)

krad(si)	Pre Exposure Min	Pre Exposure Avg	Pre Exposure Max	Pre Exposure Std	Post Exposure Min	Post Exposure Avg	Post Exposure Max	Post Exposure Std	Min Delta	Avg Delta	Max Delta	Std Delta
0	-0.0058	-0.00366	-0.0014	0.0019857	-0.0088	-0.00314	0.001	0.0040826	-0.0059	0.00052	0.0053	0.0052841
20	-0.0056	-0.00084	0.004	0.0026788	-0.0043	-0.00066	0.003	0.0025163	-0.0083	0.00018	0.006	0.0040865
30	-0.0082	-0.002	0.0034	0.0030067	-0.0086	-0.00355	0.0007	0.0030116	-0.0035	-0.00155	0.0047	0.0024968

Device Test: 5.24 UJ3WW2(IF1_32V_UJ3WW2)

TID vs Result Stats

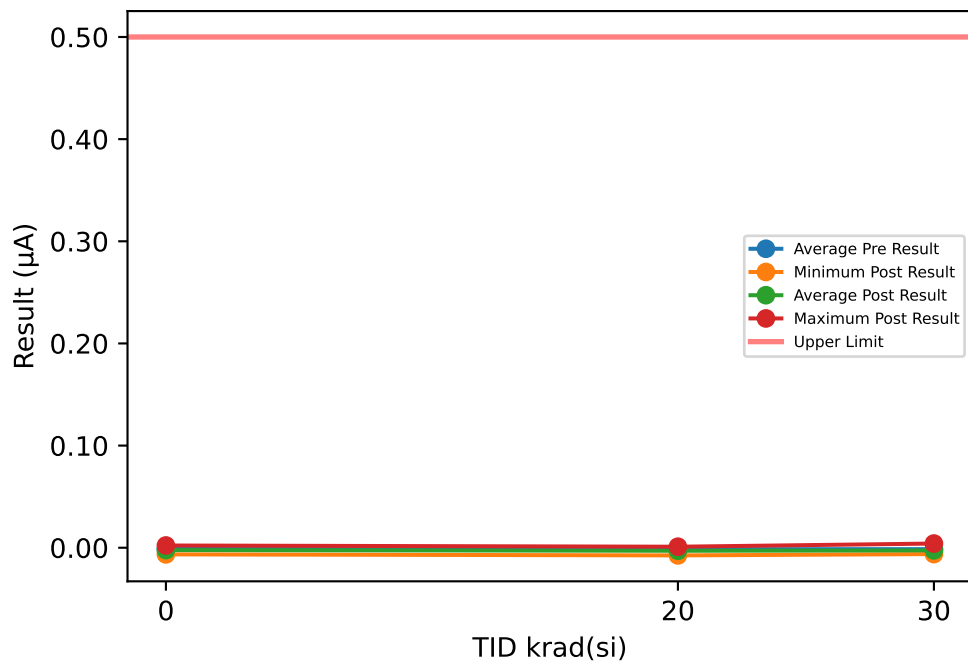

Test Results (Upper Limit = 0.5 (µA))

Serial #	krad(si)	Exposure Conditions	Pre Result	Post Result	Delta
50	20	LDR biased	-0.0023	-0.0059	-0.0036
51	20	LDR biased	-0.0003	-0.0018	-0.0015
52	20	LDR biased	-0.0048	0.001	0.0058
53	20	LDR biased	-0.0017	-0.0075	-0.0058
54	20	LDR biased	-0.0006	-0.0014	-0.0008
55	30	LDR biased	-0.0026	0.0041	0.0067
56	30	LDR biased	-0.0037	-0.0062	-0.0025
57	30	LDR biased	-0.0009	-0.0034	-0.0025
58	30	LDR biased	-0.0033	-0.0057	-0.0024
59	30	LDR biased	-0.0003	-0.0058	-0.0055
60	20	LDR unbiased	-0.0056	-0.0016	0.004
61	20	LDR unbiased	0.0017	-0.0033	-0.005
62	20	LDR unbiased	0	-0.0059	-0.0059
63	20	LDR unbiased	-0.0007	-0.0043	-0.0036
64	20	LDR unbiased	-0.0001	0.001	0.0011
65	30	LDR unbiased	0.004	-0.0023	-0.0063
66	30	LDR unbiased	-0.0027	-0.0037	-0.001
67	30	LDR unbiased	-0.0008	-0.0036	-0.0028
68	30	LDR unbiased	-0.0015	0.0018	0.0033
69	30	LDR unbiased	-0.0023	-0.0013	0.001
70	0	correlation	0.0024	-0.0023	-0.0047
71	0	correlation	-0.0022	0	0.0022
72	0	correlation	-0.0013	0.0022	0.0035
73	0	correlation	0.0011	-0.0065	-0.0076
74	0	correlation	-0.0059	-0.0049	0.001

TID vs Post - Pre Exposure Delta

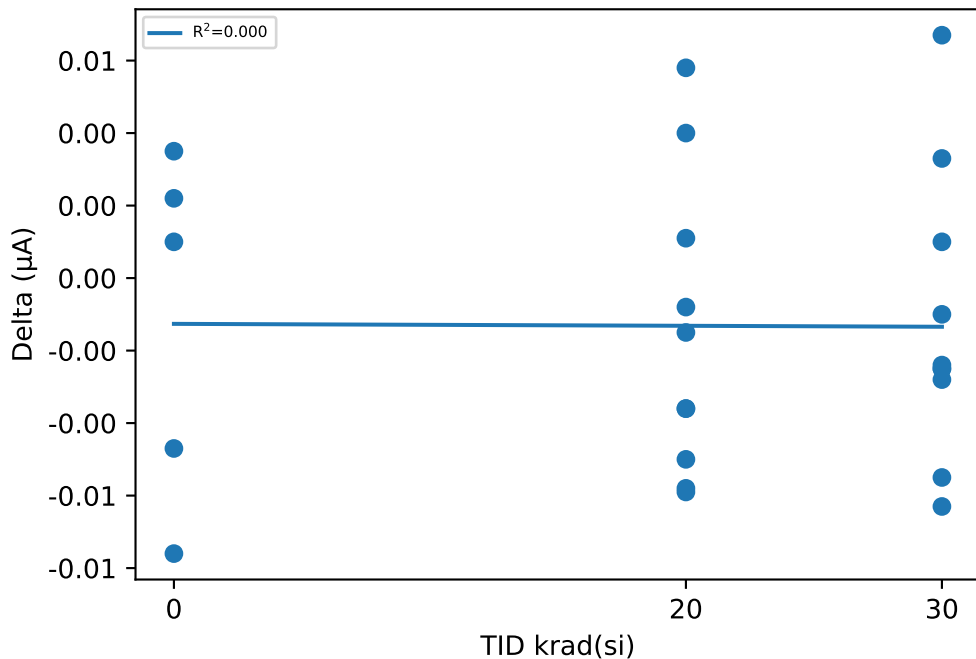

Test Statistics (µA)

krad(si)	Pre Exposure Min	Pre Exposure Avg	Pre Exposure Max	Pre Exposure Std	Post Exposure Min	Post Exposure Avg	Post Exposure Max	Post Exposure Std	Min Delta	Avg Delta	Max Delta	Std Delta
0	-0.0059	-0.00118	0.0024	0.0032151	-0.0065	-0.0023	0.0022	0.0035334	-0.0076	-0.00112	0.0035	0.0047872
20	-0.0056	-0.00144	0.0017	0.002253	-0.0075	-0.00297	0.001	0.0029212	-0.0059	-0.00153	0.0058	0.0040784
30	-0.0037	-0.00141	0.004	0.0022068	-0.0062	-0.00261	0.0041	0.0033614	-0.0063	-0.0012	0.0067	0.0039359

Device Test: 5.25 UJ3WW2(IF2_5V_UJ3WW2)

TID vs Result Stats

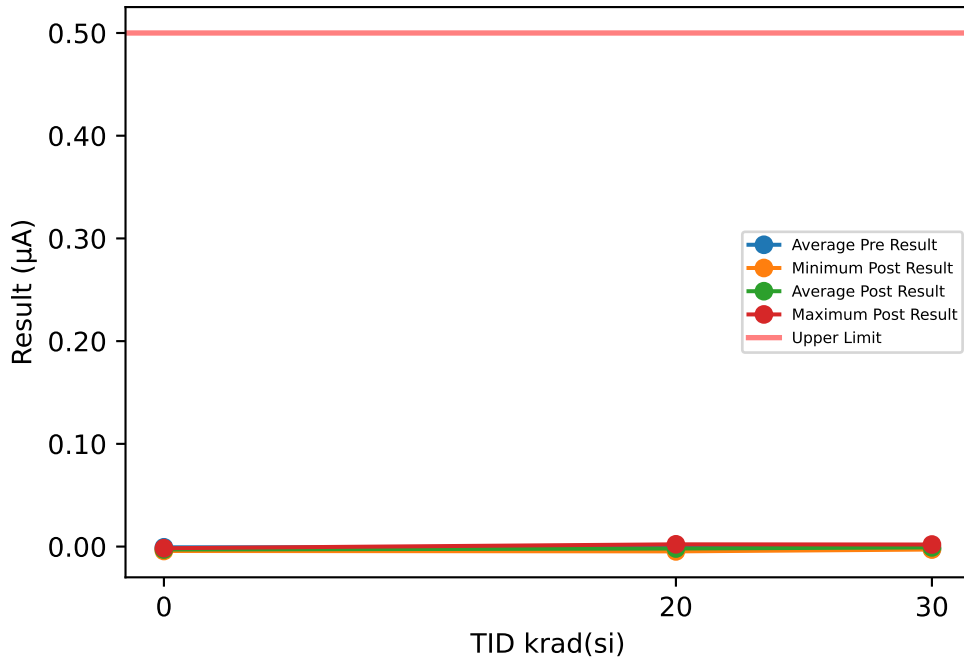

Test Results (Upper Limit = 0.5 (µA))

Serial #	krad(si)	Exposure Conditions	Pre Result	Post Result	Delta
50	20	LDR biased	-0.0033	-0.003	0.0003
51	20	LDR biased	-0.0045	-0.002	0.0025
52	20	LDR biased	0.0006	-0.0039	-0.0045
53	20	LDR biased	-0.0007	-0.0047	-0.004
54	20	LDR biased	-0.0008	-0.0031	-0.0023
55	30	LDR biased	0.001	0.0008	-0.0002
56	30	LDR biased	-0.0014	-0.0024	-0.001
57	30	LDR biased	-0.0027	-0.0013	0.0014
58	30	LDR biased	-0.0031	-0.0024	0.0007
59	30	LDR biased	-0.0033	-0.0012	0.0021
60	20	LDR unbiased	-0.0016	-0.0016	0
61	20	LDR unbiased	0.002	-0.0016	-0.0036
62	20	LDR unbiased	0.0014	-0.0004	-0.0018
63	20	LDR unbiased	0.0014	-0.001	-0.0024
64	20	LDR unbiased	-0.002	0.0022	0.0042
65	30	LDR unbiased	-0.0025	0.002	0.0045
66	30	LDR unbiased	-0.0022	-0.0016	0.0006
67	30	LDR unbiased	-0.0016	0.0004	0.002
68	30	LDR unbiased	-0.0022	0.0004	0.0026
69	30	LDR unbiased	-0.0037	-0.0029	0.0008
70	0	correlation	0.0002	-0.0043	-0.0045
71	0	correlation	-0.0018	-0.0018	0
72	0	correlation	0.0008	-0.0016	-0.0024
73	0	correlation	-0.0011	-0.0043	-0.0032
74	0	correlation	-0.0016	-0.0024	-0.0008

TID vs Post - Pre Exposure Delta

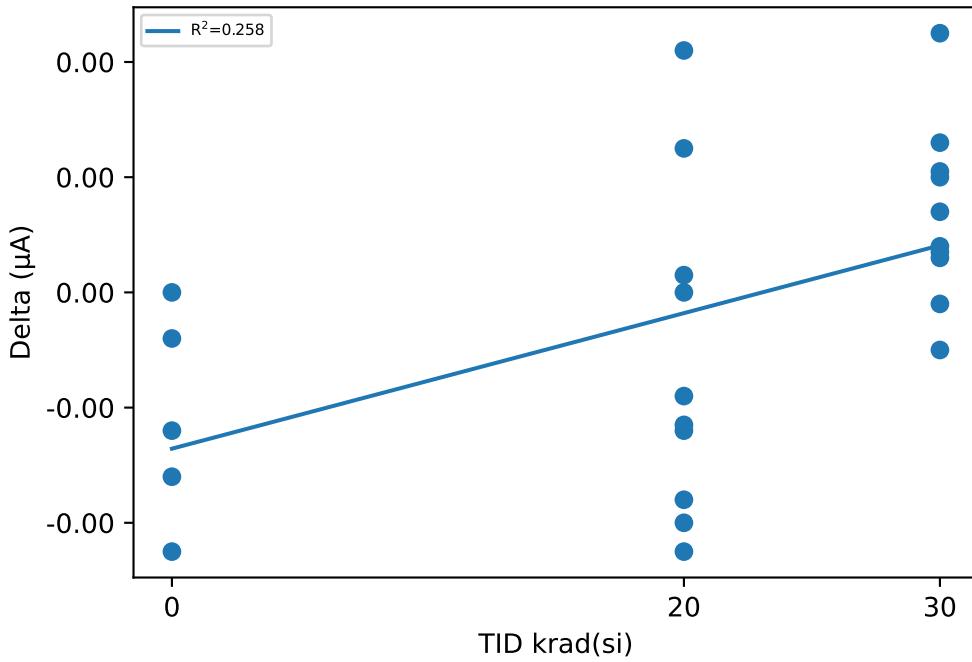

Test Statistics (µA)

krad(si)	Pre Exposure Min	Pre Exposure Avg	Pre Exposure Max	Pre Exposure Std	Post Exposure Min	Post Exposure Avg	Post Exposure Max	Post Exposure Std	Min Delta	Avg Delta	Max Delta	Std Delta
0	-0.0018	-0.0007	0.0008	0.0011446	-0.0043	-0.00288	-0.0016	0.0013293	-0.0045	-0.00218	0	0.0018116
20	-0.0045	-0.00075	0.002	0.002147	-0.0047	-0.00191	0.0022	0.0019593	-0.0045	-0.00116	0.0042	0.0028679
30	-0.0037	-0.00217	0.001	0.0013267	-0.0029	-0.00082	0.002	0.0016281	-0.001	0.00135	0.0045	0.0015522

Device Test: 5.26 UJ3WW2(IF2_12V_UJ3WW2)

TID vs Result Stats

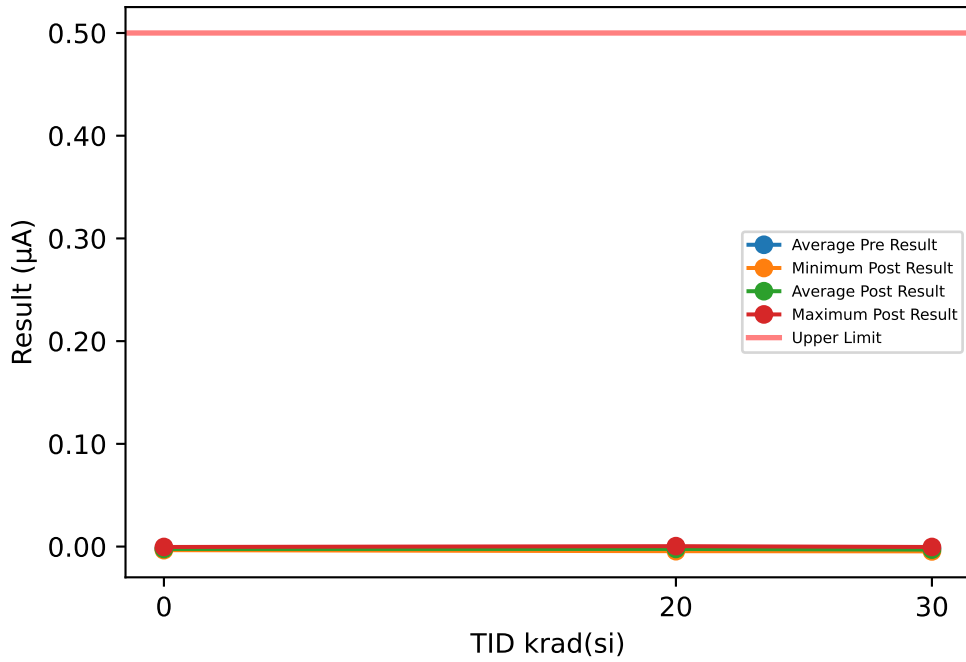

Test Results (Upper Limit = 0.5 (μA))

Serial #	krad(si)	Exposure Conditions	Pre Result	Post Result	Delta
50	20	LDR biased	0.0006	0.0004	-0.0002
51	20	LDR biased	0	-0.0041	-0.0041
52	20	LDR biased	-0.0012	-0.0039	-0.0027
53	20	LDR biased	0.0002	-0.0033	-0.0035
54	20	LDR biased	-0.0024	-0.0022	0.0002
55	30	LDR biased	-0.001	-0.0031	-0.0021
56	30	LDR biased	-0.0028	-0.0024	0.0004
57	30	LDR biased	-0.0002	-0.0043	-0.0041
58	30	LDR biased	-0.0016	-0.0047	-0.0031
59	30	LDR biased	0.0012	-0.0018	-0.003
60	20	LDR unbiased	-0.0033	-0.0045	-0.0012
61	20	LDR unbiased	0.0016	-0.0028	-0.0044
62	20	LDR unbiased	-0.0012	0.0004	0.0016
63	20	LDR unbiased	0.0018	-0.0018	-0.0036
64	20	LDR unbiased	-0.0022	-0.0012	0.001
65	30	LDR unbiased	-0.0041	-0.0043	-0.0002
66	30	LDR unbiased	-0.0018	-0.002	-0.0002
67	30	LDR unbiased	-0.0014	-0.0039	-0.0025
68	30	LDR unbiased	-0.0026	-0.0004	0.0022
69	30	LDR unbiased	-0.0029	-0.0026	0.0003
70	0	correlation	-0.0004	-0.0033	-0.0029
71	0	correlation	-0.0018	-0.0004	0.0014
72	0	correlation	-0.0014	-0.0031	-0.0017
73	0	correlation	-0.0027	-0.0035	-0.0008
74	0	correlation	-0.0041	-0.0014	0.0027

TID vs Post - Pre Exposure Delta

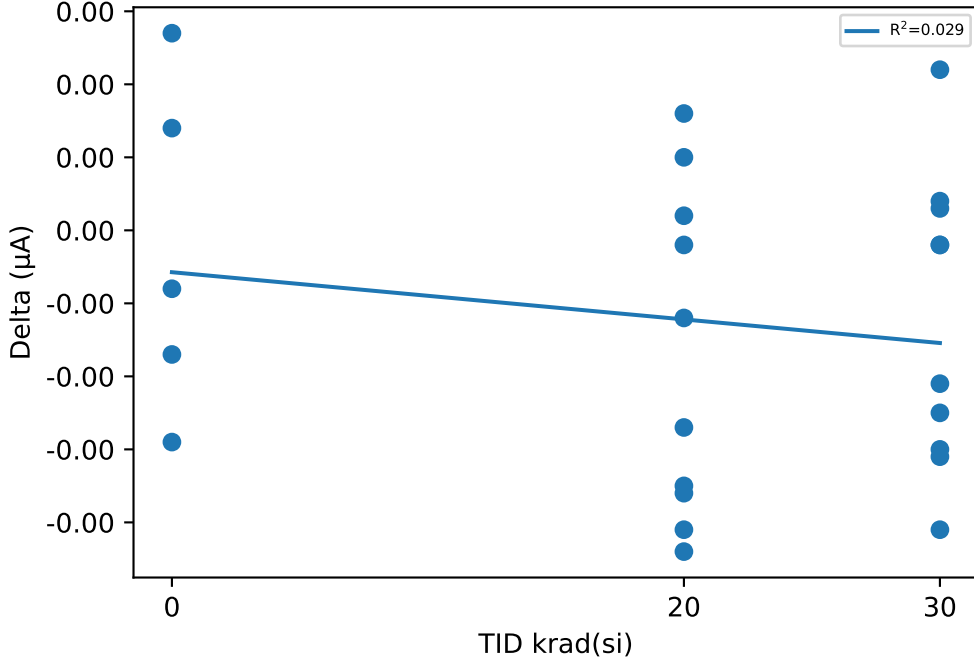

Test Statistics (μA)

krad(si)	Pre Exposure Min	Pre Exposure Avg	Pre Exposure Max	Pre Exposure Std	Post Exposure Min	Post Exposure Avg	Post Exposure Max	Post Exposure Std	Min Delta	Avg Delta	Max Delta	Std Delta
0	-0.0041	-0.00208	-0.0004	0.0013989	-0.0035	-0.00234	-0.0004	0.0013686	-0.0029	-0.00026	0.0027	0.0022832
20	-0.0033	-0.00061	0.0018	0.0017272	-0.0045	-0.0023	0.0004	0.0017619	-0.0044	-0.00169	0.0016	0.0022408
30	-0.0041	-0.00172	0.0012	0.0015083	-0.0047	-0.00295	-0.0004	0.0013657	-0.0041	-0.00123	0.0022	0.0020034

Device Test: 5.27 UJ3WW2(IF2_28V_UJ3WW2)

TID vs Result Stats

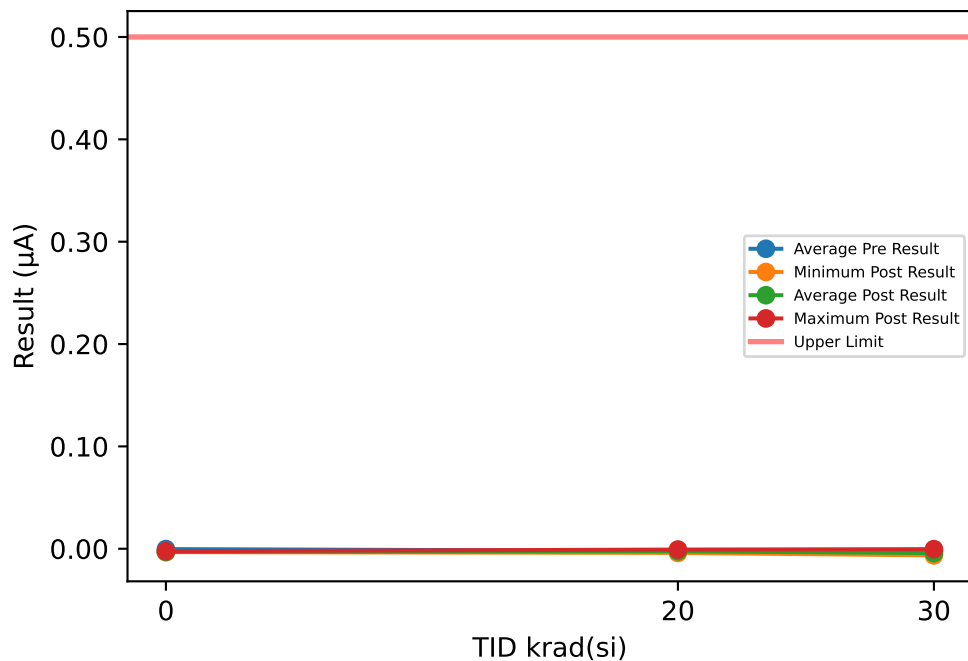

TID vs Post - Pre Exposure Delta

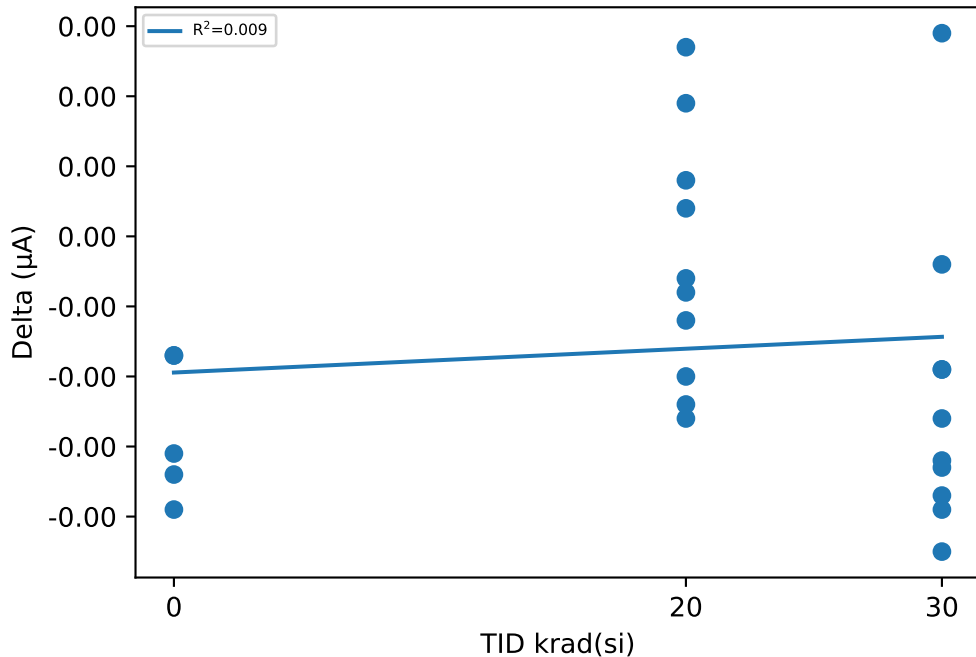

Test Results (Upper Limit = 0.5 (µA))

Serial #	krad(si)	Exposure Conditions	Pre Result	Post Result	Delta
50	20	LDR biased	-0.0014	-0.002	-0.0006
51	20	LDR biased	0.0004	-0.0022	-0.0026
52	20	LDR biased	-0.0045	-0.0026	0.0019
53	20	LDR biased	-0.0049	-0.0041	0.0008
54	20	LDR biased	-0.0012	-0.002	-0.0008
55	30	LDR biased	-0.0016	-0.0055	-0.0039
56	30	LDR biased	-0.0029	-0.0055	-0.0026
57	30	LDR biased	-0.0041	-0.006	-0.0019
58	30	LDR biased	-0.0018	-0.0037	-0.0019
59	30	LDR biased	-0.002	-0.0065	-0.0045
60	20	LDR unbiased	-0.0004	-0.0016	-0.0012
61	20	LDR unbiased	-0.0035	-0.0008	0.0027
62	20	LDR unbiased	-0.0002	-0.0026	-0.0024
63	20	LDR unbiased	-0.001	-0.003	-0.002
64	20	LDR unbiased	-0.0043	-0.0039	0.0004
65	30	LDR unbiased	-0.0033	-0.0004	0.0029
66	30	LDR unbiased	0.0002	-0.0035	-0.0037
67	30	LDR unbiased	0.001	-0.0023	-0.0033
68	30	LDR unbiased	-0.0039	-0.0043	-0.0004
69	30	LDR unbiased	-0.0015	-0.0047	-0.0032
70	0	correlation	0.0006	-0.0033	-0.0039
71	0	correlation	0.001	-0.0024	-0.0034
72	0	correlation	-0.0014	-0.0031	-0.0017
73	0	correlation	-0.0002	-0.0033	-0.0031
74	0	correlation	-0.0016	-0.0033	-0.0017

Test Statistics (µA)

krad(si)	Pre Exposure Min	Pre Exposure Avg	Pre Exposure Max	Pre Exposure Std	Post Exposure Min	Post Exposure Avg	Post Exposure Max	Post Exposure Std	Min Delta	Avg Delta	Max Delta	Std Delta
0	-0.0016	-0.00032	0.001	0.0011628	-0.0033	-0.00308	-0.0024	0.00038987	-0.0039	-0.00276	-0.0017	0.001009
20	-0.0049	-0.0021	0.0004	0.0019905	-0.0041	-0.00248	-0.0008	0.0010042	-0.0026	-0.00038	0.0027	0.0018017
30	-0.0041	-0.00199	0.001	0.0016603	-0.0065	-0.00424	-0.0004	0.0018542	-0.0045	-0.00225	0.0029	0.0021655

Device Test: 5.28 UJ3WW2(IF2_32V_UJ3WW2)

TID vs Result Stats

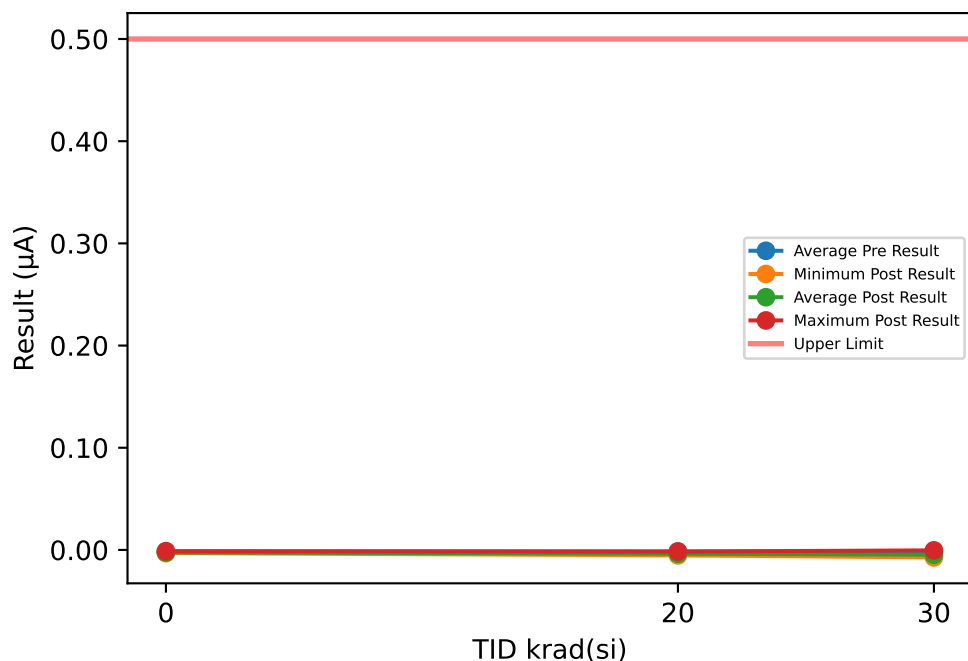

Test Results (Upper Limit = 0.5 (µA))

Serial #	krad(si)	Exposure Conditions	Pre Result	Post Result	Delta
50	20	LDR biased	-0.0037	-0.0053	-0.0016
51	20	LDR biased	-0.0022	-0.0035	-0.0013
52	20	LDR biased	-0.001	-0.0028	-0.0018
53	20	LDR biased	0.0006	-0.0045	-0.0051
54	20	LDR biased	-0.0035	-0.0037	-0.0002
55	30	LDR biased	-0.002	-0.0045	-0.0025
56	30	LDR biased	0.0004	-0.0065	-0.0069
57	30	LDR biased	0.0006	-0.0053	-0.0059
58	30	LDR biased	-0.0035	-0.0073	-0.0038
59	30	LDR biased	-0.0037	-0.0053	-0.0016
60	20	LDR unbiased	-0.0004	-0.0016	-0.0012
61	20	LDR unbiased	-0.0009	-0.0043	-0.0034
62	20	LDR unbiased	-0.0006	-0.0033	-0.0027
63	20	LDR unbiased	-0.0002	-0.0043	-0.0041
64	20	LDR unbiased	-0.0029	-0.0035	-0.0006
65	30	LDR unbiased	-0.0049	-0.0043	0.0006
66	30	LDR unbiased	-0.0002	-0.0045	-0.0043
67	30	LDR unbiased	-0.0018	-0.0045	-0.0027
68	30	LDR unbiased	-0.0002	-0.0004	-0.0002
69	30	LDR unbiased	0.0004	-0.0043	-0.0047
70	0	correlation	-0.002	-0.0012	0.0008
71	0	correlation	-0.0006	-0.0031	-0.0025
72	0	correlation	-0.0026	-0.0031	-0.0005
73	0	correlation	-0.0013	-0.0024	-0.0011
74	0	correlation	-0.001	-0.0028	-0.0018

TID vs Post - Pre Exposure Delta

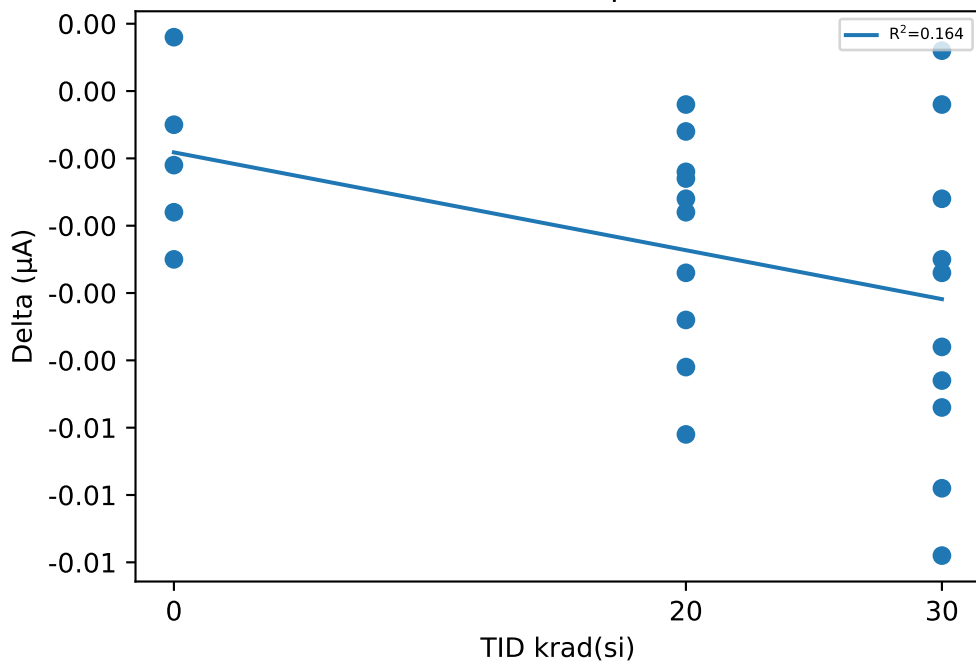

Test Statistics (µA)

krad(si)	Pre Exposure Min	Pre Exposure Avg	Pre Exposure Max	Pre Exposure Std	Post Exposure Min	Post Exposure Avg	Post Exposure Max	Post Exposure Std	Min Delta	Avg Delta	Max Delta	Std Delta
0	-0.0026	-0.0015	-0.0006	0.0008	-0.0031	-0.00252	-0.0012	0.00079183	-0.0025	-0.00102	0.0008	0.0012637
20	-0.0037	-0.00148	0.0006	0.0014913	-0.0053	-0.00368	-0.0016	0.0010207	-0.0051	-0.0022	-0.0002	0.0015846
30	-0.0049	-0.00149	0.0006	0.001993	-0.0073	-0.00469	-0.0004	0.001815	-0.0069	-0.0032	0.0006	0.002393

Device Test: 5.29 UJ3WW2(IF3_5V_UJ3WW2)

TID vs Result Stats

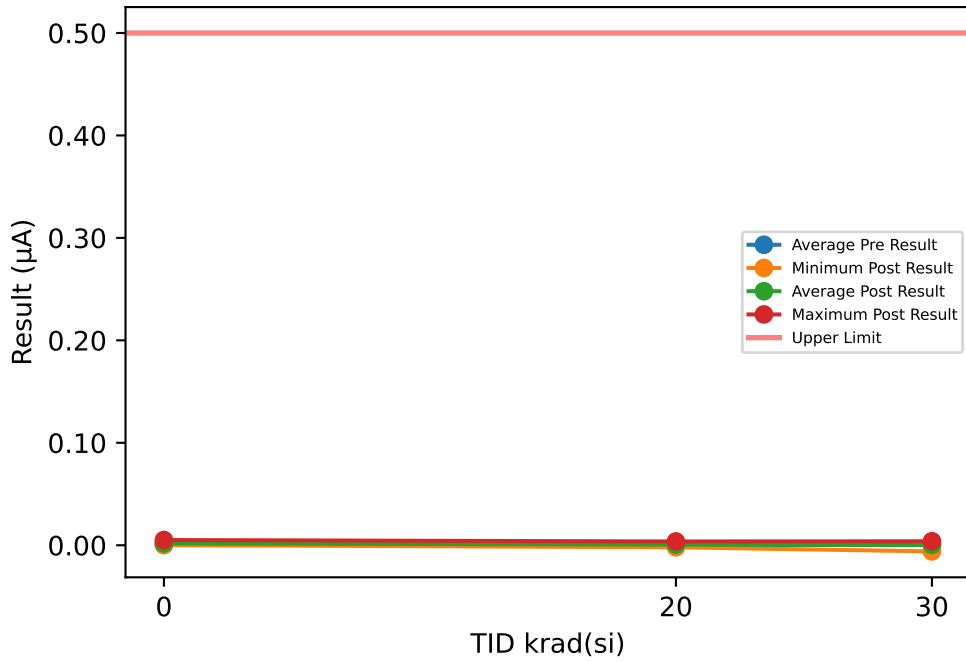

TID vs Post - Pre Exposure Delta

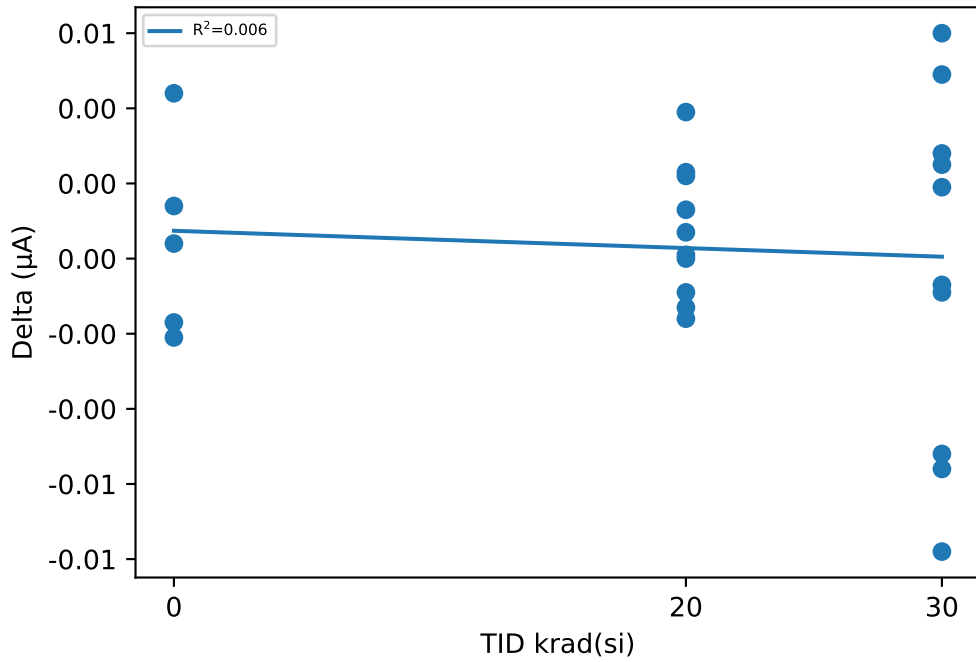

Test Results (Upper Limit = 0.5 (µA))

Serial #	krad(si)	Exposure Conditions	Pre Result	Post Result	Delta
50	20	LDR biased	0.0017	0.0001	-0.0016
51	20	LDR biased	-0.0002	0.0037	0.0039
52	20	LDR biased	-0.0015	-0.0014	0.0001
53	20	LDR biased	0.0016	0.0003	-0.0013
54	20	LDR biased	-0.0004	-0.0004	0
55	30	LDR biased	0.0022	-0.003	-0.0052
56	30	LDR biased	-0.0011	0.0014	0.0025
57	30	LDR biased	-0.0023	0.0026	0.0049
58	30	LDR biased	-0.0001	-0.001	-0.0009
59	30	LDR biased	-0.0014	0.0014	0.0028
60	20	LDR unbiased	-0.0017	-0.001	0.0007
61	20	LDR unbiased	0.0005	0.0027	0.0022
62	20	LDR unbiased	-0.0014	0.0009	0.0023
63	20	LDR unbiased	0.0018	0.0031	0.0013
64	20	LDR unbiased	-0.0011	-0.002	-0.0009
65	30	LDR unbiased	-0.0021	0.0039	0.006
66	30	LDR unbiased	0.0051	-0.0005	-0.0056
67	30	LDR unbiased	0.0018	-0.006	-0.0078
68	30	LDR unbiased	0.002	0.0013	-0.0007
69	30	LDR unbiased	0.0007	0.0026	0.0019
70	0	correlation	0.0015	0.0029	0.0014
71	0	correlation	0.0018	0.0001	-0.0017
72	0	correlation	0.0028	0.0007	-0.0021
73	0	correlation	-0.0003	0.0001	0.0004
74	0	correlation	0.0007	0.0051	0.0044

Test Statistics (µA)

krad(si)	Pre Exposure Min	Pre Exposure Avg	Pre Exposure Max	Pre Exposure Std	Post Exposure Min	Post Exposure Avg	Post Exposure Max	Post Exposure Std	Min Delta	Avg Delta	Max Delta	Std Delta
0	-0.0003	0.0013	0.0028	0.0011683	0.0001	0.00178	0.0051	0.0021845	-0.0021	0.00048	0.0044	0.0026281
20	-0.0017	-7e-05	0.0018	0.0013905	-0.002	0.0006	0.0037	0.0019726	-0.0016	0.00067	0.0039	0.001767
30	-0.0023	0.00048	0.0051	0.002337	-0.006	0.00027	0.0039	0.0029788	-0.0078	-0.00021	0.006	0.0046882

Device Test: 5.3 UJTKLS(Iop_28V_UJTKLS)

TID vs Result Stats

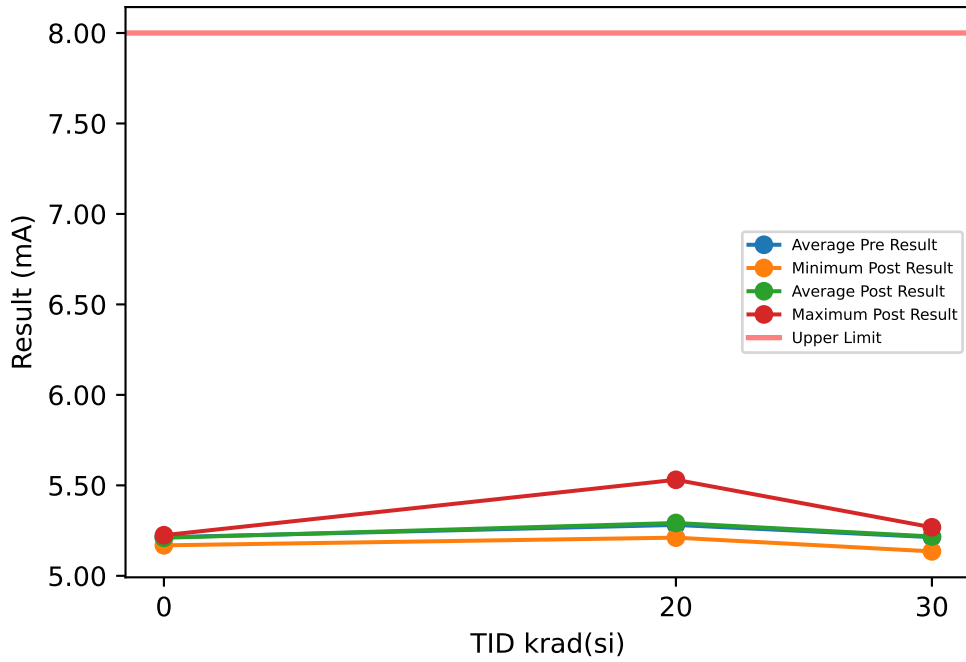

Test Results (Upper Limit = 8.0 (mA))

Serial #	krad(si)	Exposure Conditions	Pre Result	Post Result	Delta
50	20	LDR biased	5.5208	5.5307	0.0099
51	20	LDR biased	5.2201	5.2227	0.0026
52	20	LDR biased	5.2383	5.2494	0.0111
53	20	LDR biased	5.2036	5.211	0.0074
54	20	LDR biased	5.2492	5.262	0.0128
55	30	LDR biased	5.2698	5.2659	-0.0039
56	30	LDR biased	5.1323	5.135	0.0027
57	30	LDR biased	5.2132	5.2262	0.013
58	30	LDR biased	5.1788	5.1753	-0.0035
59	30	LDR biased	5.1733	5.1907	0.0174
60	20	LDR unbiased	5.241	5.2476	0.0066
61	20	LDR unbiased	5.2631	5.2702	0.0071
62	20	LDR unbiased	5.3109	5.3201	0.0092
63	20	LDR unbiased	5.2897	5.3014	0.0117
64	20	LDR unbiased	5.2759	5.3051	0.0292
65	30	LDR unbiased	5.272	5.2683	-0.0037
66	30	LDR unbiased	5.2535	5.2517	-0.0018
67	30	LDR unbiased	5.1907	5.2048	0.0141
68	30	LDR unbiased	5.1995	5.2055	0.006
69	30	LDR unbiased	5.2543	5.2511	-0.0032
70	0	correlation	5.2201	5.2182	-0.0019
71	0	correlation	5.2244	5.2227	-0.0017
72	0	correlation	5.2229	5.2244	0.0015
73	0	correlation	5.1754	5.1685	-0.0069
74	0	correlation	5.2225	5.217	-0.0055

TID vs Post - Pre Exposure Delta

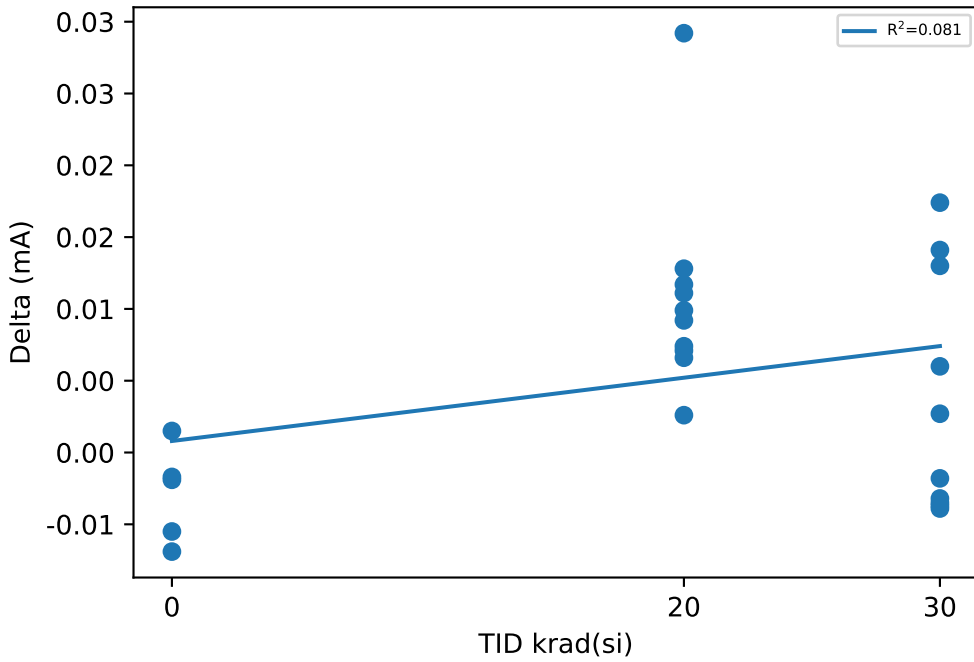

Test Statistics (mA)

krad(si)	Pre Exposure Min	Pre Exposure Avg	Pre Exposure Max	Pre Exposure Std	Post Exposure Min	Post Exposure Avg	Post Exposure Max	Post Exposure Std	Min Delta	Avg Delta	Max Delta	Std Delta
0	5.1754	5.2131	5.2244	0.021109	5.1685	5.2102	5.2244	0.023489	-0.0069	-0.0029	0.0015	0.0033377
20	5.2036	5.2813	5.5208	0.090033	5.211	5.292	5.5307	0.091014	0.0026	0.01076	0.0292	0.0071254
30	5.1323	5.2137	5.272	0.047123	5.135	5.2175	5.2683	0.043344	-0.0039	0.00371	0.0174	0.0083722

Device Test: 5.30 UJ3WW2(IF3_12V_UJ3WW2)

TID vs Result Stats

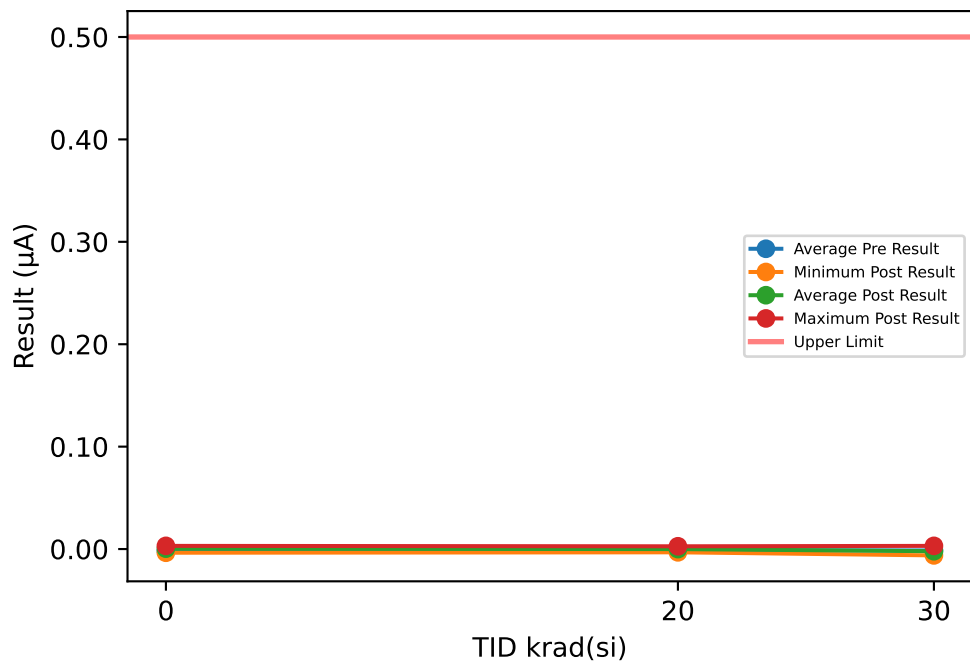

Test Results (Upper Limit = 0.5 (µA))

Serial #	krad(si)	Exposure Conditions	Pre Result	Post Result	Delta
50	20	LDR biased	-0.0018	-0.0032	-0.0014
51	20	LDR biased	-0.0014	0.0005	0.0019
52	20	LDR biased	-0.0005	0.0019	0.0024
53	20	LDR biased	-0.0029	-0.0026	0.0003
54	20	LDR biased	0.0057	0.0027	-0.003
55	30	LDR biased	-0.0004	-0.0014	-0.001
56	30	LDR biased	-0.0041	-0.0015	0.0026
57	30	LDR biased	-0.0039	-0.0039	0
58	30	LDR biased	0.0025	0.0031	0.0006
59	30	LDR biased	-0.0014	-0.0047	-0.0033
60	20	LDR unbiased	-0.0013	-0.0014	-0.0001
61	20	LDR unbiased	-0.0015	0.0017	0.0032
62	20	LDR unbiased	0.0007	0.0005	-0.0002
63	20	LDR unbiased	-0.0041	-0.0014	0.0027
64	20	LDR unbiased	-0.0037	0.0009	0.0046
65	30	LDR unbiased	-0.0072	0.0003	0.0075
66	30	LDR unbiased	0.0011	0.0018	0.0007
67	30	LDR unbiased	0.0006	-0.0062	-0.0068
68	30	LDR unbiased	-0.0007	-0.0034	-0.0027
69	30	LDR unbiased	-0.0005	-0.0054	-0.0049
70	0	correlation	0.0045	0.0031	-0.0014
71	0	correlation	-0.0057	0.0003	0.006
72	0	correlation	-0.0037	0.0005	0.0042
73	0	correlation	-0.0064	0.0017	0.0081
74	0	correlation	0.0023	-0.0036	-0.0059

TID vs Post - Pre Exposure Delta

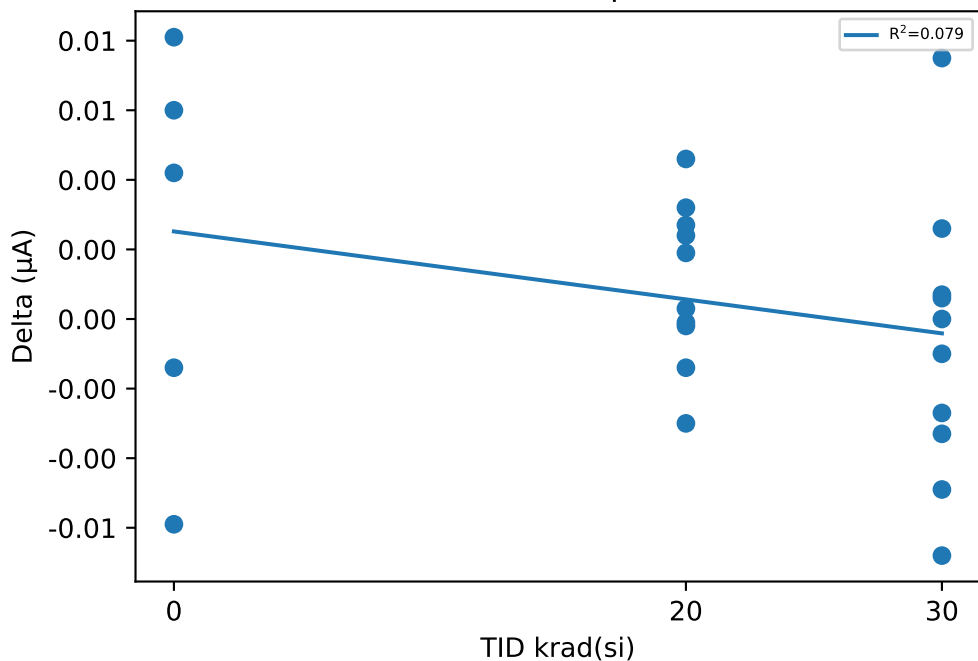

Test Statistics (µA)

krad(si)	Pre Exposure Min	Pre Exposure Avg	Pre Exposure Max	Pre Exposure Std	Post Exposure Min	Post Exposure Avg	Post Exposure Max	Post Exposure Std	Min Delta	Avg Delta	Max Delta	Std Delta
0	-0.0064	-0.0018	0.0045	0.0049112	-0.0036	0.0004	0.0031	0.0025	-0.0059	0.0022	0.0081	0.0057406
20	-0.0041	-0.00108	0.0057	0.0027812	-0.0032	-4e-05	0.0027	0.0020001	-0.003	0.00104	0.0046	0.0023177
30	-0.0072	-0.0014	0.0025	0.0028856	-0.0062	-0.00213	0.0031	0.0031312	-0.0068	-0.00073	0.0075	0.0040546

Device Test: 5.31 UJ3WW2(IF3_28V_UJ3WW2)

TID vs Result Stats

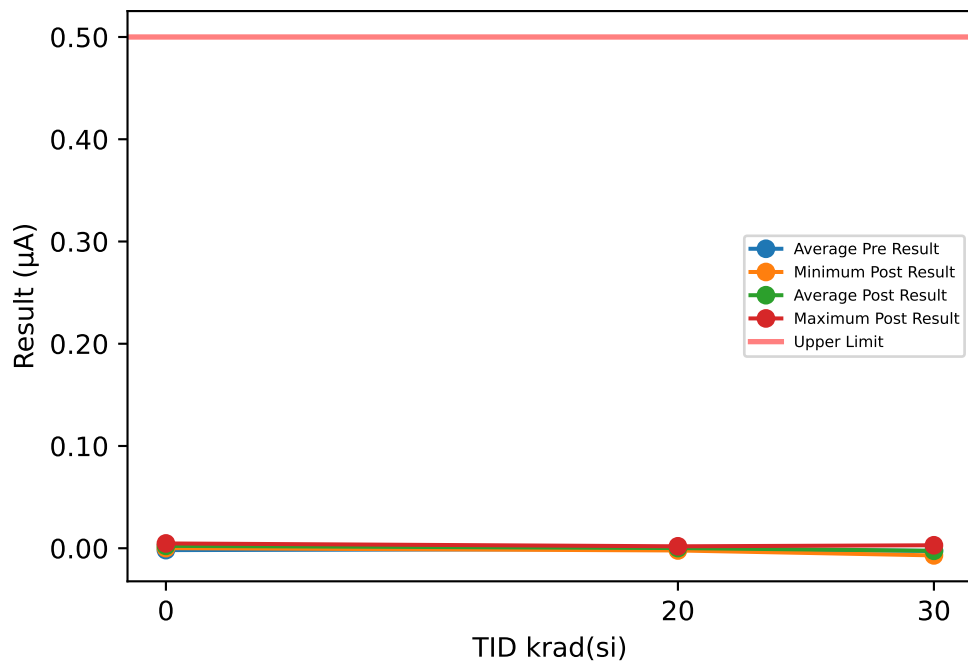

TID vs Post - Pre Exposure Delta

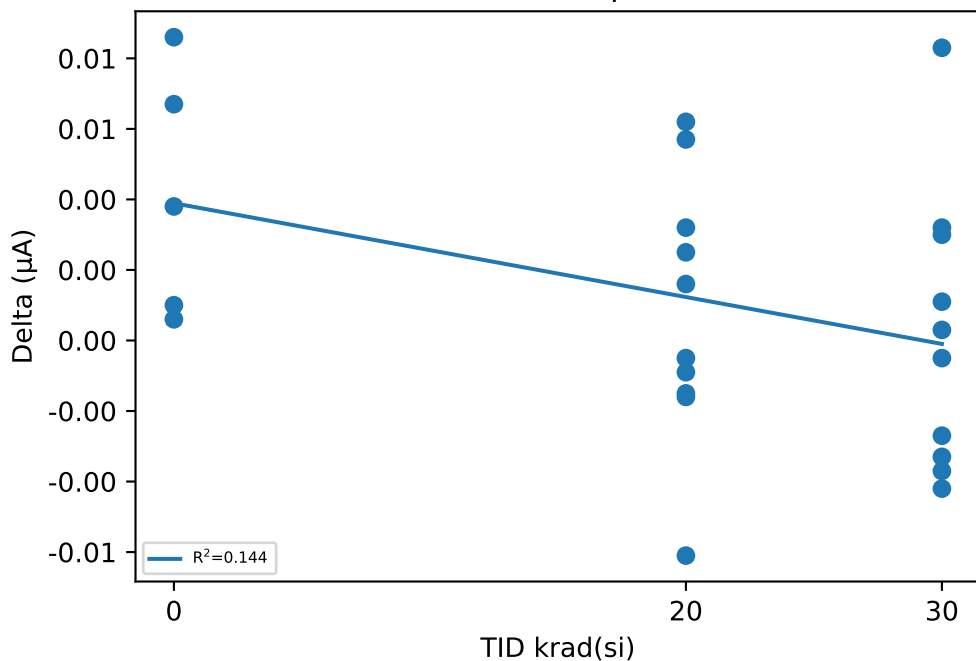

Test Results (Upper Limit = 0.5 (µA))

Serial #	krad(si)	Exposure Conditions	Pre Result	Post Result	Delta
50	20	LDR biased	0.0064	0.0003	-0.0061
51	20	LDR biased	0.0008	-0.0001	-0.0009
52	20	LDR biased	-0.0011	0.0005	0.0016
53	20	LDR biased	-0.0027	0.0005	0.0032
54	20	LDR biased	-0.0006	0.0019	0.0025
55	30	LDR biased	-0.0029	-0.0034	-0.0005
56	30	LDR biased	-0.0027	0.0003	0.003
57	30	LDR biased	-0.0043	-0.007	-0.0027
58	30	LDR biased	0.0033	-0.0004	-0.0037
59	30	LDR biased	-0.0077	-0.0066	0.0011
60	20	LDR unbiased	-0.0054	0.0003	0.0057
61	20	LDR unbiased	-0.0003	-0.0008	-0.0005
62	20	LDR unbiased	0.0019	0.0003	-0.0016
63	20	LDR unbiased	-0.0053	0.0009	0.0062
64	20	LDR unbiased	-0.0007	-0.0022	-0.0015
65	30	LDR unbiased	-0.0054	0.0029	0.0083
66	30	LDR unbiased	-0.0012	-0.0054	-0.0042
67	30	LDR unbiased	-0.0031	-0.0064	-0.0033
68	30	LDR unbiased	0.0008	0.0011	0.0003
69	30	LDR unbiased	-0.0033	-0.0001	0.0032
70	0	correlation	0.0007	0.0017	0.001
71	0	correlation	-0.0037	0.0001	0.0038
72	0	correlation	0.0005	0.0011	0.0006
73	0	correlation	-0.0039	0.0047	0.0086
74	0	correlation	-0.0028	0.0039	0.0067

Test Statistics (µA)

krad(si)	Pre Exposure Min	Pre Exposure Avg	Pre Exposure Max	Pre Exposure Std	Post Exposure Min	Post Exposure Avg	Post Exposure Max	Post Exposure Std	Min Delta	Avg Delta	Max Delta	Std Delta
0	-0.0039	-0.00184	0.0007	0.0022667	0.0001	0.0023	0.0047	0.0019339	0.0006	0.00414	0.0086	0.0034983
20	-0.0054	-0.0007	0.0064	0.003448	-0.0022	0.00016	0.0019	0.0010762	-0.0061	0.00086	0.0062	0.0037367
30	-0.0077	-0.00265	0.0033	0.0030891	-0.007	-0.0025	0.0029	0.003676	-0.0042	0.00015	0.0083	0.0039294

Device Test: 5.32 UJ3WW2(IF3_32V_UJ3WW2)

TID vs Result Stats

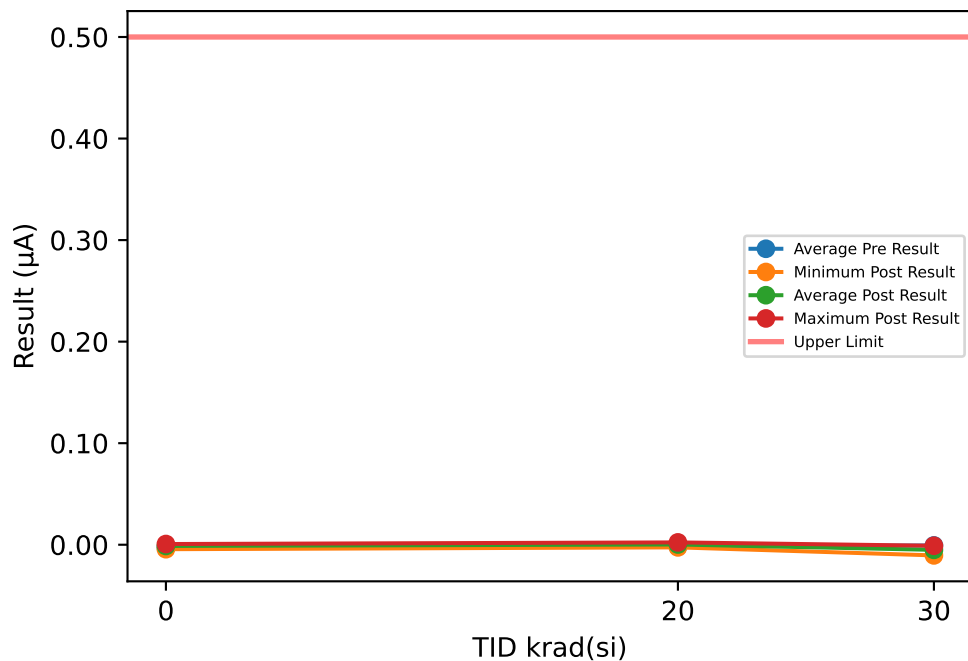

TID vs Post - Pre Exposure Delta

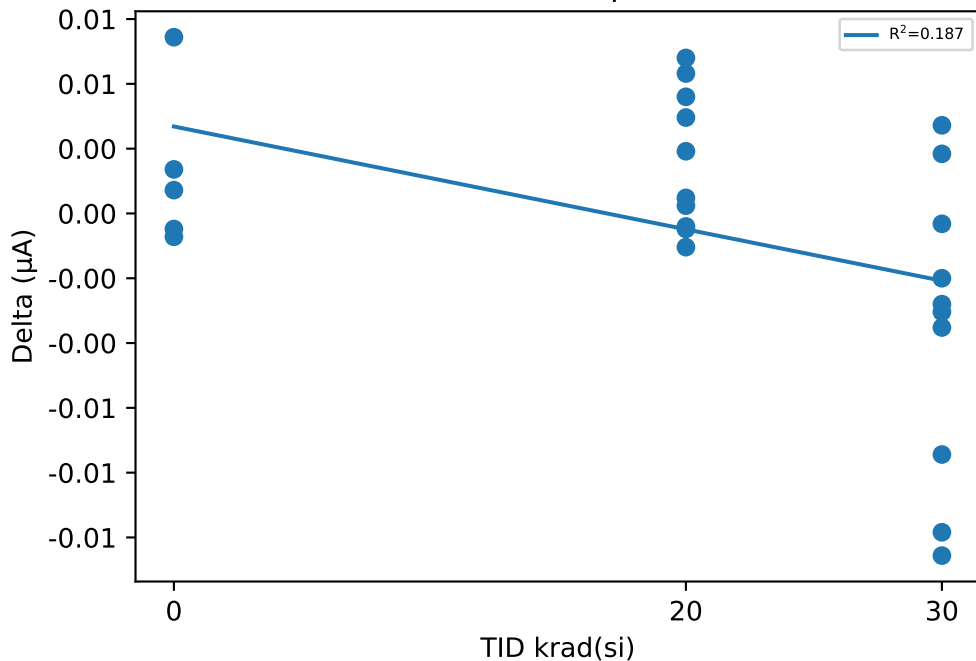

Test Results (Upper Limit = 0.5 (µA))

Serial #	krad(si)	Exposure Conditions	Pre Result	Post Result	Delta
50	20	LDR biased	0.0017	0.0023	0.0006
51	20	LDR biased	-0.0018	0.0019	0.0037
52	20	LDR biased	-0.0015	-0.002	-0.0005
53	20	LDR biased	-0.0029	-0.0026	0.0003
54	20	LDR biased	0.0005	-0.0001	-0.0006
55	30	LDR biased	-0.0026	-0.003	-0.0004
56	30	LDR biased	0.0034	-0.0098	-0.0132
57	30	LDR biased	-0.0048	-0.0092	-0.0044
58	30	LDR biased	0.0057	-0.0036	-0.0093
59	30	LDR biased	0.0018	-0.0105	-0.0123
60	20	LDR unbiased	-0.0047	-0.0002	0.0045
61	20	LDR unbiased	-0.0041	0.0013	0.0054
62	20	LDR unbiased	0.0011	-0.0002	-0.0013
63	20	LDR unbiased	-0.0043	0.0017	0.006
64	20	LDR unbiased	-0.0021	0.0003	0.0024
65	30	LDR unbiased	-0.0033	-0.001	0.0023
66	30	LDR unbiased	-0.0001	-0.0039	-0.0038
67	30	LDR unbiased	-0.0047	-0.0013	0.0034
68	30	LDR unbiased	0.0005	-0.003	-0.0035
69	30	LDR unbiased	-0.0027	-0.0052	-0.0025
70	0	correlation	0.0013	0.0007	-0.0006
71	0	correlation	-0.0035	-0.0044	-0.0009
72	0	correlation	-0.0041	-0.0024	0.0017
73	0	correlation	-0.007	-0.0002	0.0068
74	0	correlation	-0.0006	0.0003	0.0009

Test Statistics (µA)

krad(si)	Pre Exposure Min	Pre Exposure Avg	Pre Exposure Max	Pre Exposure Std	Post Exposure Min	Post Exposure Avg	Post Exposure Max	Post Exposure Std	Min Delta	Avg Delta	Max Delta	Std Delta
0	-0.007	-0.00278	0.0013	0.0032198	-0.0044	-0.0012	0.0007	0.0021529	-0.0009	0.00158	0.0068	0.0031076
20	-0.0047	-0.00181	0.0017	0.0022922	-0.0026	0.00024	0.0023	0.0016277	-0.0013	0.00205	0.006	0.0026995
30	-0.0048	-0.00068	0.0057	0.0035433	-0.0105	-0.00505	-0.001	0.0035246	-0.0132	-0.00437	0.0034	0.00568

Device Test: 5.33 UJ3WW2(IF4_5V_UJ3WW2)

TID vs Result Stats

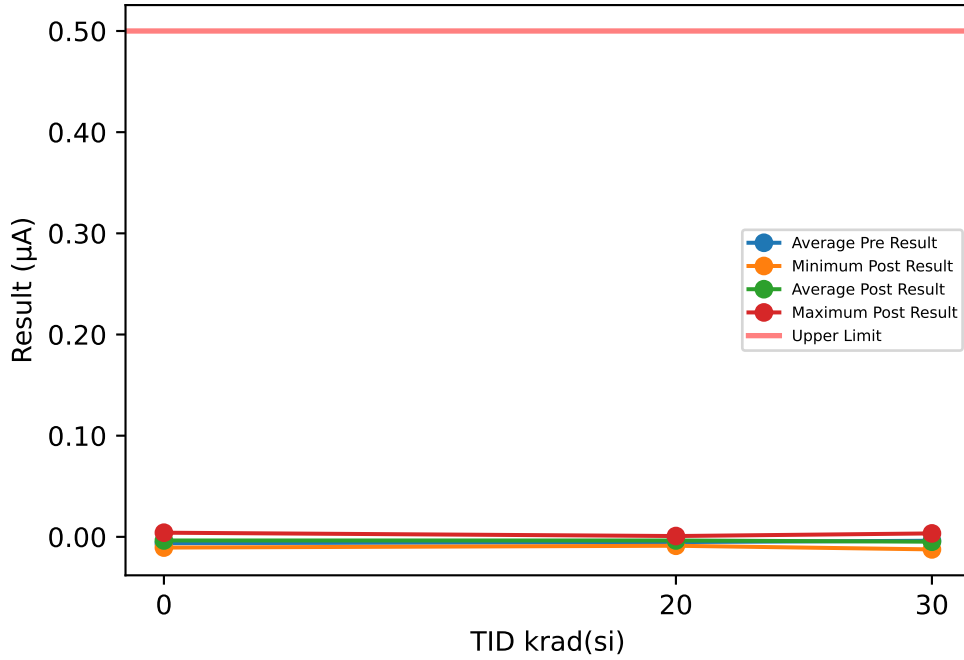

Test Results (Upper Limit = 0.5 (µA))

Serial #	krad(si)	Exposure Conditions	Pre Result	Post Result	Delta
50	20	LDR biased	-0.0027	-0.0088	-0.0061
51	20	LDR biased	-0.0064	-0.0051	0.0013
52	20	LDR biased	-0.0065	0.0002	0.0067
53	20	LDR biased	-0.0034	0.0008	0.0042
54	20	LDR biased	-0.0016	-0.0037	-0.0021
55	30	LDR biased	-0.0036	-0.0018	0.0018
56	30	LDR biased	-0.0068	-0.0049	0.0019
57	30	LDR biased	-0.002	-0.0083	-0.0063
58	30	LDR biased	0.0018	-0.0124	-0.0142
59	30	LDR biased	-0.0072	-0.0021	0.0051
60	20	LDR unbiased	-0.0128	-0.0041	0.0087
61	20	LDR unbiased	-0.0038	-0.0021	0.0017
62	20	LDR unbiased	-0.0004	-0.0047	-0.0043
63	20	LDR unbiased	-0.0068	-0.0075	-0.0007
64	20	LDR unbiased	-0.0074	-0.0008	0.0066
65	30	LDR unbiased	-0.0024	0.0034	0.0058
66	30	LDR unbiased	-0.002	0	0.002
67	30	LDR unbiased	-0.0072	-0.0075	-0.0003
68	30	LDR unbiased	-0.0027	-0.0069	-0.0042
69	30	LDR unbiased	-0.0063	-0.0074	-0.0011
70	0	correlation	-0.0118	-0.0106	0.0012
71	0	correlation	-0.0044	0.0002	0.0046
72	0	correlation	-0.009	0.0041	0.0131
73	0	correlation	-0.0073	-0.0053	0.002
74	0	correlation	0.001	-0.0063	-0.0073

TID vs Post - Pre Exposure Delta

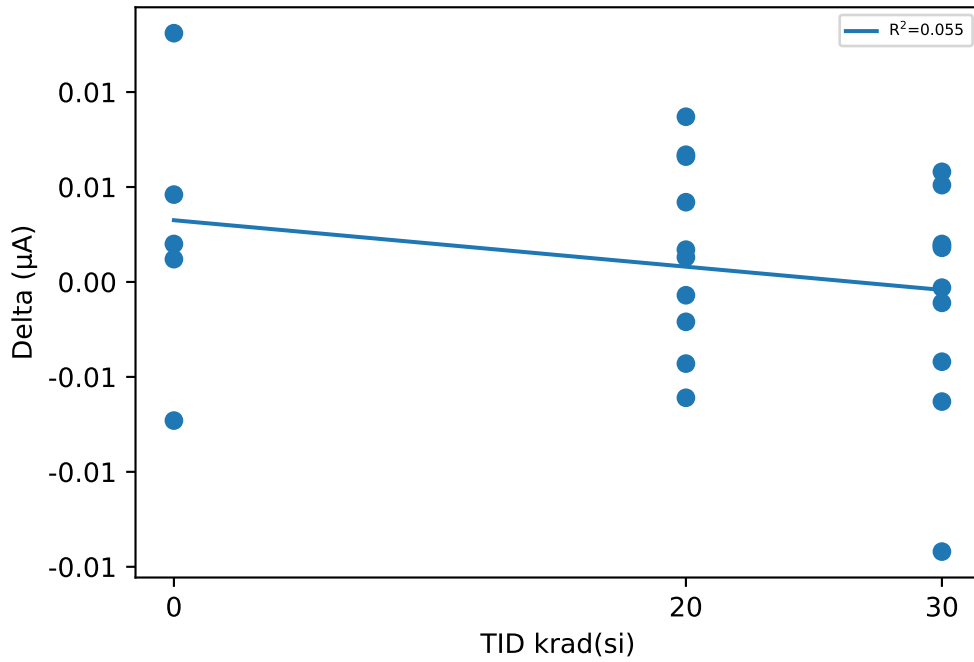

Test Statistics (µA)

krad(si)	Pre Exposure Min	Pre Exposure Avg	Pre Exposure Max	Pre Exposure Std	Post Exposure Min	Post Exposure Avg	Post Exposure Max	Post Exposure Std	Min Delta	Avg Delta	Max Delta	Std Delta
0	-0.0118	-0.0063	0.001	0.0048847	-0.0106	-0.00358	0.0041	0.0057643	-0.0073	0.00272	0.0131	0.007323
20	-0.0128	-0.00518	-0.0004	0.003586	-0.0088	-0.00358	0.0008	0.0031597	-0.0061	0.0016	0.0087	0.0049594
30	-0.0072	-0.00384	0.0018	0.0029703	-0.0124	-0.00479	0.0034	0.0046553	-0.0142	-0.00095	0.0058	0.0059791

Device Test: 5.34 UJ3WW2(IF4_12V_UJ3WW2)

TID vs Result Stats

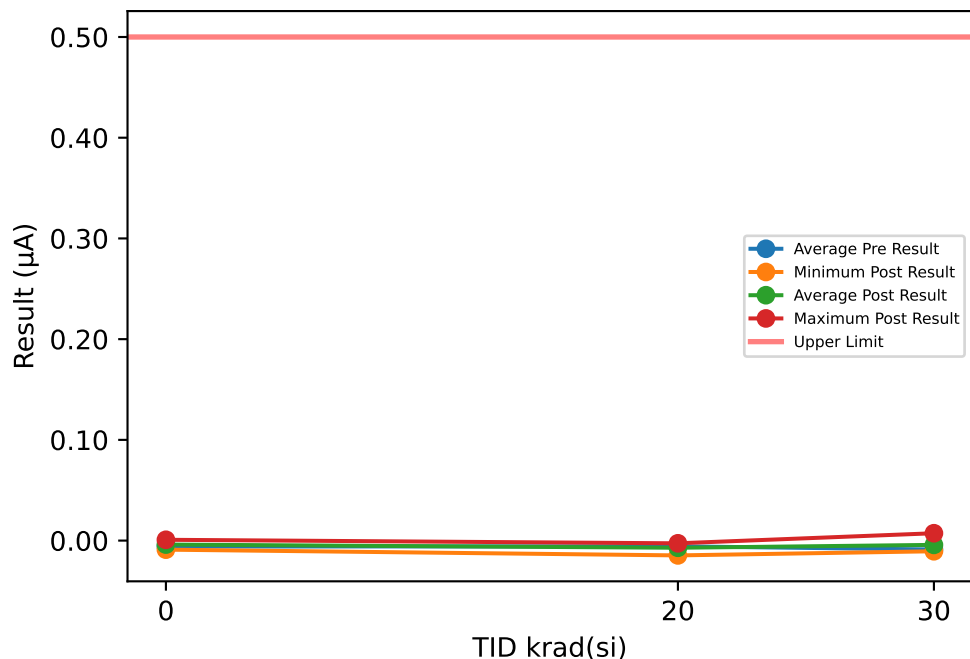

TID vs Post - Pre Exposure Delta

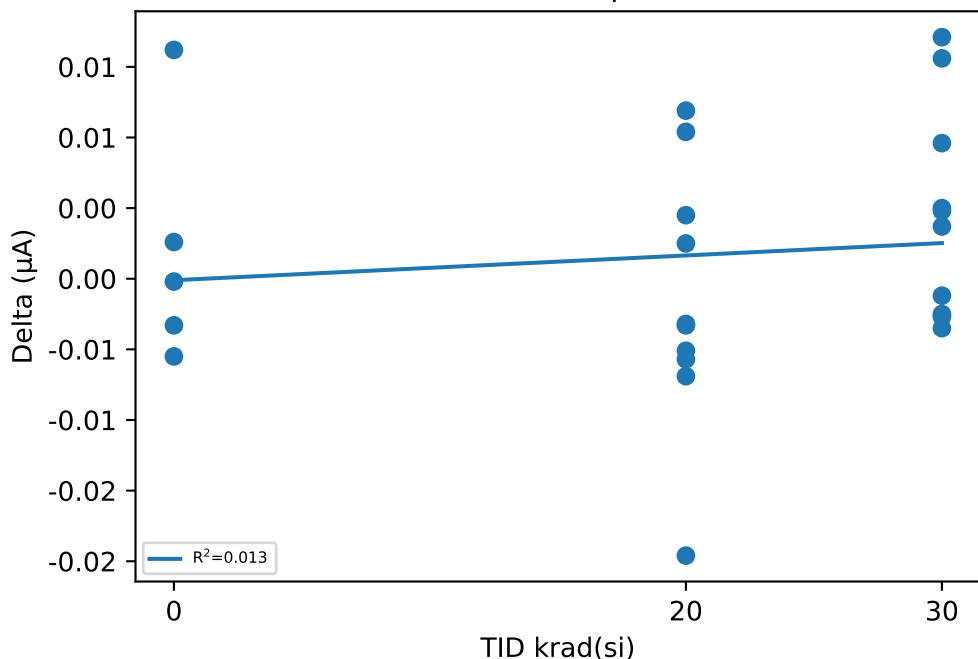

Test Results (Upper Limit = 0.5 (µA))

Serial #	krad(si)	Exposure Conditions	Pre Result	Post Result	Delta
50	20	LDR biased	-0.0161	-0.0057	0.0104
51	20	LDR biased	-0.007	-0.0102	-0.0032
52	20	LDR biased	-0.0084	-0.0059	0.0025
53	20	LDR biased	-0.0018	-0.0075	-0.0057
54	20	LDR biased	-0.0041	-0.011	-0.0069
55	30	LDR biased	-0.0083	0.0073	0.0156
56	30	LDR biased	-0.007	-0.0033	0.0037
57	30	LDR biased	-0.0081	-0.0093	-0.0012
58	30	LDR biased	-0.0069	-0.0094	-0.0025
59	30	LDR biased	-0.0093	-0.0043	0.005
60	20	LDR unbiased	0.0006	-0.0027	-0.0033
61	20	LDR unbiased	0.0002	-0.0049	-0.0051
62	20	LDR unbiased	0.0049	-0.0147	-0.0196
63	20	LDR unbiased	-0.0166	-0.0047	0.0119
64	20	LDR unbiased	-0.0084	-0.0039	0.0045
65	30	LDR unbiased	-0.0071	-0.0106	-0.0035
66	30	LDR unbiased	-0.0151	-0.0055	0.0096
67	30	LDR unbiased	-0.0103	-0.0055	0.0048
68	30	LDR unbiased	-0.0139	0.0032	0.0171
69	30	LDR unbiased	-0.0024	-0.0051	-0.0027
70	0	correlation	0.0041	0.0008	-0.0033
71	0	correlation	-0.0158	0.0004	0.0162
72	0	correlation	-0.0037	-0.0039	-0.0002
73	0	correlation	-0.0116	-0.009	0.0026
74	0	correlation	-0.0025	-0.008	-0.0055

Test Statistics (µA)

krad(si)	Pre Exposure Min	Pre Exposure Avg	Pre Exposure Max	Pre Exposure Std	Post Exposure Min	Post Exposure Avg	Post Exposure Max	Post Exposure Std	Min Delta	Avg Delta	Max Delta	Std Delta
0	-0.0158	-0.0059	0.0041	0.0078565	-0.009	-0.00394	0.0008	0.004566	-0.0055	0.00196	0.0162	0.0085319
20	-0.0166	-0.00567	0.0049	0.0070542	-0.0147	-0.00712	-0.0027	0.0037466	-0.0196	-0.00145	0.0119	0.0092295
30	-0.0151	-0.00884	-0.0024	0.0036458	-0.0106	-0.00425	0.0073	0.0056372	-0.0035	0.00459	0.0171	0.0074997

Device Test: 5.35 UJ3WW2(IF4_28V_UJ3WW2)

TID vs Result Stats

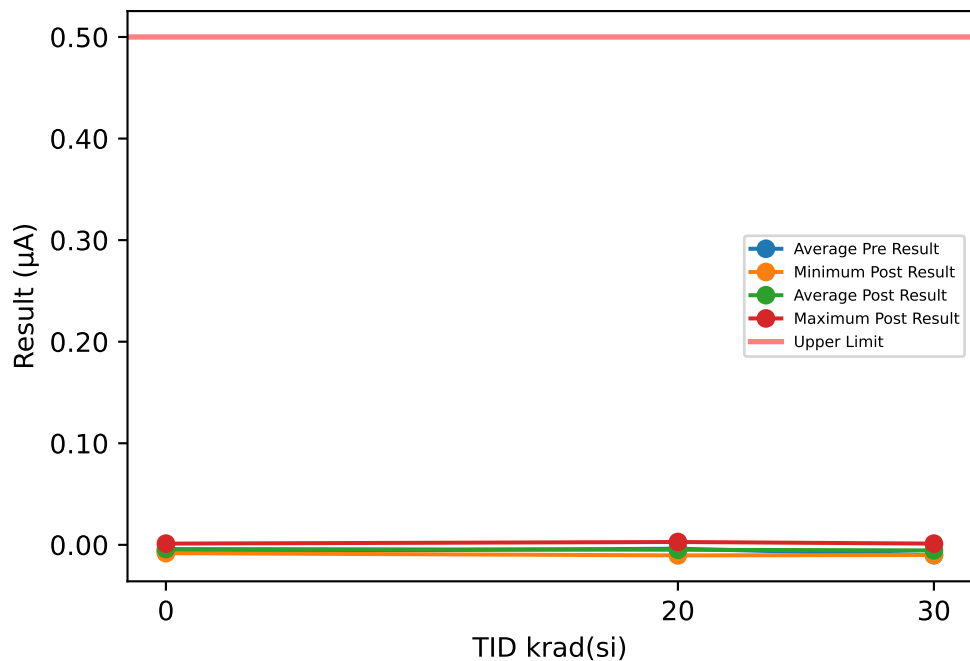

Test Results (Upper Limit = 0.5 (µA))

Serial #	krad(si)	Exposure Conditions	Pre Result	Post Result	Delta
50	20	LDR biased	-0.0069	-0.0047	0.0022
51	20	LDR biased	-0.0103	-0.0096	0.0007
52	20	LDR biased	-0.0078	-0.0012	0.0066
53	20	LDR biased	-0.0026	-0.0059	-0.0033
54	20	LDR biased	0.0012	-0.0061	-0.0073
55	30	LDR biased	-0.0197	-0.0063	0.0134
56	30	LDR biased	0.0006	-0.01	-0.0106
57	30	LDR biased	-0.0075	-0.0045	0.003
58	30	LDR biased	-0.0075	-0.0082	-0.0007
59	30	LDR biased	-0.0211	-0.01	0.0111
60	20	LDR unbiased	0.0077	-0.0035	-0.0112
61	20	LDR unbiased	-0.0053	-0.008	-0.0027
62	20	LDR unbiased	-0.0027	-0.0104	-0.0077
63	20	LDR unbiased	-0.0115	-0.0018	0.0097
64	20	LDR unbiased	0.0002	0.0028	0.0026
65	30	LDR unbiased	-0.0091	0.0012	0.0103
66	30	LDR unbiased	-0.0073	-0.0055	0.0018
67	30	LDR unbiased	-0.0125	-0.002	0.0105
68	30	LDR unbiased	-0.0143	-0.0031	0.0112
69	30	LDR unbiased	-0.0032	-0.0065	-0.0033
70	0	correlation	-0.0118	0.0012	0.013
71	0	correlation	-0.0127	-0.0008	0.0119
72	0	correlation	-0.0084	-0.0078	0.0006
73	0	correlation	-0.0004	-0.0082	-0.0078
74	0	correlation	0	-0.0051	-0.0051

TID vs Post - Pre Exposure Delta

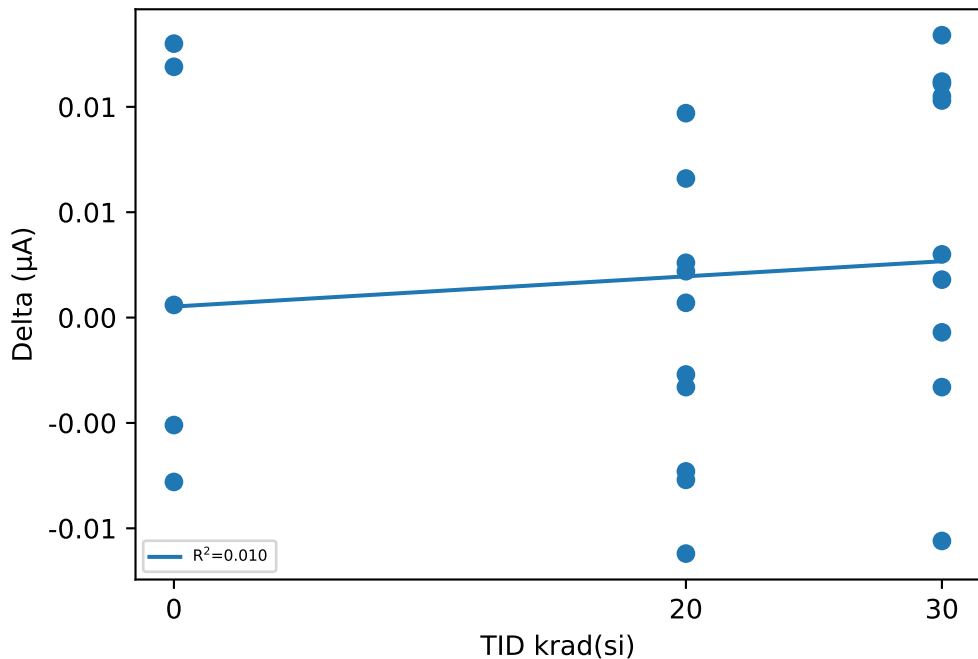

Test Statistics (µA)

krad(si)	Pre Exposure Min	Pre Exposure Avg	Pre Exposure Max	Pre Exposure Std	Post Exposure Min	Post Exposure Avg	Post Exposure Max	Post Exposure Std	Min Delta	Avg Delta	Max Delta	Std Delta
0	-0.0127	-0.00666	0	0.0061129	-0.0082	-0.00414	0.0012	0.0041974	-0.0078	0.00252	0.013	0.0095665
20	-0.0115	-0.0038	0.0077	0.0058243	-0.0104	-0.00484	0.0028	0.0040681	-0.0112	-0.00104	0.0097	0.0066259
30	-0.0211	-0.01016	0.0006	0.0068393	-0.01	-0.00549	0.0012	0.0035485	-0.0106	0.00467	0.0134	0.0079053

Device Test: 5.36 UJ3WW2(IF4_32V_UJ3WW2)

TID vs Result Stats

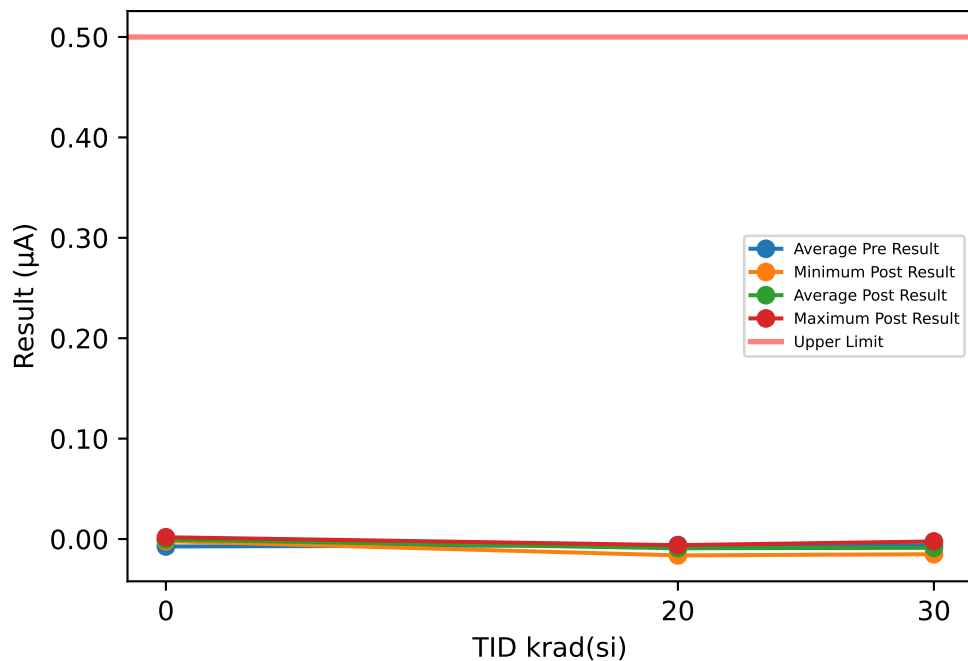

TID vs Post - Pre Exposure Delta

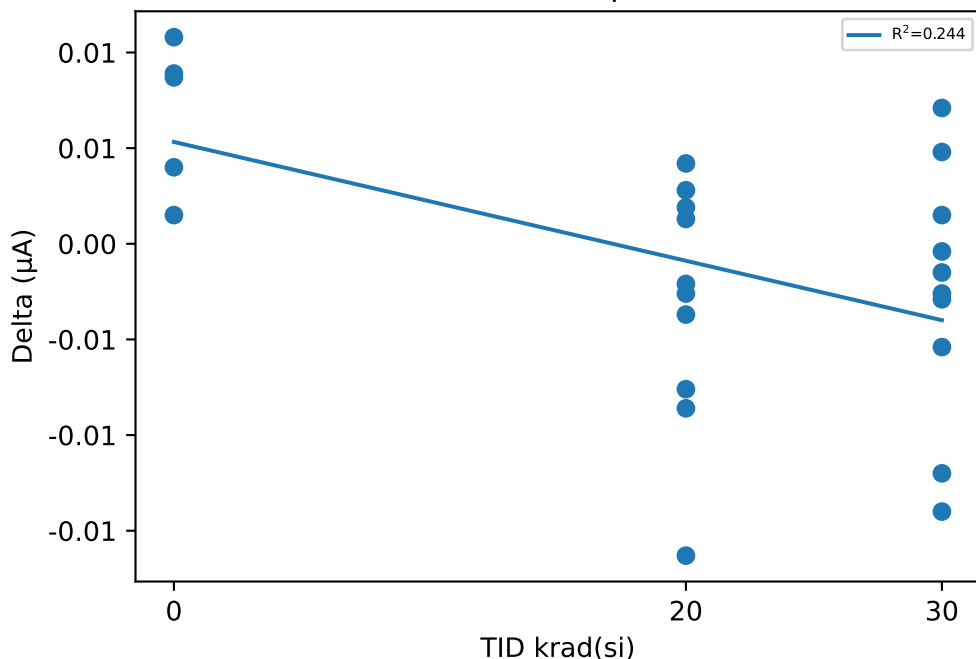

Test Results (Upper Limit = 0.5 (µA))

Serial #	krad(si)	Exposure Conditions	Pre Result	Post Result	Delta
50	20	LDR biased	-0.0061	-0.0137	-0.0076
51	20	LDR biased	-0.0105	-0.0063	0.0042
52	20	LDR biased	-0.0057	-0.0078	-0.0021
53	20	LDR biased	0.0017	-0.0069	-0.0086
54	20	LDR biased	-0.008	-0.0061	0.0019
55	30	LDR biased	-0.0125	-0.0151	-0.0026
56	30	LDR biased	0.0038	-0.0082	-0.012
57	30	LDR biased	-0.01	-0.0104	-0.0004
58	30	LDR biased	0.0014	-0.0126	-0.014
59	30	LDR biased	-0.0056	-0.011	-0.0054
60	20	LDR unbiased	0	-0.0163	-0.0163
61	20	LDR unbiased	-0.0024	-0.0061	-0.0037
62	20	LDR unbiased	-0.0112	-0.0084	0.0028
63	20	LDR unbiased	-0.0125	-0.0112	0.0013
64	20	LDR unbiased	-0.0068	-0.0094	-0.0026
65	30	LDR unbiased	-0.0083	-0.0098	-0.0015
66	30	LDR unbiased	-0.0078	-0.0063	0.0015
67	30	LDR unbiased	-0.0095	-0.0024	0.0071
68	30	LDR unbiased	-0.0063	-0.0092	-0.0029
69	30	LDR unbiased	-0.0073	-0.0025	0.0048
70	0	correlation	-0.0031	-0.0016	0.0015
71	0	correlation	-0.0083	0.0004	0.0087
72	0	correlation	-0.0124	-0.0016	0.0108
73	0	correlation	-0.0071	0.0018	0.0089
74	0	correlation	-0.0061	-0.0021	0.004

Test Statistics (µA)

krad(si)	Pre Exposure Min	Pre Exposure Avg	Pre Exposure Max	Pre Exposure Std	Post Exposure Min	Post Exposure Avg	Post Exposure Max	Post Exposure Std	Min Delta	Avg Delta	Max Delta	Std Delta
0	-0.0124	-0.0074	-0.0031	0.0033941	-0.0021	-0.00062	0.0018	0.0016589	0.0015	0.00678	0.0108	0.0038713
20	-0.0125	-0.00615	0.0017	0.0047411	-0.0163	-0.00922	-0.0061	0.0034995	-0.0163	-0.00307	0.0042	0.006314
30	-0.0125	-0.00621	0.0038	0.0050698	-0.0151	-0.00875	-0.0024	0.0040815	-0.014	-0.00254	0.0071	0.0066493

Device Test: 5.37 UJXYSN(loutleak_5V_UJXYSN)

TID vs Result Stats

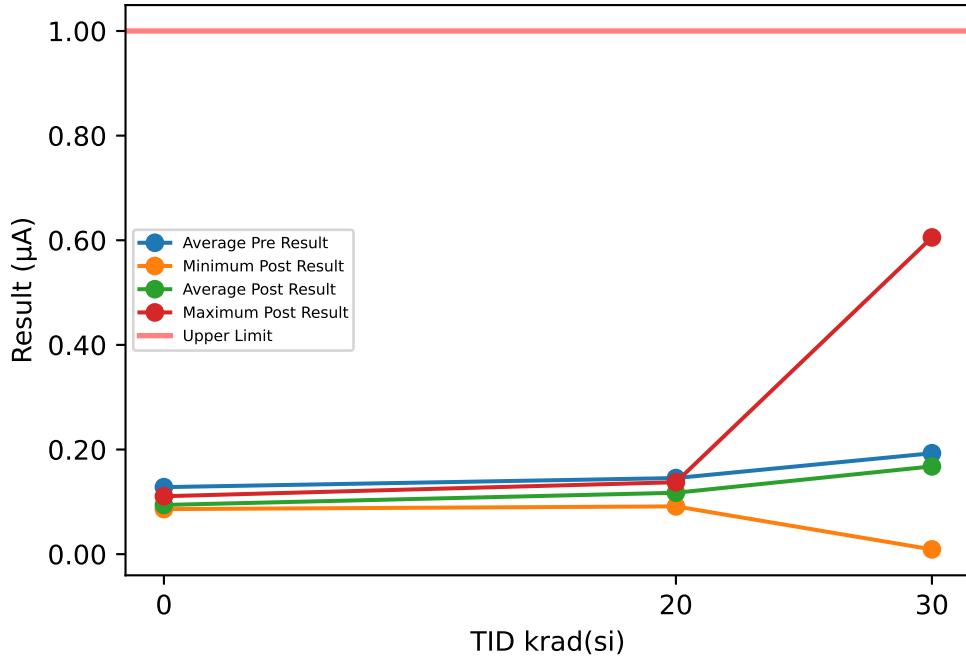

Test Results (Upper Limit = 1.0 (µA))

Serial #	krad(si)	Exposure Conditions	Pre Result	Post Result	Delta
50	20	LDR biased	0.0871	0.1232	0.0361
51	20	LDR biased	0.0618	0.0913	0.0295
52	20	LDR biased	0.1029	0.1208	0.0179
53	20	LDR biased	0.5566	0.1181	-0.4385
54	20	LDR biased	0.0765	0.127	0.0505
55	30	LDR biased	0.0605	0.0584	-0.0021
56	30	LDR biased	0.0382	0.0337	-0.0045
57	30	LDR biased	0.54	0.5722	0.0322
58	30	LDR biased	0.0634	0.0949	0.0315
59	30	LDR biased	0.0116	0.0091	-0.0025
60	20	LDR unbiased	-0.0258	0.1313	0.1571
61	20	LDR unbiased	0.5221	0.1003	-0.4218
62	20	LDR unbiased	0.0936	0.1375	0.0439
63	20	LDR unbiased	0.0034	0.1175	0.1141
64	20	LDR unbiased	-0.0235	0.1068	0.1303
65	30	LDR unbiased	0.568	0.1069	-0.4611
66	30	LDR unbiased	0.1193	0.0471	-0.0722
67	30	LDR unbiased	0.0337	0.6054	0.5717
68	30	LDR unbiased	-0.0435	0.0849	0.1284
69	30	LDR unbiased	0.5376	0.065	-0.4726
70	0	correlation	0.0608	0.0865	0.0257
71	0	correlation	-0.0119	0.0918	0.1037
72	0	correlation	-0.0052	0.0861	0.0913
73	0	correlation	0.5279	0.1107	-0.4172
74	0	correlation	0.0689	0.0951	0.0262

TID vs Post - Pre Exposure Delta

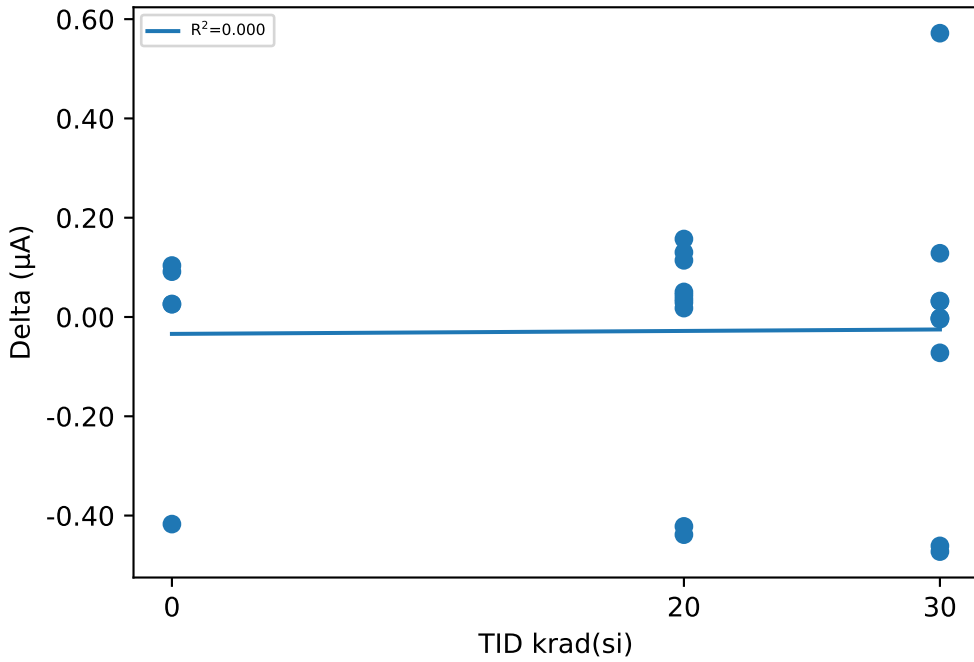

Test Statistics (µA)

krad(si)	Pre Exposure Min	Pre Exposure Avg	Pre Exposure Max	Pre Exposure Std	Post Exposure Min	Post Exposure Avg	Post Exposure Max	Post Exposure Std	Min Delta	Avg Delta	Max Delta	Std Delta
0	-0.0119	0.1281	0.5279	0.22652	0.0861	0.09404	0.1107	0.010045	-0.4172	-0.03406	0.1037	0.21719
20	-0.0258	0.14547	0.5566	0.21308	0.0913	0.11738	0.1375	0.014225	-0.4385	-0.02809	0.1571	0.21704
30	-0.0435	0.19288	0.568	0.24894	0.0091	0.16776	0.6054	0.22391	-0.4726	-0.02512	0.5717	0.29444

Device Test: 5.38 UJXYSN(loutleak_12V_UJXYSN)

TID vs Result Stats

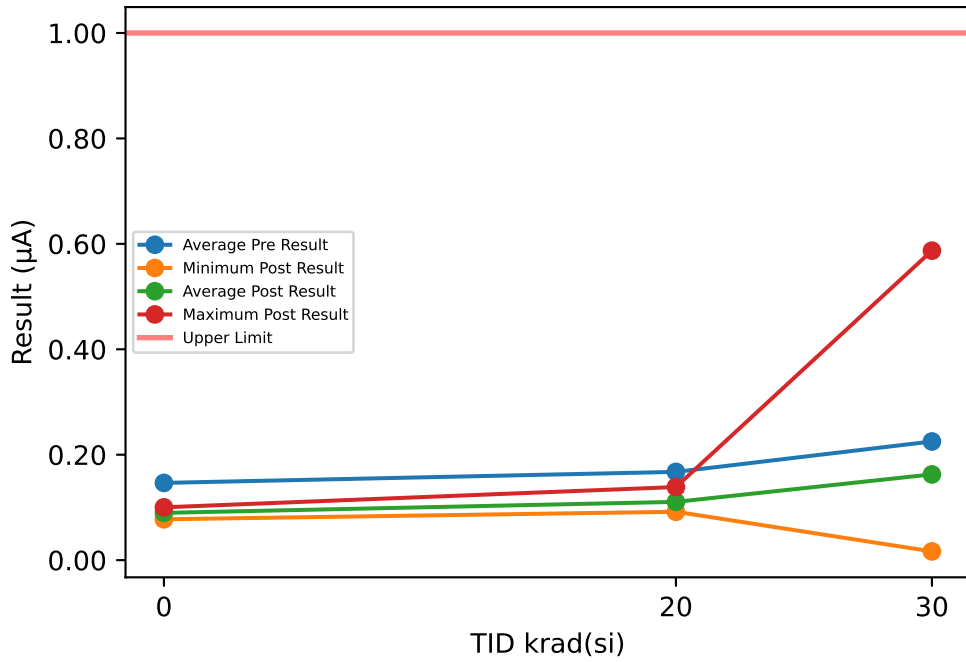

Test Results (Upper Limit = 1.0 (µA))

Serial #	krad(si)	Exposure Conditions	Pre Result	Post Result	Delta
50	20	LDR biased	0.0749	0.0936	0.0187
51	20	LDR biased	0.1576	0.1017	-0.0559
52	20	LDR biased	0.1059	0.0918	-0.0141
53	20	LDR biased	0.5486	0.1231	-0.4255
54	20	LDR biased	0.0542	0.1187	0.0645
55	30	LDR biased	0.1443	0.0461	-0.0982
56	30	LDR biased	0.0453	0.0483	0.003
57	30	LDR biased	0.5578	0.5808	0.023
58	30	LDR biased	0.062	0.0921	0.0301
59	30	LDR biased	0.1237	0.0166	-0.1071
60	20	LDR unbiased	0.0083	0.1387	0.1304
61	20	LDR unbiased	0.5455	0.0922	-0.4533
62	20	LDR unbiased	0.081	0.125	0.044
63	20	LDR unbiased	0.0887	0.11	0.0213
64	20	LDR unbiased	0.0097	0.1108	0.1011
65	30	LDR unbiased	0.5731	0.0933	-0.4798
66	30	LDR unbiased	0.1014	0.043	-0.0584
67	30	LDR unbiased	0.1206	0.5871	0.4665
68	30	LDR unbiased	-0.0229	0.058	0.0809
69	30	LDR unbiased	0.5457	0.0613	-0.4844
70	0	correlation	0.0595	0.1002	0.0407
71	0	correlation	0.0885	0.0775	-0.011
72	0	correlation	0.0034	0.09	0.0866
73	0	correlation	0.524	0.0906	-0.4334
74	0	correlation	0.0572	0.0901	0.0329

TID vs Post - Pre Exposure Delta

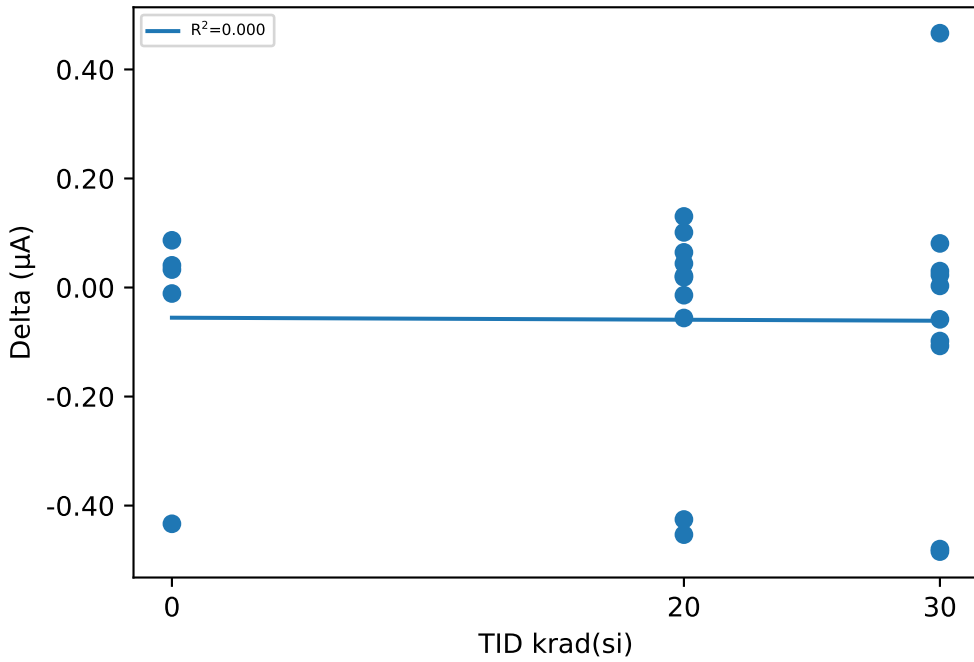

Test Statistics (µA)

krad(si)	Pre Exposure Min	Pre Exposure Avg	Pre Exposure Max	Pre Exposure Std	Post Exposure Min	Post Exposure Avg	Post Exposure Max	Post Exposure Std	Min Delta	Avg Delta	Max Delta	Std Delta
0	0.0034	0.14652	0.524	0.21324	0.0775	0.08968	0.1002	0.0080646	-0.4334	-0.05684	0.0866	0.21333
20	0.0083	0.16744	0.5486	0.20477	0.0918	0.11056	0.1387	0.015914	-0.4533	-0.05688	0.1304	0.2086
30	-0.0229	0.2251	0.5731	0.23524	0.0166	0.16266	0.5871	0.22319	-0.4844	-0.06244	0.4665	0.27406

Device Test: 5.39 UJXYSN(loutleak_28V_UJXYSN)

TID vs Result Stats

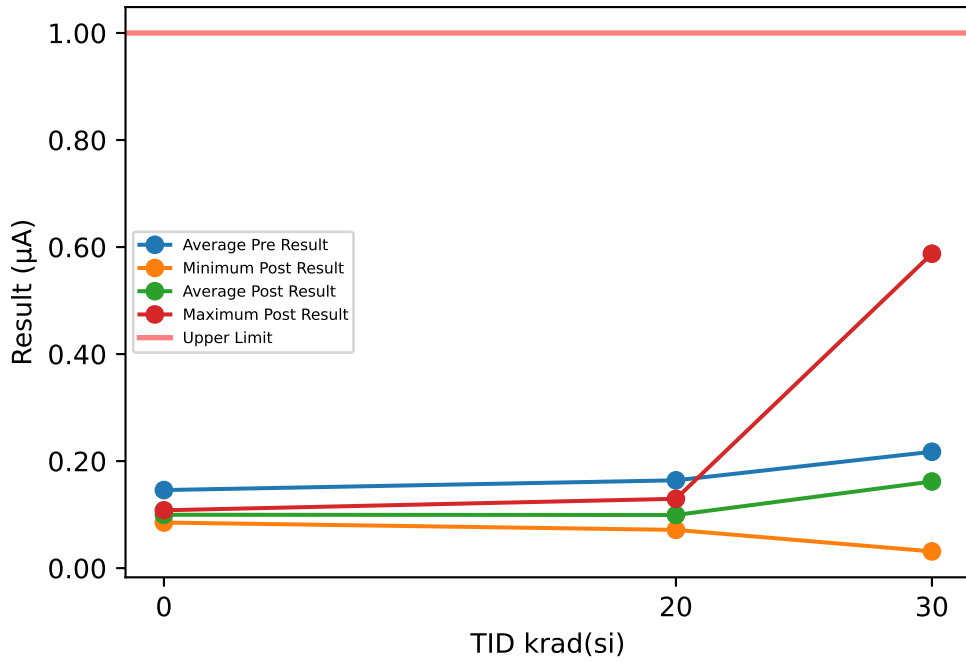

Test Results (Upper Limit = 1.0 (µA))

Serial #	krad(si)	Exposure Conditions	Pre Result	Post Result	Delta
50	20	LDR biased	0.0655	0.0972	0.0317
51	20	LDR biased	0.1587	0.0915	-0.0672
52	20	LDR biased	0.1004	0.0921	-0.0083
53	20	LDR biased	0.552	0.0912	-0.4608
54	20	LDR biased	0.0589	0.1019	0.043
55	30	LDR biased	0.139	0.05	-0.089
56	30	LDR biased	0.0288	0.0524	0.0236
57	30	LDR biased	0.5349	0.5583	0.0234
58	30	LDR biased	0.0644	0.0897	0.0253
59	30	LDR biased	0.1174	0.0313	-0.0861
60	20	LDR unbiased	-0.0046	0.1296	0.1342
61	20	LDR unbiased	0.5316	0.0715	-0.4601
62	20	LDR unbiased	0.0824	0.1255	0.0431
63	20	LDR unbiased	0.0889	0.1	0.0111
64	20	LDR unbiased	0.0075	0.093	0.0855
65	30	LDR unbiased	0.5691	0.0906	-0.4785
66	30	LDR unbiased	0.089	0.0474	-0.0416
67	30	LDR unbiased	0.109	0.5876	0.4786
68	30	LDR unbiased	-0.0204	0.0532	0.0736
69	30	LDR unbiased	0.5433	0.0582	-0.4851
70	0	correlation	0.0685	0.1009	0.0324
71	0	correlation	0.0822	0.1025	0.0203
72	0	correlation	0.0005	0.1081	0.1076
73	0	correlation	0.5182	0.102	-0.4162
74	0	correlation	0.06	0.0852	0.0252

TID vs Post - Pre Exposure Delta

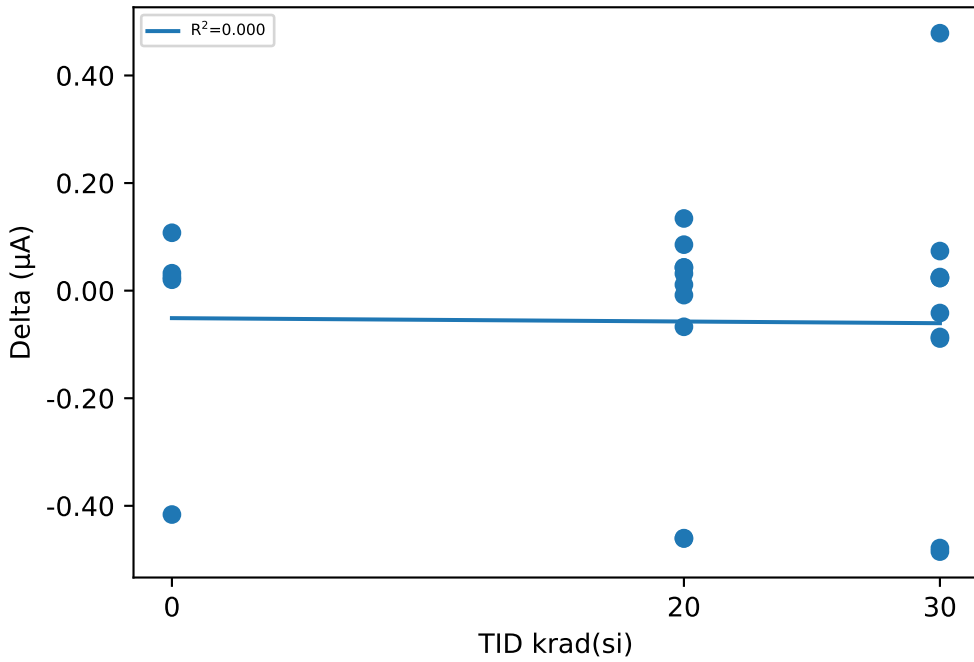

Test Statistics (µA)

krad(si)	Pre Exposure Min	Pre Exposure Avg	Pre Exposure Max	Pre Exposure Std	Post Exposure Min	Post Exposure Avg	Post Exposure Max	Post Exposure Std	Min Delta	Avg Delta	Max Delta	Std Delta
0	0.0005	0.14588	0.5182	0.21046	0.0852	0.09974	0.1081	0.0085932	-0.4162	-0.04614	0.1076	0.20991
20	-0.0046	0.16413	0.552	0.20432	0.0715	0.09935	0.1296	0.01702	-0.4608	-0.06478	0.1342	0.2152
30	-0.0204	0.21745	0.5691	0.23348	0.0313	0.16187	0.5876	0.21754	-0.4851	-0.05558	0.4786	0.27622

Device Test: 5.4 UJTKLS(Iop_32V_UJTKLS)

TID vs Result Stats

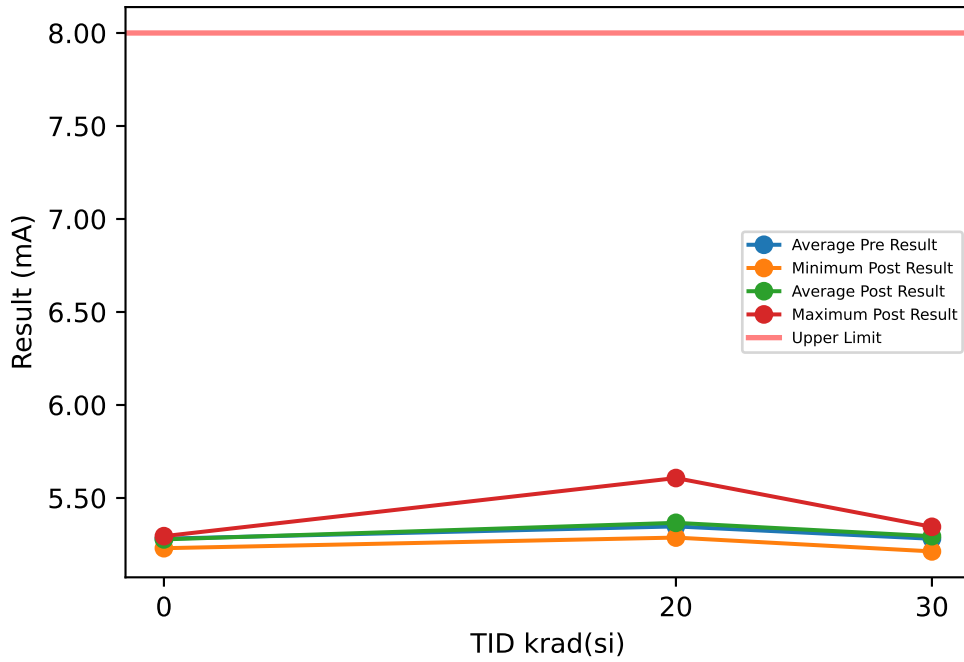

Test Results (Upper Limit = 8.0 (mA))

Serial #	krad(si)	Exposure Conditions	Pre Result	Post Result	Delta
50	20	LDR biased	5.5853	5.6073	0.022
51	20	LDR biased	5.2824	5.2946	0.0122
52	20	LDR biased	5.3029	5.3209	0.018
53	20	LDR biased	5.2687	5.2872	0.0185
54	20	LDR biased	5.3146	5.3376	0.023
55	30	LDR biased	5.3362	5.345	0.0088
56	30	LDR biased	5.1975	5.2129	0.0154
57	30	LDR biased	5.2796	5.303	0.0234
58	30	LDR biased	5.2501	5.257	0.0069
59	30	LDR biased	5.2374	5.2698	0.0324
60	20	LDR unbiased	5.3074	5.3226	0.0152
61	20	LDR unbiased	5.3297	5.3454	0.0157
62	20	LDR unbiased	5.3793	5.3893	0.01
63	20	LDR unbiased	5.3573	5.3776	0.0203
64	20	LDR unbiased	5.3446	5.3824	0.0378
65	30	LDR unbiased	5.3391	5.3446	0.0055
66	30	LDR unbiased	5.3218	5.3294	0.0076
67	30	LDR unbiased	5.2587	5.2802	0.0215
68	30	LDR unbiased	5.2648	5.2786	0.0138
69	30	LDR unbiased	5.3213	5.3269	0.0056
70	0	correlation	5.2903	5.2881	-0.0022
71	0	correlation	5.2912	5.2889	-0.0023
72	0	correlation	5.2918	5.2948	0.003
73	0	correlation	5.2422	5.2301	-0.0121
74	0	correlation	5.2909	5.285	-0.0059

TID vs Post - Pre Exposure Delta

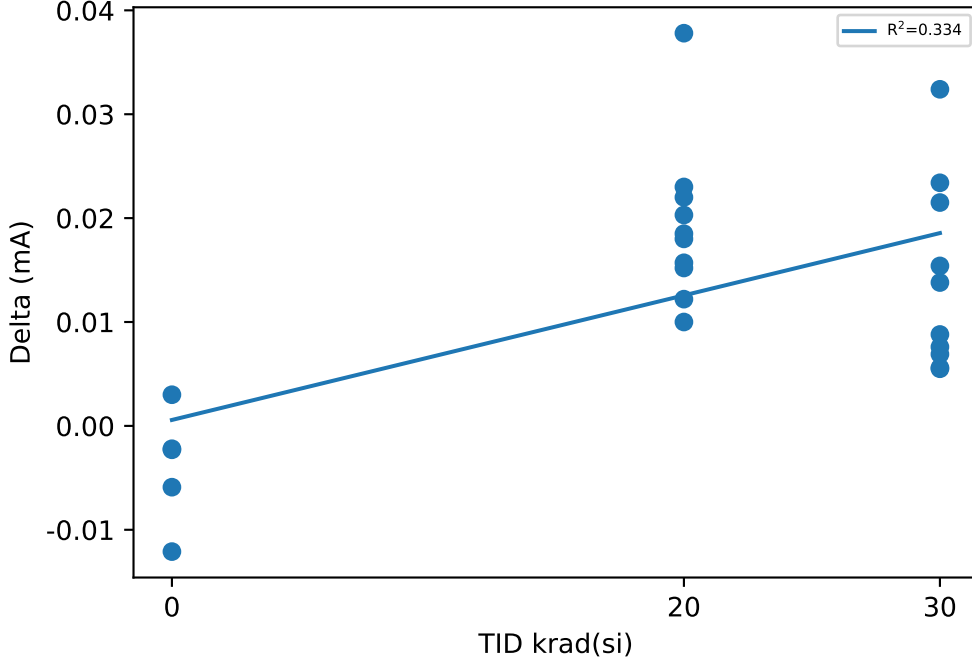

Test Statistics (mA)

krad(si)	Pre Exposure Min	Pre Exposure Avg	Pre Exposure Max	Pre Exposure Std	Post Exposure Min	Post Exposure Avg	Post Exposure Max	Post Exposure Std	Min Delta	Avg Delta	Max Delta	Std Delta
0	5.2422	5.2813	5.2918	0.021853	5.2301	5.2774	5.2948	0.026667	-0.0121	-0.0039	0.003	0.0055745
20	5.2687	5.3472	5.5853	0.090128	5.2872	5.3665	5.6073	0.091667	0.01	0.01927	0.0378	0.0076972
30	5.1975	5.2806	5.3391	0.047493	5.2129	5.2947	5.345	0.042859	0.0055	0.01409	0.0324	0.0091062

Device Test: 5.40 UJXYSN(loutleak_32V_UJXYSN)

TID vs Result Stats

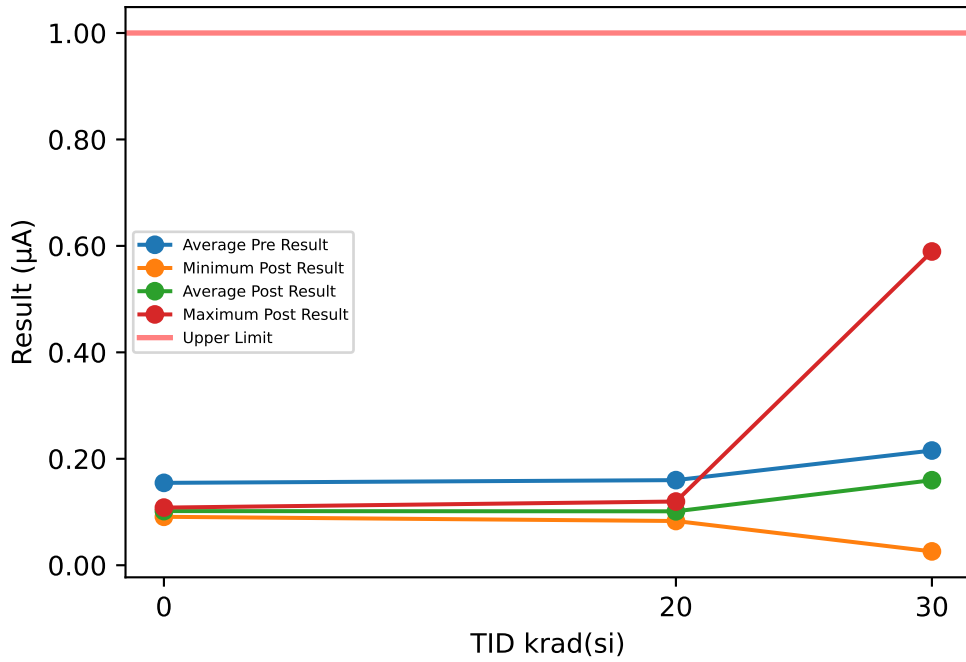

Test Results (Upper Limit = 1.0 (µA))

Serial #	krad(si)	Exposure Conditions	Pre Result	Post Result	Delta
50	20	LDR biased	0.0553	0.0904	0.0351
51	20	LDR biased	0.1448	0.0929	-0.0519
52	20	LDR biased	0.0815	0.0938	0.0123
53	20	LDR biased	0.5482	0.11	-0.4382
54	20	LDR biased	0.046	0.112	0.066
55	30	LDR biased	0.1278	0.0548	-0.073
56	30	LDR biased	0.0167	0.0503	0.0336
57	30	LDR biased	0.5502	0.5675	0.0173
58	30	LDR biased	0.066	0.0783	0.0123
59	30	LDR biased	0.0992	0.026	-0.0732
60	20	LDR unbiased	0.0061	0.1197	0.1136
61	20	LDR unbiased	0.5362	0.0905	-0.4457
62	20	LDR unbiased	0.0908	0.1153	0.0245
63	20	LDR unbiased	0.0928	0.1054	0.0126
64	20	LDR unbiased	-0.0029	0.0831	0.086
65	30	LDR unbiased	0.5667	0.0822	-0.4845
66	30	LDR unbiased	0.0948	0.0375	-0.0573
67	30	LDR unbiased	0.1128	0.5895	0.4767
68	30	LDR unbiased	-0.0222	0.0503	0.0725
69	30	LDR unbiased	0.5431	0.061	-0.4821
70	0	correlation	0.0753	0.1083	0.033
71	0	correlation	0.1011	0.0992	-0.0019
72	0	correlation	-0.0025	0.1057	0.1082
73	0	correlation	0.5367	0.1044	-0.4323
74	0	correlation	0.0633	0.091	0.0277

TID vs Post - Pre Exposure Delta

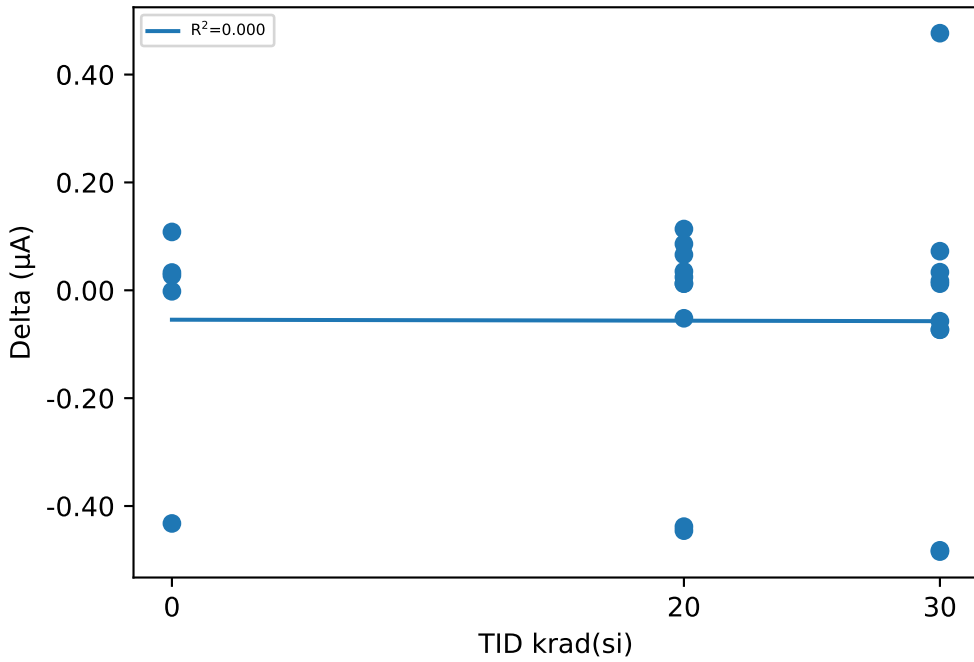

Test Statistics (µA)

krad(si)	Pre Exposure Min	Pre Exposure Avg	Pre Exposure Max	Pre Exposure Std	Post Exposure Min	Post Exposure Avg	Post Exposure Max	Post Exposure Std	Min Delta	Avg Delta	Max Delta	Std Delta
0	-0.0025	0.15478	0.5367	0.21689	0.091	0.10172	0.1083	0.0068481	-0.4323	-0.05306	0.1082	0.21586
20	-0.0029	0.15988	0.5482	0.20605	0.0831	0.10131	0.1197	0.012627	-0.4457	-0.05857	0.1136	0.20706
30	-0.0222	0.21551	0.5667	0.23744	0.026	0.15974	0.5895	0.2214	-0.4845	-0.05577	0.4767	0.2757

Device Test: 5.49 UJ4NY1(STBY_DEGLITCH_5V_UJ4NY1)

TID vs Result Stats

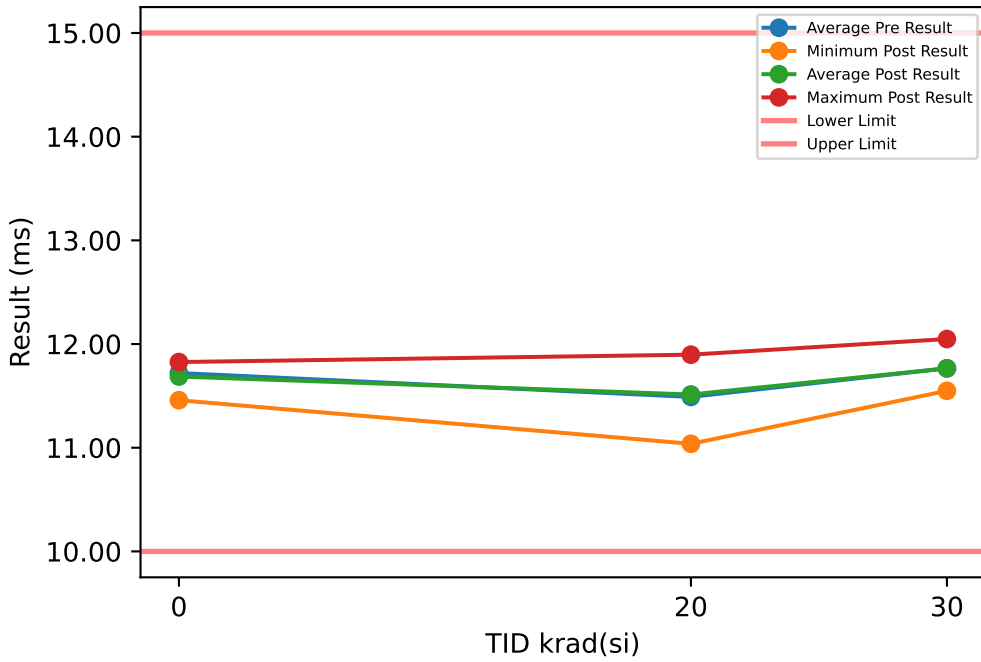

Test Results (Lower Limit = 10.0, Upper Limit = 15.0 (ms))

Serial #	krad(si)	Exposure Conditions	Pre Result	Post Result	Delta
50	20	LDR biased	11.033	11.038	0.0051
51	20	LDR biased	11.786	11.802	0.0159
52	20	LDR biased	11.662	11.743	0.0805
53	20	LDR biased	11.453	11.381	-0.0717
54	20	LDR biased	11.492	11.576	0.0848
55	30	LDR biased	11.673	11.571	-0.1014
56	30	LDR biased	11.941	11.98	0.0385
57	30	LDR biased	11.65	11.549	-0.1015
58	30	LDR biased	11.999	12.048	0.0489
59	30	LDR biased	11.752	11.629	-0.1231
60	20	LDR unbiased	11.807	11.855	0.0477
61	20	LDR unbiased	11.763	11.897	0.1341
62	20	LDR unbiased	11.302	11.233	-0.0685
63	20	LDR unbiased	11.022	11.04	0.0177
64	20	LDR unbiased	11.582	11.57	-0.0121
65	30	LDR unbiased	11.703	11.894	0.1912
66	30	LDR unbiased	11.757	11.731	-0.0259
67	30	LDR unbiased	11.634	11.85	0.2153
68	30	LDR unbiased	11.861	11.745	-0.116
69	30	LDR unbiased	11.69	11.654	-0.036
70	0	correlation	11.553	11.654	0.1003
71	0	correlation	11.799	11.739	-0.06
72	0	correlation	11.958	11.826	-0.1315
73	0	correlation	11.836	11.757	-0.0792
74	0	correlation	11.457	11.458	0.0016

TID vs Post - Pre Exposure Delta

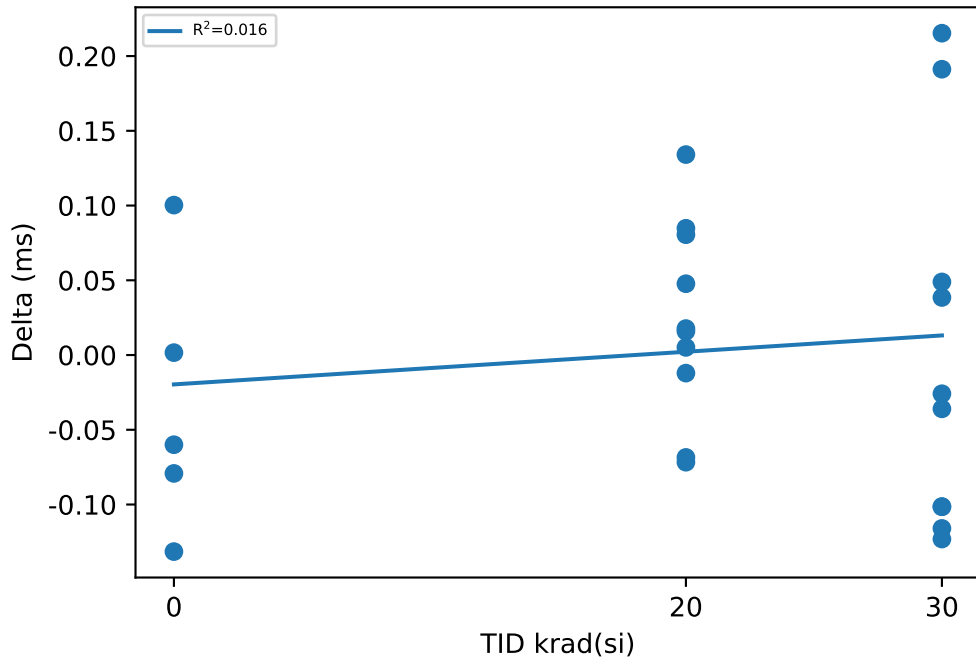

Test Statistics (ms)

krad(si)	Pre Exposure Min	Pre Exposure Avg	Pre Exposure Max	Pre Exposure Std	Post Exposure Min	Post Exposure Avg	Post Exposure Max	Post Exposure Std	Min Delta	Avg Delta	Max Delta	Std Delta
0	11.457	11.72	11.958	0.20824	11.458	11.687	11.826	0.14184	-0.1315	-0.03376	0.1003	0.088782
20	11.022	11.49	11.807	0.29168	11.038	11.513	11.897	0.32547	-0.0717	0.02335	0.1341	0.065869
30	11.634	11.766	11.999	0.12641	11.549	11.765	12.048	0.17227	-0.1231	-0.001	0.2153	0.1238

Device Test: 5.5 UJ80MB(IQ_Diag_5V_UJ80MB)

TID vs Result Stats

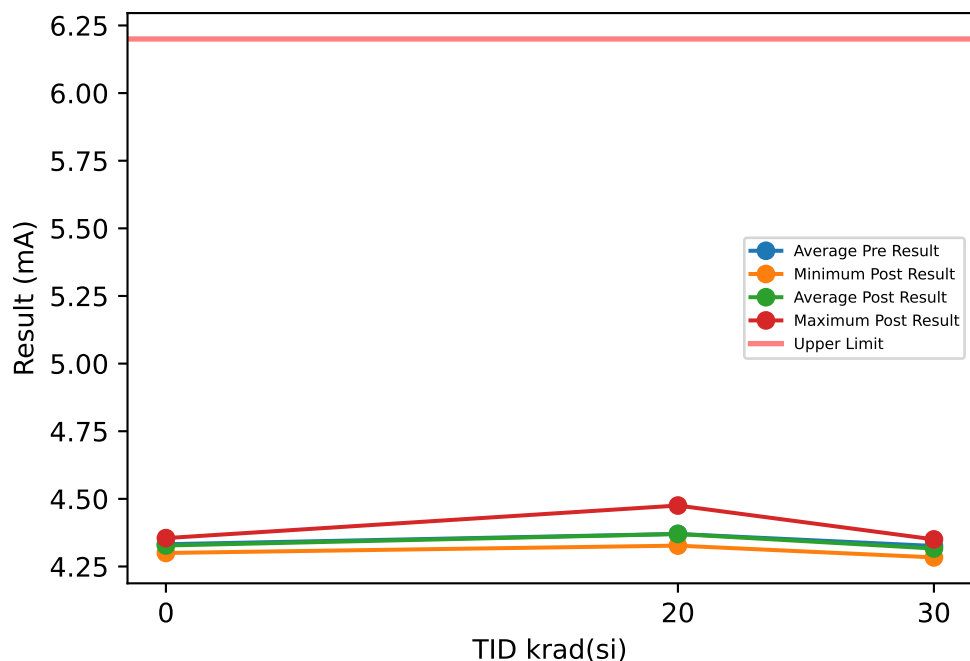

Test Results (Upper Limit = 6.2 (mA))

Serial #	krad(si)	Exposure Conditions	Pre Result	Post Result	Delta
50	20	LDR biased	4.4757	4.4753	-0.0004
51	20	LDR biased	4.3206	4.3271	0.0065
52	20	LDR biased	4.3546	4.3461	-0.0085
53	20	LDR biased	4.3583	4.3649	0.0066
54	20	LDR biased	4.3366	4.3357	-0.0009
55	30	LDR biased	4.3486	4.3502	0.0016
56	30	LDR biased	4.2883	4.2836	-0.0047
57	30	LDR biased	4.3209	4.3178	-0.0031
58	30	LDR biased	4.2957	4.2874	-0.0083
59	30	LDR biased	4.324	4.3194	-0.0046
60	20	LDR unbiased	4.3469	4.3421	-0.0048
61	20	LDR unbiased	4.3383	4.3373	-0.001
62	20	LDR unbiased	4.4081	4.4012	-0.0069
63	20	LDR unbiased	4.3927	4.3938	0.0011
64	20	LDR unbiased	4.372	4.3766	0.0046
65	30	LDR unbiased	4.3364	4.3162	-0.0202
66	30	LDR unbiased	4.3403	4.3285	-0.0118
67	30	LDR unbiased	4.3334	4.3174	-0.016
68	30	LDR unbiased	4.3086	4.2977	-0.0109
69	30	LDR unbiased	4.3627	4.3459	-0.0168
70	0	correlation	4.3587	4.3509	-0.0078
71	0	correlation	4.3283	4.3225	-0.0058
72	0	correlation	4.3033	4.3	-0.0033
73	0	correlation	4.3137	4.3092	-0.0045
74	0	correlation	4.3572	4.3549	-0.0023

TID vs Post - Pre Exposure Delta

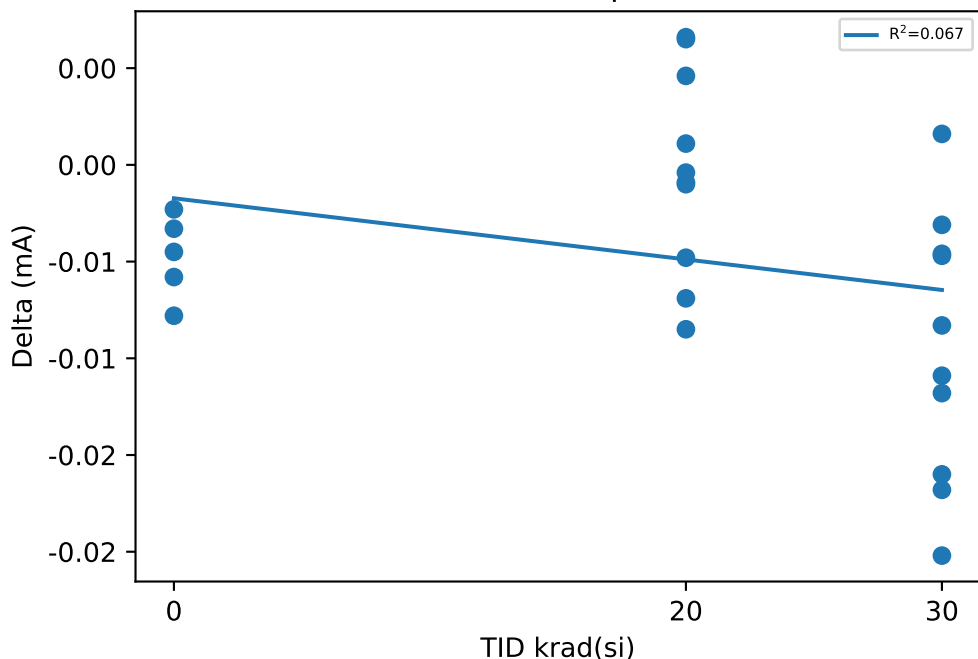

Test Statistics (mA)

krad(si)	Pre Exposure Min	Pre Exposure Avg	Pre Exposure Max	Pre Exposure Std	Post Exposure Min	Post Exposure Avg	Post Exposure Max	Post Exposure Std	Min Delta	Avg Delta	Max Delta	Std Delta
0	4.3033	4.3322	4.3587	0.025099	4.3	4.3275	4.3549	0.024569	-0.0078	-0.00474	-0.0023	0.0021548
20	4.3206	4.3704	4.4757	0.045473	4.3271	4.37	4.4753	0.044887	-0.0085	-0.00037	0.0066	0.0052882
30	4.2883	4.3259	4.3627	0.023326	4.2836	4.3164	4.3502	0.022205	-0.0202	-0.00948	0.0016	0.0069116

Device Test: 5.50 UJ4NY1(STBY_DEGLITCH_12V_UJ4NY1)

TID vs Result Stats

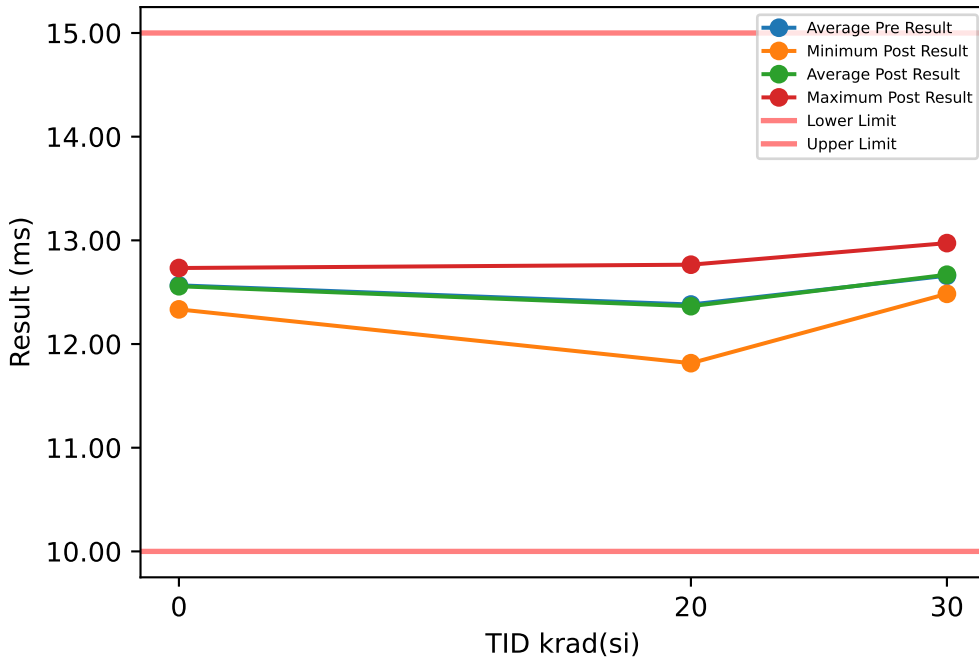

Test Results (Lower Limit = 10.0, Upper Limit = 15.0 (ms))

Serial #	krad(si)	Exposure Conditions	Pre Result	Post Result	Delta
50	20	LDR biased	11.946	11.851	-0.095
51	20	LDR biased	12.765	12.765	0.0003
52	20	LDR biased	12.42	12.597	0.1771
53	20	LDR biased	12.27	12.23	-0.0408
54	20	LDR biased	12.536	12.436	-0.0999
55	30	LDR biased	12.531	12.6	0.0684
56	30	LDR biased	12.943	12.973	0.0302
57	30	LDR biased	12.493	12.554	0.0613
58	30	LDR biased	12.892	12.83	-0.062
59	30	LDR biased	12.546	12.665	0.1185
60	20	LDR unbiased	12.704	12.588	-0.1159
61	20	LDR unbiased	12.682	12.668	-0.0137
62	20	LDR unbiased	12.045	12.186	0.1406
63	20	LDR unbiased	11.958	11.815	-0.1422
64	20	LDR unbiased	12.486	12.514	0.028
65	30	LDR unbiased	12.685	12.654	-0.0306
66	30	LDR unbiased	12.643	12.622	-0.0218
67	30	LDR unbiased	12.637	12.633	-0.0036
68	30	LDR unbiased	12.762	12.672	-0.0904
69	30	LDR unbiased	12.457	12.484	0.0267
70	0	correlation	12.534	12.385	-0.1484
71	0	correlation	12.612	12.66	0.0479
72	0	correlation	12.701	12.733	0.0324
73	0	correlation	12.634	12.674	0.0409
74	0	correlation	12.352	12.334	-0.0177

TID vs Post - Pre Exposure Delta

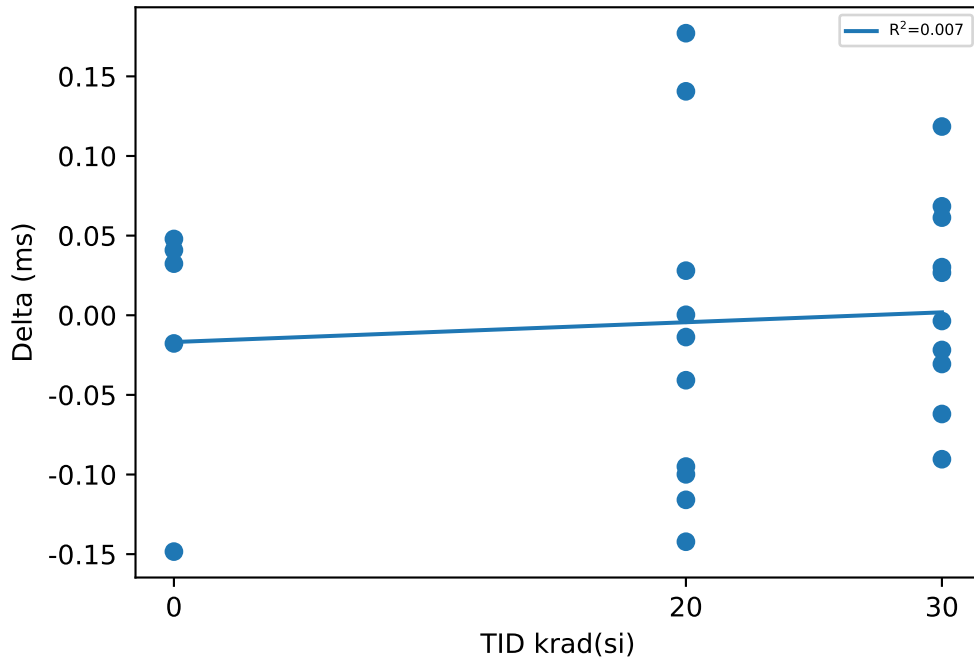

Test Statistics (ms)

krad(si)	Pre Exposure Min	Pre Exposure Avg	Pre Exposure Max	Pre Exposure Std	Post Exposure Min	Post Exposure Avg	Post Exposure Max	Post Exposure Std	Min Delta	Avg Delta	Max Delta	Std Delta
0	12.352	12.566	12.701	0.13385	12.334	12.557	12.733	0.18331	-0.1484	-0.00898	0.0479	0.082082
20	11.946	12.381	12.765	0.3112	11.815	12.365	12.765	0.33318	-0.1422	-0.01615	0.1771	0.1074
30	12.457	12.659	12.943	0.16488	12.484	12.669	12.973	0.13932	-0.0904	0.00967	0.1185	0.063778

Device Test: 5.51 UJ4NY1(STBY_DEGLITCH_28V_UJ4NY1)

TID vs Result Stats

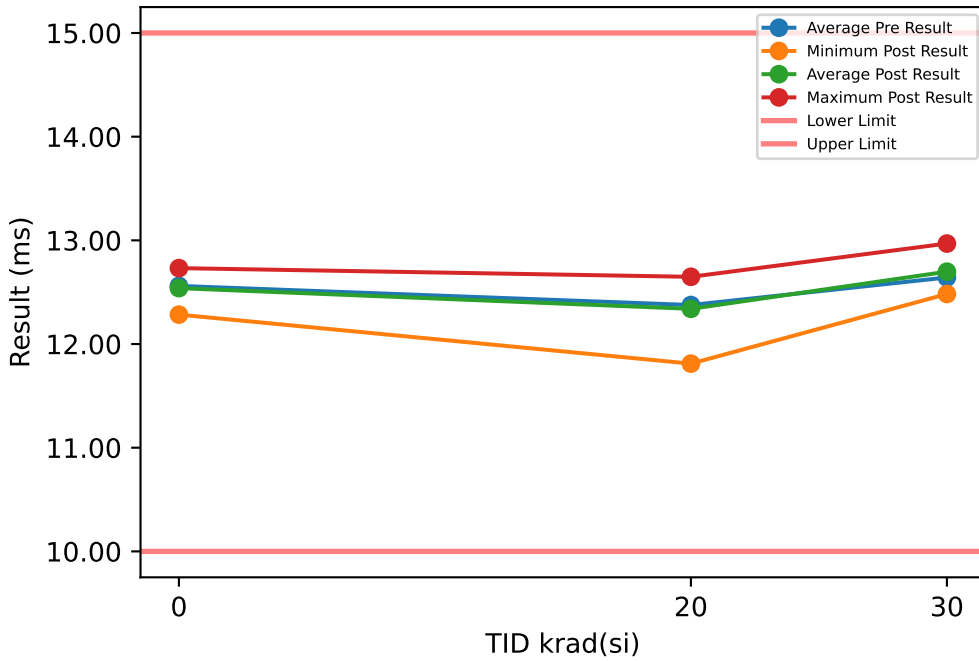

Test Results (Lower Limit = 10.0, Upper Limit = 15.0 (ms))

Serial #	krad(si)	Exposure Conditions	Pre Result	Post Result	Delta
50	20	LDR biased	11.899	11.844	-0.0556
51	20	LDR biased	12.721	12.609	-0.1122
52	20	LDR biased	12.567	12.598	0.0309
53	20	LDR biased	12.217	12.227	0.0102
54	20	LDR biased	12.527	12.431	-0.0962
55	30	LDR biased	12.527	12.586	0.0591
56	30	LDR biased	12.931	12.969	0.0381
57	30	LDR biased	12.485	12.545	0.0603
58	30	LDR biased	12.872	12.819	-0.0532
59	30	LDR biased	12.528	12.658	0.1299
60	20	LDR unbiased	12.69	12.586	-0.1042
61	20	LDR unbiased	12.664	12.648	-0.0157
62	20	LDR unbiased	12.041	12.139	0.0975
63	20	LDR unbiased	11.952	11.811	-0.1407
64	20	LDR unbiased	12.486	12.503	0.0173
65	30	LDR unbiased	12.684	12.766	0.0818
66	30	LDR unbiased	12.615	12.73	0.115
67	30	LDR unbiased	12.611	12.747	0.1363
68	30	LDR unbiased	12.736	12.676	-0.0602
69	30	LDR unbiased	12.429	12.483	0.0533
70	0	correlation	12.528	12.375	-0.1528
71	0	correlation	12.602	12.643	0.0415
72	0	correlation	12.694	12.732	0.0387
73	0	correlation	12.629	12.661	0.0327
74	0	correlation	12.352	12.284	-0.068

TID vs Post - Pre Exposure Delta

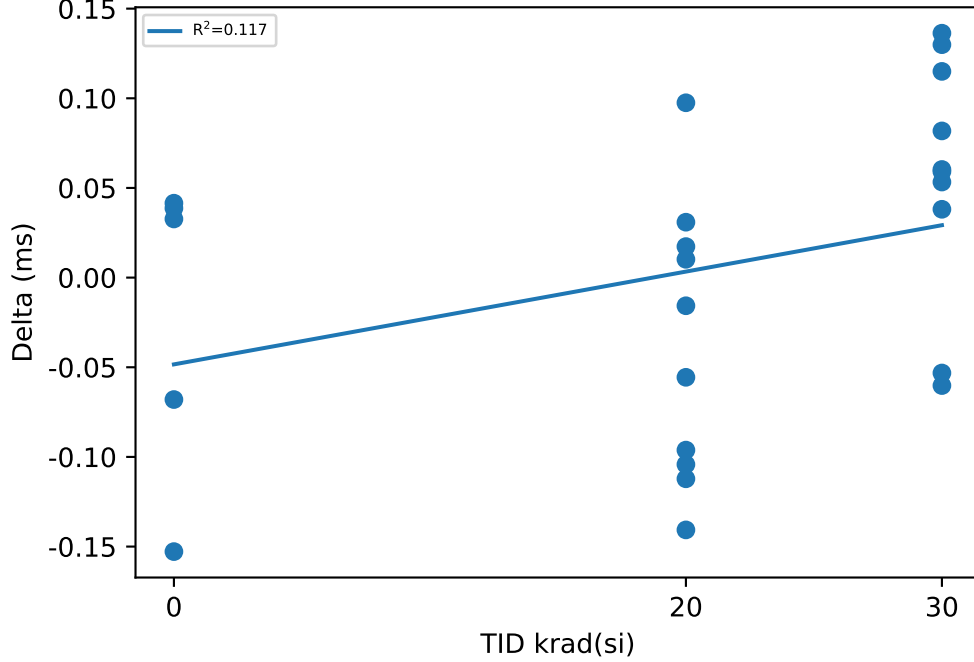

Test Statistics (ms)

krad(si)	Pre Exposure Min	Pre Exposure Avg	Pre Exposure Max	Pre Exposure Std	Post Exposure Min	Post Exposure Avg	Post Exposure Max	Post Exposure Std	Min Delta	Avg Delta	Max Delta	Std Delta
0	12.352	12.561	12.694	0.13108	12.284	12.539	12.732	0.19703	-0.1528	-0.02158	0.0415	0.086505
20	11.899	12.376	12.721	0.31913	11.811	12.34	12.648	0.31772	-0.1407	-0.03687	0.0975	0.076816
30	12.429	12.642	12.931	0.16498	12.483	12.698	12.969	0.14165	-0.0602	0.05604	0.1363	0.068182

Device Test: 5.52 UJ4NY1(STBY_DEGLITCH_32V_UJ4NY1)

TID vs Result Stats

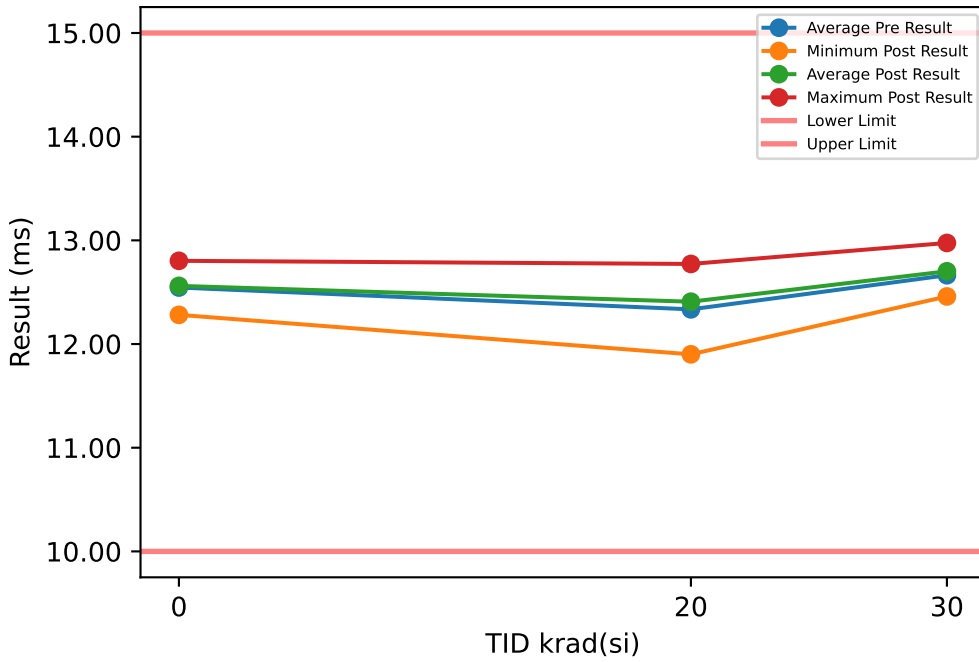

Test Results (Lower Limit = 10.0, Upper Limit = 15.0 (ms))

Serial #	krad(si)	Exposure Conditions	Pre Result	Post Result	Delta
50	20	LDR biased	11.869	11.913	0.0435
51	20	LDR biased	12.602	12.773	0.1702
52	20	LDR biased	12.438	12.639	0.2007
53	20	LDR biased	12.221	12.309	0.0882
54	20	LDR biased	12.479	12.559	0.0798
55	30	LDR biased	12.59	12.635	0.0447
56	30	LDR biased	12.976	12.975	-0.0016
57	30	LDR biased	12.504	12.553	0.0496
58	30	LDR biased	12.834	12.91	0.0753
59	30	LDR biased	12.64	12.693	0.0534
60	20	LDR unbiased	12.545	12.727	0.1822
61	20	LDR unbiased	12.646	12.63	-0.016
62	20	LDR unbiased	12.017	12.131	0.1141
63	20	LDR unbiased	11.919	11.901	-0.0184
64	20	LDR unbiased	12.609	12.502	-0.1066
65	30	LDR unbiased	12.72	12.774	0.0546
66	30	LDR unbiased	12.607	12.718	0.1112
67	30	LDR unbiased	12.554	12.703	0.149
68	30	LDR unbiased	12.764	12.596	-0.1683
69	30	LDR unbiased	12.445	12.459	0.0142
70	0	correlation	12.489	12.4	-0.0891
71	0	correlation	12.507	12.528	0.0215
72	0	correlation	12.786	12.793	0.007
73	0	correlation	12.664	12.803	0.1388
74	0	correlation	12.28	12.282	0.0016

TID vs Post - Pre Exposure Delta

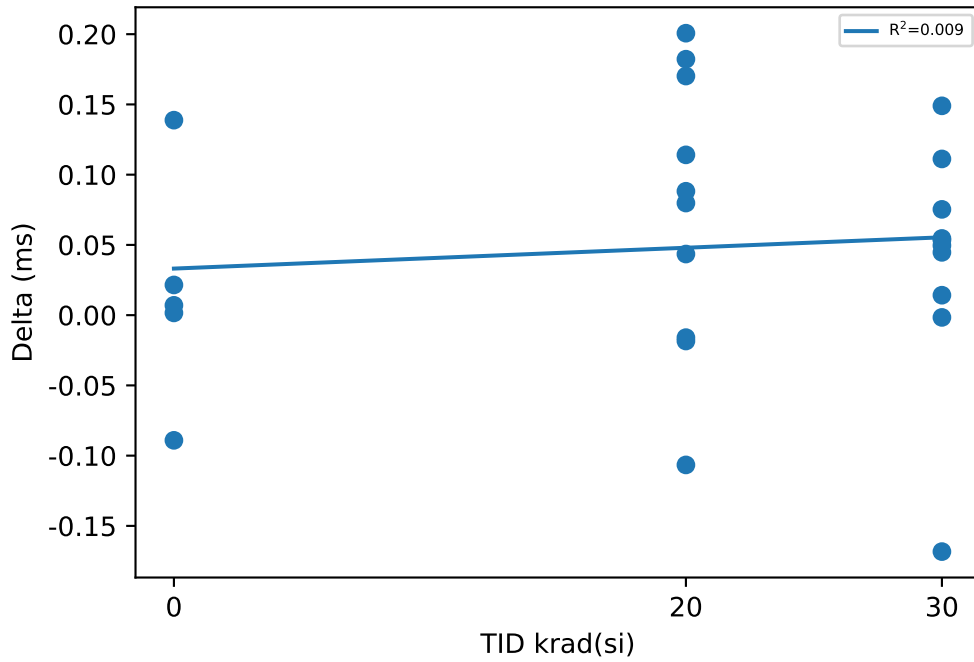

Test Statistics (ms)

krad(si)	Pre Exposure Min	Pre Exposure Avg	Pre Exposure Max	Pre Exposure Std	Post Exposure Min	Post Exposure Avg	Post Exposure Max	Post Exposure Std	Min Delta	Avg Delta	Max Delta	Std Delta
0	12.28	12.545	12.786	0.19185	12.282	12.561	12.803	0.23318	-0.0891	0.01596	0.1388	0.081309
20	11.869	12.335	12.646	0.30231	11.901	12.408	12.773	0.32623	-0.1066	0.07377	0.2007	0.099466
30	12.445	12.663	12.976	0.16157	12.459	12.702	12.975	0.15636	-0.1683	0.03821	0.149	0.084628

Device Test: 5.6 UJ8OMB(IQ_Diag_12V_UJ8OMB)

TID vs Result Stats

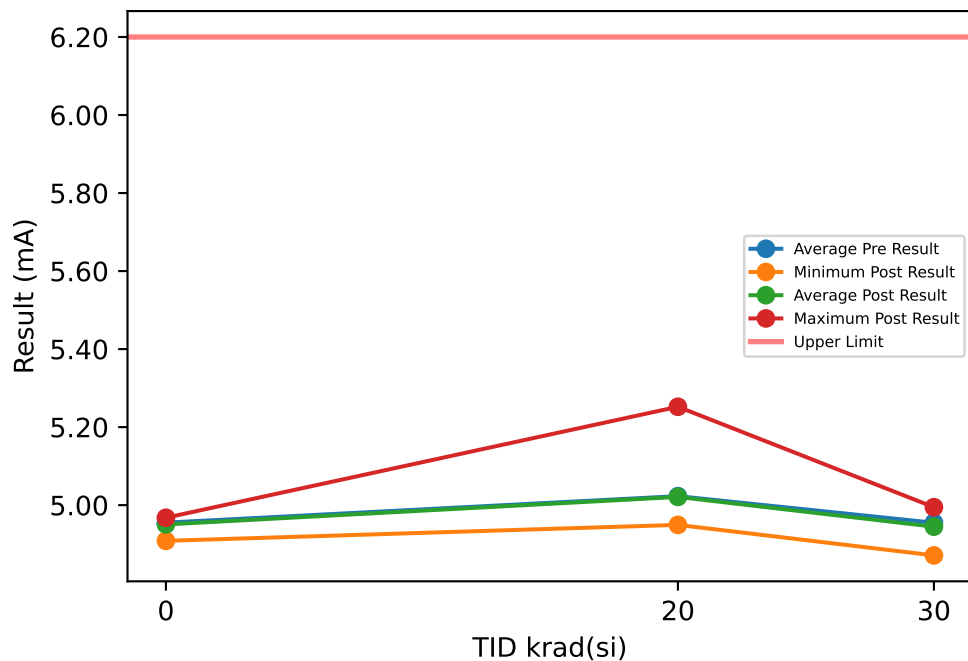

TID vs Post - Pre Exposure Delta

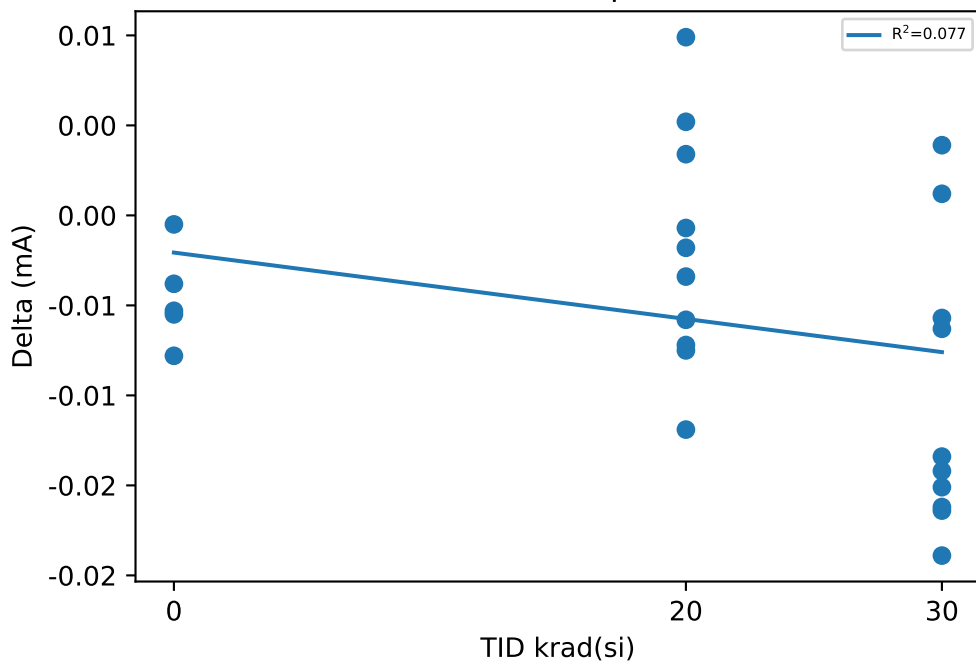

Test Results (Upper Limit = 6.2 (mA))

Serial #	krad(si)	Exposure Conditions	Pre Result	Post Result	Delta
50	20	LDR biased	5.2556	5.2522	-0.0034
51	20	LDR biased	4.9668	4.961	-0.0058
52	20	LDR biased	4.9881	4.9806	-0.0075
53	20	LDR biased	4.946	4.9494	0.0034
54	20	LDR biased	4.9867	4.9919	0.0052
55	30	LDR biased	5.009	4.9948	-0.0142
56	30	LDR biased	4.8775	4.8712	-0.0063
57	30	LDR biased	4.9538	4.955	0.0012
58	30	LDR biased	4.9173	4.9039	-0.0134
59	30	LDR biased	4.919	4.9229	0.0039
60	20	LDR unbiased	4.9842	4.9723	-0.0119
61	20	LDR unbiased	5.0008	4.999	-0.0018
62	20	LDR unbiased	5.0525	5.0453	-0.0072
63	20	LDR unbiased	5.0309	5.0302	-0.0007
64	20	LDR unbiased	5.019	5.0289	0.0099
65	30	LDR unbiased	5.0098	4.9909	-0.0189
66	30	LDR unbiased	4.9913	4.9749	-0.0164
67	30	LDR unbiased	4.9328	4.9271	-0.0057
68	30	LDR unbiased	4.9462	4.93	-0.0162
69	30	LDR unbiased	4.9928	4.9777	-0.0151
70	0	correlation	4.9604	4.9549	-0.0055
71	0	correlation	4.973	4.9677	-0.0053
72	0	correlation	4.9646	4.9641	-0.0005
73	0	correlation	4.9163	4.9085	-0.0078
74	0	correlation	4.9615	4.9577	-0.0038

Test Statistics (mA)

krad(si)	Pre Exposure Min	Pre Exposure Avg	Pre Exposure Max	Pre Exposure Std	Post Exposure Min	Post Exposure Avg	Post Exposure Max	Post Exposure Std	Min Delta	Avg Delta	Max Delta	Std Delta
0	4.9163	4.9552	4.973	0.022277	4.9085	4.9506	4.9677	0.024062	-0.0078	-0.00458	-0.0005	0.002692
20	4.946	5.0231	5.2556	0.087352	4.9494	5.0211	5.2522	0.087084	-0.0119	-0.00198	0.0099	0.0066336
30	4.8775	4.955	5.0098	0.044673	4.8712	4.9448	4.9948	0.040578	-0.0189	-0.01011	0.0039	0.0079199

Device Test: 5.7 UJ8OMB(IQ_Diag_28V_UJ8OMB)

TID vs Result Stats

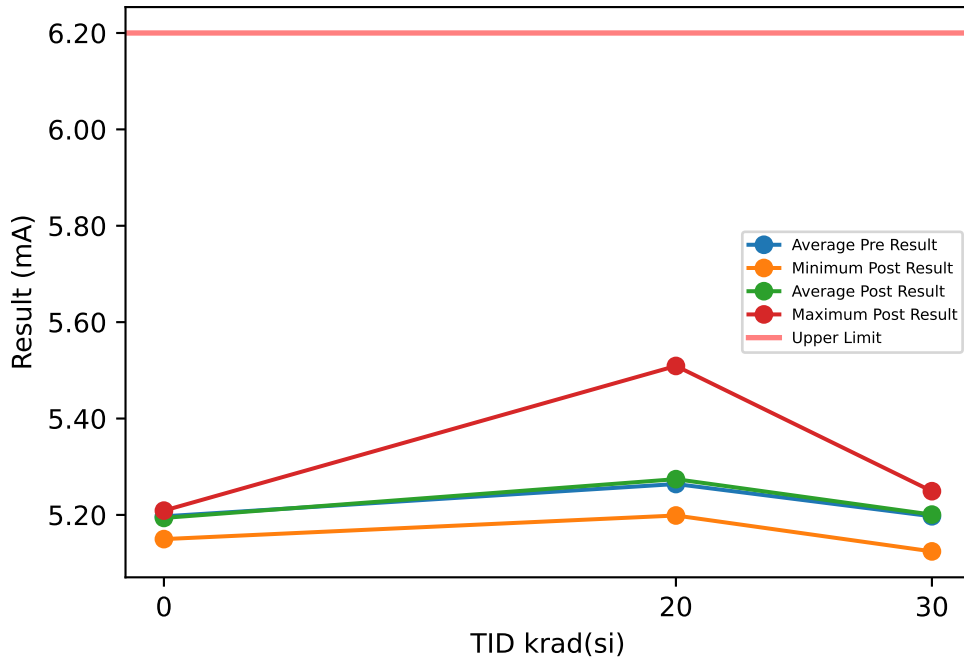

Test Results (Upper Limit = 6.2 (mA))

Serial #	krad(si)	Exposure Conditions	Pre Result	Post Result	Delta
50	20	LDR biased	5.5006	5.5091	0.0085
51	20	LDR biased	5.203	5.2055	0.0025
52	20	LDR biased	5.2254	5.2291	0.0037
53	20	LDR biased	5.1834	5.1988	0.0154
54	20	LDR biased	5.23	5.2468	0.0168
55	30	LDR biased	5.2533	5.2478	-0.0055
56	30	LDR biased	5.1171	5.1243	0.0072
57	30	LDR biased	5.1943	5.2089	0.0146
58	30	LDR biased	5.1615	5.159	-0.0025
59	30	LDR biased	5.1568	5.1749	0.0181
60	20	LDR unbiased	5.2267	5.2293	0.0026
61	20	LDR unbiased	5.2435	5.2539	0.0104
62	20	LDR unbiased	5.2926	5.2978	0.0052
63	20	LDR unbiased	5.2731	5.2849	0.0118
64	20	LDR unbiased	5.2628	5.2868	0.024
65	30	LDR unbiased	5.2542	5.2492	-0.005
66	30	LDR unbiased	5.2375	5.2366	-0.0009
67	30	LDR unbiased	5.1748	5.1841	0.0093
68	30	LDR unbiased	5.1864	5.1853	-0.0011
69	30	LDR unbiased	5.2355	5.2365	0.001
70	0	correlation	5.2039	5.1995	-0.0044
71	0	correlation	5.2125	5.2069	-0.0056
72	0	correlation	5.2093	5.2089	-0.0004
73	0	correlation	5.1563	5.1498	-0.0065
74	0	correlation	5.2033	5.2037	0.0004

TID vs Post - Pre Exposure Delta

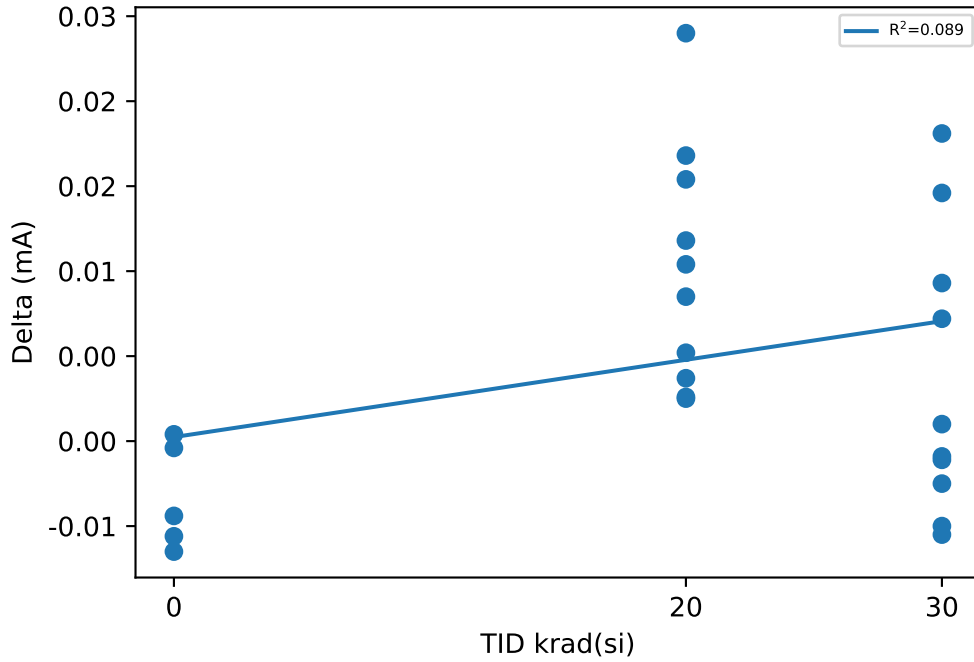

Test Statistics (mA)

krad(si)	Pre Exposure Min	Pre Exposure Avg	Pre Exposure Max	Pre Exposure Std	Post Exposure Min	Post Exposure Avg	Post Exposure Max	Post Exposure Std	Min Delta	Avg Delta	Max Delta	Std Delta
0	5.1563	5.1971	5.2125	0.023105	5.1498	5.1938	5.2089	0.02483	-0.0065	-0.0033	0.0004	0.0031161
20	5.1834	5.2641	5.5006	0.089167	5.1988	5.2742	5.5091	0.08921	0.0025	0.01009	0.024	0.0070766
30	5.1171	5.1971	5.2542	0.046472	5.1243	5.2007	5.2492	0.042114	-0.0055	0.00352	0.0181	0.008298

Device Test: 5.8 UJ8OMB(IQ_Diag_32V_UJ8OMB)

TID vs Result Stats

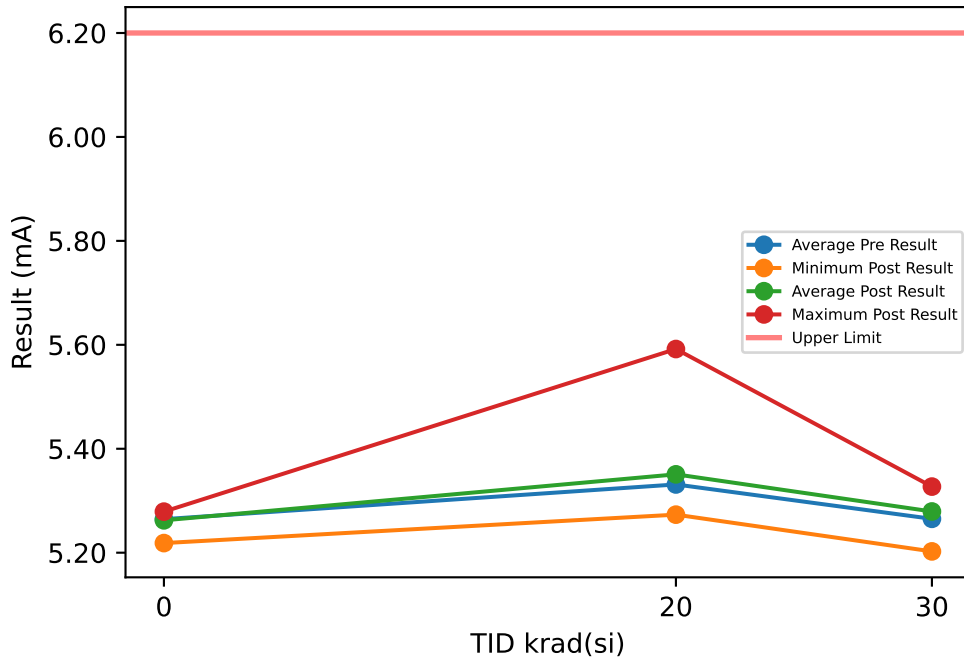

Test Results (Upper Limit = 6.2 (mA))

Serial #	krad(si)	Exposure Conditions	Pre Result	Post Result	Delta
50	20	LDR biased	5.5711	5.5919	0.0208
51	20	LDR biased	5.2664	5.279	0.0126
52	20	LDR biased	5.2905	5.3036	0.0131
53	20	LDR biased	5.2491	5.2732	0.0241
54	20	LDR biased	5.2966	5.3269	0.0303
55	30	LDR biased	5.3221	5.3272	0.0051
56	30	LDR biased	5.187	5.2025	0.0155
57	30	LDR biased	5.2633	5.2874	0.0241
58	30	LDR biased	5.229	5.2398	0.0108
59	30	LDR biased	5.2223	5.2534	0.0311
60	20	LDR unbiased	5.2959	5.3063	0.0104
61	20	LDR unbiased	5.3091	5.3265	0.0174
62	20	LDR unbiased	5.3588	5.3734	0.0146
63	20	LDR unbiased	5.343	5.3605	0.0175
64	20	LDR unbiased	5.3325	5.3664	0.0339
65	30	LDR unbiased	5.3218	5.3258	0.004
66	30	LDR unbiased	5.3052	5.3194	0.0142
67	30	LDR unbiased	5.2435	5.2638	0.0203
68	30	LDR unbiased	5.2539	5.2601	0.0062
69	30	LDR unbiased	5.3037	5.3137	0.01
70	0	correlation	5.2747	5.2702	-0.0045
71	0	correlation	5.2773	5.2721	-0.0052
72	0	correlation	5.2794	5.279	-0.0004
73	0	correlation	5.2198	5.2185	-0.0013
74	0	correlation	5.2715	5.2716	0.0001

TID vs Post - Pre Exposure Delta

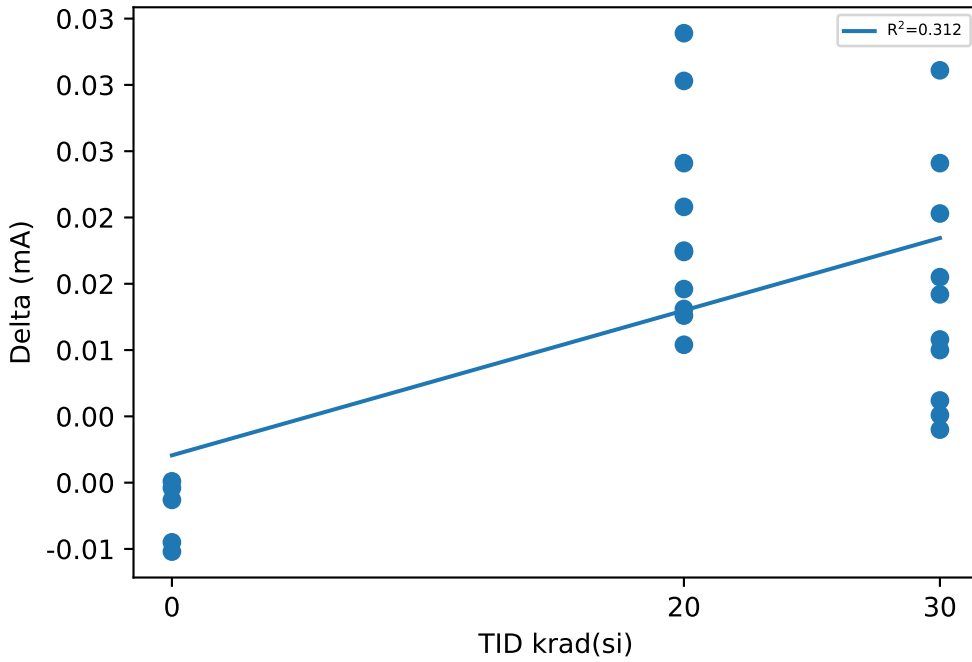

Test Statistics (mA)

krad(si)	Pre Exposure Min	Pre Exposure Avg	Pre Exposure Max	Pre Exposure Std	Post Exposure Min	Post Exposure Avg	Post Exposure Max	Post Exposure Std	Min Delta	Avg Delta	Max Delta	Std Delta
0	5.2198	5.2645	5.2794	0.025184	5.2185	5.2623	5.279	0.02471	-0.0052	-0.00226	0.0001	0.0024296
20	5.2491	5.3313	5.5711	0.090666	5.2732	5.3508	5.5919	0.091606	0.0104	0.01947	0.0339	0.0078219
30	5.187	5.2652	5.3221	0.046418	5.2025	5.2793	5.3272	0.042232	0.004	0.01413	0.0311	0.008835

Device Test: 5.9 UJKFAE(IQ_5V_UJKFAE)

TID vs Result Stats

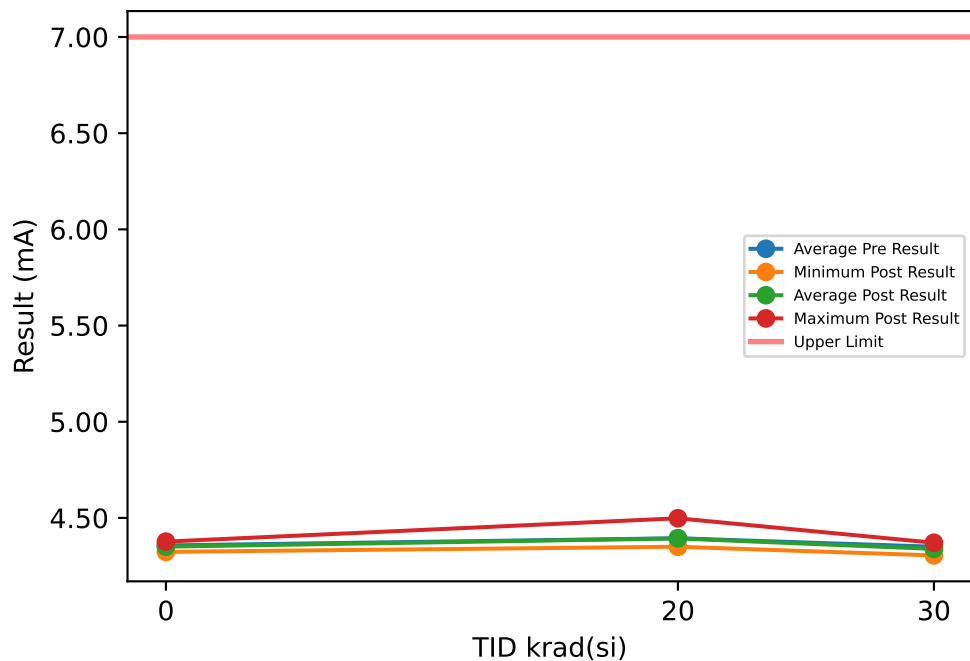

Test Results (Upper Limit = 7.0 (mA))

Serial #	krad(si)	Exposure Conditions	Pre Result	Post Result	Delta
50	20	LDR biased	4.498	4.4982	0.0002
51	20	LDR biased	4.345	4.3503	0.0053
52	20	LDR biased	4.3783	4.3696	-0.0087
53	20	LDR biased	4.3811	4.3882	0.0071
54	20	LDR biased	4.3611	4.3592	-0.0019
55	30	LDR biased	4.3741	4.3697	-0.0044
56	30	LDR biased	4.3122	4.3053	-0.0069
57	30	LDR biased	4.3462	4.3393	-0.0069
58	30	LDR biased	4.3196	4.3098	-0.0098
59	30	LDR biased	4.3474	4.3409	-0.0065
60	20	LDR unbiased	4.3714	4.3655	-0.0059
61	20	LDR unbiased	4.3624	4.3617	-0.0007
62	20	LDR unbiased	4.4336	4.4253	-0.0083
63	20	LDR unbiased	4.4169	4.4163	-0.0006
64	20	LDR unbiased	4.3974	4.4001	0.0027
65	30	LDR unbiased	4.3618	4.3377	-0.0241
66	30	LDR unbiased	4.3633	4.3511	-0.0122
67	30	LDR unbiased	4.3577	4.3424	-0.0153
68	30	LDR unbiased	4.3335	4.322	-0.0115
69	30	LDR unbiased	4.3875	4.371	-0.0165
70	0	correlation	4.3843	4.376	-0.0083
71	0	correlation	4.3537	4.3457	-0.008
72	0	correlation	4.3285	4.3238	-0.0047
73	0	correlation	4.3379	4.3312	-0.0067
74	0	correlation	4.3808	4.3769	-0.0039

TID vs Post - Pre Exposure Delta

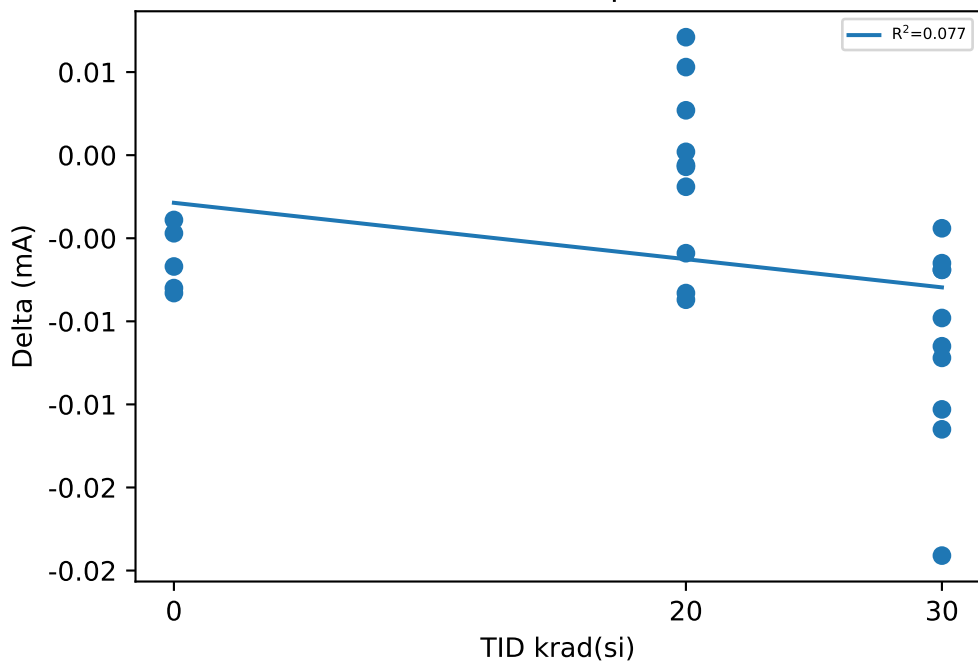

Test Statistics (mA)

krad(si)	Pre Exposure Min	Pre Exposure Avg	Pre Exposure Max	Pre Exposure Std	Post Exposure Min	Post Exposure Avg	Post Exposure Max	Post Exposure Std	Min Delta	Avg Delta	Max Delta	Std Delta
0	4.3285	4.357	4.3843	0.024998	4.3238	4.3507	4.3769	0.024776	-0.0083	-0.00632	-0.0039	0.0019601
20	4.345	4.3945	4.498	0.045121	4.3503	4.3934	4.4982	0.044689	-0.0087	-0.00108	0.0071	0.0053543
30	4.3122	4.3503	4.3875	0.023589	4.3053	4.3389	4.371	0.022129	-0.0241	-0.01141	-0.0044	0.0059557

Device Test: 6.1 UJCS56(UVLOR_UJCS56)

TID vs Result Stats

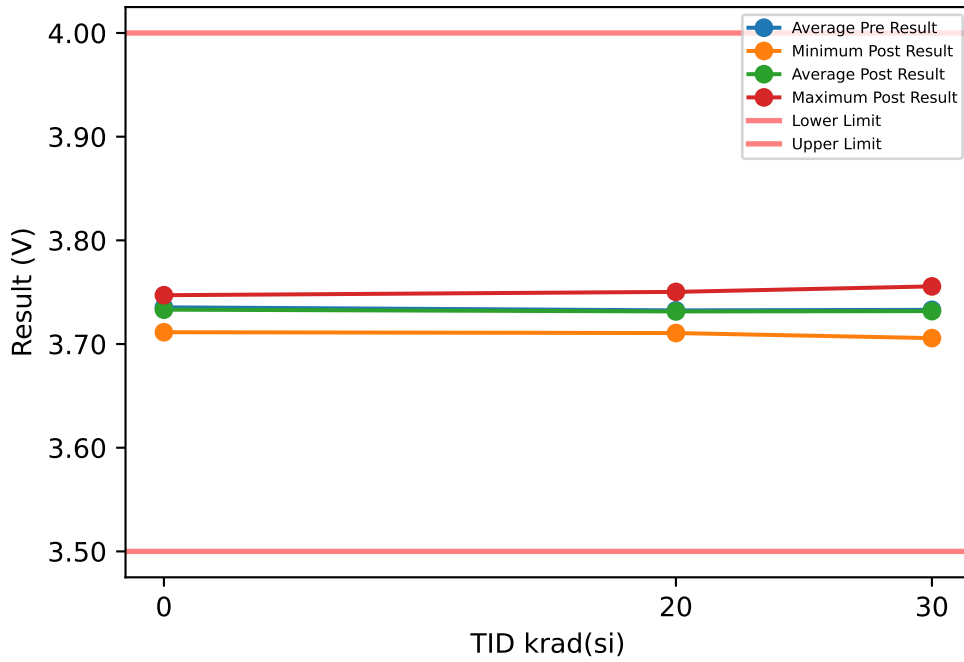

Test Results (Lower Limit = 3.5, Upper Limit = 4.0 (V))

Serial #	krad(si)	Exposure Conditions	Pre Result	Post Result	Delta
50	20	LDR biased	3.7234	3.7447	0.0213
51	20	LDR biased	3.7284	3.7347	0.0063
52	20	LDR biased	3.7284	3.7406	0.0122
53	20	LDR biased	3.723	3.7182	-0.0048
54	20	LDR biased	3.7177	3.729	0.0113
55	30	LDR biased	3.7609	3.7556	-0.0053
56	30	LDR biased	3.7249	3.7441	0.0192
57	30	LDR biased	3.7524	3.7541	0.0017
58	30	LDR biased	3.7294	3.7233	-0.0061
59	30	LDR biased	3.7377	3.7526	0.0149
60	20	LDR unbiased	3.7624	3.7373	-0.0251
61	20	LDR unbiased	3.7335	3.7503	0.0168
62	20	LDR unbiased	3.7294	3.7106	-0.0188
63	20	LDR unbiased	3.7215	3.712	-0.0095
64	20	LDR unbiased	3.757	3.7369	-0.0201
65	30	LDR unbiased	3.7261	3.7192	-0.0069
66	30	LDR unbiased	3.7341	3.7323	-0.0018
67	30	LDR unbiased	3.7322	3.7116	-0.0206
68	30	LDR unbiased	3.7108	3.7057	-0.0051
69	30	LDR unbiased	3.7213	3.719	-0.0023
70	0	correlation	3.7258	3.7171	-0.0087
71	0	correlation	3.7394	3.7471	0.0077
72	0	correlation	3.7513	3.7456	-0.0057
73	0	correlation	3.7435	3.7446	0.0011
74	0	correlation	3.7171	3.7114	-0.0057

TID vs Post - Pre Exposure Delta

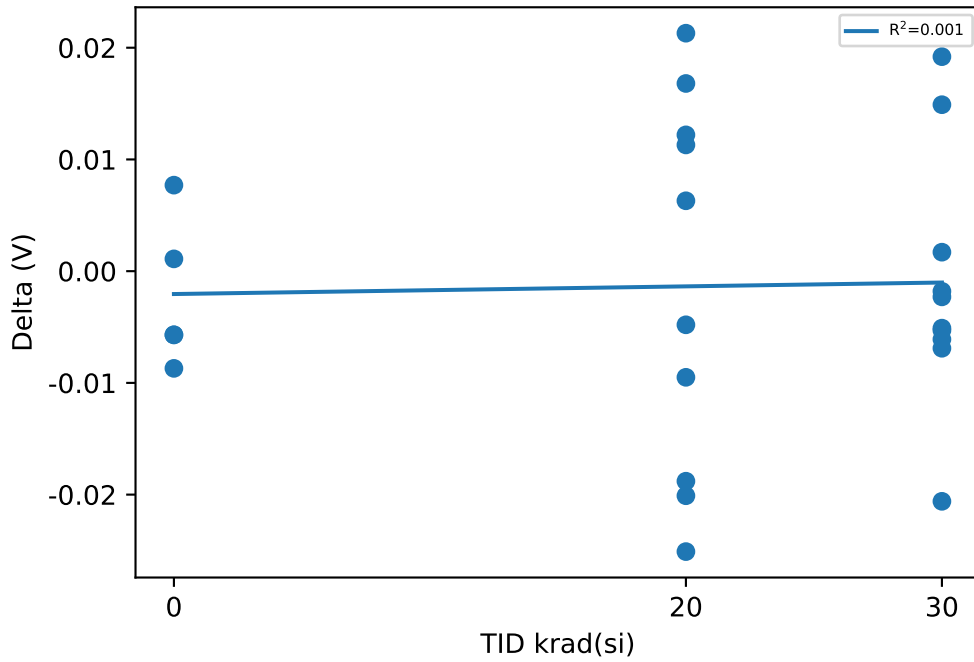

Test Statistics (V)

krad(si)	Pre Exposure Min	Pre Exposure Avg	Pre Exposure Max	Pre Exposure Std	Post Exposure Min	Post Exposure Avg	Post Exposure Max	Post Exposure Std	Min Delta	Avg Delta	Max Delta	Std Delta
0	3.7171	3.7354	3.7513	0.013797	3.7114	3.7332	3.7471	0.017402	-0.0087	-0.00226	0.0077	0.0066263
20	3.7177	3.7325	3.7624	0.015098	3.7106	3.7314	3.7503	0.013678	-0.0251	-0.00104	0.0213	0.016806
30	3.7108	3.733	3.7609	0.014661	3.7057	3.7318	3.7556	0.018655	-0.0206	-0.00123	0.0192	0.011305

Device Test: 6.2 UJE7RD(UVLOF_UJE7RD)

TID vs Result Stats

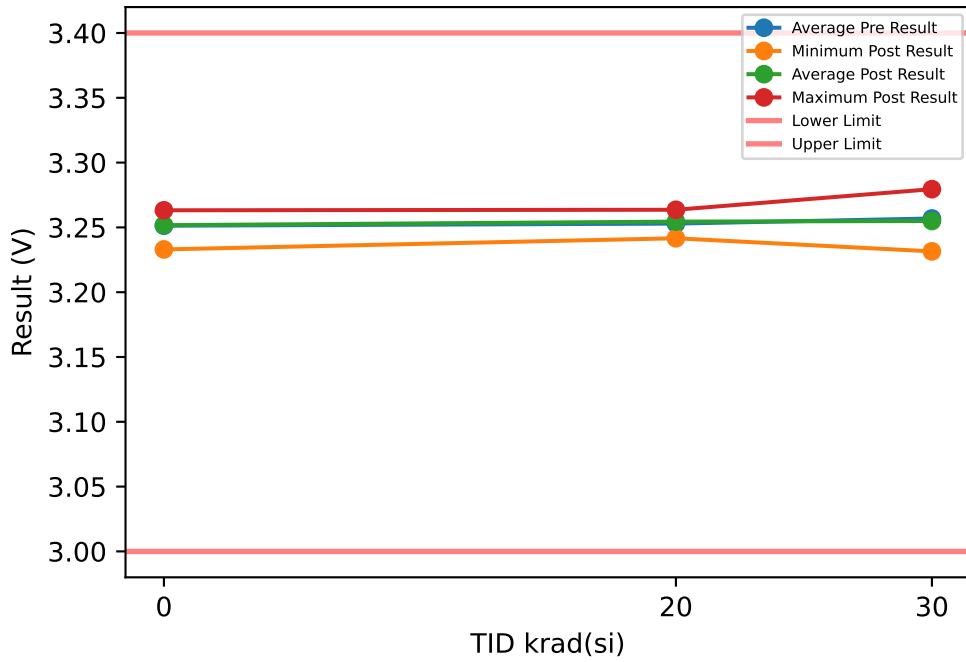

Test Results (Lower Limit = 3.0, Upper Limit = 3.4 (V))

Serial #	krad(si)	Exposure Conditions	Pre Result	Post Result	Delta
50	20	LDR biased	3.2536	3.2584	0.0048
51	20	LDR biased	3.2532	3.263	0.0098
52	20	LDR biased	3.253	3.2588	0.0058
53	20	LDR biased	3.2418	3.2474	0.0056
54	20	LDR biased	3.2429	3.2416	-0.0013
55	30	LDR biased	3.2741	3.2795	0.0054
56	30	LDR biased	3.2473	3.253	0.0057
57	30	LDR biased	3.2692	3.2791	0.0099
58	30	LDR biased	3.2478	3.2532	0.0054
59	30	LDR biased	3.2636	3.2687	0.0051
60	20	LDR unbiased	3.2685	3.2636	-0.0049
61	20	LDR unbiased	3.2634	3.258	-0.0054
62	20	LDR unbiased	3.2478	3.2479	0.0001
63	20	LDR unbiased	3.242	3.2428	0.0008
64	20	LDR unbiased	3.263	3.2632	0.0002
65	30	LDR unbiased	3.2437	3.2376	-0.0061
66	30	LDR unbiased	3.2687	3.2576	-0.0111
67	30	LDR unbiased	3.2537	3.2424	-0.0113
68	30	LDR unbiased	3.2424	3.2315	-0.0109
69	30	LDR unbiased	3.2583	3.2468	-0.0115
70	0	correlation	3.2428	3.2415	-0.0013
71	0	correlation	3.2591	3.2582	-0.0009
72	0	correlation	3.2586	3.2632	0.0046
73	0	correlation	3.2626	3.2626	0
74	0	correlation	3.2334	3.233	-0.0004

TID vs Post - Pre Exposure Delta

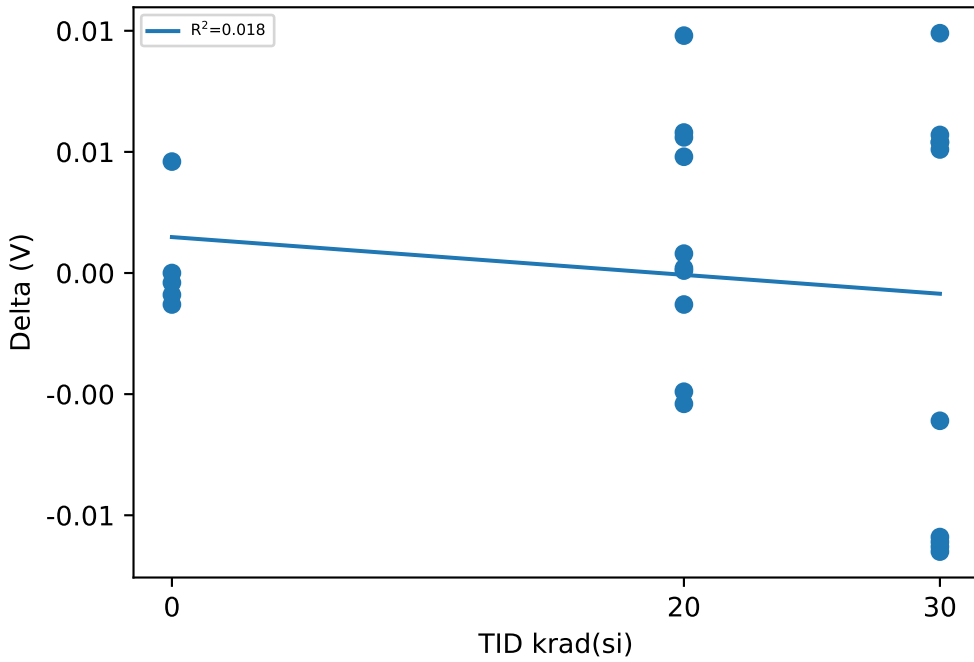

Test Statistics (V)

krad(si)	Pre Exposure Min	Pre Exposure Avg	Pre Exposure Max	Pre Exposure Std	Post Exposure Min	Post Exposure Avg	Post Exposure Max	Post Exposure Std	Min Delta	Avg Delta	Max Delta	Std Delta
0	3.2334	3.2513	3.2626	0.012594	3.233	3.2517	3.2632	0.013666	-0.0013	0.0004	0.0046	0.002399
20	3.2418	3.2529	3.2685	0.0095698	3.2416	3.2545	3.2636	0.0086536	-0.0054	0.00155	0.0098	0.0048945
30	3.2424	3.2569	3.2741	0.011561	3.2315	3.2549	3.2795	0.016545	-0.0115	-0.00194	0.0099	0.0089217

Device Test: 6.3 UJNA02(UVLO_HYS_UJNA02)

TID vs Result Stats

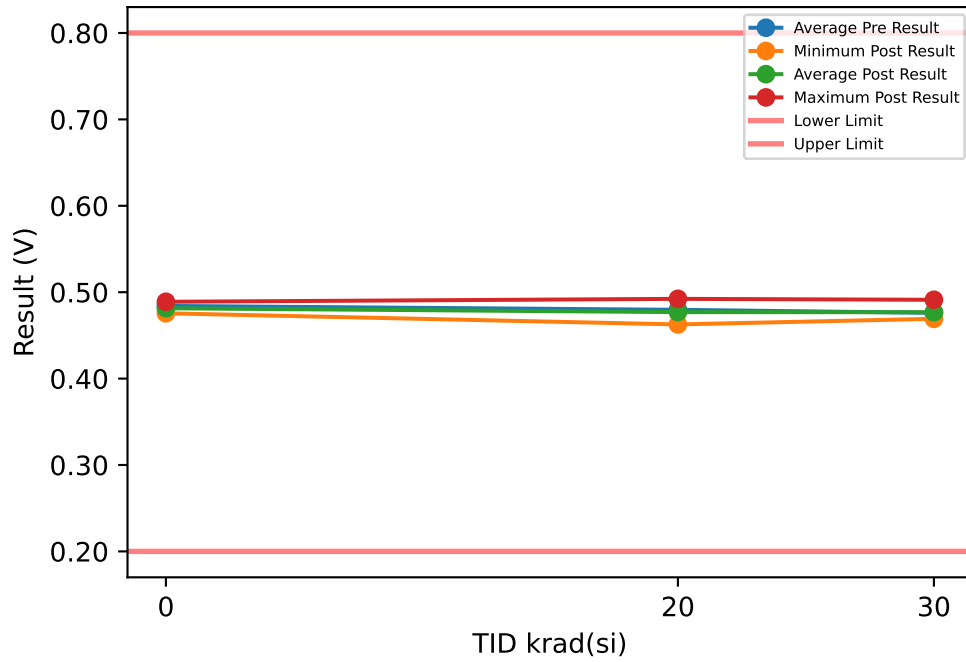

TID vs Post - Pre Exposure Delta

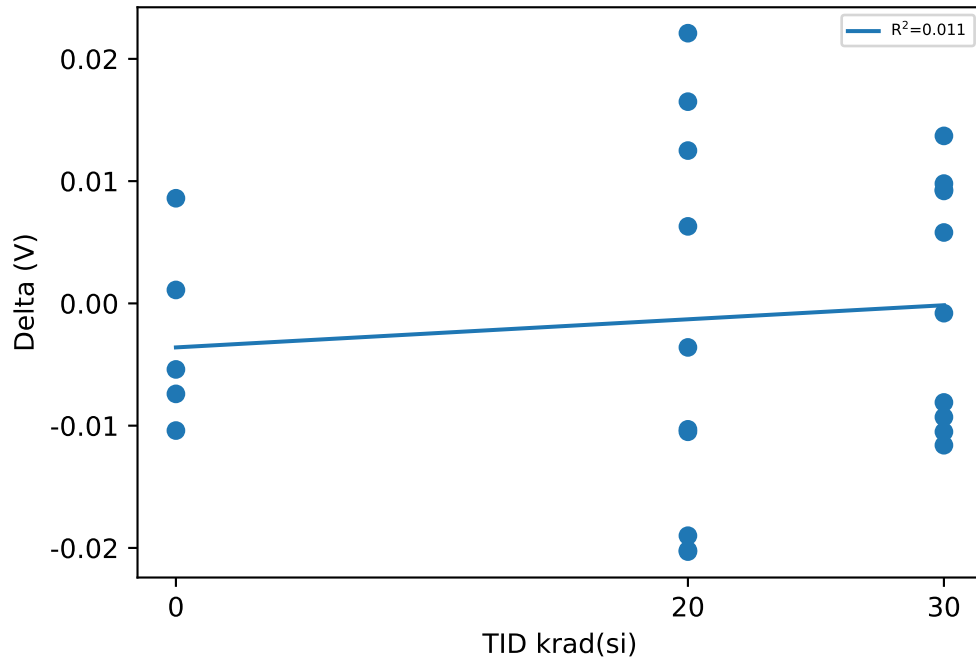

Test Results (Lower Limit = 0.2, Upper Limit = 0.8 (V))

Serial #	krad(si)	Exposure Conditions	Pre Result	Post Result	Delta
50	20	LDR biased	0.4698	0.4863	0.0165
51	20	LDR biased	0.4753	0.4717	-0.0036
52	20	LDR biased	0.4755	0.4818	0.0063
53	20	LDR biased	0.4812	0.4707	-0.0105
54	20	LDR biased	0.4749	0.4874	0.0125
55	30	LDR biased	0.4867	0.4762	-0.0105
56	30	LDR biased	0.4775	0.4912	0.0137
57	30	LDR biased	0.4831	0.475	-0.0081
58	30	LDR biased	0.4817	0.4701	-0.0116
59	30	LDR biased	0.4741	0.4839	0.0098
60	20	LDR unbiased	0.494	0.4738	-0.0202
61	20	LDR unbiased	0.4702	0.4923	0.0221
62	20	LDR unbiased	0.4817	0.4627	-0.019
63	20	LDR unbiased	0.4795	0.4692	-0.0103
64	20	LDR unbiased	0.494	0.4737	-0.0203
65	30	LDR unbiased	0.4824	0.4816	-0.0008
66	30	LDR unbiased	0.4654	0.4747	0.0093
67	30	LDR unbiased	0.4785	0.4692	-0.0093
68	30	LDR unbiased	0.4684	0.4742	0.0058
69	30	LDR unbiased	0.463	0.4722	0.0092
70	0	correlation	0.483	0.4756	-0.0074
71	0	correlation	0.4803	0.4889	0.0086
72	0	correlation	0.4927	0.4823	-0.0104
73	0	correlation	0.4809	0.482	0.0011
74	0	correlation	0.4837	0.4783	-0.0054

Test Statistics (V)

krad(si)	Pre Exposure Min	Pre Exposure Avg	Pre Exposure Max	Pre Exposure Std	Post Exposure Min	Post Exposure Avg	Post Exposure Max	Post Exposure Std	Min Delta	Avg Delta	Max Delta	Std Delta
0	0.4803	0.48412	0.4927	0.0050002	0.4756	0.48142	0.4889	0.0050167	-0.0104	-0.0027	0.0086	0.0075961
20	0.4698	0.47961	0.494	0.0085861	0.4627	0.47696	0.4923	0.0094634	-0.0203	-0.00265	0.0221	0.015975
30	0.463	0.47608	0.4867	0.0080933	0.4692	0.47683	0.4912	0.0068263	-0.0116	0.00075	0.0137	0.0098907

Device Test: 7.1001 UJTCWZ(EN4_Logic_High_Go-No-Go_UJTCWZ)

TID vs Result Stats

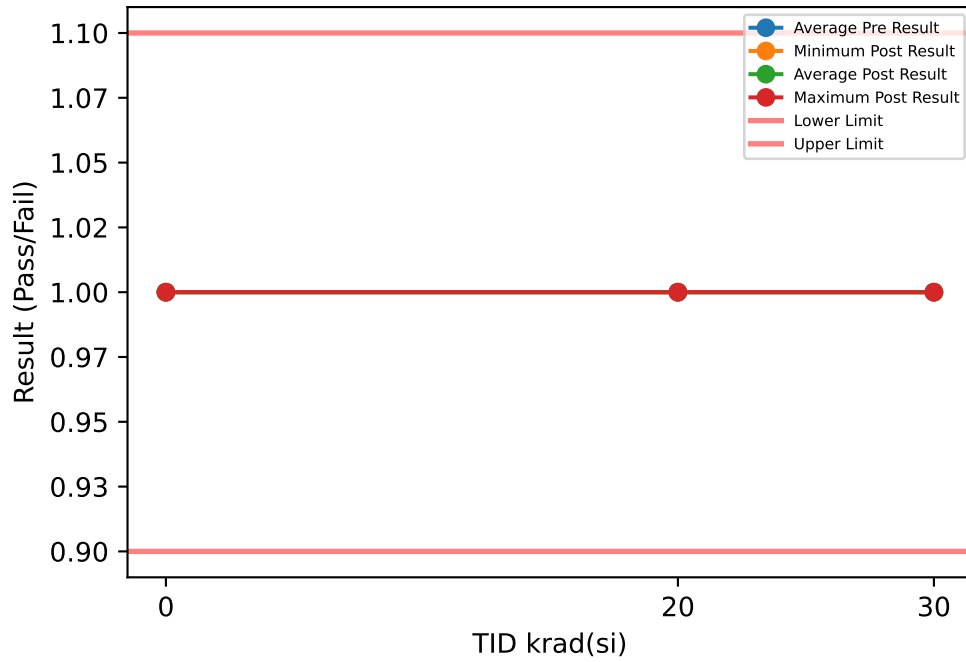

Test Results (Lower Limit = 0.9, Upper Limit = 1.1 (Pass/Fail))

Serial #	krad(si)	Exposure Conditions	Pre Result	Post Result	Delta
50	20	LDR biased	1	1	0
51	20	LDR biased	1	1	0
52	20	LDR biased	1	1	0
53	20	LDR biased	1	1	0
54	20	LDR biased	1	1	0
55	30	LDR biased	1	1	0
56	30	LDR biased	1	1	0
57	30	LDR biased	1	1	0
58	30	LDR biased	1	1	0
59	30	LDR biased	1	1	0
60	20	LDR unbiased	1	1	0
61	20	LDR unbiased	1	1	0
62	20	LDR unbiased	1	1	0
63	20	LDR unbiased	1	1	0
64	20	LDR unbiased	1	1	0
65	30	LDR unbiased	1	1	0
66	30	LDR unbiased	1	1	0
67	30	LDR unbiased	1	1	0
68	30	LDR unbiased	1	1	0
69	30	LDR unbiased	1	1	0
70	0	correlation	1	1	0
71	0	correlation	1	1	0
72	0	correlation	1	1	0
73	0	correlation	1	1	0
74	0	correlation	1	1	0

TID vs Post - Pre Exposure Delta

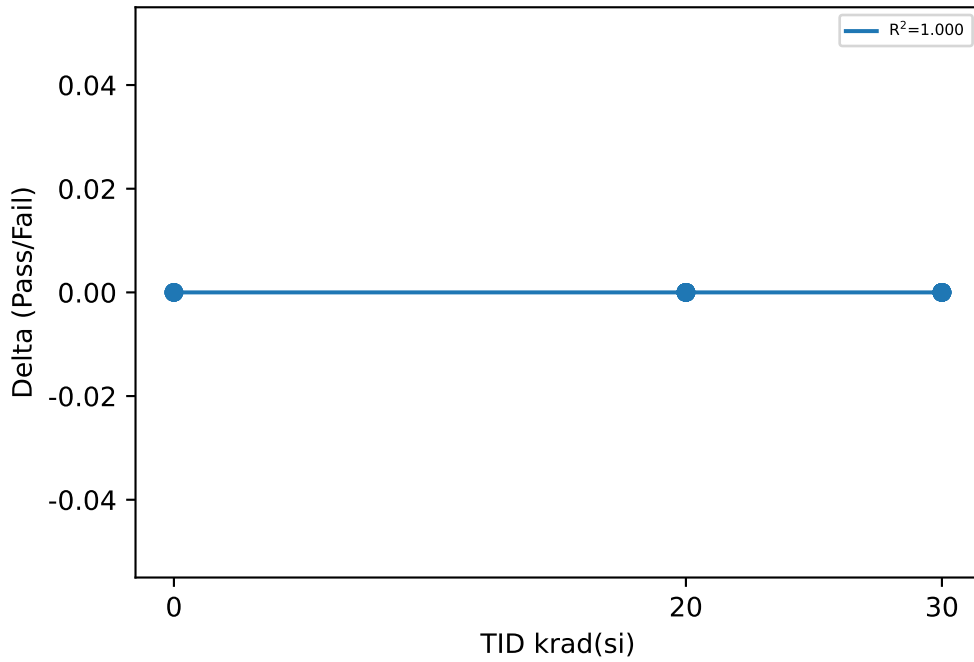

Test Statistics (Pass/Fail)

krad(si)	Pre Exposure Min	Pre Exposure Avg	Pre Exposure Max	Pre Exposure Std	Post Exposure Min	Post Exposure Avg	Post Exposure Max	Post Exposure Std	Min Delta	Avg Delta	Max Delta	Std Delta
0	1	1	1	0	1	1	1	0	0	0	0	0
20	1	1	1	0	1	1	1	0	0	0	0	0
30	1	1	1	0	1	1	1	0	0	0	0	0

Device Test: 7.101 UJTCWZ(EN1_Logic_High_Go-No-Go_UJTCWZ)

TID vs Result Stats

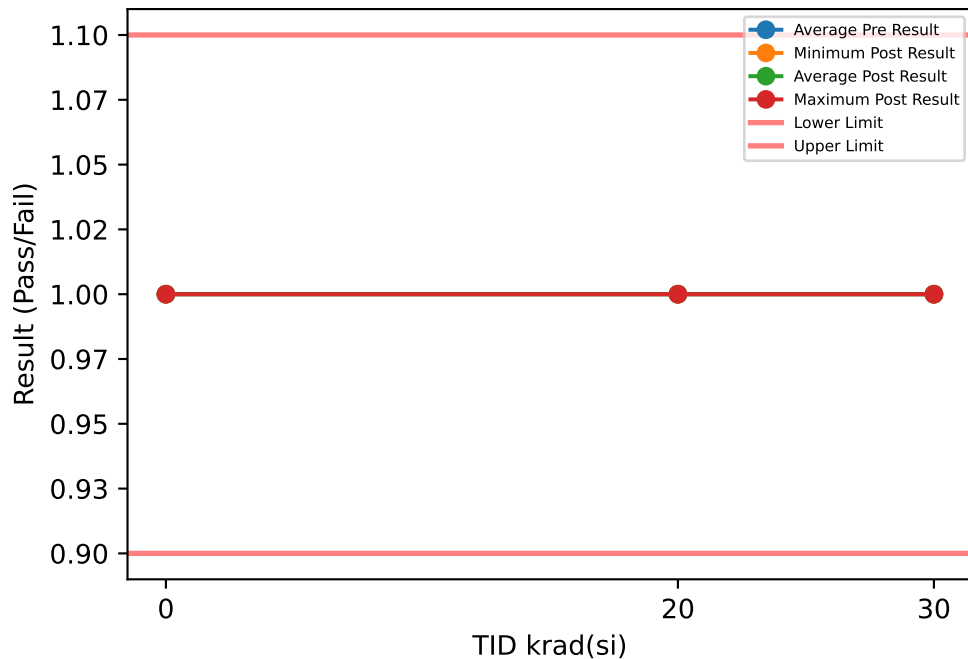

Test Results (Lower Limit = 0.9, Upper Limit = 1.1 (Pass/Fail))

Serial #	krad(si)	Exposure Conditions	Pre Result	Post Result	Delta
50	20	LDR biased	1	1	0
51	20	LDR biased	1	1	0
52	20	LDR biased	1	1	0
53	20	LDR biased	1	1	0
54	20	LDR biased	1	1	0
55	30	LDR biased	1	1	0
56	30	LDR biased	1	1	0
57	30	LDR biased	1	1	0
58	30	LDR biased	1	1	0
59	30	LDR biased	1	1	0
60	20	LDR unbiased	1	1	0
61	20	LDR unbiased	1	1	0
62	20	LDR unbiased	1	1	0
63	20	LDR unbiased	1	1	0
64	20	LDR unbiased	1	1	0
65	30	LDR unbiased	1	1	0
66	30	LDR unbiased	1	1	0
67	30	LDR unbiased	1	1	0
68	30	LDR unbiased	1	1	0
69	30	LDR unbiased	1	1	0
70	0	correlation	1	1	0
71	0	correlation	1	1	0
72	0	correlation	1	1	0
73	0	correlation	1	1	0
74	0	correlation	1	1	0

TID vs Post - Pre Exposure Delta

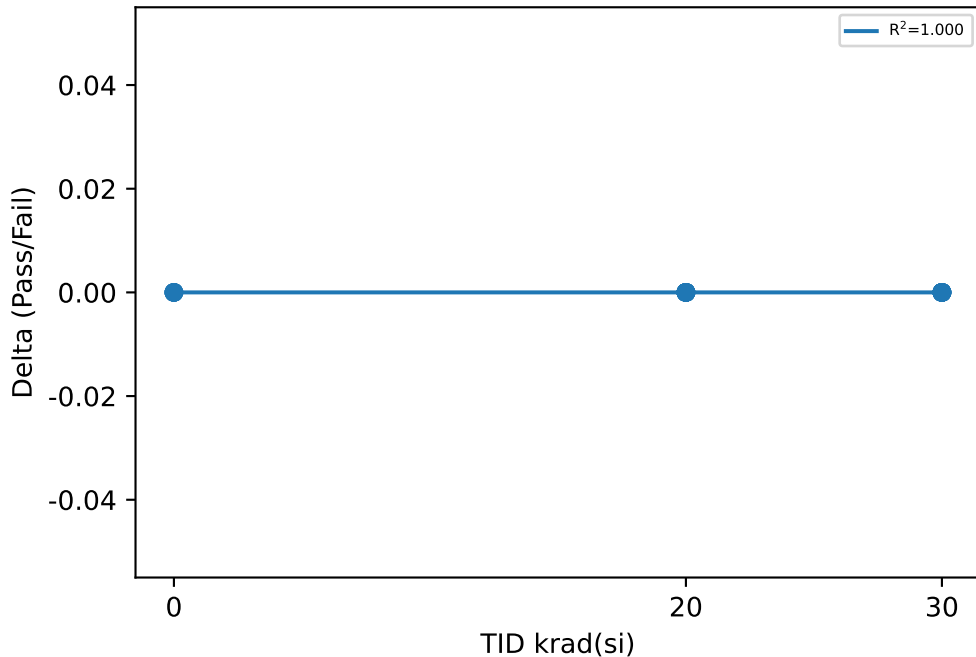

Test Statistics (Pass/Fail)

krad(si)	Pre Exposure Min	Pre Exposure Avg	Pre Exposure Max	Pre Exposure Std	Post Exposure Min	Post Exposure Avg	Post Exposure Max	Post Exposure Std	Min Delta	Avg Delta	Max Delta	Std Delta
0	1	1	1	0	1	1	1	0	0	0	0	0
20	1	1	1	0	1	1	1	0	0	0	0	0
30	1	1	1	0	1	1	1	0	0	0	0	0

Device Test: 7.111 UJVVXI(EN4_Logic_Low_Go-No-Go_UJVVXI)

TID vs Result Stats

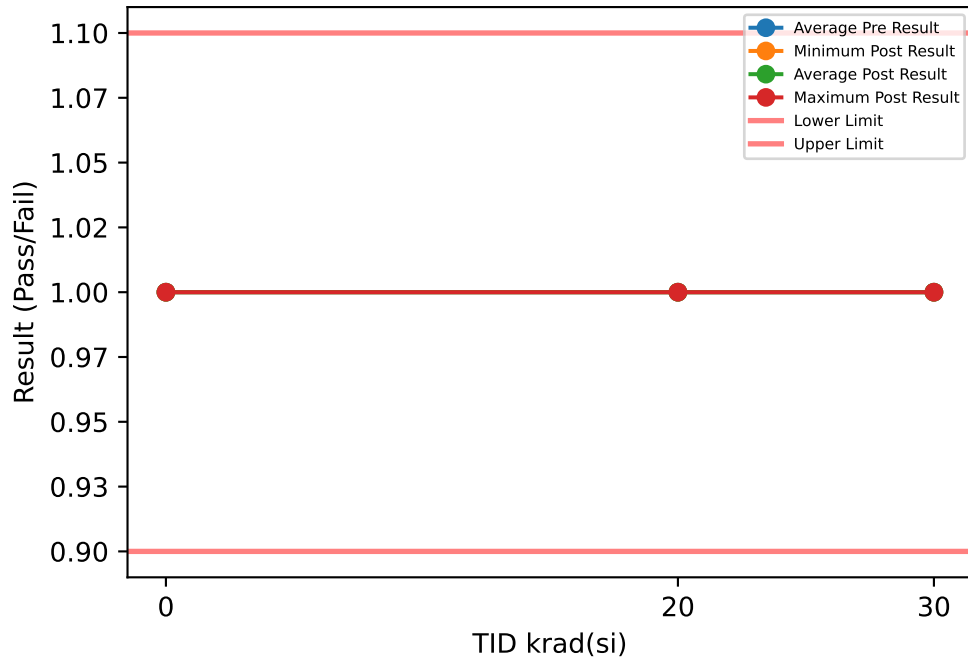

Test Results (Lower Limit = 0.9, Upper Limit = 1.1 (Pass/Fail))

Serial #	krad(si)	Exposure Conditions	Pre Result	Post Result	Delta
50	20	LDR biased	1	1	0
51	20	LDR biased	1	1	0
52	20	LDR biased	1	1	0
53	20	LDR biased	1	1	0
54	20	LDR biased	1	1	0
55	30	LDR biased	1	1	0
56	30	LDR biased	1	1	0
57	30	LDR biased	1	1	0
58	30	LDR biased	1	1	0
59	30	LDR biased	1	1	0
60	20	LDR unbiased	1	1	0
61	20	LDR unbiased	1	1	0
62	20	LDR unbiased	1	1	0
63	20	LDR unbiased	1	1	0
64	20	LDR unbiased	1	1	0
65	30	LDR unbiased	1	1	0
66	30	LDR unbiased	1	1	0
67	30	LDR unbiased	1	1	0
68	30	LDR unbiased	1	1	0
69	30	LDR unbiased	1	1	0
70	0	correlation	1	1	0
71	0	correlation	1	1	0
72	0	correlation	1	1	0
73	0	correlation	1	1	0
74	0	correlation	1	1	0

TID vs Post - Pre Exposure Delta

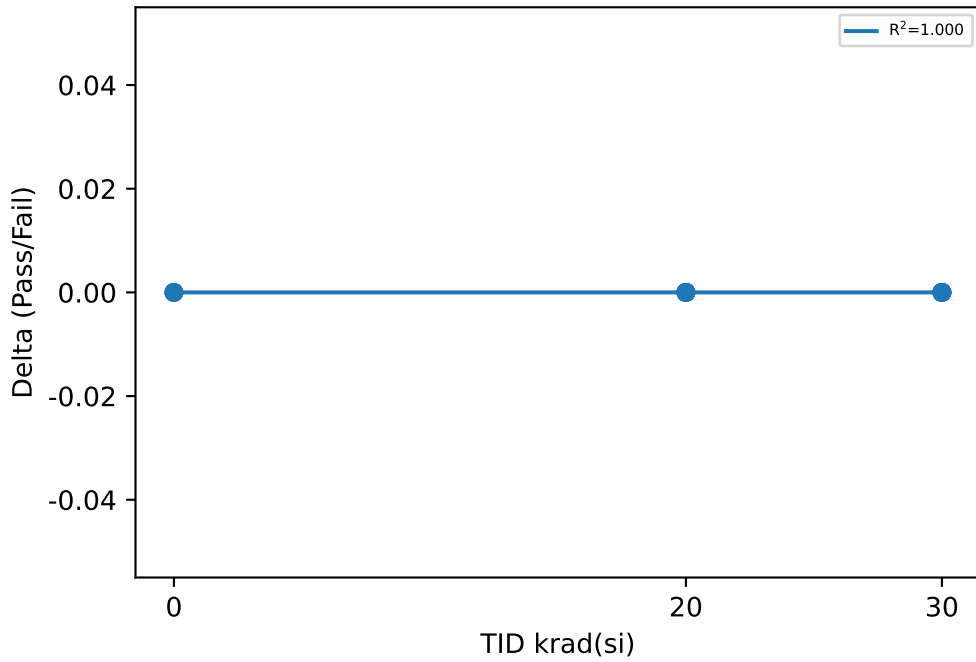

Test Statistics (Pass/Fail)

krad(si)	Pre Exposure Min	Pre Exposure Avg	Pre Exposure Max	Pre Exposure Std	Post Exposure Min	Post Exposure Avg	Post Exposure Max	Post Exposure Std	Min Delta	Avg Delta	Max Delta	Std Delta
0	1	1	1	0	1	1	1	0	0	0	0	0
20	1	1	1	0	1	1	1	0	0	0	0	0
30	1	1	1	0	1	1	1	0	0	0	0	0

Device Test: 7.131 UJTCWZ(DIAG_Logic_High_Go-No-Go_UJTCWZ)

TID vs Result Stats

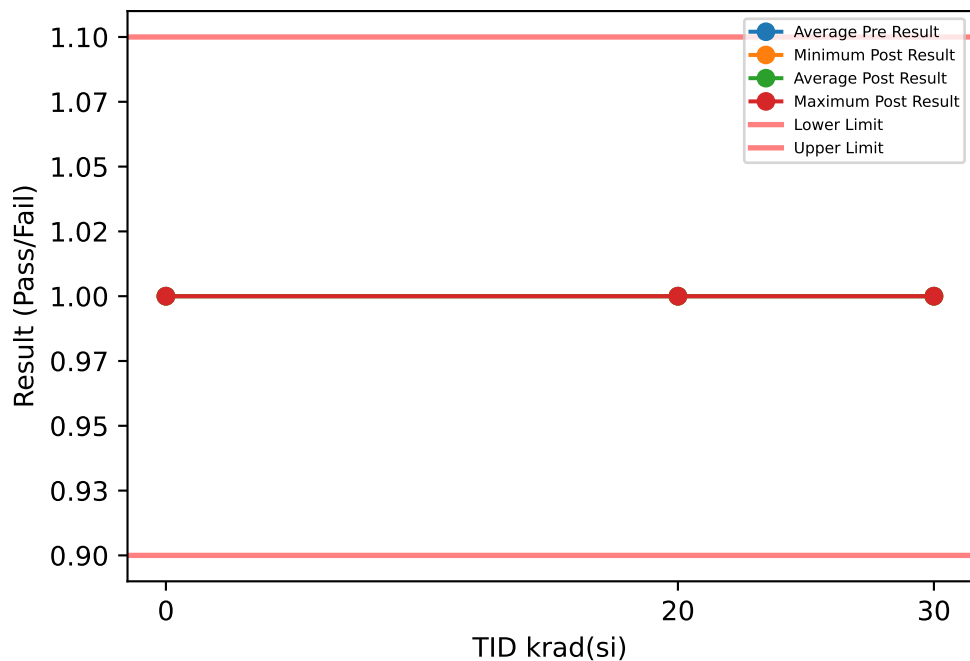

Test Results (Lower Limit = 0.9, Upper Limit = 1.1 (Pass/Fail))

Serial #	krad(si)	Exposure Conditions	Pre Result	Post Result	Delta
50	20	LDR biased	1	1	0
51	20	LDR biased	1	1	0
52	20	LDR biased	1	1	0
53	20	LDR biased	1	1	0
54	20	LDR biased	1	1	0
55	30	LDR biased	1	1	0
56	30	LDR biased	1	1	0
57	30	LDR biased	1	1	0
58	30	LDR biased	1	1	0
59	30	LDR biased	1	1	0
60	20	LDR unbiased	1	1	0
61	20	LDR unbiased	1	1	0
62	20	LDR unbiased	1	1	0
63	20	LDR unbiased	1	1	0
64	20	LDR unbiased	1	1	0
65	30	LDR unbiased	1	1	0
66	30	LDR unbiased	1	1	0
67	30	LDR unbiased	1	1	0
68	30	LDR unbiased	1	1	0
69	30	LDR unbiased	1	1	0
70	0	correlation	1	1	0
71	0	correlation	1	1	0
72	0	correlation	1	1	0
73	0	correlation	1	1	0
74	0	correlation	1	1	0

TID vs Post - Pre Exposure Delta

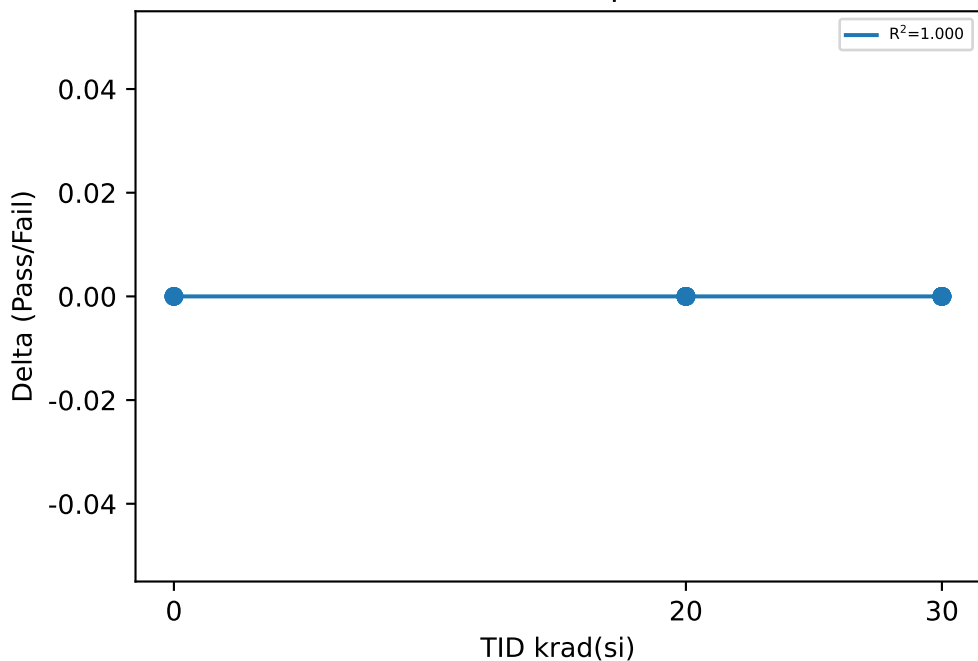

Test Statistics (Pass/Fail)

krad(si)	Pre Exposure Min	Pre Exposure Avg	Pre Exposure Max	Pre Exposure Std	Post Exposure Min	Post Exposure Avg	Post Exposure Max	Post Exposure Std	Min Delta	Avg Delta	Max Delta	Std Delta
0	1	1	1	0	1	1	1	0	0	0	0	0
20	1	1	1	0	1	1	1	0	0	0	0	0
30	1	1	1	0	1	1	1	0	0	0	0	0

Device Test: 7.141 UJVVXI(DIAG_Logic_Low_Go-No-Go_UJVVXI)

TID vs Result Stats

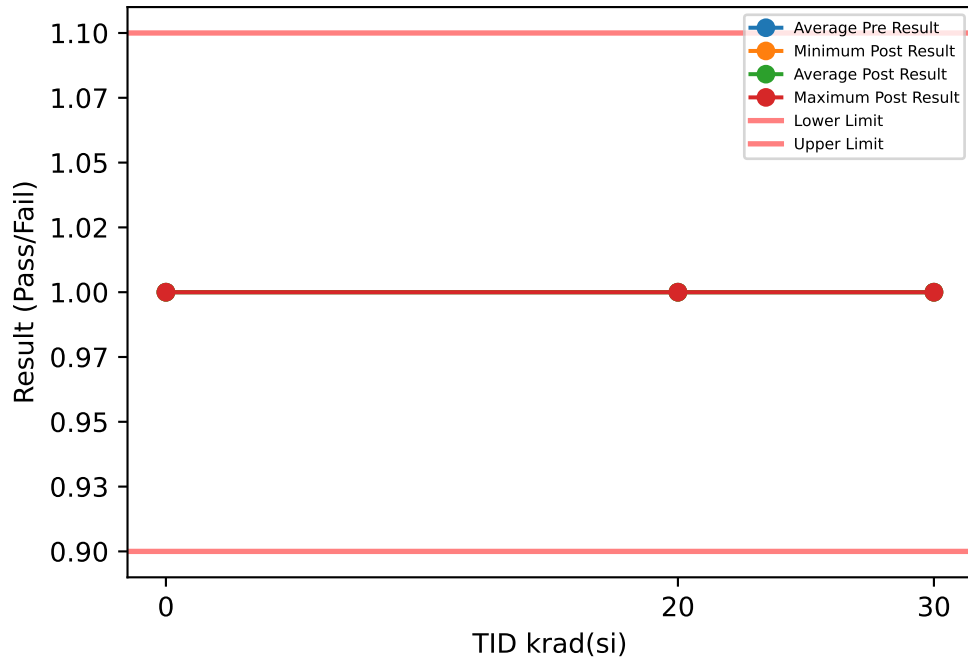

Test Results (Lower Limit = 0.9, Upper Limit = 1.1 (Pass/Fail))

Serial #	krad(si)	Exposure Conditions	Pre Result	Post Result	Delta
50	20	LDR biased	1	1	0
51	20	LDR biased	1	1	0
52	20	LDR biased	1	1	0
53	20	LDR biased	1	1	0
54	20	LDR biased	1	1	0
55	30	LDR biased	1	1	0
56	30	LDR biased	1	1	0
57	30	LDR biased	1	1	0
58	30	LDR biased	1	1	0
59	30	LDR biased	1	1	0
60	20	LDR unbiased	1	1	0
61	20	LDR unbiased	1	1	0
62	20	LDR unbiased	1	1	0
63	20	LDR unbiased	1	1	0
64	20	LDR unbiased	1	1	0
65	30	LDR unbiased	1	1	0
66	30	LDR unbiased	1	1	0
67	30	LDR unbiased	1	1	0
68	30	LDR unbiased	1	1	0
69	30	LDR unbiased	1	1	0
70	0	correlation	1	1	0
71	0	correlation	1	1	0
72	0	correlation	1	1	0
73	0	correlation	1	1	0
74	0	correlation	1	1	0

TID vs Post - Pre Exposure Delta

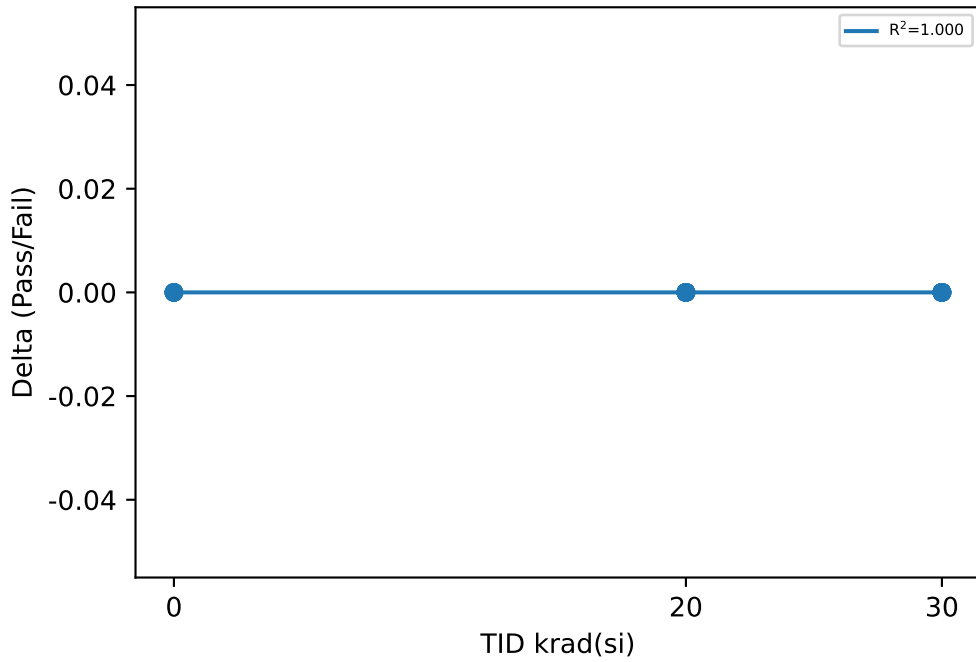

Test Statistics (Pass/Fail)

krad(si)	Pre Exposure Min	Pre Exposure Avg	Pre Exposure Max	Pre Exposure Std	Post Exposure Min	Post Exposure Avg	Post Exposure Max	Post Exposure Std	Min Delta	Avg Delta	Max Delta	Std Delta
0	1	1	1	0	1	1	1	0	0	0	0	0
20	1	1	1	0	1	1	1	0	0	0	0	0
30	1	1	1	0	1	1	1	0	0	0	0	0

Device Test: 7.161 UJTCWZ(SEH_Logic_High_Go-No-Go_UJTCWZ)

TID vs Result Stats

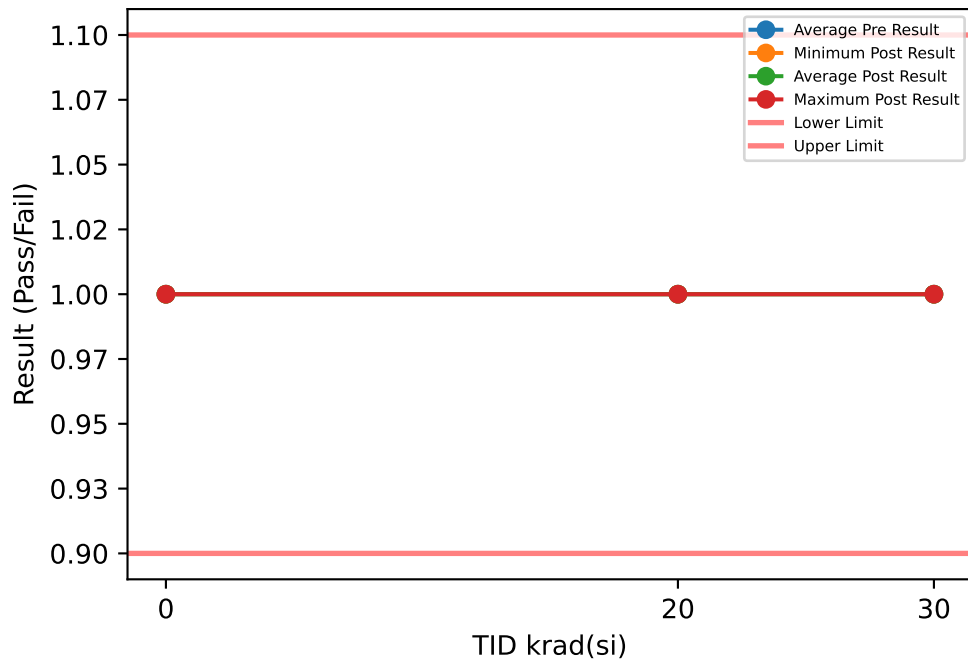

Test Results (Lower Limit = 0.9, Upper Limit = 1.1 (Pass/Fail))

Serial #	krad(si)	Exposure Conditions	Pre Result	Post Result	Delta
50	20	LDR biased	1	1	0
51	20	LDR biased	1	1	0
52	20	LDR biased	1	1	0
53	20	LDR biased	1	1	0
54	20	LDR biased	1	1	0
55	30	LDR biased	1	1	0
56	30	LDR biased	1	1	0
57	30	LDR biased	1	1	0
58	30	LDR biased	1	1	0
59	30	LDR biased	1	1	0
60	20	LDR unbiased	1	1	0
61	20	LDR unbiased	1	1	0
62	20	LDR unbiased	1	1	0
63	20	LDR unbiased	1	1	0
64	20	LDR unbiased	1	1	0
65	30	LDR unbiased	1	1	0
66	30	LDR unbiased	1	1	0
67	30	LDR unbiased	1	1	0
68	30	LDR unbiased	1	1	0
69	30	LDR unbiased	1	1	0
70	0	correlation	1	1	0
71	0	correlation	1	1	0
72	0	correlation	1	1	0
73	0	correlation	1	1	0
74	0	correlation	1	1	0

TID vs Post - Pre Exposure Delta

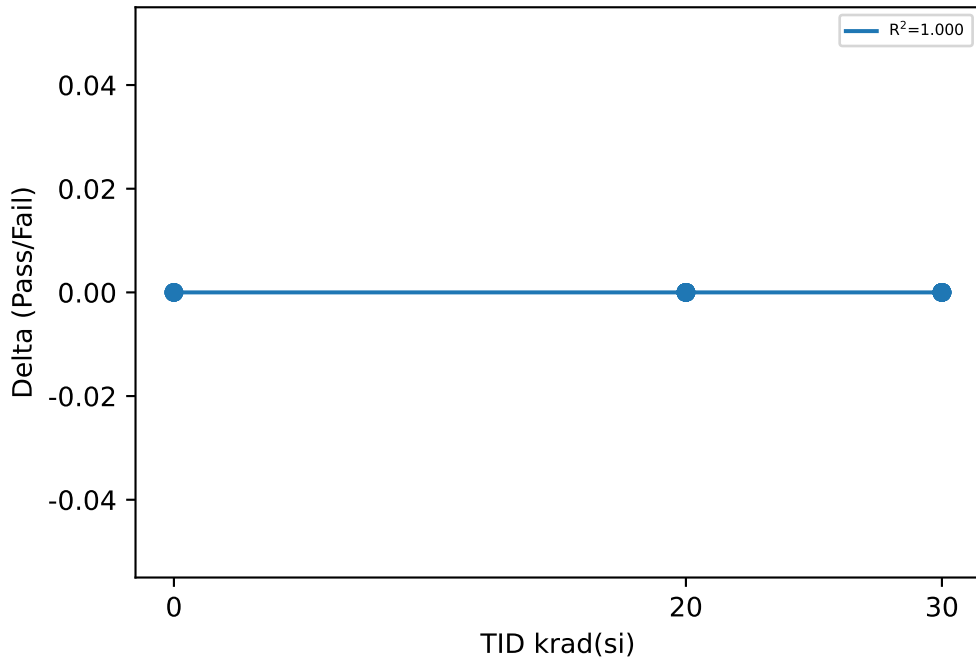

Test Statistics (Pass/Fail)

krad(si)	Pre Exposure Min	Pre Exposure Avg	Pre Exposure Max	Pre Exposure Std	Post Exposure Min	Post Exposure Avg	Post Exposure Max	Post Exposure Std	Min Delta	Avg Delta	Max Delta	Std Delta
0	1	1	1	0	1	1	1	0	0	0	0	0
20	1	1	1	0	1	1	1	0	0	0	0	0
30	1	1	1	0	1	1	1	0	0	0	0	0

Device Test: 7.171 UJVVXI(SEH_Logic_Low_Go-No-Go_UJVVXI)

TID vs Result Stats

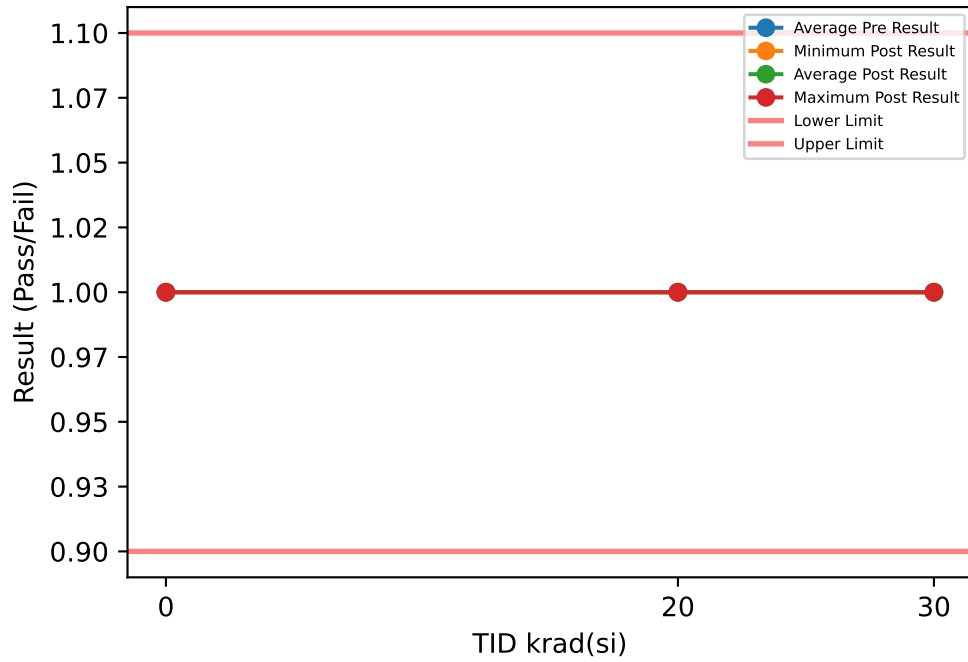

Test Results (Lower Limit = 0.9, Upper Limit = 1.1 (Pass/Fail))

Serial #	krad(si)	Exposure Conditions	Pre Result	Post Result	Delta
50	20	LDR biased	1	1	0
51	20	LDR biased	1	1	0
52	20	LDR biased	1	1	0
53	20	LDR biased	1	1	0
54	20	LDR biased	1	1	0
55	30	LDR biased	1	1	0
56	30	LDR biased	1	1	0
57	30	LDR biased	1	1	0
58	30	LDR biased	1	1	0
59	30	LDR biased	1	1	0
60	20	LDR unbiased	1	1	0
61	20	LDR unbiased	1	1	0
62	20	LDR unbiased	1	1	0
63	20	LDR unbiased	1	1	0
64	20	LDR unbiased	1	1	0
65	30	LDR unbiased	1	1	0
66	30	LDR unbiased	1	1	0
67	30	LDR unbiased	1	1	0
68	30	LDR unbiased	1	1	0
69	30	LDR unbiased	1	1	0
70	0	correlation	1	1	0
71	0	correlation	1	1	0
72	0	correlation	1	1	0
73	0	correlation	1	1	0
74	0	correlation	1	1	0

TID vs Post - Pre Exposure Delta

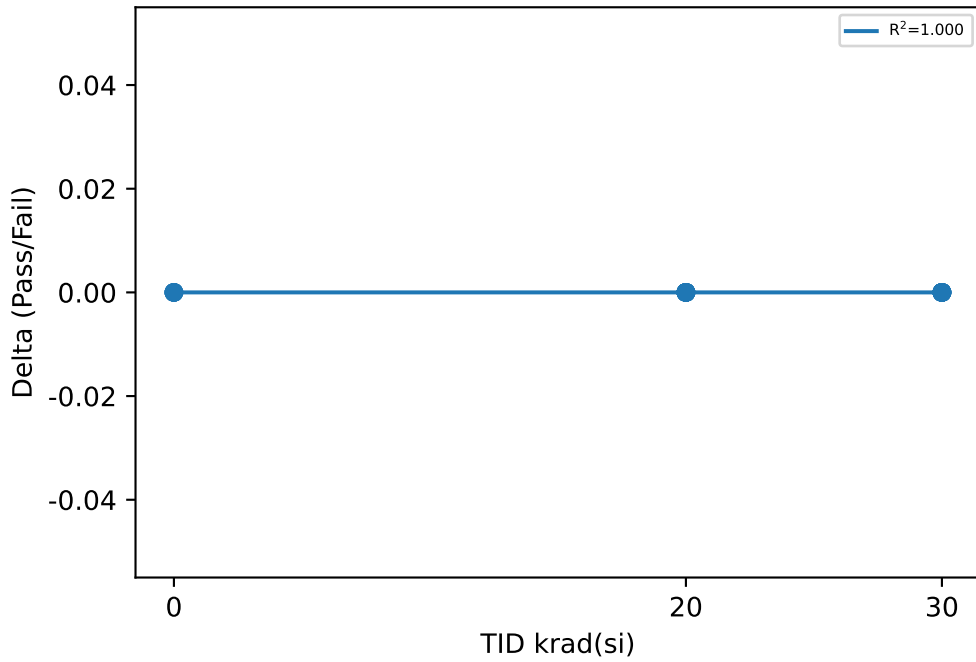

Test Statistics (Pass/Fail)

krad(si)	Pre Exposure Min	Pre Exposure Avg	Pre Exposure Max	Pre Exposure Std	Post Exposure Min	Post Exposure Avg	Post Exposure Max	Post Exposure Std	Min Delta	Avg Delta	Max Delta	Std Delta
0	1	1	1	0	1	1	1	0	0	0	0	0
20	1	1	1	0	1	1	1	0	0	0	0	0
30	1	1	1	0	1	1	1	0	0	0	0	0

Device Test: 7.191 UJTCWZ(SEL_Logic_High_Go-No-Go_UJTCWZ)

TID vs Result Stats

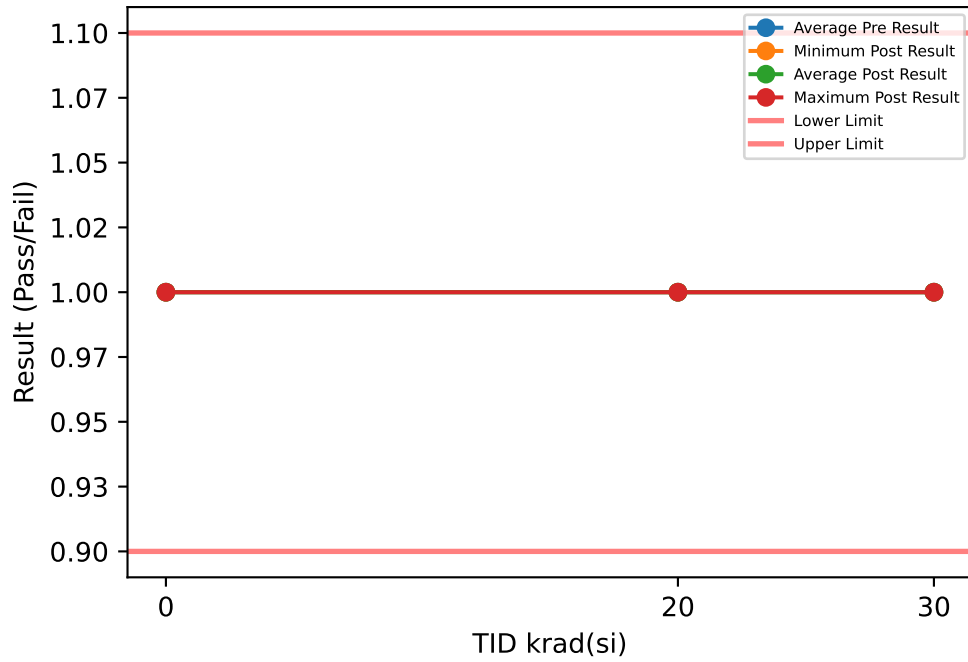

Test Results (Lower Limit = 0.9, Upper Limit = 1.1 (Pass/Fail))

Serial #	krad(si)	Exposure Conditions	Pre Result	Post Result	Delta
50	20	LDR biased	1	1	0
51	20	LDR biased	1	1	0
52	20	LDR biased	1	1	0
53	20	LDR biased	1	1	0
54	20	LDR biased	1	1	0
55	30	LDR biased	1	1	0
56	30	LDR biased	1	1	0
57	30	LDR biased	1	1	0
58	30	LDR biased	1	1	0
59	30	LDR biased	1	1	0
60	20	LDR unbiased	1	1	0
61	20	LDR unbiased	1	1	0
62	20	LDR unbiased	1	1	0
63	20	LDR unbiased	1	1	0
64	20	LDR unbiased	1	1	0
65	30	LDR unbiased	1	1	0
66	30	LDR unbiased	1	1	0
67	30	LDR unbiased	1	1	0
68	30	LDR unbiased	1	1	0
69	30	LDR unbiased	1	1	0
70	0	correlation	1	1	0
71	0	correlation	1	1	0
72	0	correlation	1	1	0
73	0	correlation	1	1	0
74	0	correlation	1	1	0

TID vs Post - Pre Exposure Delta

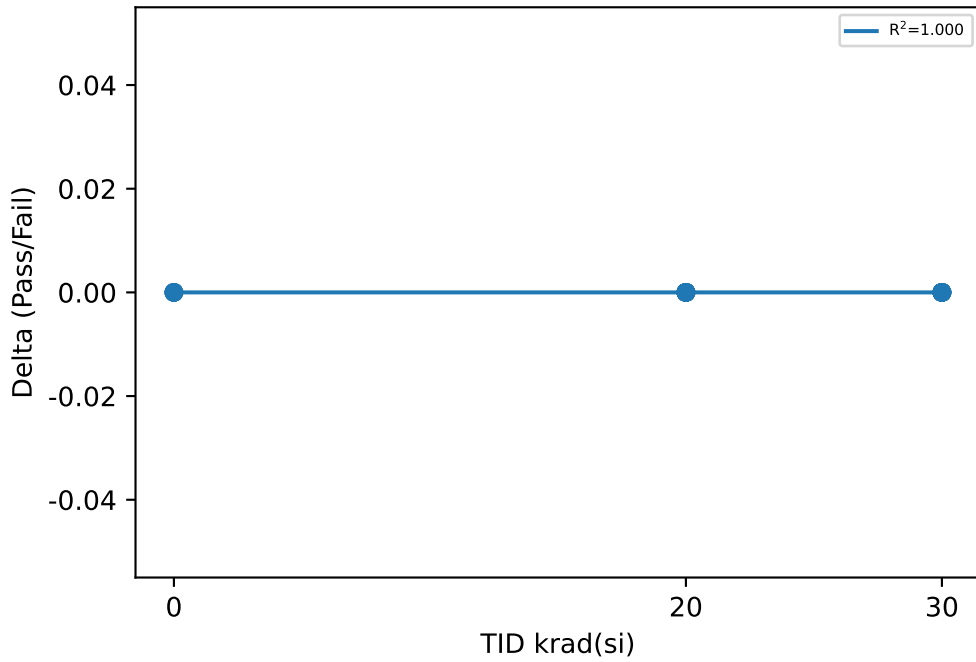

Test Statistics (Pass/Fail)

krad(si)	Pre Exposure Min	Pre Exposure Avg	Pre Exposure Max	Pre Exposure Std	Post Exposure Min	Post Exposure Avg	Post Exposure Max	Post Exposure Std	Min Delta	Avg Delta	Max Delta	Std Delta
0	1	1	1	0	1	1	1	0	0	0	0	0
20	1	1	1	0	1	1	1	0	0	0	0	0
30	1	1	1	0	1	1	1	0	0	0	0	0

Device Test: 7.2001 UJVVXI(SEL_Logic_Low_Go-No-Go_UJVVXI)

TID vs Result Stats

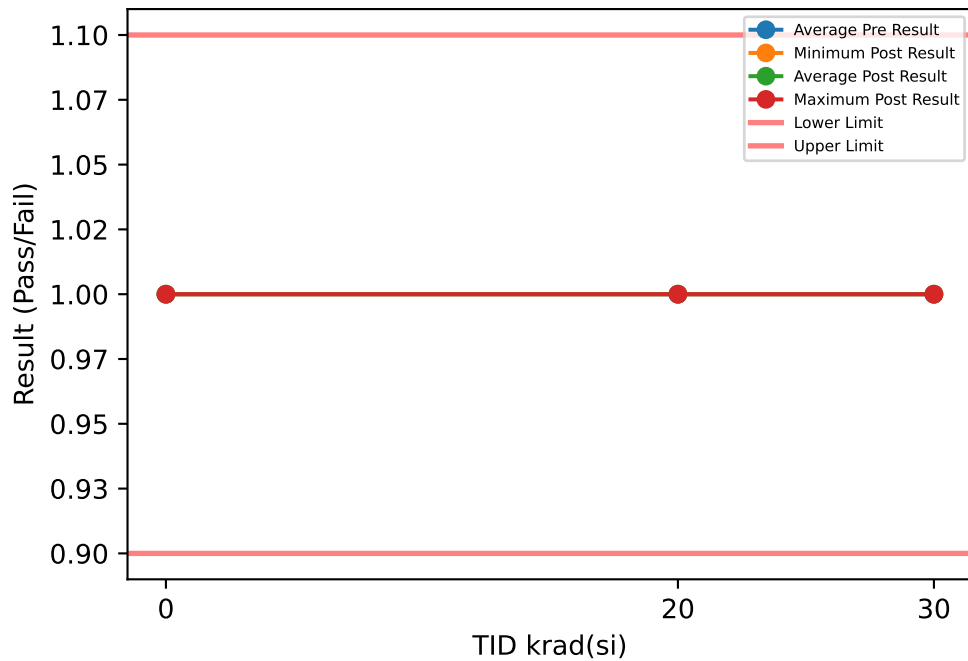

Test Results (Lower Limit = 0.9, Upper Limit = 1.1 (Pass/Fail))

Serial #	krad(si)	Exposure Conditions	Pre Result	Post Result	Delta
50	20	LDR biased	1	1	0
51	20	LDR biased	1	1	0
52	20	LDR biased	1	1	0
53	20	LDR biased	1	1	0
54	20	LDR biased	1	1	0
55	30	LDR biased	1	1	0
56	30	LDR biased	1	1	0
57	30	LDR biased	1	1	0
58	30	LDR biased	1	1	0
59	30	LDR biased	1	1	0
60	20	LDR unbiased	1	1	0
61	20	LDR unbiased	1	1	0
62	20	LDR unbiased	1	1	0
63	20	LDR unbiased	1	1	0
64	20	LDR unbiased	1	1	0
65	30	LDR unbiased	1	1	0
66	30	LDR unbiased	1	1	0
67	30	LDR unbiased	1	1	0
68	30	LDR unbiased	1	1	0
69	30	LDR unbiased	1	1	0
70	0	correlation	1	1	0
71	0	correlation	1	1	0
72	0	correlation	1	1	0
73	0	correlation	1	1	0
74	0	correlation	1	1	0

TID vs Post - Pre Exposure Delta

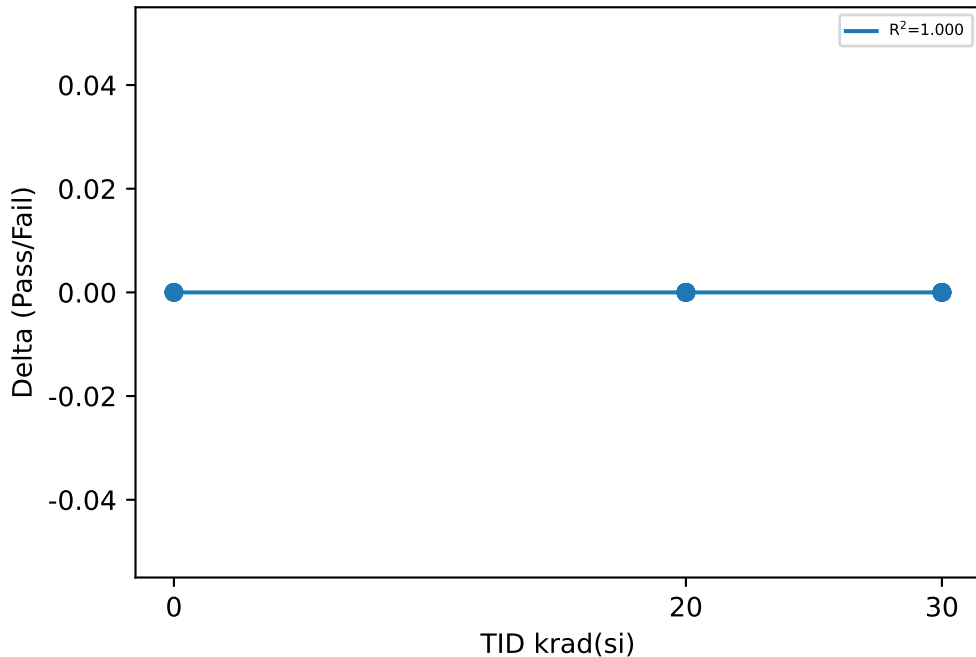

Test Statistics (Pass/Fail)

krad(si)	Pre Exposure Min	Pre Exposure Avg	Pre Exposure Max	Pre Exposure Std	Post Exposure Min	Post Exposure Avg	Post Exposure Max	Post Exposure Std	Min Delta	Avg Delta	Max Delta	Std Delta
0	1	1	1	0	1	1	1	0	0	0	0	0
20	1	1	1	0	1	1	1	0	0	0	0	0
30	1	1	1	0	1	1	1	0	0	0	0	0

Device Test: 7.201 UJVVXI(EN1_Logic_Low_Go-No-Go_UJVVXI)

TID vs Result Stats

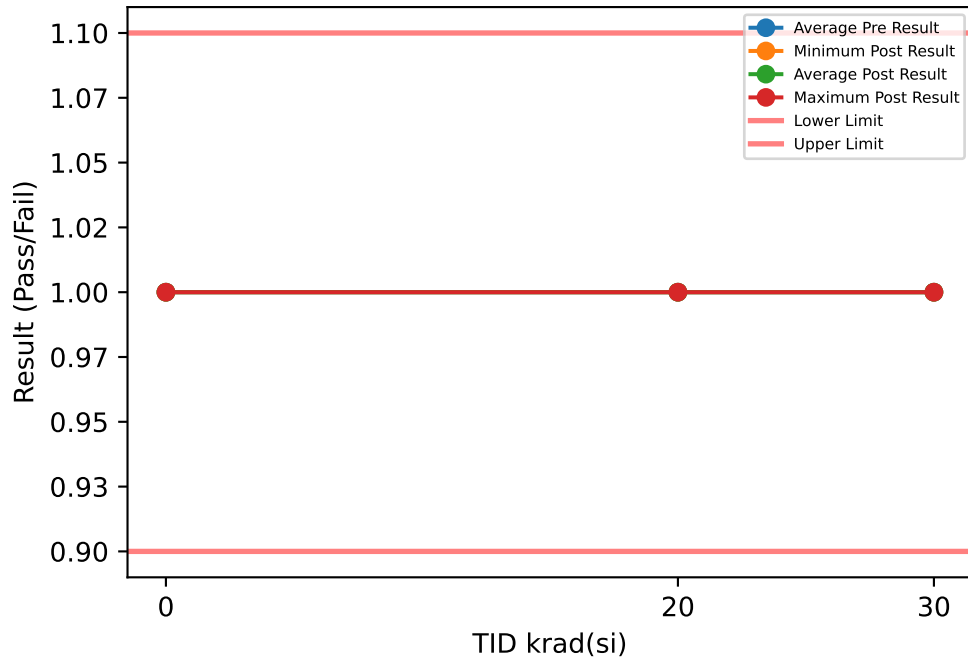

TID vs Post - Pre Exposure Delta

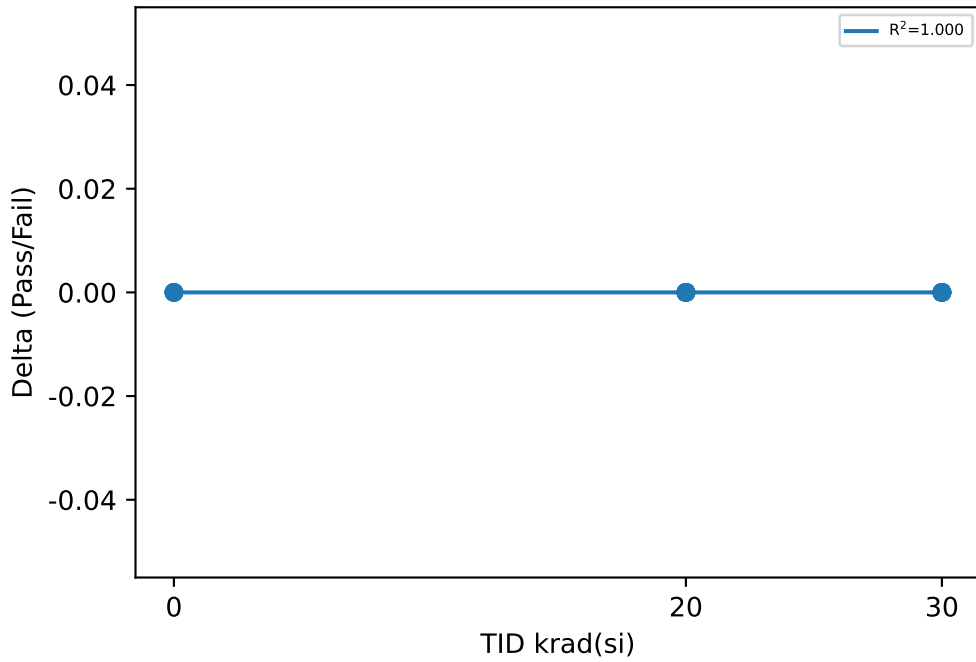

Test Results (Lower Limit = 0.9, Upper Limit = 1.1 (Pass/Fail))

Serial #	krad(si)	Exposure Conditions	Pre Result	Post Result	Delta
50	20	LDR biased	1	1	0
51	20	LDR biased	1	1	0
52	20	LDR biased	1	1	0
53	20	LDR biased	1	1	0
54	20	LDR biased	1	1	0
55	30	LDR biased	1	1	0
56	30	LDR biased	1	1	0
57	30	LDR biased	1	1	0
58	30	LDR biased	1	1	0
59	30	LDR biased	1	1	0
60	20	LDR unbiased	1	1	0
61	20	LDR unbiased	1	1	0
62	20	LDR unbiased	1	1	0
63	20	LDR unbiased	1	1	0
64	20	LDR unbiased	1	1	0
65	30	LDR unbiased	1	1	0
66	30	LDR unbiased	1	1	0
67	30	LDR unbiased	1	1	0
68	30	LDR unbiased	1	1	0
69	30	LDR unbiased	1	1	0
70	0	correlation	1	1	0
71	0	correlation	1	1	0
72	0	correlation	1	1	0
73	0	correlation	1	1	0
74	0	correlation	1	1	0

Test Statistics (Pass/Fail)

krad(si)	Pre Exposure Min	Pre Exposure Avg	Pre Exposure Max	Pre Exposure Std	Post Exposure Min	Post Exposure Avg	Post Exposure Max	Post Exposure Std	Min Delta	Avg Delta	Max Delta	Std Delta
0	1	1	1	0	1	1	1	0	0	0	0	0
20	1	1	1	0	1	1	1	0	0	0	0	0
30	1	1	1	0	1	1	1	0	0	0	0	0

Device Test: 7.22 UJQE20(EN1_Pulldown_Resistor_UJQE20)

TID vs Result Stats

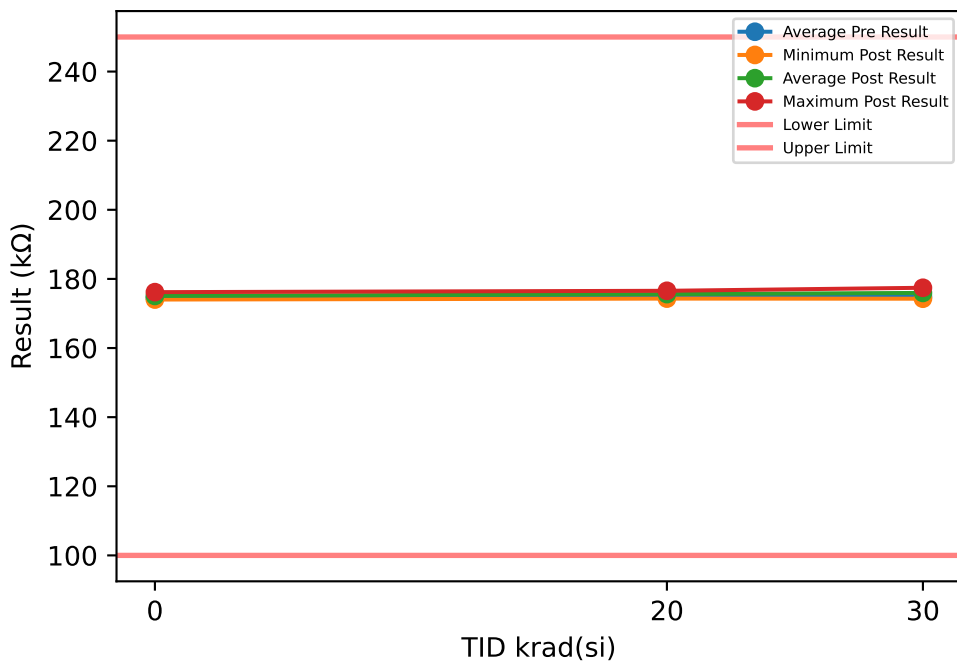

Test Results (Lower Limit = 100.0, Upper Limit = 250.0 (kΩ))

Serial #	krad(si)	Exposure Conditions	Pre Result	Post Result	Delta
50	20	LDR biased	176.21	176.56	0.3545
51	20	LDR biased	175.82	176.25	0.4273
52	20	LDR biased	174.44	174.99	0.5445
53	20	LDR biased	175.89	176.36	0.4618
54	20	LDR biased	175.54	175.93	0.3882
55	30	LDR biased	174.72	175.86	1.1352
56	30	LDR biased	174.04	175.38	1.3431
57	30	LDR biased	175.94	177.2	1.2614
58	30	LDR biased	175.25	176.43	1.1782
59	30	LDR biased	174.66	175.48	0.8145
60	20	LDR unbiased	174.24	174.82	0.5794
61	20	LDR unbiased	175.19	175.48	0.2885
62	20	LDR unbiased	175.78	176.28	0.4992
63	20	LDR unbiased	174.64	175.12	0.4811
64	20	LDR unbiased	173.92	174.3	0.386
65	30	LDR unbiased	175.76	176.91	1.1469
66	30	LDR unbiased	173.34	174.27	0.9326
67	30	LDR unbiased	174.41	175.54	1.1323
68	30	LDR unbiased	176.28	177.44	1.1599
69	30	LDR unbiased	173.99	174.99	0.9986
70	0	correlation	175.27	176.17	0.8976
71	0	correlation	174.79	175.29	0.4942
72	0	correlation	173.31	174.03	0.716
73	0	correlation	174.79	175.19	0.3956
74	0	correlation	174.4	174.71	0.3112

TID vs Post - Pre Exposure Delta

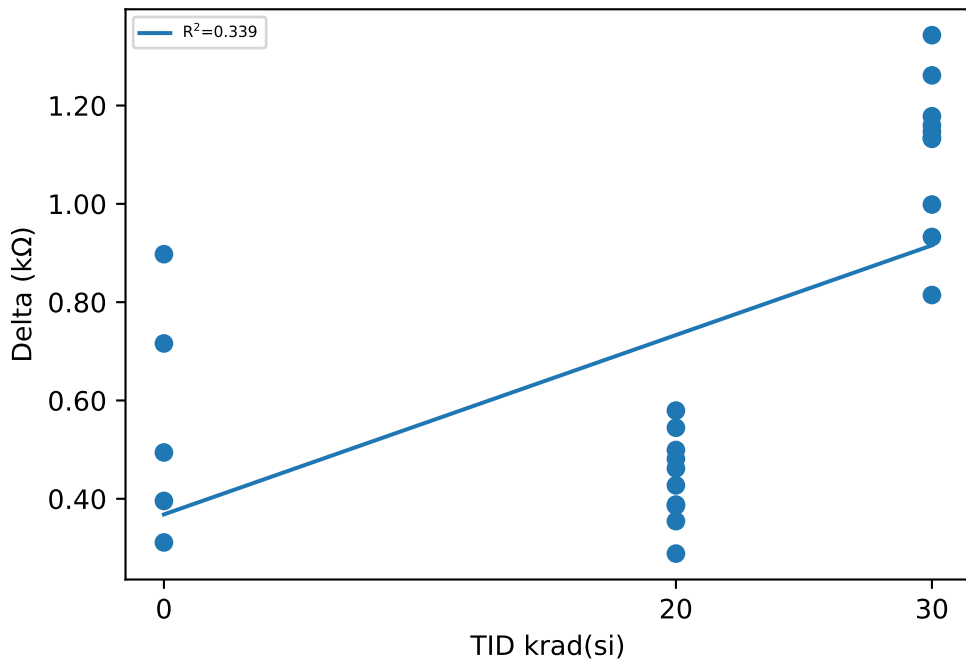

Test Statistics (kΩ)

krad(si)	Pre Exposure Min	Pre Exposure Avg	Pre Exposure Max	Pre Exposure Std	Post Exposure Min	Post Exposure Avg	Post Exposure Max	Post Exposure Std	Min Delta	Avg Delta	Max Delta	Std Delta
0	173.31	174.51	175.27	0.74028	174.03	175.08	176.17	0.78916	0.3112	0.56292	0.8976	0.24059
20	173.92	175.17	176.21	0.80224	174.3	175.61	176.56	0.77523	0.2885	0.44105	0.5794	0.089464
30	173.34	174.84	176.28	0.95087	174.27	175.95	177.44	1.021	0.8145	1.1103	1.3431	0.15567

Device Test: 7.23 UJQE20(EN2_Pulldown_Resistor_UJQE20)

TID vs Result Stats

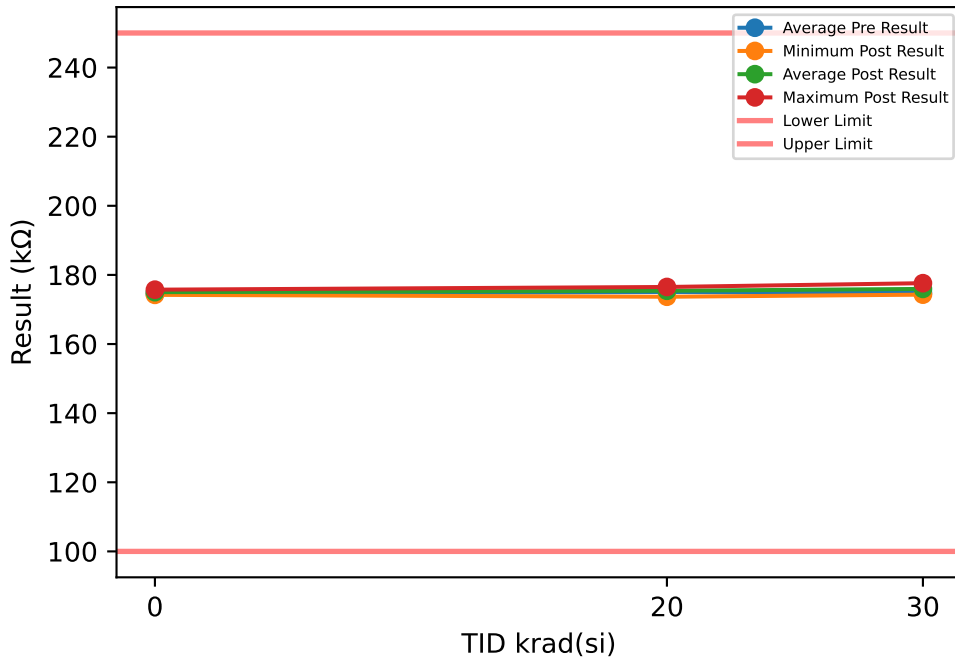

TID vs Post - Pre Exposure Delta

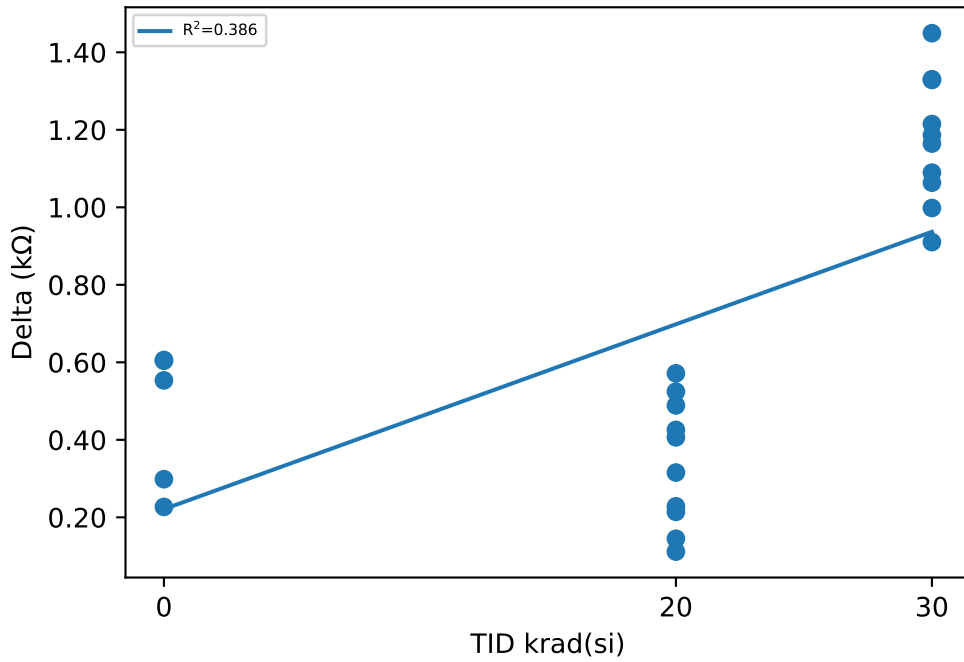

Test Results (Lower Limit = 100.0, Upper Limit = 250.0 (kΩ))

Serial #	krad(si)	Exposure Conditions	Pre Result	Post Result	Delta
50	20	LDR biased	175.99	176.51	0.5244
51	20	LDR biased	175.36	175.77	0.4064
52	20	LDR biased	174.65	174.88	0.2285
53	20	LDR biased	176.18	176.29	0.1116
54	20	LDR biased	175.7	176.01	0.3156
55	30	LDR biased	174.65	175.56	0.9103
56	30	LDR biased	174.24	175.41	1.1645
57	30	LDR biased	175.74	176.74	0.9982
58	30	LDR biased	174.98	176.17	1.186
59	30	LDR biased	174.76	175.98	1.2148
60	20	LDR unbiased	173.47	173.68	0.2142
61	20	LDR unbiased	175.15	175.3	0.1448
62	20	LDR unbiased	175.79	176.22	0.4256
63	20	LDR unbiased	174.56	175.13	0.5716
64	20	LDR unbiased	173.82	174.31	0.4888
65	30	LDR unbiased	175.5	176.83	1.3287
66	30	LDR unbiased	173.2	174.29	1.0894
67	30	LDR unbiased	174.35	175.42	1.0636
68	30	LDR unbiased	176.16	177.61	1.4493
69	30	LDR unbiased	174.17	175.5	1.3304
70	0	correlation	175.13	175.73	0.6041
71	0	correlation	174.33	174.94	0.6061
72	0	correlation	173.93	174.23	0.2984
73	0	correlation	174.58	174.8	0.2269
74	0	correlation	174.78	175.33	0.5534

Test Statistics (kΩ)

krad(si)	Pre Exposure Min	Pre Exposure Avg	Pre Exposure Max	Pre Exposure Std	Post Exposure Min	Post Exposure Avg	Post Exposure Max	Post Exposure Std	Min Delta	Avg Delta	Max Delta	Std Delta
0	173.93	174.55	175.13	0.45254	174.23	175.01	175.73	0.56635	0.2269	0.45778	0.6061	0.18115
20	173.47	175.07	176.18	0.92115	173.68	175.41	176.51	0.92479	0.1116	0.34315	0.5716	0.16348
30	173.2	174.78	176.16	0.86582	174.29	175.95	177.61	0.93618	0.9103	1.1735	1.4493	0.16528

Device Test: 7.24 UJQE20(EN3_Pulldown_Resistor_UJQE20)

TID vs Result Stats

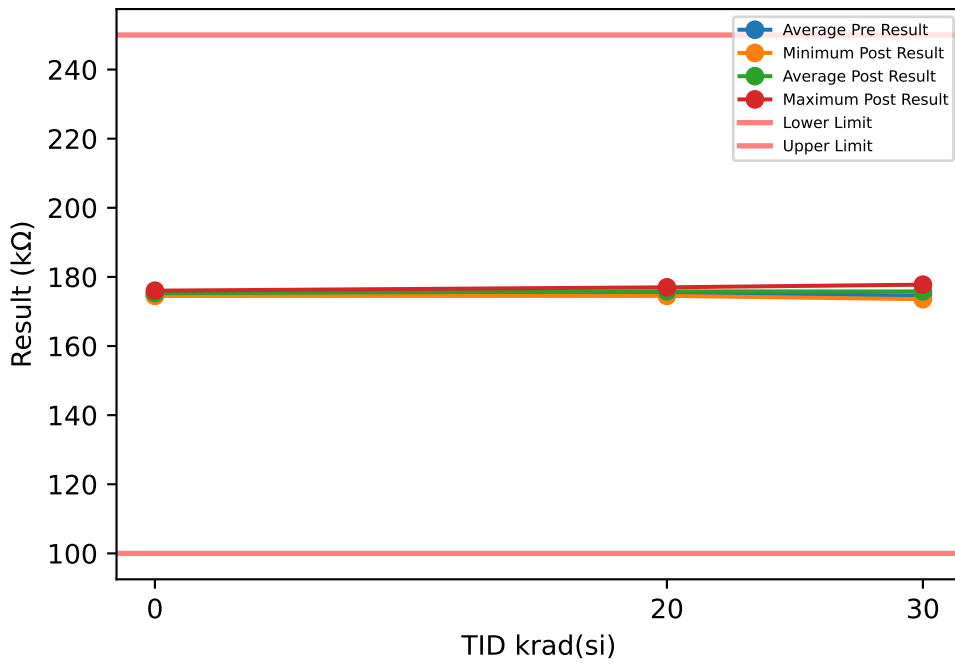

Test Results (Lower Limit = 100.0, Upper Limit = 250.0 (kΩ))

Serial #	krad(si)	Exposure Conditions	Pre Result	Post Result	Delta
50	20	LDR biased	176.28	176.99	0.7112
51	20	LDR biased	175.64	176.21	0.5665
52	20	LDR biased	174.76	175.27	0.5151
53	20	LDR biased	175.73	176.32	0.5849
54	20	LDR biased	175.79	176.1	0.3042
55	30	LDR biased	174.84	176.17	1.3259
56	30	LDR biased	174.27	175.64	1.3704
57	30	LDR biased	174.05	175.26	1.2101
58	30	LDR biased	175.53	176.4	0.8761
59	30	LDR biased	174.87	175.82	0.9507
60	20	LDR unbiased	174.57	175.14	0.5741
61	20	LDR unbiased	174.89	175.64	0.7483
62	20	LDR unbiased	176.56	176.88	0.3191
63	20	LDR unbiased	174.8	175.26	0.4638
64	20	LDR unbiased	173.78	174.52	0.7358
65	30	LDR unbiased	175.34	176.76	1.4131
66	30	LDR unbiased	172.46	173.55	1.0972
67	30	LDR unbiased	174.27	175.2	0.9298
68	30	LDR unbiased	176.43	177.76	1.3297
69	30	LDR unbiased	174.13	175.32	1.1893
70	0	correlation	175.55	176.02	0.4736
71	0	correlation	174.64	175.2	0.5593
72	0	correlation	173.8	174.5	0.7001
73	0	correlation	174.48	175.41	0.9258
74	0	correlation	174.94	175.34	0.4099

TID vs Post - Pre Exposure Delta

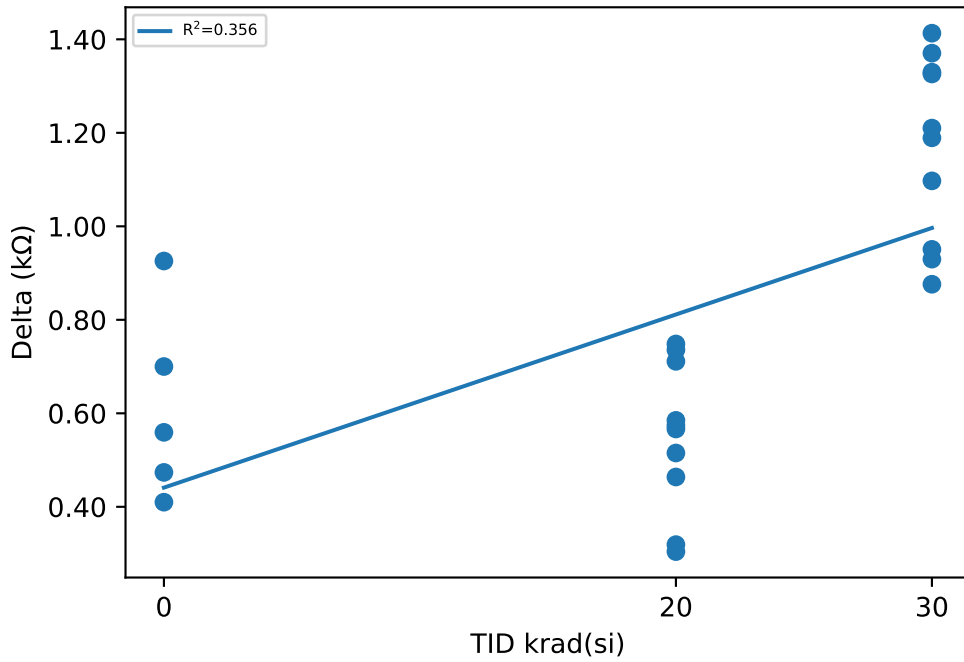

Test Statistics (kΩ)

krad(si)	Pre Exposure Min	Pre Exposure Avg	Pre Exposure Max	Pre Exposure Std	Post Exposure Min	Post Exposure Avg	Post Exposure Max	Post Exposure Std	Min Delta	Avg Delta	Max Delta	Std Delta
0	173.8	174.68	175.55	0.6391	174.5	175.3	176.02	0.54372	0.4099	0.61374	0.9258	0.20554
20	173.78	175.28	176.56	0.86054	174.52	175.83	176.99	0.80158	0.3042	0.5523	0.7483	0.15784
30	172.46	174.62	176.43	1.0654	173.55	175.79	177.76	1.1155	0.8761	1.1692	1.4131	0.19678

Device Test: 7.25 UJQE20(EN4_Pulldown_Resistor_UJQE20)

TID vs Result Stats

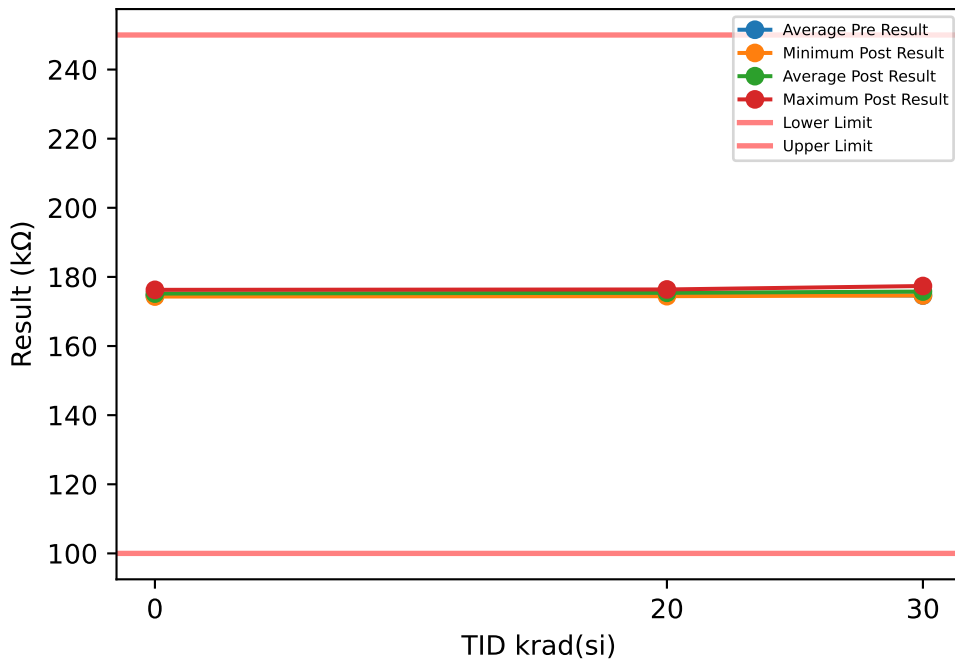

TID vs Post - Pre Exposure Delta

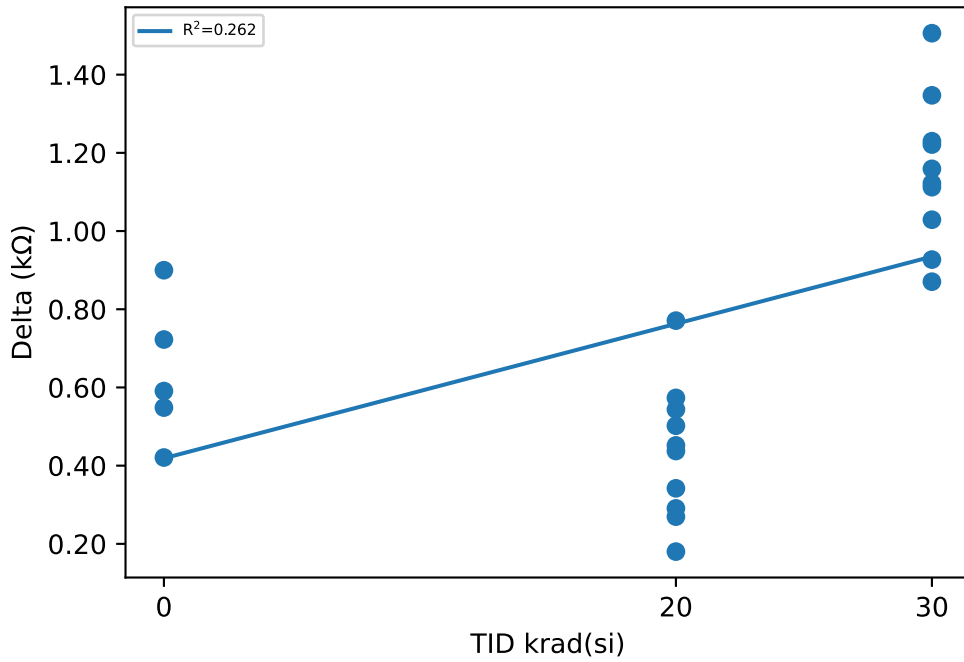

Test Results (Lower Limit = 100.0, Upper Limit = 250.0 (kΩ))

Serial #	krad(si)	Exposure Conditions	Pre Result	Post Result	Delta
50	20	LDR biased	175.52	175.96	0.4374
51	20	LDR biased	175.68	175.86	0.1802
52	20	LDR biased	174.53	174.87	0.342
53	20	LDR biased	175.68	176.18	0.5021
54	20	LDR biased	175.3	175.59	0.2907
55	30	LDR biased	174.81	175.74	0.927
56	30	LDR biased	174.47	175.63	1.1591
57	30	LDR biased	175.47	176.7	1.2297
58	30	LDR biased	174.75	175.86	1.1122
59	30	LDR biased	174.56	175.59	1.029
60	20	LDR unbiased	174.36	174.63	0.2696
61	20	LDR unbiased	174.51	175.28	0.7709
62	20	LDR unbiased	175.8	176.37	0.5733
63	20	LDR unbiased	174.43	174.88	0.4518
64	20	LDR unbiased	173.88	174.42	0.5438
65	30	LDR unbiased	174.88	176.23	1.3471
66	30	LDR unbiased	173.4	174.62	1.2212
67	30	LDR unbiased	174.3	175.17	0.8705
68	30	LDR unbiased	176.25	177.37	1.1221
69	30	LDR unbiased	173.26	174.77	1.506
70	0	correlation	175.36	176.26	0.8998
71	0	correlation	174.48	175.03	0.5485
72	0	correlation	173.73	174.32	0.5908
73	0	correlation	174.52	175.24	0.7226
74	0	correlation	174.63	175.05	0.4208

Test Statistics (kΩ)

krad(si)	Pre Exposure Min	Pre Exposure Avg	Pre Exposure Max	Pre Exposure Std	Post Exposure Min	Post Exposure Avg	Post Exposure Max	Post Exposure Std	Min Delta	Avg Delta	Max Delta	Std Delta
0	173.73	174.54	175.36	0.58141	174.32	175.18	176.26	0.70047	0.4208	0.6365	0.8998	0.18241
20	173.88	174.97	175.8	0.69662	174.42	175.4	176.37	0.68521	0.1802	0.43618	0.7709	0.17331
30	173.26	174.61	176.25	0.87905	174.62	175.77	177.37	0.84188	0.8705	1.1524	1.506	0.18907

Device Test: 7.26 UJQE20(SEH_Pulldown_Resistor_UJQE20)

TID vs Result Stats

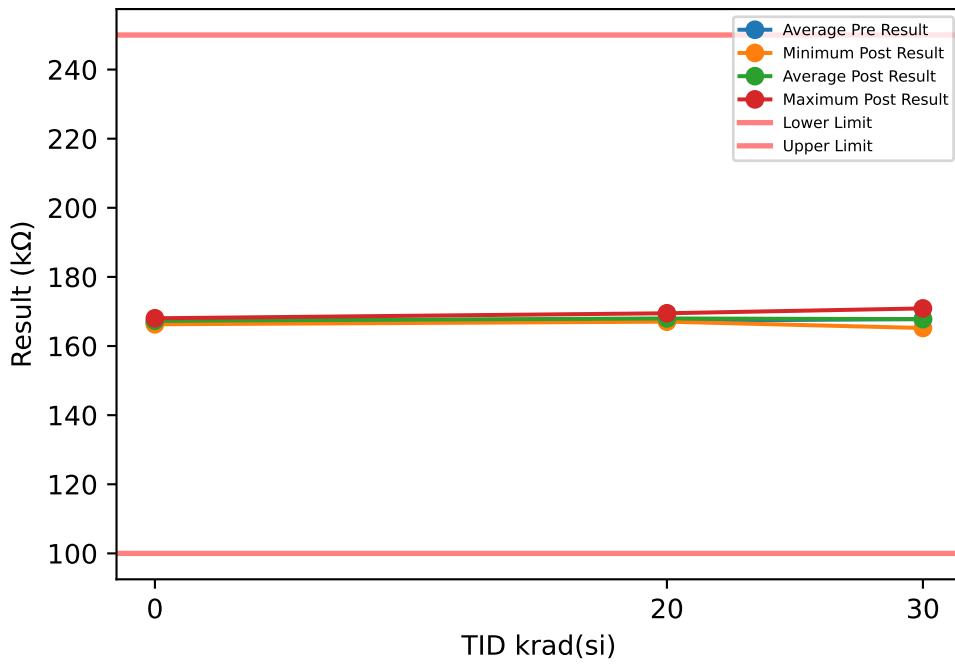

Test Results (Lower Limit = 100.0, Upper Limit = 250.0 (kΩ))

Serial #	krad(si)	Exposure Conditions	Pre Result	Post Result	Delta
50	20	LDR biased	167.27	169.48	2.2139
51	20	LDR biased	167.18	168.81	1.6326
52	20	LDR biased	167.27	167.71	0.4344
53	20	LDR biased	168.53	168.59	0.0599
54	20	LDR biased	169.37	168.26	-1.1127
55	30	LDR biased	167.94	167.71	-0.2396
56	30	LDR biased	168.15	167.38	-0.7696
57	30	LDR biased	169.42	170.89	1.4693
58	30	LDR biased	167.16	168.15	0.9877
59	30	LDR biased	167.07	166.18	-0.884
60	20	LDR unbiased	165.65	167.6	1.9481
61	20	LDR unbiased	169.53	167.05	-2.4836
62	20	LDR unbiased	167.71	167.81	0.1099
63	20	LDR unbiased	165.45	167.16	1.7067
64	20	LDR unbiased	165.11	167.38	2.2633
65	30	LDR unbiased	168.64	169.59	0.9536
66	30	LDR unbiased	166.4	165.22	-1.1779
67	30	LDR unbiased	166.96	166.66	-0.2958
68	30	LDR unbiased	168.04	169.15	1.1057
69	30	LDR unbiased	168.2	166.83	-1.3618
70	0	correlation	167.71	167.81	0.1099
71	0	correlation	167.51	168.04	0.5296
72	0	correlation	164.37	166.29	1.9186
73	0	correlation	166.66	166.72	0.0582
74	0	correlation	167.16	167.71	0.5473

TID vs Post - Pre Exposure Delta

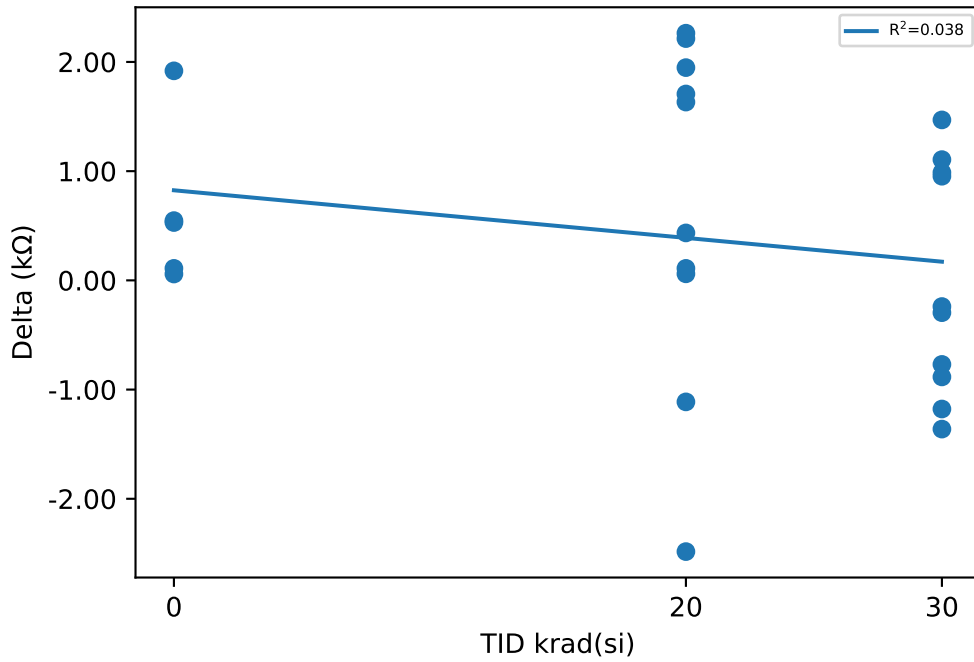

Test Statistics (kΩ)

krad(si)	Pre Exposure Min	Pre Exposure Avg	Pre Exposure Max	Pre Exposure Std	Post Exposure Min	Post Exposure Avg	Post Exposure Max	Post Exposure Std	Min Delta	Avg Delta	Max Delta	Std Delta
0	164.37	166.68	167.71	1.3503	166.29	167.31	168.04	0.76216	0.0582	0.63272	1.9186	0.75413
20	165.11	167.31	169.53	1.5594	167.05	167.98	169.48	0.78505	-2.4836	0.67725	2.2633	1.5784
30	166.4	167.8	169.42	0.90103	165.22	167.78	170.89	1.7113	-1.3618	-0.02124	1.4693	1.0553

Device Test: 7.27 UJQE20(SEL_Pulldown_Resistor_UJQE20)

TID vs Result Stats

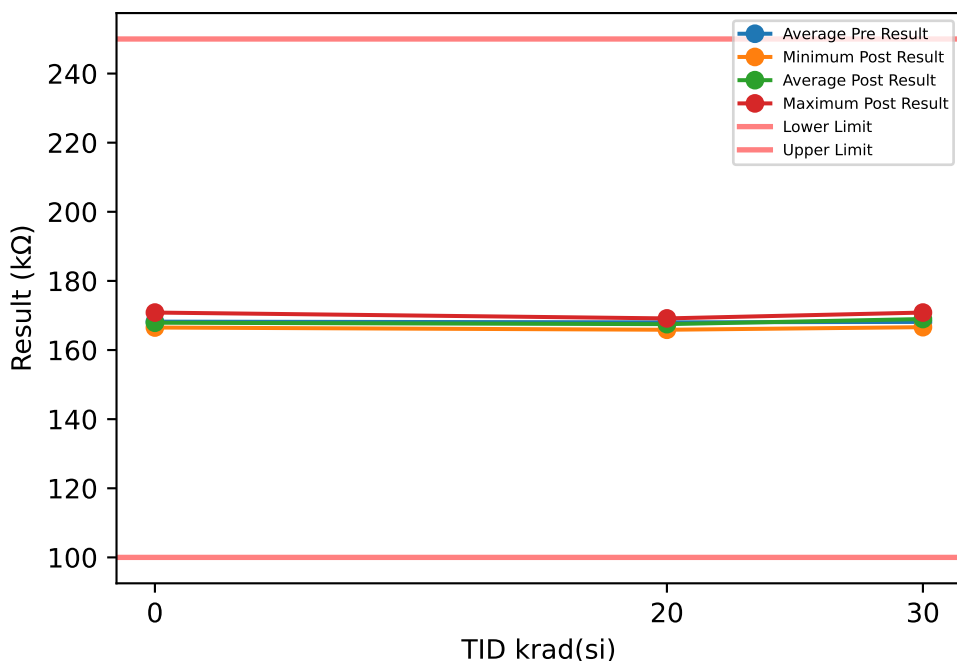

TID vs Post - Pre Exposure Delta

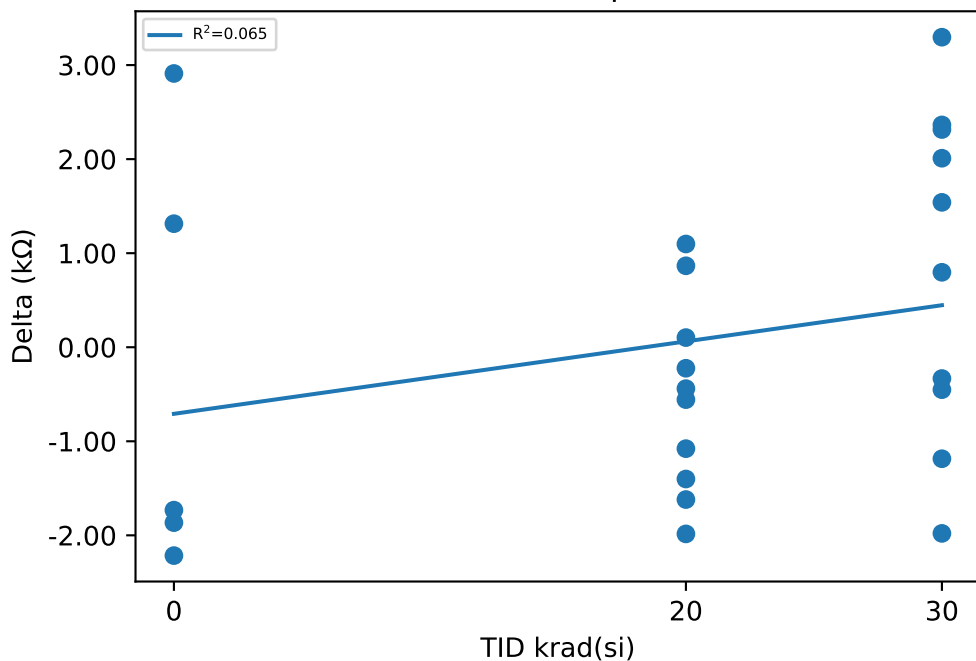

Test Results (Lower Limit = 100.0, Upper Limit = 250.0 (kΩ))

Serial #	krad(si)	Exposure Conditions	Pre Result	Post Result	Delta
50	20	LDR biased	169.38	169.15	-0.2236
51	20	LDR biased	169.81	167.82	-1.9848
52	20	LDR biased	167.27	165.87	-1.4011
53	20	LDR biased	167.61	167.71	0.1025
54	20	LDR biased	169.26	168.71	-0.5571
55	30	LDR biased	169.58	167.6	-1.9794
56	30	LDR biased	167.05	168.59	1.5405
57	30	LDR biased	170.17	169.72	-0.4512
58	30	LDR biased	168.15	170.16	2.0097
59	30	LDR biased	168.91	169.71	0.7968
60	20	LDR unbiased	167.27	166.19	-1.0784
61	20	LDR unbiased	166.74	167.6	0.866
62	20	LDR unbiased	168.15	167.71	-0.4402
63	20	LDR unbiased	168.03	166.41	-1.6195
64	20	LDR unbiased	166.62	167.71	1.0976
65	30	LDR unbiased	167.17	169.49	2.3149
66	30	LDR unbiased	166.95	166.62	-0.3328
67	30	LDR unbiased	168.47	167.28	-1.1856
68	30	LDR unbiased	168.48	170.84	2.3637
69	30	LDR unbiased	166.41	169.71	3.2965
70	0	correlation	167.93	170.84	2.9108
71	0	correlation	168.25	166.51	-1.7321
72	0	correlation	168.81	166.95	-1.8651
73	0	correlation	169.27	167.06	-2.2155
74	0	correlation	166.84	168.15	1.3137

Test Statistics (kΩ)

krad(si)	Pre Exposure Min	Pre Exposure Avg	Pre Exposure Max	Pre Exposure Std	Post Exposure Min	Post Exposure Avg	Post Exposure Max	Post Exposure Std	Min Delta	Avg Delta	Max Delta	Std Delta
0	166.84	168.22	169.27	0.92854	166.51	167.9	170.84	1.7511	-2.2155	-0.31764	2.9108	2.2957
20	166.62	168.01	169.81	1.131	165.87	167.49	169.15	1.0547	-1.9848	-0.52386	1.0976	1.0254
30	166.41	168.14	170.17	1.2274	166.62	168.97	170.84	1.3849	-1.9794	0.83731	3.2965	1.7476

Device Test: 7.28 UJQE20(THER_Pulldown_Resistor_UJQE20)

TID vs Result Stats

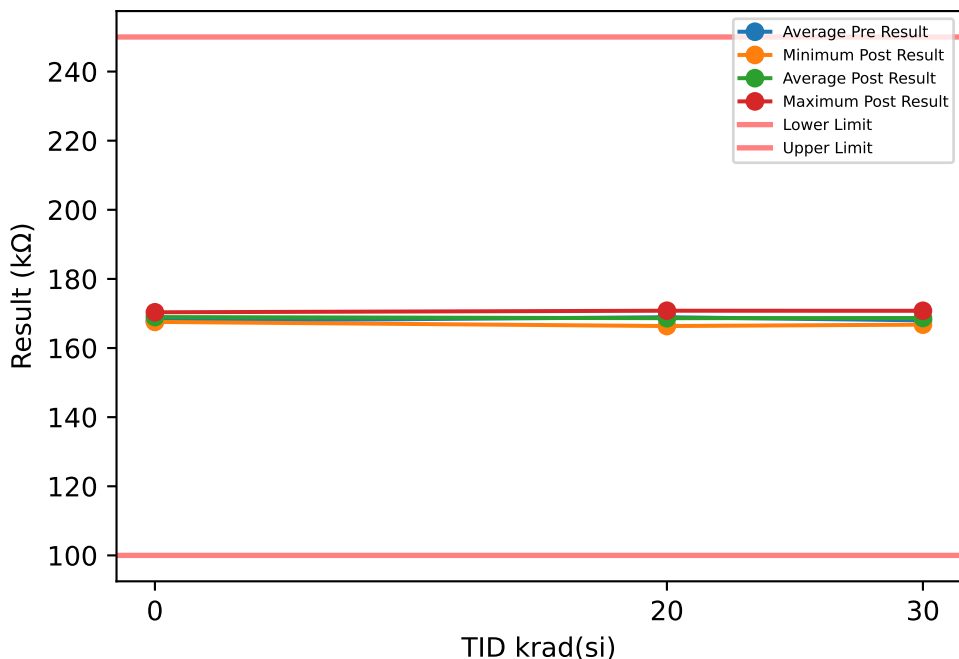

Test Results (Lower Limit = 100.0, Upper Limit = 250.0 (kΩ))

Serial #	krad(si)	Exposure Conditions	Pre Result	Post Result	Delta
50	20	LDR biased	169.44	168.44	-1.0021
51	20	LDR biased	169.06	168	-1.0564
52	20	LDR biased	168.64	168.55	-0.0876
53	20	LDR biased	170.19	170.8	0.609
54	20	LDR biased	169	168.77	-0.2226
55	30	LDR biased	166.96	168.66	1.6996
56	30	LDR biased	167.53	170.78	3.2422
57	30	LDR biased	168.29	169.85	1.5571
58	30	LDR biased	168.88	168.44	-0.4439
59	30	LDR biased	167.51	168.08	0.5768
60	20	LDR unbiased	169.42	166.36	-3.0569
61	20	LDR unbiased	167.42	168.66	1.2454
62	20	LDR unbiased	169.11	170.57	1.4628
63	20	LDR unbiased	168.39	167.78	-0.6098
64	20	LDR unbiased	168.53	168.44	-0.0873
65	30	LDR unbiased	168.85	170.12	1.2707
66	30	LDR unbiased	165.83	166.77	0.9452
67	30	LDR unbiased	167.51	167.63	0.1269
68	30	LDR unbiased	170.55	169.33	-1.2188
69	30	LDR unbiased	168.18	167.21	-0.9772
70	0	correlation	168	170.34	2.3444
71	0	correlation	167.62	167.56	-0.0582
72	0	correlation	165.91	168.22	2.3139
73	0	correlation	168.18	170.23	2.0466
74	0	correlation	169.33	168.44	-0.8902

TID vs Post - Pre Exposure Delta

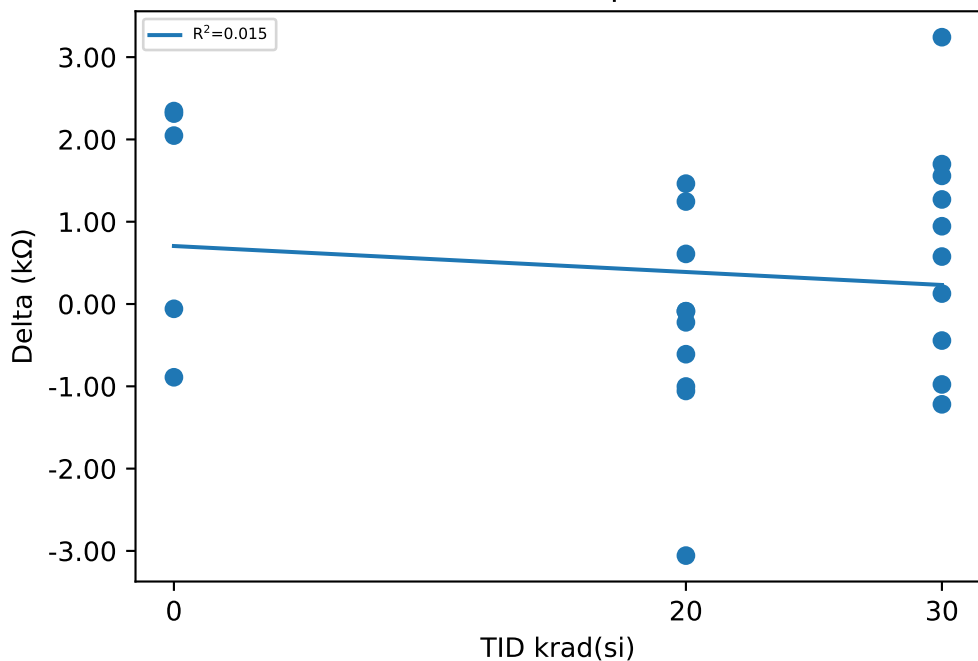

Test Statistics (kΩ)

krad(si)	Pre Exposure Min	Pre Exposure Avg	Pre Exposure Max	Pre Exposure Std	Post Exposure Min	Post Exposure Avg	Post Exposure Max	Post Exposure Std	Min Delta	Avg Delta	Max Delta	Std Delta
0	165.91	167.81	169.33	1.2401	167.56	168.96	170.34	1.2556	-0.8902	1.1513	2.3444	1.5172
20	167.42	168.92	170.19	0.74282	166.36	168.64	170.8	1.2832	-3.0569	-0.28055	1.4628	1.2986
30	165.83	168.01	170.55	1.2747	166.77	168.69	170.78	1.3156	-1.2188	0.67786	3.2422	1.3632

Device Test: 7.29 UJCQ9J(DIAG_Pulldown_Resistor_UJCQ9J)

TID vs Result Stats

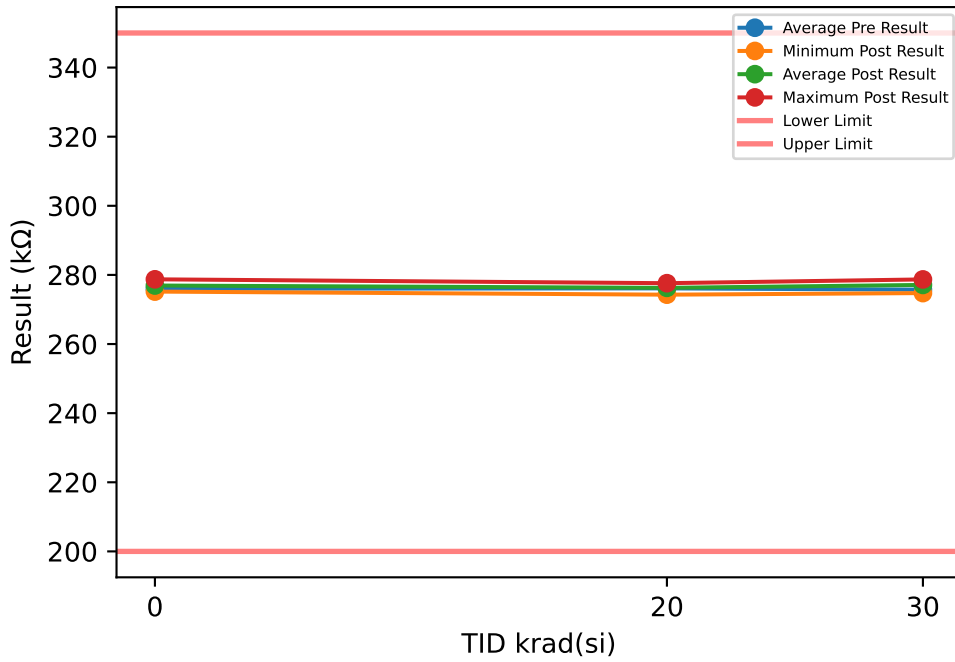

Test Results (Lower Limit = 200.0, Upper Limit = 350.0 (kΩ))

Serial #	krad(si)	Exposure Conditions	Pre Result	Post Result	Delta
50	20	LDR biased	277.21	277.6	0.3929
51	20	LDR biased	276.3	276.76	0.4552
52	20	LDR biased	276.05	276.34	0.2871
53	20	LDR biased	276.05	275.95	-0.0988
54	20	LDR biased	277.06	277.12	0.0603
55	30	LDR biased	276.79	278.7	1.9132
56	30	LDR biased	275.51	276.71	1.1979
57	30	LDR biased	277.31	278.62	1.3045
58	30	LDR biased	276.88	278.67	1.7877
59	30	LDR biased	275.41	276.89	1.4846
60	20	LDR unbiased	274.53	274.76	0.2251
61	20	LDR unbiased	277.58	277.36	-0.2205
62	20	LDR unbiased	276.94	277.06	0.1205
63	20	LDR unbiased	274.19	274.29	0.0928
64	20	LDR unbiased	275.07	275.35	0.2853
65	30	LDR unbiased	276.38	278	1.6202
66	30	LDR unbiased	274.52	275.81	1.2909
67	30	LDR unbiased	275.08	276.62	1.5374
68	30	LDR unbiased	275.6	276.28	0.6754
69	30	LDR unbiased	273.88	274.74	0.8596
70	0	correlation	277.73	278.73	1.0031
71	0	correlation	276.97	277.82	0.8509
72	0	correlation	274.5	275.17	0.6704
73	0	correlation	276.17	277	0.8321
74	0	correlation	274.67	275.95	1.2799

TID vs Post - Pre Exposure Delta

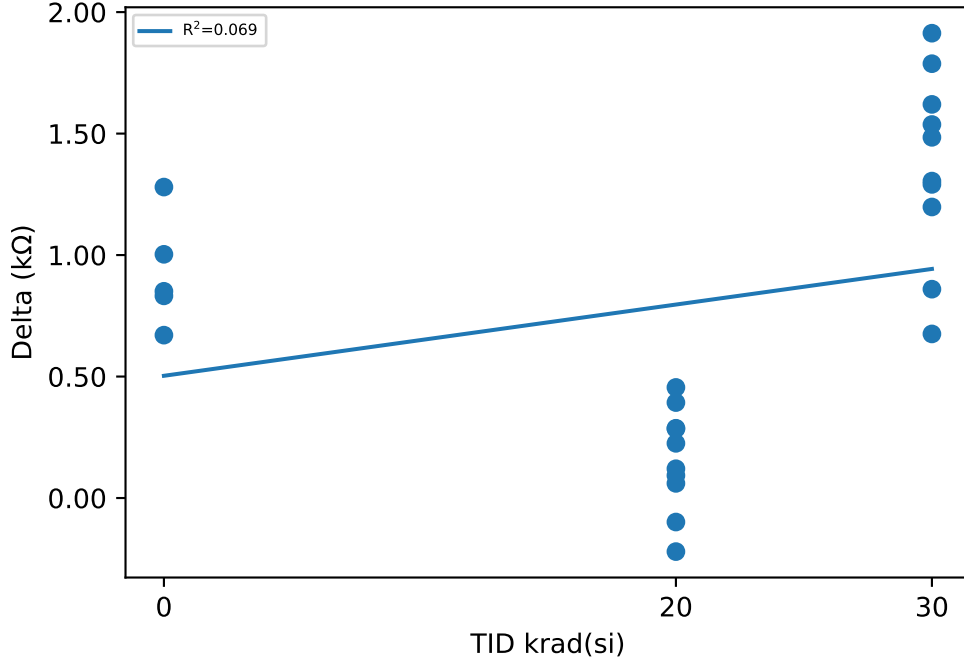

Test Statistics (kΩ)

krad(si)	Pre Exposure Min	Pre Exposure Avg	Pre Exposure Max	Pre Exposure Std	Post Exposure Min	Post Exposure Avg	Post Exposure Max	Post Exposure Std	Min Delta	Avg Delta	Max Delta	Std Delta
0	274.5	276.01	277.73	1.4093	275.17	276.93	278.73	1.4202	0.6704	0.92728	1.2799	0.22966
20	274.19	276.1	277.58	1.1675	274.29	276.26	277.6	1.1418	-0.2205	0.15999	0.4552	0.2122
30	273.88	275.74	277.31	1.0964	274.74	277.1	278.7	1.3514	0.6754	1.3671	1.9132	0.38821

Device Test: 7.401 UJTCWZ(EN2_Logic_High_Go-No-Go_UJTCWZ)

TID vs Result Stats

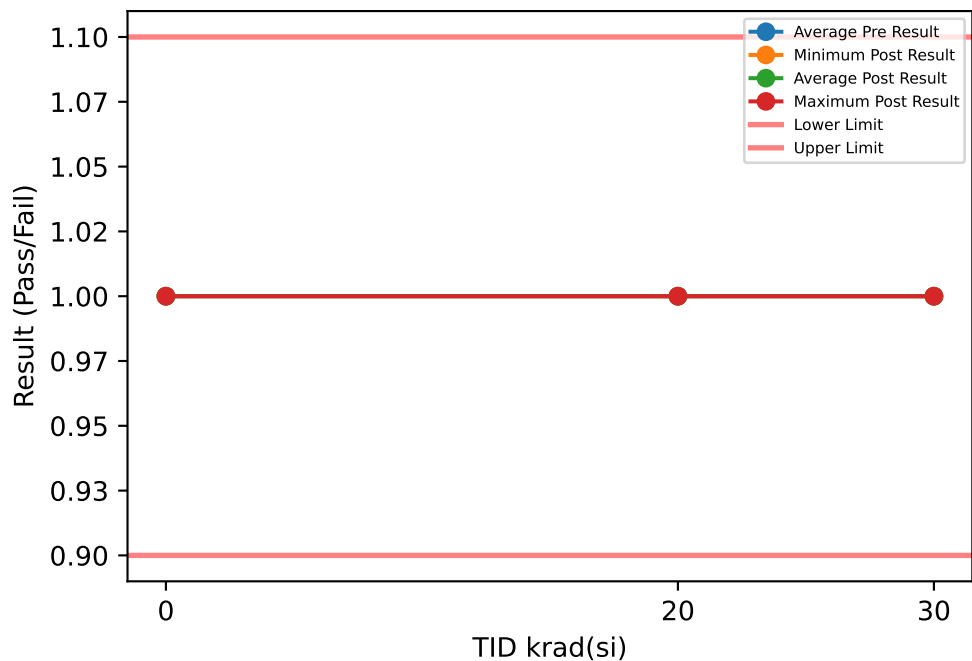

TID vs Post - Pre Exposure Delta

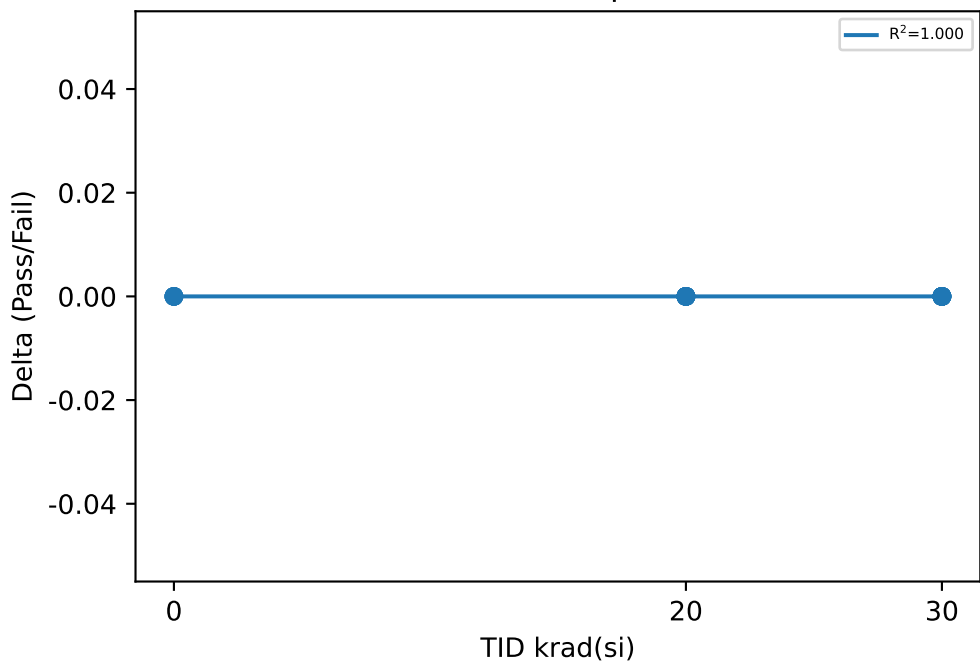

Test Results (Lower Limit = 0.9, Upper Limit = 1.1 (Pass/Fail))

Serial #	krad(si)	Exposure Conditions	Pre Result	Post Result	Delta
50	20	LDR biased	1	1	0
51	20	LDR biased	1	1	0
52	20	LDR biased	1	1	0
53	20	LDR biased	1	1	0
54	20	LDR biased	1	1	0
55	30	LDR biased	1	1	0
56	30	LDR biased	1	1	0
57	30	LDR biased	1	1	0
58	30	LDR biased	1	1	0
59	30	LDR biased	1	1	0
60	20	LDR unbiased	1	1	0
61	20	LDR unbiased	1	1	0
62	20	LDR unbiased	1	1	0
63	20	LDR unbiased	1	1	0
64	20	LDR unbiased	1	1	0
65	30	LDR unbiased	1	1	0
66	30	LDR unbiased	1	1	0
67	30	LDR unbiased	1	1	0
68	30	LDR unbiased	1	1	0
69	30	LDR unbiased	1	1	0
70	0	correlation	1	1	0
71	0	correlation	1	1	0
72	0	correlation	1	1	0
73	0	correlation	1	1	0
74	0	correlation	1	1	0

Test Statistics (Pass/Fail)

krad(si)	Pre Exposure Min	Pre Exposure Avg	Pre Exposure Max	Pre Exposure Std	Post Exposure Min	Post Exposure Avg	Post Exposure Max	Post Exposure Std	Min Delta	Avg Delta	Max Delta	Std Delta
0	1	1	1	0	1	1	1	0	0	0	0	0
20	1	1	1	0	1	1	1	0	0	0	0	0
30	1	1	1	0	1	1	1	0	0	0	0	0

Device Test: 7.501 UJVVXI(EN2_Logic_Low_Go-No-Go_UJVVXI)

TID vs Result Stats

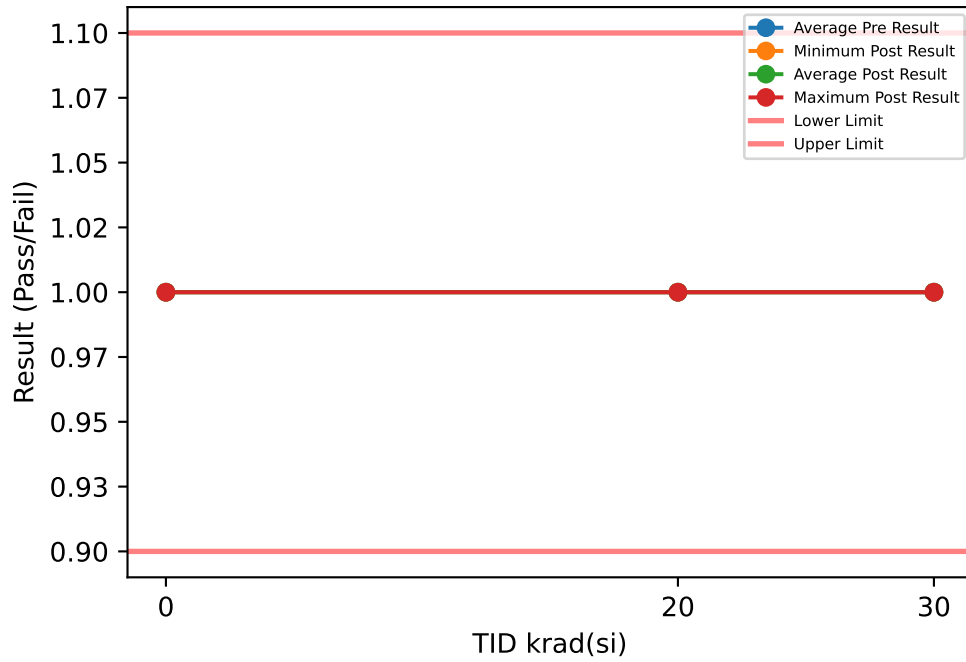

Test Results (Lower Limit = 0.9, Upper Limit = 1.1 (Pass/Fail))

Serial #	krad(si)	Exposure Conditions	Pre Result	Post Result	Delta
50	20	LDR biased	1	1	0
51	20	LDR biased	1	1	0
52	20	LDR biased	1	1	0
53	20	LDR biased	1	1	0
54	20	LDR biased	1	1	0
55	30	LDR biased	1	1	0
56	30	LDR biased	1	1	0
57	30	LDR biased	1	1	0
58	30	LDR biased	1	1	0
59	30	LDR biased	1	1	0
60	20	LDR unbiased	1	1	0
61	20	LDR unbiased	1	1	0
62	20	LDR unbiased	1	1	0
63	20	LDR unbiased	1	1	0
64	20	LDR unbiased	1	1	0
65	30	LDR unbiased	1	1	0
66	30	LDR unbiased	1	1	0
67	30	LDR unbiased	1	1	0
68	30	LDR unbiased	1	1	0
69	30	LDR unbiased	1	1	0
70	0	correlation	1	1	0
71	0	correlation	1	1	0
72	0	correlation	1	1	0
73	0	correlation	1	1	0
74	0	correlation	1	1	0

TID vs Post - Pre Exposure Delta

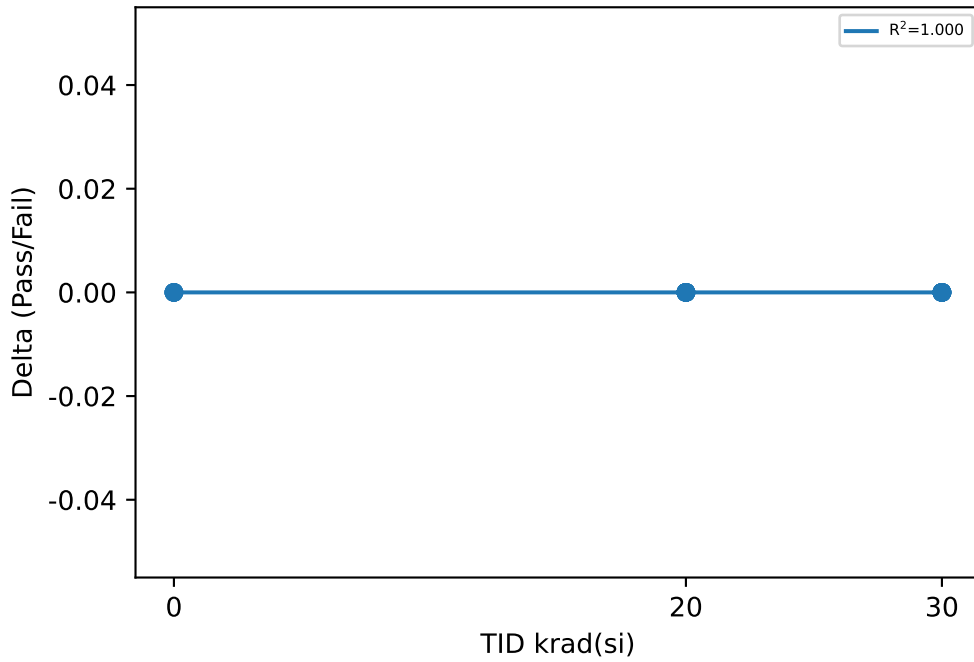

Test Statistics (Pass/Fail)

krad(si)	Pre Exposure Min	Pre Exposure Avg	Pre Exposure Max	Pre Exposure Std	Post Exposure Min	Post Exposure Avg	Post Exposure Max	Post Exposure Std	Min Delta	Avg Delta	Max Delta	Std Delta
0	1	1	1	0	1	1	1	0	0	0	0	0
20	1	1	1	0	1	1	1	0	0	0	0	0
30	1	1	1	0	1	1	1	0	0	0	0	0

Device Test: 7.701 UJTCWZ(EN3_Logic_High_Go-No-Go_UJTCWZ)

TID vs Result Stats

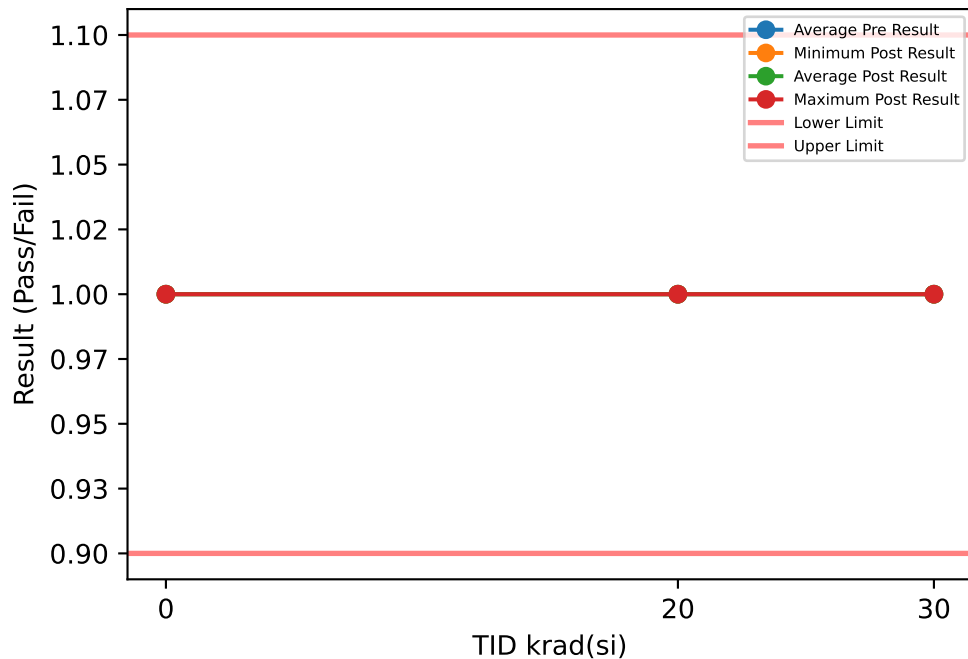

TID vs Post - Pre Exposure Delta

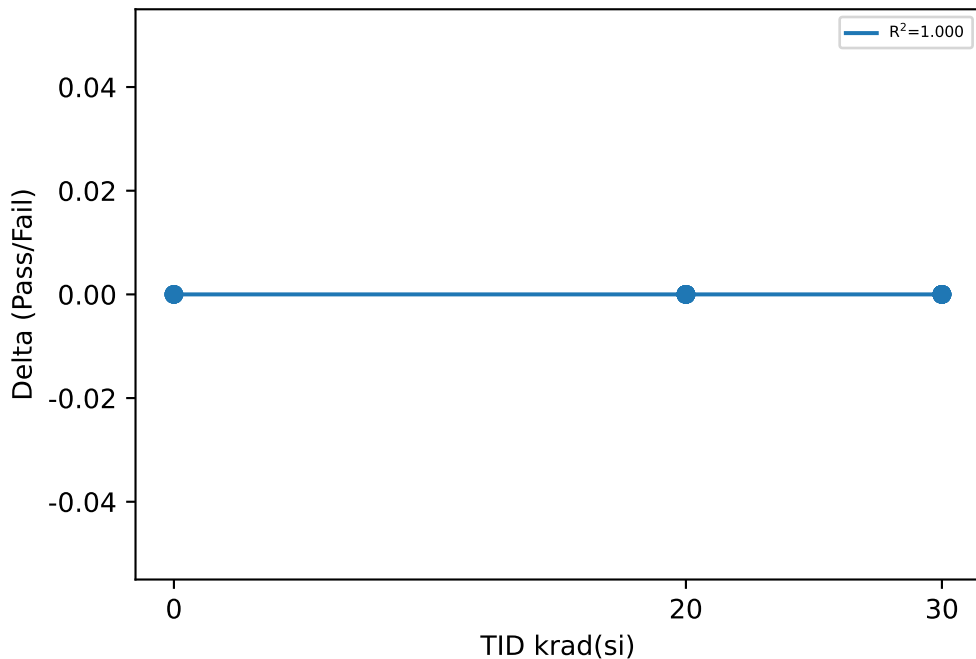

Test Results (Lower Limit = 0.9, Upper Limit = 1.1 (Pass/Fail))

Serial #	krad(si)	Exposure Conditions	Pre Result	Post Result	Delta
50	20	LDR biased	1	1	0
51	20	LDR biased	1	1	0
52	20	LDR biased	1	1	0
53	20	LDR biased	1	1	0
54	20	LDR biased	1	1	0
55	30	LDR biased	1	1	0
56	30	LDR biased	1	1	0
57	30	LDR biased	1	1	0
58	30	LDR biased	1	1	0
59	30	LDR biased	1	1	0
60	20	LDR unbiased	1	1	0
61	20	LDR unbiased	1	1	0
62	20	LDR unbiased	1	1	0
63	20	LDR unbiased	1	1	0
64	20	LDR unbiased	1	1	0
65	30	LDR unbiased	1	1	0
66	30	LDR unbiased	1	1	0
67	30	LDR unbiased	1	1	0
68	30	LDR unbiased	1	1	0
69	30	LDR unbiased	1	1	0
70	0	correlation	1	1	0
71	0	correlation	1	1	0
72	0	correlation	1	1	0
73	0	correlation	1	1	0
74	0	correlation	1	1	0

Test Statistics (Pass/Fail)

krad(si)	Pre Exposure Min	Pre Exposure Avg	Pre Exposure Max	Pre Exposure Std	Post Exposure Min	Post Exposure Avg	Post Exposure Max	Post Exposure Std	Min Delta	Avg Delta	Max Delta	Std Delta
0	1	1	1	0	1	1	1	0	0	0	0	0
20	1	1	1	0	1	1	1	0	0	0	0	0
30	1	1	1	0	1	1	1	0	0	0	0	0

Device Test: 7.801 UJVVXI(EN3_Logic_Low_Go-No-Go_UJVVXI)

TID vs Result Stats

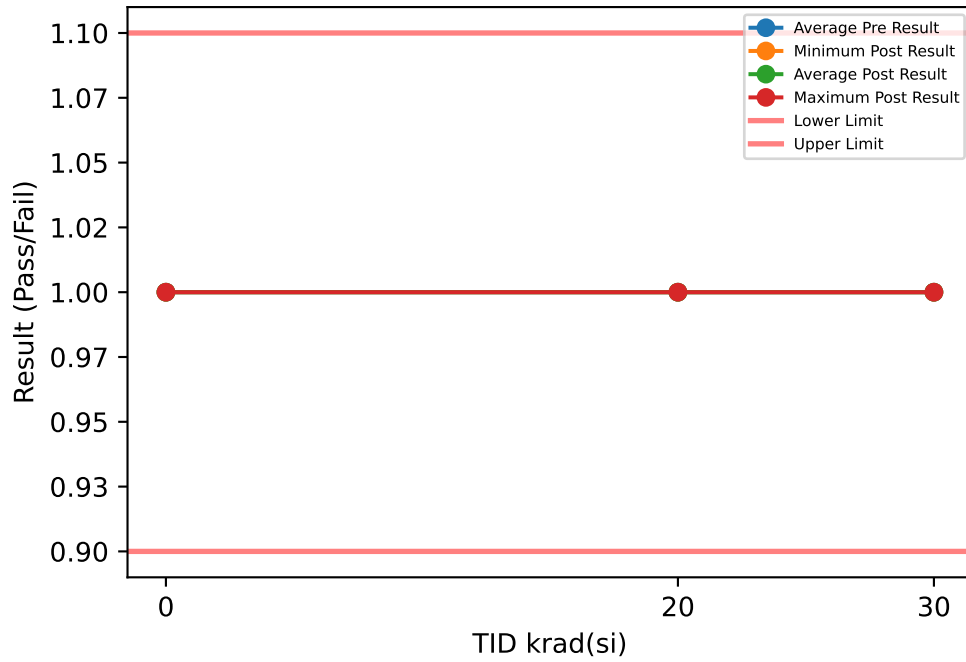

Test Results (Lower Limit = 0.9, Upper Limit = 1.1 (Pass/Fail))

Serial #	krad(si)	Exposure Conditions	Pre Result	Post Result	Delta
50	20	LDR biased	1	1	0
51	20	LDR biased	1	1	0
52	20	LDR biased	1	1	0
53	20	LDR biased	1	1	0
54	20	LDR biased	1	1	0
55	30	LDR biased	1	1	0
56	30	LDR biased	1	1	0
57	30	LDR biased	1	1	0
58	30	LDR biased	1	1	0
59	30	LDR biased	1	1	0
60	20	LDR unbiased	1	1	0
61	20	LDR unbiased	1	1	0
62	20	LDR unbiased	1	1	0
63	20	LDR unbiased	1	1	0
64	20	LDR unbiased	1	1	0
65	30	LDR unbiased	1	1	0
66	30	LDR unbiased	1	1	0
67	30	LDR unbiased	1	1	0
68	30	LDR unbiased	1	1	0
69	30	LDR unbiased	1	1	0
70	0	correlation	1	1	0
71	0	correlation	1	1	0
72	0	correlation	1	1	0
73	0	correlation	1	1	0
74	0	correlation	1	1	0

TID vs Post - Pre Exposure Delta

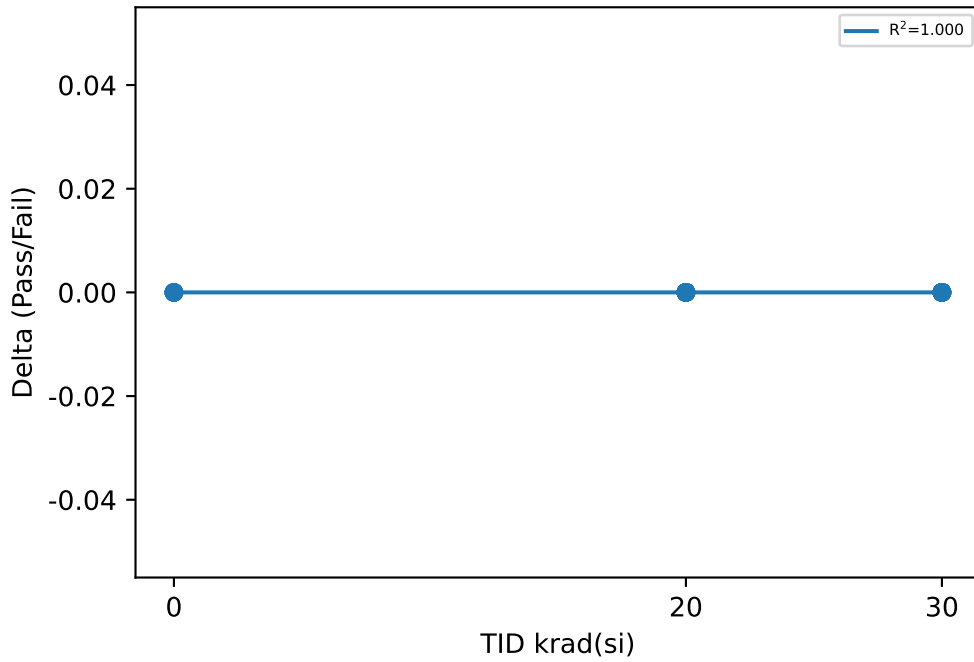

Test Statistics (Pass/Fail)

krad(si)	Pre Exposure Min	Pre Exposure Avg	Pre Exposure Max	Pre Exposure Std	Post Exposure Min	Post Exposure Avg	Post Exposure Max	Post Exposure Std	Min Delta	Avg Delta	Max Delta	Std Delta
0	1	1	1	0	1	1	1	0	0	0	0	0
20	1	1	1	0	1	1	1	0	0	0	0	0
30	1	1	1	0	1	1	1	0	0	0	0	0

Device Test: 8.1 UJEU7X(IOUT1_GroundLoss_UJEU7X)

TID vs Result Stats

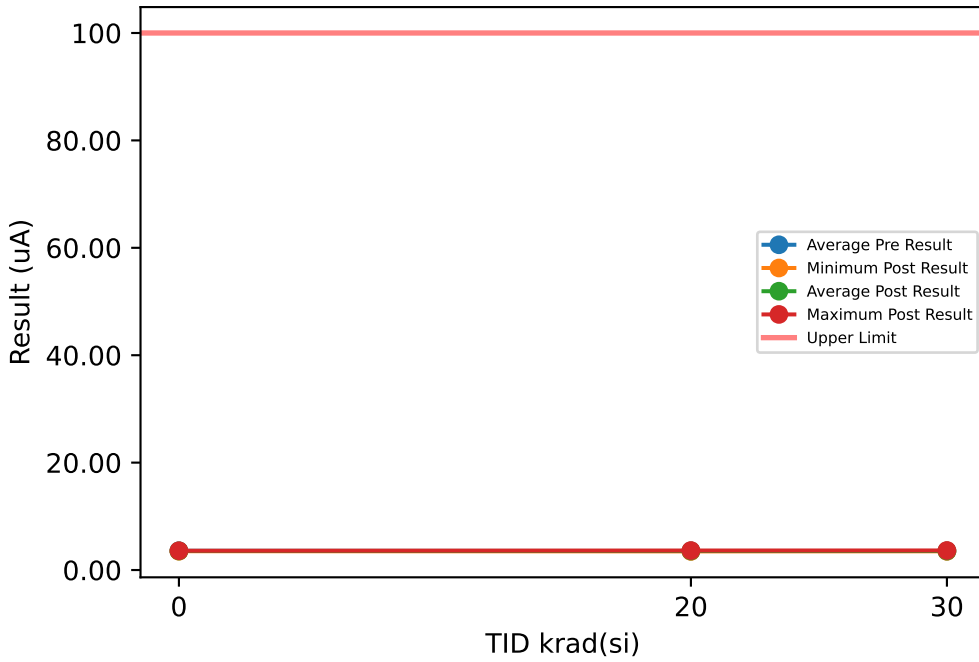

Test Results (Upper Limit = 100.0 (uA))

Serial #	krad(si)	Exposure Conditions	Pre Result	Post Result	Delta
50	20	LDR biased	3.5092	3.5484	0.0392
51	20	LDR biased	3.5071	3.5308	0.0237
52	20	LDR biased	3.5787	3.5622	-0.0165
53	20	LDR biased	3.4932	3.4699	-0.0233
54	20	LDR biased	3.5504	3.5622	0.0118
55	30	LDR biased	3.5503	3.5602	0.0099
56	30	LDR biased	3.5591	3.5748	0.0157
57	30	LDR biased	3.4991	3.5187	0.0196
58	30	LDR biased	3.5308	3.5288	-0.002
59	30	LDR biased	3.5051	3.5002	-0.0049
60	20	LDR unbiased	3.5846	3.5897	0.0051
61	20	LDR unbiased	3.5246	3.5386	0.014
62	20	LDR unbiased	3.5033	3.5406	0.0373
63	20	LDR unbiased	3.5189	3.5504	0.0315
64	20	LDR unbiased	3.5984	3.6309	0.0325
65	30	LDR unbiased	3.5305	3.519	-0.0115
66	30	LDR unbiased	3.6113	3.6436	0.0323
67	30	LDR unbiased	3.5169	3.5423	0.0254
68	30	LDR unbiased	3.5198	3.4856	-0.0342
69	30	LDR unbiased	3.5972	3.5807	-0.0165
70	0	correlation	3.5661	3.5288	-0.0373
71	0	correlation	3.4953	3.5013	0.006
72	0	correlation	3.6416	3.5956	-0.046
73	0	correlation	3.5756	3.5465	-0.0291
74	0	correlation	3.5995	3.5956	-0.0039

TID vs Post - Pre Exposure Delta

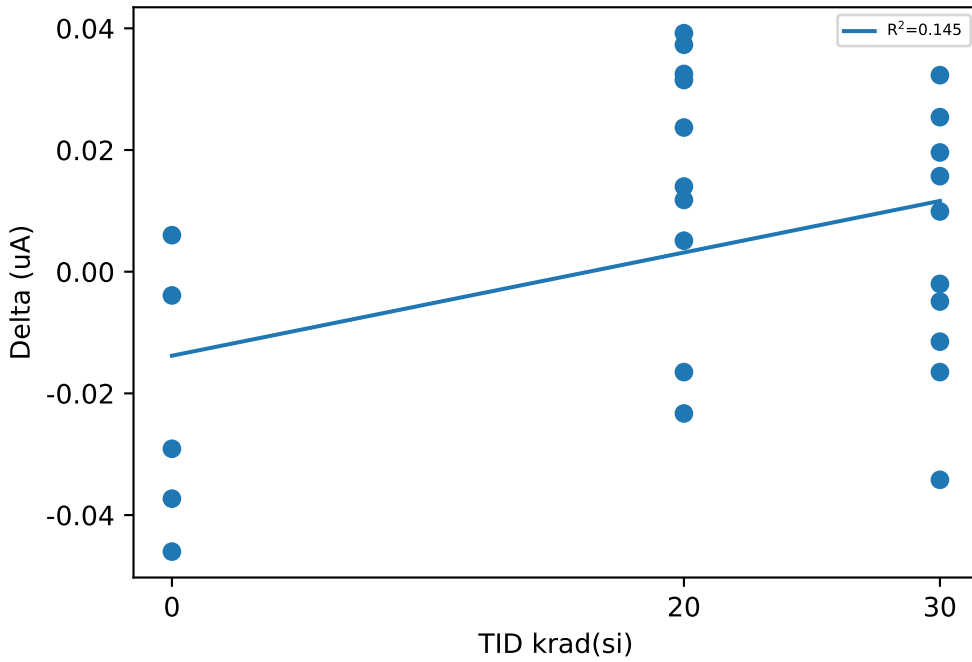

Test Statistics (uA)

krad(si)	Pre Exposure Min	Pre Exposure Avg	Pre Exposure Max	Pre Exposure Std	Post Exposure Min	Post Exposure Avg	Post Exposure Max	Post Exposure Std	Min Delta	Avg Delta	Max Delta	Std Delta
0	3.4953	3.5756	3.6416	0.053539	3.5013	3.5536	3.5956	0.04162	-0.046	-0.02206	0.006	0.022204
20	3.4932	3.5368	3.5984	0.038234	3.4699	3.5524	3.6309	0.041323	-0.0233	0.01553	0.0392	0.021865
30	3.4991	3.542	3.6113	0.037703	3.4856	3.5454	3.6436	0.046292	-0.0342	0.00338	0.0323	0.02083

Device Test: 8.2 UJEU7X(IOUT2_GroundLoss_UJEU7X)

TID vs Result Stats

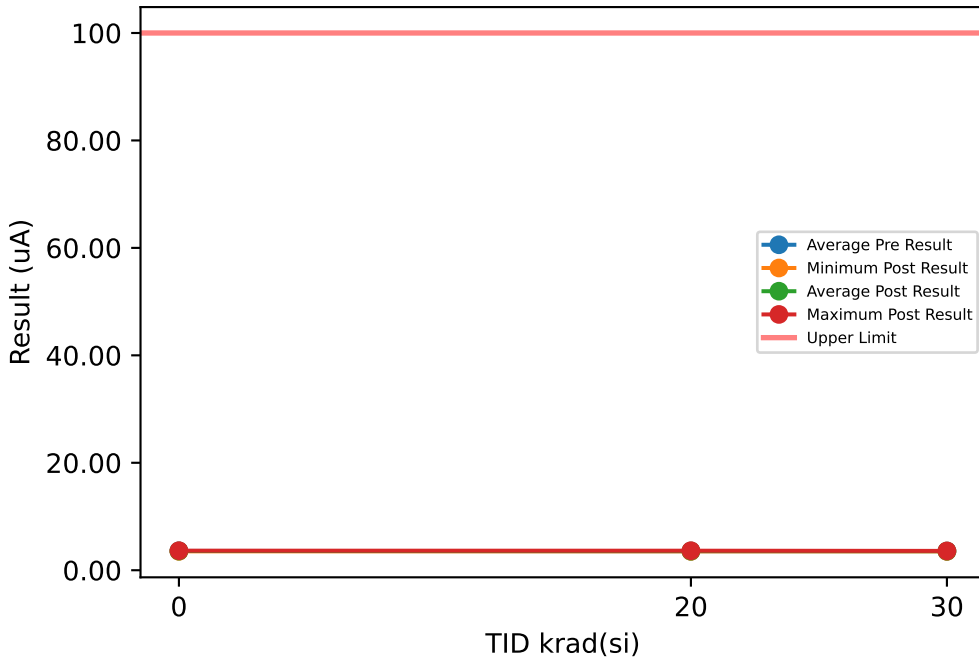

Test Results (Upper Limit = 100.0 (uA))

Serial #	krad(si)	Exposure Conditions	Pre Result	Post Result	Delta
50	20	LDR biased	3.5406	3.5485	0.0079
51	20	LDR biased	3.5003	3.5524	0.0521
52	20	LDR biased	3.5384	3.5799	0.0415
53	20	LDR biased	3.4704	3.5092	0.0388
54	20	LDR biased	3.5328	3.5721	0.0393
55	30	LDR biased	3.5396	3.5583	0.0187
56	30	LDR biased	3.5522	3.5856	0.0334
57	30	LDR biased	3.5135	3.5371	0.0236
58	30	LDR biased	3.5583	3.5347	-0.0236
59	30	LDR biased	3.5592	3.5502	-0.009
60	20	LDR unbiased	3.6052	3.6172	0.012
61	20	LDR unbiased	3.5469	3.576	0.0291
62	20	LDR unbiased	3.5662	3.5347	-0.0315
63	20	LDR unbiased	3.5612	3.5583	-0.0029
64	20	LDR unbiased	3.6052	3.6349	0.0297
65	30	LDR unbiased	3.5548	3.5544	-0.0004
66	30	LDR unbiased	3.6349	3.5777	-0.0572
67	30	LDR unbiased	3.5631	3.5548	-0.0083
68	30	LDR unbiased	3.4874	3.5053	0.0179
69	30	LDR unbiased	3.5979	3.5974	-0.0005
70	0	correlation	3.5819	3.5603	-0.0216
71	0	correlation	3.5239	3.5151	-0.0088
72	0	correlation	3.619	3.6388	0.0198
73	0	correlation	3.592	3.5583	-0.0337
74	0	correlation	3.6251	3.6133	-0.0118

TID vs Post - Pre Exposure Delta

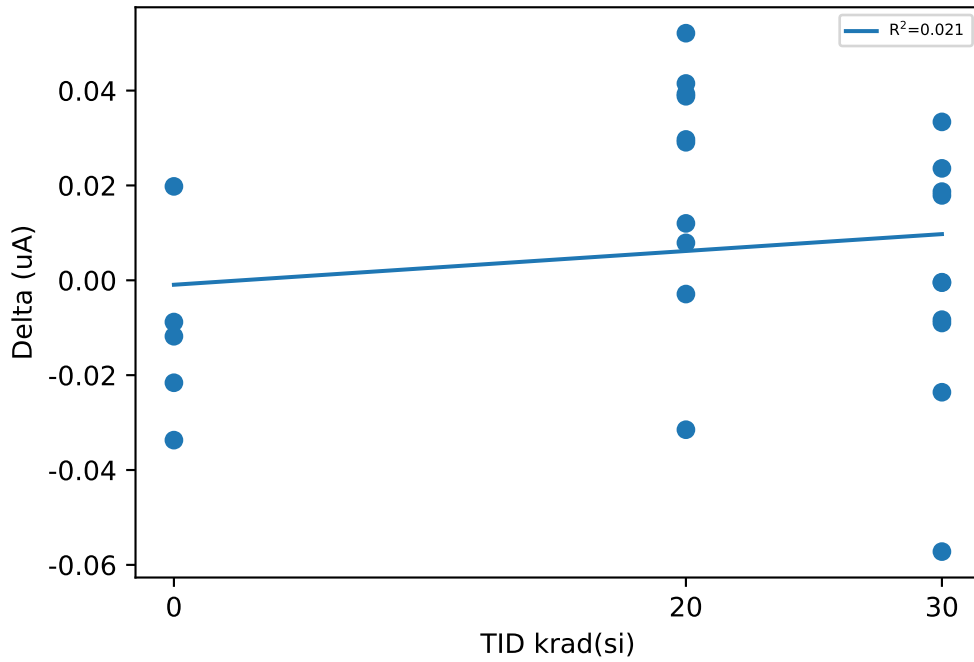

Test Statistics (uA)

krad(si)	Pre Exposure Min	Pre Exposure Avg	Pre Exposure Max	Pre Exposure Std	Post Exposure Min	Post Exposure Avg	Post Exposure Max	Post Exposure Std	Min Delta	Avg Delta	Max Delta	Std Delta
0	3.5239	3.5884	3.6251	0.040307	3.5151	3.5772	3.6388	0.048982	-0.0337	-0.01122	0.0198	0.019884
20	3.4704	3.5467	3.6052	0.041779	3.5092	3.5683	3.6349	0.037121	-0.0315	0.0216	0.0521	0.025292
30	3.4874	3.5561	3.6349	0.040612	3.5053	3.5556	3.5974	0.02684	-0.0572	-0.00054	0.0334	0.026497

Device Test: 8.3 UJEU7X(IOUT3_GroundLoss_UJEU7X)

TID vs Result Stats

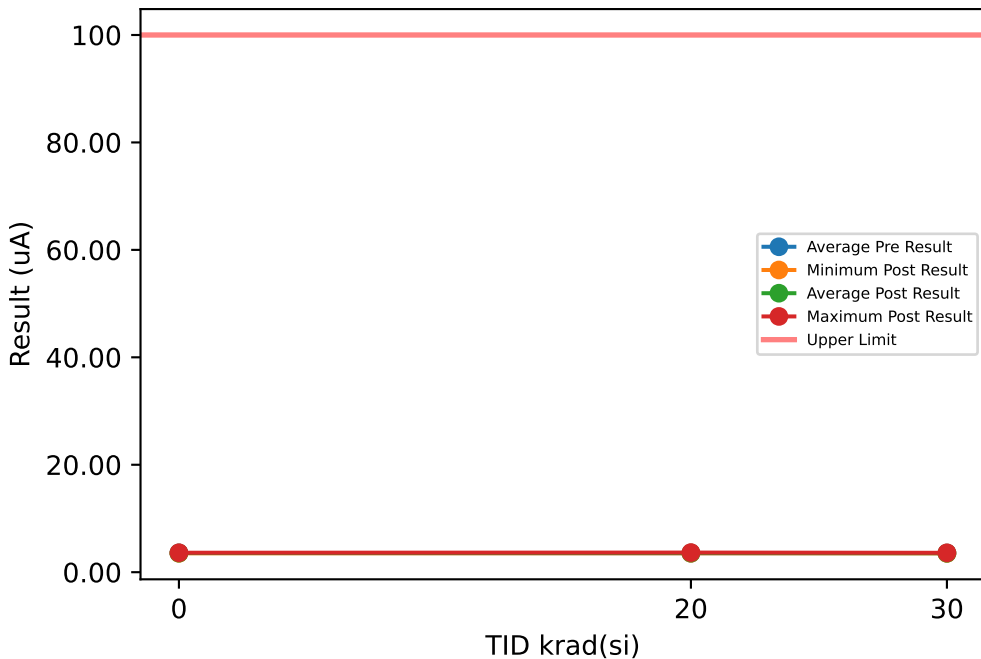

TID vs Post - Pre Exposure Delta

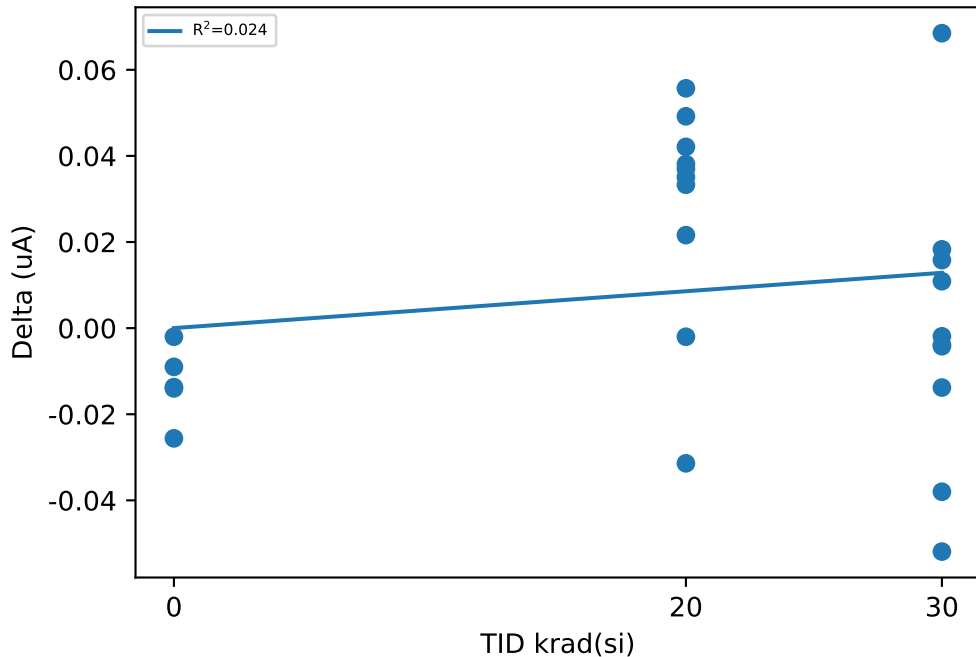

Test Results (Upper Limit = 100.0 (uA))

Serial #	krad(si)	Exposure Conditions	Pre Result	Post Result	Delta
50	20	LDR biased	3.5034	3.525	0.0216
51	20	LDR biased	3.4978	3.5348	0.037
52	20	LDR biased	3.5066	3.5623	0.0557
53	20	LDR biased	3.4838	3.5171	0.0333
54	20	LDR biased	3.5604	3.5584	-0.002
55	30	LDR biased	3.541	3.6095	0.0685
56	30	LDR biased	3.5597	3.5459	-0.0138
57	30	LDR biased	3.5014	3.4995	-0.0019
58	30	LDR biased	3.5466	3.5427	-0.0039
59	30	LDR biased	3.537	3.5479	0.0109
60	20	LDR unbiased	3.595	3.6331	0.0381
61	20	LDR unbiased	3.5407	3.5899	0.0492
62	20	LDR unbiased	3.5741	3.5427	-0.0314
63	20	LDR unbiased	3.5272	3.5623	0.0351
64	20	LDR unbiased	3.6127	3.6548	0.0421
65	30	LDR unbiased	3.5289	3.5447	0.0158
66	30	LDR unbiased	3.6548	3.6029	-0.0519
67	30	LDR unbiased	3.537	3.5328	-0.0042
68	30	LDR unbiased	3.4949	3.5132	0.0183
69	30	LDR unbiased	3.5682	3.5302	-0.038
70	0	correlation	3.5486	3.5466	-0.002
71	0	correlation	3.5272	3.5132	-0.014
72	0	correlation	3.6323	3.6233	-0.009
73	0	correlation	3.5544	3.5407	-0.0137
74	0	correlation	3.6115	3.5859	-0.0256

Test Statistics (uA)

krad(si)	Pre Exposure Min	Pre Exposure Avg	Pre Exposure Max	Pre Exposure Std	Post Exposure Min	Post Exposure Avg	Post Exposure Max	Post Exposure Std	Min Delta	Avg Delta	Max Delta	Std Delta
0	3.5272	3.5748	3.6323	0.044781	3.5132	3.5619	3.6233	0.043015	-0.0256	-0.01286	-0.002	0.008619
20	3.4838	3.5402	3.6127	0.04403	3.5171	3.568	3.6548	0.04545	-0.0314	0.02787	0.0557	0.026133
30	3.4949	3.547	3.6548	0.044208	3.4995	3.5469	3.6095	0.034864	-0.0519	-2e-05	0.0685	0.032931

Device Test: 8.4 UJEU7X(IOUT4_GroundLoss_UJEU7X)

TID vs Result Stats

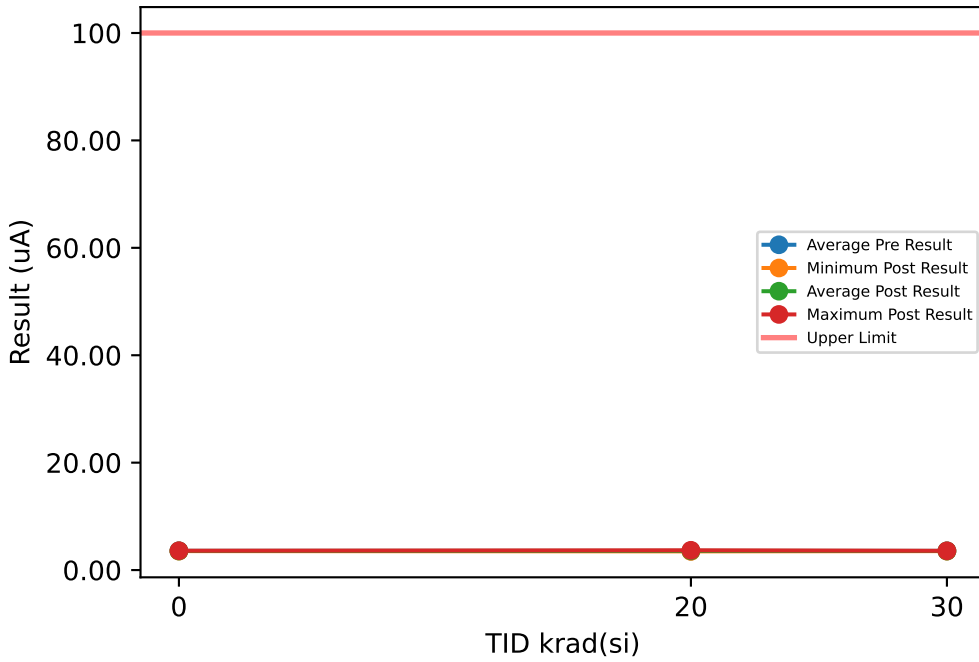

Test Results (Upper Limit = 100.0 (uA))

Serial #	krad(si)	Exposure Conditions	Pre Result	Post Result	Delta
50	20	LDR biased	3.5493	3.5238	-0.0255
51	20	LDR biased	3.5466	3.5415	-0.0051
52	20	LDR biased	3.5355	3.5631	0.0276
53	20	LDR biased	3.4788	3.4766	-0.0022
54	20	LDR biased	3.5316	3.5906	0.059
55	30	LDR biased	3.5838	3.5768	-0.007
56	30	LDR biased	3.5709	3.567	-0.0039
57	30	LDR biased	3.5456	3.5475	0.0019
58	30	LDR biased	3.5395	3.5257	-0.0138
59	30	LDR biased	3.5897	3.5434	-0.0463
60	20	LDR unbiased	3.5631	3.6162	0.0531
61	20	LDR unbiased	3.5475	3.5749	0.0274
62	20	LDR unbiased	3.5533	3.5906	0.0373
63	20	LDR unbiased	3.5701	3.5985	0.0284
64	20	LDR unbiased	3.5985	3.685	0.0865
65	30	LDR unbiased	3.5377	3.567	0.0293
66	30	LDR unbiased	3.6142	3.5906	-0.0236
67	30	LDR unbiased	3.576	3.5416	-0.0344
68	30	LDR unbiased	3.5217	3.5434	0.0217
69	30	LDR unbiased	3.579	3.569	-0.01
70	0	correlation	3.5768	3.5709	-0.0059
71	0	correlation	3.5348	3.5277	-0.0071
72	0	correlation	3.6241	3.6044	-0.0197
73	0	correlation	3.5554	3.5336	-0.0218
74	0	correlation	3.565	3.5808	0.0158

TID vs Post - Pre Exposure Delta

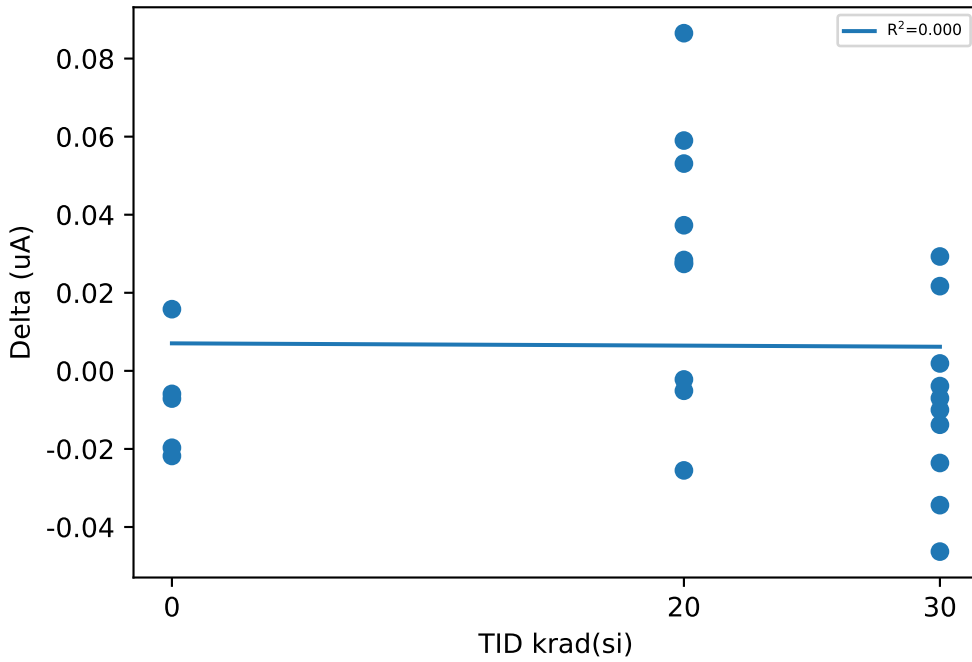

Test Statistics (uA)

krad(si)	Pre Exposure Min	Pre Exposure Avg	Pre Exposure Max	Pre Exposure Std	Post Exposure Min	Post Exposure Avg	Post Exposure Max	Post Exposure Std	Min Delta	Avg Delta	Max Delta	Std Delta
0	3.5348	3.5712	3.6241	0.033327	3.5277	3.5635	3.6044	0.032413	-0.0218	-0.00774	0.0158	0.014989
20	3.4788	3.5474	3.5985	0.030749	3.4766	3.5761	3.685	0.056167	-0.0255	0.02865	0.0865	0.033277
30	3.5217	3.5658	3.6142	0.028628	3.5257	3.5572	3.5906	0.019837	-0.0463	-0.00861	0.0293	0.023167

Device Test: 8.5 UJ4X6M(VDIODE_OUT1_UJ4X6M)

TID vs Result Stats

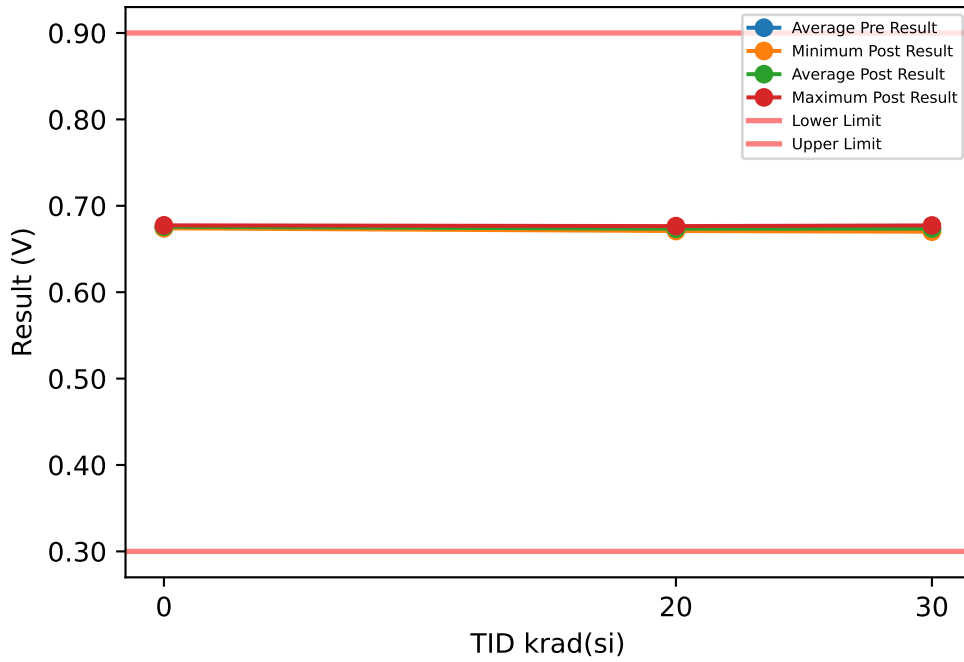

Test Results (Lower Limit = 0.3, Upper Limit = 0.9 (V))

Serial #	krad(si)	Exposure Conditions	Pre Result	Post Result	Delta
50	20	LDR biased	0.6756	0.6735	-0.0021
51	20	LDR biased	0.678	0.6765	-0.0015
52	20	LDR biased	0.6737	0.6708	-0.0029
53	20	LDR biased	0.6769	0.6734	-0.0035
54	20	LDR biased	0.6732	0.6717	-0.0015
55	30	LDR biased	0.6753	0.6755	0.0002
56	30	LDR biased	0.6727	0.6727	0
57	30	LDR biased	0.6735	0.6733	-0.0002
58	30	LDR biased	0.6737	0.6743	0.0006
59	30	LDR biased	0.678	0.6773	-0.0007
60	20	LDR unbiased	0.6747	0.6733	-0.0014
61	20	LDR unbiased	0.675	0.6733	-0.0017
62	20	LDR unbiased	0.6762	0.6752	-0.001
63	20	LDR unbiased	0.6755	0.6741	-0.0014
64	20	LDR unbiased	0.6742	0.673	-0.0012
65	30	LDR unbiased	0.6694	0.67	0.0006
66	30	LDR unbiased	0.6729	0.673	0.0001
67	30	LDR unbiased	0.6746	0.6748	0.0002
68	30	LDR unbiased	0.6736	0.6745	0.0009
69	30	LDR unbiased	0.6702	0.6708	0.0006
70	0	correlation	0.675	0.6774	0.0024
71	0	correlation	0.6734	0.6747	0.0013
72	0	correlation	0.6741	0.6762	0.0021
73	0	correlation	0.6741	0.6739	-0.0002
74	0	correlation	0.6758	0.6763	0.0005

TID vs Post - Pre Exposure Delta

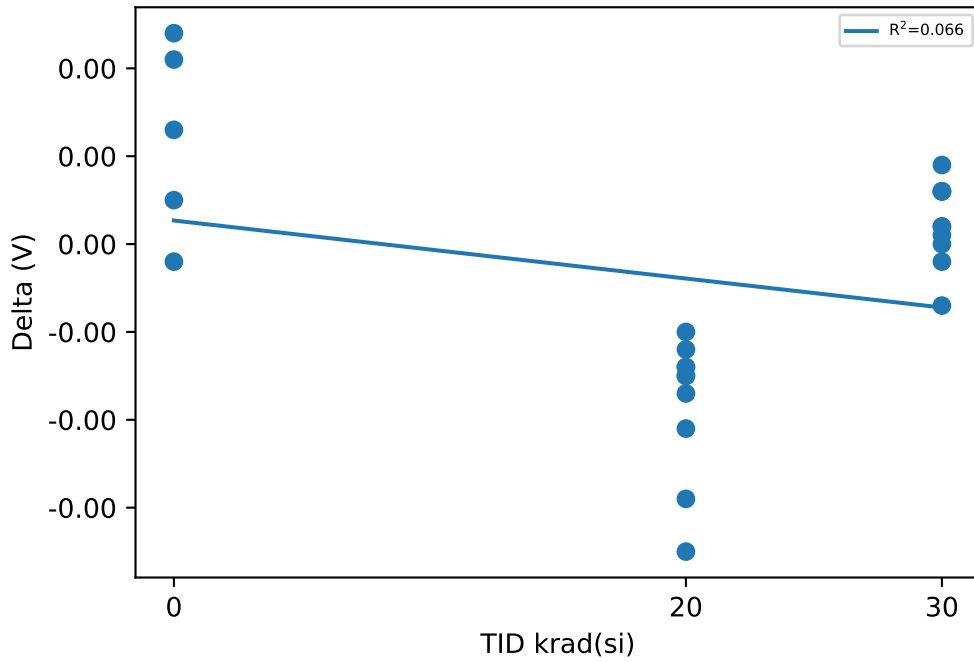

Test Statistics (V)

krad(si)	Pre Exposure Min	Pre Exposure Avg	Pre Exposure Max	Pre Exposure Std	Post Exposure Min	Post Exposure Avg	Post Exposure Max	Post Exposure Std	Min Delta	Avg Delta	Max Delta	Std Delta
0	0.6734	0.67448	0.6758	0.00093113	0.6739	0.6757	0.6774	0.001391	-0.0002	0.00122	0.0024	0.0010849
20	0.6732	0.6753	0.678	0.0014689	0.6708	0.67348	0.6765	0.0016026	-0.0035	-0.00182	-0.001	0.00079554
30	0.6694	0.67339	0.678	0.0024342	0.67	0.67362	0.6773	0.0021627	-0.0007	0.00023	0.0009	0.00046916

Device Test: 8.6 UJ4X6M(VDIODE_OUT2_UJ4X6M)

TID vs Result Stats

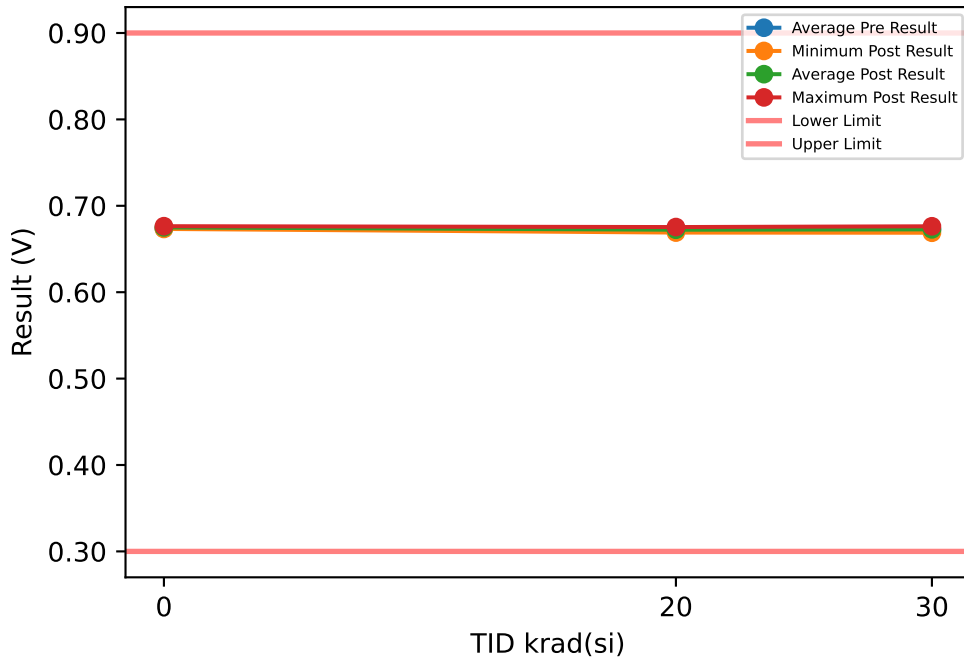

Test Results (Lower Limit = 0.3, Upper Limit = 0.9 (V))

Serial #	krad(si)	Exposure Conditions	Pre Result	Post Result	Delta
50	20	LDR biased	0.6742	0.6718	-0.0024
51	20	LDR biased	0.677	0.6754	-0.0016
52	20	LDR biased	0.6728	0.6696	-0.0032
53	20	LDR biased	0.6756	0.6733	-0.0023
54	20	LDR biased	0.6728	0.669	-0.0038
55	30	LDR biased	0.6743	0.6748	0.0005
56	30	LDR biased	0.6717	0.6717	0
57	30	LDR biased	0.6723	0.6721	-0.0002
58	30	LDR biased	0.6734	0.674	0.0006
59	30	LDR biased	0.677	0.6763	-0.0007
60	20	LDR unbiased	0.6739	0.6732	-0.0007
61	20	LDR unbiased	0.6737	0.672	-0.0017
62	20	LDR unbiased	0.6738	0.673	-0.0008
63	20	LDR unbiased	0.6748	0.6734	-0.0014
64	20	LDR unbiased	0.6733	0.6723	-0.001
65	30	LDR unbiased	0.6685	0.6688	0.0003
66	30	LDR unbiased	0.6719	0.6722	0.0003
67	30	LDR unbiased	0.6738	0.6737	-0.0001
68	30	LDR unbiased	0.6727	0.6736	0.0009
69	30	LDR unbiased	0.6694	0.6703	0.0009
70	0	correlation	0.675	0.6764	0.0014
71	0	correlation	0.6724	0.6732	0.0008
72	0	correlation	0.6733	0.6758	0.0025
73	0	correlation	0.6729	0.6736	0.0007
74	0	correlation	0.6756	0.6758	0.0002

TID vs Post - Pre Exposure Delta

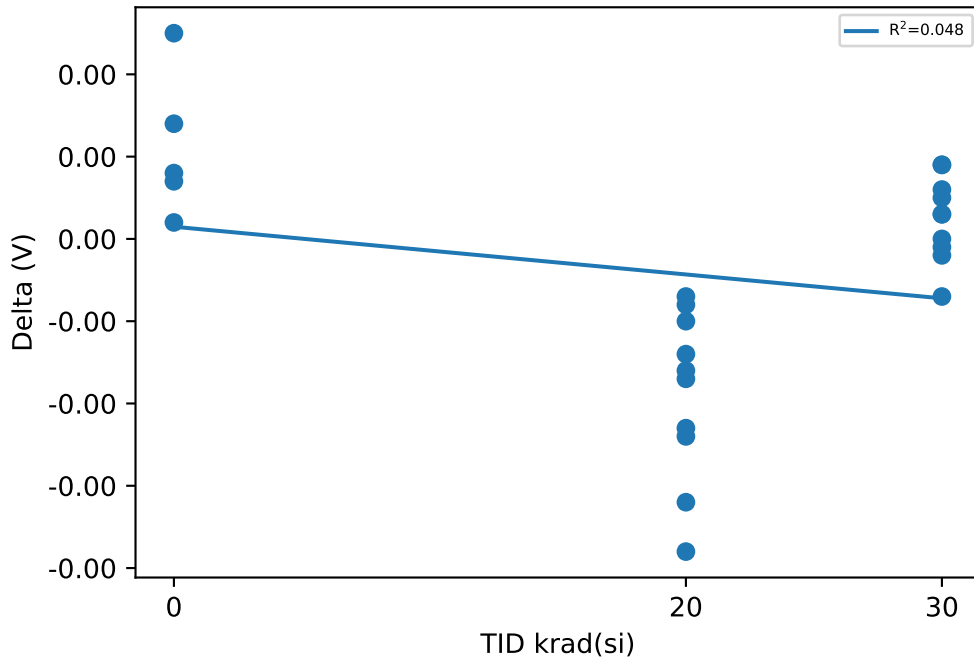

Test Statistics (V)

krad(si)	Pre Exposure Min	Pre Exposure Avg	Pre Exposure Max	Pre Exposure Std	Post Exposure Min	Post Exposure Avg	Post Exposure Max	Post Exposure Std	Min Delta	Avg Delta	Max Delta	Std Delta
0	0.6724	0.67384	0.6756	0.0013867	0.6732	0.67496	0.6764	0.0014519	0.0002	0.00112	0.0025	0.00088148
20	0.6728	0.67419	0.677	0.0013076	0.669	0.6723	0.6754	0.001875	-0.0038	-0.00189	-0.0007	0.00103
30	0.6685	0.6725	0.677	0.0024194	0.6688	0.67275	0.6763	0.0021966	-0.0007	0.00025	0.0009	0.00050827

Device Test: 8.7 UJ4X6M(VDIODE_OUT3_UJ4X6M)

TID vs Result Stats

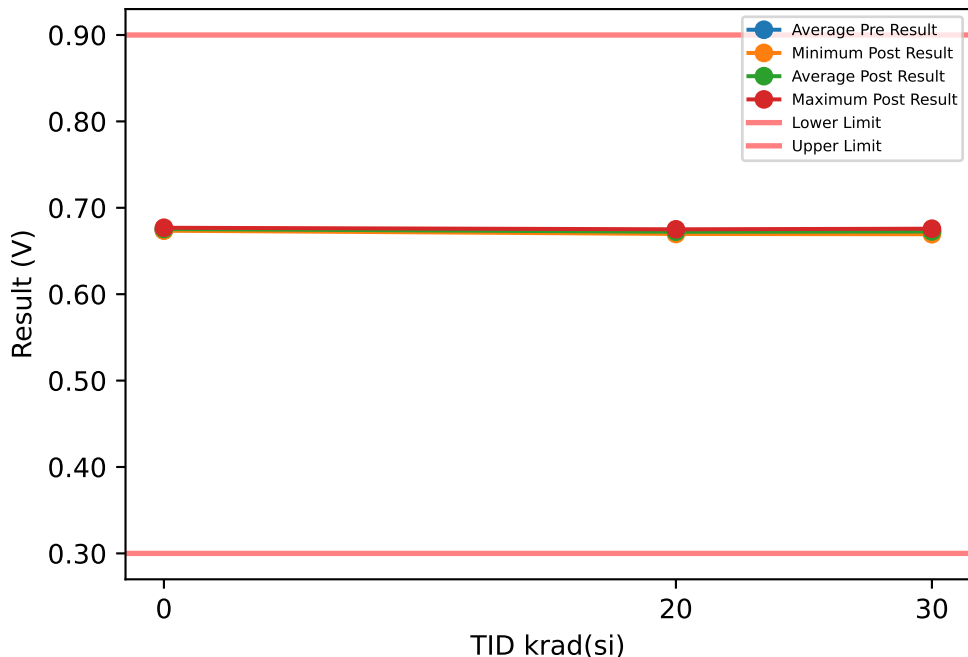

Test Results (Lower Limit = 0.3, Upper Limit = 0.9 (V))

Serial #	krad(si)	Exposure Conditions	Pre Result	Post Result	Delta
50	20	LDR biased	0.6734	0.6713	-0.0021
51	20	LDR biased	0.6775	0.6751	-0.0024
52	20	LDR biased	0.6735	0.6704	-0.0031
53	20	LDR biased	0.6746	0.6725	-0.0021
54	20	LDR biased	0.6721	0.6697	-0.0024
55	30	LDR biased	0.6739	0.6735	-0.0004
56	30	LDR biased	0.6724	0.6724	0
57	30	LDR biased	0.673	0.6728	-0.0002
58	30	LDR biased	0.6733	0.6717	-0.0016
59	30	LDR biased	0.6767	0.6758	-0.0009
60	20	LDR unbiased	0.6734	0.6732	-0.0002
61	20	LDR unbiased	0.6732	0.6717	-0.0015
62	20	LDR unbiased	0.6758	0.6728	-0.003
63	20	LDR unbiased	0.6749	0.6736	-0.0013
64	20	LDR unbiased	0.6727	0.6724	-0.0003
65	30	LDR unbiased	0.669	0.6694	0.0004
66	30	LDR unbiased	0.672	0.6729	0.0009
67	30	LDR unbiased	0.6734	0.6733	-0.0001
68	30	LDR unbiased	0.672	0.6733	0.0013
69	30	LDR unbiased	0.6698	0.6707	0.0009
70	0	correlation	0.6745	0.6769	0.0024
71	0	correlation	0.673	0.6735	0.0005
72	0	correlation	0.6742	0.6758	0.0016
73	0	correlation	0.6732	0.6746	0.0014
74	0	correlation	0.6753	0.6764	0.0011

TID vs Post - Pre Exposure Delta

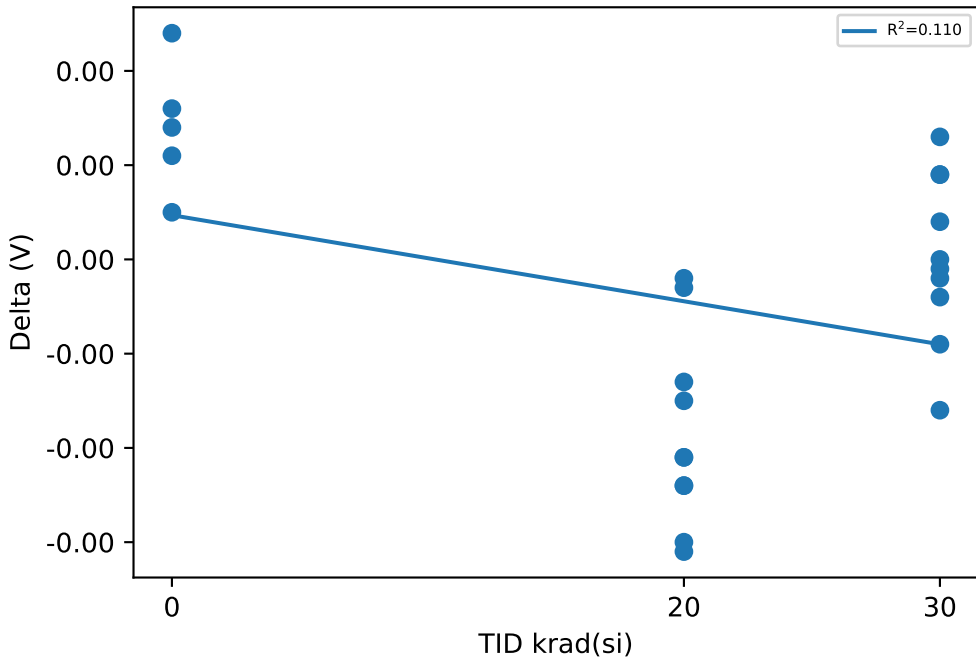

Test Statistics (V)

krad(si)	Pre Exposure Min	Pre Exposure Avg	Pre Exposure Max	Pre Exposure Std	Post Exposure Min	Post Exposure Avg	Post Exposure Max	Post Exposure Std	Min Delta	Avg Delta	Max Delta	Std Delta
0	0.673	0.67404	0.6753	0.00095026	0.6735	0.67544	0.6769	0.0013831	0.0005	0.0014	0.0024	0.00069642
20	0.6721	0.67411	0.6775	0.0016141	0.6697	0.67227	0.6751	0.0015762	-0.0031	-0.00184	-0.0002	0.0010091
30	0.669	0.67255	0.6767	0.0021428	0.6694	0.67258	0.6758	0.0017274	-0.0016	3e-05	0.0013	0.0008845

Device Test: 8.8 UJ4X6M(VDIODE_OUT4_UJ4X6M)

TID vs Result Stats

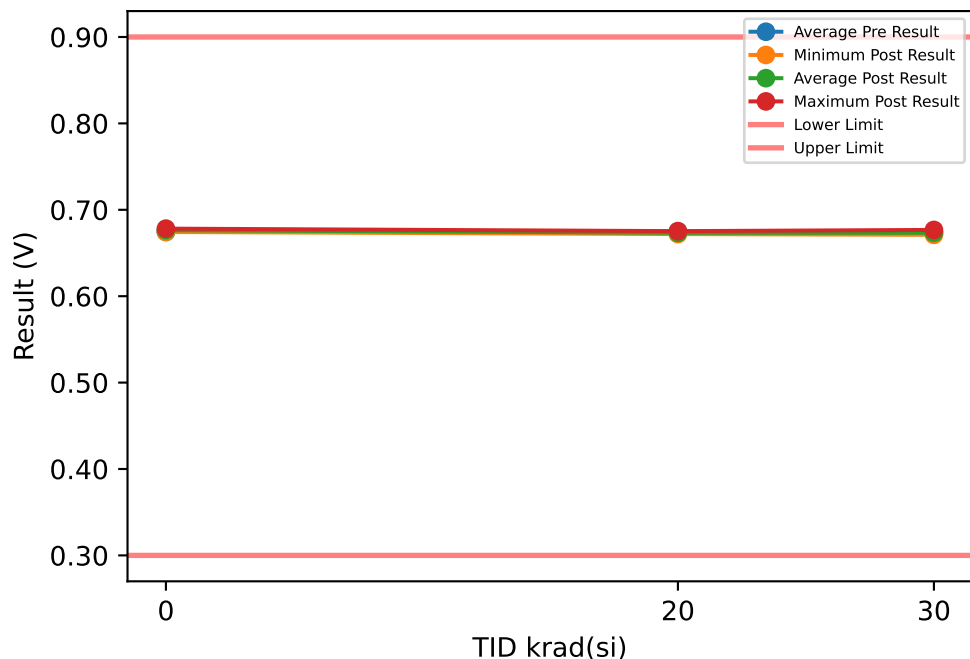

Test Results (Lower Limit = 0.3, Upper Limit = 0.9 (V))

Serial #	krad(si)	Exposure Conditions	Pre Result	Post Result	Delta
50	20	LDR biased	0.6741	0.6732	-0.0009
51	20	LDR biased	0.6784	0.6753	-0.0031
52	20	LDR biased	0.6741	0.6726	-0.0015
53	20	LDR biased	0.6755	0.672	-0.0035
54	20	LDR biased	0.674	0.6719	-0.0021
55	30	LDR biased	0.6749	0.6734	-0.0015
56	30	LDR biased	0.6732	0.6731	-0.0001
57	30	LDR biased	0.6739	0.6737	-0.0002
58	30	LDR biased	0.6742	0.6744	0.0002
59	30	LDR biased	0.6776	0.6767	-0.0009
60	20	LDR unbiased	0.674	0.6735	-0.0005
61	20	LDR unbiased	0.674	0.6738	-0.0002
62	20	LDR unbiased	0.6757	0.6743	-0.0014
63	20	LDR unbiased	0.6756	0.6744	-0.0012
64	20	LDR unbiased	0.6734	0.6726	-0.0008
65	30	LDR unbiased	0.6694	0.671	0.0016
66	30	LDR unbiased	0.6724	0.6737	0.0013
67	30	LDR unbiased	0.6743	0.674	-0.0003
68	30	LDR unbiased	0.6727	0.6729	0.0002
69	30	LDR unbiased	0.6703	0.6712	0.0009
70	0	correlation	0.6741	0.6782	0.0041
71	0	correlation	0.6739	0.6743	0.0004
72	0	correlation	0.6747	0.6775	0.0028
73	0	correlation	0.6743	0.6746	0.0003
74	0	correlation	0.6751	0.6776	0.0025

TID vs Post - Pre Exposure Delta

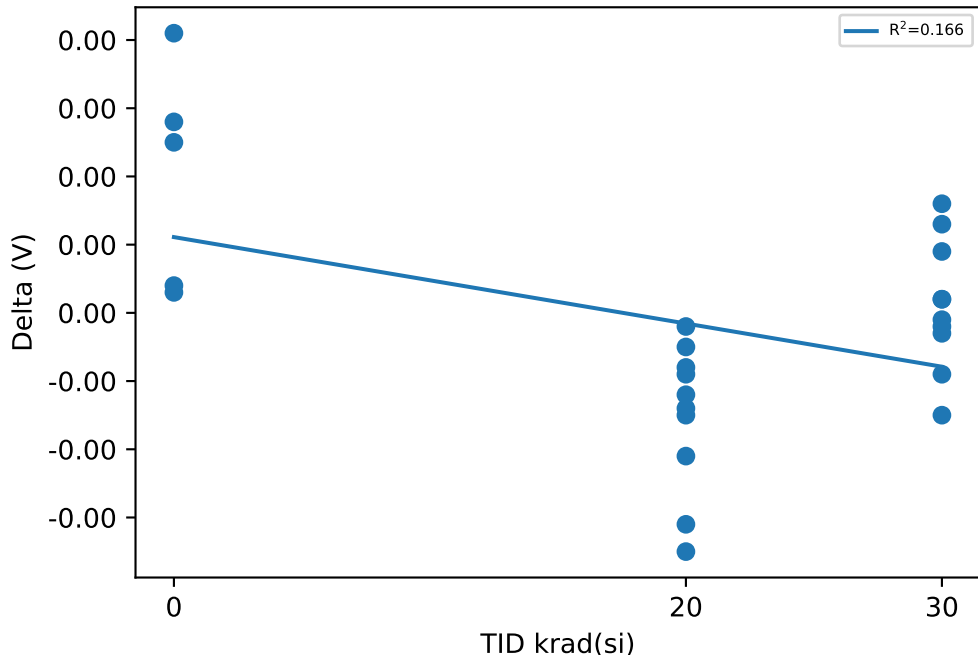

Test Statistics (V)

krad(si)	Pre Exposure Min	Pre Exposure Avg	Pre Exposure Max	Pre Exposure Std	Post Exposure Min	Post Exposure Avg	Post Exposure Max	Post Exposure Std	Min Delta	Avg Delta	Max Delta	Std Delta
0	0.6739	0.67442	0.6751	0.00048166	0.6743	0.67644	0.6782	0.0018393	0.0003	0.00202	0.0041	0.0016392
20	0.6734	0.67488	0.6784	0.0014793	0.6719	0.67336	0.6753	0.0011108	-0.0035	-0.00152	-0.0002	0.001083
30	0.6694	0.67329	0.6776	0.002324	0.671	0.67341	0.6767	0.0016114	-0.0015	0.00012	0.0016	0.00095429

Device Test: 9.1 UJ9MO5(VOL_OFF_UJ9MO5)

TID vs Result Stats

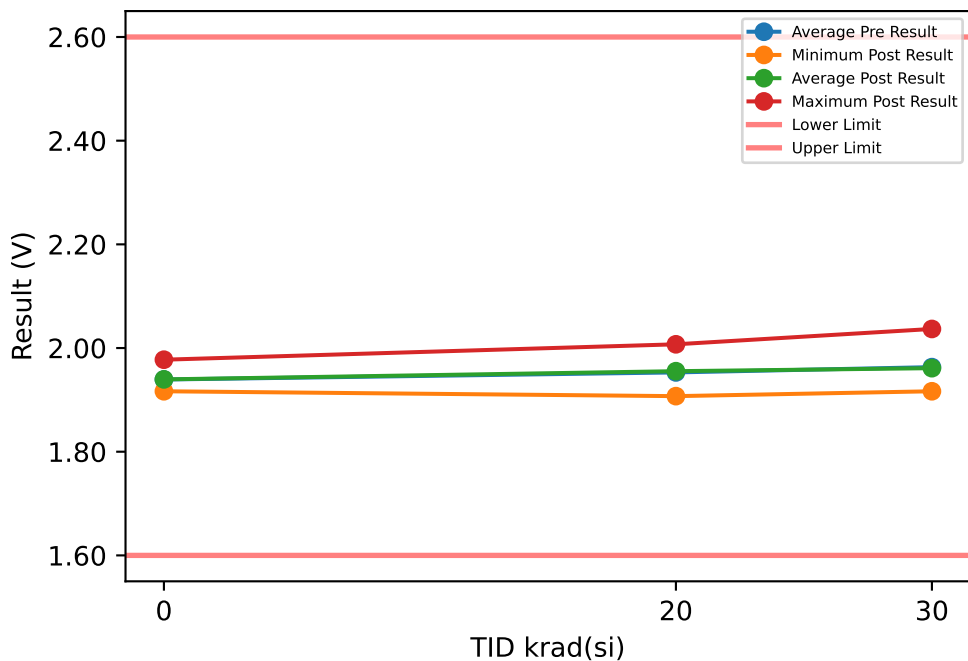

Test Results (Lower Limit = 1.6, Upper Limit = 2.6 (V))

Serial #	krad(si)	Exposure Conditions	Pre Result	Post Result	Delta
50	20	LDR biased	1.9459	1.9469	0.001
51	20	LDR biased	1.9562	1.9569	0.0007
52	20	LDR biased	1.9078	1.9072	-0.0006
53	20	LDR biased	1.9567	1.9578	0.0011
54	20	LDR biased	1.9978	2.0072	0.0094
55	30	LDR biased	1.9275	1.9285	0.001
56	30	LDR biased	1.9462	1.9571	0.0109
57	30	LDR biased	1.977	1.977	0
58	30	LDR biased	2.0484	2.0368	-0.0116
59	30	LDR biased	1.9272	1.9265	-0.0007
60	20	LDR unbiased	1.9674	1.9666	-0.0008
61	20	LDR unbiased	1.9873	1.9872	-0.0001
62	20	LDR unbiased	1.9572	1.9578	0.0006
63	20	LDR unbiased	1.9163	1.9278	0.0115
64	20	LDR unbiased	1.9368	1.9381	0.0013
65	30	LDR unbiased	1.9164	1.9166	0.0002
66	30	LDR unbiased	1.9475	1.9468	-0.0007
67	30	LDR unbiased	1.9478	1.9367	-0.0111
68	30	LDR unbiased	2.0067	1.9981	-0.0086
69	30	LDR unbiased	1.987	1.9874	0.0004
70	0	correlation	1.9281	1.9285	0.0004
71	0	correlation	1.9372	1.9369	-0.0003
72	0	correlation	1.9371	1.9381	0.001
73	0	correlation	1.917	1.9166	-0.0004
74	0	correlation	1.9769	1.9775	0.0006

TID vs Post - Pre Exposure Delta

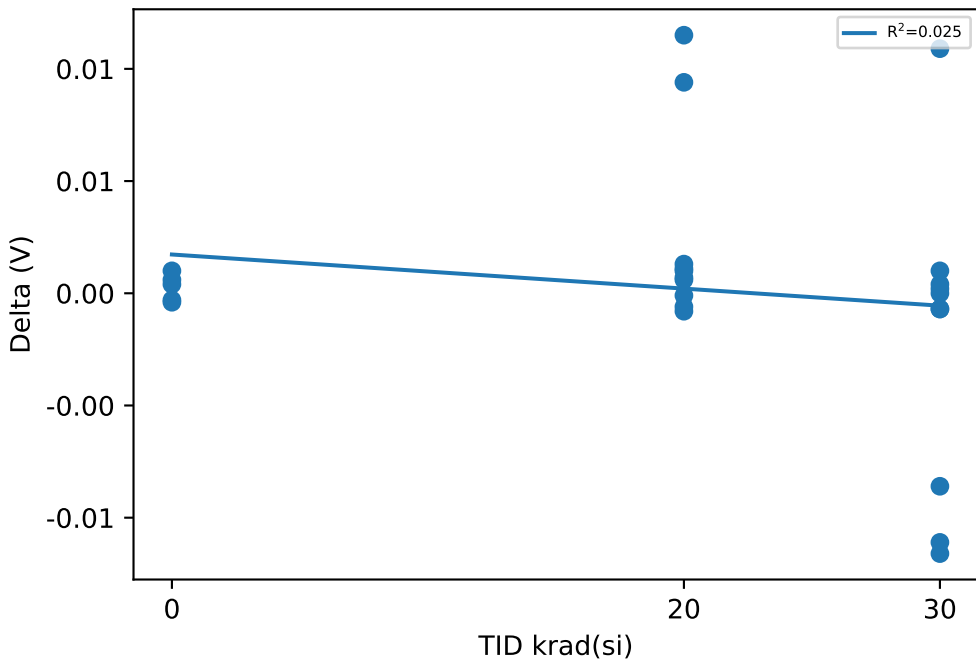

Test Statistics (V)

krad(si)	Pre Exposure Min	Pre Exposure Avg	Pre Exposure Max	Pre Exposure Std	Post Exposure Min	Post Exposure Avg	Post Exposure Max	Post Exposure Std	Min Delta	Avg Delta	Max Delta	Std Delta
0	1.917	1.9393	1.9769	0.022615	1.9166	1.9395	1.9775	0.022903	-0.0004	0.00026	0.001	0.00059833
20	1.9078	1.9529	1.9978	0.028157	1.9072	1.9553	2.0072	0.028461	-0.0008	0.00241	0.0115	0.0043242
30	1.9164	1.9632	2.0484	0.041421	1.9166	1.9611	2.0368	0.038152	-0.0116	-0.00202	0.0109	0.0067652

Device Test: 9.10 UJUQE8(V_FAULT_OL_UJUQE8)

TID vs Result Stats

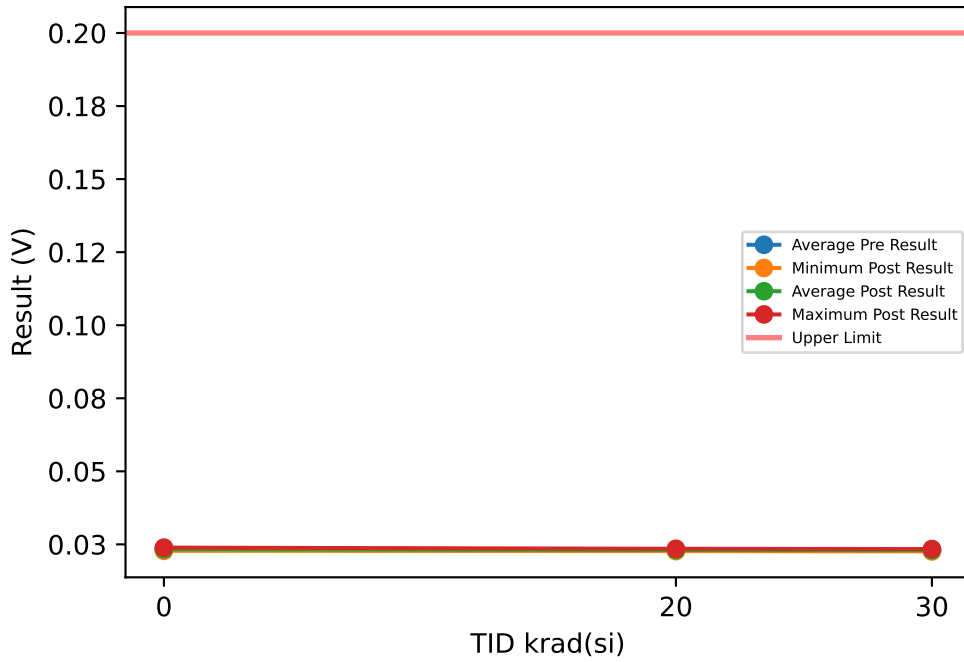

Test Results (Upper Limit = 0.2 (V))

Serial #	krad(si)	Exposure Conditions	Pre Result	Post Result	Delta
50	20	LDR biased	0.0235	0.0235	0
51	20	LDR biased	0.0233	0.023	-0.0003
52	20	LDR biased	0.0231	0.0231	0
53	20	LDR biased	0.0227	0.0227	0
54	20	LDR biased	0.0231	0.0231	0
55	30	LDR biased	0.0234	0.0231	-0.0003
56	30	LDR biased	0.0233	0.0231	-0.0002
57	30	LDR biased	0.0233	0.0232	-0.0001
58	30	LDR biased	0.023	0.0228	-0.0002
59	30	LDR biased	0.0233	0.023	-0.0003
60	20	LDR unbiased	0.0234	0.0234	0
61	20	LDR unbiased	0.0231	0.0231	0
62	20	LDR unbiased	0.0229	0.0228	-0.0001
63	20	LDR unbiased	0.0233	0.0231	-0.0002
64	20	LDR unbiased	0.0231	0.023	-0.0001
65	30	LDR unbiased	0.0229	0.0226	-0.0003
66	30	LDR unbiased	0.0236	0.0234	-0.0002
67	30	LDR unbiased	0.0234	0.023	-0.0004
68	30	LDR unbiased	0.0228	0.0226	-0.0002
69	30	LDR unbiased	0.0231	0.023	-0.0001
70	0	correlation	0.023	0.0228	-0.0002
71	0	correlation	0.0237	0.0235	-0.0002
72	0	correlation	0.0241	0.0239	-0.0002
73	0	correlation	0.0232	0.0231	-0.0001
74	0	correlation	0.0234	0.0233	-0.0001

TID vs Post - Pre Exposure Delta

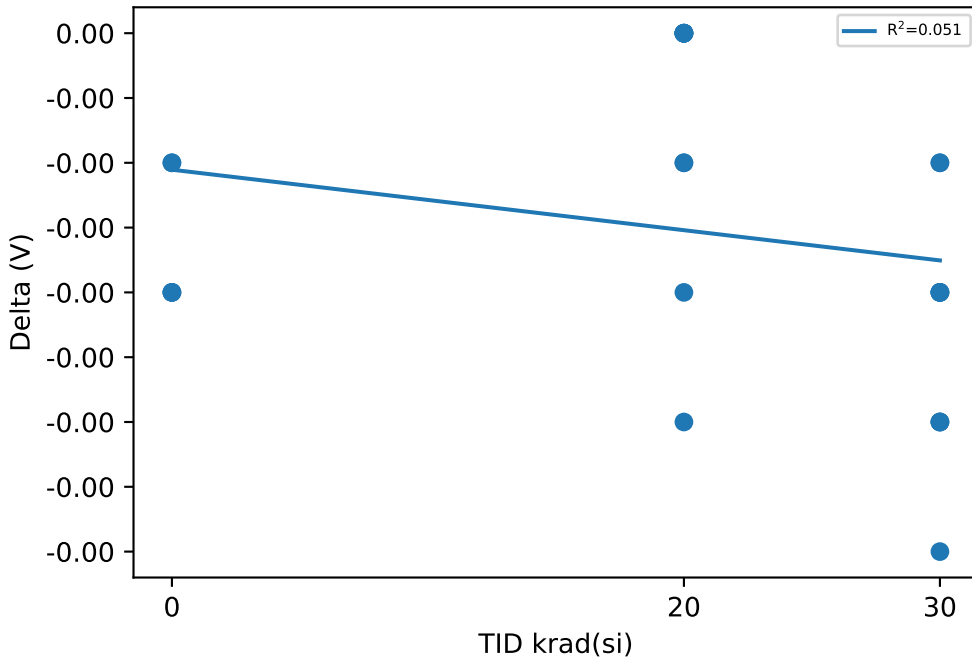

Test Statistics (V)

krad(si)	Pre Exposure Min	Pre Exposure Avg	Pre Exposure Max	Pre Exposure Std	Post Exposure Min	Post Exposure Avg	Post Exposure Max	Post Exposure Std	Min Delta	Avg Delta	Max Delta	Std Delta
0	0.023	0.02348	0.0241	0.00043243	0.0228	0.02332	0.0239	0.00041473	-0.0002	-0.00016	-0.0001	5.4772e-05
20	0.0227	0.02315	0.0235	0.00023688	0.0227	0.02308	0.0235	0.00023944	-0.0003	-7e-05	0	0.00010593
30	0.0228	0.02321	0.0236	0.00025144	0.0226	0.02298	0.0234	0.00025298	-0.0004	-0.00023	-0.0001	9.4868e-05

Device Test: 9.11 UJWCB3(TOL_OFF_UJWCB3)

TID vs Result Stats

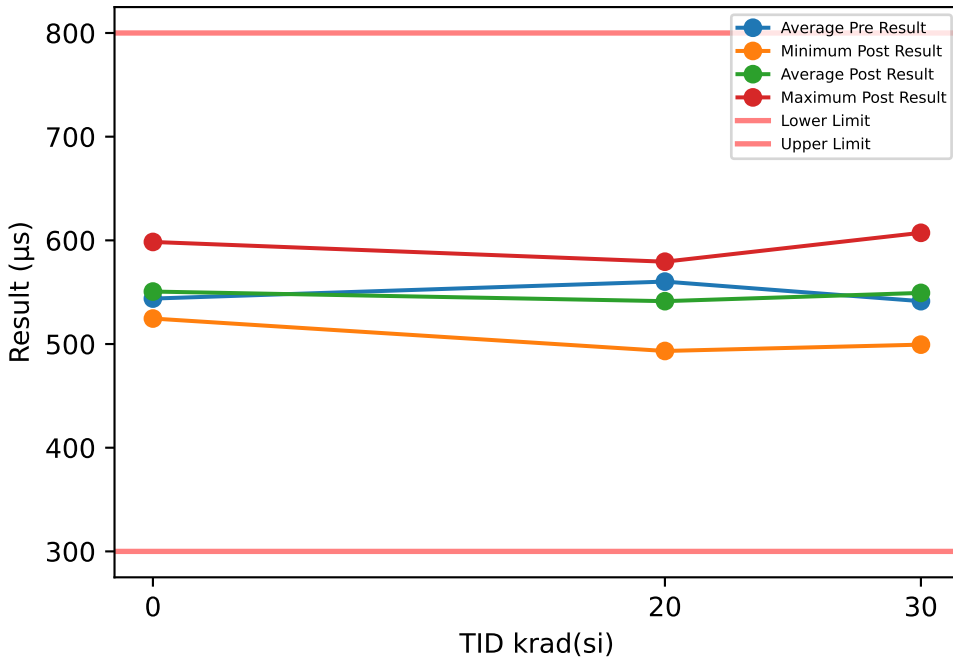

Test Results (Lower Limit = 300.0, Upper Limit = 800.0 (µs))

Serial #	krad(si)	Exposure Conditions	Pre Result	Post Result	Delta
50	20	LDR biased	553.01	532.2	-20.807
51	20	LDR biased	582.58	568.62	-13.961
52	20	LDR biased	582.98	546.51	-36.475
53	20	LDR biased	528.8	579.42	50.622
54	20	LDR biased	565.54	557.83	-7.7127
55	30	LDR biased	557.75	520.98	-36.766
56	30	LDR biased	518.04	605.49	87.45
57	30	LDR biased	517.62	499.42	-18.208
58	30	LDR biased	539.08	607.28	68.199
59	30	LDR biased	520.82	582.56	61.735
60	20	LDR unbiased	555.38	525.51	-29.873
61	20	LDR unbiased	565.45	579.03	13.572
62	20	LDR unbiased	564.57	493.3	-71.272
63	20	LDR unbiased	556.12	515.63	-40.483
64	20	LDR unbiased	547.83	515.47	-32.362
65	30	LDR unbiased	540.86	555.61	14.74
66	30	LDR unbiased	576.03	566.53	-9.4938
67	30	LDR unbiased	523.71	524.43	0.72
68	30	LDR unbiased	534.14	528.76	-5.3822
69	30	LDR unbiased	585.4	502.08	-83.314
70	0	correlation	496.65	530.75	34.093
71	0	correlation	578.56	564.83	-13.723
72	0	correlation	560.03	534.48	-25.551
73	0	correlation	532.91	598.46	65.556
74	0	correlation	551.07	524.6	-26.467

TID vs Post - Pre Exposure Delta

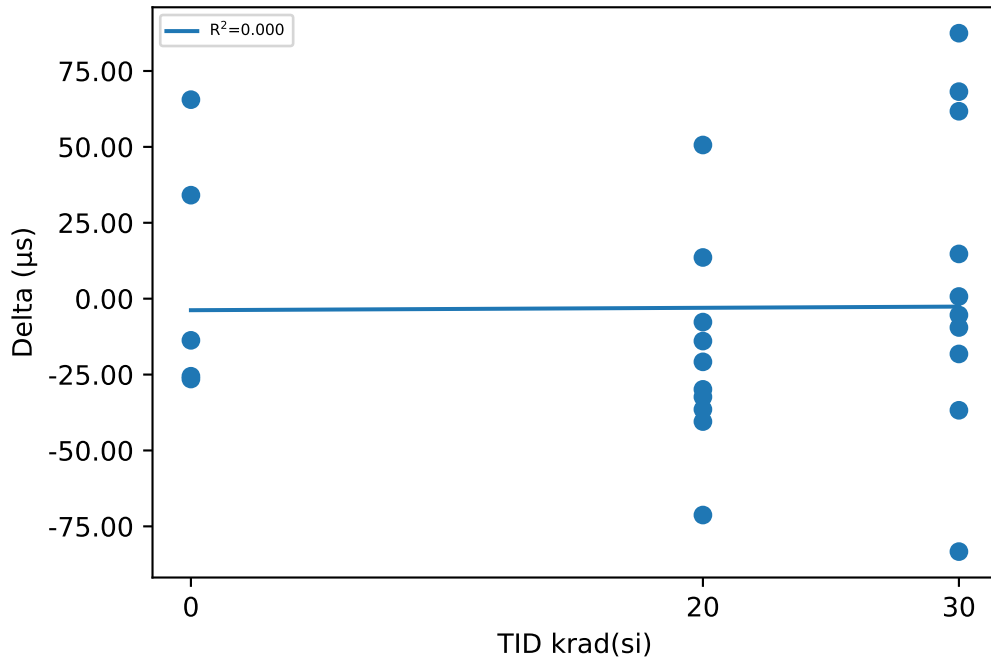

Test Statistics (µs)

krad(si)	Pre Exposure Min	Pre Exposure Avg	Pre Exposure Max	Pre Exposure Std	Post Exposure Min	Post Exposure Avg	Post Exposure Max	Post Exposure Std	Min Delta	Avg Delta	Max Delta	Std Delta
0	496.65	543.84	578.56	31.088	524.6	550.62	598.46	30.917	-26.467	6.7818	65.556	41.145
20	528.8	560.23	582.98	16.077	493.3	541.35	579.42	29.599	-71.272	-18.875	50.622	33.099
30	517.62	541.35	585.4	24.285	499.42	549.31	607.28	40.169	-83.314	7.968	87.45	52.107

Device Test: 9.12 UJBGA6(VCSH_UJBGA6)

TID vs Result Stats

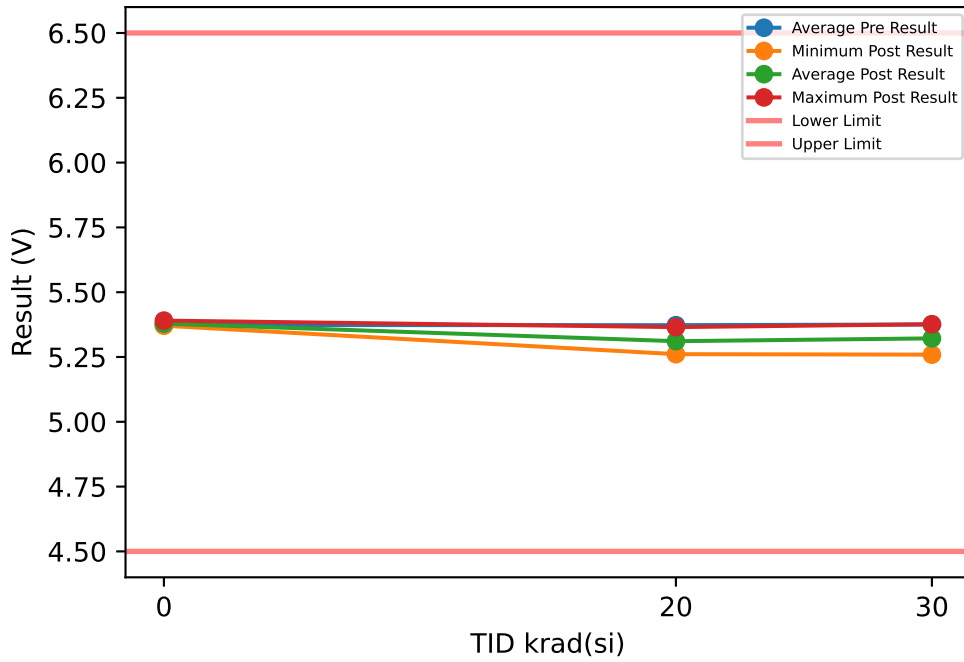

Test Results (Lower Limit = 4.5, Upper Limit = 6.5 (V))

Serial #	krad(si)	Exposure Conditions	Pre Result	Post Result	Delta
50	20	LDR biased	5.372	5.2729	-0.0991
51	20	LDR biased	5.3754	5.2774	-0.098
52	20	LDR biased	5.3664	5.2609	-0.1055
53	20	LDR biased	5.3816	5.2765	-0.1051
54	20	LDR biased	5.3756	5.2733	-0.1023
55	30	LDR biased	5.3748	5.2737	-0.1011
56	30	LDR biased	5.3606	5.2592	-0.1014
57	30	LDR biased	5.3945	5.3073	-0.0872
58	30	LDR biased	5.3665	5.2782	-0.0883
59	30	LDR biased	5.3907	5.3046	-0.0861
60	20	LDR unbiased	5.3806	5.3612	-0.0194
61	20	LDR unbiased	5.3713	5.3513	-0.02
62	20	LDR unbiased	5.3867	5.3653	-0.0214
63	20	LDR unbiased	5.347	5.3247	-0.0223
64	20	LDR unbiased	5.3717	5.3468	-0.0249
65	30	LDR unbiased	5.3769	5.3649	-0.012
66	30	LDR unbiased	5.3644	5.3516	-0.0128
67	30	LDR unbiased	5.3624	5.3432	-0.0192
68	30	LDR unbiased	5.3924	5.3763	-0.0161
69	30	LDR unbiased	5.3714	5.3591	-0.0123
70	0	correlation	5.3744	5.3833	0.0089
71	0	correlation	5.3858	5.3904	0.0046
72	0	correlation	5.3664	5.3708	0.0044
73	0	correlation	5.3713	5.3771	0.0058
74	0	correlation	5.3683	5.3718	0.0035

TID vs Post - Pre Exposure Delta

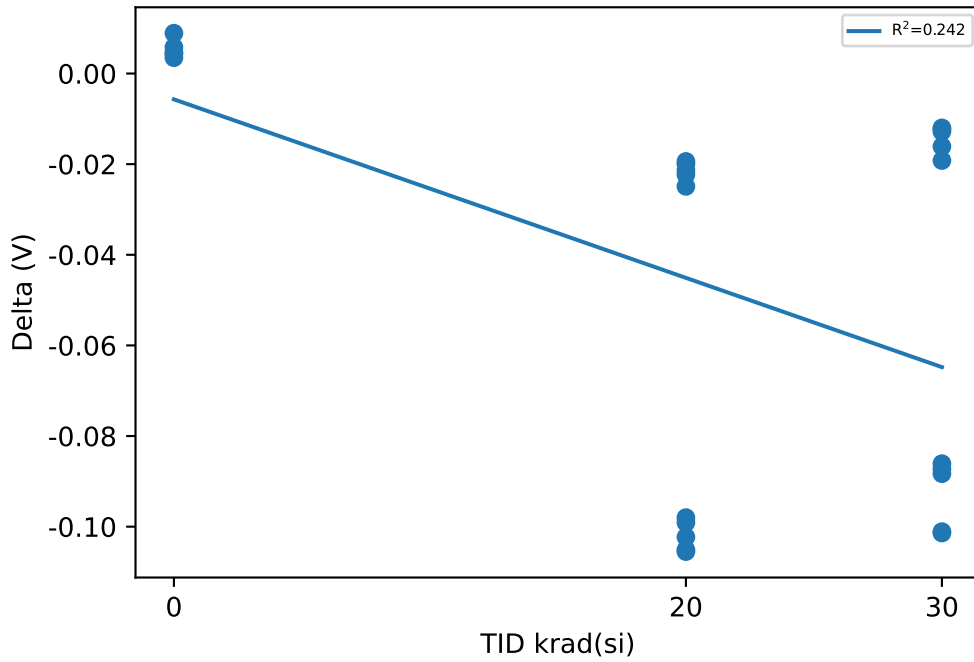

Test Statistics (V)

krad(si)	Pre Exposure Min	Pre Exposure Avg	Pre Exposure Max	Pre Exposure Std	Post Exposure Min	Post Exposure Avg	Post Exposure Max	Post Exposure Std	Min Delta	Avg Delta	Max Delta	Std Delta
0	5.3664	5.3732	5.3858	0.0076494	5.3708	5.3787	5.3904	0.0082254	0.0035	0.00544	0.0089	0.0021007
20	5.347	5.3728	5.3867	0.010836	5.2609	5.311	5.3653	0.04251	-0.1055	-0.0618	-0.0194	0.04246
30	5.3606	5.3755	5.3945	0.012887	5.2592	5.3218	5.3763	0.042432	-0.1014	-0.05365	-0.012	0.041661

Device Test: 9.13 UJP7QA(ICSH_UJP7QA)

TID vs Result Stats

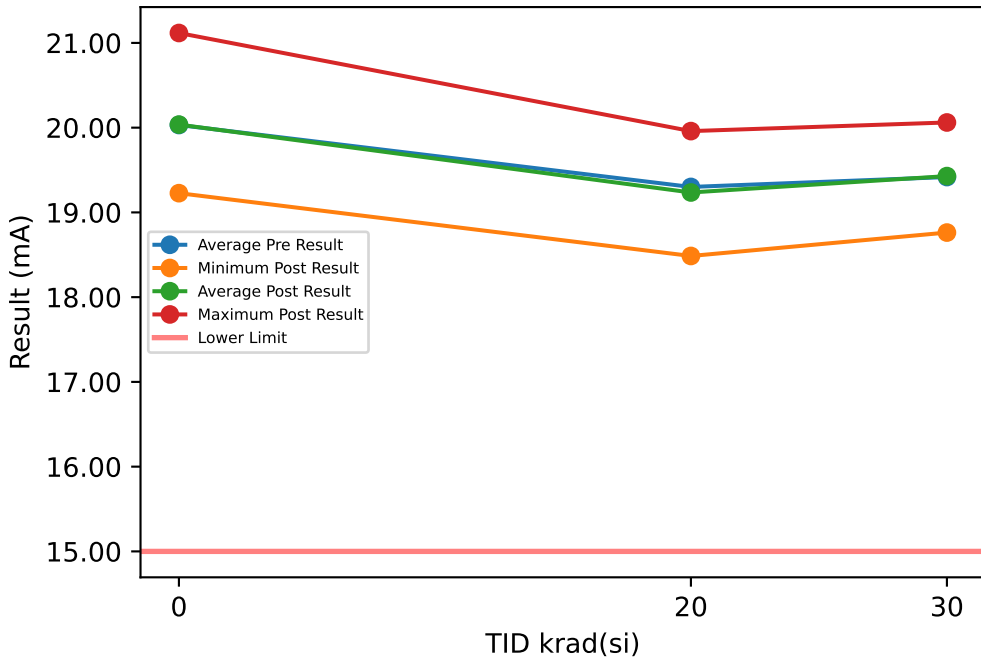

Test Results (Lower Limit = 15.0 (mA))

Serial #	krad(si)	Exposure Conditions	Pre Result	Post Result	Delta
50	20	LDR biased	19.928	19.959	0.031
51	20	LDR biased	19.07	18.923	-0.1471
52	20	LDR biased	18.97	18.989	0.0196
53	20	LDR biased	18.668	18.486	-0.1823
54	20	LDR biased	19.426	19.206	-0.2205
55	30	LDR biased	19.569	19.297	-0.2719
56	30	LDR biased	19.157	19.306	0.149
57	30	LDR biased	19.967	20.061	0.094
58	30	LDR biased	19.007	19.359	0.3519
59	30	LDR biased	19.74	20.014	0.2737
60	20	LDR unbiased	19.941	19.957	0.0164
61	20	LDR unbiased	19.561	19.496	-0.0653
62	20	LDR unbiased	18.937	18.826	-0.111
63	20	LDR unbiased	19.056	19.155	0.0991
64	20	LDR unbiased	19.447	19.354	-0.0931
65	30	LDR unbiased	19.053	18.762	-0.2912
66	30	LDR unbiased	20.023	19.947	-0.0762
67	30	LDR unbiased	18.867	18.813	-0.0541
68	30	LDR unbiased	19.199	19.156	-0.0428
69	30	LDR unbiased	19.588	19.568	-0.0194
70	0	correlation	19.27	19.24	-0.0296
71	0	correlation	20.405	20.412	0.0068
72	0	correlation	21.089	21.117	0.0284
73	0	correlation	19.203	19.227	0.0242
74	0	correlation	20.19	20.184	-0.006

TID vs Post - Pre Exposure Delta

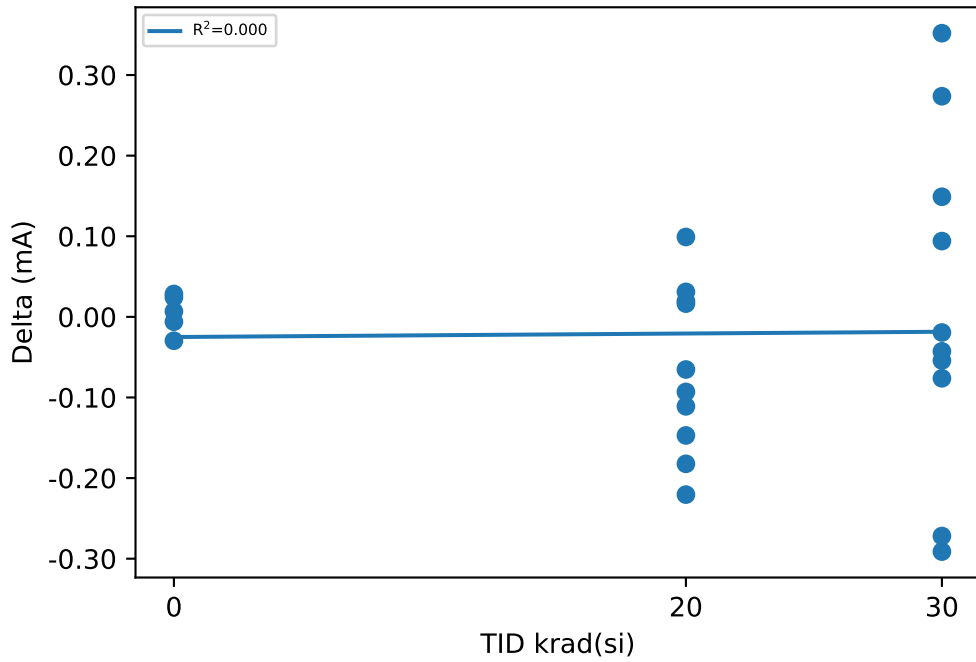

Test Statistics (mA)

krad(si)	Pre Exposure Min	Pre Exposure Avg	Pre Exposure Max	Pre Exposure Std	Post Exposure Min	Post Exposure Avg	Post Exposure Max	Post Exposure Std	Min Delta	Avg Delta	Max Delta	Std Delta
0	19.203	20.031	21.089	0.79828	19.227	20.036	21.117	0.80924	-0.0296	0.00476	0.0284	0.02365
20	18.668	19.3	19.941	0.42998	18.486	19.235	19.959	0.47399	-0.2205	-0.06532	0.0991	0.10409
30	18.867	19.417	20.023	0.41424	18.762	19.428	20.061	0.46725	-0.2912	0.0113	0.3519	0.21034

Device Test: 9.2 UJ5EAX(IOL_OFF_OUT1_UJ5EAX)

TID vs Result Stats

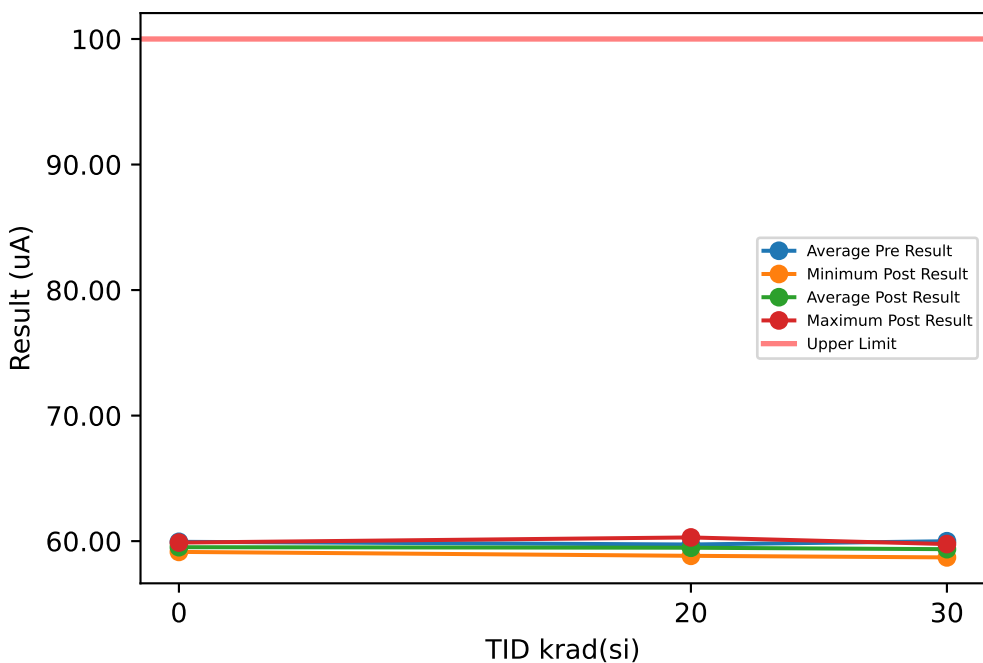

Test Results (Upper Limit = 100.0 (uA))

Serial #	krad(si)	Exposure Conditions	Pre Result	Post Result	Delta
50	20	LDR biased	60.118	59.982	-0.1367
51	20	LDR biased	59.457	58.986	-0.4714
52	20	LDR biased	59.304	58.986	-0.3177
53	20	LDR biased	59.231	59.084	-0.1478
54	20	LDR biased	59.611	59.591	-0.0195
55	30	LDR biased	59.711	59.123	-0.5883
56	30	LDR biased	60.378	59.519	-0.8596
57	30	LDR biased	59.7	58.705	-0.9955
58	30	LDR biased	60.353	59.767	-0.5857
59	30	LDR biased	59.692	59.46	-0.2314
60	20	LDR unbiased	60.437	60.294	-0.1427
61	20	LDR unbiased	60.247	59.767	-0.4796
62	20	LDR unbiased	59.435	58.83	-0.6052
63	20	LDR unbiased	59.262	59.24	-0.0226
64	20	LDR unbiased	60.222	59.982	-0.2402
65	30	LDR unbiased	59.915	58.908	-1.0068
66	30	LDR unbiased	60.118	59.695	-0.424
67	30	LDR unbiased	60.238	59.642	-0.5961
68	30	LDR unbiased	59.948	59.299	-0.65
69	30	LDR unbiased	59.876	59.48	-0.3961
70	0	correlation	60.04	59.259	-0.781
71	0	correlation	59.945	59.533	-0.4124
72	0	correlation	60.3	59.767	-0.5331
73	0	correlation	59.602	59.142	-0.4601
74	0	correlation	59.845	59.884	0.0391

TID vs Post - Pre Exposure Delta

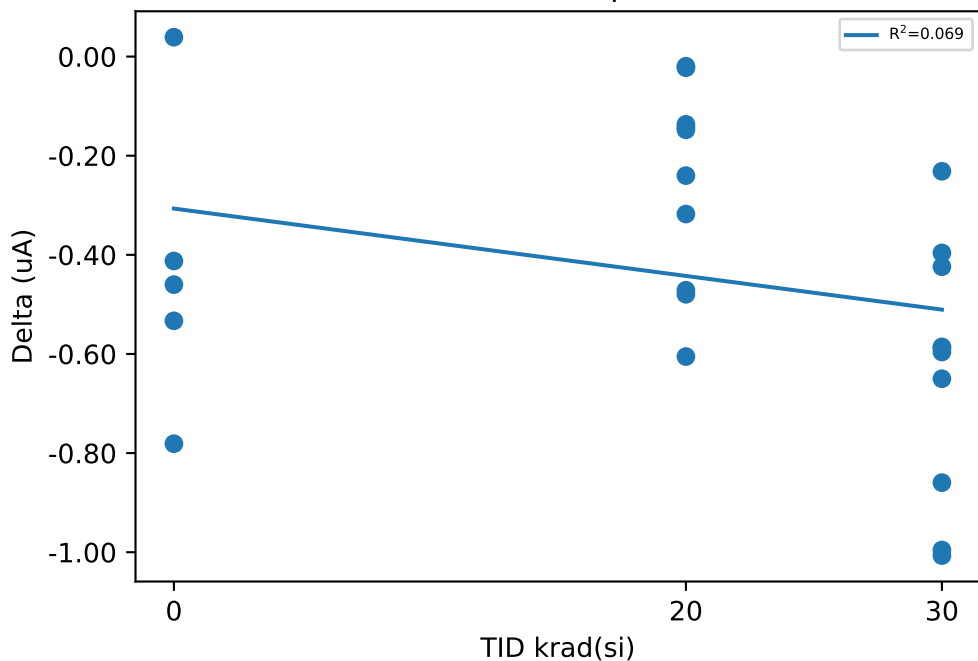

Test Statistics (uA)

krad(si)	Pre Exposure Min	Pre Exposure Avg	Pre Exposure Max	Pre Exposure Std	Post Exposure Min	Post Exposure Avg	Post Exposure Max	Post Exposure Std	Min Delta	Avg Delta	Max Delta	Std Delta
0	59.602	59.947	60.3	0.25619	59.142	59.517	59.884	0.31794	-0.781	-0.4295	0.0391	0.29795
20	59.231	59.733	60.437	0.46947	58.83	59.474	60.294	0.51491	-0.6052	-0.25834	-0.0195	0.20318
30	59.692	59.993	60.378	0.2649	58.705	59.36	59.767	0.34966	-1.0068	-0.63335	-0.2314	0.25592

Device Test: 9.3 UJ5EAX(IOL_OFF_OUT2_UJ5EAX)

TID vs Result Stats

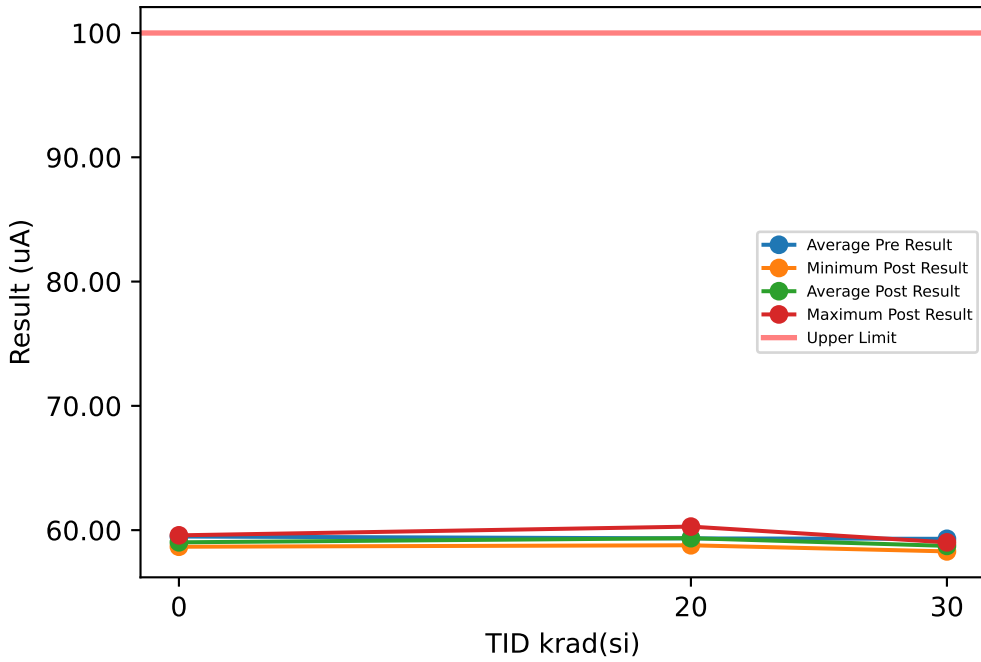

Test Results (Upper Limit = 100.0 (uA))

Serial #	krad(si)	Exposure Conditions	Pre Result	Post Result	Delta
50	20	LDR biased	59.661	59.797	0.1366
51	20	LDR biased	58.908	59.095	0.1868
52	20	LDR biased	59.37	59.153	-0.2168
53	20	LDR biased	58.914	58.782	-0.1318
54	20	LDR biased	59.387	59.056	-0.3317
55	30	LDR biased	59.298	58.88	-0.4181
56	30	LDR biased	59.233	58.823	-0.4102
57	30	LDR biased	58.719	58.29	-0.4292
58	30	LDR biased	59.563	59.017	-0.5464
59	30	LDR biased	59.532	58.96	-0.5725
60	20	LDR unbiased	60.327	60.285	-0.0423
61	20	LDR unbiased	58.719	58.997	0.278
62	20	LDR unbiased	58.997	59.153	0.1561
63	20	LDR unbiased	59.006	59.212	0.2063
64	20	LDR unbiased	60.073	60.012	-0.0615
65	30	LDR unbiased	59.304	58.587	-0.717
66	30	LDR unbiased	59.212	58.765	-0.4473
67	30	LDR unbiased	59.611	58.934	-0.6767
68	30	LDR unbiased	59.097	58.431	-0.6653
69	30	LDR unbiased	59.46	58.647	-0.8132
70	0	correlation	59.251	58.666	-0.5853
71	0	correlation	59.318	58.939	-0.3792
72	0	correlation	59.761	59.036	-0.7246
73	0	correlation	59.383	58.88	-0.5024
74	0	correlation	59.719	59.583	-0.1366

TID vs Post - Pre Exposure Delta

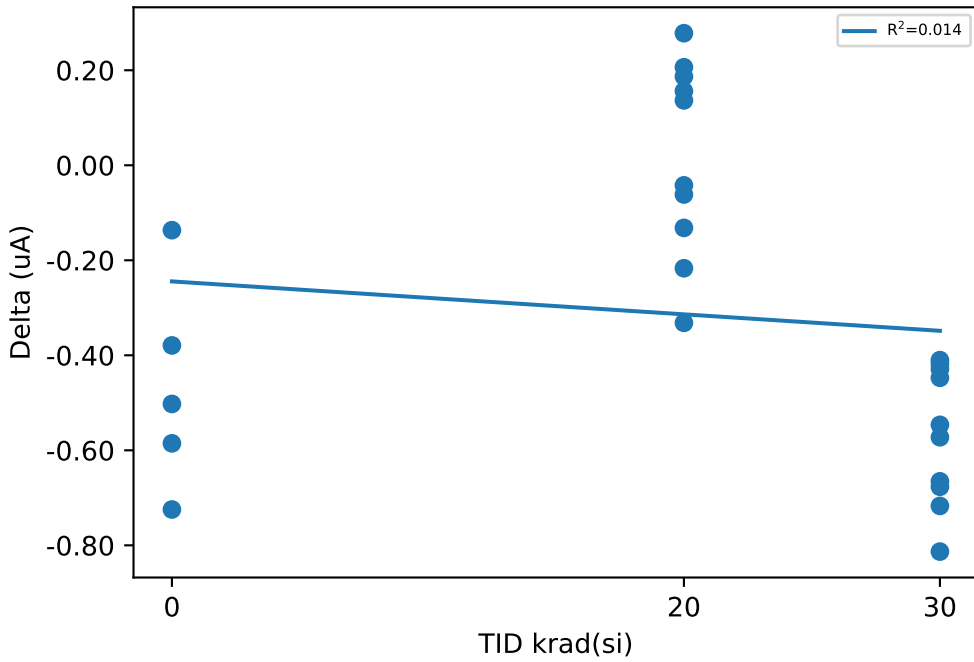

Test Statistics (uA)

krad(si)	Pre Exposure Min	Pre Exposure Avg	Pre Exposure Max	Pre Exposure Std	Post Exposure Min	Post Exposure Avg	Post Exposure Max	Post Exposure Std	Min Delta	Avg Delta	Max Delta	Std Delta
0	59.251	59.486	59.761	0.23676	58.666	59.021	59.583	0.34229	-0.7246	-0.46562	-0.1366	0.22275
20	58.719	59.336	60.327	0.53759	58.782	59.354	60.285	0.49518	-0.3317	0.01797	0.278	0.20399
30	58.719	59.303	59.611	0.26588	58.29	58.733	59.017	0.24011	-0.8132	-0.56959	-0.4102	0.14348

Device Test: 9.4 UJ5EAX(IOL_OFF_OUT3_UJ5EAX)

TID vs Result Stats

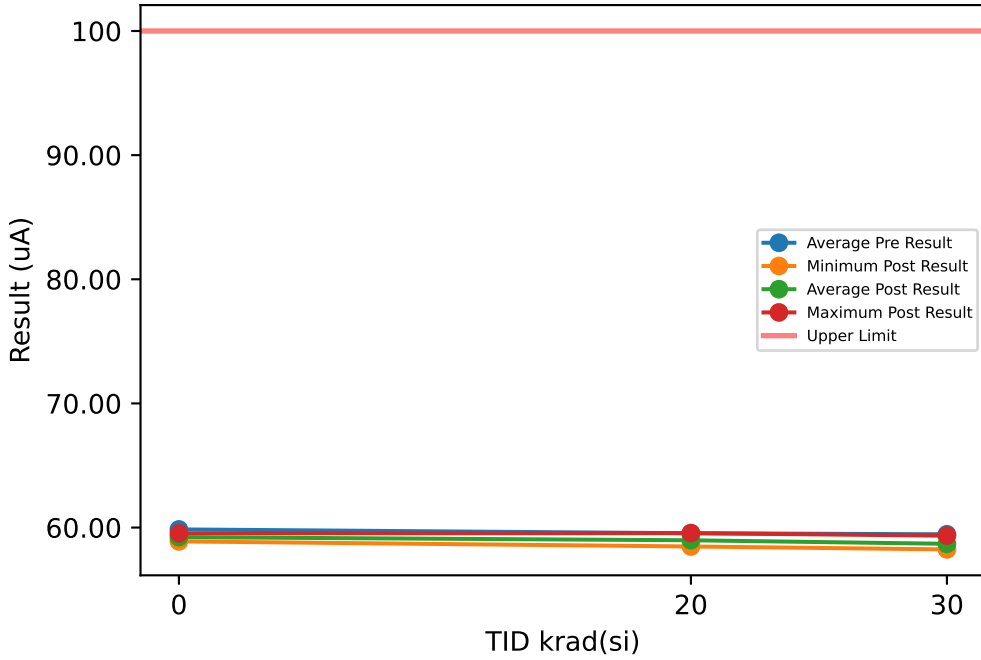

Test Results (Upper Limit = 100.0 (uA))

Serial #	krad(si)	Exposure Conditions	Pre Result	Post Result	Delta
50	20	LDR biased	59.883	59.414	-0.4691
51	20	LDR biased	59.4	58.788	-0.6116
52	20	LDR biased	60.048	59.55	-0.4977
53	20	LDR biased	58.944	58.475	-0.4682
54	20	LDR biased	58.944	58.573	-0.3714
55	30	LDR biased	59.419	58.475	-0.9438
56	30	LDR biased	59.326	58.603	-0.7224
57	30	LDR biased	59.276	58.358	-0.9183
58	30	LDR biased	59.257	58.866	-0.391
59	30	LDR biased	59.751	59.345	-0.4057
60	20	LDR unbiased	60.224	59.336	-0.8884
61	20	LDR unbiased	59.12	58.671	-0.4486
62	20	LDR unbiased	59.59	59.062	-0.5278
63	20	LDR unbiased	59.439	58.749	-0.6897
64	20	LDR unbiased	59.833	59.14	-0.6934
65	30	LDR unbiased	59.139	58.241	-0.8982
66	30	LDR unbiased	59.941	59.111	-0.8304
67	30	LDR unbiased	59.4	58.729	-0.671
68	30	LDR unbiased	59.658	58.456	-1.2019
69	30	LDR unbiased	59.413	58.72	-0.6921
70	0	correlation	60.215	59.531	-0.6842
71	0	correlation	59.966	59.042	-0.9235
72	0	correlation	59.423	58.886	-0.5375
73	0	correlation	59.549	59.14	-0.4093
74	0	correlation	60.098	59.531	-0.5669

TID vs Post - Pre Exposure Delta

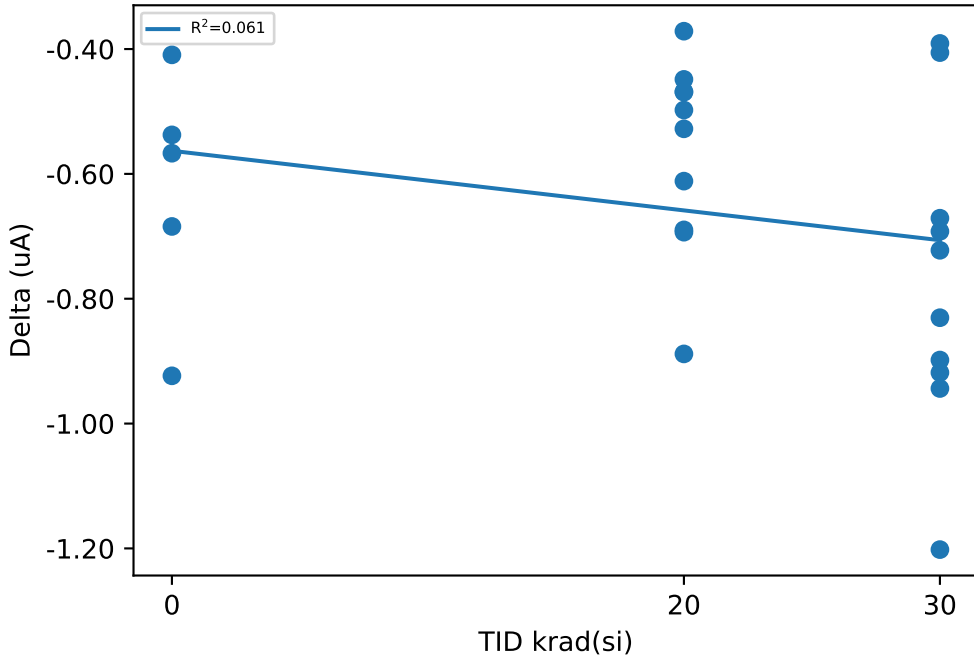

Test Statistics (uA)

krad(si)	Pre Exposure Min	Pre Exposure Avg	Pre Exposure Max	Pre Exposure Std	Post Exposure Min	Post Exposure Avg	Post Exposure Max	Post Exposure Std	Min Delta	Avg Delta	Max Delta	Std Delta
0	59.423	59.85	60.215	0.3466	58.886	59.226	59.531	0.29272	-0.9235	-0.62428	-0.4093	0.19375
20	58.944	59.542	60.224	0.45327	58.475	58.976	59.55	0.37683	-0.8884	-0.56659	-0.3714	0.1543
30	59.139	59.458	59.941	0.24925	58.241	58.69	59.345	0.34334	-1.2019	-0.76748	-0.391	0.24794

Device Test: 9.5 UJ5EAX(IOL_OFF_OUT4_UJ5EAX)

TID vs Result Stats

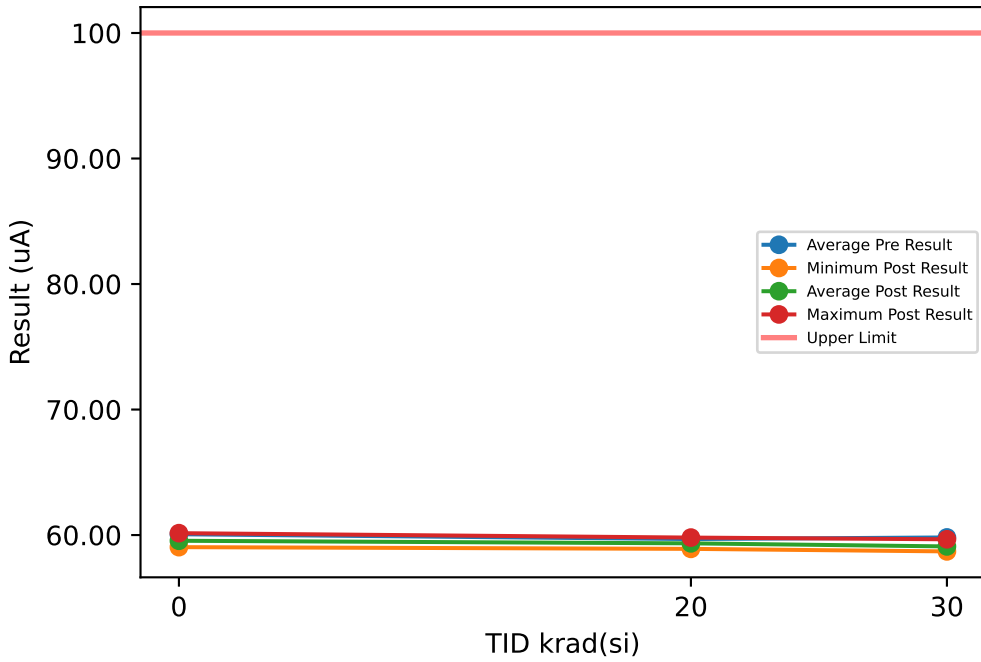

Test Results (Upper Limit = 100.0 (uA))

Serial #	krad(si)	Exposure Conditions	Pre Result	Post Result	Delta
50	20	LDR biased	59.721	59.389	-0.3323
51	20	LDR biased	59.392	59.252	-0.1408
52	20	LDR biased	59.783	59.799	0.0162
53	20	LDR biased	59.03	58.9	-0.1303
54	20	LDR biased	59.506	59.115	-0.391
55	30	LDR biased	60.115	59.662	-0.4525
56	30	LDR biased	59.9	59.273	-0.627
57	30	LDR biased	59.264	58.698	-0.5662
58	30	LDR biased	59.682	59.095	-0.5864
59	30	LDR biased	59.939	59.411	-0.5284
60	20	LDR unbiased	60.273	59.545	-0.7277
61	20	LDR unbiased	59.811	59.252	-0.5594
62	20	LDR unbiased	59.779	59.447	-0.3323
63	20	LDR unbiased	59.529	59.037	-0.4924
64	20	LDR unbiased	59.979	59.662	-0.3166
65	30	LDR unbiased	59.772	58.782	-0.9895
66	30	LDR unbiased	59.995	59.058	-0.9367
67	30	LDR unbiased	59.763	59.011	-0.7527
68	30	LDR unbiased	59.9	59.095	-0.805
69	30	LDR unbiased	59.772	58.862	-0.9101
70	0	correlation	60.053	59.252	-0.8015
71	0	correlation	59.978	59.213	-0.7653
72	0	correlation	60.429	60.073	-0.3567
73	0	correlation	59.635	59.037	-0.5987
74	0	correlation	60.229	60.151	-0.0782

TID vs Post - Pre Exposure Delta

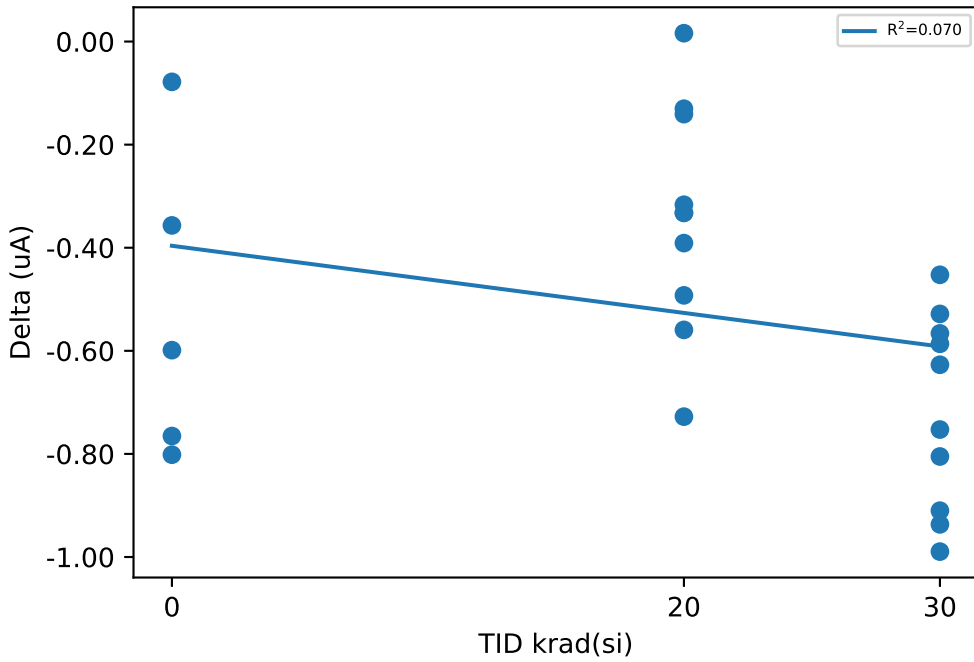

Test Statistics (uA)

krad(si)	Pre Exposure Min	Pre Exposure Avg	Pre Exposure Max	Pre Exposure Std	Post Exposure Min	Post Exposure Avg	Post Exposure Max	Post Exposure Std	Min Delta	Avg Delta	Max Delta	Std Delta
0	59.635	60.065	60.429	0.29664	59.037	59.545	60.151	0.5245	-0.8015	-0.52008	-0.0782	0.30309
20	59.03	59.68	60.273	0.33959	58.9	59.34	59.799	0.28331	-0.7277	-0.34066	0.0162	0.21997
30	59.264	59.81	60.115	0.23072	58.698	59.095	59.662	0.29268	-0.9895	-0.71545	-0.4525	0.18922

C Revision History

Changes from Revision A (August 2023) to Revision B (November 2023)

Page

- Updated LDR to include 30krad(Si)..... 1
- Updated LDR details for 30krad(Si).....2

Changes from Revision * (August 2023) to Revision A (October 2023)

Page

- Updated LDR to [Abstract](#) section..... 1
- Added LDR details and updated [Figure 1-1](#) and [Figure 1-2](#)2
- Added test description and facility information for LDR data.....3
- Updated pin names in bias diagram3
- Added link for Appendix B: LDR TID Report..... 5
- Changed the section title from *Specification Compliance Matrix* to *Data Sheet Electrical Parameters* 6
- Updated the *Tests* column in [Table 3-1](#) 6
- Updated the link for the single-event effects report in [Applicable Documents](#)11
- Added [Appendix B: LDR TID Report](#) for LDR data.....13

IMPORTANT NOTICE AND DISCLAIMER

TI PROVIDES TECHNICAL AND RELIABILITY DATA (INCLUDING DATA SHEETS), DESIGN RESOURCES (INCLUDING REFERENCE DESIGNS), APPLICATION OR OTHER DESIGN ADVICE, WEB TOOLS, SAFETY INFORMATION, AND OTHER RESOURCES "AS IS" AND WITH ALL FAULTS, AND DISCLAIMS ALL WARRANTIES, EXPRESS AND IMPLIED, INCLUDING WITHOUT LIMITATION ANY IMPLIED WARRANTIES OF MERCHANTABILITY, FITNESS FOR A PARTICULAR PURPOSE OR NON-INFRINGEMENT OF THIRD PARTY INTELLECTUAL PROPERTY RIGHTS.

These resources are intended for skilled developers designing with TI products. You are solely responsible for (1) selecting the appropriate TI products for your application, (2) designing, validating and testing your application, and (3) ensuring your application meets applicable standards, and any other safety, security, regulatory or other requirements.

These resources are subject to change without notice. TI grants you permission to use these resources only for development of an application that uses the TI products described in the resource. Other reproduction and display of these resources is prohibited. No license is granted to any other TI intellectual property right or to any third party intellectual property right. TI disclaims responsibility for, and you will fully indemnify TI and its representatives against, any claims, damages, costs, losses, and liabilities arising out of your use of these resources.

TI's products are provided subject to [TI's Terms of Sale](#) or other applicable terms available either on [ti.com](https://www.ti.com) or provided in conjunction with such TI products. TI's provision of these resources does not expand or otherwise alter TI's applicable warranties or warranty disclaimers for TI products.

TI objects to and rejects any additional or different terms you may have proposed.

Mailing Address: Texas Instruments, Post Office Box 655303, Dallas, Texas 75265
Copyright © 2023, Texas Instruments Incorporated