

TPS2661EVM: Evaluation Module for TPS2661x Current-Loop Protector



ABSTRACT

This user's guide describes the evaluation module (EVM) for the Texas instruments TPS2661x current-loop protector. The document provides EVM configuration information and test setup details for evaluating the TPS26610 and TPS26612 devices. The EVM schematic, board layout, and bill of materials (BOM) are also included.

Note

The TPS26611, TPS26613 and TPS26614 devices can also be evaluated on this EVM by replacing the TPS26610 (U1) device.

Table of Contents

1 Introduction	2
2 Description	3
3 Schematic	4
4 General Configurations	5
5 Test Setup and Procedures	7
6 EVAL Board Assembly Drawings and Layout Guidelines	22
7 Bill Of Materials (BoM)	24
8 Revision History	26

List of Figures

Figure 3-1. TPS2661EVM eFuse Evaluation Board Schematic.....	4
Figure 5-1. TPS2661EVM Setup With Test Equipment.....	7
Figure 5-2. Current Limit Behavior of TPS26610 for $I_{OUT} > 2 \times I_{OL}$ With MODE = 180 k Ω	8
Figure 5-3. Current Limit Behavior of TPS26610 for $I_{OUT} > 2 \times I_{OL}$ With MODE = 180 k Ω (Zoomed).....	9
Figure 5-4. TPS26610 Response During Recovery From Overload Fault.....	9
Figure 5-5. Output Short-Circuit Response of TPS26610 Device.....	10
Figure 5-6. Output Short-Circuit Response of TPS26610 Device (Zoomed).....	11
Figure 5-7. Input Undervoltage Protection Response of TPS26610 Device.....	12
Figure 5-8. Output Undervoltage Protection Response of TPS26610 Device.....	13
Figure 5-9. Output Overvoltage Protection Response of TPS26610 Device.....	14
Figure 5-10. Current-Limit Behavior of TPS26612.....	15
Figure 5-11. Current-Limit Behavior of TPS26612 Under Sustained Overload.....	16
Figure 5-12. Current Limit Behavior of TPS26613 for $V_{IN} < -V_s$	17
Figure 5-13. IEC61000-4-5 (+1 kV, 42 Ω) Signal Line Surge Immunity With TVS3301 at Input of CH1.....	18
Figure 5-14. IEC61000-4-5 (-1 kV, 42 Ω) Signal Line Surge Immunity With TVS3301 at Input of CH1.....	19
Figure 5-15. IEC61000-4-5 (+1 kV, 42 Ω) Signal Line Surge Immunity With TVS3301 at Output of CH2.....	20
Figure 5-16. IEC61000-4-5 (-1 kV, 42 Ω) Signal Line Surge Immunity With TVS3301 at Output of CH2.....	21
Figure 6-1. TPS2661EVM Board Assembly.....	22
Figure 6-2. TPS2661EVM Board Top Layer.....	22
Figure 6-3. TPS2661EVM Board Bottom Layer.....	23

List of Tables

Table 2-1. TPS2661EVM eFuse Evaluation Board Options and Setting.....	3
Table 4-1. Input and Output Connector Functionality.....	5
Table 4-2. Test Points Description.....	5

Table 4-3. Jumper and LED Descriptions.....	5
Table 5-1. Default Jumper Setting for TPS2661EVM eFuse Evaluation Board.....	7
Table 7-1. TPS2661EVM Bill of Materials.....	24

Trademarks

All trademarks are the property of their respective owners.

1 Introduction

The TPS2661EVM allows reference circuit evaluation of the TPS26610 and TPS26612 current-loop protector from TI. The TPS2661x device is a 50-V, universal (± 20 mA, 0 to 20 mA, 4–20 mA) current-loop protector with integrated fixed bipolar 30-mA current limit and output overvoltage protection. The device provides protection against miswiring conditions on input/output and offers robust signal-line protection in industrial and process automation systems.

1.1 EVM Features

TPS2661EVM board features include:

- Bidirectional current input for CH1, range: ± 20 mA
- Onboard selectable 3 burden resistors for CH1: 50 Ω , 100 Ω , 250 Ω
- Voltage Input on CH2
- Onboard Power Amplifier OPA551 on CH2 for providing power for Analog output on CH2
- Gain options of 1, 2.5, and 4 for CH2 with provision to compensate for ON resistance of the TPS2661x
- Selectable overload response using jumpers on MODE pin
- IEC61000-4-5 Signal Line Surge (± 1 kV, 42 Ω) Immunity with TVS3301 on Input (CH1) and Output (CH2)
- External LED to indicate status of the system

1.2 EVM Applications

Use this EVM on the following applications:

- Factory automation and control – PLCs- analog input/output module
- Motor drives control
- HART
- HVAC controllers
- Thermal controller
- UART IO protection

2 Description

The TPS2661EVM evaluation board enables evaluation of TPS26610 and TPS26612 current loop protectors. The input signal is applied between connectors J1 and J13 while J3 and J9 provides the output connection to the load; see the schematic in [Figure 3-1](#), and EVM test setup in [Figure 5-1](#). U1 in channel-1 provides current input protection and U3 in channel-2 provides output analog output protection and sensor supply protection.

LEDs D1 (D5) provide visual indication when the device U1 (U3) operates outside normal operating conditions. [Table 2-1](#) details the eFuse options and settings.

Table 2-1. TPS2661EVM eFuse Evaluation Board Options and Setting

Part Number	EVM Function	Channel	IN Range	Overload Response	Application
TPS2661EVM Evaluation Board	Current input protection on CH1, analog output protection and sensor supply protection on CH2	CH1 – TPS26610	Current input range: ± 20 mA	Depends on MODE pin selection. See Section 8.4 in the data sheet for the details	Analog input protection for current inputs
		CH2 – TPS26612	Voltage input range: 0 to +Vs		Analog module output port protection

Note

TVS diodes U6 and U7 are required when burden resistor (R8–R11) is floating, jumpers J17 and J19 are open (burden resistor is not connected to GND).

3 Schematic

Figure 3-1 illustrates the EVM schematic.

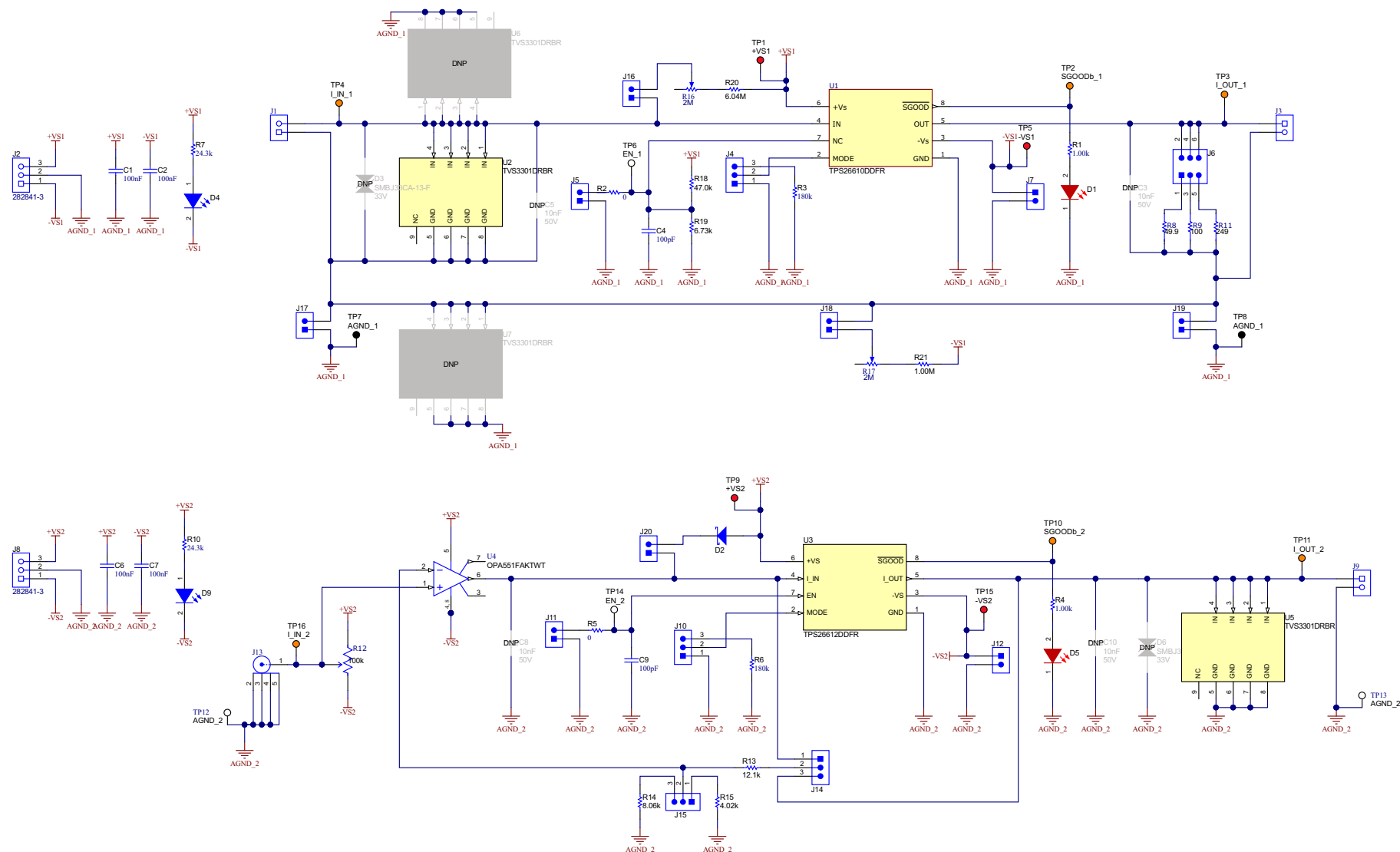

Figure 3-1. TPS2661EVM eFuse Evaluation Board Schematic

4 General Configurations

4.1 Physical Access

Table 4-1 lists the TPS2661EVM evaluation board input and output connector functionality. Table 4-2 and Table 4-3 describe the test point availability and the jumper functionality.

Table 4-1. Input and Output Connector Functionality

Connector	Channel	Label	Description
J1	CH1	I_IN_1, AGND_1	CH1 - Signal input connector
J3	CH1	I_OUT_1, AGND_1	CH1 - Signal output connector
J2	CH1	+VS1, AGND_1, - VS1	CH1 - Supply for powering the device
J13	CH2	I_IN_2, AGND_2	CH2 - Signal input connector
J9	CH2	I_OUT_2, AGND_2	CH2 - Signal output connector
J8	CH2	+VS2, AGND_2, - VS2	CH2 - Supply for powering the device

Table 4-2. Test Points Description

Test Points	Label	Description
TP1	+VS1	Positive supply for U1
TP2	S GOODb_1	Signal good indicator for CH1
TP3	I_OUT_1	Signal output for CH1
TP4	I_IN_1	Signal input for CH1
TP5	-VS1	Negative supply for U1
TP6	EN_1	Enable control for CH1
TP7, TP8	AGND_1	Reference ground for CH1
TP9	+VS2	Positive supply for U3
TP10	S GOODb_2	Signal good indicator for CH2
TP11	I_OUT_2	Signal output for CH2
TP12, TP13	AGND_2	Reference ground for CH2
TP14	EN_2	Enable control for CH2
TP15	-VS2	Negative supply for U3
TP16	I_IN_2	Signal input for CH2

Table 4-3. Jumper and LED Descriptions

Jumper	Label	Description
J4, J10	MODE	Overload Response Setting Leaving J4 OPEN sets MODE = OPEN 1–2 Position connects MODE pin to GND 2–3 Position connects 180 k Ω from MODE pin to GND
J5, J11	EN	EN has internal pullup and it can be left floating to enable the device Pull EN low to turn off the device
J6	R_burden	Jumper to select burden resistor 1–2 Position connects 49.9 Ω as burden resistor 3–4 Position connects 100 Ω as burden resistor 5–6 Position connects 249 Ω as burden resistor Leave J6 OPEN to connect load externally
J7	-VS1	Install to use U1 in single supply configuration
J12	-VS2	Install to use U3 in single supply configuration
J14	Feedback selection jumper	Jumper to select the feedback point 1–2 Position does not compensation the voltage drop in the eFuse 2–3 Position compensates the voltage drop in the eFuse

Table 4-3. Jumper and LED Descriptions (continued)

Jumper	Label	Description
J15	Feedback gain selection	Jumper to select the feedback gain 1–2 Position sets gain of 4 2–3 Position sets gain of 2.5
J16, J18	Bias resistors	Install to connect bias resistors on the signal lines
J17, J19	AGND_1	Install to connect signal return to the ground
J20	—	Install to configure the device U3 as power supply protection for 2-wire transmitter

4.2 Test Equipment and Setup

4.2.1 Power Supplies

One dual polarity regulated power supply: +15 V : 0 V : –15 V, 500-mA current limit.

One source meter of 200 mA, 50-V rated

4.2.2 Meters

One DMM minimum needed.

4.2.3 Oscilloscope

A DPO2024 or equivalent, three 10 × voltage probes, and a DC current probe.

4.2.4 Loads

One decade resistance box or equivalent which can tolerate 50 V and capable of the output short.

5 Test Setup and Procedures

In this user's guide, the test procedure is described for the TPS26610 and TPS26612 devices.

Make sure the evaluation board has default jumper settings as shown in [Table 5-1](#).

Table 5-1. Default Jumper Setting for TPS2661EVM eFuse Evaluation Board

J4	J5	J6	J7	J10	J11	J12	J14	J15	J16	J17	J18	J19	J20
1-2	Open	1-2	Open	2-3	Open	Open	2-3	2-3	Open	Install	Open	Install	Open

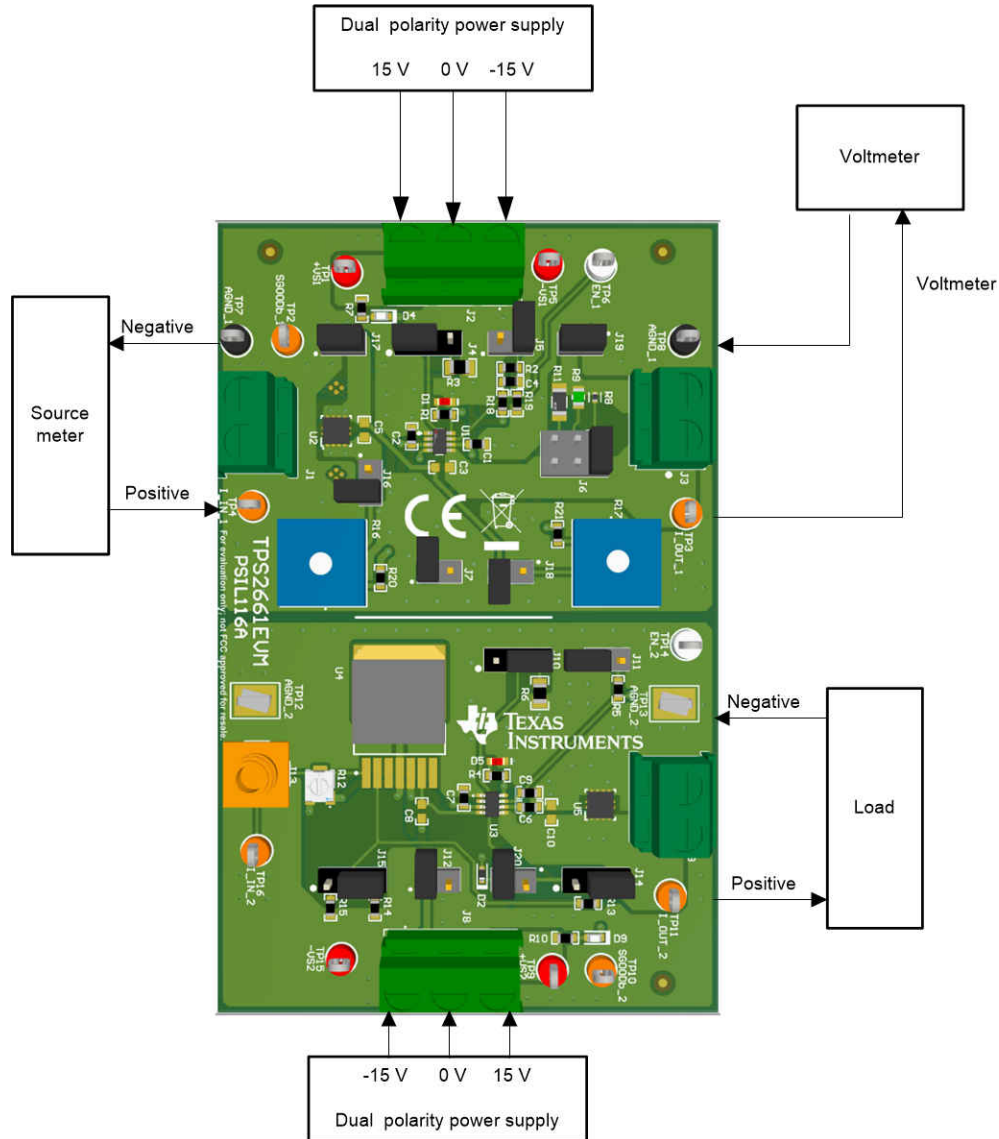

Figure 5-1. TPS2661EVM Setup With Test Equipment

5.1 Overload Protection Test

Use the following instructions to evaluate current limit behavior of the TPS26610 (U1):

1. Set the jumper setting J4 in 2–3 position to set MODE = 180 k Ω
2. Install jumper J6 in 1-2 position to connect 49.9 Ω as burden resistor
3. Set dual polarity regulated power supply to +15 V : 0 V : -15 V and apply the power at connector J2
4. Apply a voltage of 1.6 V at I_IN_1 and then step-up to 8 V to emulate overload situation on TPS26610
5. The device limits the current to 60 mA for approximately 50 ms and after that the current is limited to 30 mA for approximately 100-ms time and then auto retries for every 1.6 s
6. Step-down the voltage at I_IN_1 to 1.6 V to remove the overload fault

Figure 5-2 and Figure 5-3 show current limit behavior captured on the TPS2661EVM eFuse Evaluation Board. Figure 5-4 shows device response during recovery from overload fault.

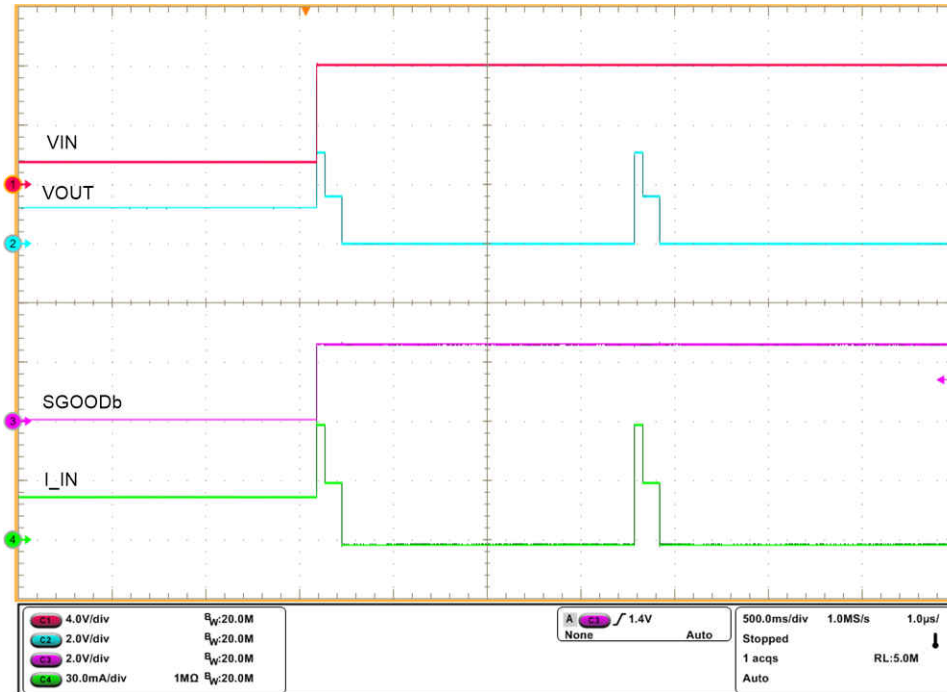

Figure 5-2. Current Limit Behavior of TPS26610 for $I_{OUT} > 2 \times I_{OL}$ With MODE = 180 k Ω

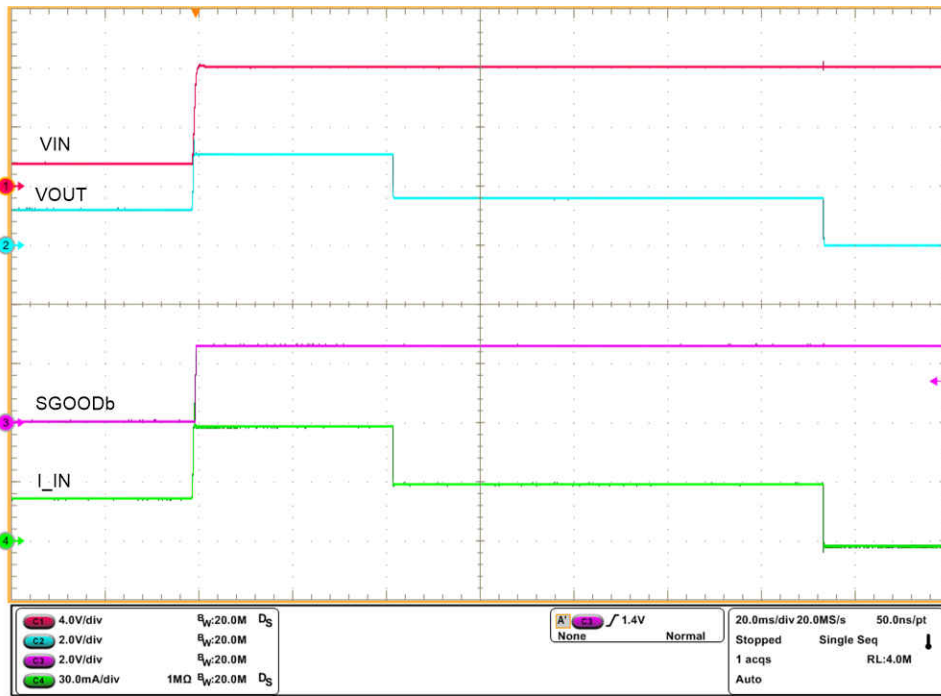

Figure 5-3. Current Limit Behavior of TPS26610 for $I_{OUT} > 2 \times I_{OL}$ With MODE = 180 kΩ (Zoomed)

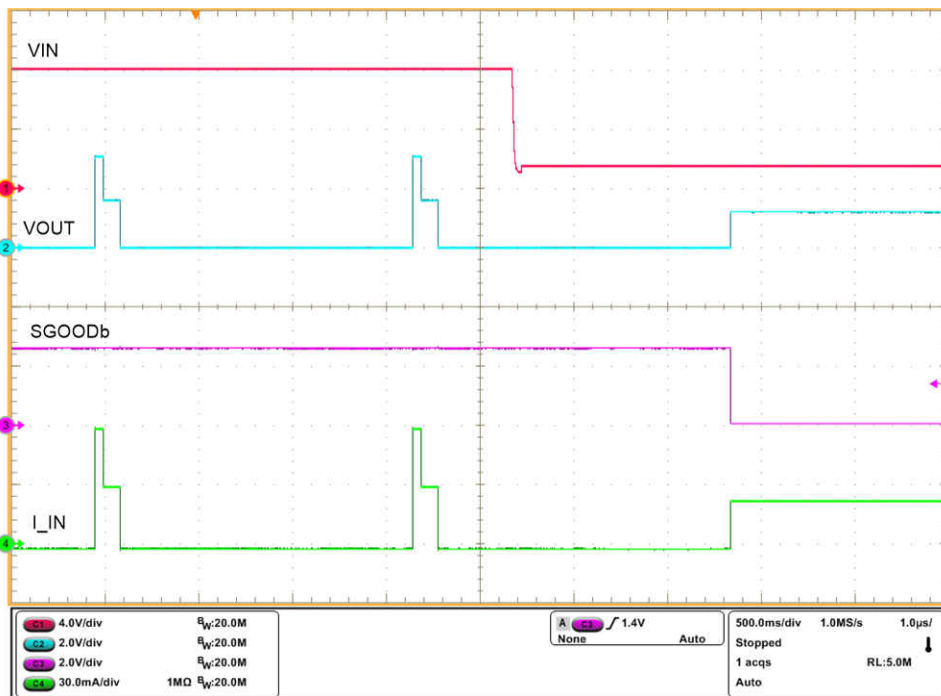

Figure 5-4. TPS26610 Response During Recovery From Overload Fault

5.2 Output Short-Circuit Test

Use the following instructions to perform an output short-circuit test on TPS26610 (U1):

1. Set the jumper setting J4 in 2–3 position to set MODE = 180 k Ω
2. Open jumper J6
3. Set dual polarity regulated power supply to +15 V : 0 V : –15 V and apply the power at connector J2
4. Apply a voltage of 12 V at I_IN_1
5. Short the output of the device for example, I_OUT_1 to AGND_1 with a shorter cable
6. Observe the waveforms using an oscilloscope

Figure 5-5 and Figure 5-6 show test waveforms of output hot-short on the TPS2661 eFuse evaluation board.

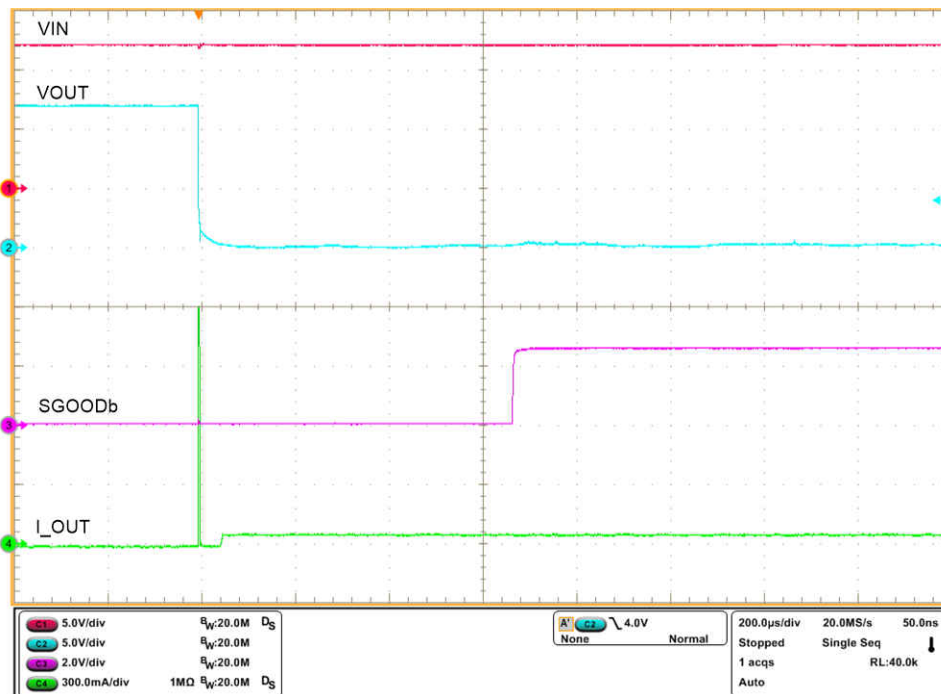

Figure 5-5. Output Short-Circuit Response of TPS26610 Device

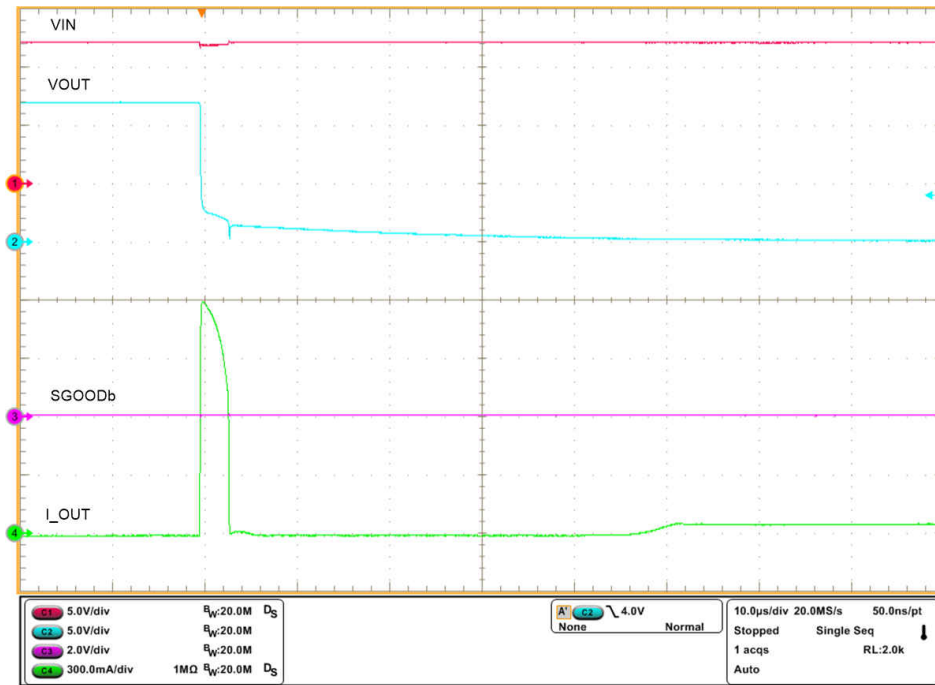

Figure 5-6. Output Short-Circuit Response of TPS26610 Device (Zoomed)

5.3 Input Undervoltage Protection Test

Use the following instructions to perform input undervoltage protection test:

1. Set dual polarity regulated power supply to +15 V : 0 V : -15 V and apply the power at connector J2
2. OPEN jumper J6
3. Connect a load of 3 kΩ between I_OUT_1 and AGND_1 at connector J3
4. Apply a voltage of 0 V at I_IN_1 and gradually decrease the voltage to -15.4 V to trigger the input undervoltage fault
5. Observe the waveforms using an oscilloscope

Figure 5-7 shows input undervoltage protection response of TPS26610 on TPS2661EVM eFuse Evaluation Board.

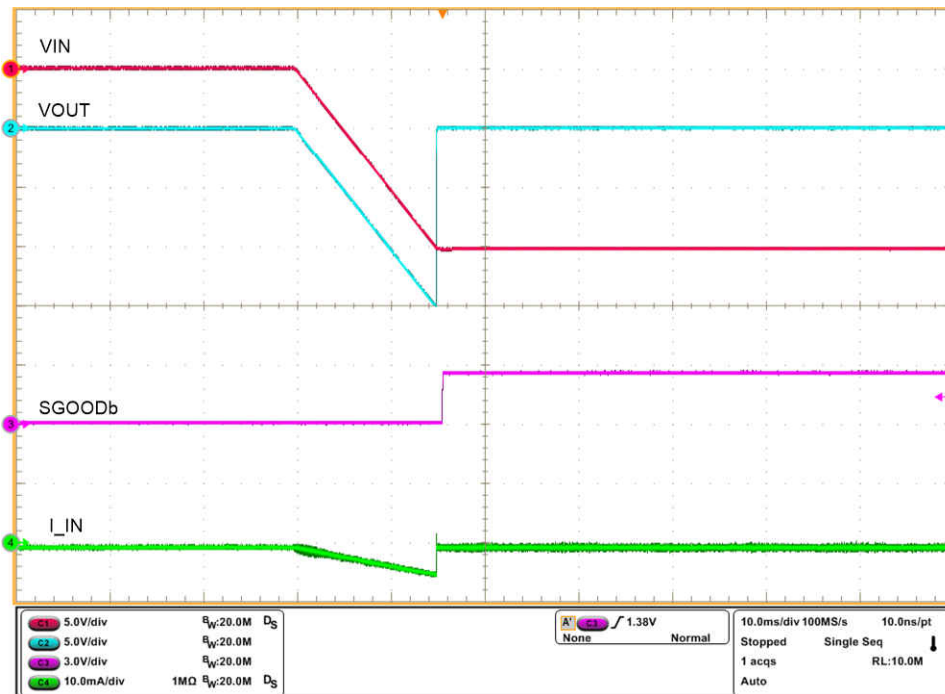

Figure 5-7. Input Undervoltage Protection Response of TPS26610 Device

5.4 Output Undervoltage Protection Test

Use the following instructions to perform output undervoltage protection test:

1. Set dual polarity regulated power supply to +15 V : 0 V : -15 V and apply the power at connector J2
2. Connect a load of 3 k Ω between I_IN_1 and AGND_1 at connector J1
3. Apply a voltage of 0 V at I_OUT_1 and gradually decrease the voltage to -15.4 V to trigger the output undervoltage fault
4. Observe the waveforms using an oscilloscope

Figure 5-8 shows output undervoltage protection response of TPS26610 on TPS2661EVM eFuse Evaluation Board.

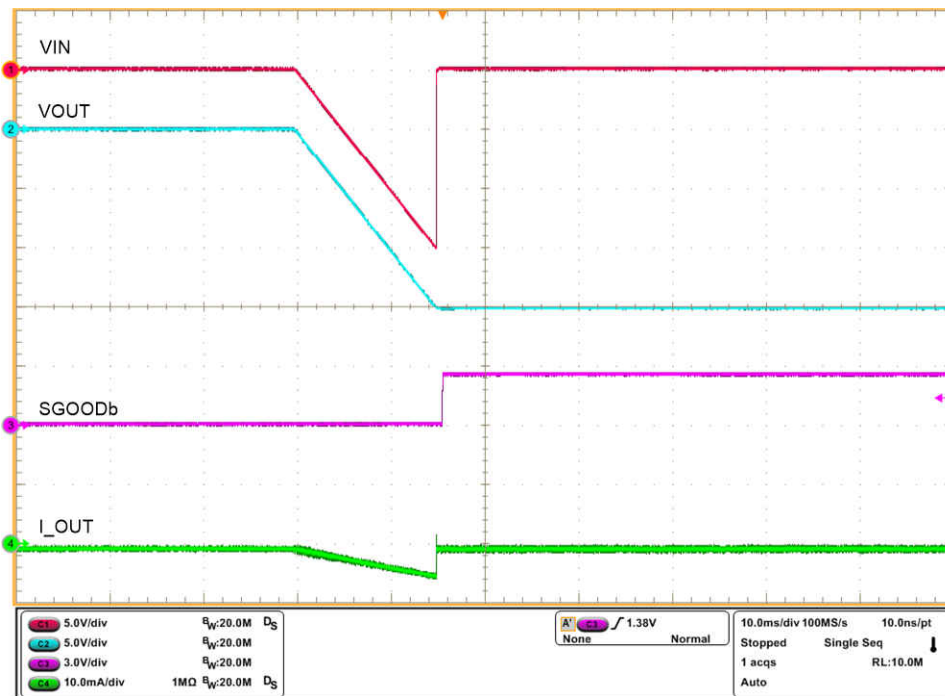

Figure 5-8. Output Undervoltage Protection Response of TPS26610 Device

5.5 Output Overvoltage Protection Test

Use the following instructions to perform output overvoltage protection test:

1. Set dual polarity regulated power supply to +15 V : 0 V : -15 V and apply the power at connector J2
2. Connect a load of 3 k Ω between I_IN_1 and AGND_1 at connector J1
3. Apply a voltage of 0 V at I_OUT_1 and gradually increase the voltage to 15.3 V to trigger the output overvoltage fault
4. Observe the waveforms using an oscilloscope

Figure 5-9 shows output overvoltage protection response of TPS26610 on TPS2661EVM eFuse evaluation board.

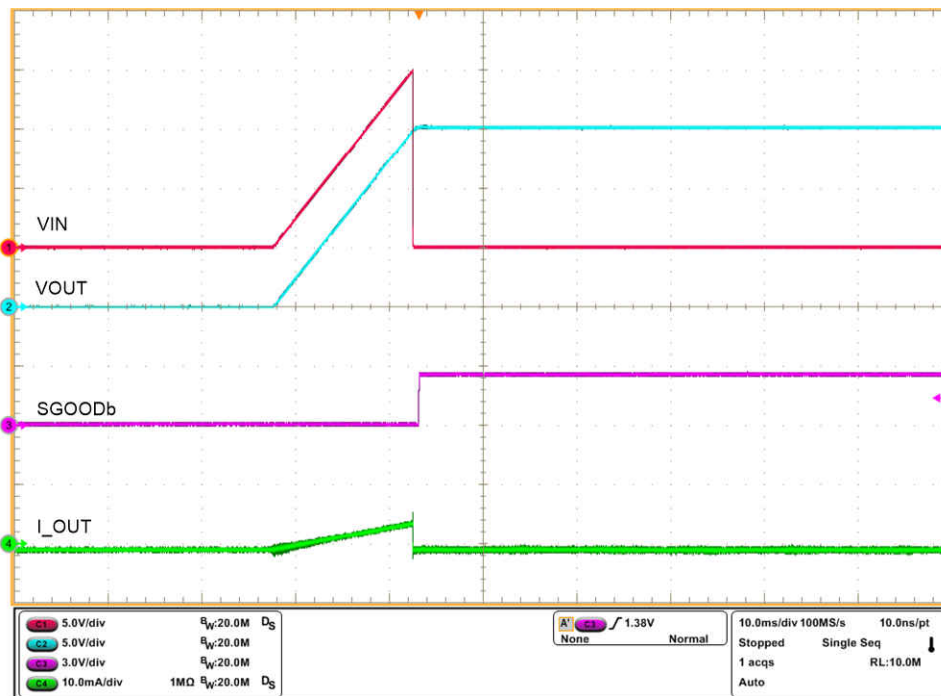

Figure 5-9. Output Overvoltage Protection Response of TPS26610 Device

5.6 TPS26612 Overload Protection Test

Use the following instructions to evaluate current limit behavior of TPS26612 (U3):

1. Set the jumper setting J10 in 1–2 position to set MODE = OPEN
2. Connect a load resistance of 1 k Ω between I_OUT_2 and AGND_2 at connector J9
3. Adjust potentiometer R12 to set 6V at I_IN_2 (J13/ TP16). This action results in a voltage of 15 V at the input of TPS26612 eFuse (U3)
4. Now apply load of 5 Ω between I_OUT_2 and AGND_2 to trigger overload fault
5. Observe the waveforms using an oscilloscope

Figure 5-10 and Figure 5-11 show current limit behavior of TPS26612 captured on the TPS2661EVM eFuse evaluation board.

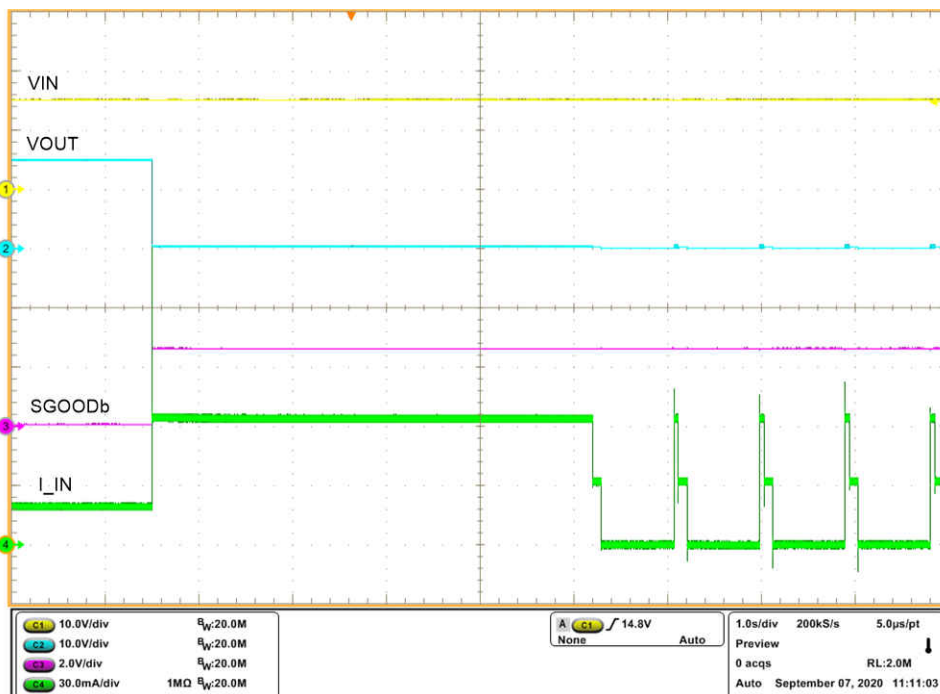

Figure 5-10. Current-Limit Behavior of TPS26612

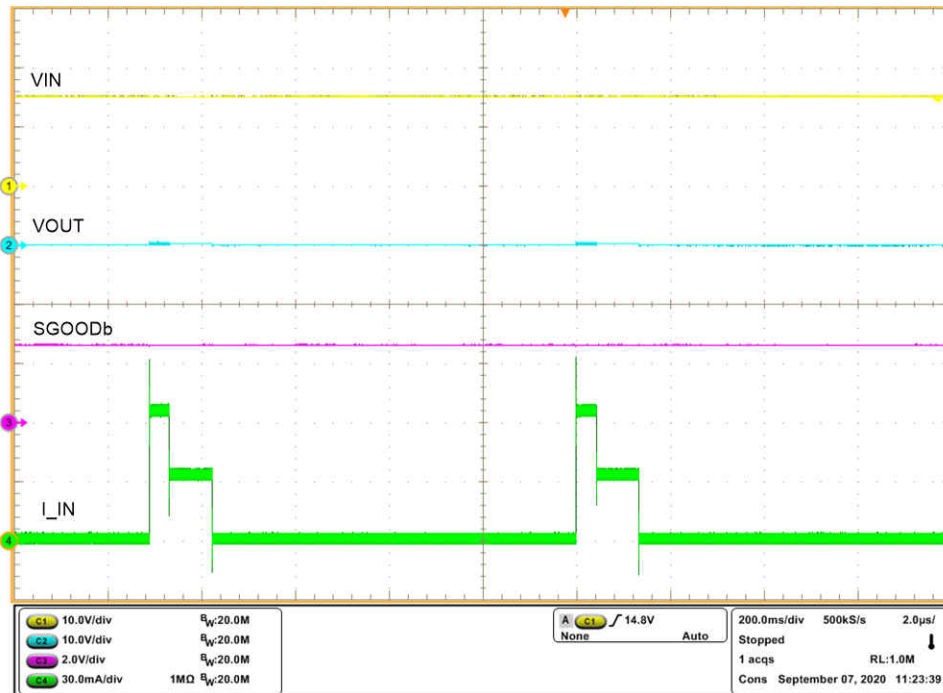

Figure 5-11. Current-Limit Behavior of TPS26612 Under Sustained Overload

5.7 Current Limiting for $V_{IN} < -V_S$

Use the following instructions to evaluate current limit behavior for input voltages lower than negative bias supply ($-V_S$):

1. Replace the TPS26610 with TPS26613 in U1 position
2. The current limiting behavior is independent of MODE setting for $V_{IN} < -V_S$, so jumper setting J4 can be in any position
3. Open jumper J6
4. Connect 600 Ω at terminal J3
5. Set dual polarity regulated power supply to +20 V : 0 V : -20 V and apply the power at connector J2
6. Apply a voltage of -24 V at I_IN_1
7. The device limits the current to 32 mA for approximately 100 ms and then auto retries for every 800 ms

Figure 5-12 shows current limit behavior captured on the TPS2661EVM with TPS26613 in U1 position.

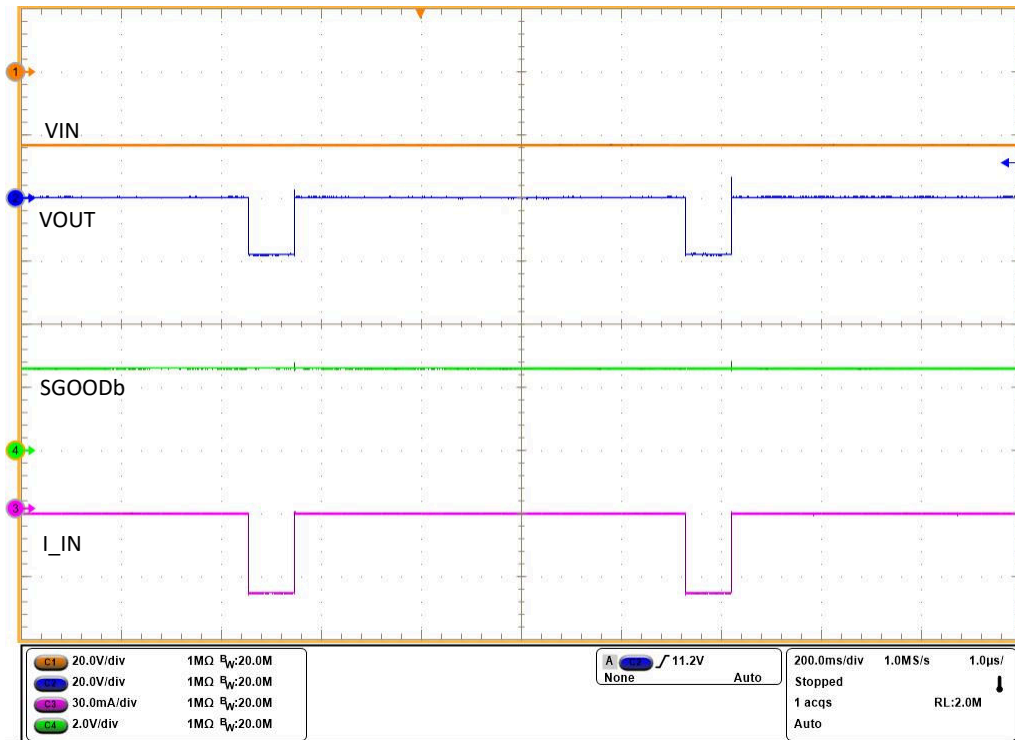

Figure 5-12. Current Limit Behavior of TPS26613 for $V_{IN} < -V_s$

5.8 Surge Protection Test (Current Input, CH1)

Use the following instructions to perform surge test on the current input channel-1:

1. Set dual polarity regulated power supply to +15 V : 0 V : -15 V and apply the power at connector J2
2. Install jumper J6 in 5-6 position to connect 249 Ω as burden resistor
3. Set the source meter to 20 mA and connector to PSIL116 at J1
4. Use UCS500N to generate surge pulses. Set the test voltage to ± 1 kV and coupling impedance to 42 Ω as specified by IEC61000-4-5 to check the signal line transient immunity
5. Connect the surge pulse generator UCS500N at J1 and enable it
6. Observe the waveforms using an oscilloscope

Figure 5-13 and Figure 5-14 show surge performance for current inputs with TPS26610 on the TPS2661EVM eFuse evaluation board.

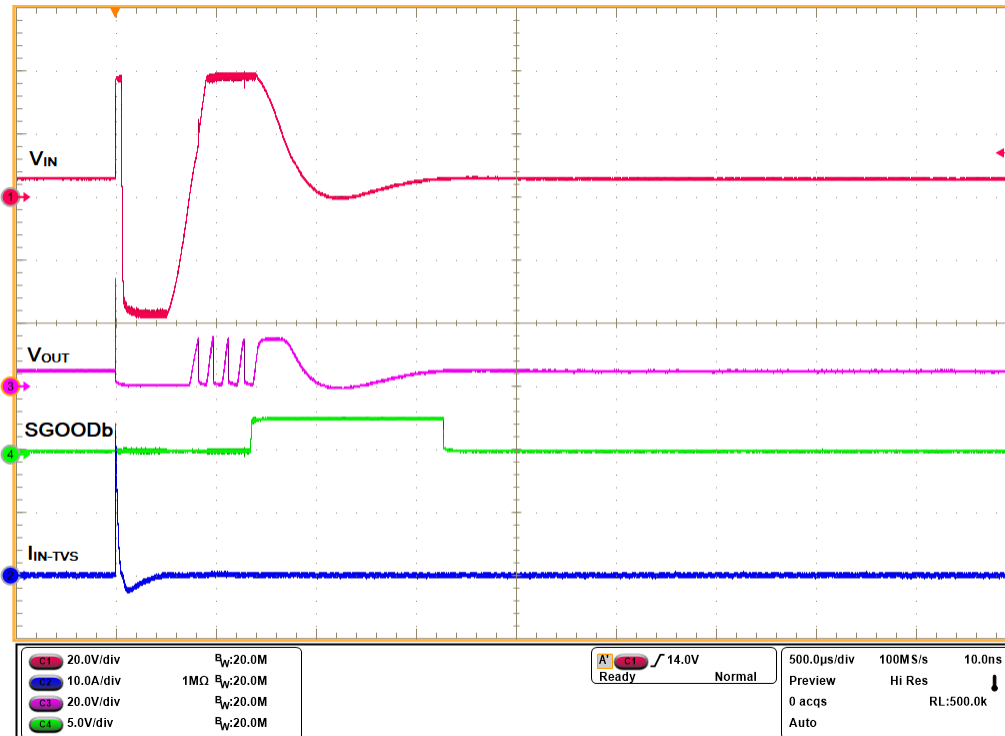

Figure 5-13. IEC61000-4-5 (+1 kV, 42 Ω) Signal Line Surge Immunity With TVS3301 at Input of CH1

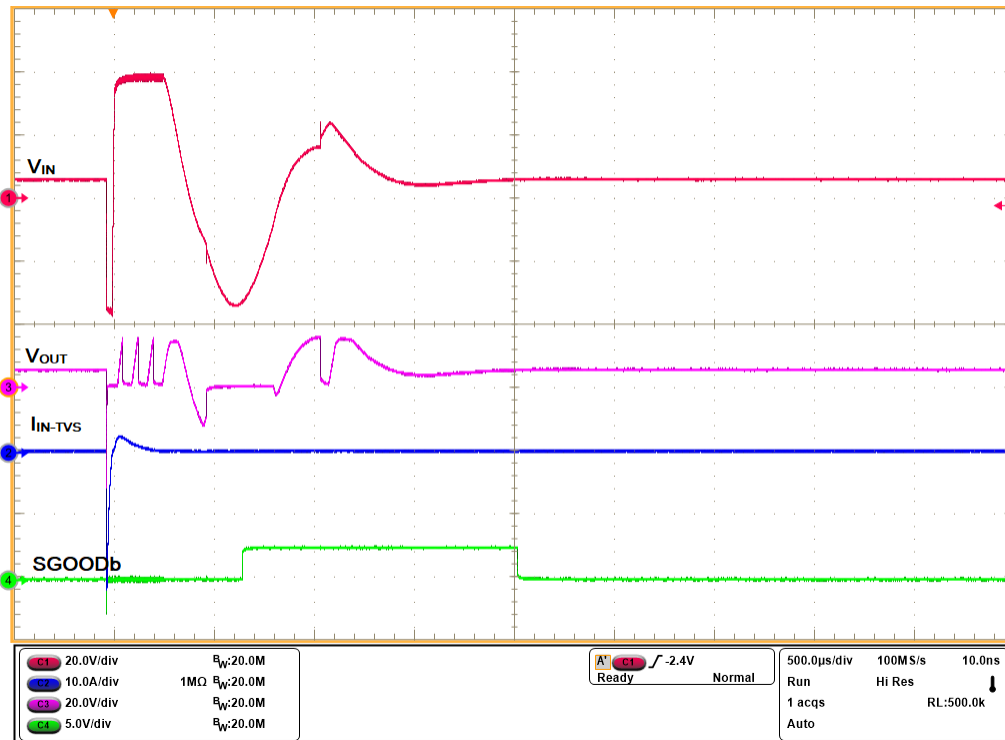

Figure 5-14. IEC61000-4-5 (-1 kV, 42 Ω) Signal Line Surge Immunity With TVS3301 at Input of CH1

5.9 Surge Protection Test (Analog Output, CH2)

Use the following instructions to perform surge test on the analog output in channel-2:

1. Set dual polarity regulated power supply to +15 V : 0 V : -15 V and apply the power at connector J8
2. Connect load resistor of 2 k Ω at the output
3. Adjust the potentiometer R12 to set 10 V at the input of TPS26612
4. Use UCS500N to generate surge pulses. Set the test voltage to ± 1 kV and coupling impedance to 42 Ω as specified by IEC61000-4-5 to check the signal line transient immunity
5. Connect the surge pulse generator UCS500N at J9 and enable it
6. Observe the waveforms using an oscilloscope

Figure 5-15 and Figure 5-16 show surge performance for current inputs with TPS26610 on the TPS2661EVM eFuse evaluation board.

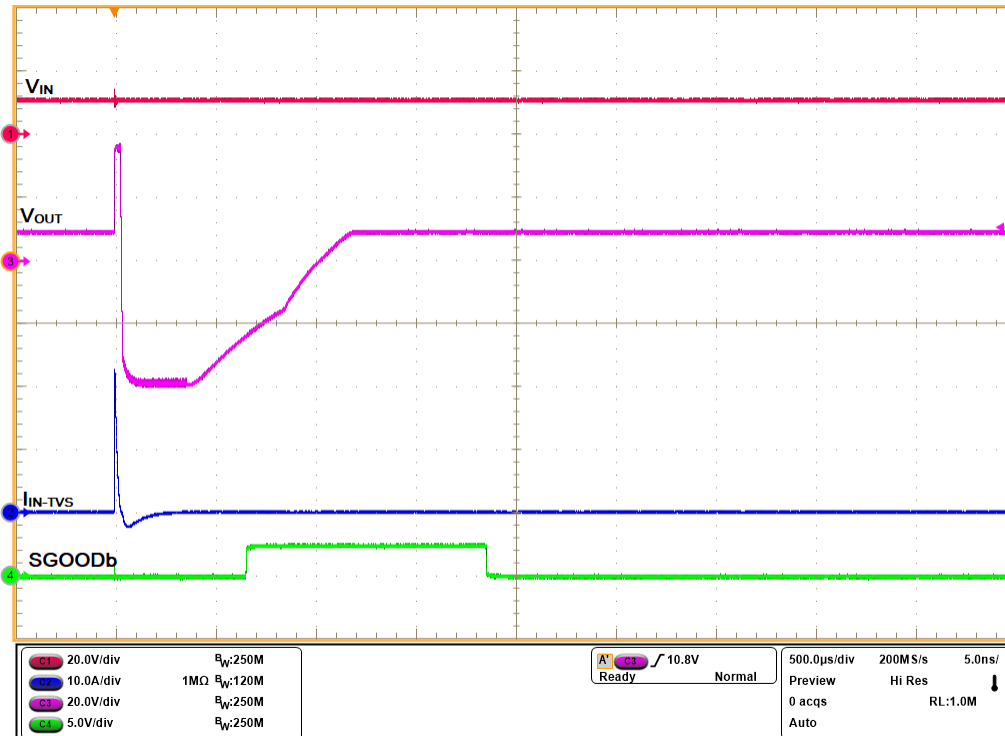

Figure 5-15. IEC61000-4-5 (+1 kV, 42 Ω) Signal Line Surge Immunity With TVS3301 at Output of CH2

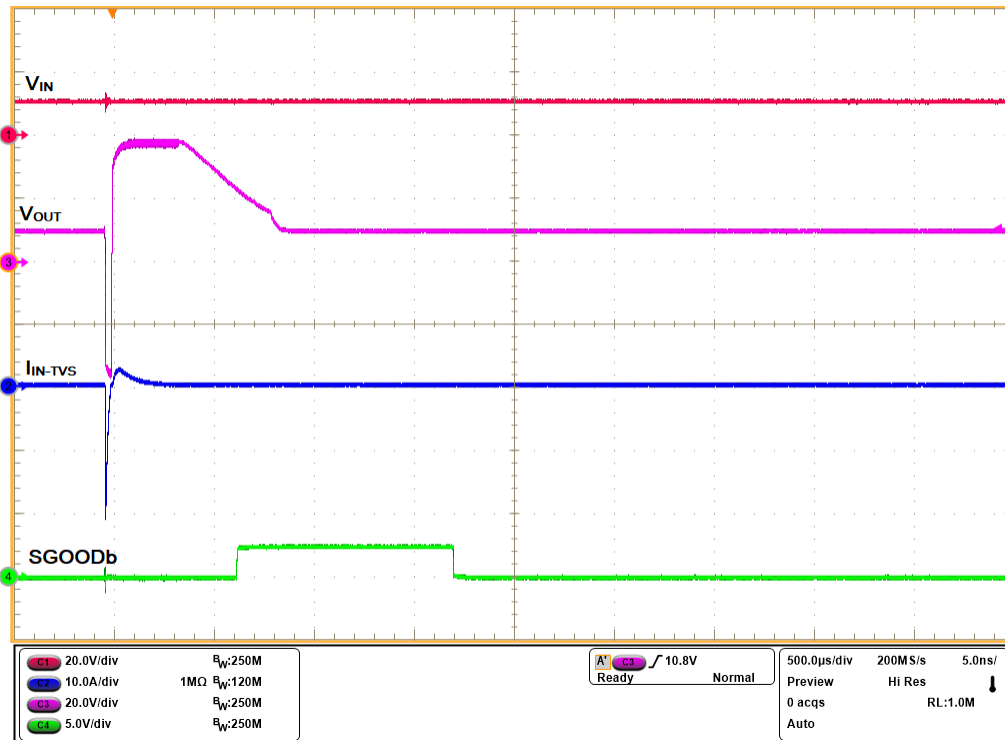

Figure 5-16. IEC61000-4-5 (-1 kV, 42 Ω) Signal Line Surge Immunity With TVS3301 at Output of CH2

6 EVAL Board Assembly Drawings and Layout Guidelines

6.1 PCB Drawings

Figure 6-1 shows component placement of the EVAL Board, and Figure 6-2, Figure 6-3 show PCB layout images.

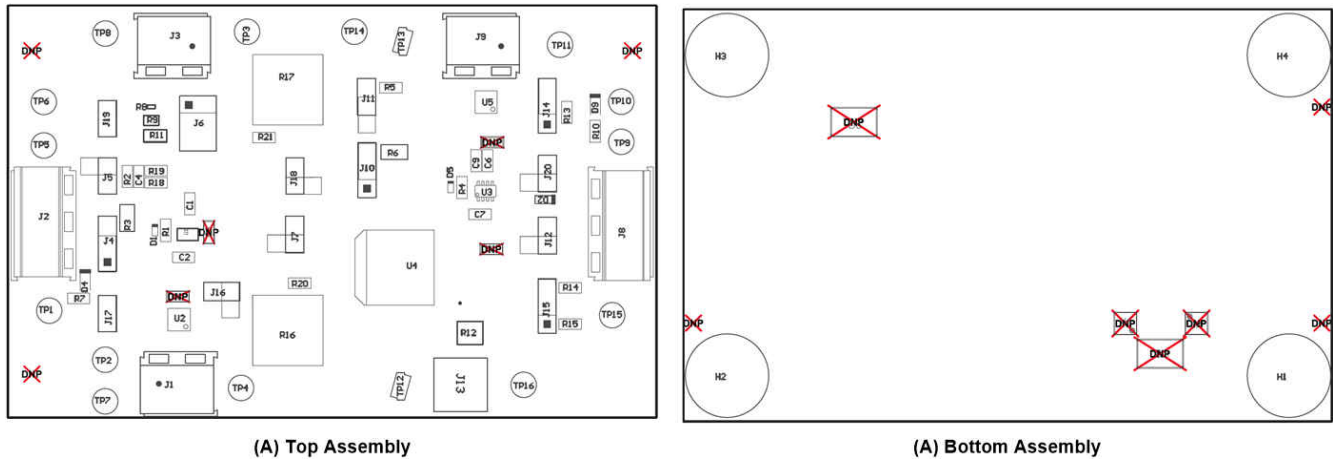

Figure 6-1. TPS2661EVM Board Assembly

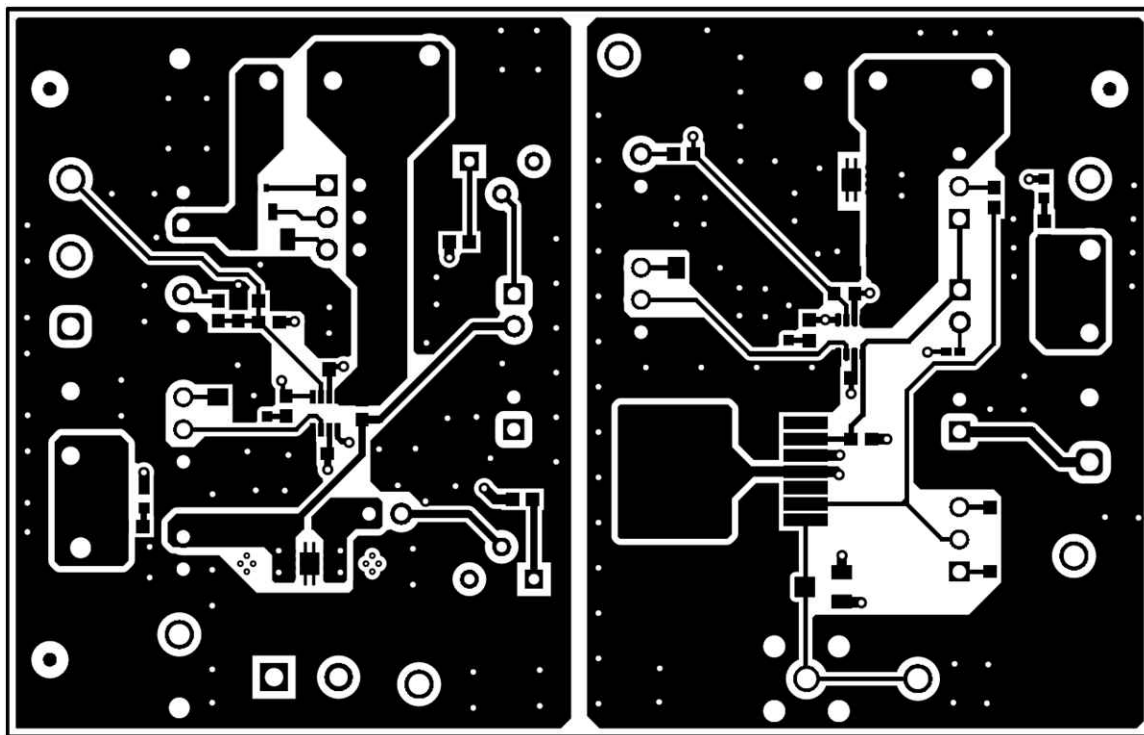

Figure 6-2. TPS2661EVM Board Top Layer

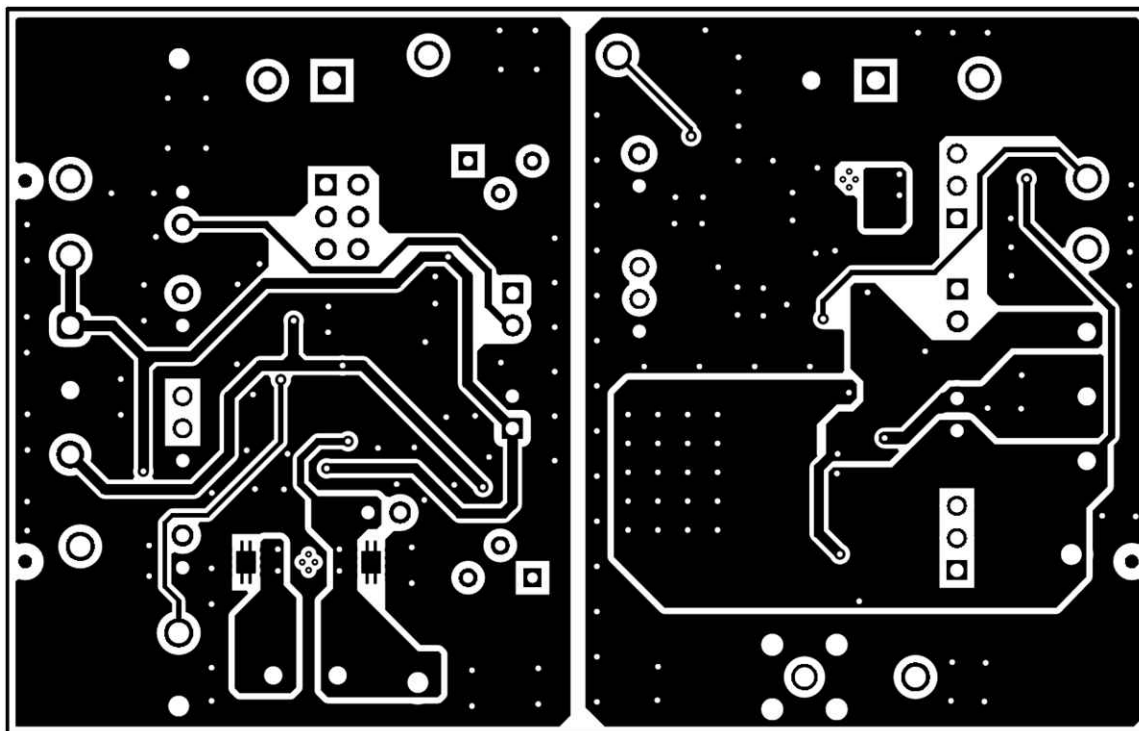

Figure 6-3. TPS2661EVM Board Bottom Layer

7 Bill Of Materials (BoM)

Table 7-1 lists the EVM BOM.

Table 7-1. TPS2661EVM Bill of Materials

Designator	QTY	Value	Description	Package Reference	Part Number	Manufacturer	Alternate Part Number ⁽¹⁾	Alternate Manufacturer ⁽¹⁾
!PCB1	1		Printed Circuit Board		PSIL116	Any		
C1, C2, C6, C7	4	0.1 uF	CAP, CERM, 0.1 uF, 50 V, ±10%, X7R, AEC-Q200 Grade 1, 0603	0603	C0603C104K5RACAUTO	Kemet		
C4, C9	2	100 pF	CAP, CERM, 100 pF, 25 V, ±10%, X7R, 0603	0603	06033C101KAT2A	AVX		
D1, D5	2	Red	LED, Red, SMD	Body1.6x0.8mm	APTD1608LSECK/J3-PF	Kingbright		
D2	1	45 V	Diode, Schottky, 45 V, 0.1 A, SOD-523	SOD-523	SDM10U45-7-F	Diodes Inc.		
D4, D9	2	Green	LED, Green, SMD	1.6x0.8x0.8mm	LTST-C190GKT	Lite-On		
H1, H2, H3, H4	4		Bumpon, Hemisphere, 0.44 X 0.20, Clear	Transparent Bumpon	SJ-5303 (CLEAR)	3M		
J1, J3, J9	3		Terminal Block, 2x1, 5.08mm, TH	10.16x15.2x9mm	282841-2	TE Connectivity		
J2, J8	2		Terminal Block, 5.08mm, 3x1, Tin, TH	Terminal Block, 5.08mm, 3x1, TH	282841-3	TE Connectivity		
J4, J10, J14, J15	4		Header, 100mil, 3x1, Tin, TH	Header, 3 PIN, 100mil, Tin	PEC03SAAN	Sullins Connector Solutions		
J5, J7, J11, J12, J16, J17, J18, J19, J20	9		Header, 100mil, 2x1, Gold, TH	Header, 100mil, 2x1, TH	HTSW-102-07-G-S	Samtec		
J6	1		Header, 100mil, 3x2, Tin, TH	3x2 Header	PEC03DAAN	Sullins Connector Solutions		
J13	1		SMA Straight Jack, Gold, 50 Ohm, TH	SMA Straight Jack, TH	901-144-8RFX	Amphenol RF		
R1, R4	2	1.00 k	RES, 1.00 k, 0.5%, 0.1 W, 0603	0603	RT0603DRD071KL	Yageo		
R2, R5	2	0	RES, 0, 5%, 0.1 W, 0603	0603	RC0603JR-070RL	Yageo		
R3, R6	2	180 k	RES, 180 k, 0.1%, 0.125 W, 0805	0805	RT0805BRD07180KL	Yageo America		
R7, R10	2	24.3 k	RES, 24.3 k, 1%, 0.1 W, AEC-Q200 Grade 0, 0603	0603	CRCW060324K3FKEA	Vishay-Dale		
R8	1	49.9	Res Thick Film 0402 49.9Ohm 0.1% 10ppm/K Paper T/R	0402	TNPW040249R9BYEP	Vishay		
R9	1	100	100 Ohms ±0.1% 0.2W, 1/5W Chip Resistor 0805 (2012 Metric) Anti-Sulfur, Automotive AEC-Q200, Moisture Resistant	0805	TNPW0805100RBYEN	Vishay		
R11	1	249	Res Precision Thin Film 1206 249 Ohm 0.1% 2/5W ±10ppm/°C Molded T/R	1206	RQ73C2B249RBDT	TE Connectivity		
R12	1	100 k	100 kOhms 0.125W, 1/8W J Lead Surface Mount Trimmer Potentiometer Cermet 1 Turn Top Adjustment	SMT_POT_3MM20_3MM51	22AR100KLFR	TT Electronics		
R13	1	12.1 k	RES, 12.1 k, 0.5%, 0.1 W, 0603	0603	RT0603DRE0712K1L	Yageo America		
R14	1	8.06 k	RES, 8.06 k, 0.5%, 0.1 W, 0603	0603	RT0603DRE078K06L	Yageo America		
R15	1	4.02 k	RES, 4.02 k, 0.5%, 0.1 W, 0603	0603	RT0603DRE074K02L	Yageo America		
R16, R17	2	2 M	TRIMMER, 2M ohm, 0.5W, TH	375x190x375mil	3386P-1-205LF	Bourns		
R18	1	47.0 k	RES, 47.0 k, 0.1%, 0.1 W, 0603	0603	RT0603BRD0747KL	Yageo America		
R19	1	6.73 k	RES, 6.73 k, 0.1%, 0.1 W, 0603	0603	RT0603BRD076K73L	Yageo America		

Table 7-1. TPS2661EVM Bill of Materials (continued)

Designator	QTY	Value	Description	Package Reference	Part Number	Manufacturer	Alternate Part Number ⁽¹⁾	Alternate Manufacturer ⁽¹⁾
R20	1	6.04 Meg	RES, 6.04 M, 1%, 0.1 W, AEC-Q200 Grade 0, 0603	0603	CRCW06036M04FKEA	Vishay-Dale		
R21	1	1.00 Meg	RES, 1.00 M, 0.5%, 0.1 W, AEC-Q200 Grade 0, 0603	0603	CRCW06031M00DHEAP	Vishay-Dale		
SH-J4, SH-J5, SH-J6, SH-J7, SH-J10, SH-J11, SH-J12, SH-J14, SH-J15, SH-J16, SH-J17, SH-J18, SH-J19, SH-J20	14	1x2	Shunt, 100mil, Flash Gold, Black	Closed Top 100mil Shunt	SPC02SYAN	Sullins Connector Solutions		
TP1, TP5, TP9, TP15	4		Test Point, Multipurpose, Red, TH	Red Multipurpose Testpoint	5010	Keystone		
TP2, TP3, TP4, TP10, TP11, TP16	6		Test Point, Multipurpose, Orange, TH	Orange Multipurpose Testpoint	5013	Keystone		
TP6, TP14	2		Test Point, Multipurpose, White, TH	White Multipurpose Testpoint	5012	Keystone		
TP7, TP8	2		Test Point, Multipurpose, Black, TH	Black Multipurpose Testpoint	5011	Keystone		
TP12, TP13	2		Test Point, Compact, SMT	Testpoint_Keystone_Compact	5016	Keystone		
U1	1		50 V, Universal 4-20 mA, ±20-mA Current Loop Protector with Input/Output Miswiring Protection	SOT23-8	TPS26610DDFR	Texas Instruments		
U2, U5	2		33 V Bidirectional Flat-Clamp Surge Protection Device, DRB0008A (VSON-8)	DRB0008A	TVS3301DRBR	Texas Instruments	TVS3301DRBT	Texas Instruments
U3	1		TPS26611, DDF0008A (SOT-23-THN-8)	DDF0008A	TPS26612DDFR	Texas Instruments	TPS26611DDFT	Texas Instruments
U4	1		High-Voltage, High-Current Operational Amplifier, 8 to 60 V, -55 to 125 degC, 7-Pin DDPACK (KTW), Green (RoHS & no Sb/Br), Tape and Reel	KTW0007A	OPA551FAKTWT			
C3, C5, C8, C10	0	0.01 uF	CAP, CERM, 0.01 uF, 50 V, ±10%, X7R, AEC-Q200 Grade 1, 0603	0603	GCM188R71H103KA37D	MuRata		
D3, D6	0	33 V	Diode, TVS, Bi, 33 V, SMB	SMB	SMBJ33CA-13-F	Diodes Inc.		
FID1, FID2, FID3, FID4, FID5, FID6	0		Fiducial mark. There is nothing to buy or mount.	N/A	N/A	N/A		
U6, U7	0		33 V Bidirectional Flat-Clamp Surge Protection Device, DRB0008A (VSON-8)	DRB0008A	TVS3301DRBR	Texas Instruments	TVS3301DRBT	Texas Instruments

(1) Unless otherwise noted in the *Alternate Part Number* or *Alternate Manufacturer* columns, all parts can be substituted with equivalents.

8 Revision History

NOTE: Page numbers for previous revisions may differ from page numbers in the current version.

Changes from Revision A (March 2021) to Revision B (December 2021) Page

- | | | |
|---|--|----|
| • | Updated note in the <i>Abstract</i> section..... | 1 |
| • | Added current limit behavior of TPS26613..... | 16 |

Changes from Revision * (October 2020) to Revision A (March 2021) Page

- | | | |
|---|--|----|
| • | Added note on the need of TVS diodes U6 and U7 when the burden resistor is floating..... | 3 |
| • | Updated Figure 3-1 TPS2661EVM eFuse Evaluation Board Schematic | 4 |
| • | Updated Table 5-1 Default Jumper Settings | 7 |
| • | Replaced Figure 5-1 TPS2661EVM Setup With Test Equipment as per the revised EVM..... | 7 |
| • | Added surge test waveforms and <i>Surge Protection Test (Current Input, CH1)</i> section..... | 18 |
| • | Added surge test waveforms and <i>Surge Protection Test (Analog Output, CH2)</i> section..... | 20 |
| • | Updated TPS2661EVM board assembly and layer images in Section 6.1 | 22 |
| • | Updated bill of materials..... | 24 |

IMPORTANT NOTICE AND DISCLAIMER

TI PROVIDES TECHNICAL AND RELIABILITY DATA (INCLUDING DATA SHEETS), DESIGN RESOURCES (INCLUDING REFERENCE DESIGNS), APPLICATION OR OTHER DESIGN ADVICE, WEB TOOLS, SAFETY INFORMATION, AND OTHER RESOURCES "AS IS" AND WITH ALL FAULTS, AND DISCLAIMS ALL WARRANTIES, EXPRESS AND IMPLIED, INCLUDING WITHOUT LIMITATION ANY IMPLIED WARRANTIES OF MERCHANTABILITY, FITNESS FOR A PARTICULAR PURPOSE OR NON-INFRINGEMENT OF THIRD PARTY INTELLECTUAL PROPERTY RIGHTS.

These resources are intended for skilled developers designing with TI products. You are solely responsible for (1) selecting the appropriate TI products for your application, (2) designing, validating and testing your application, and (3) ensuring your application meets applicable standards, and any other safety, security, regulatory or other requirements.

These resources are subject to change without notice. TI grants you permission to use these resources only for development of an application that uses the TI products described in the resource. Other reproduction and display of these resources is prohibited. No license is granted to any other TI intellectual property right or to any third party intellectual property right. TI disclaims responsibility for, and you will fully indemnify TI and its representatives against, any claims, damages, costs, losses, and liabilities arising out of your use of these resources.

TI's products are provided subject to [TI's Terms of Sale](#) or other applicable terms available either on ti.com or provided in conjunction with such TI products. TI's provision of these resources does not expand or otherwise alter TI's applicable warranties or warranty disclaimers for TI products.

TI objects to and rejects any additional or different terms you may have proposed.

Mailing Address: Texas Instruments, Post Office Box 655303, Dallas, Texas 75265
Copyright © 2022, Texas Instruments Incorporated