

DS90UH927QEVM User Guide



Literature Number: SNLU124
November 2012

Introduction

1.1 DS90UH927QEVN

The Texas Instruments DS90UH927QEVN evaluation module (EVM) helps system designers evaluate the operation and performance of the DS90UH927Q 5MHz-85MHz FPD-Link III Serializer (SER). The device translates four FPD-Link (I) compatible LVDS data input pairs and one LVDS clock into a high-speed serialized FPD-Link III interface for transport over a single shielded twisted pair (STP) cable.

The DS90UH927QEVN board features a 20-position IDC connector at the FPD-Link input, and a Rosenberger HSD Automotive Connector at the FPD-Link III output. The included SMA connectors may also be configured as the FPD-Link III data output, enabling evaluation of other connectors and cable configurations.

The EVM contains one serializer (SER) device

1-1. Device and Package Configurations

Reference	IC	Package
U1	DS90UH927QSQ	LLP-40

1.2 DS90UH927QEVN Kit Contents

The DS90UH927QEVN Kit contains the following items:

- DS90UH927QEVN Evaluation Board
- ALP Installation CD
- USB Cable

1.3 System Requirements

The ALP software installation requires a PC with a USB interface running the Windows XP operating system.

1.4 DS90UH927QEVN Overview

The DS90UH927Q HDCP serializer supports rich audiovisual applications in automotive navigation and rear seat entertainment systems. It transports LVDS video data, I2S audio, GPIO, and I2C control over a single shielded twisted pair cable. The evaluation board and included software enables easy evaluation of the serializer features, including:

- Support of 720p video applications with a pixel clock up to 85MHz
- Surround sound I2S Digital Audio Applications with up to 4 I2S data inputs
- Low EMI FPD-Link video input interface
- Content protection with the integrated HDCP cipher engine and on-chip key storage
- Bidirectional control channel including GPIO (with 2 dedicated pins), interrupt, and I2C interface
- Up to 10 configurable I2C addresses
- Flexible 3.3V or 1.8V LVCMOS I/O interface
- Backwards compatibility mode to DS90UR906Q, DS90UR908Q, and DS90UR916Q
- Low-power modes

- Internal Pattern Generation

1.5 Typical Application

The following diagram illustrates a typical rear seat entertainment application utilizing the DS90UH927Q serializer and a compatible HDCP deserializer (DS90UH926Q or DS90UH928Q). The DS90UH927Q accepts video, audio, and control information from an AV source or graphics processor and transports it over an automotive-grade STP cable to its partner deserializer where it is reassembled and driven to the display, audio system, and other peripherals requiring remote configuration or control.

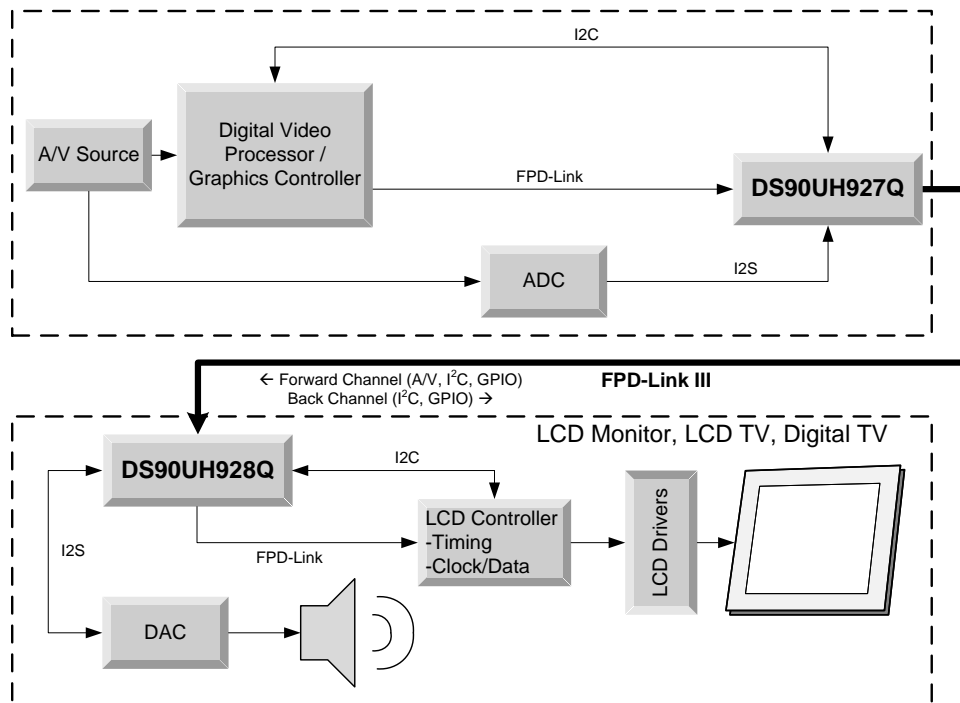

1-1. Typical Application/Evaluation Configuration

Quick Start Guide

2.1 Board Setup

This section describes how to quickly set up the DS90UH927QEVM with an appropriate deserializer for evaluation of the chipset in HDCP display applications. The default switches and jumper positions have been set at the factory. This setup guide assumes the user has already installed and configured the included ALP software.

1. Connect 3.3V DC power and ground from a power supply to J8 (VDD33C) and J9 (VSS). If 1.8V VDDIO operation is desired, set the 1.8V position at JP7 and apply 1.8V DC at pin 1 of JP6. Alternatively, onboard 1.8V DC and 3.3V DC voltage regulators may be utilized by connecting 5V DC at the J7 barrel power jack (center positive).
2. Connect an applicable cable (not provided, Rosenberger HSD configured by default) from the DS90UH927Q-EVK TX board FPD-Link III output to the FPD-Link III input of a compatible FPD-Link III RX board (DS90UH928Q or DS90UH928Q - not included in kit).
3. From the Video source, connect a flat cable (not included) to the TX board and connect the appropriate cable (not supplied) from the RX board (provided separately) to the panel.
4. Connect the included USB cable from a host computer running the included TI ALP software to the USB port (J6) on the TX board. See the included ALP software guide for further information on using the TI ALP tool.
5. (Optional) Connect I2S audio (not included) from an I2S audio source to TX board pins DA (data), CLK (clock), and WC (word clock) and from RX board pins DA, CLK, and WC to an I2S DAC or audio output.
6. (Optional) Connect any required GPIO interfaces. GPIO0 and GPIO1 are dedicated pins.
7. Jumpers and switches have been configured by TI; they should not require any changes for immediate operation of the board. See Configuration Settings section and the DS90UH927Q device datasheet for further details.

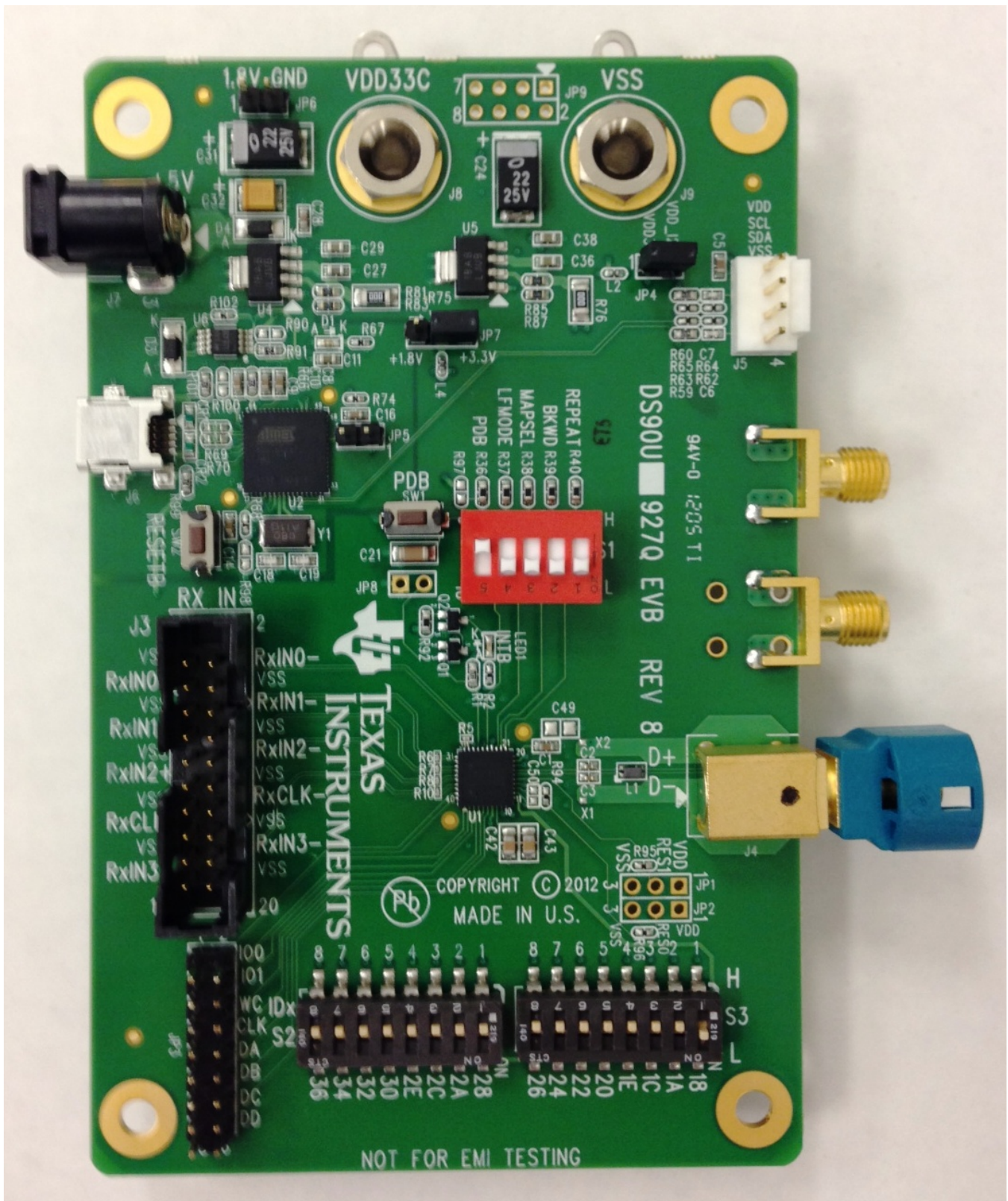

2-1. DS90UH927QEV8

Evaluation Hardware Overview

3.1 Board Overview

The evaluation board includes circuits and interfaces facilitating the different device features of the DS90UH927Q serializer, including power, video data, FPD-Link III interface, I2S audio, I2C control, connectors, and switches.

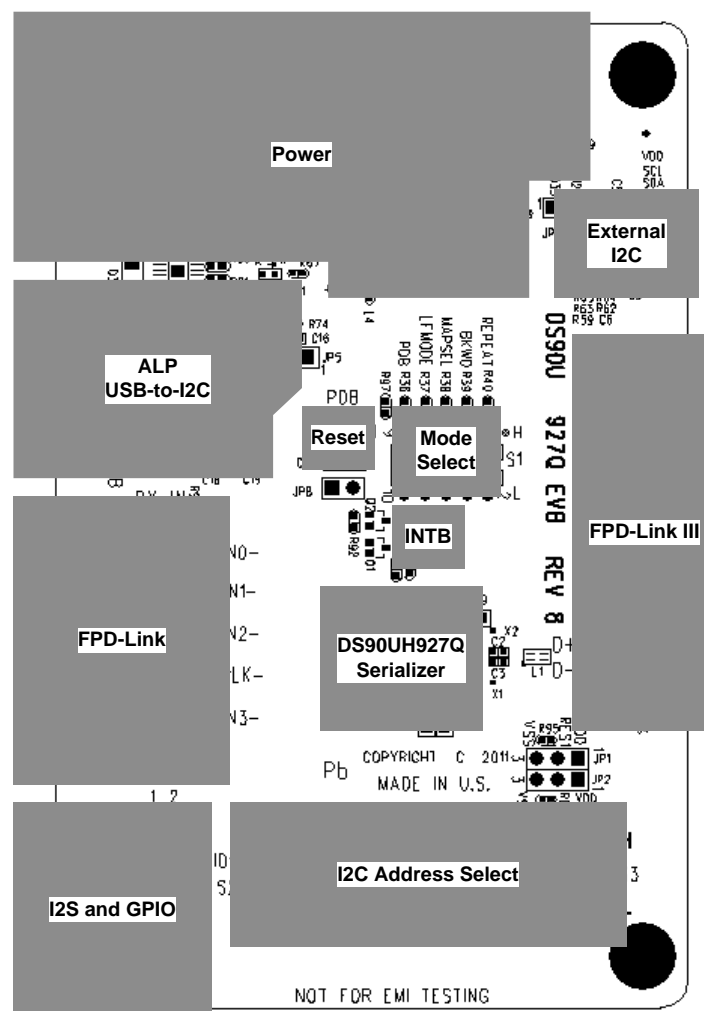

Note: the 4 corner standoffs are NOT connected to VSS (GND)

3-1. DS90UH927QEV M Layout

3.2 Power

Two options are provided for powering the board. +5V DC power may be supplied at the provided barrel connector (J7, center positive), or +3.3V DC through J8 and J9. If 1.8V VDDIO power supply operation is desired, connect +1.8V DC at JP6 and select 1.8V VDDIO power from JP7.

3.3 FPD-Link Video Data Input

The FPD-Link video data input accepts a 20-pin IDC cable or similar 0.1" spaced connector. Connect the clock and 4 FPD-Link (LVDS) data pairs here. The data channel mapping is determined from the MAPSEL switch, located on the mode select switch block.

100Ω differential termination is provided on-board near the DS90UH927Q device (U1).

3.4 FPD-Link III Interface

The high-speed FPD-Link interface is the point of output for the high-speed (up to 2.975Gbps) forward data channel, as well as the receive point for the low speed back channel. The default configuration features a Rosenberger HSD-style automotive cable connector. The board also provides two SMA connectors to which other cable connectors may be attached. To use the SMA connectors, depopulate J4 and solder 0Ω resistors at R3 and R4.

The FPD-Link signal may be probed from the output capacitors and two provided ground pads (X1 and X2). Use a high-bandwidth differential probe to observe the channel. See the device datasheet for additional details.

3.5 Controller

The onboard USB-to-I2C controller allows for easy evaluation of the DS90UH927Q I2C interface without the need for a dedicated external tool. It interfaces with a host PC using the provided TI Analog LaunchPAD (ALP) software. The I2C bus may also be accessed by an external controller via the external I2C interface at J5.

3.6 I2C and Device Addressing

A row of switches is provided at S2 and S3 to set the IDx I2C address select. Only one I2C address may be selected at a time. **Note that addresses 0x18 and 0x26 through 0x36 are available.** All others are reserved.

3.7 I2S and GPIO Interface

A 0.1" header block is provided for connections to the I2S and GPIO interfaces. All GPIOs may be configured as inputs or outputs, with GPIO[3:0] available for bidirectional transport. Signal levels should scale with VDDIO.

3.8 Device Address, Reset and Mode Selection Inputs

The Mode Select inputs determine the specific mode or state of device operation, including:

- **PDB** When set LOW, the device enters a low-power mode and all registers are reset. Set HIGH for normal operation.
- **MAPSEL** Set LOW to assign LSBs to RxIN3±, set HIGH to assign MSBs to RxIN3±. See device datasheet for details.
- **LFMODE** Set HIGH for 5MHz ≤ PCLK < 15MHz. Set LOW for 15MHz ≤ PCLK ≤ 85MHz
- **BKWD** Set HIGH to interface with DS90UR906Q, DS90UR908Q, DS90UR910Q, or DS90UR916Q. Set LOW to interface with DS90UH926Q and DS90UH928Q.
- **REPEAT** Set HIGH to activate HDCP Repeater Mode. Set LOW for normal operation.

These mode settings are selectable from the following switches and buttons:

- **S1** (Mode Selection Inputs): Set PDB, LFMODE, MAPSEL, BKWD, and REPEAT. See DS90UH927Q datasheet additional detail.
- **S2/S3** (IDx Select Inputs): Select required I2C address level for IDx input. Set only one switch to 'L' (0x18 is default address).
- **SW1** (PDB Reset Button): PDB pull-down switch. Press to perform a DS90UH927Q (U1) device PDB reset.
- **SW2** (Onboard I2C Bridge Reset): Press to reset the onboard USB-to-I2C bridge controller.

3.9 Indicators

The INTB interrupt state may be observed from the on-board LED indicator. The LED turns off when an interrupt is indicated (INTB = LOW).

3.10 Input/Output Connectors

The following jumpers and connectors are provided on the board:

- **J1/J2 FPD-Link III SMA Output (optional)** – These optional outputs may be used to evaluate the FPD-Link III serial link with different STP or micro-coax configurations. To use, remove J4 and populate R3 and R4 with 0Ω resistors.
- **J3 20-pin FPD-Link (I) Input** – Connect LVDS data and clock here. Required 100Ω terminations are located on-board near U1. See DS90UH927Q device datasheet for input electrical characteristics and requirements.
- **J4 FPD-Link III HSD Automotive Output** – Connect to automotive-grade STP cable here. Remove the connector if the SMA outputs (J1/J2) are to be used.
- **J5 4-pin I2C Input/Output** – Connect SDA, SCL, VSS, and VDD33 to external I2C peripherals or controls here. The EVM board provides the recommended 4.7KΩ pull-up resistors.
- **J6 USB Connector for USB-to-I2C Controller** – Connect USB cable to host PC to use EVM board with ALP evaluation software.
- **J7 5V External Power Input (optional)** – Connect +5V center-positive 2.1mm barrel connector here to supply board power. Onboard regulators will supply the board with 3.3V VDDIO and 3.3V/1.8V VDDIO supplies. Do not connect J8/J9 if this connector is used.
- **J8 +3.3V VDD33 Power Input** – Connect to 3.3V power supply.
- **J9 VSS Power** – Connect to system GND.
- **JP1/JP2 Reserved** – Do not populate or connect to external inputs/outputs
- **JP3 I2S/GPIO Input/output Header** – Connect to I2S input pins or bidirectional GPIO pins. See DS90UH927Q datasheet for detailed I2S and GPIO usage.
- **JP4 VDD_I2C Power Enable** – Short to provide 3.3V power to on-board I2C pull-ups.
- **JP5 Reserved** – Do not short or connect to external inputs/outputs
- **JP6 VDDIO_EXT Power Input** – Connect to independent external VDDIO supply if VDDIO = 1.8V
- **JP7 VDDIO Select** – Connect jumper to select VDDIO=VDD33 [2-3] or VDDIO=VDDIO_EXT [1-2]

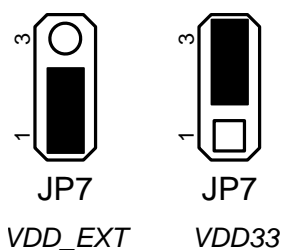

3-2. VDDIO Select (JP7) Jumper Settings

- **JP8 INTB Interrupt Output** – Monitor INTB status or connect to external device utilizing link interrupt options. See DS90UH927Q datasheet for additional details on INTB options
- **JP9 Reserved** – Do not populate or connect to external inputs/outputs

ALP Software

4.1 Overview

The included Analog Launch PAD (ALP) software allows evaluation of the I2C control interface of the DS90UH927Q serializer. The tool provides a graphical interface for reading/writing the device registers. It also features several useful tools for manipulating advanced device-specific features, including HDCP authentication and internal pattern generation.

System Requirements:

Operating System: Windows XP or Vista

USB version: 2.0

4.2 Installation

Extract the contents of the NSC Analog Launch PAD CD a temporary location that can be deleted later. Make sure the board USB port is connected to the host PC.

The following installation instructions are for the Windows XP Operating System:

Install the ALP Software

Execute the ALP Setup Wizard program called "Setup.exe", found on the ALP CD included with the DS90UH927QEVM.

1. Click "Next"
2. Select "I accept the agreement"
3. Click "Next"
4. Select the location to install the ALP software and click "Next"
5. Select the location for the Start Menu shortcut and click "Next"
6. Create a desktop shortcut icon and Quick Launch button (optional). Click "Next"
7. Click "Install." The software will be extracted and installed to the system.
8. Uncheck "Launch Analog LaunchPAD" and click "Finish." The ALP software should not be launched until the USB driver is installed.

Install the USB Driver

To install the ALP hardware USB driver:

1. Select "No, not at this time" then click "Next"
2. Click "Install from a list or specific location" then click "Next"
3. Click "Search for the best driver in these locations". Uncheck "Search removable media" and check "Include this location in the search."
4. Browse to the Install Directory which is typically located at "C:\Program Files\National Semiconductor Corp\Analog LaunchPAD\vx.x.x\Drivers" and select the "Next" button. Windows should find the driver.
5. Click "Continue Anyway".
6. Click "Finish"

The software installation is now complete. The ALP software may now be launched.

4.3 Usage

Startup

Make sure all the software has been installed and the hardware is powered on and connected to the PC. Execute “Analog LaunchPAD” from the start menu. The default start menu location is “Programs\National Semiconductor Corp\Analog LaunchPAD vx.x.x\Analog LaunchPAD”.

The application should come up in the state shown below. If it does not, see “Trouble Shooting” at the end of this document. Under the Devices tab click on “DS90UH92x” to select the device and open up the device profile and its associated tabs.

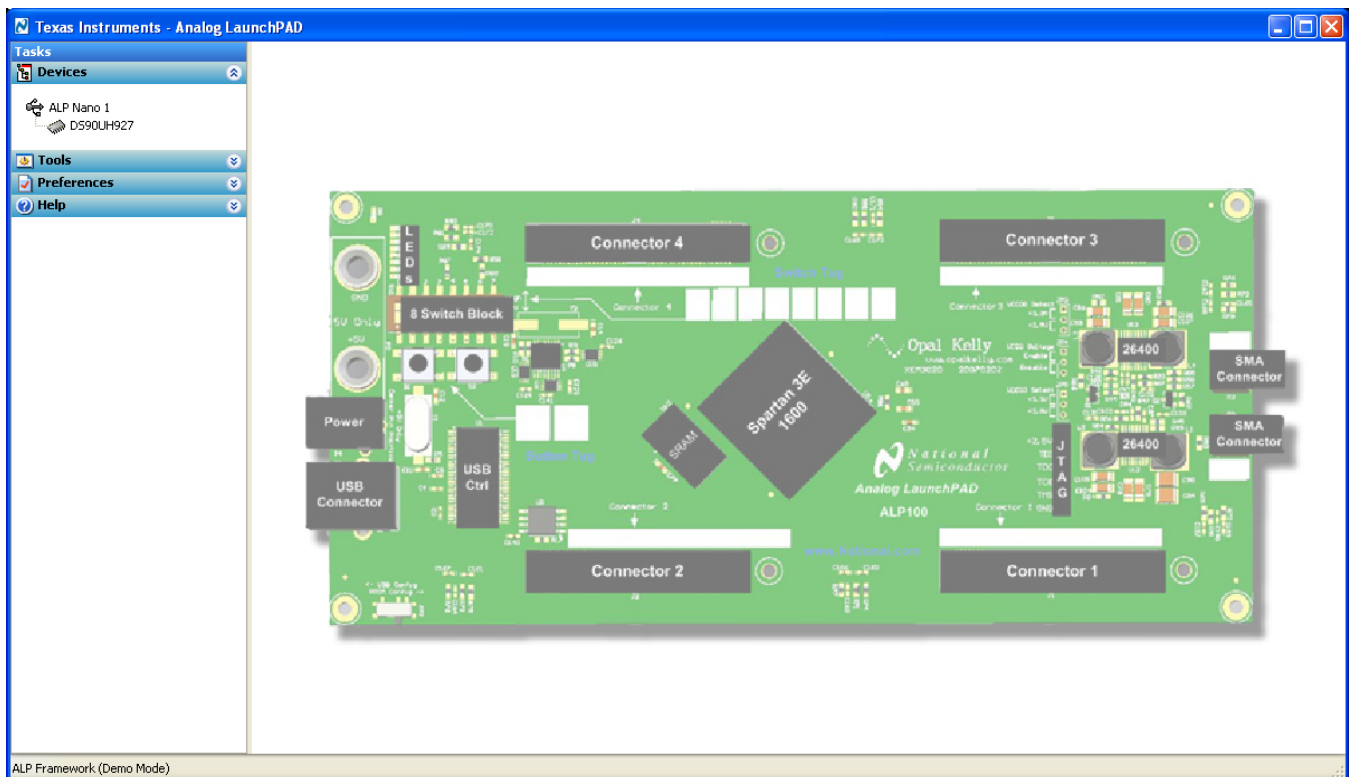

4-1. ALP Startup Screen

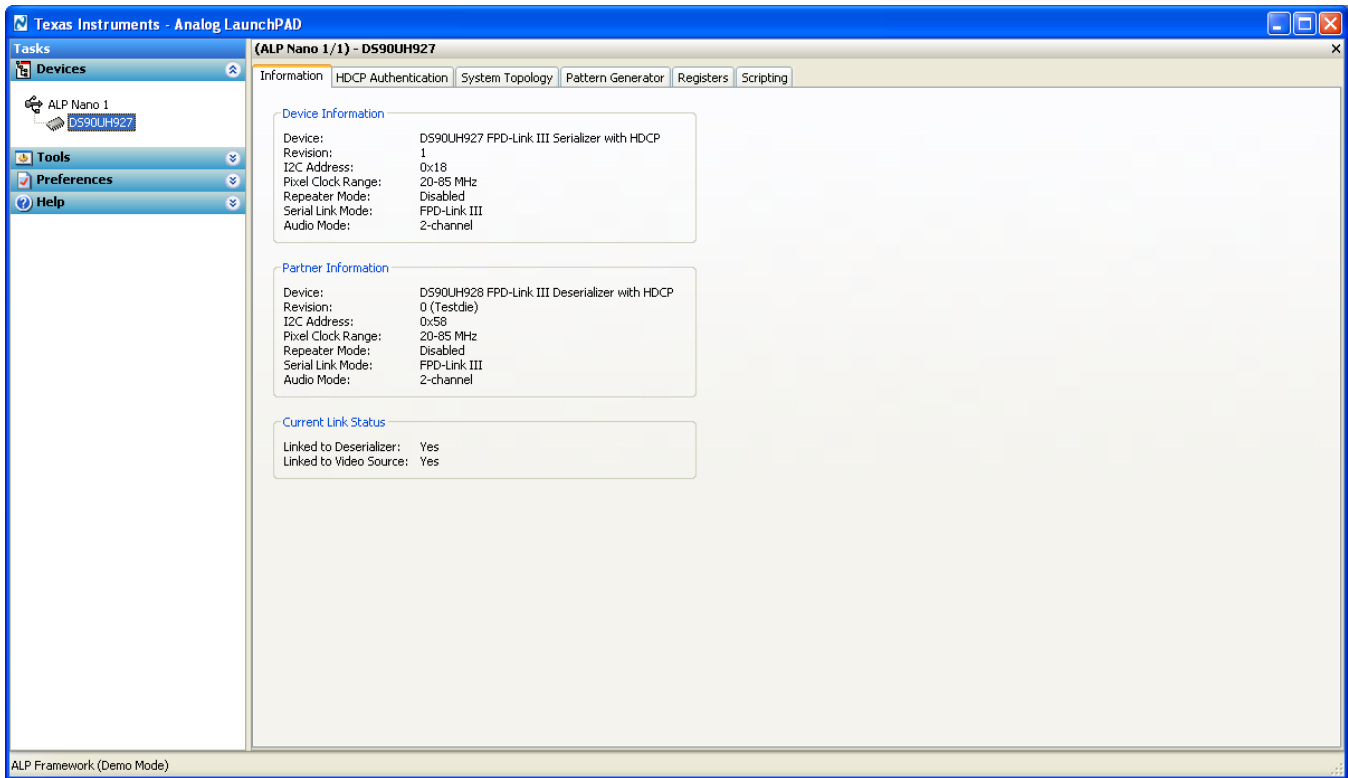

4-2. Information Tab

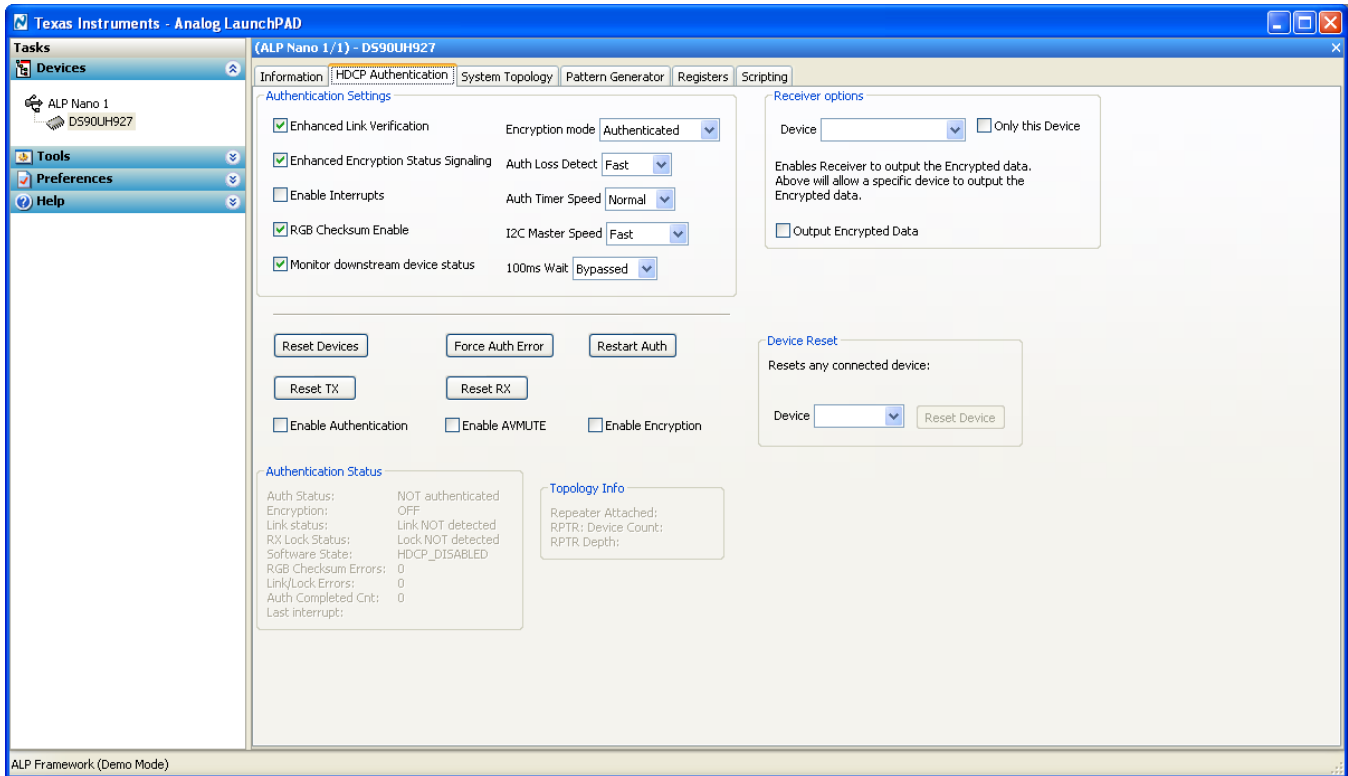

4-3. HDCP Tab

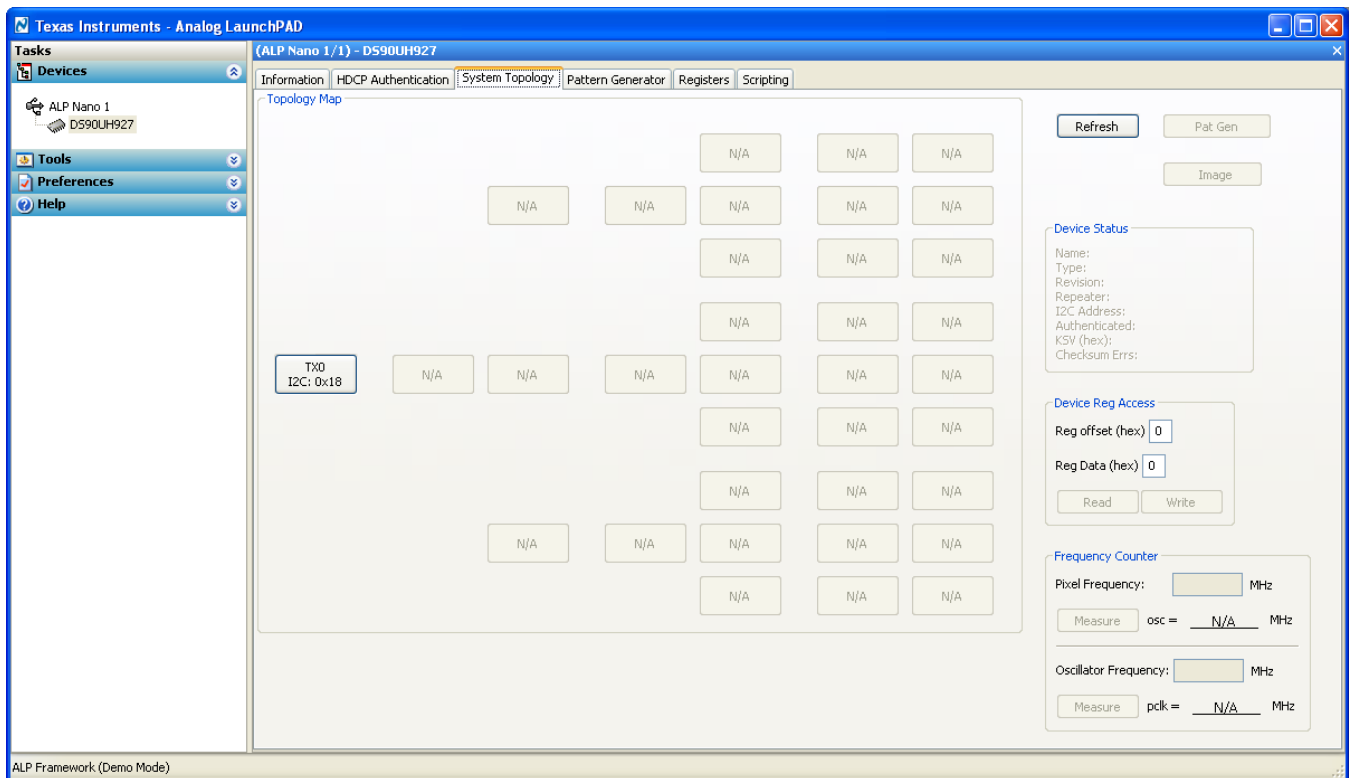

4-4. System Topology Tab

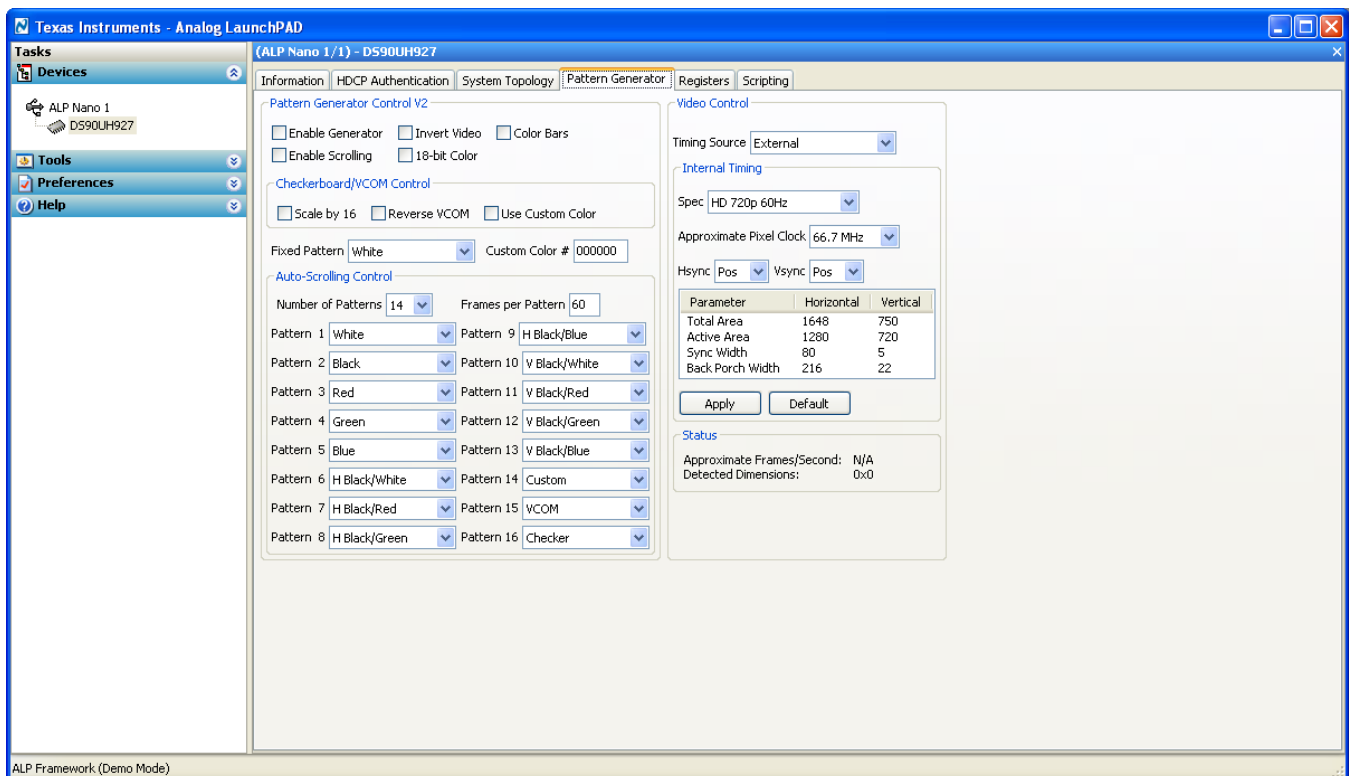

4-5. Pattern Generator Tab

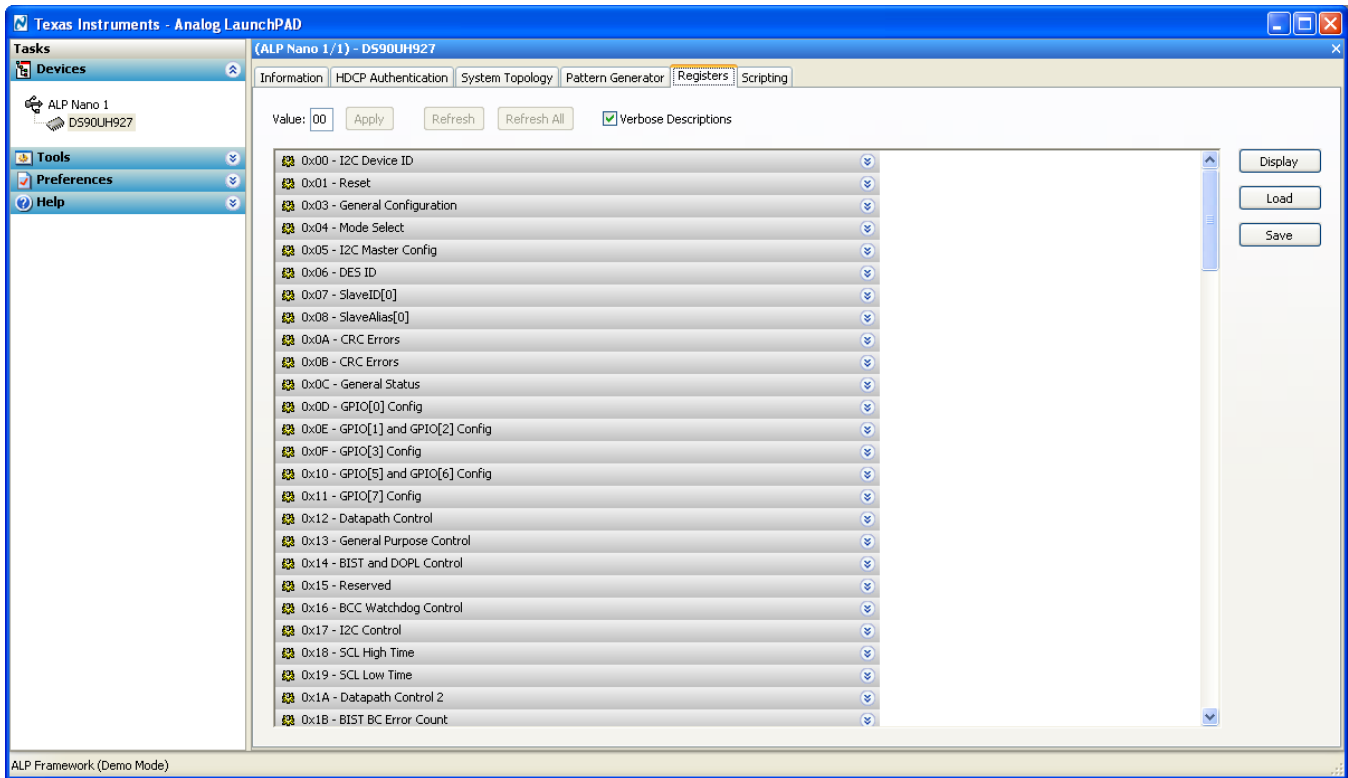

4-6. Register Tab

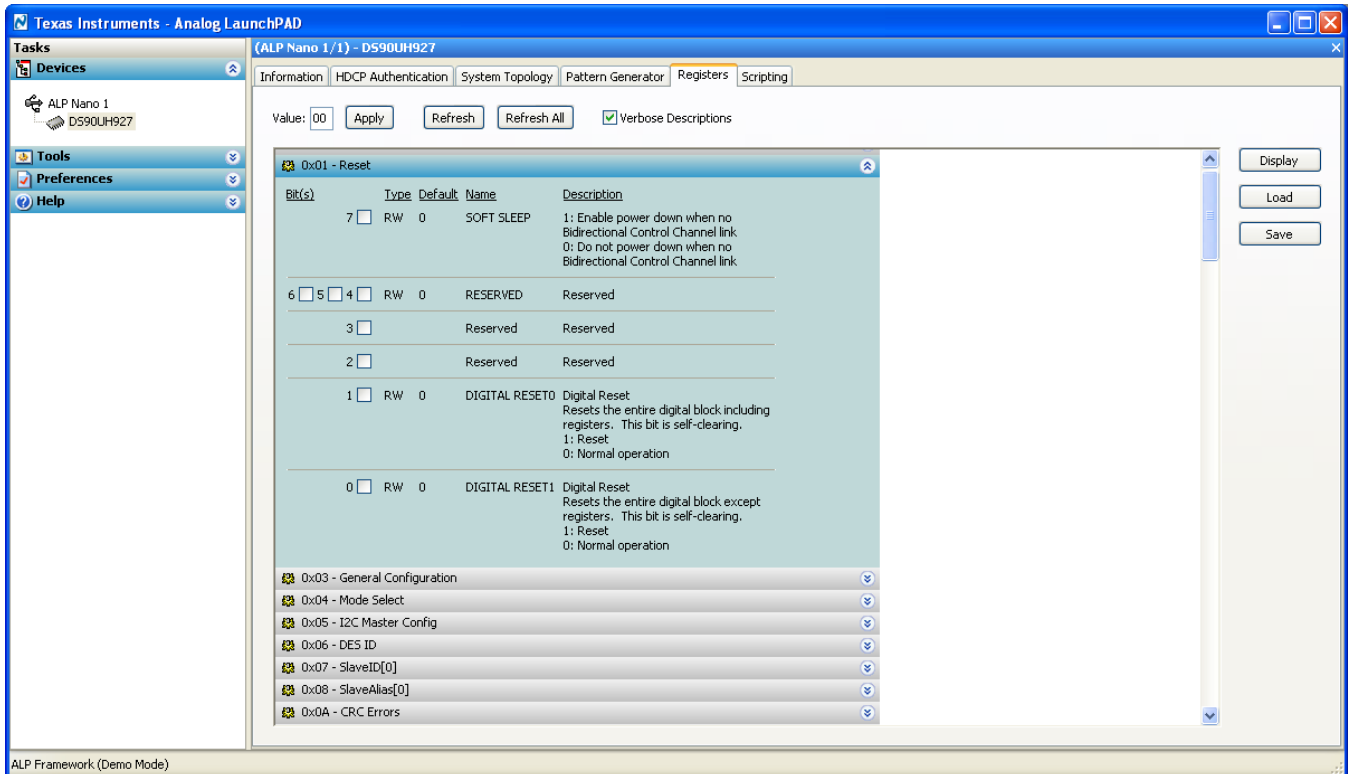

4-7. Register Tab with expanded register description

4.3.1 Information Tab

The information tab gives basic device state information, including local device information, partner device information, and current link status. For both the local device and partner device, the tab gives the following information:

- Device Name
- Device Revision
- I2C address
- Pixel clock range (set by LFMODE)
- Repeater Status (set by REPEAT)
- Serial Link Mode (set by BKWD)
- Audio mode (set by configuration registers)

4.3.2 HDCP Authentication Tab

The HDCP Authentication Tab allows control of the onboard HDCP cipher and authentication features. HDCP authentication may be activated by clicking the “enable authentication” checkbox. The Authentication Status and Topology Info panels report on the authentication state and number of authenticated devices in the repeater tree (if repeater mode is active).

4.3.3 System Topology Tab

The System Topology Tab gives an overview of all devices downstream from the deserializer. Individual devices may be clicked on for individual I2C access. The user may read/write to a specific device from the Device Reg Access panel.

4.3.4 Pattern Generator Tab

The Pattern Generator Tab enables interactive control of the internal pattern generator features. The pane controls timing information and different pattern settings, including a scrolling function. Timing information is configured from the Video Control panel, and supports the following timing/clocking sources:

- External
- Internal
- Internal w/ Ext. Clock

The Internal timing option allows evaluation of the link performance without the need for an external source. The Video Control panel also provides several timing and pixel clock options, including several presets covering common video resolutions.

4.3.5 Registers Tab

The Registers Tab allows for direct reading/writing of individual registers or register bits located on the local device. Each register drop-down shows the name and description of individual bits or groupings of bits. Use the check boxes to set individual bits, and commit the register write by clicking the “Apply” button. Click the “Refresh” or “Refresh All” buttons to read an update of the selected register or all registers respectively.

4.4 Troubleshooting

If the following window opens after starting the ALP software, double check the hardware setup and that the board USB port is connected to the host PC.

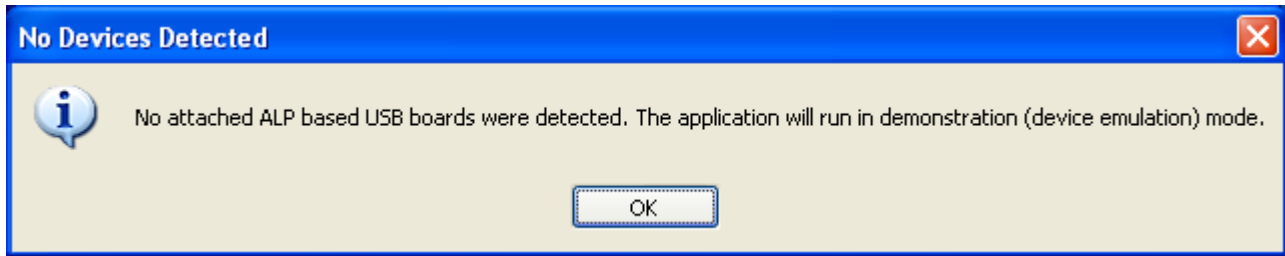

4-8. No Devices error message

The USB driver may not be installed. Check the device manager. There should be a device named "NSC ALP Nano Atmel" device under the "Universal Serial Bus Controllers" as shown below.

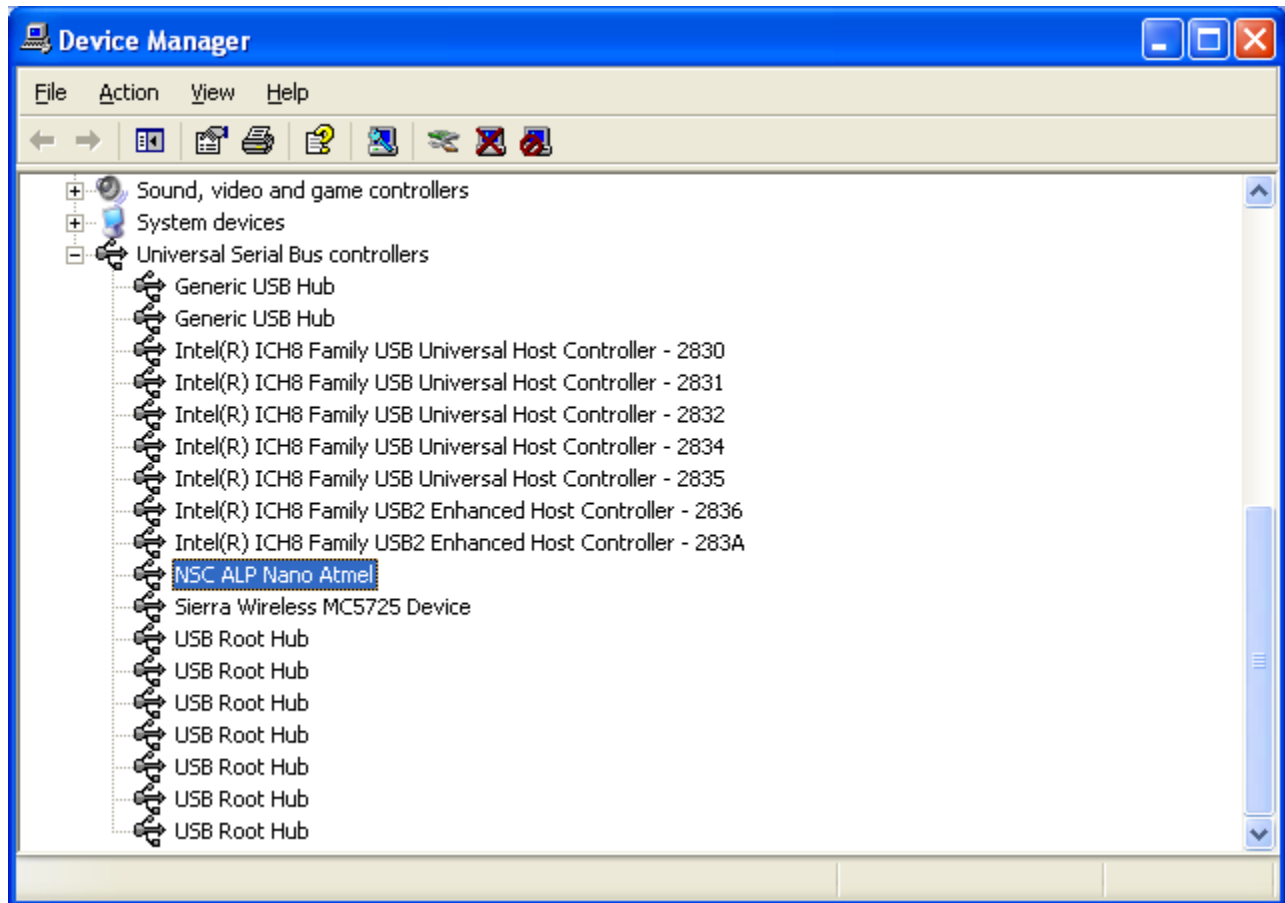

4-9. Windows XP Analog LaunchPAD USB Driver

The software should start with only "DS90UH92x" in the "Devices" pull down menu. If there are more devices then the software is most likely in demo mode. When the ALP is operating in demo mode there is a "(Demo Mode)" indication in the lower left of the application status bar as shown below.

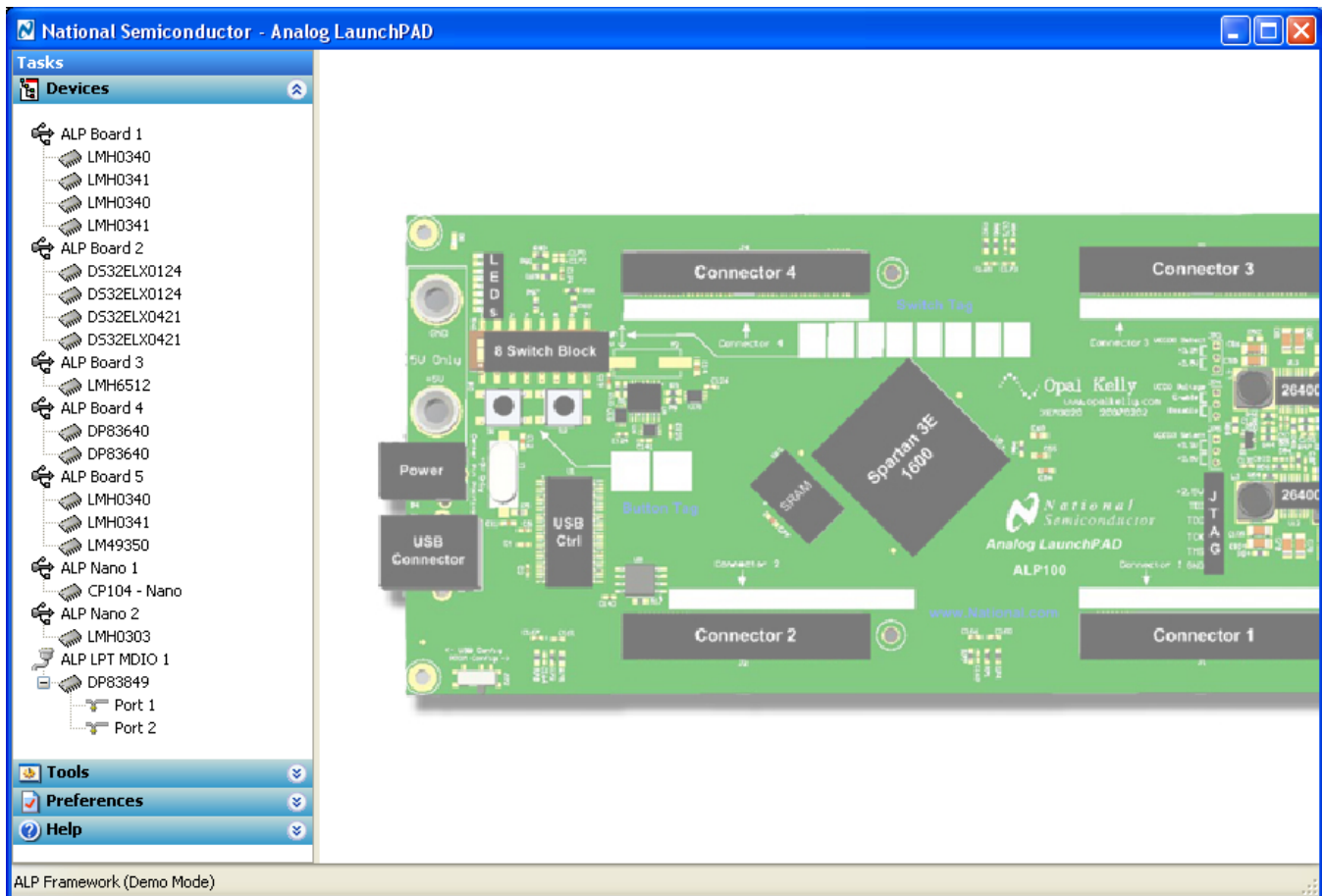

4-10. Analog LaunchPAD in Demo Mode

Disable the demo mode by selecting the “Preferences” pull down menu and un-checking “Enable Demo Mode”.

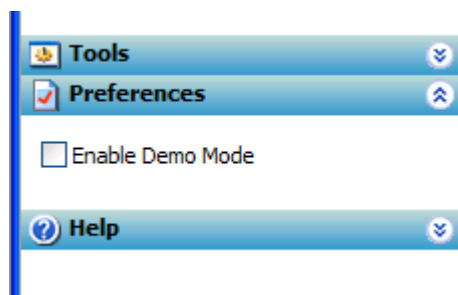

4-11. Analog LaunchPAD Preferences Menu

After demo mode is disabled, the ALP software will poll the ALP hardware. The ALP software will update and have only “DS90UH92x” under the “Devices” pull down menu.

Additional Information

5.1 Related Documents

Additional information may be found in the device product folder at www.ti.com

- DS90UH927Q device datasheet
- DS90UH928Q device datasheet
- DS90UH926Q device datasheet
- TI Application Note AN-2173
- TI Application Note AN-2198

5.2 Document Revision History

- 10/26/12 -- Initial Release

Board Schematic

A.1 Board Stackup

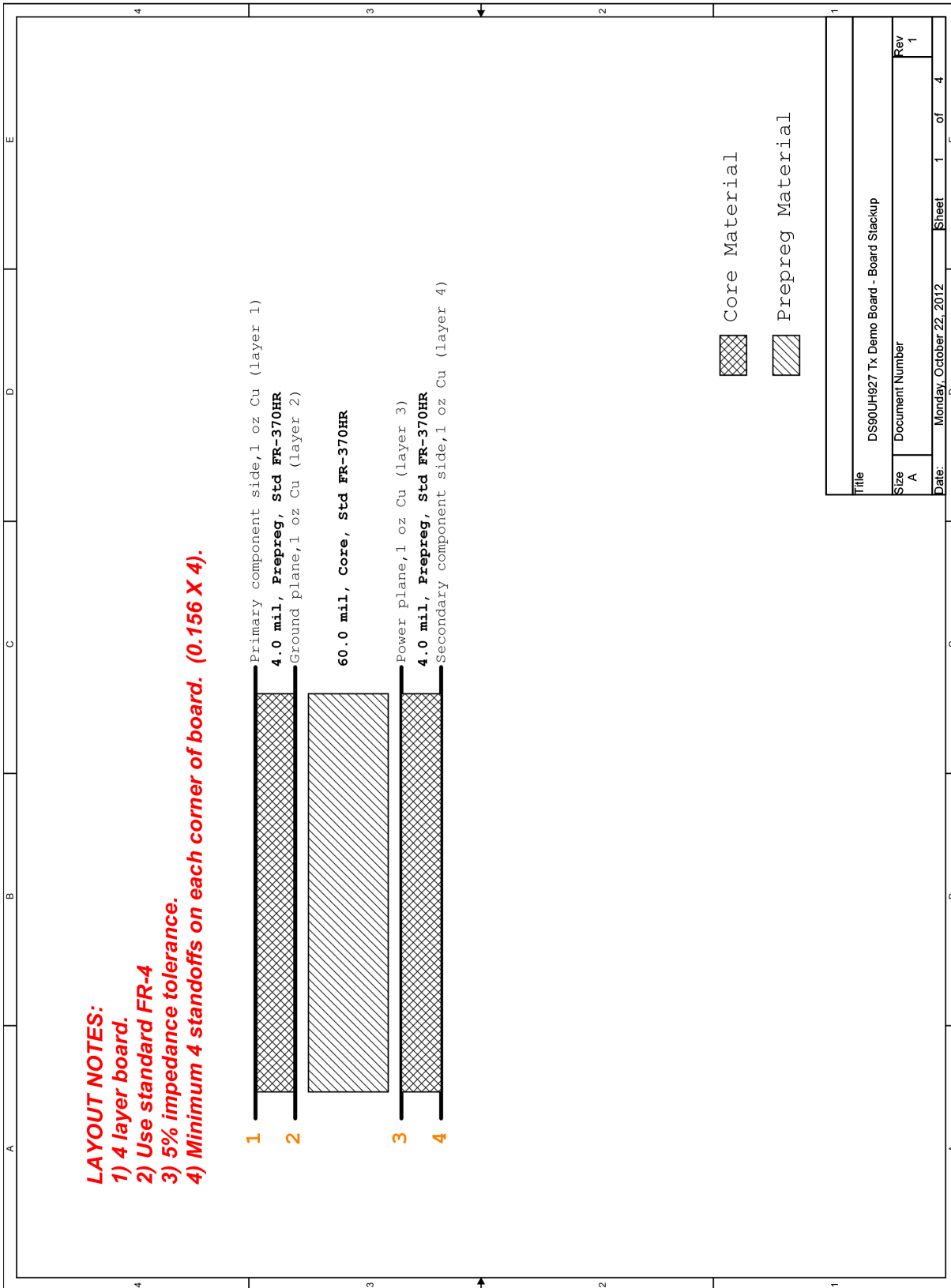

A-1. Board Stackup

A.2 DS90UH927Q Serializer

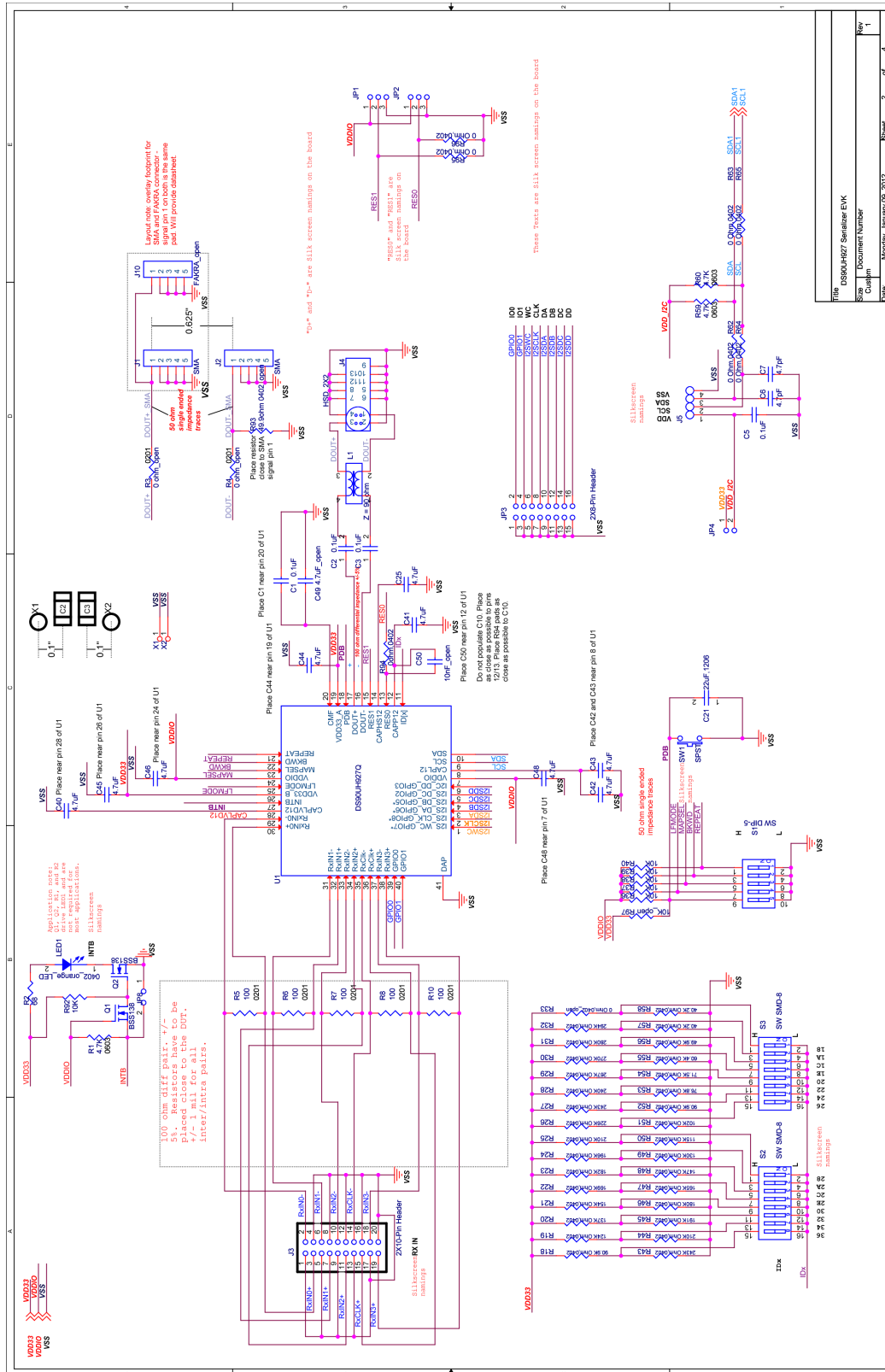

A-2. DS90UH927Q Serializer

A.3 USB-to-I2C Controller

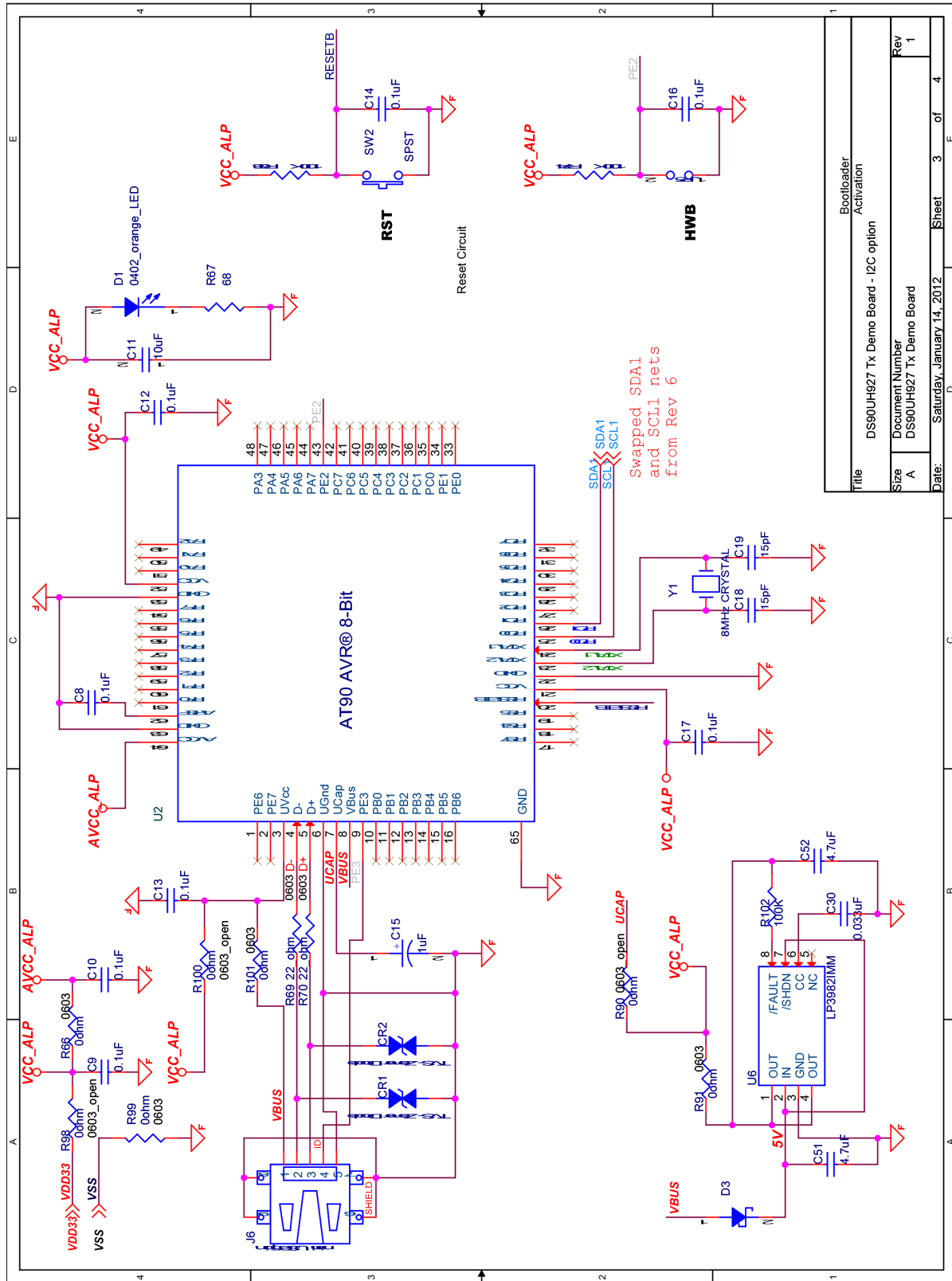

Title		Bootloader Activation	
Size		Document Number	
A		DS90UH927 Tx Demo Board	
Date:		Rev	
Saturday, January 14, 2012		1	
Sheet		of	
3		4	

A-3. USB-to-I2C Controller

A.4 Power

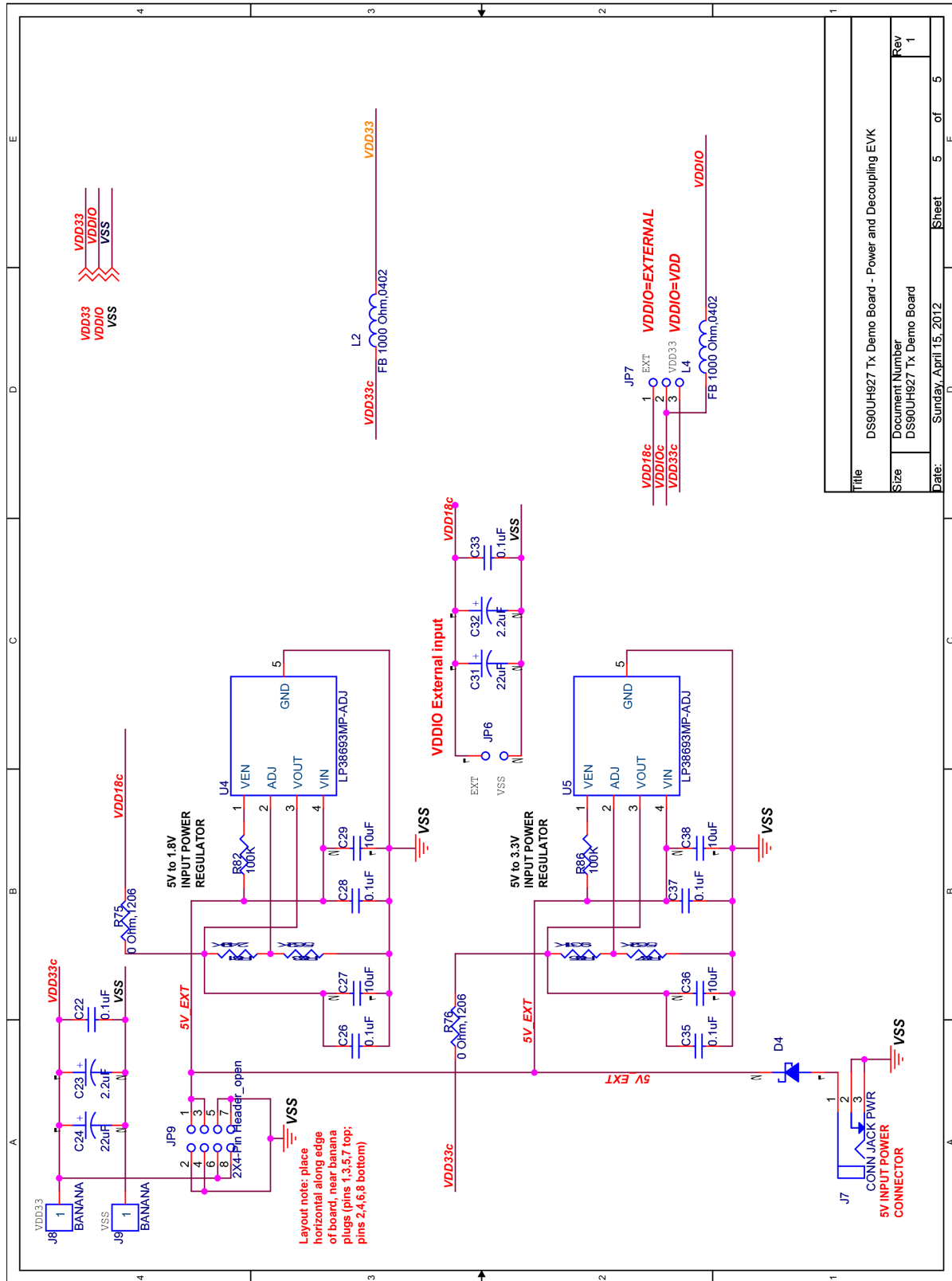

A-4. Power

Bill of Materials

B.1 DS90UH927QEVM BOM

B-1. DS90UH927QEVM BOM

Item	Qty	Reference	Description	Manufacturer	Part Number
1	2	CR1,CR2	SUPPRESSOR ESD 24VDC 0603 SMD	Littelfuse	PGB1010603MR
2	16	C1,C5,C8, C9,C10,C1 2,C13,C14, C16,C17,C 22,C26,C2 8,C33,C35, C37	CAP CER .1UF 50V 10% X7R 0603	Murata	GRM188R71H104KA9 3D
3	2	C2,C3	CAP CER .1UF 16V X7R 0402	Murata	GCM155R71C104KA5 5D
4	2	C6,C7	CAP CERAMIC 4.7PF 25V COG 0402	Panasonic	ECD-G0E4R7C
5	5	C11,C27,C 29,C36,C3 8	CAP CER 10UF 10V X5R 0603	Taiyo Yuden	LMK107BJ106MALTD
6	1	C15	CAPACITOR TANT 1.0UF 16V 10% SMD	Kemet	T491A105K016AT
7	2	C18,C19	CAP CERAMIC 15PF 50V NP0 0603	Kemet	C0603C150J5GACTU
8	1	C21	CAP CER 22UF 6.3V 10% X7R 1206	Murata	GCM31CR70J226KE2 3L
9	2	C23,C32	CAPACITOR TANT 2.2UF 20V 10% SMD	Kemet	T491B225K020AT
10	2	C24,C31	CAP TANTALUM 22UF 25V 20% SMD	Nichion	F931E226MNC
11	11	C25,C40,C 41,C42,C4 3,C44,C45, C46,C48,C 51,C52	CAP CER 4.7UF 16V X7R 0805	Murata	490-5332-1-ND
12	1	C30	CAP CERM 33000PF 5% 50V X7R 0603	AVX	06035C333JAT2A
13	2	LED1,D1	LED ORN/CLEAR 610NM 0402 SMD	Lumex	SML-LX0402SOC-TR
14	2	D3,D4	DIODE SCHOTTKY 400MW 20V SOD123	Diodes, Inc.	SD103CW-13-F
15	1	JP3	CONN HEADER 16POS .100 STR 30AU	FCI	68602-116HLF
16	3	JP4,JP5,JP 6	CONN HEADER VERT .100 2POS 30AU	AMP/Tyco	87220-2
17	1	JP7	CONN HEADER VERT .100 3POS 15AU	AMP/Tyco	87224-3
18	2	J1,J2	SMA – Edge Launch	Johnson Group	142-0701-851

B-1. DS90UH927QEVM BOM (continued)

Item	Qty	Reference	Description	Manufacturer	Part Number
19	1	J3	CONN HEADER 20 POS STRGHT GOLD.	3M	N2520-6002RB
20	1	J4	Automotive HSD Connector, RA	Rosenberger	D4S20B-40ML5-Y
21	1	J5	CONN HEADER 4POS .100 VERT GOLD	Molex	22-11-2042
22	1	J6	CONN RECEPT MINI USB2.0 5POS	Hirose	UX60-MB-5ST
23	1	J7	CONN POWER JACK 2.1MM.	CPU Inc	PJ-002A
24	2	J8,J9	BANANA-female (non-insulated)	Johnson	108-0740-001
25	1	L1	CHOKE COIL COMMON MODE 280MA SMD	Murata	DLW21SN900HQ2L
26	2	L2,L4	FERRITE CHIP 1000 OHM 0402	Murata	BLM15AX102SN1D
27	2	Q1,Q2	MOSFET N-CH 50V 200MA SC70-3	Diodes, Inc.	BSS138W-7-F
28	3	R1,R59,R60	RES 4.7K OHM 1/10W 5% 0603 SMD	Panasonic	ERJ-3GEYJ472V
29	2	R2,R67	RES 68 OHM 1/10W 5% 0402 SMD	Panasonic	ERJ-2GEJ680X
30	5	R5,R6,R7,R8,R10	RES 100 OHM 0201 SMD. 1/20W .5%	Susumu	RR0306P-101-D
31	2	R18,R52	RES 90.9K OHM 1/10W 1% 0402 SMD	Panasonic	ERJ-2RKF9092X
32	1	R19	RES 124K OHM 1/10W 1% 0402 SMD	Panasonic	ERJ-2RKF1243X
33	1	R20	RES 137K OHM 1/10W 1% 0402 SMD	Panasonic	ERJ-2RKF1373X
34	1	R21	RES 154K OHM 1/10W 1% 0402 SMD	Panasonic	ERJ-2RKF1543X
35	1	R22	RES 169K OHM 1/10W 1% 0402 SMD	Panasonic	ERJ-2RKF1693X
36	1	R23	RES 182K OHM 1/10W 1% 0402 SMD	Panasonic	ERJ-2RKF1823X
37	1	R24	RES 196K OHM 1/10W 1% 0402 SMD	Panasonic	ERJ-2RKF1963X
38	2	R25,R44	RES 210K OHM 1/10W 1% 0402 SMD	Panasonic	ERJ-2RKF2103X
39	1	R26	RES 226K OHM 1/10W 1% 0402 SMD	Panasonic	ERJ-2RKF2263X
40	2	R27,R43	RES 243K OHM 1/10W 1% 0402 SMD	Panasonic	ERJ-2RKF2433X
41	1	R28	RES 240K OHM 1/10W 1% 0402 SMD	Panasonic	ERJ-2RKF2403X
42	1	R29	RES 267K OHM 1/10W 1% 0402 SMD	Panasonic	ERJ-2RKF2673X
43	1	R30	RES 270K OHM 1/10W 1% 0402 SMD	Panasonic	ERJ-2RKF2703X
44	1	R31	RES 280K OHM 1/10W 1% 0402 SMD	Panasonic	ERJ-2RKF2803X
45	1	R32	RES 294K OHM 1/10W 1% 0402 SMD	Panasonic	ERJ-2RKF2943X

B-1. DS90UH927QEVM BOM (continued)

Item	Qty	Reference	Description	Manufacturer	Part Number
46	6	R36,R37,R38,R39,R40,R92	RES 10.0K OHM 1/10W 1% 0603 SMD	Panasonic	ERJ-3EKF1002V
47	1	R45	RES 191K OHM 1/10W 1% 0402 SMD	Panasonic	ERJ-2RKF1913X
48	1	R46	RES 180K OHM 1/10W 1% 0402 SMD	Panasonic	ERJ-2RKF1803X
49	1	R47	RES 165K OHM 1/10W 1% 0402 SMD	Panasonic	ERJ-2RKF1653X
50	1	R48	RES 147K OHM 1/10W 1% 0402 SMD	Panasonic	ERJ-2RKF1473X
51	1	R49	RES 130K OHM 1/10W 1% 0402 SMD	Panasonic	ERJ-2RKF1303X
52	1	R50	RES 115K OHM 1/10W 1% 0402 SMD	Panasonic	ERJ-2RKF1153X
53	1	R51	RES 102K OHM 1/10W 1% 0402 SMD	Panasonic	ERJ-2RKF1023X
54	1	R53	RES 76.8K OHM 1/10W 1% 0402 SMD	Panasonic	ERJ-2RKF7682X
55	1	R54	RES 71.5K OHM 1/10W 1% 0402 SMD	Panasonic	ERJ-2RKF7152X
56	1	R55	RES 60.4K OHM 1/10W 1% 0402 SMD	Panasonic	ERJ-2RKF6042X
57	1	R56	RES 49.9K OHM 1/10W 1% 0402 SMD	Panasonic	ERJ-2RKF4992X
58	2	R57,R58	RES 40.2K OHM 1/10W 1% 0402 SMD	Panasonic	ERJ-2RKF4022X
59	6	R62,R63,R64,R65,R94,R95,R96	RES ZERO OHM 1/16W 5% 0402 SMD	Panasonic	ERJ-2GEJ0R00X
60	4	R66,R91,R99,R101	RES ZERO OHM 1/10W 5% 0603 SMD	Panasonic	ERJ-3GEY0R00V
61	5	R68,R74,R82,R86,R102	RES 100K OHM 1/10W 5% 0402 SMD	Panasonic	ERJ-2GEJ104X
62	2	R69,R70	RES 22 OHM 1/16W 3300PPM 5% 0603	Panasonic	ERA-V33J220V
63	2	R75, R76	RES ZERO OHM 1/4W 5% 1206 SMD	Panasonic	ERJ-8GEY0R00V
64	1	R81	RES 2.49K OHM 1/10W 1% 0603 SMD	Vishay	CRCW06032K49FKE A
65	2	R83, R87	RES 5.62K OHM 1/10W 1% 0603 SMD.	Vishay	CRCW06035K62FKE A
66	1	R85	RES 9.31K OHM 1/10W 1% 0603 SMD	Vishay	CRCW06039K31FKE A
67	2	SW1, SW2	SWITCH TACT	APEM	ADTSM31NV
68	1	S1	SWITCH DIP EXTENDED SEALED 5POS	Grayhill	78B05ST
69	2	S2, S3	SWITCH TAPE SEAL 8 POS SMD	CTS	219-8MST
70	1	U1	DS90UH927Q FPD-Link III Serializer	TI	DS90UH927QSQ
71	1	U2	IC AVR MCU 128K 64QFN	Atmel	AT90USB1287-16MU
72	2	U4, U5	IC REG LDO 500MA ADJ SOT223-4.	TI	LP38693MP- ADJ/NOPB

B-1. DS90UH927QEVM BOM (continued)

Item	Qty	Reference	Description	Manufacturer	Part Number
73	1	U6	IC REG LDO 300MA 3.3V 8MSOP	TI	LP3982IMM- 3.3/NOPB
74	1	Y1	CRYSTAL 8.000 MHZ 18PF SMD	Abracon	ABM3-8.000MHZ- D2Y-T
75	1	-	PCB	-	-

Board Layout

C.1 Board Layers

The following mechanical drawings illustrate the physical layout and stack-up of the 4-layer DS90UH927QEVM evaluation board:

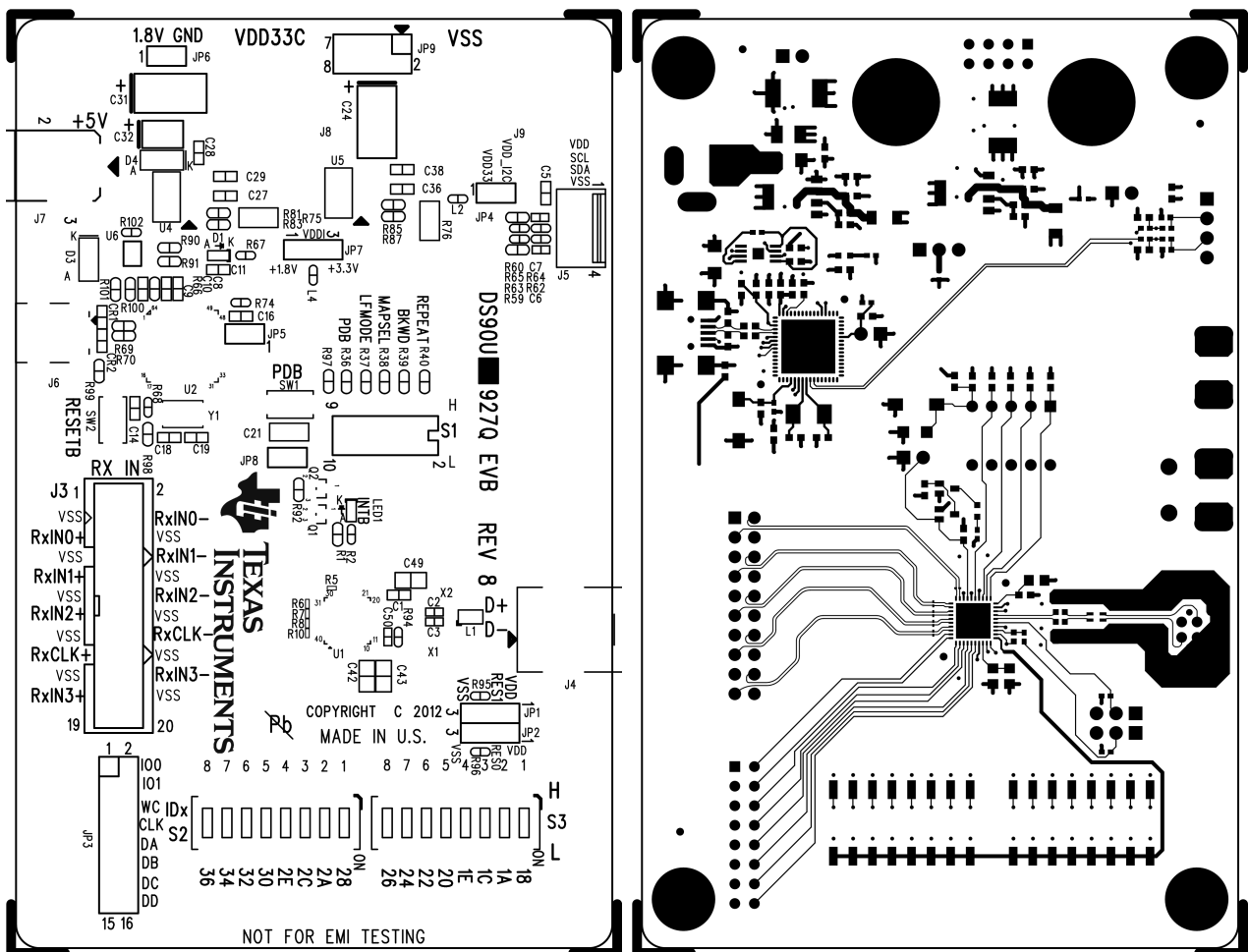

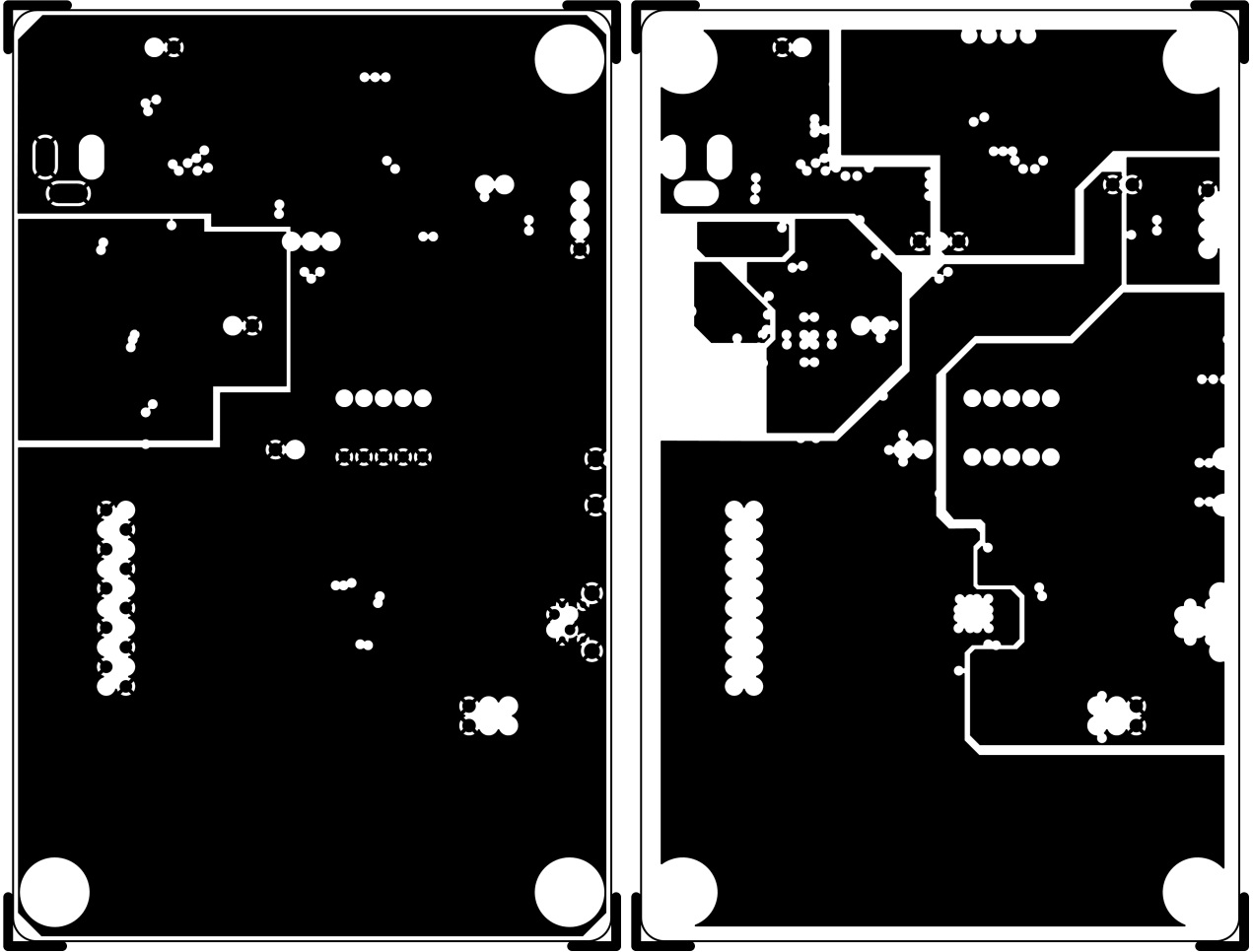

C-3. Internal Layer 1: Ground

C-4. Internal Layer 2: Power

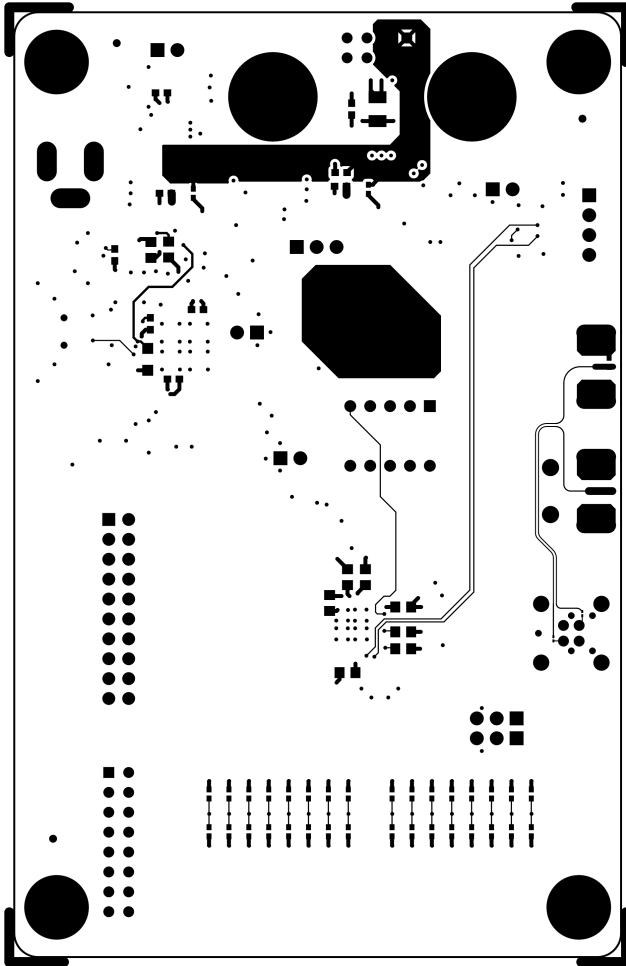

C-5. Bottom Copper

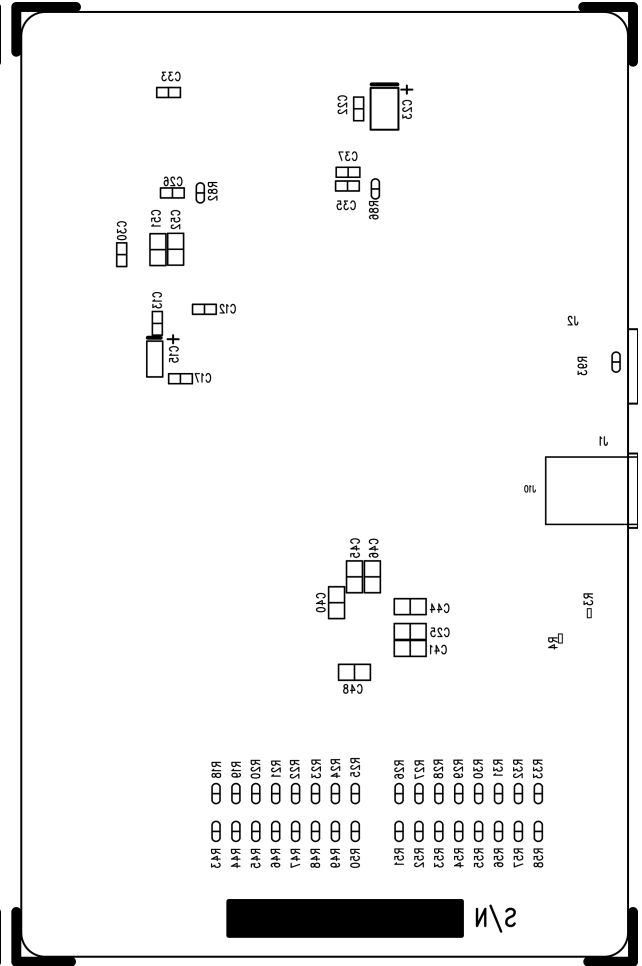

C-6. Bottom Silkscreen

IMPORTANT NOTICE FOR TI REFERENCE DESIGNS

Texas Instruments Incorporated ("TI") reference designs are solely intended to assist designers ("Buyers") who are developing systems that incorporate TI semiconductor products (also referred to herein as "components"). Buyer understands and agrees that Buyer remains responsible for using its independent analysis, evaluation and judgment in designing Buyer's systems and products.

TI reference designs have been created using standard laboratory conditions and engineering practices. **TI has not conducted any testing other than that specifically described in the published documentation for a particular reference design.** TI may make corrections, enhancements, improvements and other changes to its reference designs.

Buyers are authorized to use TI reference designs with the TI component(s) identified in each particular reference design and to modify the reference design in the development of their end products. HOWEVER, NO OTHER LICENSE, EXPRESS OR IMPLIED, BY ESTOPPEL OR OTHERWISE TO ANY OTHER TI INTELLECTUAL PROPERTY RIGHT, AND NO LICENSE TO ANY THIRD PARTY TECHNOLOGY OR INTELLECTUAL PROPERTY RIGHT, IS GRANTED HEREIN, including but not limited to any patent right, copyright, mask work right, or other intellectual property right relating to any combination, machine, or process in which TI components or services are used. Information published by TI regarding third-party products or services does not constitute a license to use such products or services, or a warranty or endorsement thereof. Use of such information may require a license from a third party under the patents or other intellectual property of the third party, or a license from TI under the patents or other intellectual property of TI.

TI REFERENCE DESIGNS ARE PROVIDED "AS IS". TI MAKES NO WARRANTIES OR REPRESENTATIONS WITH REGARD TO THE REFERENCE DESIGNS OR USE OF THE REFERENCE DESIGNS, EXPRESS, IMPLIED OR STATUTORY, INCLUDING ACCURACY OR COMPLETENESS. TI DISCLAIMS ANY WARRANTY OF TITLE AND ANY IMPLIED WARRANTIES OF MERCHANTABILITY, FITNESS FOR A PARTICULAR PURPOSE, QUIET ENJOYMENT, QUIET POSSESSION, AND NON-INFRINGEMENT OF ANY THIRD PARTY INTELLECTUAL PROPERTY RIGHTS WITH REGARD TO TI REFERENCE DESIGNS OR USE THEREOF. TI SHALL NOT BE LIABLE FOR AND SHALL NOT DEFEND OR INDEMNIFY BUYERS AGAINST ANY THIRD PARTY INFRINGEMENT CLAIM THAT RELATES TO OR IS BASED ON A COMBINATION OF COMPONENTS PROVIDED IN A TI REFERENCE DESIGN. IN NO EVENT SHALL TI BE LIABLE FOR ANY ACTUAL, SPECIAL, INCIDENTAL, CONSEQUENTIAL OR INDIRECT DAMAGES, HOWEVER CAUSED, ON ANY THEORY OF LIABILITY AND WHETHER OR NOT TI HAS BEEN ADVISED OF THE POSSIBILITY OF SUCH DAMAGES, ARISING IN ANY WAY OUT OF TI REFERENCE DESIGNS OR BUYER'S USE OF TI REFERENCE DESIGNS.

TI reserves the right to make corrections, enhancements, improvements and other changes to its semiconductor products and services per JESD46, latest issue, and to discontinue any product or service per JESD48, latest issue. Buyers should obtain the latest relevant information before placing orders and should verify that such information is current and complete. All semiconductor products are sold subject to TI's terms and conditions of sale supplied at the time of order acknowledgment.

TI warrants performance of its components to the specifications applicable at the time of sale, in accordance with the warranty in TI's terms and conditions of sale of semiconductor products. Testing and other quality control techniques for TI components are used to the extent TI deems necessary to support this warranty. Except where mandated by applicable law, testing of all parameters of each component is not necessarily performed.

TI assumes no liability for applications assistance or the design of Buyers' products. Buyers are responsible for their products and applications using TI components. To minimize the risks associated with Buyers' products and applications, Buyers should provide adequate design and operating safeguards.

Reproduction of significant portions of TI information in TI data books, data sheets or reference designs is permissible only if reproduction is without alteration and is accompanied by all associated warranties, conditions, limitations, and notices. TI is not responsible or liable for such altered documentation. Information of third parties may be subject to additional restrictions.

Buyer acknowledges and agrees that it is solely responsible for compliance with all legal, regulatory and safety-related requirements concerning its products, and any use of TI components in its applications, notwithstanding any applications-related information or support that may be provided by TI. Buyer represents and agrees that it has all the necessary expertise to create and implement safeguards that anticipate dangerous failures, monitor failures and their consequences, lessen the likelihood of dangerous failures and take appropriate remedial actions. Buyer will fully indemnify TI and its representatives against any damages arising out of the use of any TI components in Buyer's safety-critical applications.

In some cases, TI components may be promoted specifically to facilitate safety-related applications. With such components, TI's goal is to help enable customers to design and create their own end-product solutions that meet applicable functional safety standards and requirements. Nonetheless, such components are subject to these terms.

No TI components are authorized for use in FDA Class III (or similar life-critical medical equipment) unless authorized officers of the parties have executed an agreement specifically governing such use.

Only those TI components that TI has specifically designated as military grade or "enhanced plastic" are designed and intended for use in military/aerospace applications or environments. Buyer acknowledges and agrees that any military or aerospace use of TI components that have **not** been so designated is solely at Buyer's risk, and Buyer is solely responsible for compliance with all legal and regulatory requirements in connection with such use.

TI has specifically designated certain components as meeting ISO/TS16949 requirements, mainly for automotive use. In any case of use of non-designated products, TI will not be responsible for any failure to meet ISO/TS16949.