

Inductive Touch System Design Guide for HMI Button Applications



Yibo Yu, Chris Oberhauser

ABSTRACT

The Inductive Touch System Design Guide presents an overview of the typical sensor mechanical structure and sensor electrical design for human machine interface (HMI) button applications. The mechanical design chapter discusses several factors that impact button sensitivity, including metal selection, sensor geometry, sensitivity dependence on target-to-coil distance, and mechanical isolations. Two options of common layer stacks for inductive touch buttons are also presented. The sensor design chapter focuses on flex PCB sensor electrical requirements and considerations for optimal sensitivity.

Table of Contents

1 Mechanical Design	2
1.1 Theory of Operation.....	2
1.2 Button Construction.....	2
1.3 Mechanical Deflection.....	3
1.4 Mechanical Factors that Affect Sensitivity.....	4
1.5 Layer Stacks of Touch Buttons.....	5
1.6 Sensor Mounting Reference.....	6
1.7 Sensor Mounting Techniques.....	7
1.8 Mechanical Isolation.....	10
2 Sensor Design	11
2.1 Overview.....	11
2.2 Inductive Touch.....	13
2.3 LDC211x/LDC3114 Design Boundary Conditions.....	13
2.4 Sensor Physical Construction.....	14
2.5 Example Sensor.....	20
3 Summary	24
4 Revision History	24

1 Mechanical Design

Implementing an effective inductive touch solution requires appropriate system mechanical design and matching sensor design. The mechanical design should take into consideration the material properties, button geometry, and sensor construction and mounting. The following sections will address each of these topics.

1.1 Theory of Operation

Consider a flat metal plate held at a fixed distance from an inductive coil sensor, as shown in [Figure 1-1](#). If a force is applied onto the metal plate, the metal will deform slightly. For example, with a 1 N force, which is approximately the weight of a computer mouse, a 1-mm thick aluminum plate that is 15 mm × 15 mm will deform by about 0.2 μm. This deformation moves the opposite side of the plate closer to the LDC sensor. When the force is removed, the plate will return to its original unstressed shape.

When the conductive material is in close proximity to the inductor, the magnetic field will induce circulating eddy currents on the surface of the conductor. The eddy currents are a function of the distance, size, and composition of the conductor. If the conductor is deflected toward the inductor as shown in [Figure 1-1](#), more eddy currents will be generated.

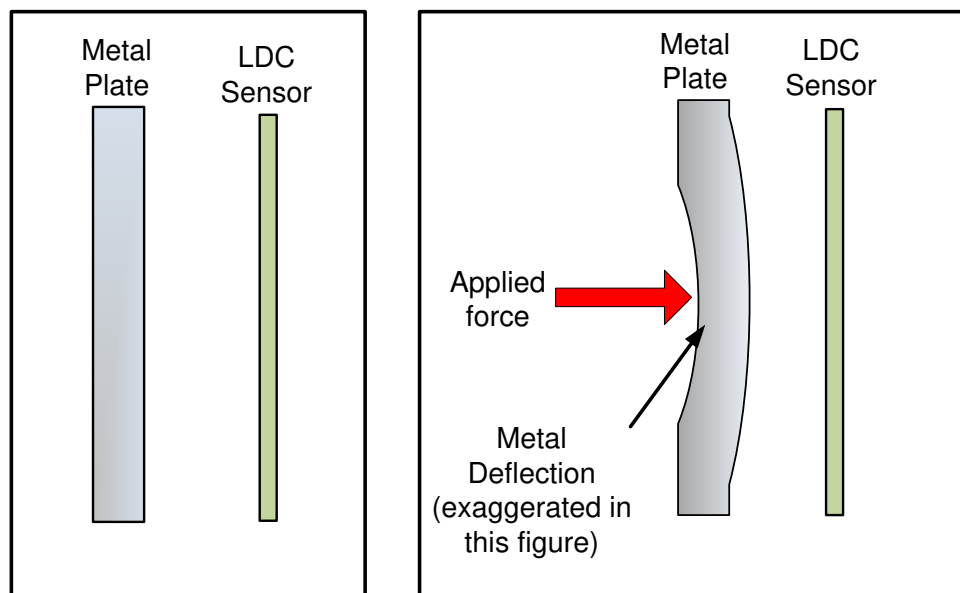

Figure 1-1. Metal Deflection

The eddy currents generate their own magnetic field, which opposes the original field generated by the inductor. This effect reduces the inductance of the system, resulting in an increase in sensor frequency. As the conductive target moves closer to the sensor, the electromagnetic coupling between them becomes stronger. As a result, the change in sensor frequency is also more significant.

1.2 Button Construction

Using the principle discussed above, we can construct a metal plate and sensor combination which can function as a button. As the sensitivity of the sensor increases with closer targets, the conductive plate should be placed quite close to the sensor—typically 10% of the sensor diameter. At this close distance, the LDC can reliably measure a 0.2-μm deflection. For small deflections, the amount of deflection is roughly proportional to the applied force.

For a robust interface, it is necessary to control the distance between the sensor and the target so that random movements are not interpreted as button presses. [Figure 1-2](#) shows how sensors can be clamped onto the inside surface so that only touch forces cause a deflection toward the sensor and any other forces do not produce an effective deflection toward the sensor.

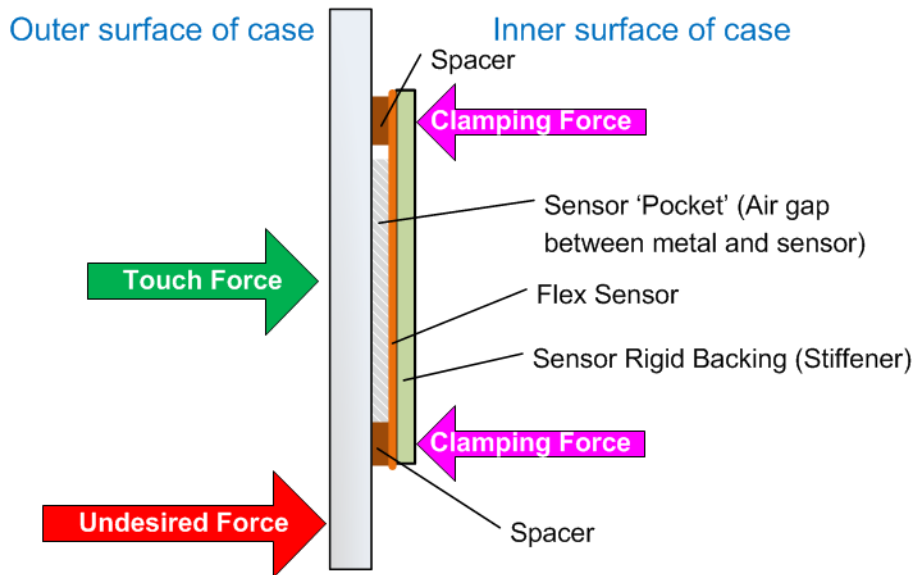

Figure 1-2. Button Construction With Metal Target and PCB Sensor

If the sensor is constructed of a rigid PCB material such as FR4, then the rigid backing is not necessary.

1.3 Mechanical Deflection

The LDC211x and LDC3114 devices measure the shift in frequency of an LC resonator sensor. [Figure 1-3](#) shows the change in frequency versus metal deflection for an example flex PCB sensor. The nominal spacing between the metal target and sensor is 150 μm . As shown in the graph, the change in frequency is approximately linear with small metal deflections.

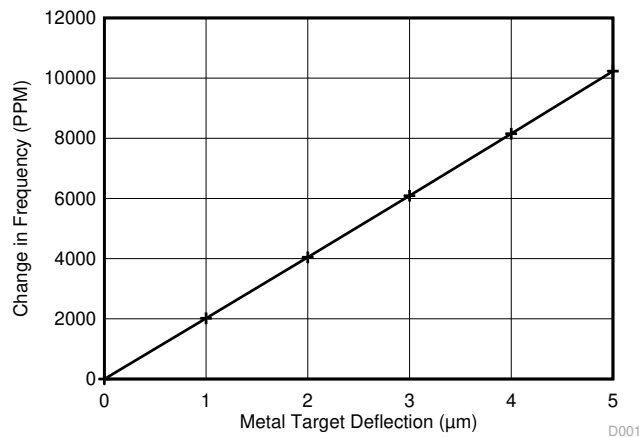

Figure 1-3. Simulated Sensor Frequency Change (PPM) vs Deflection (μm) for an Example Sensor

To design an inductive touch button system, TI recommends to obtain the deflection vs force characteristic of the button surface. It is often easier to determine this using mechanical modeling and simulation. This is to ensure that there is enough deflection for a desirable force threshold. The Metal Deflection tab of the [LDC Calculations Tool](#) provides an estimate of the metal deflection for a specified button material and geometry.

1.4 Mechanical Factors that Affect Sensitivity

The button performance depends on the mechanical characteristics of the layer stack, as well as the electrical parameters of the LC sensor. The most important mechanical factors are listed below.

1.4.1 Target Material Selection

As discussed in [Section 1.1](#), inductive button operates based on the electromagnetic coupling between a coil sensor and metal target. The mechanical and electrical characteristics of the metal target significantly affect the sensitivity of the button.

1.4.1.1 Material Stiffness

The material choice has a large impact on how much force is needed to achieve the required deflection for a given metal thickness. The key material parameter is the Young's modulus, which is a measure of the elasticity of the metal and is measured in units of pascal (Pa). Materials with a lower Young's modulus are typically more flexible. For example, aluminum (AL6061-T6) has a Young's modulus of 68.9 GPa, while stainless steel (for example, SS304) has a Young's modulus of about 200 GPa, which makes stainless steel about three times stiffer than aluminum. [Figure 1-4](#) shows the difference in deflection versus force for a given circular sensor between the two materials.

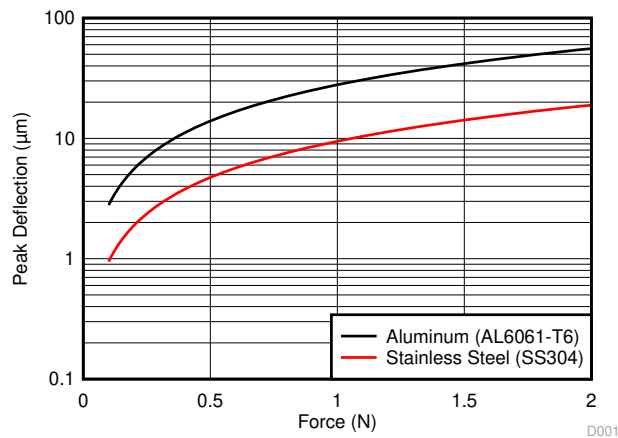

Figure 1-4. Deflection vs Force for Al and Steel Targets, Circular Button, Diameter = 20 mm, Thickness = 0.25 mm

1.4.1.2 Material Conductivity

The higher the conductivity of the target material, the more eddy currents are generated on the surface. This causes a stronger electromagnetic interaction with the sensor. Therefore, the conductivity of the material should be as high as possible, as this produces the largest inductance shift for a given target deflection. SS304 has a conductivity of 1.37×10^6 S/m, and aluminum has an even higher conductivity of 36.9×10^6 S/m.

In general, aluminum is an excellent material choice for inductive sensing because aluminum is both flexible and asserts a large inductance change on a sensing coil. Materials such as SS304, while not as optimal a material choice as aluminum, can also be used and provide robust results.

1.4.2 Button Geometry

Inductive touch buttons can take on a variety of shapes, such as circular, oval, or rectangular. In designing the button sizes and geometries, it is important to consider the amount of deflection that can be obtained for a given material, metal thickness, desirable force, and so forth. In the case of circular buttons, the diameter of the button determines its rigidity or how much deflection can be obtained, assuming all other parameters are kept the same. For example, if a circular 0.6-mm thick aluminum button is pressed with 1 N uniform force, a button of 10-mm diameter has a peak deflection of about 90 nm, while a button of 20-mm diameter would have a peak deflection of about 350 nm. The Metal Deflection tab of the [LDC Calculations Tool](#) provides an estimate of the metal deflection for a specified button material and geometry. The exact deflection profile can be obtained through mechanical simulation tools.

1.4.3 Spacing Between Target and Sensor

The spacing between the metal target and PCB sensor is important for both electrical and mechanical considerations. As the metal target approaches the coil sensor, it can interact with more of the electromagnetic field. Therefore for the same deflection (for example, 1 μm) at a closer nominal distance, the amount of inductance shift increases, which leads to a larger change in frequency (see Figure 1-5). In other words, if the target is closer to the sensor, the system sensitivity is higher.

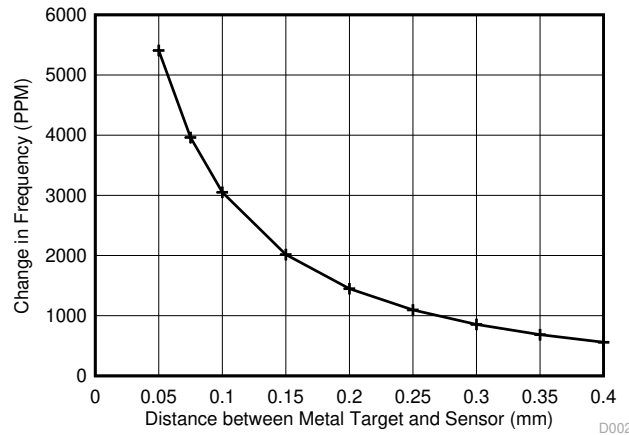

Figure 1-5. Simulated Change in Frequency (PPM) for 1- μm Deflection vs Target Distance (mm)

However, to ensure that there is enough room for deflection and meanwhile accounting for manufacturing tolerances, TI recommends to have a nominal target-to-sensor distance of 0.1 to 0.2 mm. This spacing can be achieved by creating recessed area in the metal facing the sensor for systems where the PCB is placed flush to the metal, or by using a small spacer between the metal and the PCB sensor with a cutout to allow the metal to deflect, as shown in Figure 1-6.

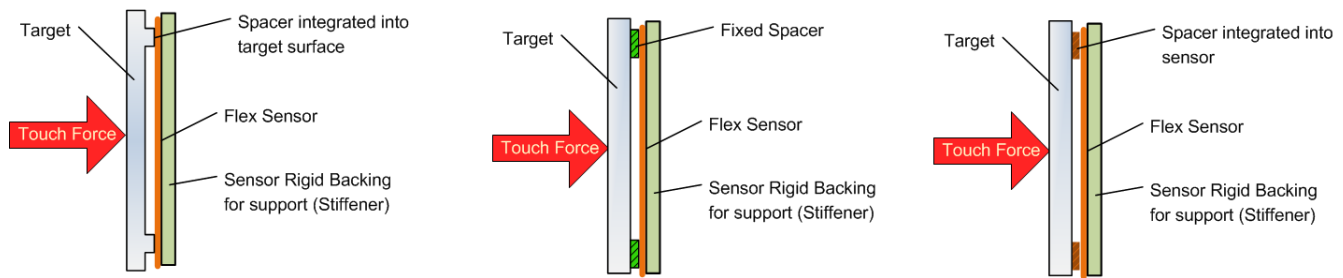

Figure 1-6. Spacer Options

Maintaining a consistent separation between the sensor and the target is critical to ensure effective sensing. If spacers are used, the material should be non-compressible and have a low temperature coefficient, so that the thickness does not vary over time or environmental conditions.

1.5 Layer Stacks of Touch Buttons

The button layer stack typically includes the conductive target, spacer (separation between target and sensor), PCB coil sensor, and an optional stiffener (supporting structure for flex PCB sensors). There are two common ways to implement the stack, depending on whether the surface is conductive.

1.5.1 Conductive Surface

If the touch button is implemented on a conductive surface, such as aluminum or stainless steel, the surface can be used as the target of detection. In this configuration, the metal target is at the top of the entire stack. The user directly presses the metal target, causing a micro-deflection in the metal itself. The metal deflection will cause a change in the inductance of the sensor coil.

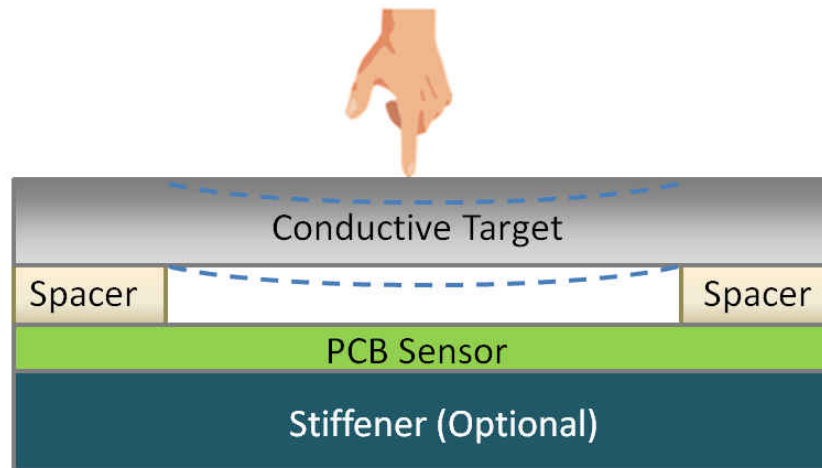

Figure 1-7. Example Layer Stack With Conductive Surface

1.5.2 Non-Conductive Surface

For non-conductive surfaces such as glass or plastic, a thin sheet of conductive layer, such as aluminum or copper, should be embedded below the surface. When the user presses on the rigid surface at the top of the stack, a micro-deflection is translated onto the conductive layer, bringing the layer closer to the PCB sensor. This alternative approach can extend the application of inductive touch to virtually any material surface.

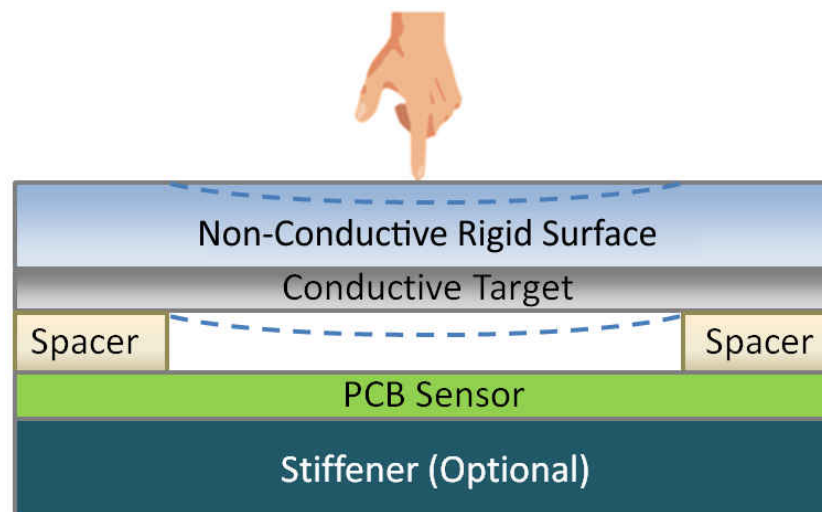

Figure 1-8. Example Layer Stack With Non-Conductive Surface

1.6 Sensor Mounting Reference

In general, the coil sensor should be directly attached to the metal target, not to other adjacent structures, to avoid mechanical movement of the support structure causing unexpected movement of the sensor. When the sensor is mounted to some other adjacent structure that can move with respect to the target, that motion can be misinterpreted as a button press.

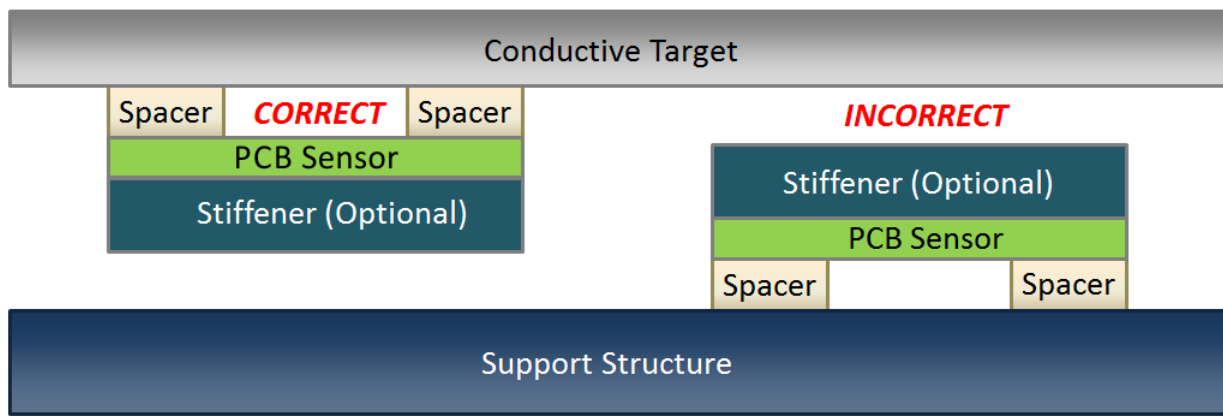

Figure 1-9. Sensors Mounted to the Metal Target (Correct) and to the Support Structure (Incorrect)

1.7 Sensor Mounting Techniques

The sensor coils can be mounted to the metal target in many ways. The sensor mounting technique must provide consistent performance with minimal crosstalk between neighboring buttons. This implies that any force outside the button region should cause minimal local metal deflection at that button location. In order to achieve this goal, the spacer should provide robust attachment between the metal and coil. At the same time, the sensors should be mass-production friendly in terms of both cost and installation effort.

Three different mounting techniques are presented below, namely adhesive-based, spring-based, and slot-based.

1.7.1 Adhesive-Based

The most straight-forward method for mounting the sensors is to apply adhesive to the spacers and glue them to the metal target. The adhesive-based system does not require additional mechanical pieces and is suitable for quick prototyping. The downside is that the glue attachment process is less repeatable.

Figure 1-10 shows an image of the two side buttons on a phone case prototype. The size of each button coil is 8 mm × 2.7 mm. The inside of the case is recessed to make room for the coils. This not only reduces the board area used by the coils, but also reduces the rigidity of the metal sidewall and enhances sensitivity.

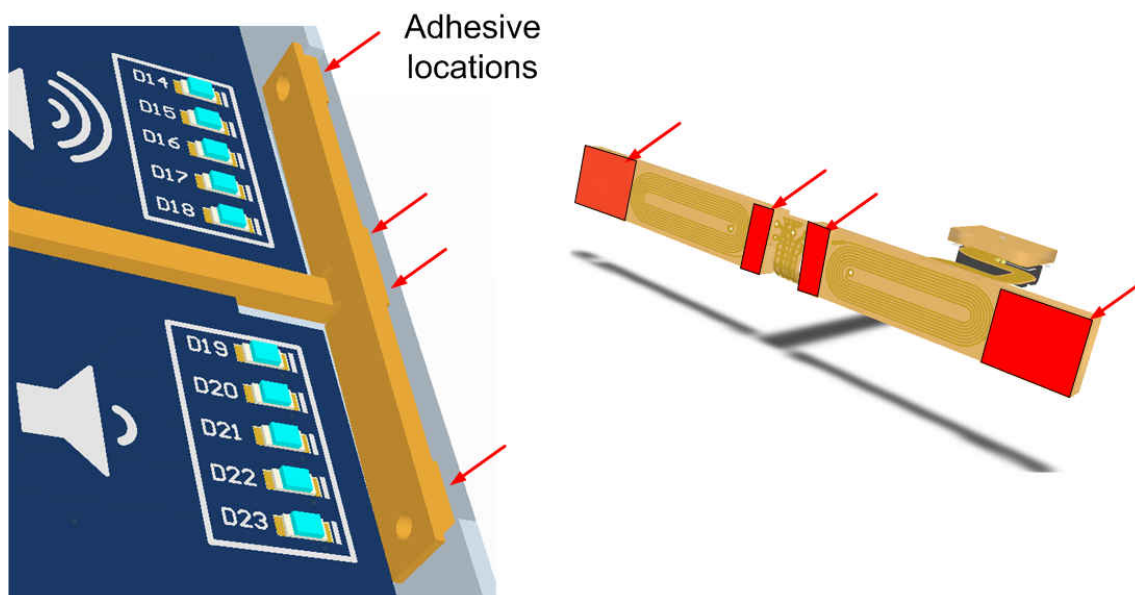

Figure 1-10. Adhesive-Based Sensor Structure

1.7.2 Spring-Based

An alternative method is to use a spring-based structure to push the sensors toward the metal target. The spring arms can help to absorb unwanted movement in the vertical axis, therefore the system is less susceptible to mechanical interference due to twisting. Such a system is easier to assemble than an adhesive-based one. The disadvantage is that if the spring is attached to the PCB or the bottom of the case, pinching the location of contact may cause interference in a less rigid case. The sensor structure also takes up more space due to the additional mechanical pieces.

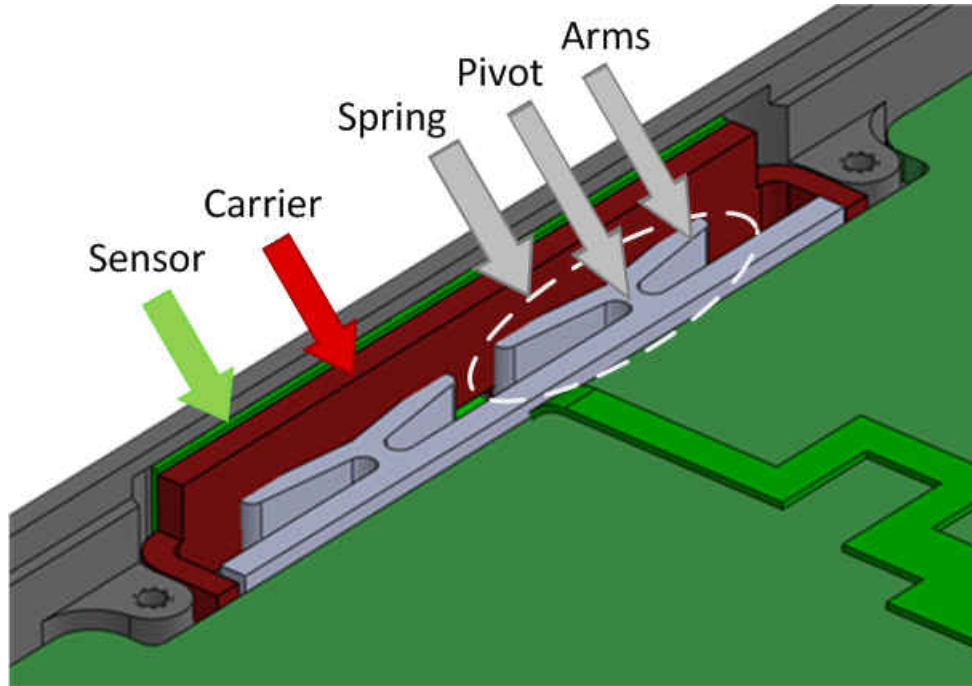

Figure 1-11. Spring-Based Sensor Structure

1.7.3 Slot-Based

A third sensor integration technique is to insert the coil into a slot. Before inserting the sensor coil, memory foam pads are glued to both sides of the coil. This step can be integrated into the PCB fabrication process. When squeezed, the memory foam pads become thinner than the width of the slot and thus can be inserted easily. After the foam pads are inserted into the slot, they restore to fill the entire slot within a few seconds and serve as the “spacer” between the target and coil. The coil will be placed right in the middle of the slot. The unique sensor enclosure is a more rigid structure compared to that of the previous solutions. This approach provides the best immunity against undesirable mechanical interference such as twisting and pinching.

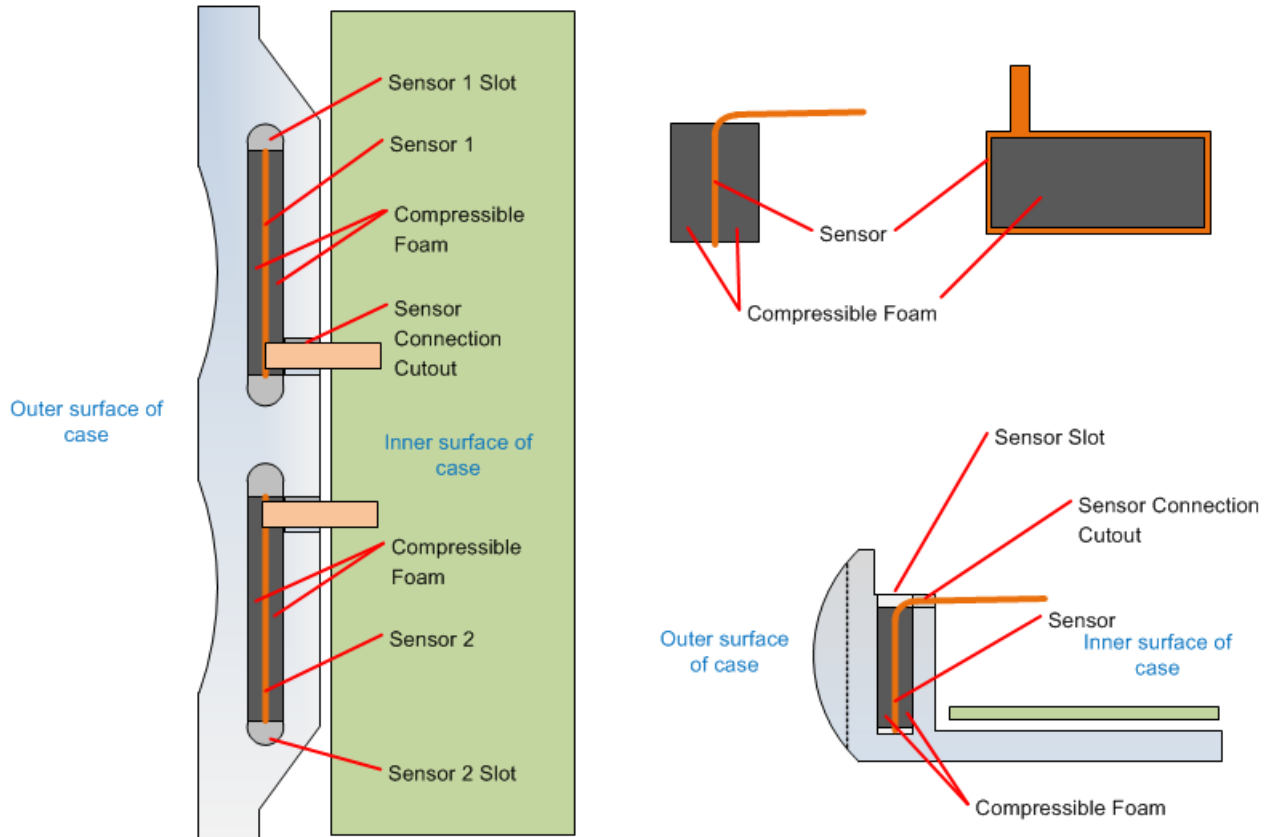

Figure 1-12. Slot-Based Sensor Structure

Copper foil can be used to make a “Faraday Box” to completely shield the sensor in strong EMI environment, such as wireless charging.



Figure 1-13. Copper Foil Shielded “Faraday Box”

1.8 Mechanical Isolation

When multiple buttons are present in a system, it is possible for undesirable mechanical interaction between different buttons to occur. The LDC2112, LDC2114, LDC3114, and LDC3114-Q1 all have built-in algorithms to handle most of such crosstalk. However, good mechanical design principles should still be applied so that the crosstalk between adjacent buttons can be minimized. The following principles can be applied to reduce the mechanical crosstalk between adjacent buttons during an active press:

1. Physical supports between buttons can facilitate larger metal deformation on the button that is pressed.
2. Ensuring a larger physical deflection for the intended button. From an electrical perspective, a larger deflection enables a greater signal. Using a thinner metal or metal with a lower Young’s modulus facilitates button surface deformation and reduces the impact on the neighboring buttons.
3. Increasing the distance or adding grooves between adjacent buttons improves mechanical isolation. For crosstalk minimization, button-to-button separation should also be greater than one coil diameter.

2 Sensor Design

2.1 Overview

The Inductive Touch System uses a sensor composed of an inductor in parallel with a capacitor to form an LC resonator.

The resonator generates a magnetic field which interacts with nearby conductive materials. The generated magnetic field is a near-field effect, and so the first principle of sensor design is to ensure that the field reaches the desired conductive material, which we refer to as the target.

The TI application note [LDC Sensor Design](#) provides extensive detail on sensor construction. Many of the concepts and recommendations in that application note apply to designing sensors suitable for Inductive Touch applications.

2.1.1 Sensor Electrical Parameters

The primary electrical parameters for an inductive sensor are:

- Sensor resonant frequency f_{SENSOR} ,
- Sensor resistance (represented as R_P or R_S)
- Sensor inductance L ,
- Sensor capacitance C ,
- Sensor quality factor Q .

2.1.2 Sensor Frequency

The inductance and capacitance listed in [Equation 1](#) determine the sensor frequency.

$$f_{\text{SENSOR}} = \frac{1}{2\pi\sqrt{LC}} \quad (1)$$

In general, as the magnetic field of the sensor interacts with a conductive target, the effective inductance of the sensor changes, causing the sensor resonant frequency to change.

2.1.3 Sensor R_P and R_S

R_P represents the parallel resonant impedance of the oscillator, and R_S represents the series resonant impedance. These resistances are different representations of the same parasitic losses.

As conductive materials get closer to the sensor, the intensity of the eddy currents increases, which corresponds to larger losses in the sensor. The sensor R_S is based on the series electrical model, while the R_P is based on the parallel electrical model, as shown in [Figure 2-1](#). It is important to remember that these resistances are AC resistances, and not the DC resistances.

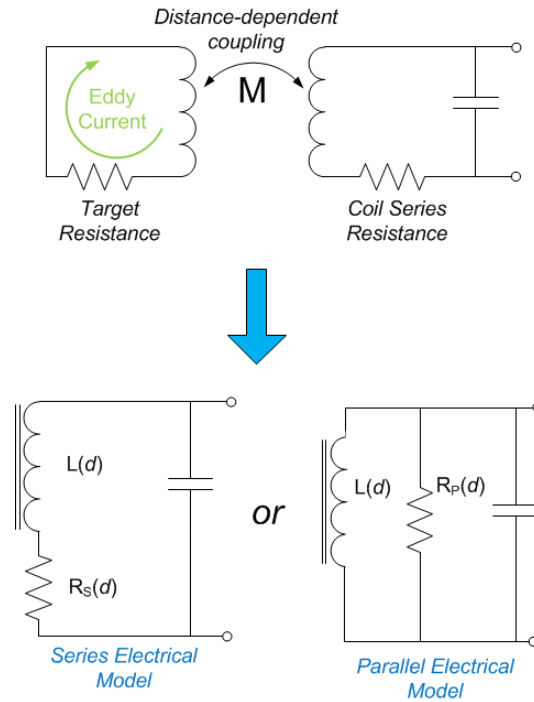

Figure 2-1. Sensor Models

Use [Equation 2](#) to calculate the R_P from the R_S .

$$R_P = \frac{L}{R_S \times C} \tag{2}$$

The Sensor R_P decreases significantly as the conductive material is brought closer to the sensor surface, as seen in [Figure 2-2](#). The example sensor response graphed in [Figure 2-2](#) has an R_P variation between 2 k Ω and 8 k Ω . This variation can be normalized response to apply to most sensors. If a 4-mm diameter sensor had a free space R_P of 3 k Ω , the sensor would have a R_P of approximately 2.2 k Ω if the distance to the conductive material was 0.5 mm.

It is possible that the sensor R_P can be reduced to too low a level if the target is too close to the sensor. This condition must be avoided for proper functionality. Refer to [Section 2.3](#) for more details.

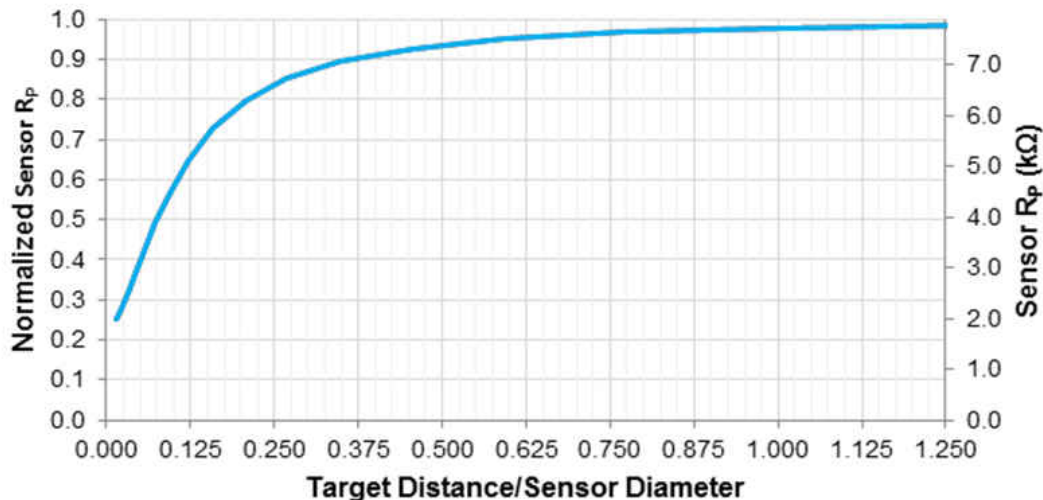

Figure 2-2. Example Sensor R_P vs Target Distance

2.1.4 Sensor Inductance

The sensor inductance is a function of the geometry of the inductor—the inductor area, number of windings, and also the interaction with any conductive materials. In general, a larger inductance value is easier to drive. The sensing range of the inductor is based primarily on the physical size of the inductor, not the inductance, where the larger the inductor, the farther the sensing range.

2.1.5 Sensor Capacitance

In general, the sensor capacitance is selected after the inductor has been designed, and is used to set the sensor frequency. Use of very small sensor capacitances should be avoided so that any parasitic capacitance shifts do not affect operation. As a general guideline, use of sensor capacitances smaller than 22 pF should be avoided.

2.1.6 Sensor Quality Factor

The sensor Quality Factor Q measures the ratio of the sensor inductance to the sensor's AC resistance. In general, a higher value is desirable, as the sensor requires less energy to maintain oscillation. Use [Equation 3](#) to calculate the sensor Q .

$$Q = \frac{1}{R_S} \sqrt{\frac{L}{C}} \quad (3)$$

The R_S is the sensor's series AC resistance at the frequency of operation. The sensor Q can be increased by either increasing the sensor inductance, decreasing the sensor R_S , or decreasing capacitance.

2.2 Inductive Touch

LDC technology can be used to detect metal deflection as an emulation of a button. This capability provides many advantages, such as operation with seamless, grounded plates of metal, operation in wet or humid environments, resistance to false touch events, and reliable operation even when the user is wearing gloves. This application is discussed in the TI Application Note [Inductive Sensing Touch-On-Metal Buttons Design Guide](#).

2.3 LDC211x/LDC3114 Design Boundary Conditions

The LDC2112 and LDC2114 are high resolution Inductance-to-Digital Converters (LDCs) which internal algorithms can detect inductance shifts corresponding to button presses on metal or other surfaces. These devices require that the attached sensors meet the following parameters:

- $1 \text{ MHz} \leq f_{\text{SENSOR}} \leq 30 \text{ MHz}$
- $350 \Omega \leq R_P \leq 10 \text{ k}\Omega$
- $5 \leq Q \leq 30$

The LDC3114 and LDC3114-Q1 are similar devices but require the sensor frequency to be between 5 MHz and 30 MHz and offer slightly different functionality such as the ability to access the raw data before the internal algorithm if desired. If the sensor parameters are not within these specifications, the LDC may not be able to measure inductance shifts, and as a result will not indicate Inductive Touch events. [Figure 2-3](#) show these restrictions, which is derived from [Equation 1](#).

LDC2112/LDC2114 Operating region

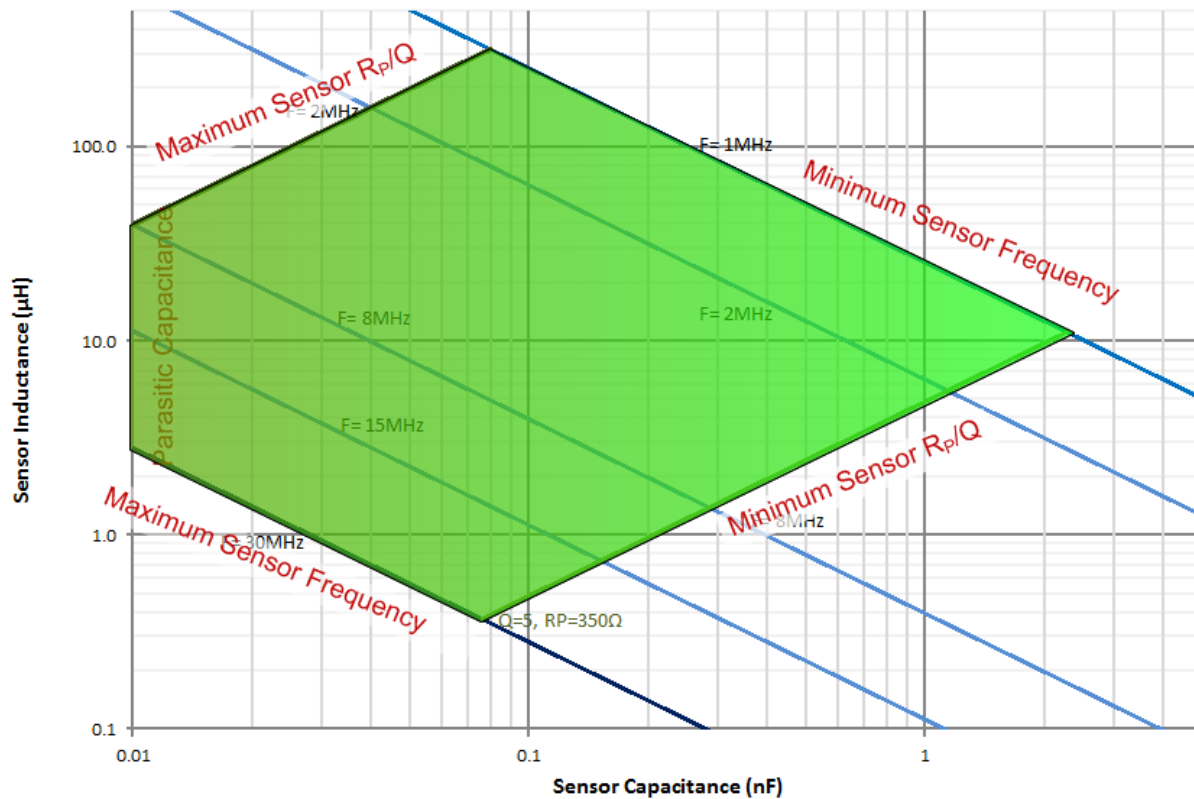

Figure 2-3. LDC2112/LDC2114 Operating Region

Use Equation 4 to calculate the minimum sensor frequency on the top-right boundary:

$$L = \frac{1}{(2\pi \times 1 \text{ MHz})^2 C} \quad (4)$$

Use Equation 5 to calculate the maximum sensor frequency on the bottom-left boundary:

$$L = \frac{1}{(2\pi \times 30 \text{ MHz})^2 C} \quad (5)$$

On the left, if the sensor capacitance is too small, then parasitic capacitance effects may degrade the sensor operation. While this boundary is shown at 10 pF, some systems may encounter issues even with larger sensor capacitances. In general, TI recommends to use a sensor capacitance larger than 22 pF.

2.4 Sensor Physical Construction

2.4.1 Sensor Physical Size

Inductive touch functionality is based on the sensor's magnetic field interacting with a metal surface. Therefore the magnetic field must reach the surface of the metal. The magnetic field 'size' is based on the size of the inductor—the larger the inductor, the larger the generated magnetic field.

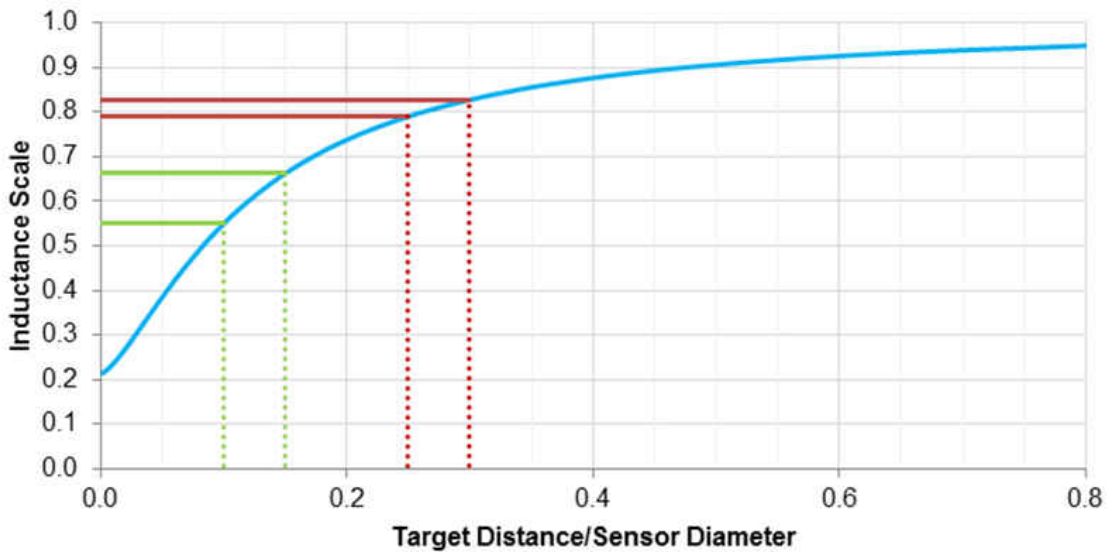

Figure 2-4. Inductance Shift vs Target Distance

For a circular inductor, the size of the inductor is the diameter. For a non-circular inductor, sensor diameter is effectively the minimum axis size.

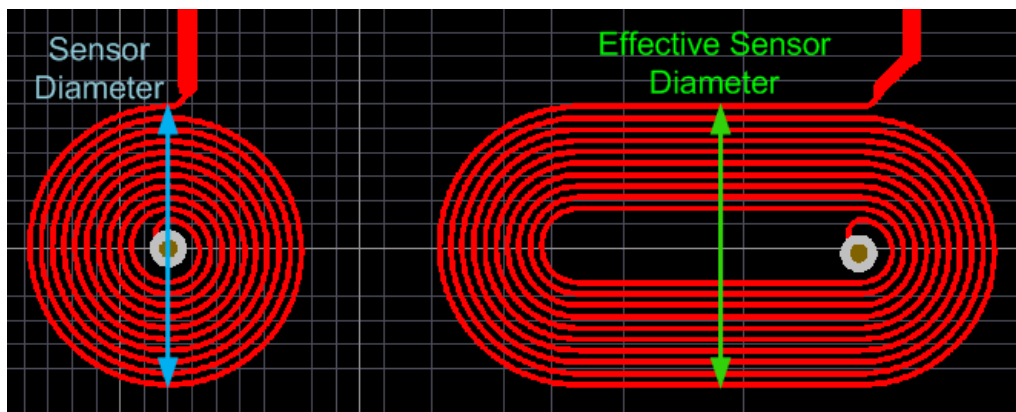

Figure 2-5. Sensor Diameter for Circular and Racetrack Sensor Coils

2.4.2 Sensor Capacitor Position

TI recommends to place the sensor capacitor close to the INn pin, and not near the sensor. This placement avoids transmission line effects with higher frequency sensors.

2.4.3 Shielding INn traces

For reliable inductive touch applications, the INn traces should not have significant time-varying capacitance shifts. Parasitic capacitance shifts could produce false button press events if the INn traces are not shielded. TI recommends to surround the INn traces with a shield driven by the COM pin (see [Figure 2-6](#)).

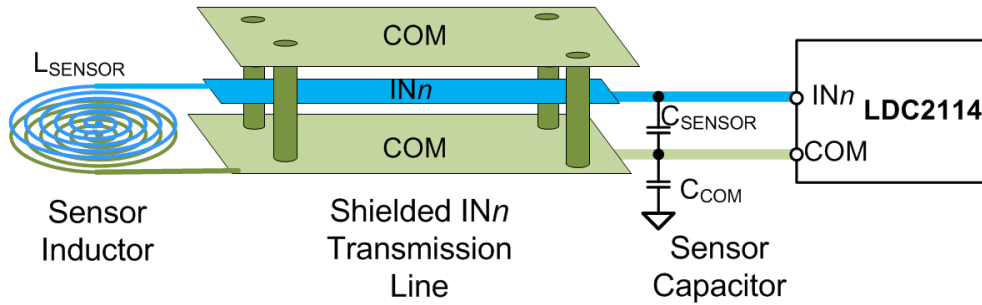

Figure 2-6. IN_n Shielding With COM

2.4.4 Shielding Capacitance

The LC resonator sensor can respond to both inductive and capacitive changes. In order to prevent any capacitive effects from causing undesired signal responses, the metal target should have a fixed constant potential. Therefore in constructing the sensor-target system, the conductive target should be AC grounded to shield any external capacitances.

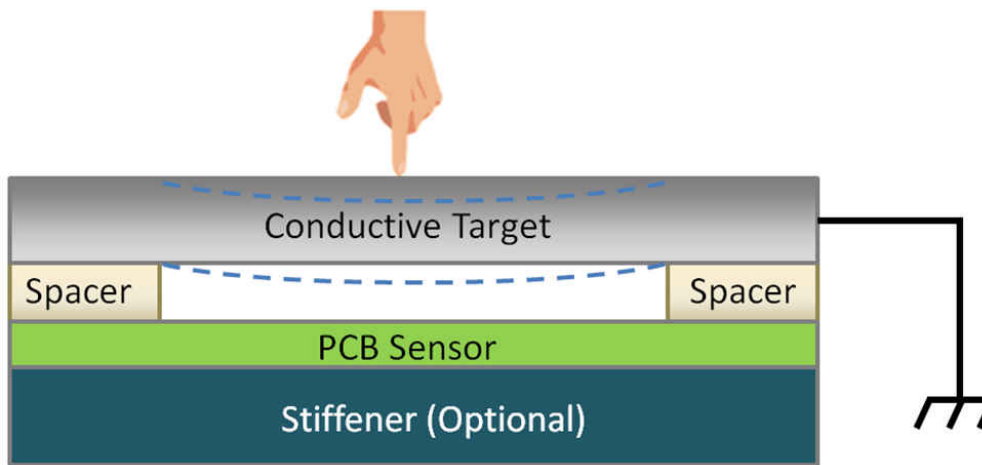

Figure 2-7. AC Grounded Target for Shielding Capacitive Effects

2.4.5 C_{COM} Sizing

The COM pin can drive a load of up to 20 nF to ground. C_{COM} should be sized so that the following relationship is valid for all channels.

$$100 \times C_{\text{SENSOR}} / Q_{\text{SENSOR}} < C_{\text{COM}} < 1250 \times C_{\text{SENSOR}} / Q_{\text{SENSOR}} \quad (6)$$

This requirement is still necessary even if C_{SENSOR} is not the same value for all channels.

2.4.6 Multi-Layer Design

The inductance of a sensor is a function of the area, and the number of windings, and target distance. With many inductive touch applications, the desired physical size of the buttons may be 3-mm in diameter or smaller. The low total inductance of smaller sensors may result in a sensor frequency which is outside the design space of the LDC. By using multiple layers of alternating rotation sensors, the total inductance, due to additional mutual inductance between layers, is significantly higher compared to a single layer design.

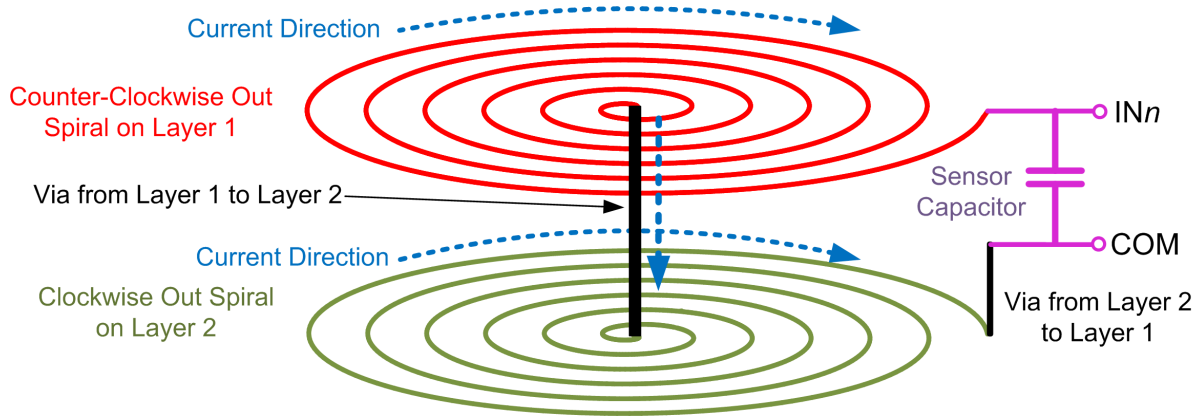

Figure 2-8. 2-Layer Sensor Design

For most applications, 2-layer or 4-layer designs are sufficient. While a 4-layer sensor is more complex and expensive compared to a similar geometry 2-layer sensor, the LDC211x and LDC3114 can effectively drive a physically smaller 4-layer sensor, as shown in Table 2-1.

Use of a single layer sensor is generally not as effective, as the mutual coupling between layers in a multilayer sensor provides a significant increase in the sensor inductance. In addition, there needs to be a second routing to bring the sensor current out from the center of the sensor back to the LDC.

Table 2-1. Approximate Minimum Sensor Width vs Fabrication Restrictions

AVAILABLE SPACING DISTANCE BETWEEN TURNS	NUMBER OF LAYERS	MINIMUM VIA SIZE	MINIMUM SENSOR WIDTH
4 mil (0.1016 mm)	2	15 mil (0.4 mm)	2.85 mm
4 mil (0.1016 mm)	4	15 mil (0.4 mm)	2.30 mm
3 mil (0.076 mm)	2	15 mil (0.4 mm)	2.05 mm
3 mil (0.076 mm)	4	15 mil (0.4 mm)	1.91 mm
2 mil (0.051 mm)	2	15 mil (0.4 mm)	1.65 mm
2 mil (0.051 mm)	4	15 mil (0.4 mm)	1.53 mm
2 mil (0.051 mm)	4	12 mil (0.305 mm)	1.38 mm

Minimum sensor width of a fixed 8-mm sensor length with a target distance of 0.2 mm. These sensors have not been evaluated for performance. These sensors assume a 1-mil (25 µm) dielectric thickness between layers.

2.4.6.1 Sensor Parasitic Capacitance

The individual turns of an inductor have a physical area and are separated by a dielectric, which manifests as small parasitic capacitor across each turn. These parasitic capacitances should be minimized for optimum sensor performance. One simple but effective technique for multi-layer sensors to reduce the parasitic capacitance is to offset any parallel traces between layers, as shown in Figure 2-9.

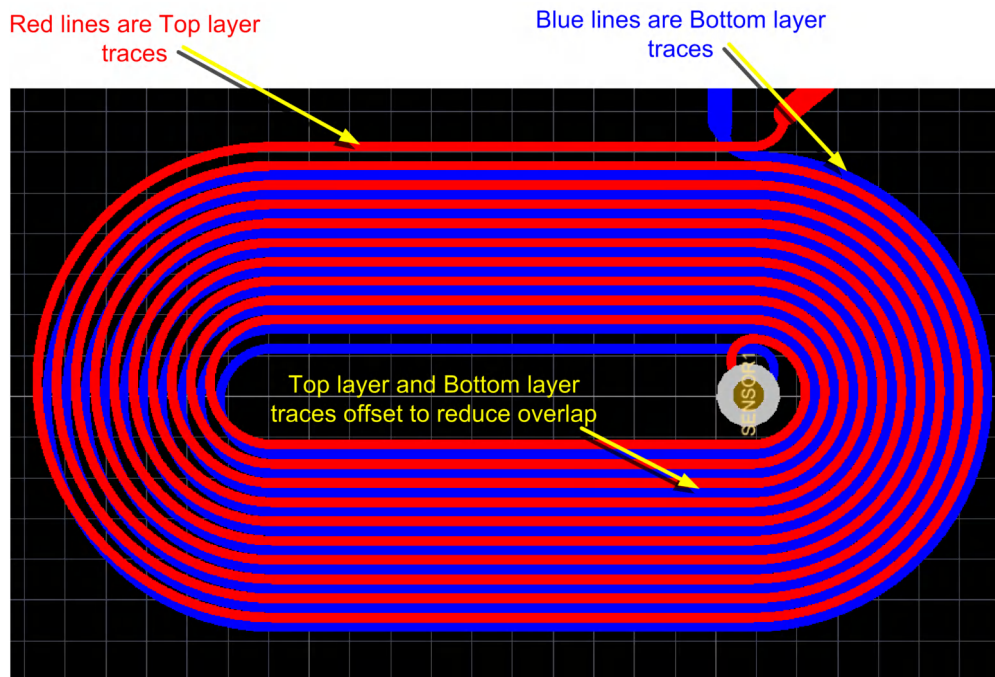

Figure 2-9. Offsetting Traces to Reduce Parasitic Capacitance

2.4.7 Sensor Spacers

Maintaining a consistent separation (gap) between the sensor and the target is critical to ensure effective sensing. The system design feature which provides this is the spacer.

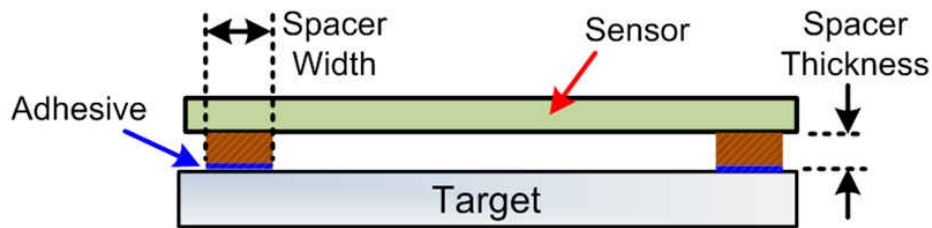

Figure 2-10. Spacer Thickness and Width

Typical spacer thicknesses range from 0.1 mm to 0.5 mm, depending on the sensor geometry and sensor electrical parameters. In general, thinner spacers provide better performance, provided the sensor electrical characteristics are within the LDC211x/LDC3114 boundary conditions. Setting the spacer thickness to less than 10% of the coil diameter (for a rectangular or elliptical shaped sensor, 10% of the shorter side) generally provides optimum performance.

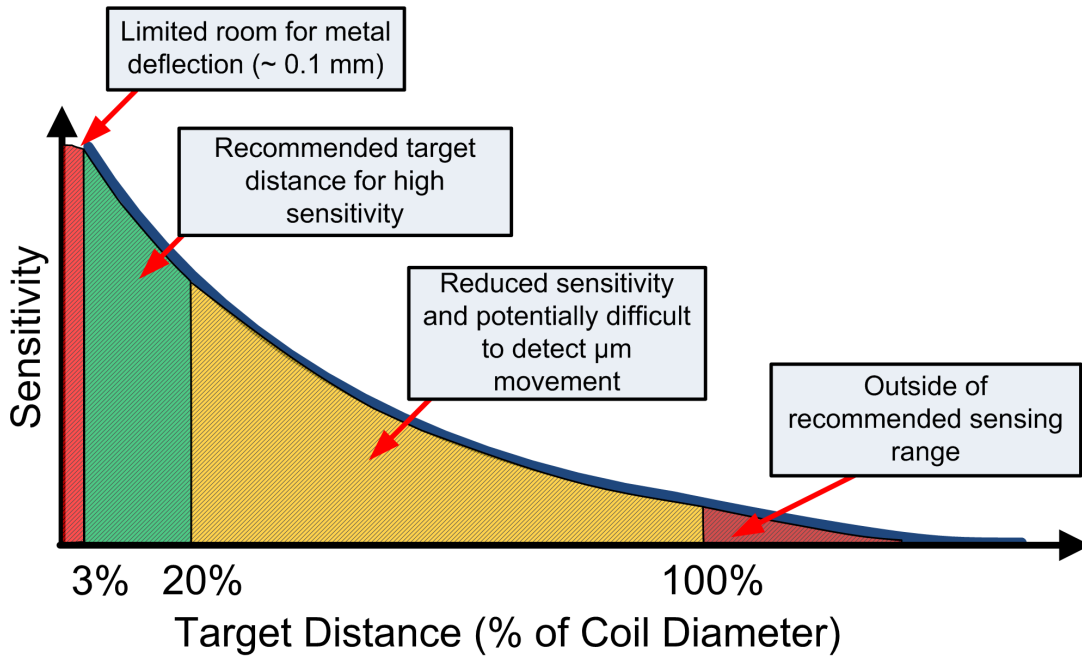

Figure 2-11. Measurement Sensitivity vs Target Distance

Wider spacers may be needed when an adhesive is used to attach the sensor to the target surface, to provide a stronger attachment to the target.

2.4.8 Sensor Stiffener

If a flex PCB is used for the sensor, the sensor must be supported by a stiffener. If a flex sensor is not supported, then it may deform under any movement, leading to false detection events. The support should be a uniform surface which has minimal warping across temperature, humidity, and acceleration. The supporting structure, which is often called a stiffener for LDC applications, should not be conductive; otherwise the sensor R_P and R_S may be reduced below the minimum levels the LDC211x/LDC3114 can support. Use of FR4 backing is a common technique for flex PCBs and is suitable for LDC sensor use. For a thinner sensor, it is acceptable to use an epoxy based stiffener.

The stiffener should be a non-conductive material, otherwise the sensor R_P may be too low for the LDC211x/LDC3114 to drive; for this reason SuS and Al stiffeners should be avoided.

If multiple sensors are constructed on a single flex PCB, the stiffener should be separate for each sensor section; otherwise significantly more mechanical crosstalk can occur.

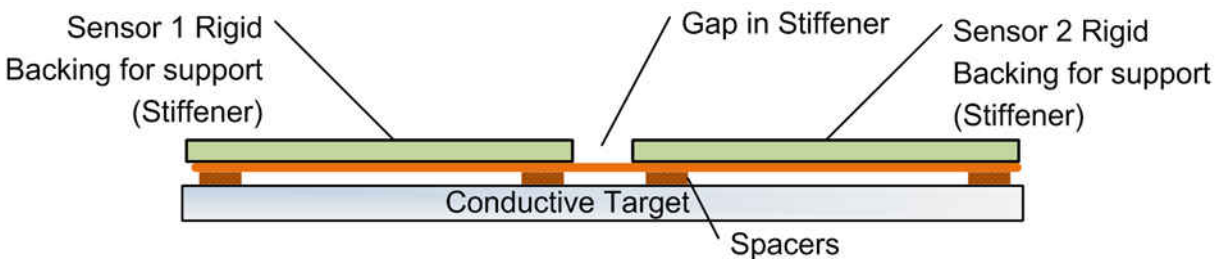

Figure 2-12. Separate Stiffener for Each Sensor

For some applications, the stiffener can be a component already present in the system—for example, a glass surface, or with sensors manufactured on a rigid material such as FR4.

Normal PCBs made of FR4 or other rigid materials do not require a dedicated stiffener.

2.4.9 Racetrack Inductor Shape

For some inductive touch applications which require very small sensors, the inductance of a circular or square sensor is too low. An elongated shape, such as a rectangle or racetrack shape, as seen in [Figure 2-13](#), will have a larger amount of inductance. This shape is effective for side-buttons in mobile applications.

2.5 Example Sensor

For this example, a dual sensor design is presented. [Figure 2-13](#) shows the sensors are 2.85 mm × 8 mm in size with eight turns. The traces are 0.25 oz-cu (9 μm) thick, are 75 μm wide and have a spacing of 50 μm. The sensor free-space inductance is approximately 1.3 μH, and has a 47-pF sensor capacitor. When mounted, the sensor inductance decreases due to interaction with the conductive target.

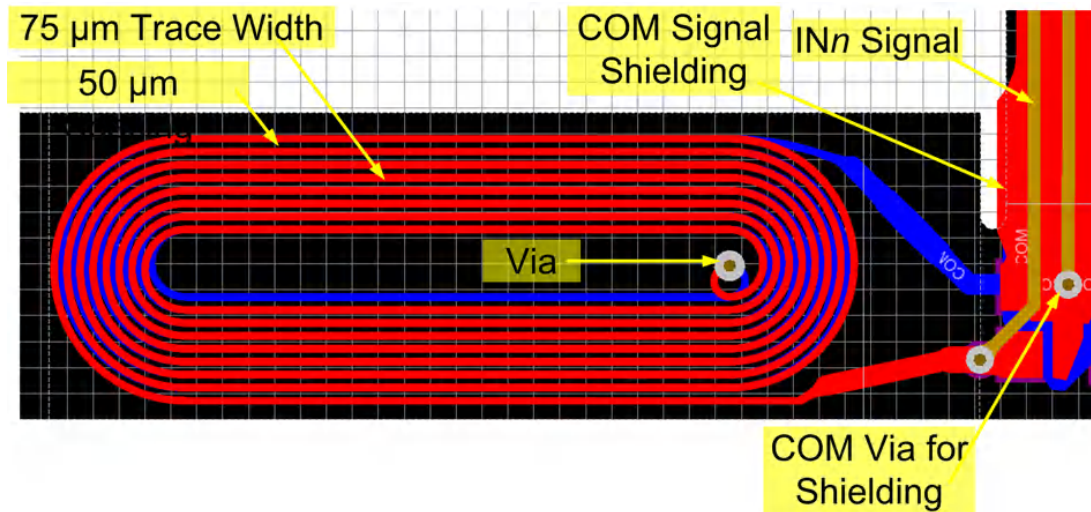

Figure 2-13. Sensor Racetrack Routing

The parameters of this sensor were estimated using the Racetrack Inductor Designer tab on the [LDC Calculations Tool](#). [Figure 2-14](#) is an example of the tool entries used to design the sensor described here. Note that the tool provides estimates of the sensor parameters such as R_S , R_P , Q , L , and frequency, based on [Equation 1](#), [Equation 2](#), and [Equation 3](#).

TI LDC Inductance Calculator

Estimator tool for racetrack spiral coils. This tool is provided without warranty or support. User assumes all liability.

[Return to Main page](#)

Ver N



Layer Stackup

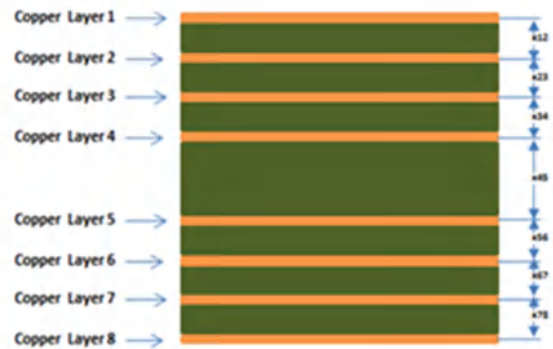

Enter only in Yellow Fields (pull-down for mm or mil)
Results in Orange Fields

LC Sensor calculations			
Operating temperature	T	25 °C	Enter operating temperature
Sensor capacitance	C	47.0 pF	Select LC tank capacitance
Layers	M	2 Layers	Number of layers on PCB board (1≤M≤8)
Turns	N	8 Turns	Number of turns per layer
Outer diameter of the inductor (short side)	d _{OUT}	2.85 mm	Outer Diameter of the spiral inductor
ratio of long edge to short edge (>=1)		2.80	racetrack design if >1
Long side of inductor	d _L	7.980 mm	
spacing between traces	S	2.000 mil	Space between traces (mm or mil)
width of trace	w	3.000 mil	Width of the trace (mm or mil)
PCB thickness between 1st layer and 2nd layer	h12	1.000 mil	Space between layer 1 and 2 (mm or mil)
Copper thickness	t	0.250 oz-Cu	Copper layer thickness (mm, Oz-Cu, or mil)
Coil Fill Ratio	d _{in} /d _{out}	0.28	0.2 > 0.8 is recommended
Inductor inner diameter	d _{in}	31.205 mil	Inner diameter of the spiral inductor (mm or mil)
Self inductance per layer	L	0.370 μH	
Total Inductance	L _{TOTAL}	1.316 μH	
Sensor Operating Frequency	F _{res}	19.426 MHz	
Resonance impedance estimate	R _p	7297.3 Ω	
Q factor	Q	41.86	
Target Distance	D	0.10 mm	
Sensor Inductance from Target Interaction	L'	0.756 μH	
Sensor Frequency with Target Interaction	F _{res} '	26.692 MHz	
R_p with Target Interaction	R _p '	1.40 kΩ	For aluminum target of at least 5 skin depths
Q Factor with target	Q'	11.0	

Figure 2-14. Racetrack Inductor Design Tab of the LDC Calculations Tool

The tool output includes estimates for both free space parameters (no target present) and their values when the sensor is mounted in the system with a target close by. As seen in Table 2-2, the sensor parameters are within the LDC211x/LDC3114 operating space when the sensor is mounted.

Table 2-2. Sensor Parameters

SENSOR PARAMETERS	SENSOR IN FREE SPACE	SENSOR MOUNTED	LDC211x/LDC3114 OPERATING SPACE
Sensor Inductance	1.3 μH	0.76 μH	
Sensor Capacitance	47 pF	47 pF	
Sensor Frequency	19.4 MHz	26.7 MHz	1 MHz – 30 MHz (LDC211x) 5 MHz – 30 MHz (LDC3114)
Sensor R _p	7.3 kΩ	1.4 kΩ	350 Ω ≤ R _p ≤ 10 kΩ
Sensor Q	41	11	5 ≤ Q ≤ 30

The routing between the sensor and the connector is shielded by the top and bottom layers, which are driven by the COM signal. Regularly spaced vias are used to tie the top and bottom shields.

The bend in the shielded routing is used for strain relief.

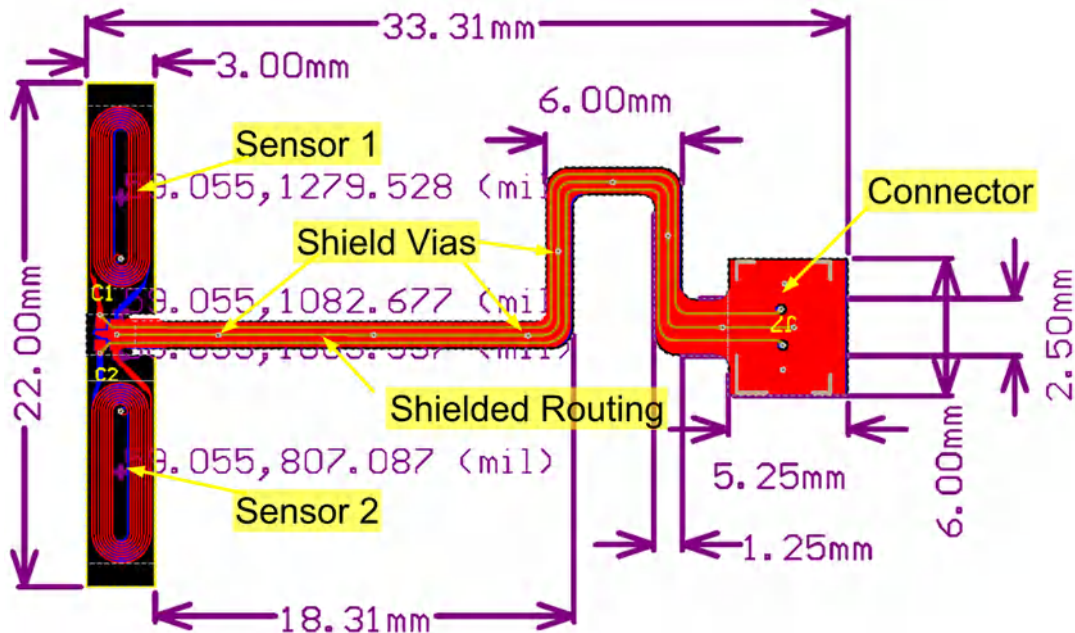

Figure 2-15. Example Dual Sensor Design

The stiffeners and spacers are integrated into the sensors for this example. Figure 2-16 shows the arrangement of the spacer and stiffeners.

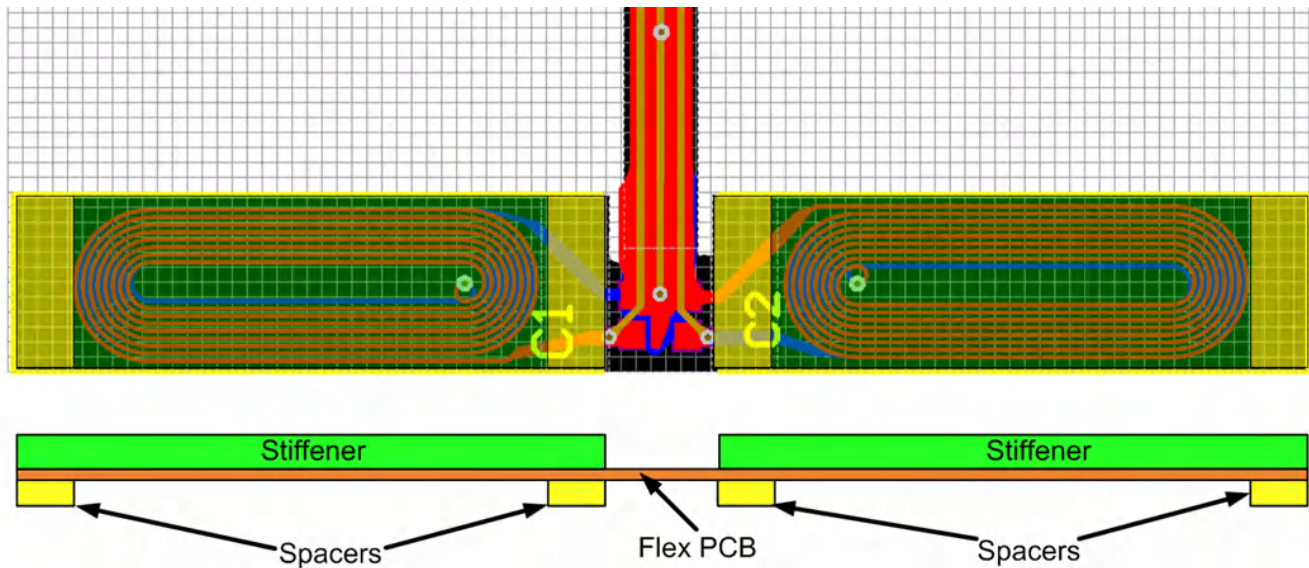

Figure 2-16. Sensor Region Construction

Each sensor region has a dedicated stiffener and two spacers. The flex sensor region between the two sensors provides mechanical isolation between the two sensors.

Table 2-3 shows the sensor stack. The thickness of the stiffener can be varied based on mechanical considerations. In general, incorporating the spacer into the sensor manufacturing can usually provide a tighter tolerance for the spacer thickness than machining the spacer on the case.

Table 2-3. Sensor Stack

LAYER	TYPE	MATERIAL	THICKNESS (mil)	THICKNESS (mm)	DIELECTRIC MATERIAL
Stiffener	Dielectric	Core	32	0.813	FR4
Top Overlay	Overlay				
Flex Top Coverlay	Solder Mask/Coverlay	Surface Material	0.4	0.010	Coverlay
Top Layer	Signal	Copper	0.46	0.012	
Flex1	Dielectric	Film	0.47	0.012	Polyimide
Signal Layer	Signal	Copper	0.46	0.012	
Flex2	Dielectric	Film	1	0.025	Polyimide
Bottom Layer	Signal	Copper	0.46	0.012	
Flex Bottom Coverlay	Solder Mask/Coverlay	Surface Material	0.4	0.010	Coverlay (PI)
Bottom Solder 1	Solder Mask/Coverlay	Surface Material	0.4	0.010	Solder Resist
Bottom Overlay	Overlay				
Spacer	Dielectric	Film	5	0.127	Polyimide
Total Thickness			41.05	1.043	

The spacer and stiffener are only present for a portion of the sensor design, as shown in Figure 2-17. The spacer is only required on the ends of the button locations. The stiffener is required over the sensor and any connectors. The stiffener can be manufactured with a thinner material, if needed for a specific application.

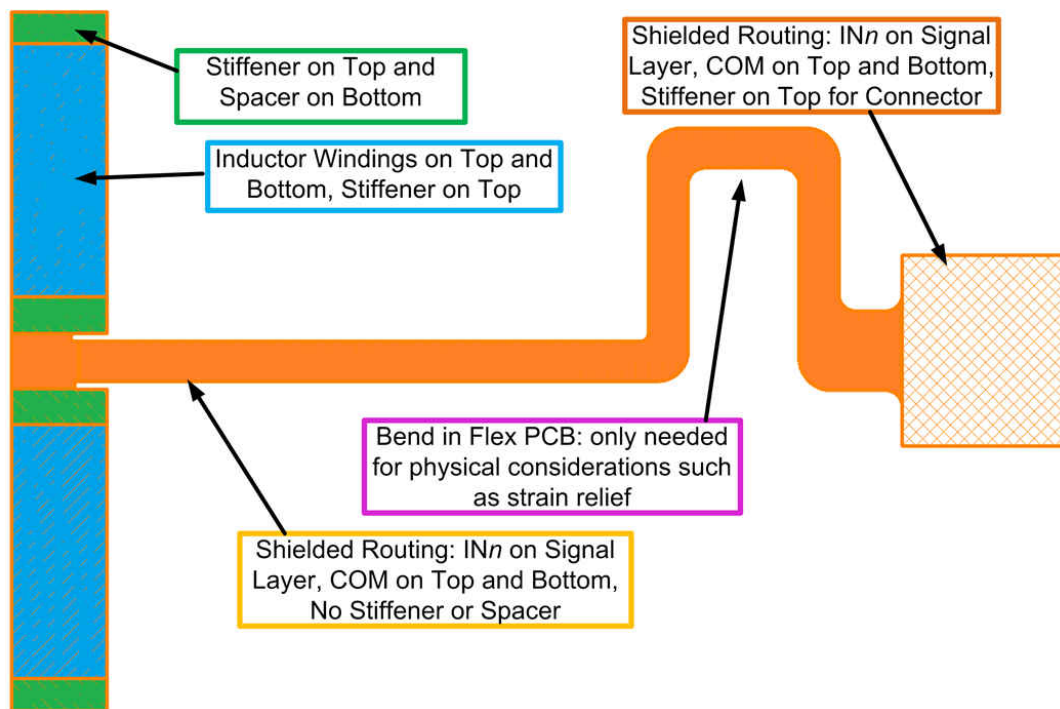

Figure 2-17. Sensor Stack Across Regions

3 Summary

In this design guide, we reviewed the mechanical considerations of inductive touch button design using inductive sensing technologies for optimal sensitivity and reliability, including the mechanical stack and basic process flow for electrical design. The process for designing a sensor suitable for LDC211x/LDC3114 inductive touch applications can be viewed as:

1. Determine the available physical size of the sensor
2. Use the design tools to design a sensor that is within the LDC211x/LDC3114 operating space
3. Use the shielded structure to route the IN n traces
4. Construct any spacers or stiffeners that are needed.

The low power architecture of the LDC211x/LDC3114 makes the device suitable for driving button sensors. The mechanical case does not require any cutouts at the button locations. This can support reduced manufacturing cost and enhance the case's resistance to moisture, dust, and dirt. This is a great advantage compared to traditional mechanical buttons in the market today.

4 Revision History

NOTE: Page numbers for previous revisions may differ from page numbers in the current version.

Changes from Revision * (February 2017) to Revision A (February 2023)	Page
• Added LDC3114 and LDC3114-Q1 information to the document.....	10
• Changed the sensor frequency parameters in Table 2-2	20

IMPORTANT NOTICE AND DISCLAIMER

TI PROVIDES TECHNICAL AND RELIABILITY DATA (INCLUDING DATA SHEETS), DESIGN RESOURCES (INCLUDING REFERENCE DESIGNS), APPLICATION OR OTHER DESIGN ADVICE, WEB TOOLS, SAFETY INFORMATION, AND OTHER RESOURCES "AS IS" AND WITH ALL FAULTS, AND DISCLAIMS ALL WARRANTIES, EXPRESS AND IMPLIED, INCLUDING WITHOUT LIMITATION ANY IMPLIED WARRANTIES OF MERCHANTABILITY, FITNESS FOR A PARTICULAR PURPOSE OR NON-INFRINGEMENT OF THIRD PARTY INTELLECTUAL PROPERTY RIGHTS.

These resources are intended for skilled developers designing with TI products. You are solely responsible for (1) selecting the appropriate TI products for your application, (2) designing, validating and testing your application, and (3) ensuring your application meets applicable standards, and any other safety, security, regulatory or other requirements.

These resources are subject to change without notice. TI grants you permission to use these resources only for development of an application that uses the TI products described in the resource. Other reproduction and display of these resources is prohibited. No license is granted to any other TI intellectual property right or to any third party intellectual property right. TI disclaims responsibility for, and you will fully indemnify TI and its representatives against, any claims, damages, costs, losses, and liabilities arising out of your use of these resources.

TI's products are provided subject to [TI's Terms of Sale](#) or other applicable terms available either on [ti.com](https://www.ti.com) or provided in conjunction with such TI products. TI's provision of these resources does not expand or otherwise alter TI's applicable warranties or warranty disclaimers for TI products.

TI objects to and rejects any additional or different terms you may have proposed.

Mailing Address: Texas Instruments, Post Office Box 655303, Dallas, Texas 75265
Copyright © 2023, Texas Instruments Incorporated