

AN–1368 LM5115/5025A Evaluation Board

1 Introduction

The LM5115/LM5025A evaluation board provides the design engineer with a secondary side post regulated (SSPR) output from an existing Active Clamp Forward topology. Information on the LM5025A active clamp evaluation board can be found in *AN-1345 LM5025A Evaluation Board User's Guide* ([SNVA097](#)). Note that other types of isolated power converters (for example, push-pull, half-bridge, and full-bridge) can be used in the place of the LM5025A active clamp forward converter to drive the LM5115 AC evaluation board.

The evaluation board specifications are:

- Input voltage: 36V to 72V, 48V nominal on LM5025A
- Output voltage Main: 3.3V nominal
- Output current Main: 0 to 30A
- Current limit Main: $\approx 30A$
- Output voltage Secondary: 2V
- Output current Secondary: 0 to 9A
- Current limit Secondary: $\approx 9A$
- Measured efficiency on secondary only: 98% at 36V, $I_{load} = 1A$, 93% at 48V, $I_{load} = 4A$
- Load regulation: 2mV change from 1A-7A, $36V < V_{in} < 72V$
- Size: 2.0 x 1.125 x 0.375 inches

The printed circuit board consists of 4 layers of 2 oz copper on FR4 material, with a thickness of 0.050 in. It is designed for continuous operation at rated load with a minimum airflow of 200 LFPM.

2 Theory of Operation

The LM5115 controller contains all of the features necessary to implement multiple output power converters utilizing the Secondary Side Post Regulation (SSPR) technique. The SSPR technique develops a highly efficient and well regulated auxiliary output from the secondary side switching waveform of an isolated power converter.

Synchronization of the LM5115 comes from the main pulsed signal of the transformer secondary winding. Resistor R2 and R4 sense the pulsing signal to form an internal synchronization signal and an internal current to charge the RAMP of the LM5115. The LM5115 controls the buck power stage with leading edge pulse width modulation (PWM) to hold off the high side driver until the necessary volt*seconds is established for regulation. Representative waveforms are shown in [Section 10](#).

Bias to the part comes from a rectified pulse signal. Note that the pulse signals vary from 6Vpp to 12Vpp, with V_{in} varying from 36V to 72V, respectively. Therefore, the V_{CC} regulator will not regulate at 7V until the peak to peak voltage is slightly higher than 7.5V (accounting for the diode drop to the bias). The intention was to show that with non-regulation on V_{CC} the LM5115 is still capable of providing the secondary voltage of 2V from the main 3.3V. Adaptive deadtime control delays the top and bottom drivers to avoid shoot through currents ([Figure 7](#) and [Figure 8](#)).

3 Board Layout and Probing

Figure 1, Figure 2, and Figure 3 show the board layout, main components, and critical probe points for testing the LM5115 AC mode evaluation board in conjunction with the LM5025A board. The following notes should be considered prior to applying power to the board:

1. Main input power (36V to 72V) is applied to points J1 and J4 of the LM5025A board, connected to VIN and GND, respectively.
2. The main current carrying components (LM5115 board: L1, Q1, and Q2; LM5025A board L2, Q3-Q6) will be hot to the touch at maximum load current. USE CAUTION. When operating at load currents in excess of 5A, the use of a fan to provide forced air flow is necessary.
3. The diameter and length of the wire used to connect the load is important. To ensure that there is not a significant voltage drop in the wires, a minimum of 14 gauge wire is recommended.

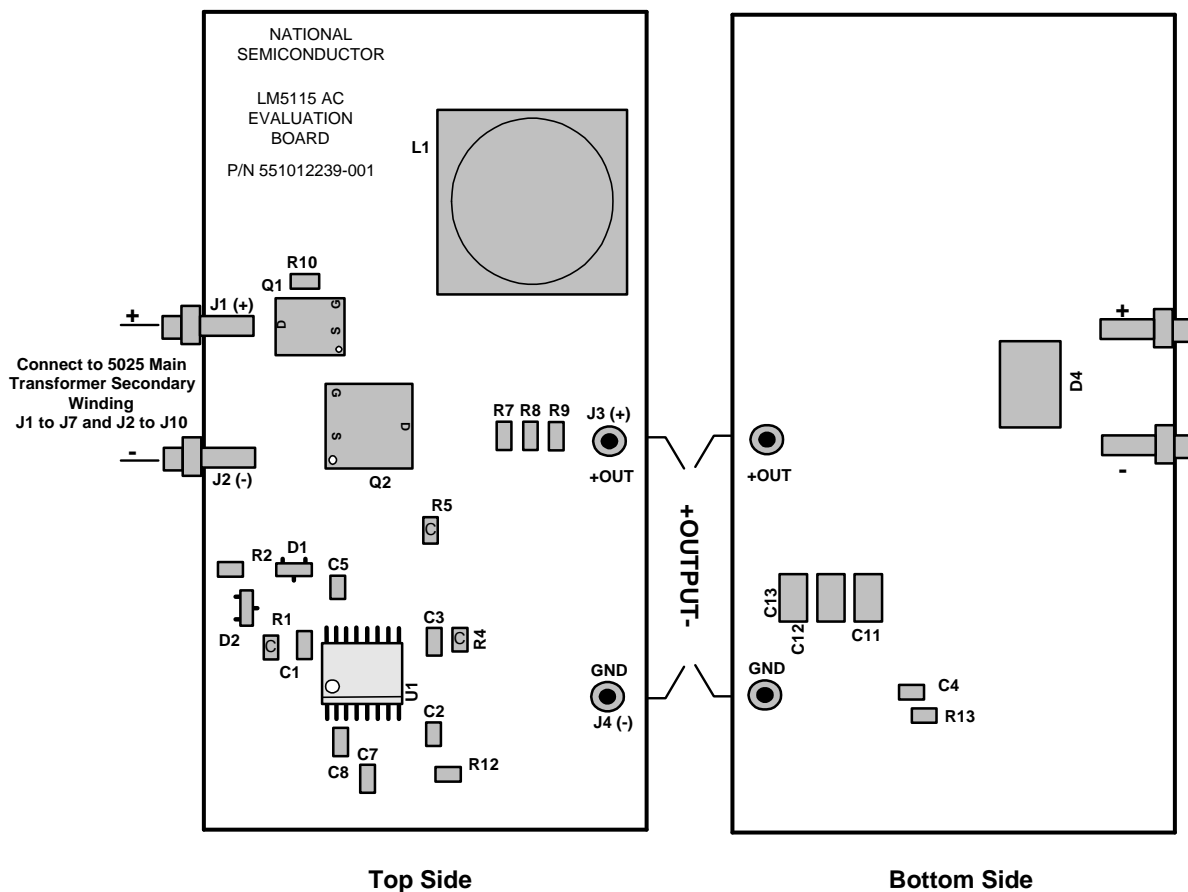

Figure 1. LM5115 Evaluation Board

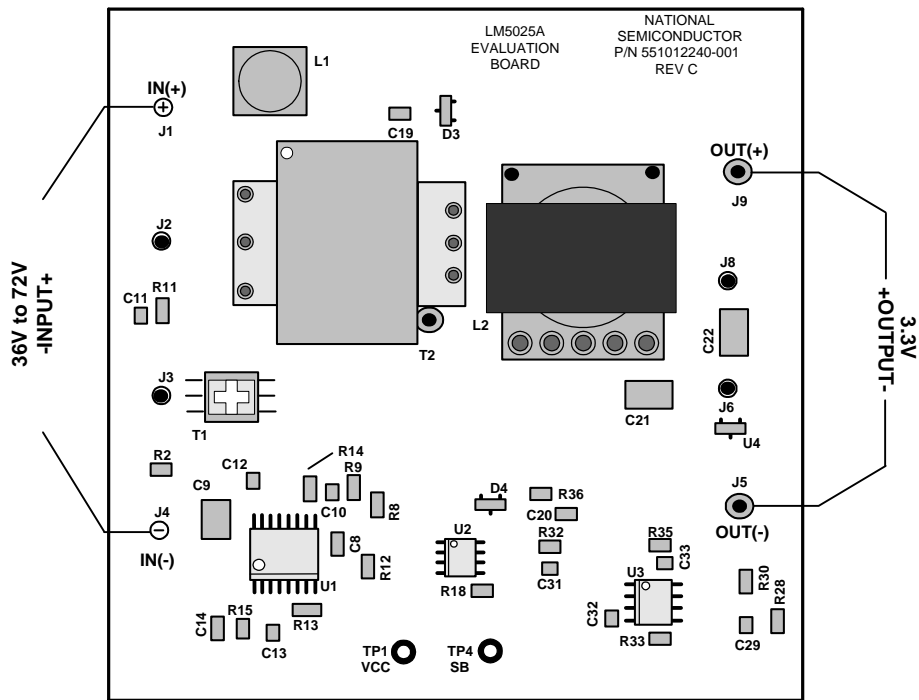

Figure 2. LM5025A Evaluation Board Top Side

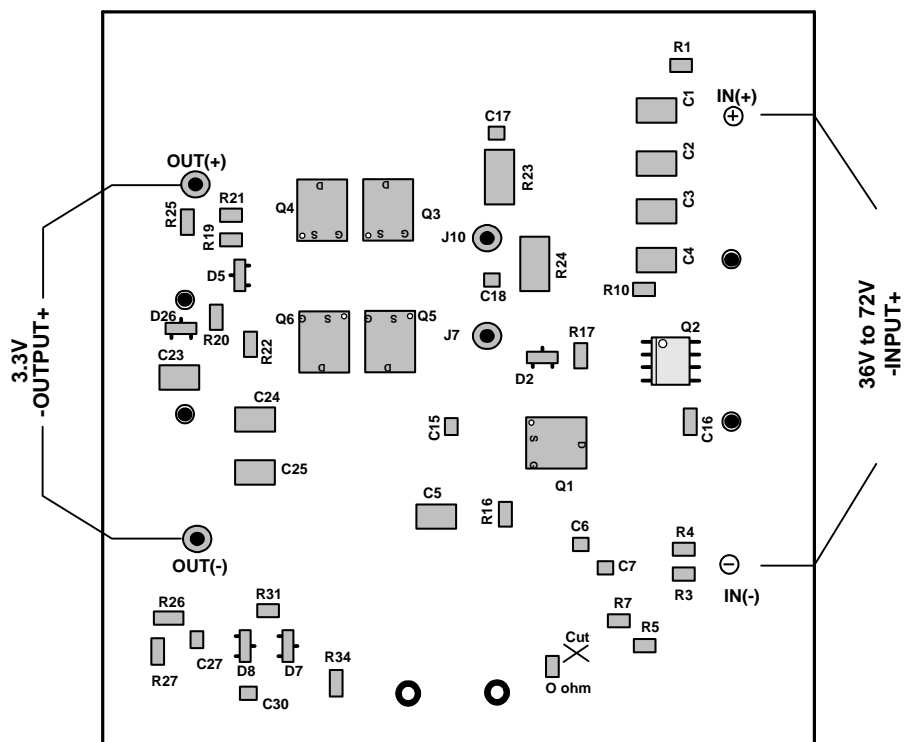

Figure 3. LM5025A Evaluation Board Bottom Side

4 Board Connections/Start-Up

The input power connections are made to terminals J1 (+) and J4 (-) of the LM5025A evaluation board. The input source must be capable of supplying the load on both the output of the LM5025A board and LM5115 board. The input to the LM5115 is supplied by the secondary winding of the LM5025A board. J7 (LM5025A) connects to J1 (LM5115) and J10 (LM5025A) connects to J2 (LM5115) (see [Figure 1](#), [Figure 2](#), and [Figure 3](#)). The main load is connected to terminals J9 (+) and J5 (-) for the LM5025. Terminals J3 (+) and J4 (-) are the load connections for the LM5115. Before start-up, a voltmeter should be connected to the input terminals and to the output terminals. The input current should be monitored with an ammeter or a current probe. Soft-start provided by the LM5115 will insure that the output rises with a smooth turn on without overshoot ([Figure 12](#)). The LM5115 evaluation board will operate in the continuous conduction mode even with a light or no load ([Figure 4](#)).

5 Performance LM5115 Secondary Side Post Regulator

Performance of the LM5115 evaluation board can be seen in the following figures:

1. Power Conversion Efficiency ([Figure 5](#) and [Figure 6](#))
2. Gate Delays ([Figure 7](#) and [Figure 8](#))
3. Short circuit response ([Figure 9](#))
4. Step Load Response ([Figure 10](#) and [Figure 11](#))
5. Startup and Shutdown Response ([Figure 12](#) and [Figure 13](#))
6. Ripple Voltage ([Figure 14](#))
7. Load Regulation ([Figure 15](#))
8. Secondary Closed Loop Frequency Response ([Figure 16](#))

6 V_{CC}

The LM5115 produces a LDO 7V regulated output (V_{CC}) that can supply up to 40mA of DC current. The V_{CC} regulator supplies power for the high current gate drive for the low side MOSFET and the bootstrap capacitor of the high side MOSFET driver.

7 Current Limit Operation

Inductor current is sensed through the parallel resistances of R7, R8, and R9. The resistor values are designed for a current limit of ~9A. Current limiting occurs when the delta voltage across the sense resistor exceeds 45mV causing the current sense amplifier to pull down the combined CO and COMP pins. Pulling COMP low reduces the width of pulses to the high side driver, limiting the output current of the converter. After reaching the current limit, the voltage feedback causes the COMP pin to rise and turn on the high side driver until the inductor current again reaches the ~9A current limit threshold. ([Figure 9](#)).

The parallel resistance also serves to inject the inductor current into the LM5115 feedback loop. Injecting a signal proportional to the instantaneous inductor current into a voltage mode controller improves the control loop stability and bandwidth. Current injection, which is a form of average current mode control, eliminates the lead R-C network in the feedback path that is normally required with voltage mode control. This not only simplifies the compensation but also reduces sensitivity to output noise that could pass through the lead network to the error amplifier.

In cases where a noisy current sense is present, adding a low pass filter to the input of CS and VOUT can help restore a cleaner waveform ([Figure 24](#), R16 and C10). Care must be taken not to have a large RC time constant to avoid instability.

8 Foldback Current Limit

Current limit foldback can be implemented with the following components: R17, R18, C10, D5, and R16 (see [Figure 24](#)). At nominal output voltage ($V_{OUT} > 3V$) D5 is reversed biased and the current limit threshold is still $\sim 45mV$. At lower output voltage the resistor divider network along with the forward biased diode (D5) will increase the voltage across R16. In order to reach the $45mV$ current limit threshold, the voltage across the sense resistor (R7-R9) is reduced due to the increase in voltage across R16. Thus, the current limit is reduced providing current limit foldback. The resistor divider sets the voltage when current limit foldback kicks in and R16 sets the amount of current limit foldback.

A most common occurrence, that will prove unnerving, is when the current limit set on the source supply is insufficient for the load. The result is similar to having the high source impedance referred to earlier. The interaction of the source supply folding back and the UUT going into undervoltage shutdown will start an oscillation, or chatter, that may have highly undesirable consequences.

9 Optional DC Buck

LM5115 can also be configured as a DC buck regulator. Information for the DC board can be found in *LM5115 Secondary Side Post Regulator/Synchronous Buck Controller* ([SNVS343](#)).

10 Typical Performance Characteristics

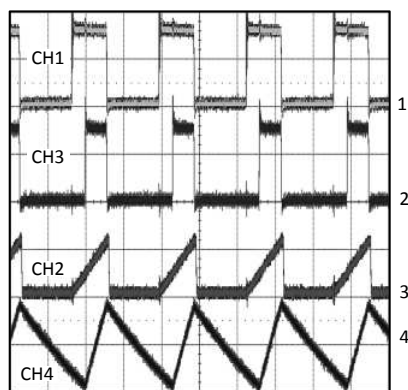

$V_{IN} = 48V$, Secondary output load = open
 CH1 = Main Phase Signal (5V/Div).
 CH2 = RAMP (1V/Div).
 CH3 = Secondary Switch Signal (5V/Div).
 CH4 = Inductor Current Secondary (2A/Div).
 Horizontal Resolution = $2 \mu s/Div$.

Figure 4. Representative Waveform

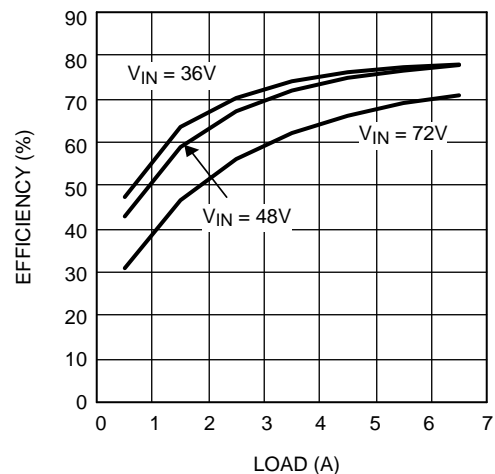

Figure 5. System Efficiency vs. Load Current and V_{IN}

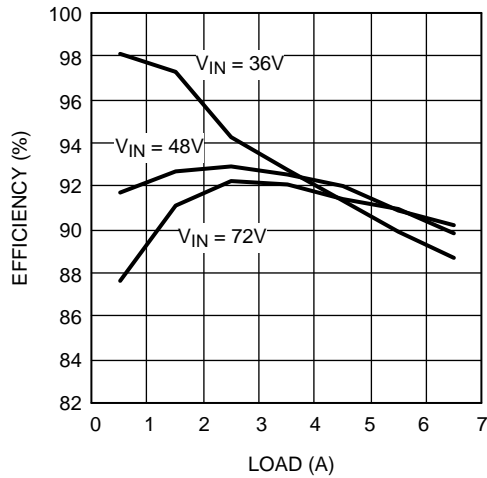
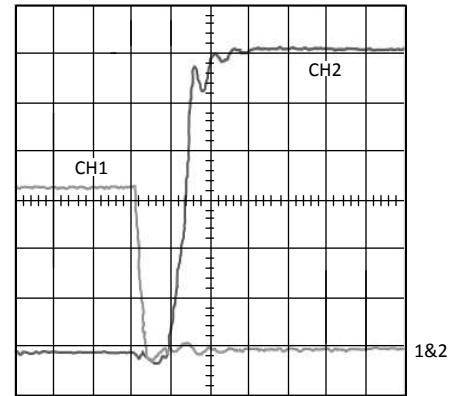
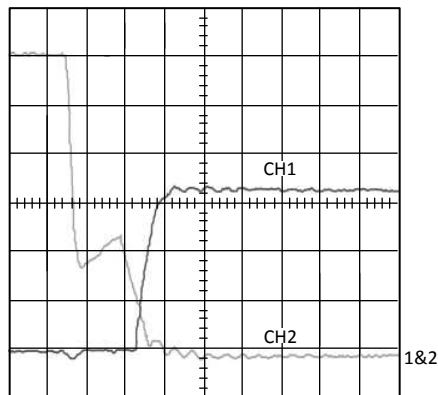

Figure 6. Adjusted Efficiency on Secondary Side vs. Load Current and V_{IN}



$V_{IN} = 48V$; LM5115 Load = 5.0A
 CH1 = Lo Side Sw Gate Drive, 2V/Div.
 CH2 = Hi Side Sw Gate Drive, 2V/Div.
 Horizontal Resolution = 100 ns/Div.

Figure 7. Gate Turn-on Delay



$V_{IN} = 48V$; LM5115 Load = 5.0A
 CH1 = Lo Side Sw Gate Drive, 2V/Div.
 CH2 = Hi Side Sw Gate Drive, 2V/Div.
 Horizontal Resolution = 100 ns/Div.

Figure 8. Gate Turn-off Delay

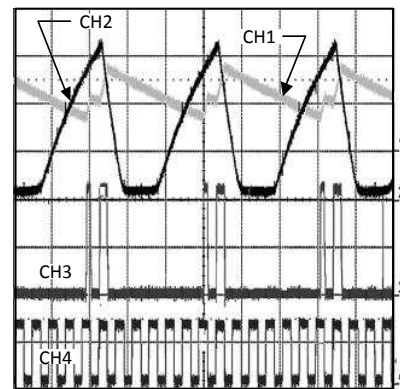

$V_{IN} = 48V$
 CH1 = Inductor Current, 5A/Div.
 CH2 = COMP/CO, 1V/Div.
 CH3 = High Side Switch Gate Drive, 5V/Div.
 CH4 = Phase Signal, 5V/Div.
 Horizontal Resolution = 10 μ s/Div.

Figure 9. Secondary Output Short Response

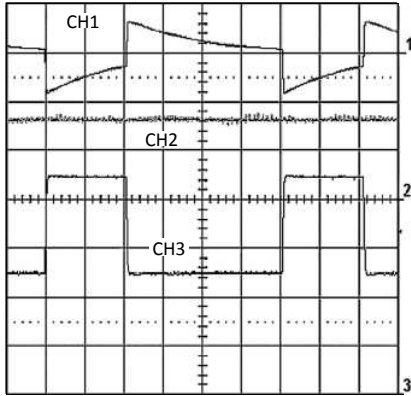

V_{IN} = 48V
 CH1 = Secondary 2.0V Output, 100 mV/Div. (AC Mode).
 CH2 = Main 3.3V Output, 2V/Div.
 CH3 = Secondary Current Load (5A to 9A), 2A/Div.
 Horizontal Resolution = 500 μ s/Div.

Figure 10. Secondary Step Load Response

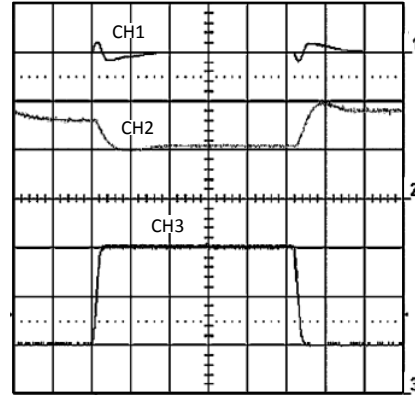

V_{IN} = 48V
 CH1 = Secondary 2.0V Output, 100 mV/Div. AC.
 CH2 = Main 3.3V Output, 2V/Div.
 CH3 = Main Current Load (10A to 30A), 10A/Div.
 Horizontal Resolution = 200 μ s/Div.

Figure 11. Cross Regulation Step Load

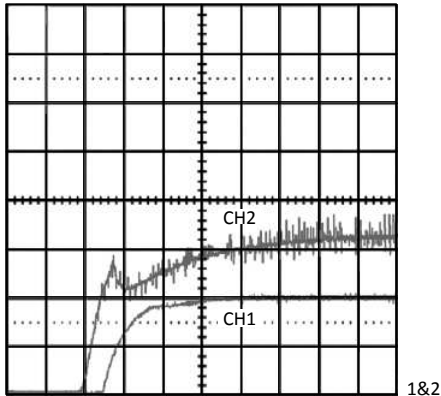

V_{IN} = 48V; LM5115 Load = 5.0A, LM5025 Load = Open
 CH1 = Secondary 2V Output, 1V/Div.
 CH2 = Main 3.3V Output, 1V/Div.
 Horizontal Resolution = 1 ms/Div.

Figure 12. Startup Response

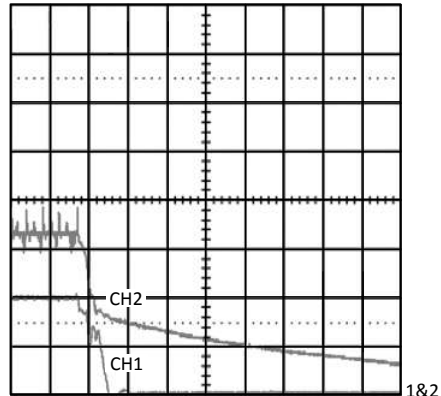

V_{IN} = 48V; LM5115 Load = 5.0A, LM5025 Load = Open
 CH1 = Secondary 2V Output, 1V/Div.
 CH2 = Main 3.3V Output, 1V/Div.
 Horizontal Resolution = 200 μ s/Div.

Figure 13. Shutdown Response

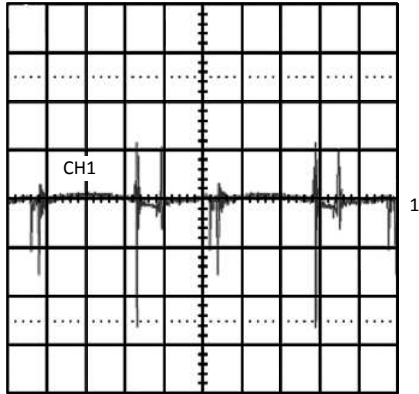

V_{IN} = 48V; LM5115 Load = 8.0A
 CH1 = Secondary 2V Output, 50 mV/Div. (AC Mode).
 Horizontal Resolution = 1 μs/Div.

Figure 14. Secondary Ripple Voltage

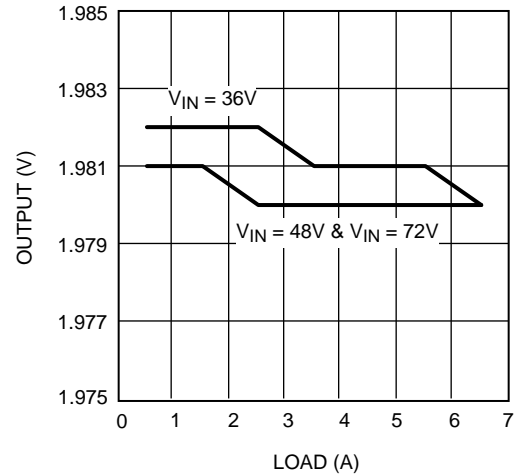

Figure 15. Output vs. Load Current and V_{IN}

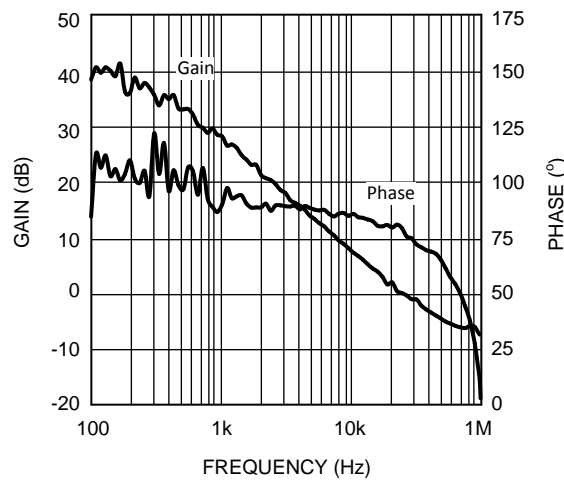

Figure 16. Secondary Closed Loop Response

11 Bill of Materials

Table 1. Bill of Materials

Item		Part Number	Description	Value
C	1	C3216X7R1E105K	CAPACITOR, CER, TDK	1.0 μ F, 25V
C	2	C2012X7R1H104K	CAPACITOR, CER, TDK	0.1 μ F, 50V
C	3	C3216X7R1E105K	CAPACITOR, CER, TDK	1.0 μ F, 25V
C	4	C2012COG1H331K	CAPACITOR, CER, TDK	330 pF, 50V
C	5	C2012X7R1H104K	CAPACITOR, CER, TDK	0.1 μ F, 50V
C	6			Not Used
C	7	C2012COG1H223K	CAPACITOR, CER, TDK	0.022 μ F, 50V
C	8	C2012COG1H471K	CAPACITOR, CER, TDK	470 pF, 50V
C	9			Not Used
C	10			Not Used
C	11	C4532X7SOG686M	CAPACITOR, CER, TDK	68 μ F, 4.0V
C	12	C4532X7SOG686M	CAPACITOR, CER, TDK	68 μ F, 4.0V
C	13	C4532X7SOG686M	CAPACITOR, CER, TDK	68 μ F, 4.0V
D	1	CMPD2838E-NSA	DIODE, SIGNAL, CENTRAL, SEMI	
D	2	CMPD2838E-NSA	DIODE, SIGNAL, CENTRAL, SEMI	
D	3			Not Used
D	4	CMSH3-40L-NSA	DIODE SHOTTKY, CENTRAL, SEMI	CMSH3-40L
D	5			Not Used
J	1	2515-1-01-01-00-00-07-0	SOLDER TERMINAL SLOTTED, MILL-MAX	
J	2	2515-1-01-01-00-00-07-0	SOLDER TERMINAL SLOTTED, MILL-MAX	
J	3	5002	TERMINAL, SMALL TEST POINT, KEYSTONE	
J	4	5002	TERMINAL, SMALL TEST POINT, KEYSTONE	
R	1	CRCW080510R0J	RESISTOR, VISHAY	10
R	2	CRCW08051001F	RESISTOR, VISHAY	1.00 K
R	3	CRCW08054322F	RESISTOR, VISHAY	43.2 K
R	4	CRCW08051153F	RESISTOR, VISHAY	115 K
R	5	CRCW080510R0J	RESISTOR, VISHAY	10
R	6			Not Used
R	7	CRCW1206R012F	RESISTOR, VISHAY , Newark # 06HO462	0.012
R	8	CRCW1206R012F	RESISTOR, VISHAY , Newark # 06HO462	0.012
R	9	CRCW1206R012F	RESISTOR, VISHAY , Newark # 06HO462	0.012
R	10	CRCW080510R0J	RESISTOR, VISHAY	10
R	11			Not Used
R	12	CRCW08058251F	RESISTOR, VISHAY	8.25 K
R	13	CRCW08054991F	RESISTOR, VISHAY	4.99K
R	14			Not Used
R	15	CRCW08050000Z	RESISTOR, VISHAY	0 OHMS
R	16	CRCW08050000Z	RESISTOR, VISHAY	0 OHMS
R	17			Not Used
R	18			Not Used
Q	1	SI7892DP	MOSFET, N-CH, POWER S0-8 PKG, VISHAY	SI7892DP
Q	2	SUD70N02	MOSFET, N-CH, DPAK PKG, VISHAY	SUD70N02
L	1	DR356-2-272	INDUCTOR, COOPER, DR127-2R2	2.2 uH - 12A
U	1	LM5115	CONTROLLER, SINGLE OUT, PWM, TEXAS INSTRUMENTS	LM 5115

12 PCB Layout(s)

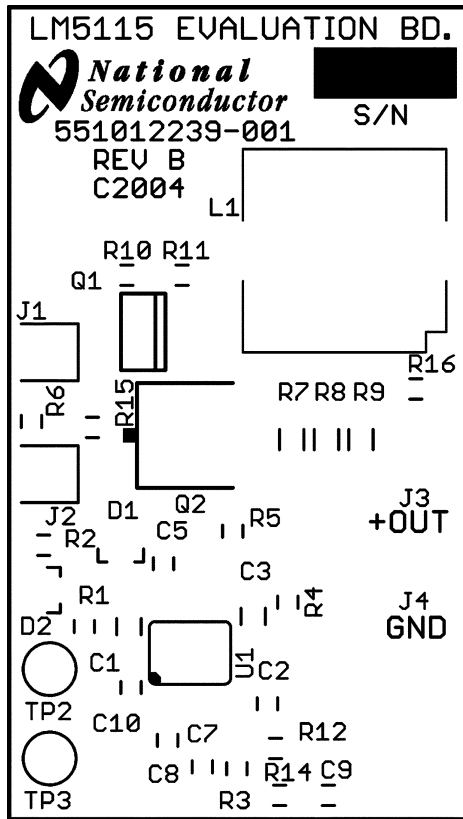

Figure 17. Top Silk Screen LM5115

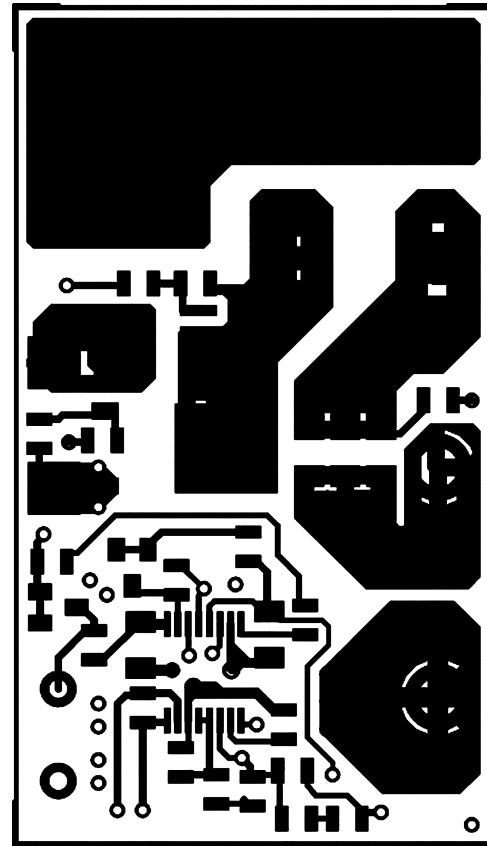

Figure 18. Top Layer LM5115

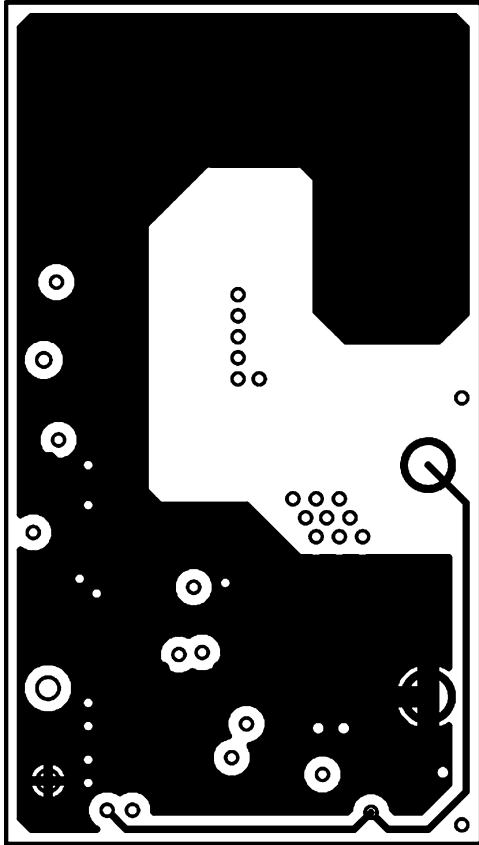

Figure 19. Layer 2 LM5115

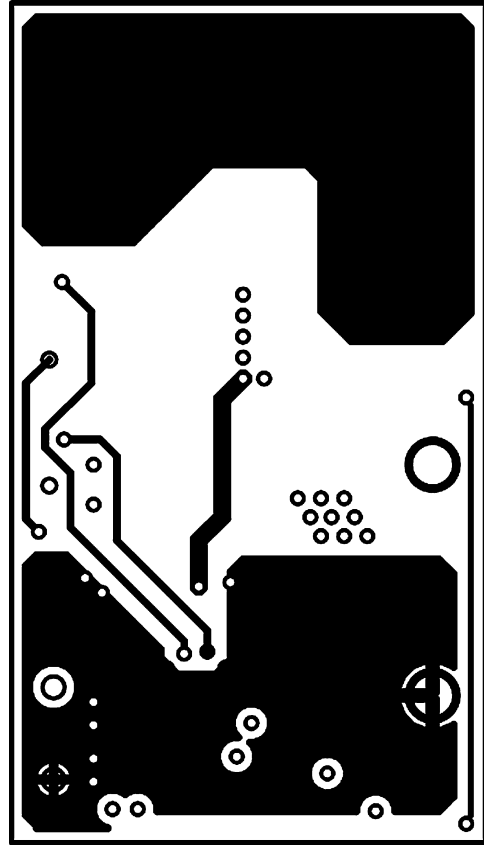

Figure 20. Layer 3 LM5115

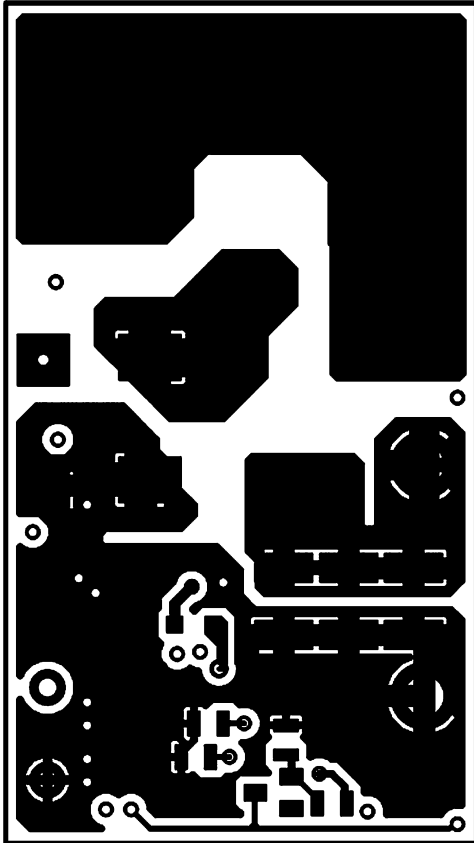

Figure 21. Bottom Layer LM5115,
as Viewed from Top

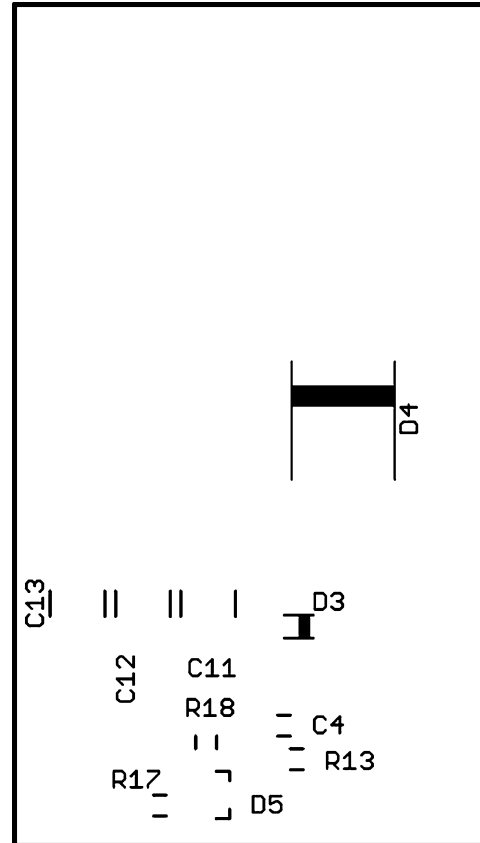

Figure 22. Bottom Silk Screen LM5115

13 Application Circuit Schematic

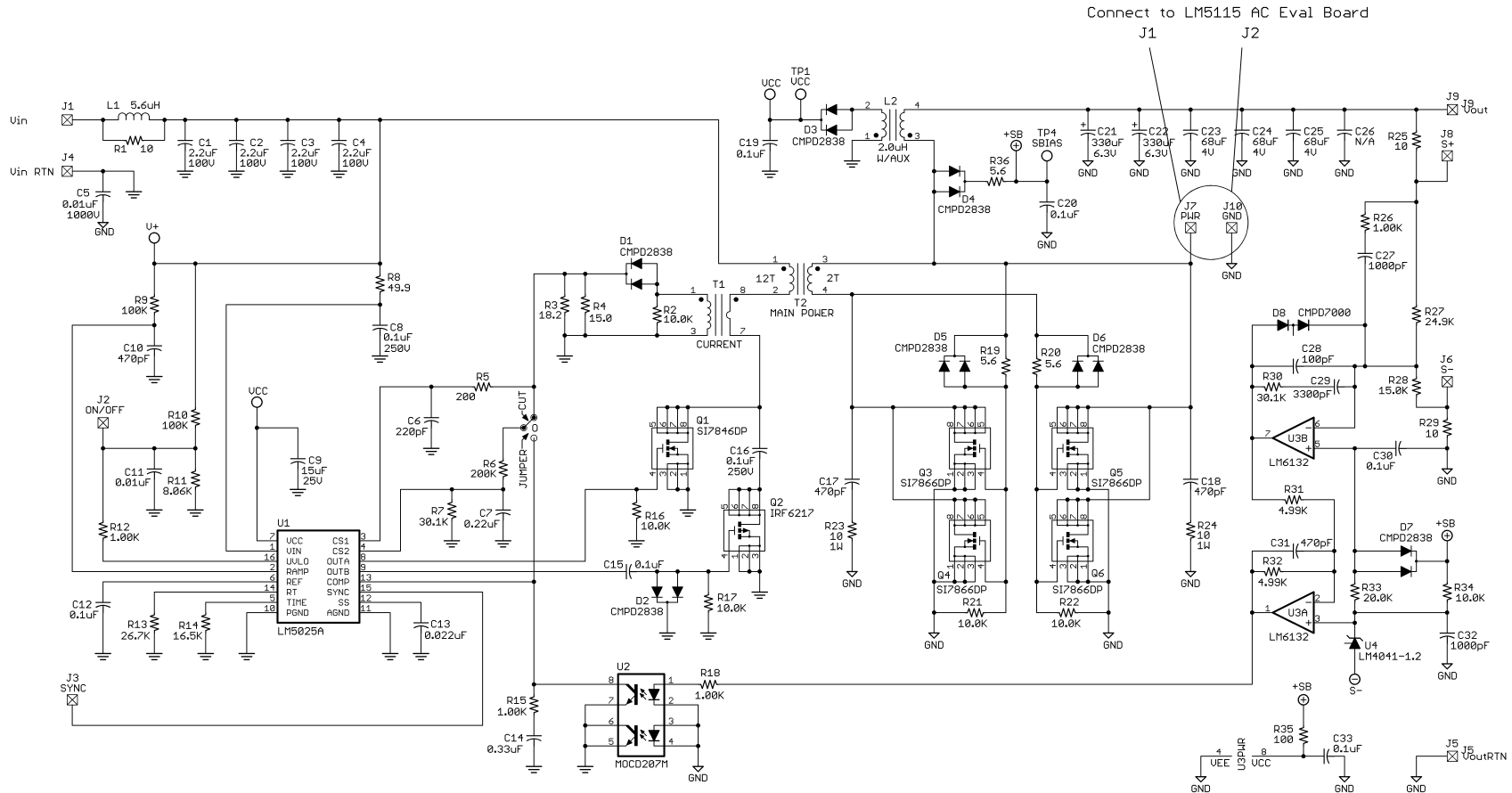

Figure 23. LM5025A Eval Board

IMPORTANT NOTICE

Texas Instruments Incorporated and its subsidiaries (TI) reserve the right to make corrections, enhancements, improvements and other changes to its semiconductor products and services per JESD46, latest issue, and to discontinue any product or service per JESD48, latest issue. Buyers should obtain the latest relevant information before placing orders and should verify that such information is current and complete. All semiconductor products (also referred to herein as "components") are sold subject to TI's terms and conditions of sale supplied at the time of order acknowledgment.

TI warrants performance of its components to the specifications applicable at the time of sale, in accordance with the warranty in TI's terms and conditions of sale of semiconductor products. Testing and other quality control techniques are used to the extent TI deems necessary to support this warranty. Except where mandated by applicable law, testing of all parameters of each component is not necessarily performed.

TI assumes no liability for applications assistance or the design of Buyers' products. Buyers are responsible for their products and applications using TI components. To minimize the risks associated with Buyers' products and applications, Buyers should provide adequate design and operating safeguards.

TI does not warrant or represent that any license, either express or implied, is granted under any patent right, copyright, mask work right, or other intellectual property right relating to any combination, machine, or process in which TI components or services are used. Information published by TI regarding third-party products or services does not constitute a license to use such products or services or a warranty or endorsement thereof. Use of such information may require a license from a third party under the patents or other intellectual property of the third party, or a license from TI under the patents or other intellectual property of TI.

Reproduction of significant portions of TI information in TI data books or data sheets is permissible only if reproduction is without alteration and is accompanied by all associated warranties, conditions, limitations, and notices. TI is not responsible or liable for such altered documentation. Information of third parties may be subject to additional restrictions.

Resale of TI components or services with statements different from or beyond the parameters stated by TI for that component or service voids all express and any implied warranties for the associated TI component or service and is an unfair and deceptive business practice. TI is not responsible or liable for any such statements.

Buyer acknowledges and agrees that it is solely responsible for compliance with all legal, regulatory and safety-related requirements concerning its products, and any use of TI components in its applications, notwithstanding any applications-related information or support that may be provided by TI. Buyer represents and agrees that it has all the necessary expertise to create and implement safeguards which anticipate dangerous consequences of failures, monitor failures and their consequences, lessen the likelihood of failures that might cause harm and take appropriate remedial actions. Buyer will fully indemnify TI and its representatives against any damages arising out of the use of any TI components in safety-critical applications.

In some cases, TI components may be promoted specifically to facilitate safety-related applications. With such components, TI's goal is to help enable customers to design and create their own end-product solutions that meet applicable functional safety standards and requirements. Nonetheless, such components are subject to these terms.

No TI components are authorized for use in FDA Class III (or similar life-critical medical equipment) unless authorized officers of the parties have executed a special agreement specifically governing such use.

Only those TI components which TI has specifically designated as military grade or "enhanced plastic" are designed and intended for use in military/aerospace applications or environments. Buyer acknowledges and agrees that any military or aerospace use of TI components which have **not** been so designated is solely at the Buyer's risk, and that Buyer is solely responsible for compliance with all legal and regulatory requirements in connection with such use.

TI has specifically designated certain components as meeting ISO/TS16949 requirements, mainly for automotive use. In any case of use of non-designated products, TI will not be responsible for any failure to meet ISO/TS16949.

Products

Audio	www.ti.com/audio
Amplifiers	amplifier.ti.com
Data Converters	dataconverter.ti.com
DLP® Products	www.dlp.com
DSP	dsp.ti.com
Clocks and Timers	www.ti.com/clocks
Interface	interface.ti.com
Logic	logic.ti.com
Power Mgmt	power.ti.com
Microcontrollers	microcontroller.ti.com
RFID	www.ti-rfid.com
OMAP Applications Processors	www.ti.com/omap
Wireless Connectivity	www.ti.com/wirelessconnectivity

Applications

Automotive and Transportation	www.ti.com/automotive
Communications and Telecom	www.ti.com/communications
Computers and Peripherals	www.ti.com/computers
Consumer Electronics	www.ti.com/consumer-apps
Energy and Lighting	www.ti.com/energy
Industrial	www.ti.com/industrial
Medical	www.ti.com/medical
Security	www.ti.com/security
Space, Avionics and Defense	www.ti.com/space-avionics-defense
Video and Imaging	www.ti.com/video

TI E2E Community

e2e.ti.com