

AN-2089 LMZ14203H/02H/01H Evaluation Board

1 Introduction

The LMZ14203H/02H/01H SIMPLE SWITCHER® power modules for high output voltage are easy-to-use DC-DC solutions capable of driving up to a 3A load with exceptional power conversion efficiency, output voltage accuracy, line and load regulation. They are available in an innovative package that enhances thermal performance and allows for hand or machine soldering.

The LMZ14203H/02H/01H Evaluation Board is configured for 12V output voltage from 15V to 42V input. The precision enable input allows for programmable UVLO of the input supply. The resistor voltage divider R_{ENT} and R_{ENB} set the input UVLO threshold. Connect the V_{IN} turret terminal to the EN turret on the board to enable operation.

The external soft-start capacitor C_{SS} facilitates controlled startup output rise time. The resistors R_{FBT} and R_{FBB} set the output voltage. An output feed-forward capacitor C_{FF} across the upper feedback resistor trims for optimum transient response. The control loop operates well with low ESR output capacitors such as ceramic and polymer electrolytic capacitors. The resistor R_{ON} sets the operating frequency. See datasheet for component selection details.

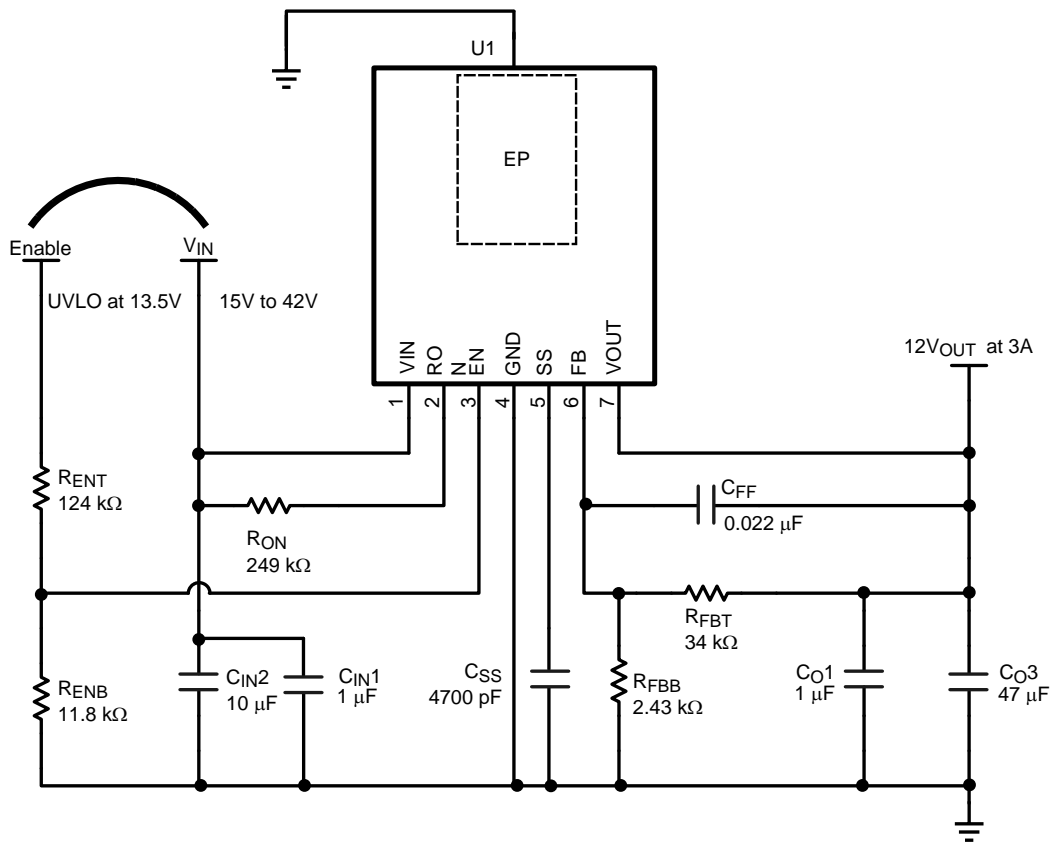
The LMZ14203H/02H/01H PCB layout offers excellent thermal performance, achieving junction-to-ambient thermal resistance θ_{JA} of 14.9°C/W. The evaluation board with its default Bill of Materials offers great EMI performance, complying with the EN 55022 Class B radiated emissions standard. The solution also complies with the CISPR22 conducted emissions standard with the addition of a small input filter.

2 Board Specifications

- $V_{IN} = 15V$ to 42V
- $V_{OUT} = 12V$
- 3A max load at 24 V_{IN} and 65°C T_{AMB}
- Low radiated EMI (EN 55022 Class B compliant)
- 400kHz switching frequency
- Enable UVLO set at 13.5V
- $\theta_{JA} = 14.9^{\circ}C/W$
- 4 copper layers
- 2 oz copper on top and bottom layer
- 1 oz copper on internal layers
- 6.985 cm x 7.620 cm (2.75 in x 3 in) with 1.575 cm (.062 in) thickness of FR4 laminate material

3 Additional Footprints

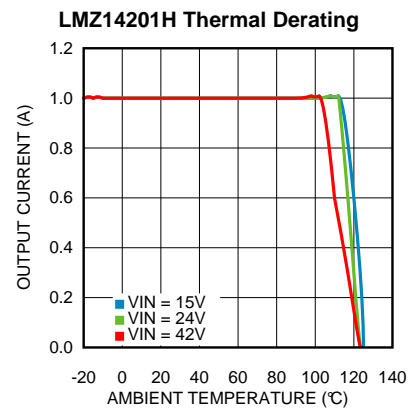
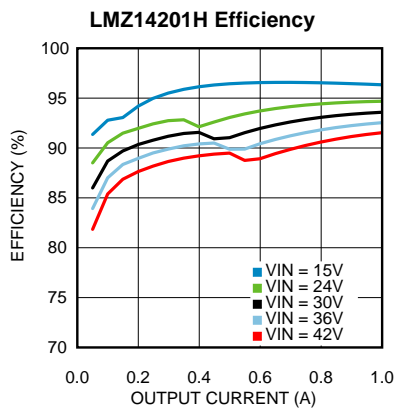
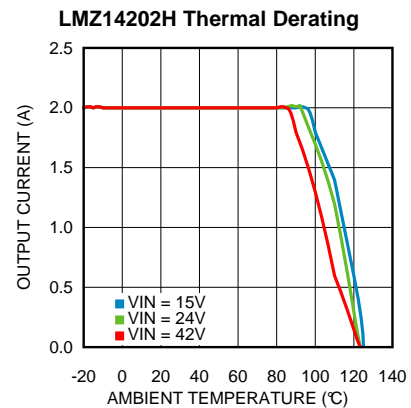
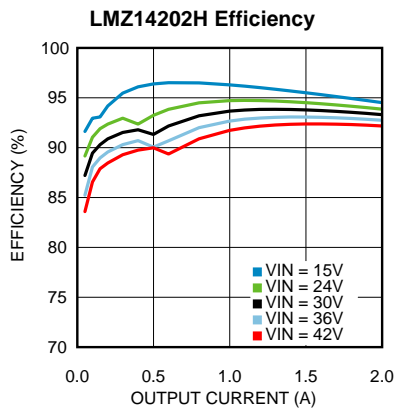
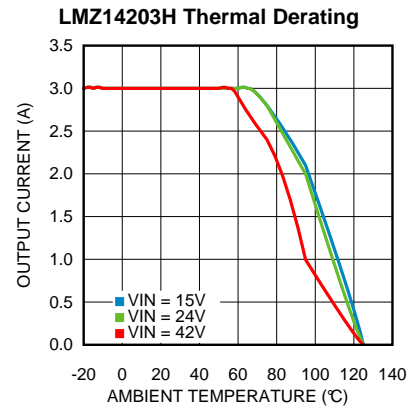
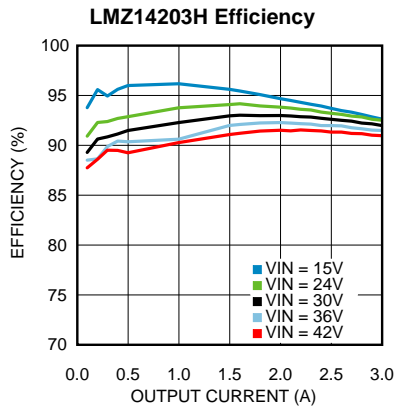
Additional component mounting pads are available to experiment with alternative input and output capacitor combinations or a zener clamp on the enable input. See [Figure 6](#) for corresponding schematic locations.


Figure 1. Evaluation Board Schematic
Table 1. LMZ1420xH Bill of Materials, $V_{IN} = 15V$ to $42V$, $V_{OUT} = 12V$, $I_{OUT (MAX)} = 3A / 2A / 1A$

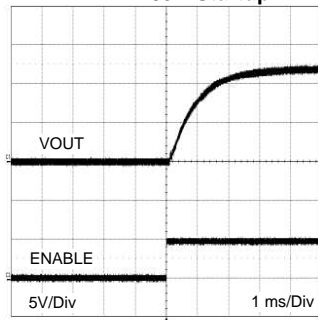
Designator	Description	Case Size	Manufacturer	Manufacturer P/N	Quantity
U1	SIMPLE SWITCHER®	PFM-7	Texas Instruments	LMZ14203 or LMZ14202 or LMZ14201	1
C_{IN4} , C_{O1}	1 μ F, X7R, 50V	1206	Taiyo Yuden	UMK316B7105KL-T	2
C_{IN2}	10 μ F, X5R, 50V	1210	Taiyo Yuden	UMK325BJ106MM-T	1
C_{O3}	47 μ F, 35 m Ω , 16V, Polymer	7343-43	KEMET	T525D476M016ATE035	1
C_{FF}	0.022 μ F, X7R, 100V	0805	AVX	08051C223JAT2A	1
C_{SS}	4700 pF, X7R, 25V	0805	AVX	08053A472JAT2A	1
R_{ENB}	11.8 k Ω	0805	Panasonic	ERJ-6ENF1182V	1
R_{ENT}	124 k Ω	0805	Panasonic	ERJ-6ENF1243V	1
R_{FBT}	34 k Ω	0805	Vishay-Dale	CRCW080534K0FKEA	1
R_{FBB}	2.43 k Ω	0805	Panasonic	ERJ-6ENF2431V	1
R_{ON}	249 k Ω	0805	Vishay-Dale	CRCW0805249KFKFA	1

4 Performance Characteristics

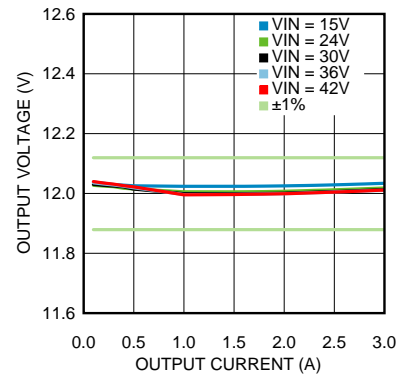
Unless otherwise specified the following conditions apply: $V_{IN} = 24V$, $V_{OUT} = 12V$, $T_{AMB} = 25^{\circ}C$



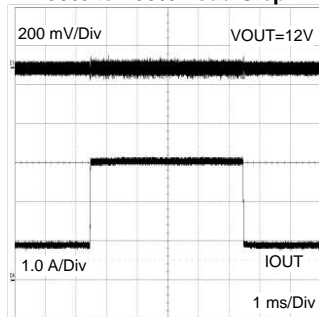
LMZ14203H Startup



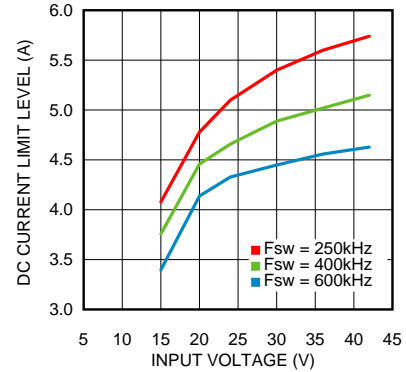
LMZ14203H Line and Load Regulation



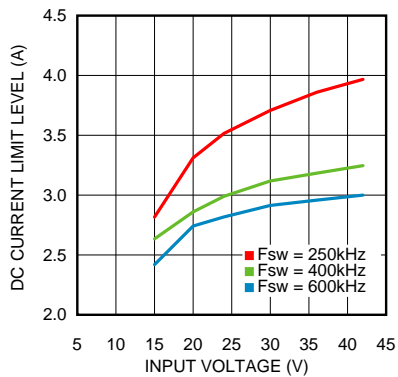
LMZ14203H Transient Response 30% to 100% Load Step



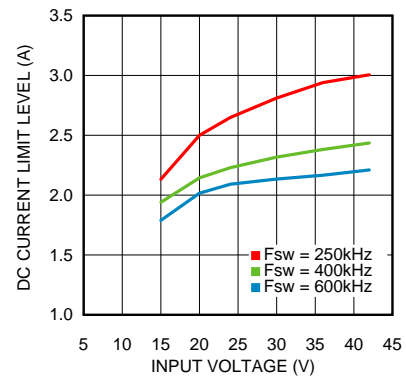
LMZ14203H Current Limit



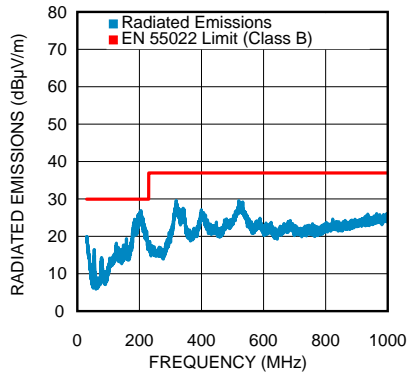
LMZ14202H Current Limit



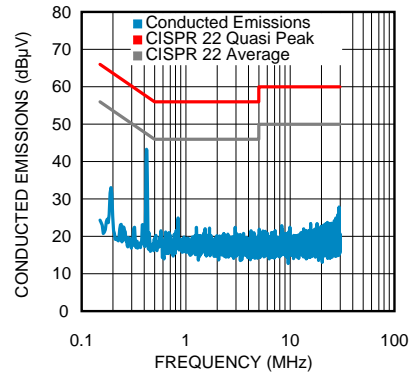
LMZ14201H Current Limit



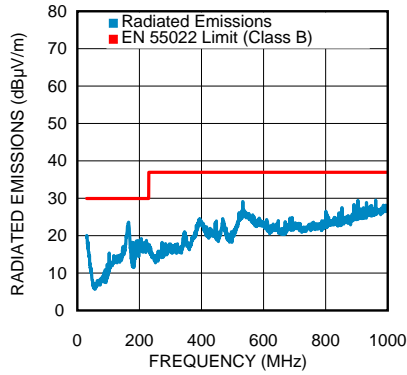
LMZ14203H Radiated EMI, $I_{OUT} = 3A$



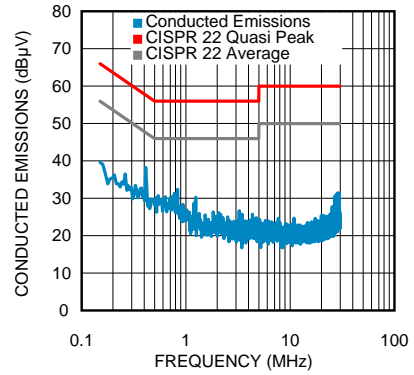
LMZ14203H Conducted EMI, $I_{OUT} = 3A$ with 3.3µH 2x10µF LC line filter added



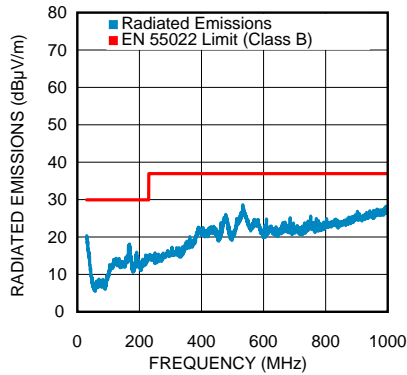
LMZ14202H Radiated EMI, $I_{OUT} = 2A$



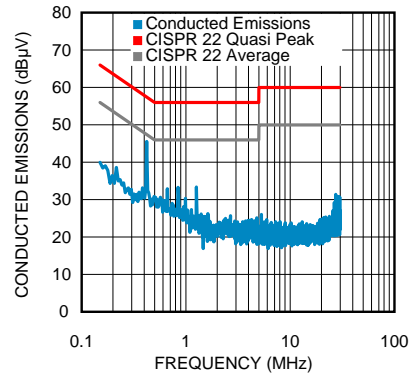
LMZ14202H Conducted EMI, $I_{OUT} = 2A$ with 3.3µH 2x10µF LC line filter added



LMZ14201H Radiated EMI, $I_{OUT} = 1A$



LMZ14201H Conducted EMI, $I_{OUT} = 1A$ with 3.3µH 1µF LC line filter added



5 PCB Layout Diagrams

Gerber and CAD files can be download from the LMZ14203H product folder.

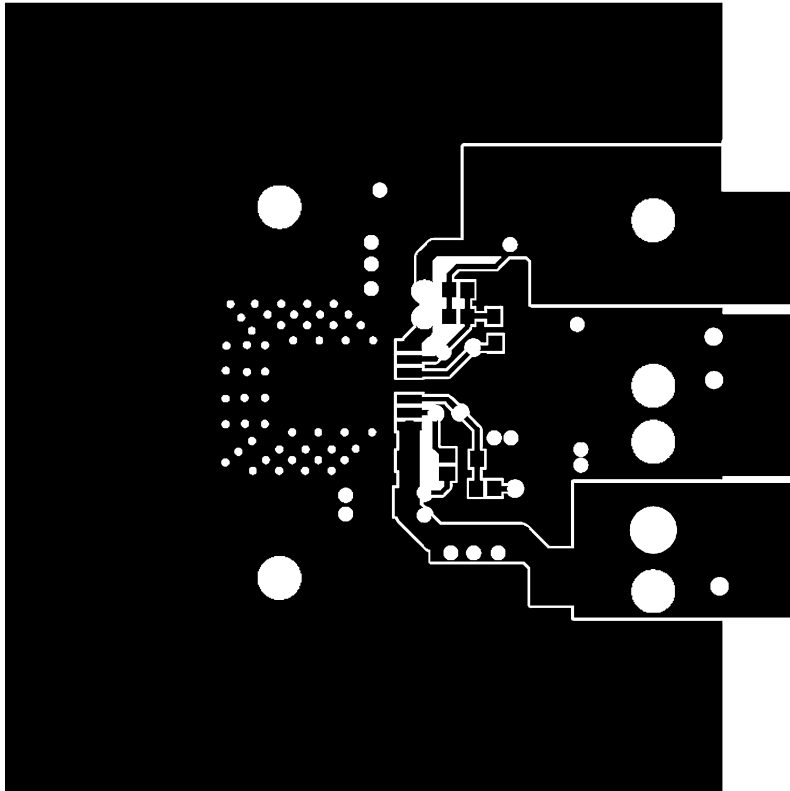
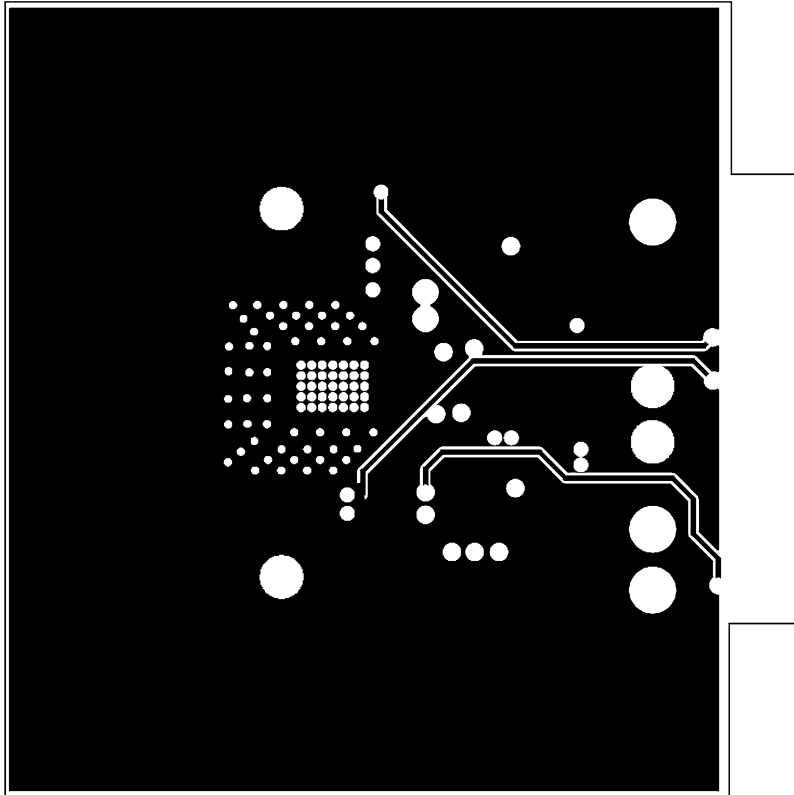
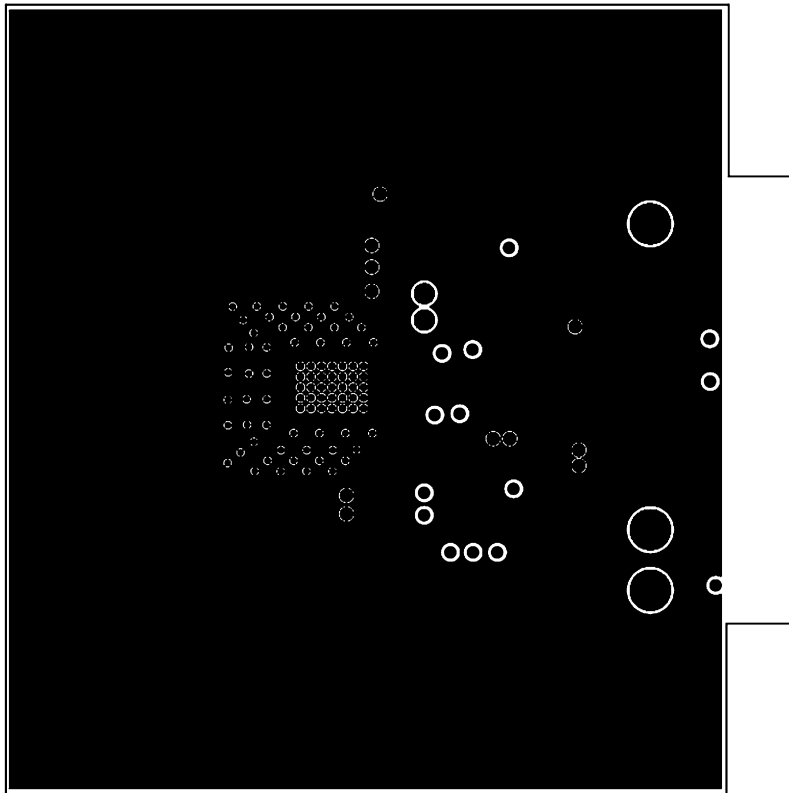


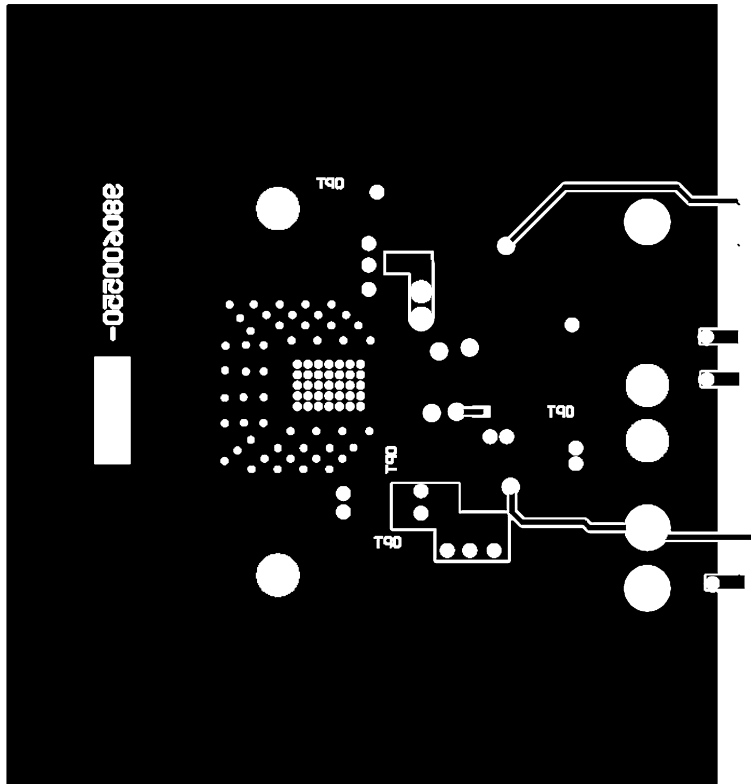
Figure 2. Top Layer



**Figure 3. Internal Layer I (Ground)
Heat Sinking Layer**



**Figure 4. Internal Layer II (Ground)
Heat Sinking Layer**



**Figure 5. Bottom Layer (Ground and Routing)
Heat Sinking Layer**

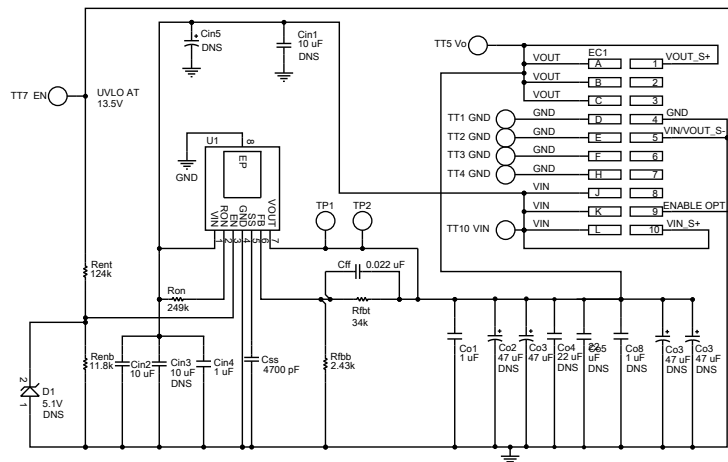
6 PCB Schematic


Figure 6. Detailed Schematic
 DNS = Component not installed

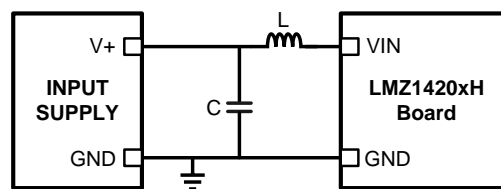


Figure 7. Conducted EMI LC Filter Configuration

IMPORTANT NOTICE

Texas Instruments Incorporated and its subsidiaries (TI) reserve the right to make corrections, enhancements, improvements and other changes to its semiconductor products and services per JESD46, latest issue, and to discontinue any product or service per JESD48, latest issue. Buyers should obtain the latest relevant information before placing orders and should verify that such information is current and complete. All semiconductor products (also referred to herein as "components") are sold subject to TI's terms and conditions of sale supplied at the time of order acknowledgment.

TI warrants performance of its components to the specifications applicable at the time of sale, in accordance with the warranty in TI's terms and conditions of sale of semiconductor products. Testing and other quality control techniques are used to the extent TI deems necessary to support this warranty. Except where mandated by applicable law, testing of all parameters of each component is not necessarily performed.

TI assumes no liability for applications assistance or the design of Buyers' products. Buyers are responsible for their products and applications using TI components. To minimize the risks associated with Buyers' products and applications, Buyers should provide adequate design and operating safeguards.

TI does not warrant or represent that any license, either express or implied, is granted under any patent right, copyright, mask work right, or other intellectual property right relating to any combination, machine, or process in which TI components or services are used. Information published by TI regarding third-party products or services does not constitute a license to use such products or services or a warranty or endorsement thereof. Use of such information may require a license from a third party under the patents or other intellectual property of the third party, or a license from TI under the patents or other intellectual property of TI.

Reproduction of significant portions of TI information in TI data books or data sheets is permissible only if reproduction is without alteration and is accompanied by all associated warranties, conditions, limitations, and notices. TI is not responsible or liable for such altered documentation. Information of third parties may be subject to additional restrictions.

Resale of TI components or services with statements different from or beyond the parameters stated by TI for that component or service voids all express and any implied warranties for the associated TI component or service and is an unfair and deceptive business practice. TI is not responsible or liable for any such statements.

Buyer acknowledges and agrees that it is solely responsible for compliance with all legal, regulatory and safety-related requirements concerning its products, and any use of TI components in its applications, notwithstanding any applications-related information or support that may be provided by TI. Buyer represents and agrees that it has all the necessary expertise to create and implement safeguards which anticipate dangerous consequences of failures, monitor failures and their consequences, lessen the likelihood of failures that might cause harm and take appropriate remedial actions. Buyer will fully indemnify TI and its representatives against any damages arising out of the use of any TI components in safety-critical applications.

In some cases, TI components may be promoted specifically to facilitate safety-related applications. With such components, TI's goal is to help enable customers to design and create their own end-product solutions that meet applicable functional safety standards and requirements. Nonetheless, such components are subject to these terms.

No TI components are authorized for use in FDA Class III (or similar life-critical medical equipment) unless authorized officers of the parties have executed a special agreement specifically governing such use.

Only those TI components which TI has specifically designated as military grade or "enhanced plastic" are designed and intended for use in military/aerospace applications or environments. Buyer acknowledges and agrees that any military or aerospace use of TI components which have **not** been so designated is solely at the Buyer's risk, and that Buyer is solely responsible for compliance with all legal and regulatory requirements in connection with such use.

TI has specifically designated certain components as meeting ISO/TS16949 requirements, mainly for automotive use. In any case of use of non-designated products, TI will not be responsible for any failure to meet ISO/TS16949.

Products

Audio	www.ti.com/audio
Amplifiers	amplifier.ti.com
Data Converters	dataconverter.ti.com
DLP® Products	www.dlp.com
DSP	dsp.ti.com
Clocks and Timers	www.ti.com/clocks
Interface	interface.ti.com
Logic	logic.ti.com
Power Mgmt	power.ti.com
Microcontrollers	microcontroller.ti.com
RFID	www.ti-rfid.com
OMAP Applications Processors	www.ti.com/omap
Wireless Connectivity	www.ti.com/wirelessconnectivity

Applications

Automotive and Transportation	www.ti.com/automotive
Communications and Telecom	www.ti.com/communications
Computers and Peripherals	www.ti.com/computers
Consumer Electronics	www.ti.com/consumer-apps
Energy and Lighting	www.ti.com/energy
Industrial	www.ti.com/industrial
Medical	www.ti.com/medical
Security	www.ti.com/security
Space, Avionics and Defense	www.ti.com/space-avionics-defense
Video and Imaging	www.ti.com/video

TI E2E Community

e2e.ti.com