

LM5166EVM-C33A Evaluation Module

User's Guide



Literature Number: SNVU544
December 2016

1	EVM Description	6
1.1	Typical Applications	6
1.2	Features and Electrical Performance	7
2	EVM Performance Specifications	7
3	Application Circuit Diagram	8
4	EVM Photo	8
5	Test Setup and Procedure	9
5.1	Test Setup	9
5.2	Test Equipment	10
5.3	Recommended Test Setup	10
5.4	Test Procedure	10
6	Test Data and Performance Curves	11
6.1	Conversion Efficiency	11
6.2	Line and Load Regulation	11
6.3	Operating Waveforms	12
6.4	EMI Performance - CISPR 25	19
7	EVM Documentation	20
7.1	Converter Schematics	21
7.2	PCB Layout	22
7.3	Bill of Materials	25
8	Reference Designs	25
8.1	Schematics	26
8.2	Bill of Materials - COT Designs	28
8.3	Bill of Materials - PFM Designs	29
9	Device Support	30
9.1	Development Support	30
9.2	Documentation Support	30

List of Figures

1	LM5166 Buck Converter Default Schematic: Adjustable Output COT	8
2	LM5166 EVM Photo	8
3	EVM Test Setup.....	9
4	COT Converter Efficiency (3.3 V, 500 mA Output)	11
5	Line and Load Regulation	11
6	COT Mode SW Node and V_{OUT} Waveforms: $V_{IN} = 12\text{ V}$, $V_{OUT} = 3.3\text{ V}$, $I_{OUT} = 0\text{ mA}$ ($5\mu\text{s}/\text{div}$, Ch1: SW, $5\text{V}/\text{div}$; Ch2: V_{OUT} , $50\text{mV}/\text{div}$).....	12
7	COT Mode SW Node and V_{OUT} Waveforms: $V_{IN} = 24\text{ V}$, $V_{OUT} = 3.3\text{ V}$, $I_{OUT} = 0\text{ mA}$ ($5\mu\text{s}/\text{div}$, Ch1: SW, $5\text{V}/\text{div}$; Ch2: V_{OUT} , $50\text{mV}/\text{div}$).....	12
8	COT Mode SW Node and V_{OUT} Waveforms: $V_{IN} = 12\text{ V}$, $V_{OUT} = 3.3\text{ V}$, $I_{OUT} = 50\text{ mA}$ ($5\mu\text{s}/\text{div}$, Ch1: SW, $5\text{V}/\text{div}$; Ch2: V_{OUT} , $50\text{mV}/\text{div}$).....	12
9	COT Mode SW Node and V_{OUT} Waveforms: $V_{IN} = 24\text{ V}$, $V_{OUT} = 3.3\text{ V}$, $I_{OUT} = 50\text{ mA}$ ($5\mu\text{s}/\text{div}$, Ch1: SW, $5\text{V}/\text{div}$; Ch2: V_{OUT} , $50\text{mV}/\text{div}$).....	12
10	COT Mode SW Node and V_{OUT} Waveforms: $V_{IN} = 12\text{ V}$, $V_{OUT} = 3.3\text{ V}$, $I_{OUT} = 500\text{ mA}$ ($5\mu\text{s}/\text{div}$, Ch1: SW, $5\text{V}/\text{div}$; Ch2: V_{OUT} , $50\text{mV}/\text{div}$).....	12
11	COT Mode SW Node and V_{OUT} Waveforms: $V_{IN} = 24\text{ V}$, $V_{OUT} = 3.3\text{ V}$, $I_{OUT} = 500\text{ mA}$ ($5\mu\text{s}/\text{div}$, Ch1: SW, $5\text{V}/\text{div}$; Ch2: V_{OUT} , $50\text{mV}/\text{div}$).....	12
12	Load-ON Transient Response $V_{IN} = 12\text{ V}$, $V_{OUT} = 5\text{ V}$, 0 mA to 500 mA at $2\text{ A}/\mu\text{s}$ ($100\mu\text{s}/\text{div}$, Ch4: I_{OUT} , $200\text{mA}/\text{div}$; Ch2: V_{OUT} , $100\text{mV}/\text{div}$)	13
13	Load-OFF Transient Response $V_{IN} = 12\text{ V}$, $V_{OUT} = 3.3\text{ V}$, 500 mA to 0 mA at $2\text{ A}/\mu\text{s}$ ($100\mu\text{s}/\text{div}$, Ch4: I_{OUT} , $200\text{mA}/\text{div}$; Ch2: V_{OUT} , $100\text{mV}/\text{div}$).....	13
14	Load-ON Transient Response $V_{IN} = 24\text{ V}$, $V_{OUT} = 3.3\text{ V}$, 0 mA to 500 mA at $2\text{ A}/\mu\text{s}$ ($100\mu\text{s}/\text{div}$, Ch4: I_{OUT} , $200\text{mA}/\text{div}$; Ch2: V_{OUT} , $100\text{mV}/\text{div}$)	13
15	Load-OFF Transient Response $V_{IN} = 24\text{ V}$, $V_{OUT} = 3.3\text{ V}$, 500 mA to 0 mA at $2\text{ A}/\mu\text{s}$ ($100\mu\text{s}/\text{div}$, Ch4: I_{OUT} , $200\text{mA}/\text{div}$; Ch2: V_{OUT} , $100\text{mV}/\text{div}$).....	13
16	Startup with V_{IN} Ramping to 12 V , No Load ($2\text{ms}/\text{div}$, Ch1: V_{IN} , $3\text{V}/\text{div}$; Ch2: V_{OUT} , $1\text{V}/\text{div}$; Ch4: I_{OUT} , $200\text{mA}/\text{div}$)	14
17	Startup with V_{IN} Ramping to 24 V , No Load ($2\text{ms}/\text{div}$, Ch1: V_{IN} , $3\text{V}/\text{div}$; Ch2: V_{OUT} , $1\text{V}/\text{div}$; Ch4: I_{OUT} , $200\text{mA}/\text{div}$)	14
18	Startup with V_{IN} Ramping to 12 V , 500 mA Load ($2\text{ms}/\text{div}$, Ch1: V_{IN} , $3\text{V}/\text{div}$; Ch2: V_{OUT} , $1\text{V}/\text{div}$; Ch4: I_{OUT} , $200\text{mA}/\text{div}$)	14
19	Startup with V_{IN} Ramping to 24 V , 500 mA Load ($2\text{ms}/\text{div}$, Ch1: V_{IN} , $3\text{V}/\text{div}$; Ch2: V_{OUT} , $1\text{V}/\text{div}$; Ch4: I_{OUT} , $200\text{mA}/\text{div}$)	14
20	Startup with V_{OUT} Pre-biased to 1.8 V ; $V_{IN} = 12\text{ V}$, No Load ($2\text{ms}/\text{div}$, Ch1: V_{IN} , $3\text{V}/\text{div}$; Ch2: V_{OUT} , $1\text{V}/\text{div}$; Ch4: I_{OUT} , $200\text{mA}/\text{div}$)	14
21	Startup with V_{OUT} Pre-biased to 1.8 V ; $V_{IN} = 12\text{ V}$, 500 mA Load ($2\text{ms}/\text{div}$, Ch1: V_{IN} , $3\text{V}/\text{div}$; Ch2: V_{OUT} , $1\text{V}/\text{div}$; Ch4: I_{OUT} , $200\text{mA}/\text{div}$)	14
22	ENABLE On and Off; $V_{IN} = 24\text{ V}$, No Load ($2\text{ms}/\text{div}$, Ch1: V_{EN} , $1\text{V}/\text{div}$; Ch2: V_{OUT} , $1\text{V}/\text{div}$; Ch4: I_{OUT} , $200\text{mA}/\text{div}$)	15
23	ENABLE On and Off; $V_{IN} = 24\text{ V}$, No Load ($2\text{ms}/\text{div}$, Ch1: V_{EN} , $1\text{V}/\text{div}$; Ch2: V_{OUT} , $1\text{V}/\text{div}$; Ch4: I_{OUT} , $200\text{mA}/\text{div}$)	15
24	ENABLE On and Off with V_{OUT} Pre-biased to 1.8V ; $V_{IN} = 24\text{ V}$, No Load ($2\text{ms}/\text{div}$, Ch1: V_{EN} , $1\text{V}/\text{div}$; Ch2: V_{OUT} , $1\text{V}/\text{div}$; Ch4: I_{OUT} , $200\text{mA}/\text{div}$).....	15
25	ENABLE On and Off with V_{OUT} Pre-biased to 1.8V ; $V_{IN} = 24\text{ V}$, 500 mA Load ($2\text{ms}/\text{div}$, Ch1: V_{EN} , $1\text{V}/\text{div}$; Ch2: V_{OUT} , $1\text{V}/\text{div}$; Ch4: I_{OUT} , $200\text{mA}/\text{div}$)	15
26	ENABLE On and Off with V_{OUT} Pre-biased to 3.3V ; $V_{IN} = 24\text{ V}$, No Load ($2\text{ms}/\text{div}$, Ch1: V_{EN} , $1\text{V}/\text{div}$; Ch2: V_{OUT} , $1\text{V}/\text{div}$; Ch4: I_{OUT} , $200\text{mA}/\text{div}$).....	15
27	ENABLE On and Off with V_{OUT} Pre-biased to 3.3V ; $V_{IN} = 24\text{ V}$, 500 mA Load ($2\text{ms}/\text{div}$, Ch1: V_{EN} , $1\text{V}/\text{div}$; Ch2: V_{OUT} , $1\text{V}/\text{div}$; Ch4: I_{OUT} , $200\text{mA}/\text{div}$)	15
28	Line Transient Response, No Load 65 V to 12 V to 65 V at $1\text{ V}/\mu\text{s}$ ($1\text{ms}/\text{div}$, Ch1: V_{IN} , $10\text{V}/\text{div}$; Ch2: V_{OUT} , $100\text{mV}/\text{div}$)	16
29	Line Transient Response, 500 mA Load 65 V to 12 V to 65 V at $1\text{ V}/\mu\text{s}$ ($1\text{ms}/\text{div}$, Ch1: V_{IN} , $10\text{V}/\text{div}$; Ch2: V_{OUT} , $100\text{mV}/\text{div}$).....	16

30	Line Transient Response, No Load 24 V to 8 V to 24 V at 0.1 V/ μ s (1ms/div, Ch1: V_{IN} , 10V/div; Ch2: V_{OUT} , 100mV/div).....	16
31	Line Transient Response, 500 mA Load 24 V to 8 V to 24 V at 0.1 V/ μ s (1ms/div, Ch1: V_{IN} , 10V/div; Ch2: V_{OUT} , 100mV/div).....	16
32	Line Transient Response, No Load 24 V to 5 V to 24 V at 0.1 V/ μ s (1ms/div, Ch1: V_{IN} , 10V/div; Ch2: V_{OUT} , 100mV/div).....	16
33	Line Transient Response, 500 mA Load 24 V to 5 V (Dropout) to 24 V at 0.1 V/ μ s (1ms/div, Ch1: V_{IN} , 10V/div; Ch2: V_{OUT} , 100mV/div).....	16
34	Line Transient Response, No Load 24 V to 3.5 V to 24 V at 0.1 V/ μ s (1ms/div, Ch1: V_{IN} , 10V/div; Ch2: V_{OUT} , 100mV/div).....	16
35	Line Transient Response, 500 mA Load 24 V to 3.5 V (Dropout) to 24 V at 0.1 V/ μ s (1ms/div, Ch1: V_{IN} , 10V/div; Ch2: V_{OUT} , 500mV/div).....	16
36	Typical Automotive Cold-Crank VIN Transient, Profile 1, 500 mA Load (2s/div, Ch1: V_{IN} , 2V/div; Ch2: V_{OUT} , 2V/div; Ch4: I_{OUT} , 200mA/div).....	18
37	Typical Automotive Cold-Crank VIN Transient, Profile 2, 500 mA Load (200ms/div, Ch1: V_{IN} , 2V/div; Ch2: V_{OUT} , 2V/div; Ch4: I_{OUT} , 200mA/div).....	18
38	Typical Automotive Cold-Crank VIN Transient, Profile 3, 500 mA Load (2s/div, Ch1: V_{IN} , 2V/div; Ch2: V_{OUT} , 2V/div; Ch4: I_{OUT} , 200mA/div).....	18
39	Zoom-in on a Typical Automotive Cold-Crank VIN Transient, Profile 3, 500 mA Load (200ms/div, Ch1: V_{IN} , 2V/div; Ch2: V_{OUT} , 2V/div; Ch4: I_{OUT} , 200mA/div).....	18
40	EMI Filter	19
41	CISPR25 Class 5 Conducted Emissions Plot, 150 kHz to 30 MHz, V_{IN} = 13.5 V, Load = 500 mA, UNFILTERED (Yellow: Peak Detector, Blue: Average Detector)	20
42	CISPR25 Class 5 Conducted Emissions Plot, 150 kHz to 30 MHz, V_{IN} = 13.5 V, Load = 500 mA, FILTERED (Yellow: Peak Detector, Blue: Average Detector)	20
43	CISPR25 Class 5 Conducted Emissions Plot, 30 MHz to 108 MHz, V_{IN} = 13.5 V, Load = 500 mA, UNFILTERED (Yellow: Peak Detector, Blue: Average Detector)	20
44	CISPR25 Class 5 Conducted Emissions Plot, 30 MHz to 108 MHz, V_{IN} = 13.5 V, Load = 500 mA, FILTERED (Yellow: Peak Detector, Blue: Average Detector)	20
45	3.3V, 500mA COT Schematic (Adjustable Output Version)	21
46	Top Copper (Top View).....	22
47	Layer 2 (Top View).....	22
48	Layer 3 (Top View).....	23
49	Bottom Copper (Bottom View).....	23
50	Top Assembly.....	24
51	Bottom Assembly.....	24
52	5V, 500mA COT Schematic (Adjustable Output Version)	26
53	5V, 500mA PFM Schematic (Adjustable Output Version)	27

List of Tables

1	Electrical Performance Specifications.....	7
2	EVM Connections.....	9
3	List of Components for EMI Filter	19
4	Bill of Materials (COT, 3.3 V, 500 mA, Adjustable Output Version)	25
5	Bill of Materials (COT, 5 V, 500 mA, Adjustable Output Version)	28
6	Bill of Materials (COT, 3.3 V, 300 mA, Adjustable Output Version)	28
7	Bill of Materials (PFM, 5V, 500 mA, Adjustable Output Version)	29
8	Bill of Materials (PFM, 3.3V, 300 mA, Adjustable Output Version)	29

LM5166EVM-C33A User's Guide

The LM5166EVM evaluation module (EVM) is designed to showcase the performance and all features of the LM5166, wide-VIN, synchronous buck DC/DC buck converter with ultra-low no-load supply current. The design is packaged in a miniature footprint with low component count. It operates over a wide input voltage range of 3 V to 65 V to deliver a 3.3-V output with better than 2% setpoint accuracy. Low-dropout performance whenever the input voltage decreases below the output voltage setpoint is available with 100% duty cycle conduction of the high-side MOSFET. By virtue of the LM5166's constant-on-time (COT) control scheme and diode emulation, the no-load supply current is only 12 μ A at 24-V input.

With integrated high- and low-side power MOSFETs, the design uses synchronous rectification to achieve high conversion efficiency over a wide load current range. The selectable PFM or COT control architecture simplifies the implementation while giving the option for optimization depending on the target application. Key features include programmable cycle-by-cycle peak current limit, over-temperature protection, configurable soft-start, 1.22-V precision enable threshold, and open-drain PGOOD flag. With AEC-Q100 Q1 grade automotive qualification, the LM5166 is rated to operate over a junction temperature range of -40°C to $+150^{\circ}\text{C}$. Input UVLO turn-on/off thresholds are set internally at 2.75 V and 2.45 V to protect the module at low input voltage conditions, and it is possible to tailor the minimum operating input voltage and hysteresis to the application requirements by suitable choice of input UVLO components.

The LM5166 is available in VSON-10 PowerPAD™ package with 3 x 3-mm² body size to enable high density, low component count DC/DC solutions. Please consult the LM5166 datasheet for more information. The LM5166 is supported by [WEBENCH®](#) Designer and numerous SPICE simulation models. Furthermore, the reader can avail of the [LM5166 Quick-Start Design Tool](#) to optimize component selection and examine predicted efficiency performance across wide line and load ranges.

1 EVM Description

The LM5166 EVM is designed to use a regulated or non-regulated high-voltage input rail (3.0 V to 65 V) to produce a tightly regulated output voltage of 3.3 V at continuous current levels up to 500 mA. In particular, the current limit is set to one of two pre-defined levels to optimize inductor size and maximize efficiency. The EVM's maximum output current is configured by default to 500 mA but can be changed to 300 mA by suitable component selection.

ENABLE and PGOOD connections are provided to facilitate upstream and downstream sequencing of the LM5166-based converter. The output voltage is user-adjustable by modification of the feedback resistors as appropriate. The power train passive components selected in this design, including filter inductor and ceramic input and output capacitors, are available with AEC-Q200 qualification for automotive applications.

1.1 Typical Applications

- High voltage LDO replacement
- Process control
- Building automation and HVAC
- General-purpose bias supplies
- Automotive and battery powered equipment

1.2 Features and Electrical Performance

- Tightly-regulated output voltage of 3.3 V with 1.5% setpoint accuracy, adjustable from 1.223 V to V_{IN}
- Wide input voltage operating range of 3 V to 65 V
- Ultra-high power conversion efficiency:
 - >85% at an output voltage of 3.3 V and load current above 10 mA (input voltage 12 V)
- No-load supply current as low as 11 μ A
- Integrated 1- Ω PMOS buck switch supports 100% duty cycle for low dropout voltage
- Integrated 0.5- Ω NMOS synchronous rectifier eliminates external Schottky diode
- Output voltage level and inductor current limit set with the ILIM pin
- User-adjustable soft-start ramp time set to 4 ms by 33-nF capacitor at the SS pin
- ENABLE and PGOOD terminals with 10-M Ω and 10-k Ω pullups to V_{IN} and V_{OUT} , respectively
- Monotonic pre-bias output voltage startup
- Programmable input UVLO (internally set to turn on and off at 2.75 V and 2.45 V, respectively)
- Fully assembled, tested and proven PCB layout with 31.75-mm x 25.4-mm total footprint

2 EVM Performance Specifications

Table 1. Electrical Performance Specifications

Parameter	Test Conditions	MIN	TYP	MAX	UNITS
INPUT CHARACTERISTICS					
Input voltage range, V_{IN}	Operating	3	12	65	V
Input voltage turn on, $V_{IN(ON)}$	Set internally, adjusted by populating EN/UVLO resistors		2.75		V
Input voltage turn off, $V_{IN(OFF)}$			2.45		V
Input voltage hysteresis, $V_{IN(HYS)}$				0.3	
Input current, no load, $I_{IN(NL)}$	$I_{OUT} = 0$ mA	$V_{IN} = 12$ V		14	μ A
		$V_{IN} = 24$ V		12	μ A
		$V_{IN} = 65$ V		11	μ A
Input current, disabled, $I_{IN(OFF)}$	$V_{ENABLE} = 0$ V	$V_{IN} = 12$ V		6	μ A
OUTPUT CHARACTERISTICS					
Output voltage, $V_{OUT}^{(1)}$	V_{OUT} follows V_{IN} for $V_{IN} < 3.3$ V + $1.3 \Omega * I_{OUT}$	3.23	3.3	3.37	V
Output current, I_{OUT}	$V_{IN} = 3$ V to 65 V	0		500	mA
Output voltage regulation, ΔV_{OUT}	Load Regulation	$I_{OUT} = 0$ mA to 500 mA		1%	
	Line Regulation	$V_{IN} = 4.5$ V to 65 V		1%	
Output voltage ripple, $V_{OUT(AC)}$	$V_{IN} = 12$ V, $I_{OUT} = 250$ mA		25		mVp-p
Output overcurrent protection, I_{OCP}	$V_{IN} = 12$ V, ILIM setting of 750 mA		750		mA
Soft-start time, t_{SS}			4		ms
SYSTEM CHARACTERISTICS					
Pulse switching frequency, $F_{SW(nom)}$	$V_{IN} = 12$ V		200		kHz
Half-load efficiency, $\eta_{HALF}^{(1)}$	$I_{OUT} = 250$ mA	$V_{IN} = 12$ V		88.2%	
Full load efficiency, η_{FULL}	$I_{OUT} = 500$ mA	$V_{IN} = 8$ V		85.5%	
		$V_{IN} = 12$ V		85.1%	
		$V_{IN} = 24$ V		82.9%	
		$V_{IN} = 36$ V		80.4%	
		$V_{IN} = 65$ V		74.9%	
LM5166 junction temperature, T_J		-40		150	$^{\circ}$ C

⁽¹⁾ The default output voltage of this EVM is 3.3 V. Efficiency and other performance metrics will change based on the operating input voltage, output voltage, load current, output capacitance, and other parameters.

3 Application Circuit Diagram

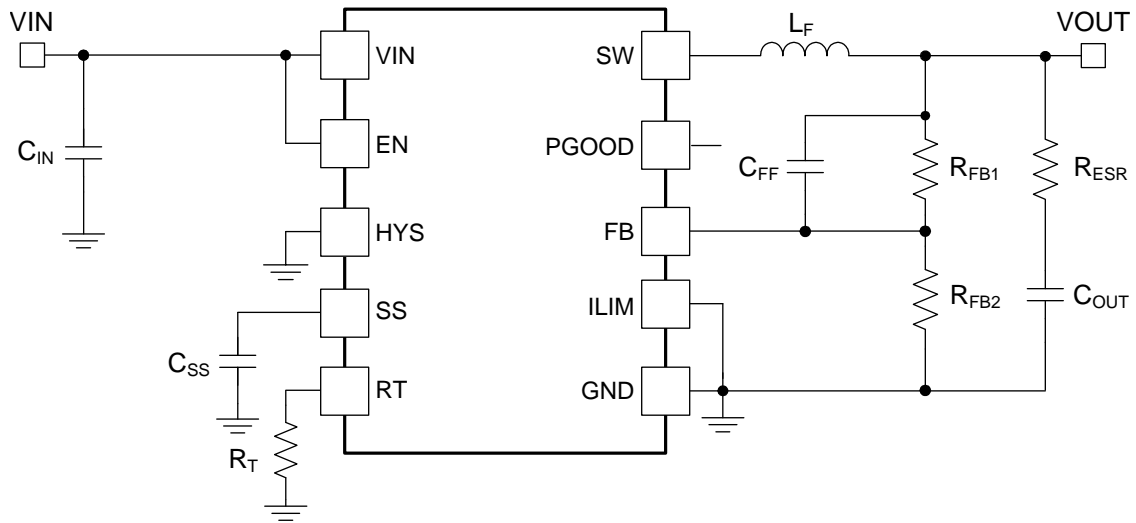


Figure 1. LM5166 Buck Converter Default Schematic: Adjustable Output COT

4 EVM Photo

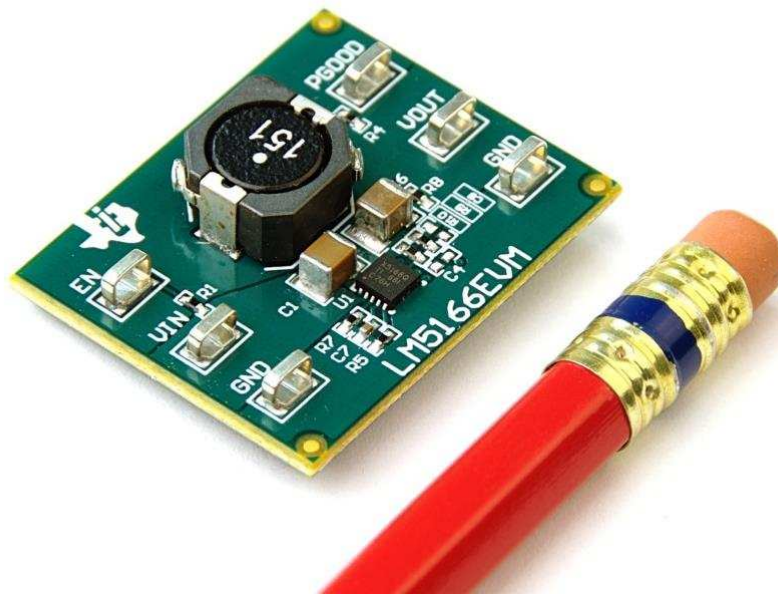


Figure 2. LM5166 EVM Photo

5 Test Setup and Procedure

5.1 Test Setup

Table 2. EVM Connections

LABEL	DESCRIPTION
VIN	Positive input voltage power and sense connection
GND	Negative input voltage negative power and sense connection
VOUT	Positive output voltage positive power and sense connection
GND	Negative output voltage negative power and sense connection
ENABLE	ENABLE input – tie to GND to disable converter
PGOOD	Power Good output

Referencing the EVM connections described in Table 2, Figure 3 shows the recommended test setup to evaluate the LM5166EVM. Working at an ESD workstation, make sure that any wrist straps, boot straps or mats are connected referencing the user to earth ground before power is applied to the EVM.

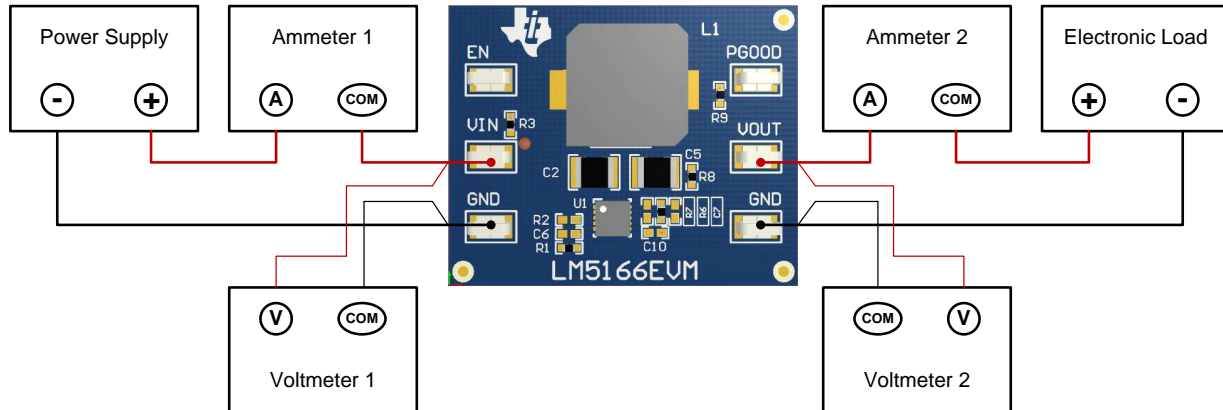


Figure 3. EVM Test Setup

CAUTION

Please refer to the [LM5166](#) datasheet, [Quick-Start Design Tool](#), and [WEBENCH®](#) Power Designer for additional guidance pertaining to component selection and converter operation.

5.2 Test Equipment

Voltage Source: The input voltage source VIN should be a 0–70-V variable dc source capable of supplying 1A.

Multimeters:

- **Voltmeter 1:** Input voltage at VIN to GND. Set voltmeter to input impedance of 1 G Ω .
- **Voltmeter 2:** Output voltage at VOUT to GND. Set voltmeter to input impedance of 1 G Ω .
- **Ammeter 1:** Input current. Set ammeter to 1-second aperture time.
- **Ammeter 2:** Output current. Set ammeter to 1-second aperture time

Electronic Load: The load should be an electronic constant-resistance (CR) or constant-current (CC) mode load capable of 0 mAdc to 750 mAdc at 3.3 V. For a no-load input current measurement, disconnect the electronic load as it may draw a small residual current.

Oscilloscope: With the scope set to 20-MHz bandwidth and AC coupling, measure the output voltage ripple directly across an output capacitor with a short ground lead normally provided with the scope probe. Place the oscilloscope probe tip on the positive terminal of the output capacitor, holding the probe's ground barrel through the ground lead to the capacitor's negative terminal. It is not recommended to use a long-leaded ground connection because this may induce additional noise given a large ground loop. To measure other waveforms, adjust the oscilloscope as needed.

Safety: Always use caution when touching any circuits that may be live or energized.

5.3 Recommended Test Setup

5.3.1 Input Connections

- Prior to connecting the DC input source, it is advisable to limit the source current to 1 A maximum. Ensure the input source is initially set to 0 V and connected to the VIN and GND connection points as shown in [Figure 3](#). An additional high-ESR, low leakage, input bulk capacitor (e.g. 47- μ F, 100-V Electrolytic capacitor) is recommended if long input lines are used.
- Connect voltmeter 1 at VIN and GND connection points to measure the input voltage.
- Connect ammeter 1 to measure the input current and set to at least 1-second aperture time.

5.3.2 Output Connections

- Connect an electronic load to VOUT and GND connections. Set the load to constant-resistance mode or constant-current mode at 0 mAdc before applying input voltage.
- Connect voltmeter 2 at VOUT and GND connection points to measure the output voltage.
- Connect ammeter 2 to measure the output current.

5.4 Test Procedure

5.4.1 Line and Load Regulation, Efficiency

- Setup the EVM as described above.
- Set load to constant resistance or constant current mode and to sink 0 mAdc.
- Increase input source from 0 V to 12 V, using voltmeter 1 to measure the input voltage.
- Using voltmeter 2 to measure the output voltage, V_{OUT} , vary the load current from 0 to 500 mAdc; V_{OUT} should remain within the load regulation specification.
- Vary input source voltage from 4.5 V to 65 V; V_{OUT} should remain within the line regulation specification.
- Decrease load to 0 mA. Decrease input source voltage to 0 V.

6 Test Data and Performance Curves

Figure 4 presents typical efficiency curves for the LM5166EVM-C33A. Since actual efficiency data may be affected by measurement techniques and environmental variables, these curves are presented for reference and may differ from actual field measurements.

6.1 Conversion Efficiency

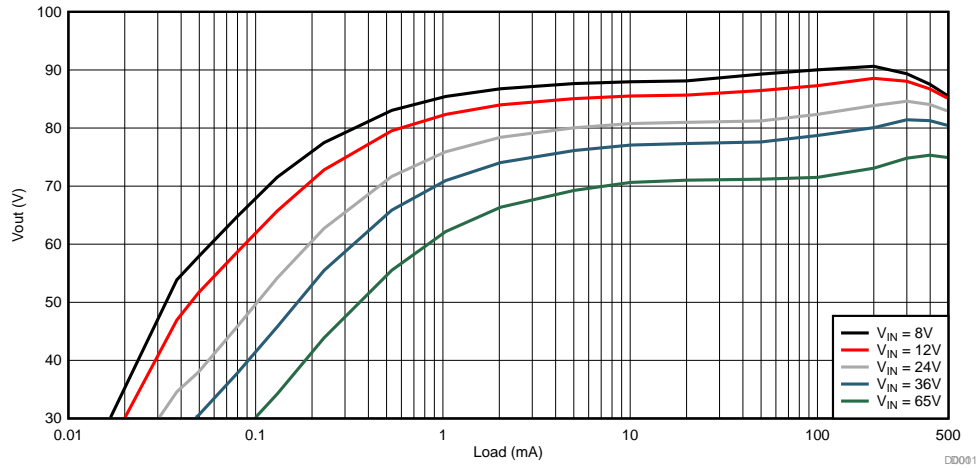


Figure 4. COT Converter Efficiency (3.3 V, 500 mA Output)

6.2 Line and Load Regulation

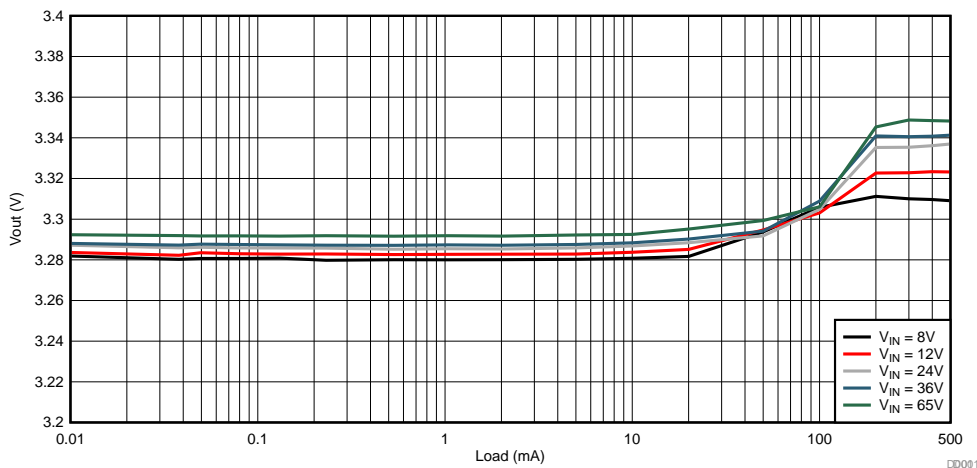


Figure 5. Line and Load Regulation

6.3 Operating Waveforms

6.3.1 Switching

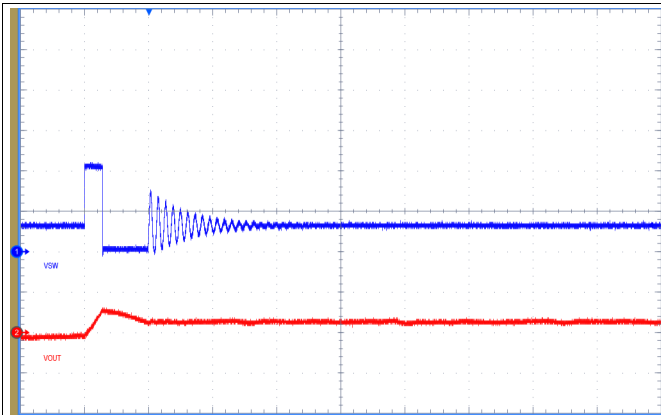


Figure 6. COT Mode SW Node and V_{OUT} Waveforms:
 $V_{IN} = 12\text{ V}$, $V_{OUT} = 3.3\text{ V}$, $I_{OUT} = 0\text{ mA}$
 (5 $\mu\text{s}/\text{div}$, Ch1: SW, 5V/div; Ch2: V_{OUT} , 50mV/div)

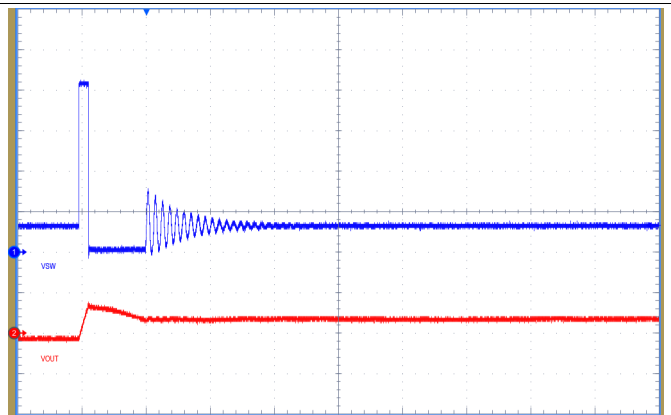


Figure 7. COT Mode SW Node and V_{OUT} Waveforms:
 $V_{IN} = 24\text{ V}$, $V_{OUT} = 3.3\text{ V}$, $I_{OUT} = 0\text{ mA}$
 (5 $\mu\text{s}/\text{div}$, Ch1: SW, 5V/div; Ch2: V_{OUT} , 50mV/div)

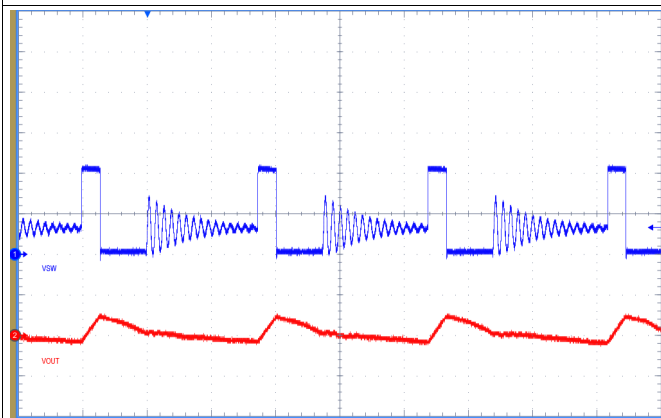


Figure 8. COT Mode SW Node and V_{OUT} Waveforms:
 $V_{IN} = 12\text{ V}$, $V_{OUT} = 3.3\text{ V}$, $I_{OUT} = 50\text{ mA}$
 (5 $\mu\text{s}/\text{div}$, Ch1: SW, 5V/div; Ch2: V_{OUT} , 50mV/div)

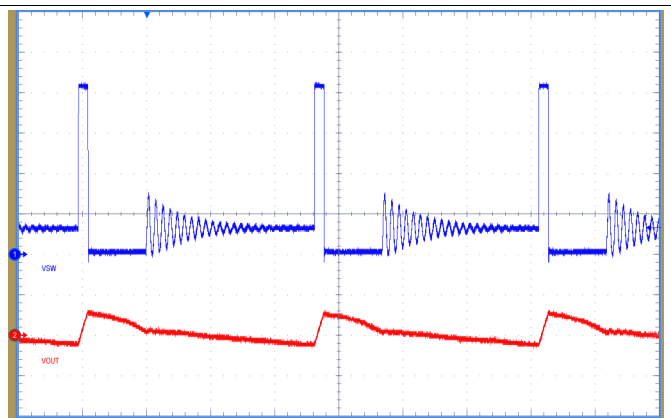


Figure 9. COT Mode SW Node and V_{OUT} Waveforms:
 $V_{IN} = 24\text{ V}$, $V_{OUT} = 3.3\text{ V}$, $I_{OUT} = 50\text{ mA}$
 (5 $\mu\text{s}/\text{div}$, Ch1: SW, 5V/div; Ch2: V_{OUT} , 50mV/div)

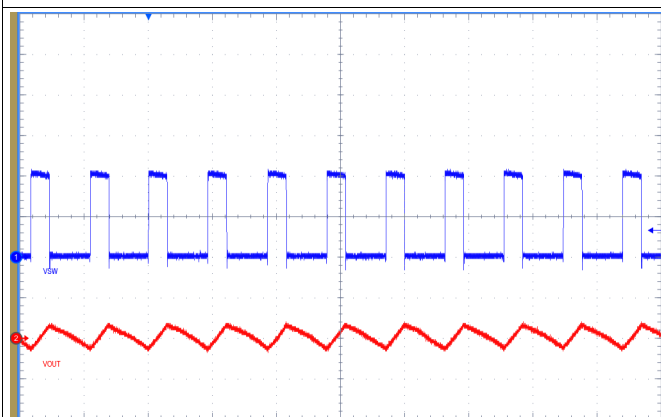


Figure 10. COT Mode SW Node and V_{OUT} Waveforms:
 $V_{IN} = 12\text{ V}$, $V_{OUT} = 3.3\text{ V}$, $I_{OUT} = 500\text{ mA}$
 (5 $\mu\text{s}/\text{div}$, Ch1: SW, 5V/div; Ch2: V_{OUT} , 50mV/div)

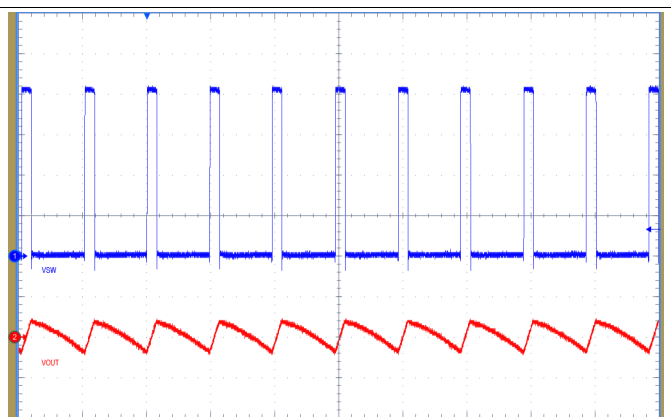


Figure 11. COT Mode SW Node and V_{OUT} Waveforms:
 $V_{IN} = 24\text{ V}$, $V_{OUT} = 3.3\text{ V}$, $I_{OUT} = 500\text{ mA}$
 (5 $\mu\text{s}/\text{div}$, Ch1: SW, 5V/div; Ch2: V_{OUT} , 50mV/div)

6.3.2 Load Transient Response

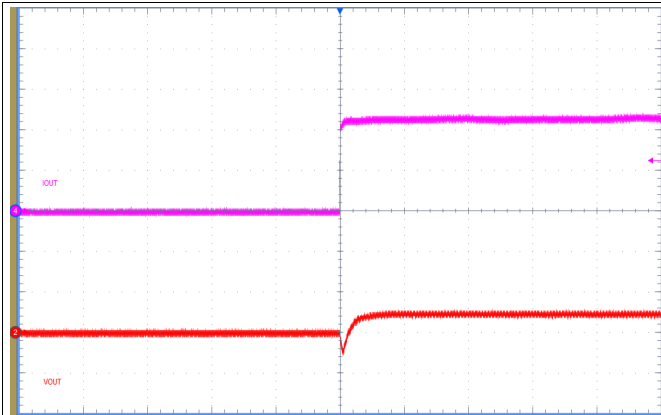


Figure 12. Load-ON Transient Response
 $V_{IN} = 12\text{ V}$, $V_{OUT} = 5\text{ V}$, 0 mA to 500 mA at 2 A/ μ s
 (100 μ s/div, Ch4: I_{OUT} , 200mA/div; Ch2: V_{OUT} , 100mV/div)

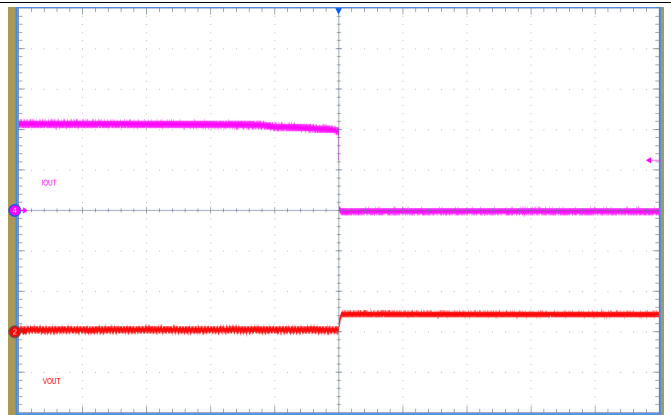


Figure 13. Load-OFF Transient Response
 $V_{IN} = 12\text{ V}$, $V_{OUT} = 3.3\text{ V}$, 500 mA to 0 mA at 2 A/ μ s
 (100 μ s/div, Ch4: I_{OUT} , 200mA/div; Ch2: V_{OUT} , 100mV/div)

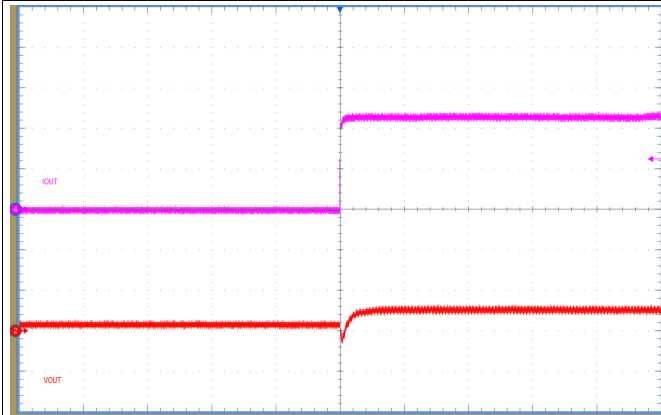


Figure 14. Load-ON Transient Response
 $V_{IN} = 24\text{ V}$, $V_{OUT} = 3.3\text{ V}$, 0 mA to 500 mA at 2 A/ μ s
 (100 μ s/div, Ch4: I_{OUT} , 200mA/div; Ch2: V_{OUT} , 100mV/div)

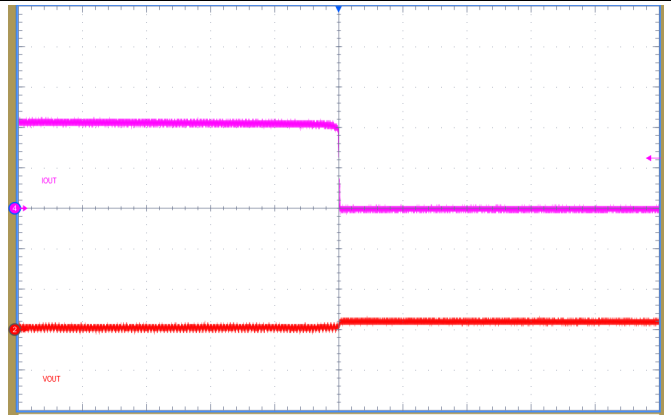


Figure 15. Load-OFF Transient Response
 $V_{IN} = 24\text{ V}$, $V_{OUT} = 3.3\text{ V}$, 500 mA to 0 mA at 2 A/ μ s
 (100 μ s/div, Ch4: I_{OUT} , 200mA/div; Ch2: V_{OUT} , 100mV/div)

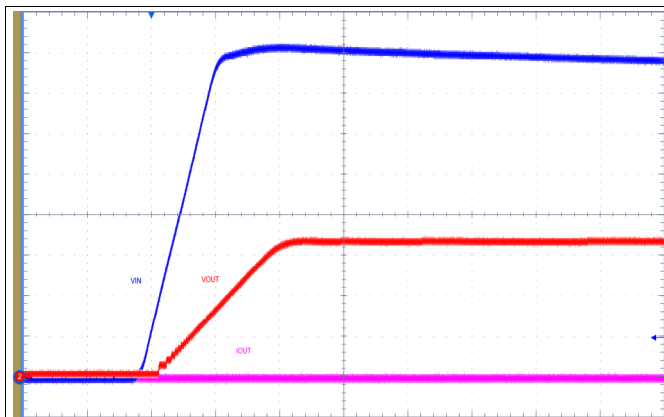
6.3.3 Startup


Figure 16. Startup with V_{IN} Ramping to 12 V, No Load
(2ms/div, Ch1: V_{IN} , 3V/div; Ch2: V_{OUT} , 1V/div;
Ch4: I_{OUT} , 200mA/div)

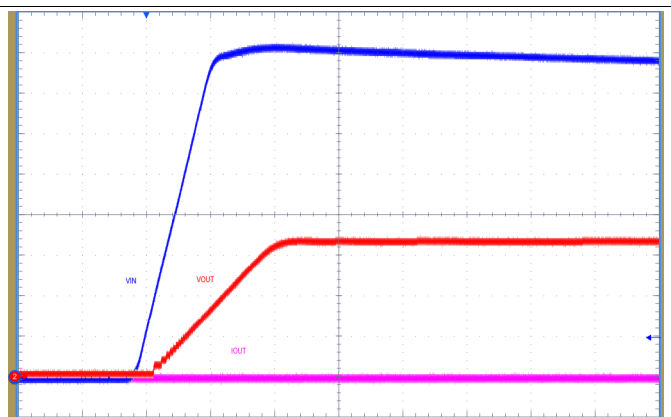


Figure 17. Startup with V_{IN} Ramping to 24 V, No Load
(2ms/div, Ch1: V_{IN} , 3V/div; Ch2: V_{OUT} , 1V/div;
Ch4: I_{OUT} , 200mA/div)

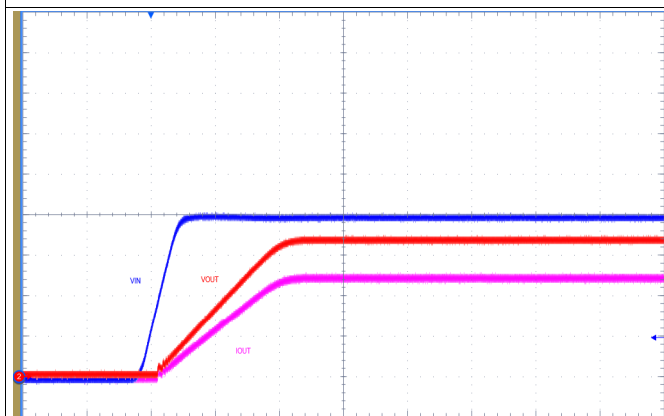


Figure 18. Startup with V_{IN} Ramping to 12 V, 500 mA Load
(2ms/div, Ch1: V_{IN} , 3V/div; Ch2: V_{OUT} , 1V/div;
Ch4: I_{OUT} , 200mA/div)

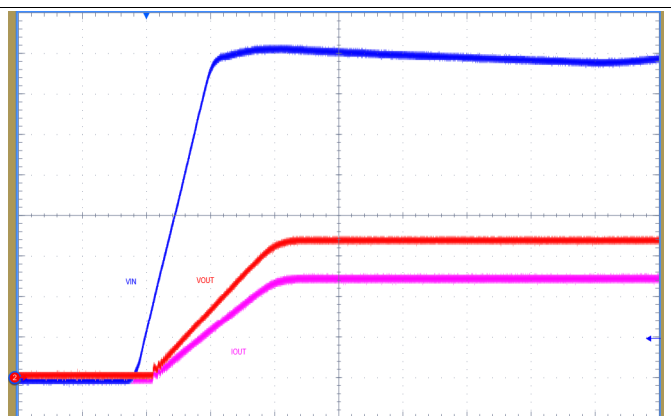


Figure 19. Startup with V_{IN} Ramping to 24 V, 500 mA Load
(2ms/div, Ch1: V_{IN} , 3V/div; Ch2: V_{OUT} , 1V/div;
Ch4: I_{OUT} , 200mA/div)

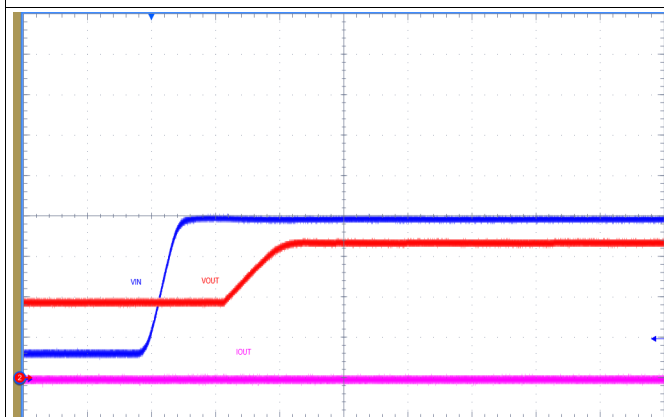


Figure 20. Startup with V_{OUT} Pre-biased to 1.8 V; V_{IN} = 12 V, No Load
(2ms/div, Ch1: V_{IN} , 3V/div; Ch2: V_{OUT} , 1V/div;
Ch4: I_{OUT} , 200mA/div)

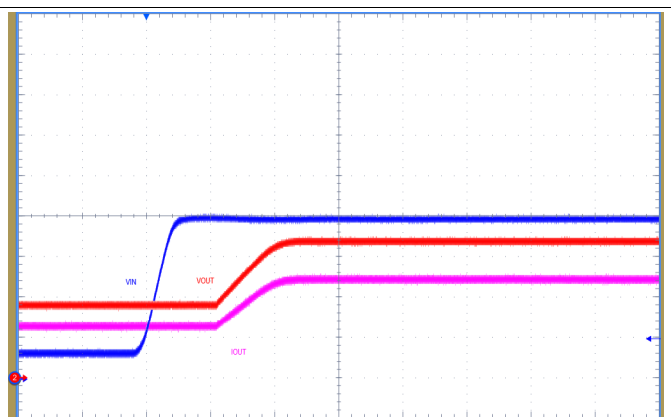


Figure 21. Startup with V_{OUT} Pre-biased to 1.8 V; V_{IN} = 12 V, 500 mA Load
(2ms/div, Ch1: V_{IN} , 3V/div; Ch2: V_{OUT} , 1V/div;
Ch4: I_{OUT} , 200mA/div)

6.3.4 ENABLE On and Off

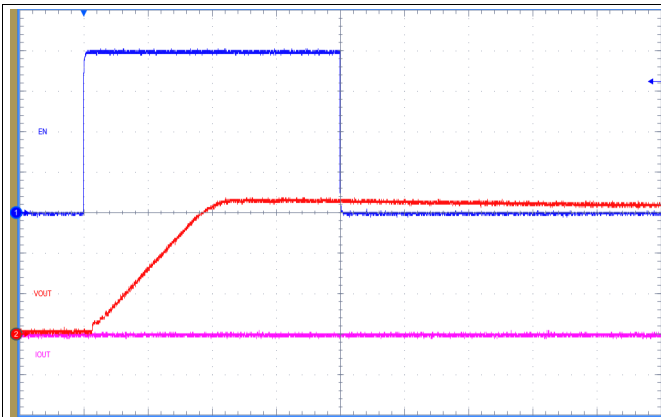


Figure 22. ENABLE On and Off; $V_{IN} = 24\text{ V}$, No Load
(2ms/div, Ch1: V_{EN} , 1V/div; Ch2: V_{OUT} , 1V/div;
Ch4: I_{OUT} , 200mA/div)

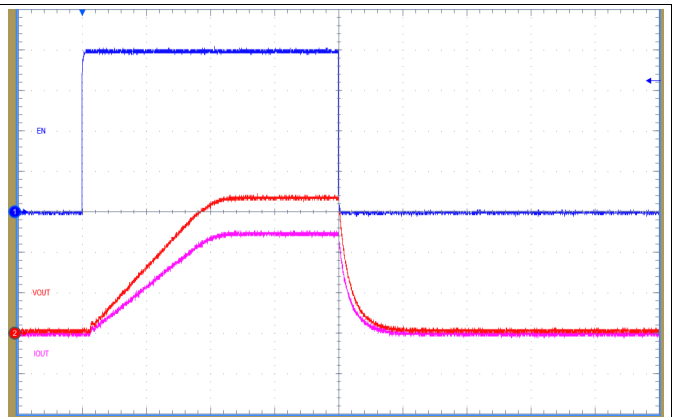


Figure 23. ENABLE On and Off; $V_{IN} = 24\text{ V}$, No Load
(2ms/div, Ch1: V_{EN} , 1V/div; Ch2: V_{OUT} , 1V/div;
Ch4: I_{OUT} , 200mA/div)

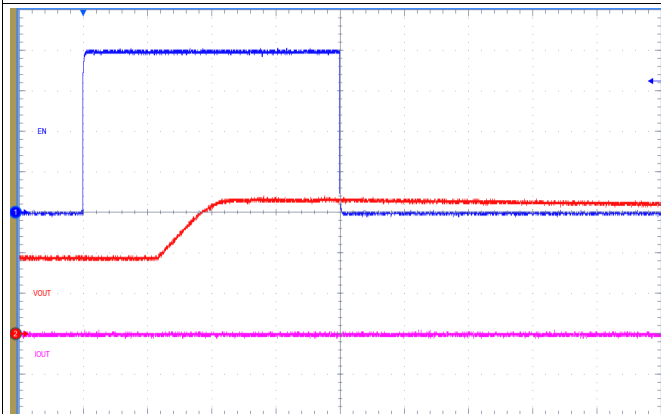


Figure 24. ENABLE On and Off with V_{OUT} Pre-biased to 1.8V; $V_{IN} = 24\text{ V}$, No Load
(2ms/div, Ch1: V_{EN} , 1V/div; Ch2: V_{OUT} , 1V/div;
Ch4: I_{OUT} , 200mA/div)

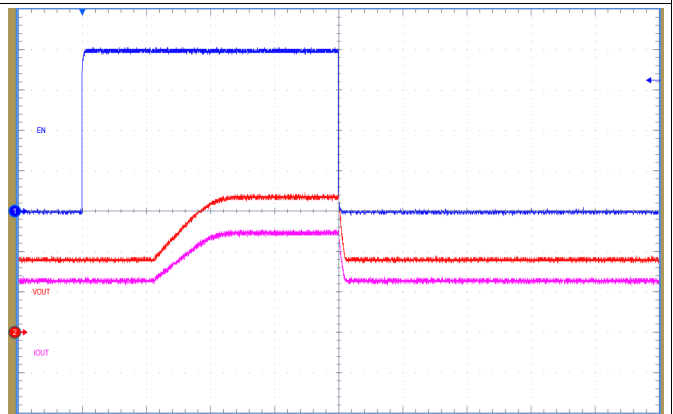


Figure 25. ENABLE On and Off with V_{OUT} Pre-biased to 1.8V; $V_{IN} = 24\text{ V}$, 500 mA Load
(2ms/div, Ch1: V_{EN} , 1V/div; Ch2: V_{OUT} , 1V/div;
Ch4: I_{OUT} , 200mA/div)

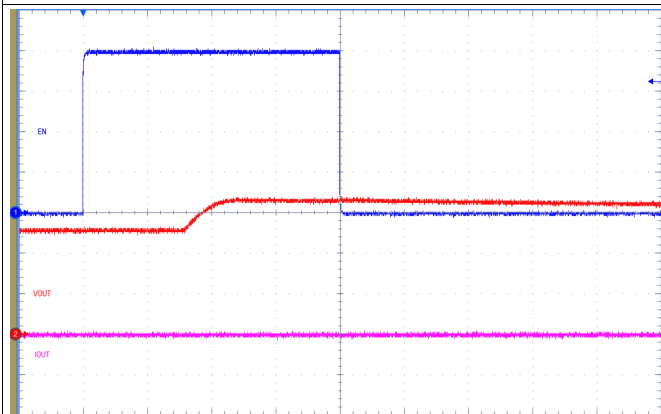


Figure 26. ENABLE On and Off with V_{OUT} Pre-biased to 3.3V; $V_{IN} = 24\text{ V}$, No Load
(2ms/div, Ch1: V_{EN} , 1V/div; Ch2: V_{OUT} , 1V/div;
Ch4: I_{OUT} , 200mA/div)

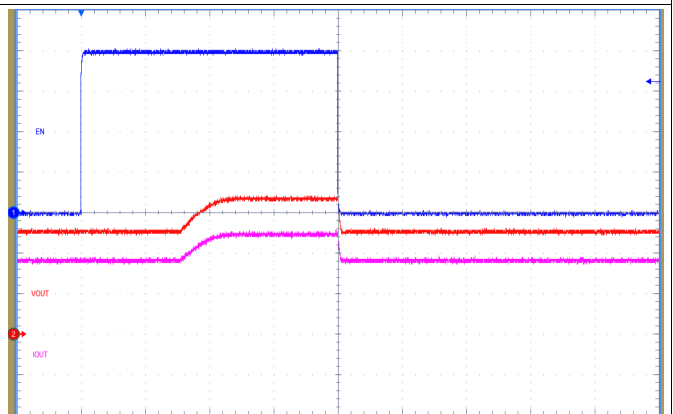


Figure 27. ENABLE On and Off with V_{OUT} Pre-biased to 3.3V; $V_{IN} = 24\text{ V}$, 500 mA Load
(2ms/div, Ch1: V_{EN} , 1V/div; Ch2: V_{OUT} , 1V/div;
Ch4: I_{OUT} , 200mA/div)

6.3.5 Line Transient Response

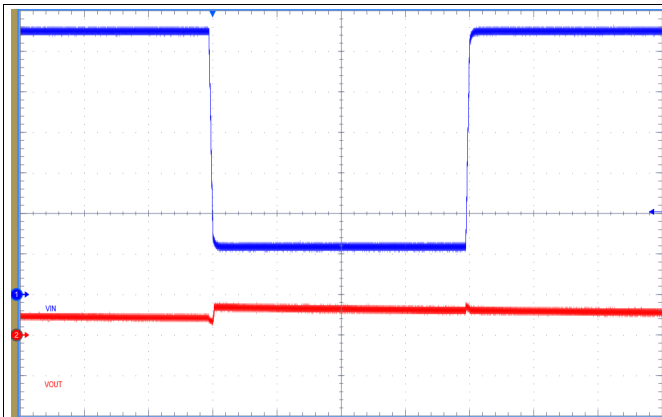


Figure 28. Line Transient Response, No Load
 65 V to 12 V to 65 V at 1 V/μs
 (1ms/div, Ch1: V_{IN}, 10V/div; Ch2: V_{OUT}, 100mV/div)

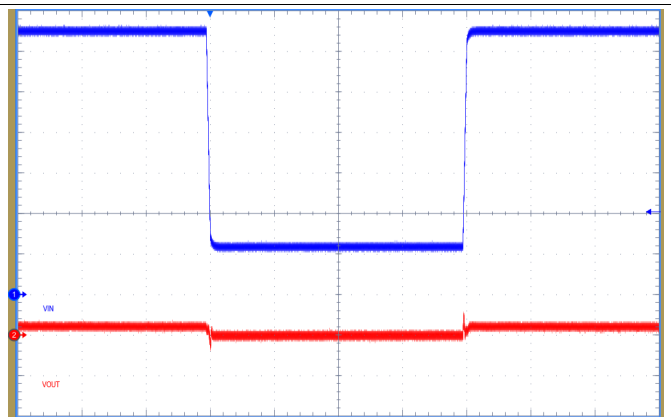


Figure 29. Line Transient Response, 500 mA Load
 65 V to 12 V to 65 V at 1 V/μs
 (1ms/div, Ch1: V_{IN}, 10V/div; Ch2: V_{OUT}, 100mV/div)

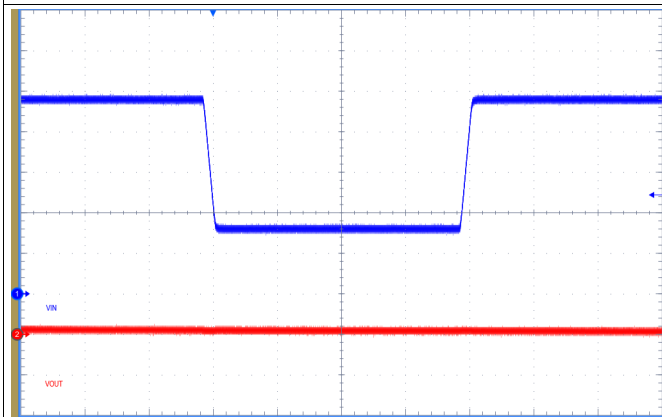


Figure 30. Line Transient Response, No Load
 24 V to 8 V to 24 V at 0.1 V/μs
 (1ms/div, Ch1: V_{IN}, 10V/div; Ch2: V_{OUT}, 100mV/div)

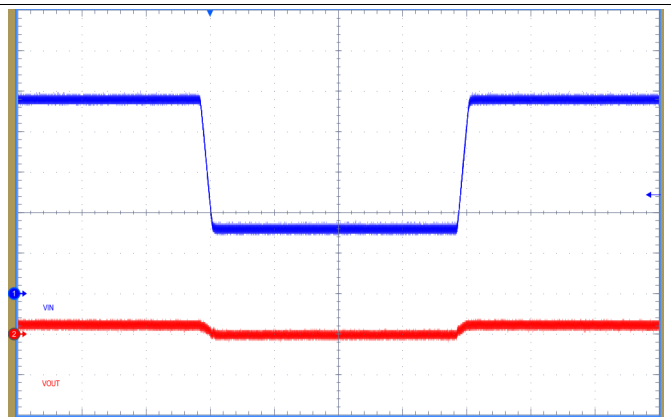


Figure 31. Line Transient Response, 500 mA Load
 24 V to 8 V to 24 V at 0.1 V/μs
 (1ms/div, Ch1: V_{IN}, 10V/div; Ch2: V_{OUT}, 100mV/div)

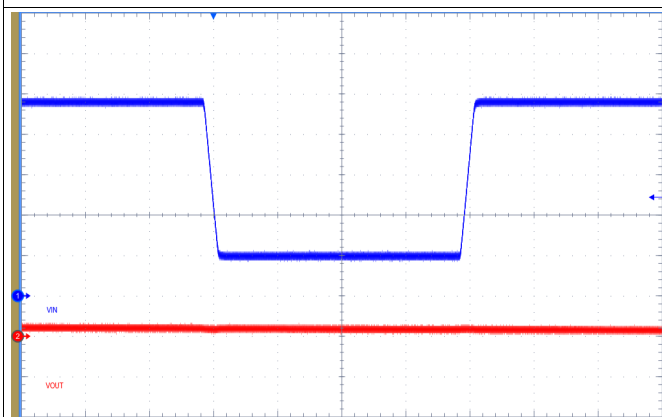


Figure 32. Line Transient Response, No Load
 24 V to 5 V to 24 V at 0.1 V/μs
 (1ms/div, Ch1: V_{IN}, 10V/div; Ch2: V_{OUT}, 100mV/div)

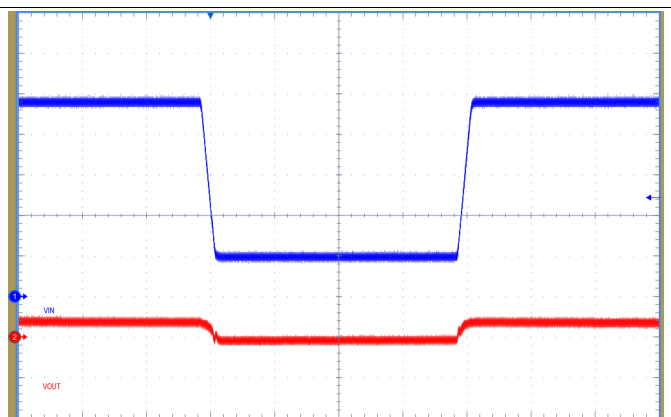


Figure 33. Line Transient Response, 500 mA Load
 24 V to 5 V (Dropout) to 24 V at 0.1 V/μs
 (1ms/div, Ch1: V_{IN}, 10V/div; Ch2: V_{OUT}, 100mV/div)

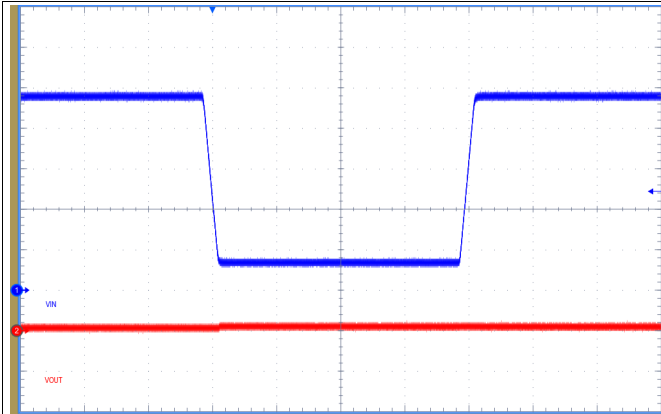


Figure 34. Line Transient Response, No Load
 24 V to 3.5 V to 24 V at 0.1 V/ μ s
 (1ms/div, Ch1: V_{IN}, 10V/div; Ch2: V_{OUT}, 100mV/div)

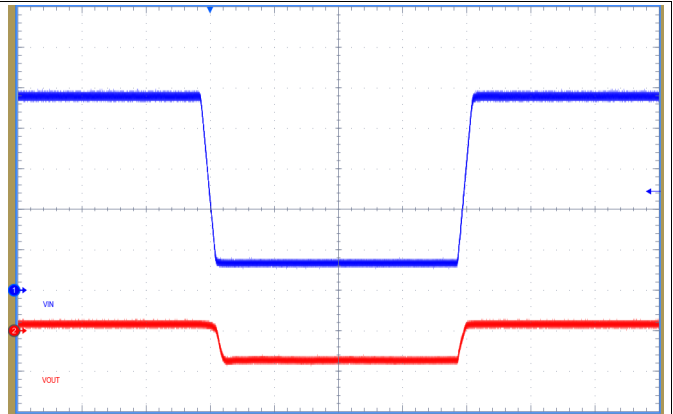


Figure 35. Line Transient Response, 500 mA Load
 24 V to 3.5 V (Dropout) to 24 V at 0.1 V/ μ s
 (1ms/div, Ch1: V_{IN}, 10V/div; Ch2: V_{OUT}, 500mV/div)

6.3.6 Line Transients - Automotive Cold-Crank

Various automotive cold-crank voltage profiles are applied to the input of the LM5166 converter. A cranking condition causes the battery voltage to drop to a low value when the battery is supplying current to an electric starter motor. The test pulses describe the drop of the battery voltage during cranking and subsequent recovery to the nominal operating voltage. Each automotive manufacturer has its own applicable standard.

The test pulses shown in [Figure 36](#) through [Figure 39](#) represent the drop in battery voltage and subsequent recovery. These waveforms are readily generated using the TI [PMP7233](#) automotive cranking simulator design. Please consult the Automotive Cranking Simulator User's Guide [SLVU984](#) for more detail.

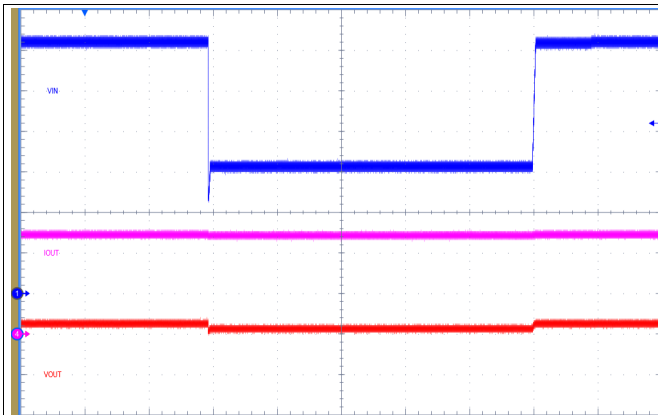


Figure 36. Typical Automotive Cold-Crank VIN Transient, Profile 1, 500 mA Load
(2s/div, Ch1: V_{IN} , 2V/div; Ch2: V_{OUT} , 2V/div;
Ch4: I_{OUT} , 200mA/div)

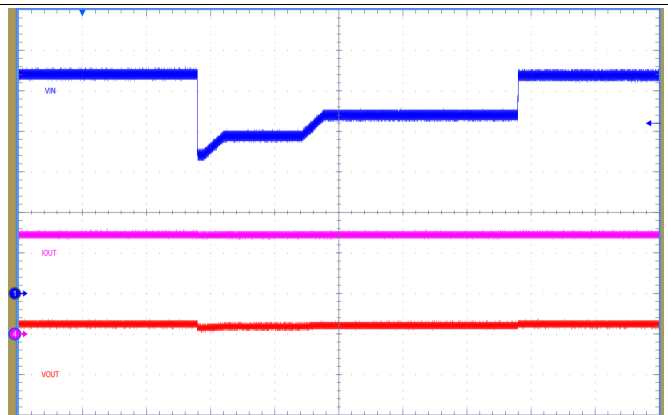


Figure 37. Typical Automotive Cold-Crank VIN Transient, Profile 2, 500 mA Load
(200ms/div, Ch1: V_{IN} , 2V/div; Ch2: V_{OUT} , 2V/div;
Ch4: I_{OUT} , 200mA/div)

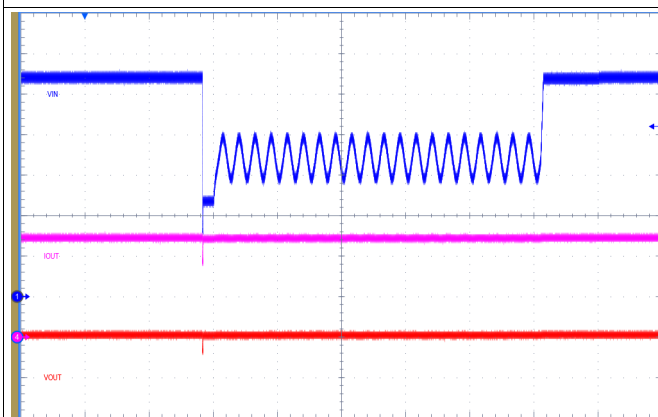


Figure 38. Typical Automotive Cold-Crank VIN Transient, Profile 3, 500 mA Load
(2s/div, Ch1: V_{IN} , 2V/div; Ch2: V_{OUT} , 2V/div;
Ch4: I_{OUT} , 200mA/div)

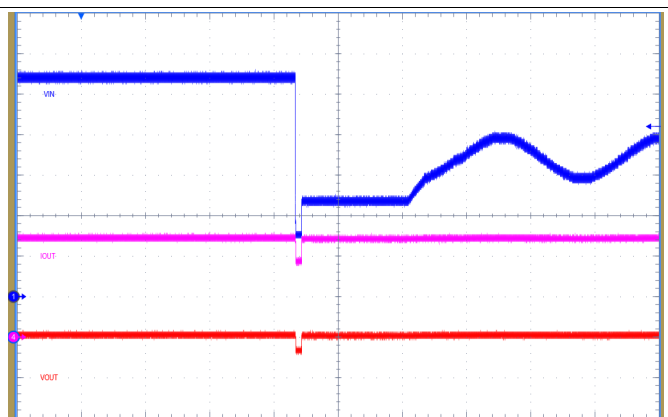


Figure 39. Zoom-in on a Typical Automotive Cold-Crank VIN Transient, Profile 3, 500 mA Load
(200ms/div, Ch1: V_{IN} , 2V/div; Ch2: V_{OUT} , 2V/div;
Ch4: I_{OUT} , 200mA/div)

6.4 EMI Performance - CISPR 25

Figure 41 and Figure 42 represent the LM5166EVM-C33A converter's unfiltered and filtered EMI performance for conducted emissions over a frequency range of 150 kHz to 30 MHz using a 5- μ H LISN according to the CISPR 25 specification. Figure 43 and Figure 40 show the measurement over a frequency range of 30 MHz to 108 MHz. CISPR 25 Class 5 peak and average limits are denoted in red. The yellow and blue spectra are measured using peak and average detection, respectively.

A suitable EMI input filter to meet the specification limits is represented by an LC filter and a damping electrolytic capacitor is shown in Figure 40. The required components are listed in Table 3.

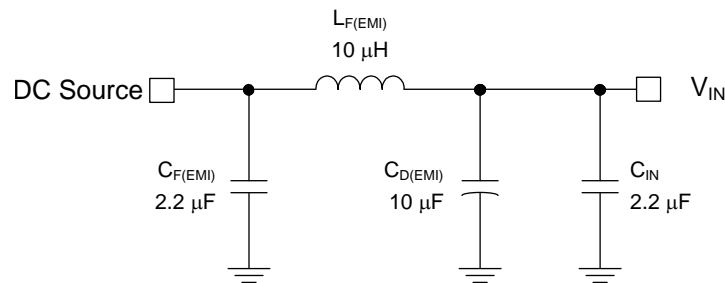


Figure 40. EMI Filter

Table 3. List of Components for EMI Filter ⁽¹⁾

Count	Ref Des	Description	Part Number	MFR
1	C _{F(EMI)}	Capacitor, Ceramic, 2.2 μ F, 100 V, X7R, 10%, 1206	GRM31CR72A225KA73L	Murata
1	C _{D(EMI)}	Capacitor, Electrolytic, 10 μ F, 63 V, 2.2 Ω ESR	EEE-TG1J100P	Panasonic
1	L _{F(EMI)}	Inductor, 10 μ H, 0.136 Ω typ, 0.9 A Isat, 2.4 mm max	VLCF4024T-100MR90-2	TDK

⁽¹⁾ This EMI filter is rated for the maximum input voltage of 42 V.

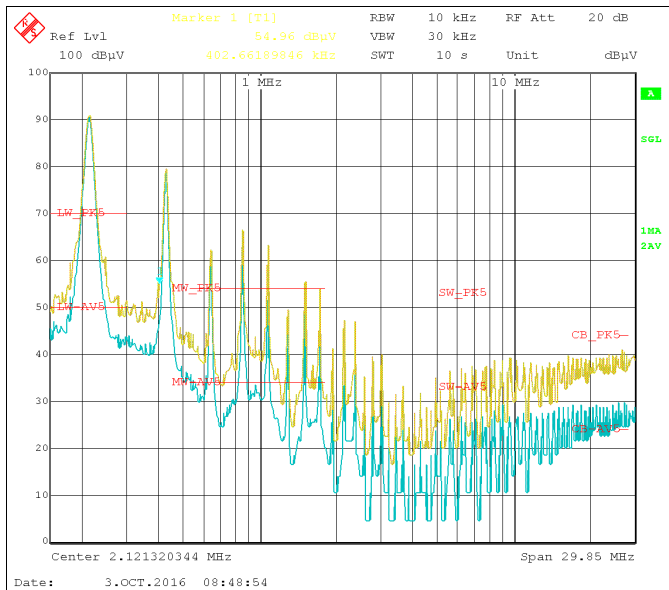


Figure 41. CISPR25 Class 5 Conducted Emissions Plot, 150 kHz to 30 MHz, VIN = 13.5 V, Load = 500 mA, UNFILTERED (Yellow: Peak Detector, Blue: Average Detector)

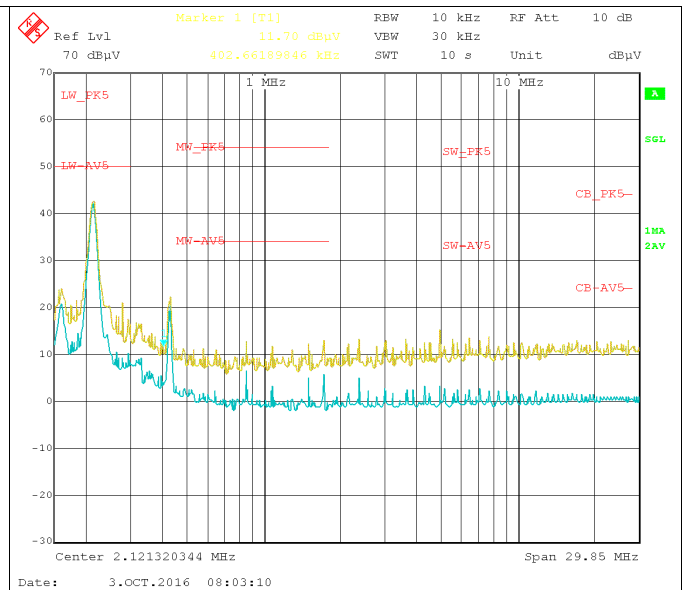


Figure 42. CISPR25 Class 5 Conducted Emissions Plot, 150 kHz to 30 MHz, VIN = 13.5 V, Load = 500 mA, FILTERED (Yellow: Peak Detector, Blue: Average Detector)

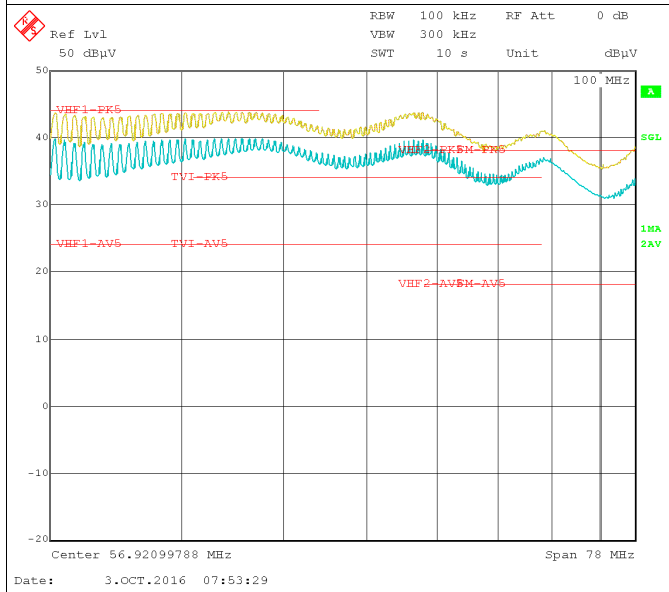


Figure 43. CISPR25 Class 5 Conducted Emissions Plot, 30 MHz to 108 MHz, VIN = 13.5 V, Load = 500 mA, UNFILTERED (Yellow: Peak Detector, Blue: Average Detector)

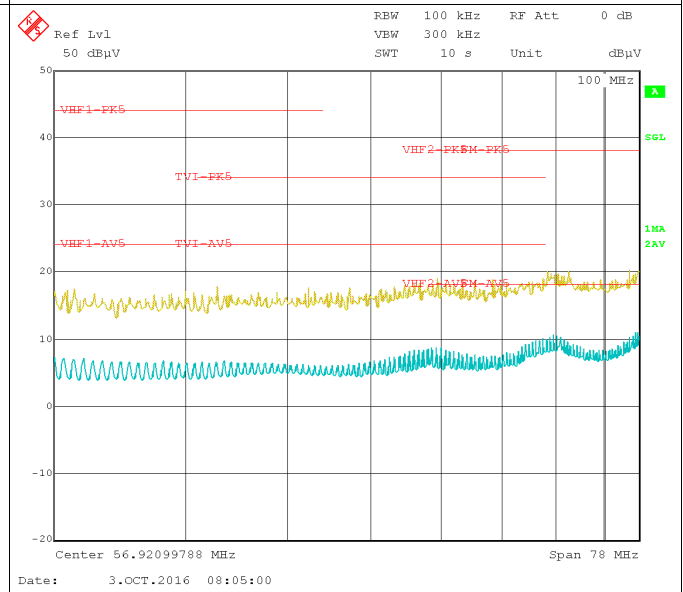


Figure 44. CISPR25 Class 5 Conducted Emissions Plot, 30 MHz to 108 MHz, VIN = 13.5 V, Load = 500 mA, FILTERED (Yellow: Peak Detector, Blue: Average Detector)

7 EVM Documentation

7.1 Converter Schematics

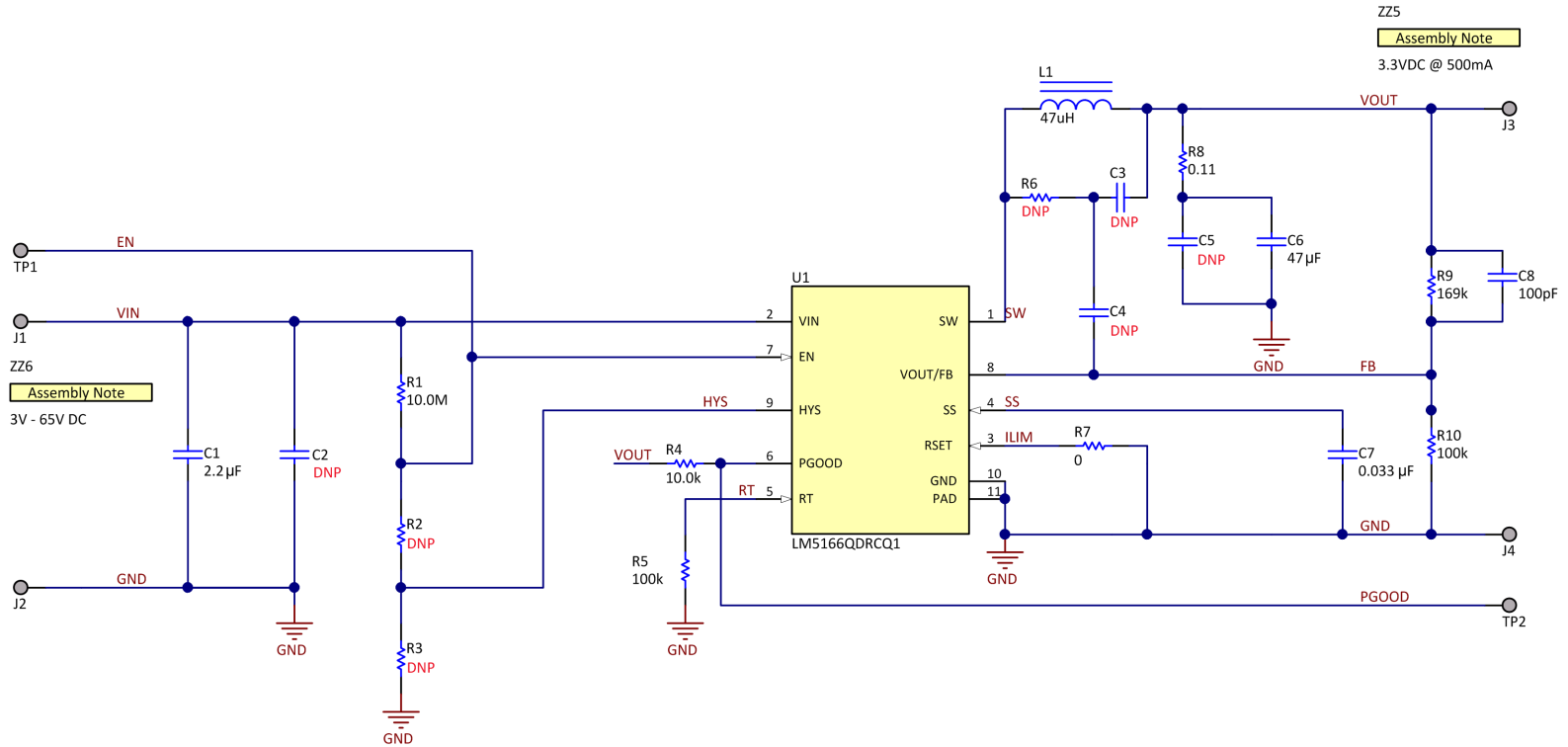


Figure 45. 3.3V, 500mA COT Schematic (Adjustable Output Version)

7.2 PCB Layout

Figure 46 through Figure 51 show the design of the LM5166 4-layer PCB with 1-oz copper thickness. The EVM is a two-sided design, and it includes positions for additional input and output capacitors on the bottom side (if needed).

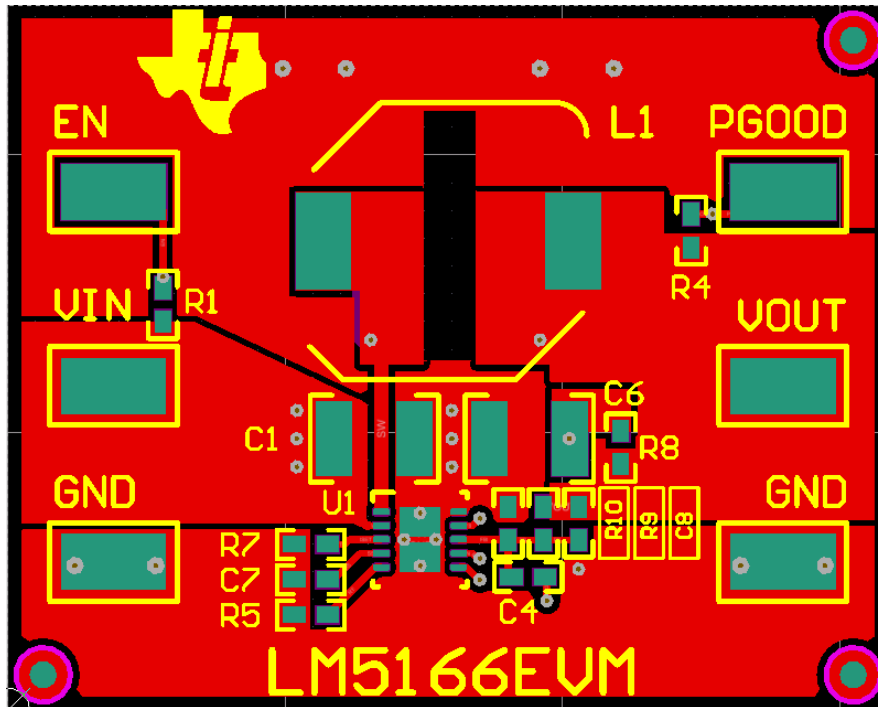


Figure 46. Top Copper (Top View)

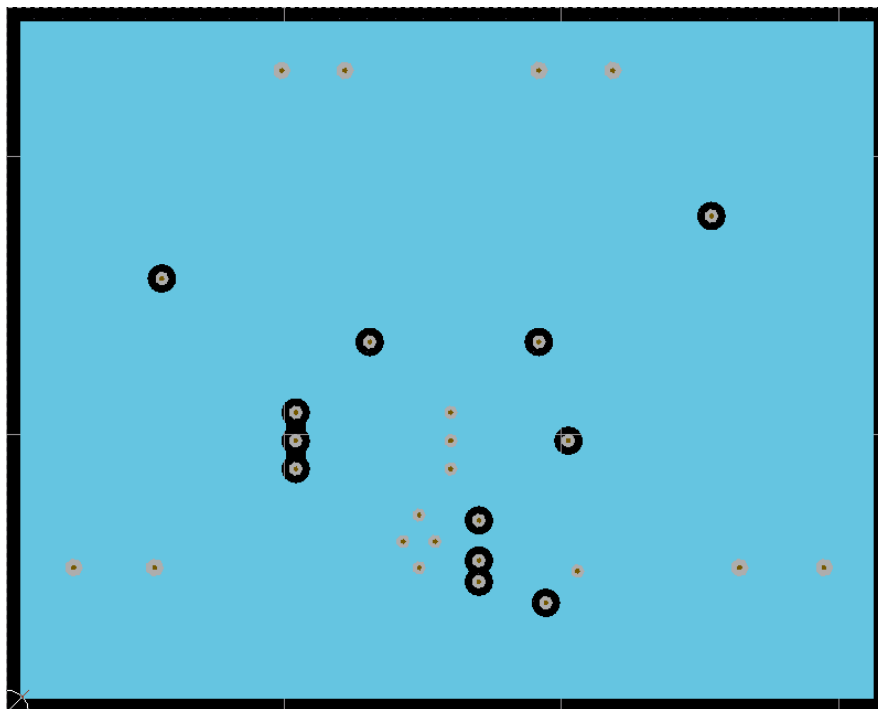


Figure 47. Layer 2 (Top View)

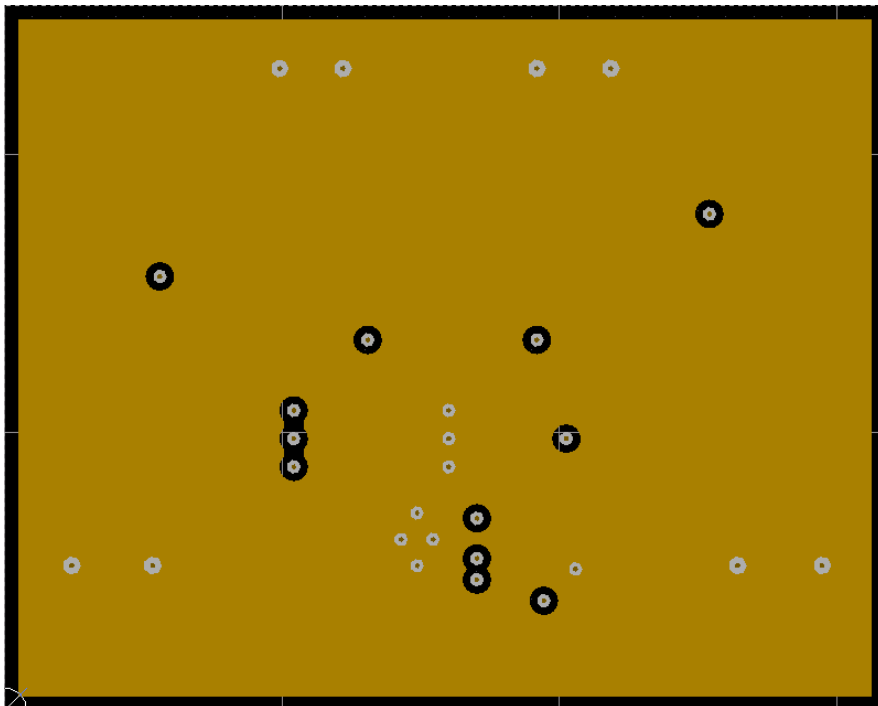


Figure 48. Layer 3 (Top View)

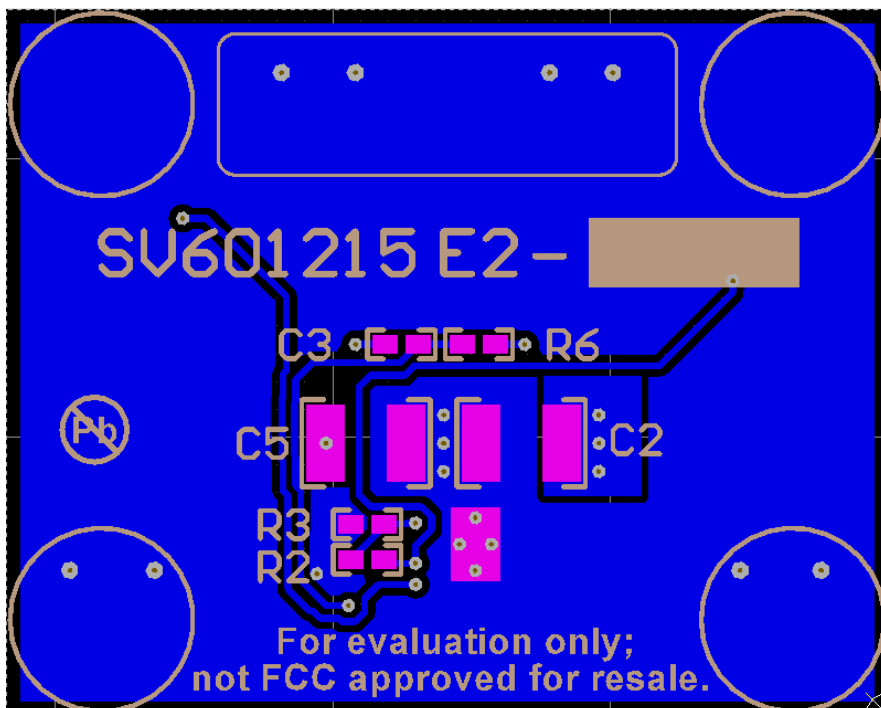


Figure 49. Bottom Copper (Bottom View)

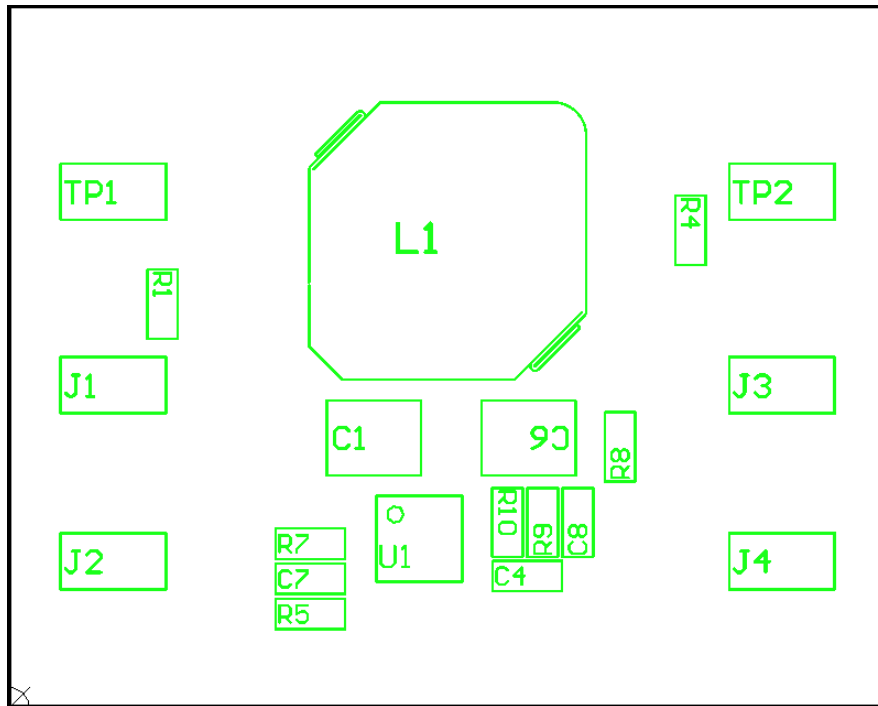


Figure 50. Top Assembly

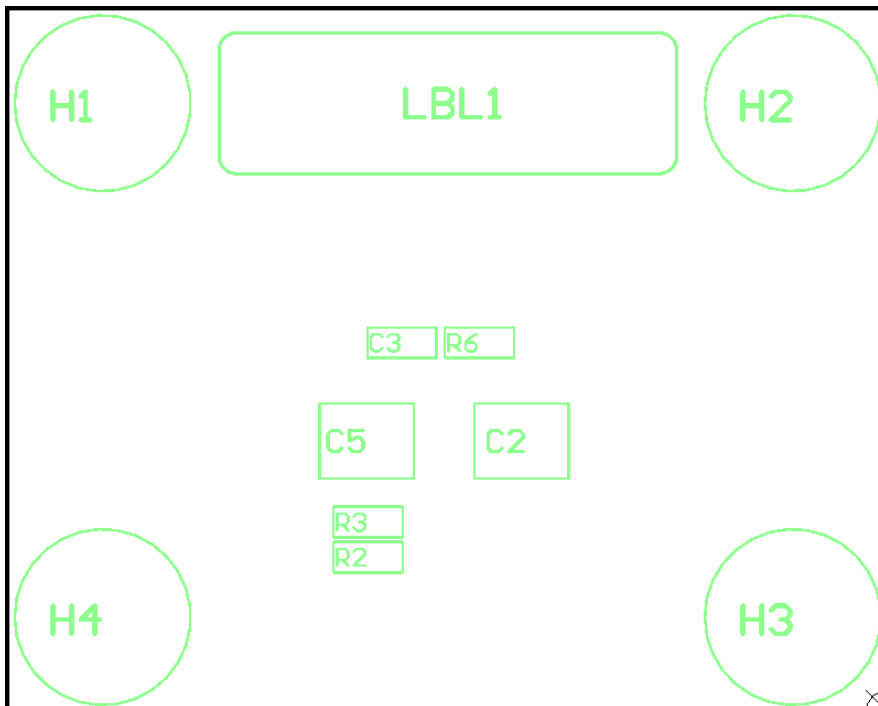


Figure 51. Bottom Assembly

7.3 Bill of Materials

Table 4. Bill of Materials (COT, 3.3 V, 500 mA, Adjustable Output Version)

Count	Ref Des	Description	Part Number	MFR
1	C1	Capacitor, Ceramic, 2.2 μ F, 100V, X7R, 10%, 1210	GRM32ER72A225KA35L	Murata
		Capacitor, Ceramic, 2.2 μ F, 100V, X7R, 10%, 1210, AEC-Q200	CGA6N3X7R2A225K230AB	TDK
2	C5, C6	Capacitor, Ceramic, 47 μ F, 10V, X7R, 10%, 1210	GRM32ER71A476KE15L	Murata
		Capacitor, Ceramic, 47 μ F, 6.3V, X7R, 10%, 1210, AEC-Q200	JMK325B7476KMHTR	Taiyo Yuden
1	C7	Capacitor, Ceramic, 0.033 μ F, 10V, X7R, 10%, 0402	Std	Std
1	C8	Capacitor, Ceramic, 100pF, 50V, X7R, 10%, 0402	Std	Std
1	L1	Inductor, 47 μ H, 0.315 Ω typ, 1.3A Isat, 2.8mm max	74404063470	Würth
		Inductor, 47 μ H, 0.156 Ω max, 0.97A Isat, 4.8mm max, AEC-Q200	CLF6045NIT-470M-D	TDK
		Inductor, 47 μ H, 0.245 Ω max, 1.2A Isat, 3.5mm max	LPS6235-473MR	Coilcraft
1	R1	Resistor, Chip, 10M Ω , 1/16W, 1%, 0402	Std	Std
1	R4	Resistor, Chip, 10k Ω , 1/16W, 1%, 0402	Std	Std
1	R9	Resistor, Chip, 169k Ω , 1/16W, 1%, 0402	Std	Std
1	R7	Resistor, Chip, 0 Ω , 1/16W, 1%, 0402	Std	Std
1	R8	Resistor, Chip, 0.11 Ω , 1/16W, 1%, 0402	Std	Std
2	R5, R10	Resistor, Chip, 100k Ω , 1/16W, 1%, 0402	Std	Std
1	U1	IC, Synchronous Buck Converter, VSON-10, ADJ	LM5166QDRCRQ1	TI
1	PCB1	PCB, FR4, 4 layer, 1 oz, 31.75-mm x 25.4-mm	PCB	–
6	TP1, TP2, J1, J2, J3, J4	Connector, SMT	5019	Keystone

8 Reference Designs

Shown below are several designs that can be realized on the same PCB as that used for the LM5166EVM-C33A Evaluation Module.

8.1 Schematics

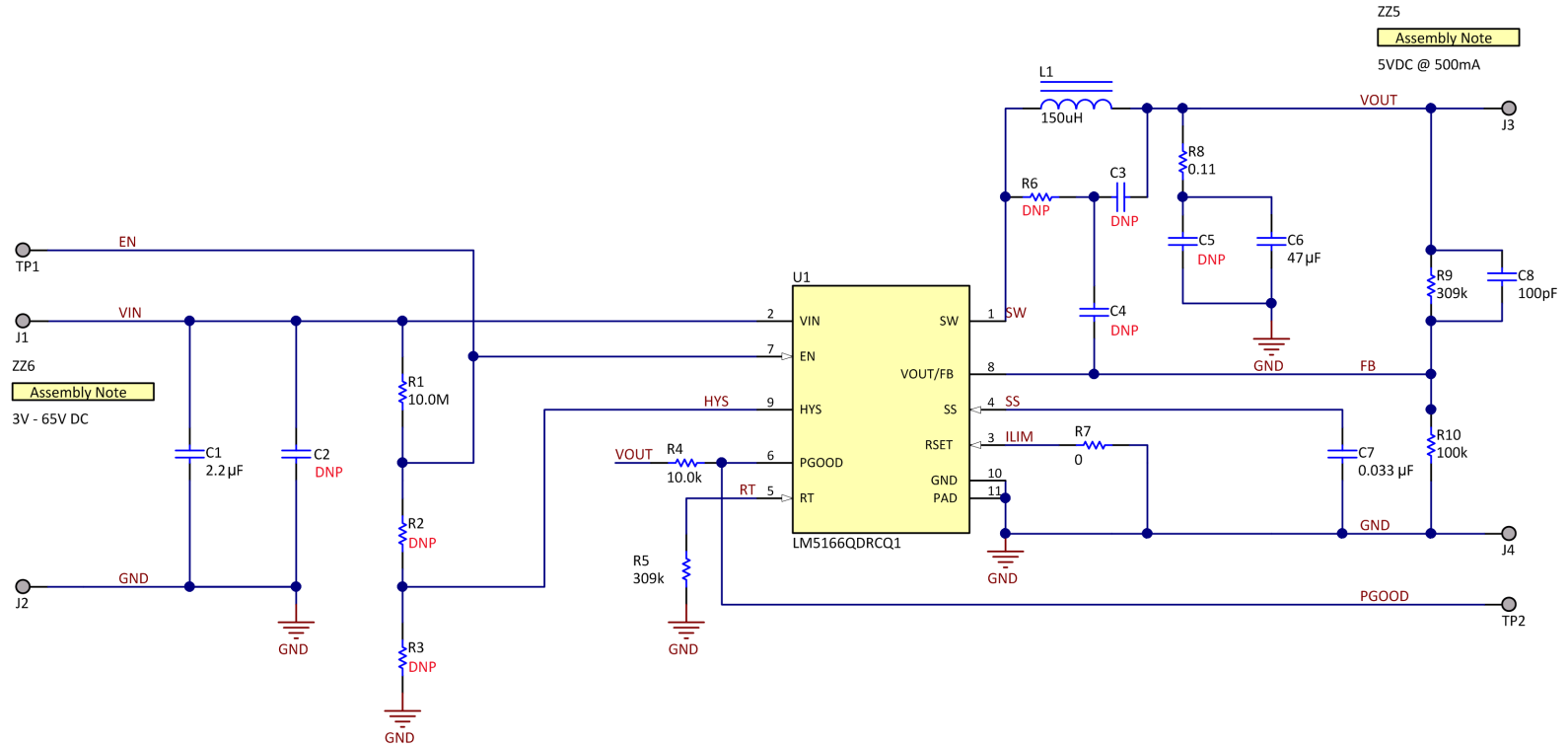


Figure 52. 5V, 500mA COT Schematic (Adjustable Output Version)

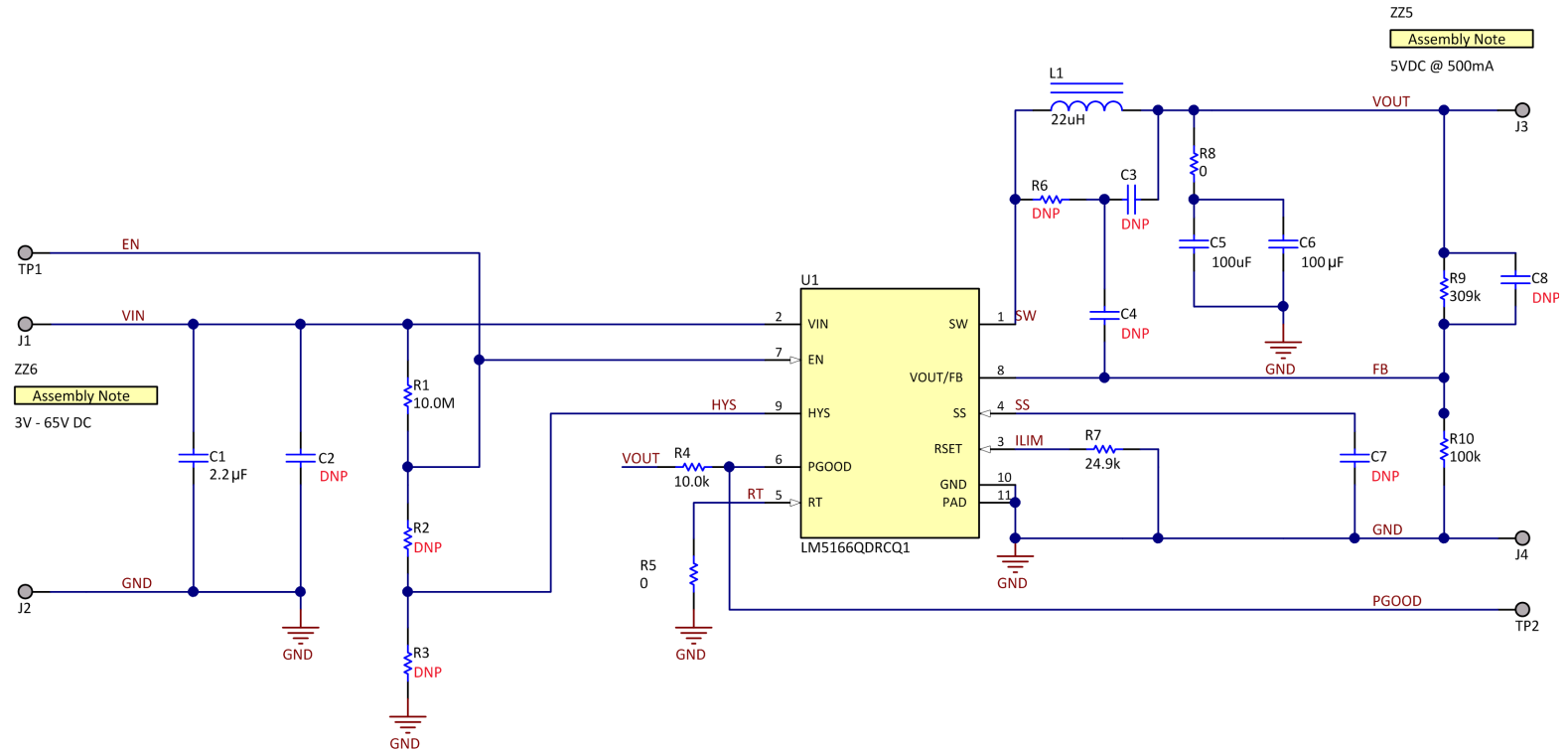


Figure 53. 5V, 500mA PFM Schematic (Adjustable Output Version)

8.2 Bill of Materials - COT Designs

Table 5. Bill of Materials (COT, 5 V, 500 mA, Adjustable Output Version)

Count	Ref Des	Description	Part Number	MFR
1	C1	Capacitor, Ceramic, 2.2 μ F, 100V, X7R, 10%, 1210	GRM32ER72A225KA35L	Murata
		Capacitor, Ceramic, 2.2 μ F, 100V, X7R, 10%, 1210, AEC-Q200	CGA6N3X7R2A225K230AB	TDK
2	C5, C6	Capacitor, Ceramic, 47 μ F, 10V, X7R, 10%, 1210	GRM32ER71A476KE15L	Murata
		Capacitor, Ceramic, 47 μ F, 6.3V, X7R, 10%, 1210, AEC-Q200	JMK325B7476KMHTR	Taiyo Yuden
1	C7	Capacitor, Ceramic, 0.033 μ F, 10V, X7R, 10%, 0402	Std	Std
1	C8	Capacitor, Ceramic, 100pF, 50V, X7R, 10%, 0402	Std	Std
1	L1	Inductor, 150 μ H, 0.240 Ω typ, 1.4A Isat, 5mm max	7447714151	Würth
		Inductor, 150 μ H, 0.285 Ω typ, 1.12A Isat, 5.1mm max	CDRH105RNP-151NC	Sumida
		Inductor, 150 μ H, 0.330 Ω max, 1.16A Isat, 5.1mm max, AEC-Q200	MSS1048T-154KL	Coilcraft
1	R1	Resistor, Chip, 10M Ω , 1/16W, 1%, 0402	Std	Std
1	R4	Resistor, Chip, 10k Ω , 1/16W, 1%, 0402	Std	Std
2	R5, R9	Resistor, Chip, 309k Ω , 1/16W, 1%, 0402	Std	Std
1	R7	Resistor, Chip, 0 Ω , 1/16W, 1%, 0402	Std	Std
1	R8	Resistor, Chip, 0.11 Ω , 1/16W, 1%, 0402	Std	Std
1	R10	Resistor, Chip, 100k Ω , 1/16W, 1%, 0402	Std	Std
1	U1	IC, Synchronous Buck Converter, VSON-10, ADJ	LM5166QDRCRQ1	TI
1	PCB1	PCB, FR4, 4 layer, 1 oz, 31.75-mm x 25.4-mm	PCB	–
6	TP1, TP2, J1, J2, J3, J4	Connector, SMT	5019	Keystone

Table 6. Bill of Materials (COT, 3.3 V, 300 mA, Adjustable Output Version)

Count	Ref Des	Description	Part Number	MFR
1	C1	Capacitor, Ceramic, 2.2 μ F, 100V, X7R, 10%, 1210	GRM32ER72A225KA35L	Murata
		Capacitor, Ceramic, 2.2 μ F, 100V, X7R, 10%, 1210, AEC-Q200	CGA6N3X7R2A225K230AB	TDK
1	C6	Capacitor, Ceramic, 10 μ F, 6.3V, X7R, 10%, 0805	GRM21BR70J106KE76L	Murata
		Capacitor, Ceramic, 10 μ F, 6.3V, X7R, 10%, 0805, AEC-Q200	GCM21BR70J106KE22L	Murata
1	C7	Capacitor, Ceramic, 0.033 μ F, 10V, X7R, 10%, 0402	Std	Std
1	L1	Inductor, 33 μ H, 0.260 Ω max, 0.68A Isat, 3.0mm max, AEC-Q200	SRU5028A-330Y	Bourns
		Inductor, 33 μ H, 0.240 Ω max, 0.62A Isat, 2.8mm max	VLCF5028T-330MR62-2	TDK
		Inductor, 33 μ H, 0.260 Ω max, 0.64A Isat, 3.0mm max	LPS5030-333ML	Coilcraft
1	R1	Resistor, Chip, 10M Ω , 1/16W, 1%, 0402	Std	Std
1	R4	Resistor, Chip, 10k Ω , 1/16W, 1%, 0402	Std	Std
1	R9	Resistor, Chip, 169k Ω , 1/16W, 1%, 0402	Std	Std
1	R5	Resistor, Chip, 49.9k Ω , 1/16W, 1%, 0402	Std	Std
1	R8	Resistor, Chip, 0.3 Ω , 1/16W, 1%, 0402	Std	Std
2	R7, R10	Resistor, Chip, 100k Ω , 1/16W, 1%, 0402	Std	Std
1	U1	IC, Synchronous Buck Converter, VSON-10, ADJ	LM5166QDRCRQ1	TI
1	PCB1	PCB, FR4, 4 layer, 1 oz, 31.75-mm x 25.4-mm	PCB	–
6	TP1, TP2, J1, J2, J3, J4	Connector, SMT	5019	Keystone

8.3 Bill of Materials - PFM Designs

Table 7. Bill of Materials (PFM, 5V, 500 mA, Adjustable Output Version)

Count	Ref Des	Description	Part Number	MFR
1	C1	Capacitor, Ceramic, 2.2 μ F, 100V, X7R, 10%, 1210	GRM32ER72A225KA35L	Murata
		Capacitor, Ceramic, 2.2 μ F, 100V, X7R, 10%, 1210, AEC-Q200	CGA6N3X7R2A225K230AB	TDK
2	C5, C6	Capacitor, Ceramic, 100 μ F, 10V, X5R, 20%, 1210	GRM32ER61A107ME20K	Murata
		Capacitor, Ceramic, 100 μ F, 16V, X5R, 20%, 1210	EMK325ABJ107MM-T	Taiyo Yuden
1	L1	Inductor, 22 μ H, 0.139 Ω typ, 2.0A Isat, 4.5mm max, AEC-Q200	NRS6045T220MMGKV	Taiyo Yuden
		Inductor, 22 μ H, 0.167 Ω typ, 2.0A Isat, 4.8mm max, AEC-Q200	MBH6045C-220MA=P3	Murata
		Inductor, 22 μ H, 0.145 Ω max, 1.7A Isat, 3.5mm max	LPS6235-223MR	Coilcraft
1	R1	Resistor, Chip, 10M Ω , 1/16W, 1%, 0402	Std	Std
1	R4	Resistor, Chip, 10k Ω , 1/16W, 1%, 0402	Std	Std
1	R9	Resistor, Chip, 309k Ω , 1/16W, 1%, 0402	Std	Std
2	R5, R8	Resistor, Chip, 0 Ω , 1/16W, 1%, 0402	Std	Std
1	R7	Resistor, Chip, 24.9k Ω , 1/16W, 1%, 0402	Std	Std
1	R10	Resistor, Chip, 100k Ω , 1/16W, 1%, 0402	Std	Std
1	U1	IC, Synchronous Buck Converter, VSON-10, ADJ	LM5166QDRCRQ1	TI
1	PCB1	PCB, FR4, 4 layer, 1 oz, 31.75-mm x 25.4-mm	PCB	-
6	TP1, TP2, J1, J2, J3, J4	Connector, SMT	5019	Keystone

Table 8. Bill of Materials (PFM, 3.3V, 300 mA, Adjustable Output Version)

Count	Ref Des	Description	Part Number	MFR
1	C1	Capacitor, Ceramic, 2.2 μ F, 100V, X7R, 10%, 1210	GRM32ER72A225KA35L	Murata
		Capacitor, Ceramic, 2.2 μ F, 100V, X7R, 10%, 1210, AEC-Q200	CGA6N3X7R2A225K230AB	TDK
2	C5, C6	Capacitor, Ceramic, 100 μ F, 10V, X5R, 20%, 1210	GRM32ER61A107ME20K	Murata
		Capacitor, Ceramic, 100 μ F, 16V, X5R, 20%, 1210	EMK325ABJ107MM-T	Taiyo Yuden
1	L1	Inductor, 22 μ H, 0.139 Ω typ, 2.0A Isat, 4.5mm max, AEC-Q200	NRS6045T220MMGKV	Taiyo Yuden
		Inductor, 22 μ H, 0.167 Ω typ, 2.0A Isat, 4.8mm max, AEC-Q200	MBH6045C-220MA=P3	Murata
		Inductor, 22 μ H, 0.145 Ω max, 1.7A Isat, 3.5mm max	LPS6235-223MR	Coilcraft
1	R1	Resistor, Chip, 10M Ω , 1/16W, 1%, 0402	Std	Std
1	R4	Resistor, Chip, 10k Ω , 1/16W, 1%, 0402	Std	Std
1	R9	Resistor, Chip, 169k Ω , 1/16W, 1%, 0402	Std	Std
2	R5, R8	Resistor, Chip, 0 Ω , 1/16W, 1%, 0402	Std	Std
1	R7	Resistor, Chip, 56.2k Ω , 1/16W, 1%, 0402	Std	Std
1	R10	Resistor, Chip, 100k Ω , 1/16W, 1%, 0402	Std	Std
1	U1	IC, Synchronous Buck Converter, VSON-10, ADJ	LM5166QDRCRQ1	TI
1	PCB1	PCB, FR4, 4 layer, 1 oz, 31.75-mm x 25.4-mm	PCB	-
6	TP1, TP2, J1, J2, J3, J4	Connector, SMT	5019	Keystone

9 Device Support

9.1 Development Support

- [LM5166 Quick-Start Design Tool](#)
- [TIDesigns](#) Reference Design Library
- [WEBENCH®](#) Designer

9.2 Documentation Support

- [LM5166 Datasheet SNVSA67](#)
- [LM5166-Q1 Datasheet SNVSAO1](#)
- [LM5166EVM-C50A User's Guide SNVU485](#)
- [AN-2162: Simple Success with Conducted EMI from DC-DC Converters SNVA489](#)
- [Automotive Cranking Simulator User's Guide SLVU984](#)
- [Using New Thermal Metrics Application Report SBVA025](#)
- [Semiconductor and IC Package Thermal Metrics SPRA953](#)

STANDARD TERMS AND CONDITIONS FOR EVALUATION MODULES

1. *Delivery:* TI delivers TI evaluation boards, kits, or modules, including demonstration software, components, and/or documentation which may be provided together or separately (collectively, an "EVM" or "EVMs") to the User ("User") in accordance with the terms and conditions set forth herein. Acceptance of the EVM is expressly subject to the following terms and conditions.
 - 1.1 EVMs are intended solely for product or software developers for use in a research and development setting to facilitate feasibility evaluation, experimentation, or scientific analysis of TI semiconductor products. EVMs have no direct function and are not finished products. EVMs shall not be directly or indirectly assembled as a part or subassembly in any finished product. For clarification, any software or software tools provided with the EVM ("Software") shall not be subject to the terms and conditions set forth herein but rather shall be subject to the applicable terms and conditions that accompany such Software
 - 1.2 EVMs are not intended for consumer or household use. EVMs may not be sold, sublicensed, leased, rented, loaned, assigned, or otherwise distributed for commercial purposes by Users, in whole or in part, or used in any finished product or production system.
2. *Limited Warranty and Related Remedies/Disclaimers:*
 - 2.1 These terms and conditions do not apply to Software. The warranty, if any, for Software is covered in the applicable Software License Agreement.
 - 2.2 TI warrants that the TI EVM will conform to TI's published specifications for ninety (90) days after the date TI delivers such EVM to User. Notwithstanding the foregoing, TI shall not be liable for any defects that are caused by neglect, misuse or mistreatment by an entity other than TI, including improper installation or testing, or for any EVMs that have been altered or modified in any way by an entity other than TI. Moreover, TI shall not be liable for any defects that result from User's design, specifications or instructions for such EVMs. Testing and other quality control techniques are used to the extent TI deems necessary or as mandated by government requirements. TI does not test all parameters of each EVM.
 - 2.3 If any EVM fails to conform to the warranty set forth above, TI's sole liability shall be at its option to repair or replace such EVM, or credit User's account for such EVM. TI's liability under this warranty shall be limited to EVMs that are returned during the warranty period to the address designated by TI and that are determined by TI not to conform to such warranty. If TI elects to repair or replace such EVM, TI shall have a reasonable time to repair such EVM or provide replacements. Repaired EVMs shall be warranted for the remainder of the original warranty period. Replaced EVMs shall be warranted for a new full ninety (90) day warranty period.
3. *Regulatory Notices:*
 - 3.1 *United States*
 - 3.1.1 *Notice applicable to EVMs not FCC-Approved:*

This kit is designed to allow product developers to evaluate electronic components, circuitry, or software associated with the kit to determine whether to incorporate such items in a finished product and software developers to write software applications for use with the end product. This kit is not a finished product and when assembled may not be resold or otherwise marketed unless all required FCC equipment authorizations are first obtained. Operation is subject to the condition that this product not cause harmful interference to licensed radio stations and that this product accept harmful interference. Unless the assembled kit is designed to operate under part 15, part 18 or part 95 of this chapter, the operator of the kit must operate under the authority of an FCC license holder or must secure an experimental authorization under part 5 of this chapter.
 - 3.1.2 *For EVMs annotated as FCC – FEDERAL COMMUNICATIONS COMMISSION Part 15 Compliant:*

CAUTION

This device complies with part 15 of the FCC Rules. Operation is subject to the following two conditions: (1) This device may not cause harmful interference, and (2) this device must accept any interference received, including interference that may cause undesired operation.

Changes or modifications not expressly approved by the party responsible for compliance could void the user's authority to operate the equipment.

FCC Interference Statement for Class A EVM devices

NOTE: This equipment has been tested and found to comply with the limits for a Class A digital device, pursuant to part 15 of the FCC Rules. These limits are designed to provide reasonable protection against harmful interference when the equipment is operated in a commercial environment. This equipment generates, uses, and can radiate radio frequency energy and, if not installed and used in accordance with the instruction manual, may cause harmful interference to radio communications. Operation of this equipment in a residential area is likely to cause harmful interference in which case the user will be required to correct the interference at his own expense.

FCC Interference Statement for Class B EVM devices

NOTE: This equipment has been tested and found to comply with the limits for a Class B digital device, pursuant to part 15 of the FCC Rules. These limits are designed to provide reasonable protection against harmful interference in a residential installation. This equipment generates, uses and can radiate radio frequency energy and, if not installed and used in accordance with the instructions, may cause harmful interference to radio communications. However, there is no guarantee that interference will not occur in a particular installation. If this equipment does cause harmful interference to radio or television reception, which can be determined by turning the equipment off and on, the user is encouraged to try to correct the interference by one or more of the following measures:

- Reorient or relocate the receiving antenna.
- Increase the separation between the equipment and receiver.
- Connect the equipment into an outlet on a circuit different from that to which the receiver is connected.
- Consult the dealer or an experienced radio/TV technician for help.

3.2 Canada

3.2.1 For EVMs issued with an Industry Canada Certificate of Conformance to RSS-210

Concerning EVMs Including Radio Transmitters:

This device complies with Industry Canada license-exempt RSS standard(s). Operation is subject to the following two conditions: (1) this device may not cause interference, and (2) this device must accept any interference, including interference that may cause undesired operation of the device.

Concernant les EVMs avec appareils radio:

Le présent appareil est conforme aux CNR d'Industrie Canada applicables aux appareils radio exempts de licence. L'exploitation est autorisée aux deux conditions suivantes: (1) l'appareil ne doit pas produire de brouillage, et (2) l'utilisateur de l'appareil doit accepter tout brouillage radioélectrique subi, même si le brouillage est susceptible d'en compromettre le fonctionnement.

Concerning EVMs Including Detachable Antennas:

Under Industry Canada regulations, this radio transmitter may only operate using an antenna of a type and maximum (or lesser) gain approved for the transmitter by Industry Canada. To reduce potential radio interference to other users, the antenna type and its gain should be so chosen that the equivalent isotropically radiated power (e.i.r.p.) is not more than that necessary for successful communication. This radio transmitter has been approved by Industry Canada to operate with the antenna types listed in the user guide with the maximum permissible gain and required antenna impedance for each antenna type indicated. Antenna types not included in this list, having a gain greater than the maximum gain indicated for that type, are strictly prohibited for use with this device.

Concernant les EVMs avec antennes détachables

Conformément à la réglementation d'Industrie Canada, le présent émetteur radio peut fonctionner avec une antenne d'un type et d'un gain maximal (ou inférieur) approuvé pour l'émetteur par Industrie Canada. Dans le but de réduire les risques de brouillage radioélectrique à l'intention des autres utilisateurs, il faut choisir le type d'antenne et son gain de sorte que la puissance isotrope rayonnée équivalente (p.i.r.e.) ne dépasse pas l'intensité nécessaire à l'établissement d'une communication satisfaisante. Le présent émetteur radio a été approuvé par Industrie Canada pour fonctionner avec les types d'antenne énumérés dans le manuel d'usage et ayant un gain admissible maximal et l'impédance requise pour chaque type d'antenne. Les types d'antenne non inclus dans cette liste, ou dont le gain est supérieur au gain maximal indiqué, sont strictement interdits pour l'exploitation de l'émetteur.

3.3 Japan

3.3.1 *Notice for EVMs delivered in Japan:* Please see http://www.tij.co.jp/llds/ti_ja/general/eStore/notice_01.page 日本国内に輸入される評価用キット、ボードについては、次のところをご覧ください。
http://www.tij.co.jp/llds/ti_ja/general/eStore/notice_01.page

3.3.2 *Notice for Users of EVMs Considered "Radio Frequency Products" in Japan:* EVMs entering Japan may not be certified by TI as conforming to Technical Regulations of Radio Law of Japan.

If User uses EVMs in Japan, not certified to Technical Regulations of Radio Law of Japan, User is required by Radio Law of Japan to follow the instructions below with respect to EVMs:

1. Use EVMs in a shielded room or any other test facility as defined in the notification #173 issued by Ministry of Internal Affairs and Communications on March 28, 2006, based on Sub-section 1.1 of Article 6 of the Ministry's Rule for Enforcement of Radio Law of Japan,
2. Use EVMs only after User obtains the license of Test Radio Station as provided in Radio Law of Japan with respect to EVMs, or
3. Use of EVMs only after User obtains the Technical Regulations Conformity Certification as provided in Radio Law of Japan with respect to EVMs. Also, do not transfer EVMs, unless User gives the same notice above to the transferee. Please note that if User does not follow the instructions above, User will be subject to penalties of Radio Law of Japan.

【無線電波を送信する製品の開発キットをお使いになる際の注意事項】 開発キットの中には技術基準適合証明を受けていないものがあります。技術適合証明を受けていないものご使用に際しては、電波法遵守のため、以下のいずれかの措置を取っていただく必要がありますのでご注意ください。

1. 電波法施行規則第6条第1項第1号に基づく平成18年3月28日総務省告示第173号で定められた電波暗室等の試験設備でご使用いただく。
2. 実験局の免許を取得後ご使用いただく。
3. 技術基準適合証明を取得後ご使用いただく。

なお、本製品は、上記の「ご使用にあたっての注意」を譲渡先、移転先に通知しない限り、譲渡、移転できないものとします。

上記を遵守頂けない場合は、電波法の罰則が適用される可能性があることをご留意ください。日本テキサス・インスツルメンツ株式会社
東京都新宿区西新宿 6 丁目 2 4 番 1 号
西新宿三井ビル

3.3.3 *Notice for EVMs for Power Line Communication:* Please see http://www.tij.co.jp/lstds/ti_ja/general/eStore/notice_02.page
電力線搬送波通信についての開発キットをお使いになる際の注意事項については、次のところをご覧ください。 http://www.tij.co.jp/lstds/ti_ja/general/eStore/notice_02.page

4 *EVM Use Restrictions and Warnings:*

4.1 EVMS ARE NOT FOR USE IN FUNCTIONAL SAFETY AND/OR SAFETY CRITICAL EVALUATIONS, INCLUDING BUT NOT LIMITED TO EVALUATIONS OF LIFE SUPPORT APPLICATIONS.

4.2 User must read and apply the user guide and other available documentation provided by TI regarding the EVM prior to handling or using the EVM, including without limitation any warning or restriction notices. The notices contain important safety information related to, for example, temperatures and voltages.

4.3 *Safety-Related Warnings and Restrictions:*

4.3.1 User shall operate the EVM within TI's recommended specifications and environmental considerations stated in the user guide, other available documentation provided by TI, and any other applicable requirements and employ reasonable and customary safeguards. Exceeding the specified performance ratings and specifications (including but not limited to input and output voltage, current, power, and environmental ranges) for the EVM may cause personal injury or death, or property damage. If there are questions concerning performance ratings and specifications, User should contact a TI field representative prior to connecting interface electronics including input power and intended loads. Any loads applied outside of the specified output range may also result in unintended and/or inaccurate operation and/or possible permanent damage to the EVM and/or interface electronics. Please consult the EVM user guide prior to connecting any load to the EVM output. If there is uncertainty as to the load specification, please contact a TI field representative. During normal operation, even with the inputs and outputs kept within the specified allowable ranges, some circuit components may have elevated case temperatures. These components include but are not limited to linear regulators, switching transistors, pass transistors, current sense resistors, and heat sinks, which can be identified using the information in the associated documentation. When working with the EVM, please be aware that the EVM may become very warm.

4.3.2 EVMs are intended solely for use by technically qualified, professional electronics experts who are familiar with the dangers and application risks associated with handling electrical mechanical components, systems, and subsystems. User assumes all responsibility and liability for proper and safe handling and use of the EVM by User or its employees, affiliates, contractors or designees. User assumes all responsibility and liability to ensure that any interfaces (electronic and/or mechanical) between the EVM and any human body are designed with suitable isolation and means to safely limit accessible leakage currents to minimize the risk of electrical shock hazard. User assumes all responsibility and liability for any improper or unsafe handling or use of the EVM by User or its employees, affiliates, contractors or designees.

4.4 User assumes all responsibility and liability to determine whether the EVM is subject to any applicable international, federal, state, or local laws and regulations related to User's handling and use of the EVM and, if applicable, User assumes all responsibility and liability for compliance in all respects with such laws and regulations. User assumes all responsibility and liability for proper disposal and recycling of the EVM consistent with all applicable international, federal, state, and local requirements.

5. *Accuracy of Information:* To the extent TI provides information on the availability and function of EVMs, TI attempts to be as accurate as possible. However, TI does not warrant the accuracy of EVM descriptions, EVM availability or other information on its websites as accurate, complete, reliable, current, or error-free.

6. *Disclaimers:*

6.1 EXCEPT AS SET FORTH ABOVE, EVMS AND ANY WRITTEN DESIGN MATERIALS PROVIDED WITH THE EVM (AND THE DESIGN OF THE EVM ITSELF) ARE PROVIDED "AS IS" AND "WITH ALL FAULTS." TI DISCLAIMS ALL OTHER WARRANTIES, EXPRESS OR IMPLIED, REGARDING SUCH ITEMS, INCLUDING BUT NOT LIMITED TO ANY IMPLIED WARRANTIES OF MERCHANTABILITY OR FITNESS FOR A PARTICULAR PURPOSE OR NON-INFRINGEMENT OF ANY THIRD PARTY PATENTS, COPYRIGHTS, TRADE SECRETS OR OTHER INTELLECTUAL PROPERTY RIGHTS.

6.2 EXCEPT FOR THE LIMITED RIGHT TO USE THE EVM SET FORTH HEREIN, NOTHING IN THESE TERMS AND CONDITIONS SHALL BE CONSTRUED AS GRANTING OR CONFERRING ANY RIGHTS BY LICENSE, PATENT, OR ANY OTHER INDUSTRIAL OR INTELLECTUAL PROPERTY RIGHT OF TI, ITS SUPPLIERS/LICENSORS OR ANY OTHER THIRD PARTY, TO USE THE EVM IN ANY FINISHED END-USER OR READY-TO-USE FINAL PRODUCT, OR FOR ANY INVENTION, DISCOVERY OR IMPROVEMENT MADE, CONCEIVED OR ACQUIRED PRIOR TO OR AFTER DELIVERY OF THE EVM.

7. *USER'S INDEMNITY OBLIGATIONS AND REPRESENTATIONS.* USER WILL DEFEND, INDEMNIFY AND HOLD TI, ITS LICENSORS AND THEIR REPRESENTATIVES HARMLESS FROM AND AGAINST ANY AND ALL CLAIMS, DAMAGES, LOSSES, EXPENSES, COSTS AND LIABILITIES (COLLECTIVELY, "CLAIMS") ARISING OUT OF OR IN CONNECTION WITH ANY HANDLING OR USE OF THE EVM THAT IS NOT IN ACCORDANCE WITH THESE TERMS AND CONDITIONS. THIS OBLIGATION SHALL APPLY WHETHER CLAIMS ARISE UNDER STATUTE, REGULATION, OR THE LAW OF TORT, CONTRACT OR ANY OTHER LEGAL THEORY, AND EVEN IF THE EVM FAILS TO PERFORM AS DESCRIBED OR EXPECTED.

8. *Limitations on Damages and Liability:*

8.1 *General Limitations.* IN NO EVENT SHALL TI BE LIABLE FOR ANY SPECIAL, COLLATERAL, INDIRECT, PUNITIVE, INCIDENTAL, CONSEQUENTIAL, OR EXEMPLARY DAMAGES IN CONNECTION WITH OR ARISING OUT OF THESE TERMS AND CONDITIONS OR THE USE OF THE EVMS PROVIDED HEREUNDER, REGARDLESS OF WHETHER TI HAS BEEN ADVISED OF THE POSSIBILITY OF SUCH DAMAGES. EXCLUDED DAMAGES INCLUDE, BUT ARE NOT LIMITED TO, COST OF REMOVAL OR REINSTALLATION, ANCILLARY COSTS TO THE PROCUREMENT OF SUBSTITUTE GOODS OR SERVICES, RETESTING, OUTSIDE COMPUTER TIME, LABOR COSTS, LOSS OF GOODWILL, LOSS OF PROFITS, LOSS OF SAVINGS, LOSS OF USE, LOSS OF DATA, OR BUSINESS INTERRUPTION. NO CLAIM, SUIT OR ACTION SHALL BE BROUGHT AGAINST TI MORE THAN ONE YEAR AFTER THE RELATED CAUSE OF ACTION HAS OCCURRED.

8.2 *Specific Limitations.* IN NO EVENT SHALL TI'S AGGREGATE LIABILITY FROM ANY WARRANTY OR OTHER OBLIGATION ARISING OUT OF OR IN CONNECTION WITH THESE TERMS AND CONDITIONS, OR ANY USE OF ANY TI EVM PROVIDED HEREUNDER, EXCEED THE TOTAL AMOUNT PAID TO TI FOR THE PARTICULAR UNITS SOLD UNDER THESE TERMS AND CONDITIONS WITH RESPECT TO WHICH LOSSES OR DAMAGES ARE CLAIMED. THE EXISTENCE OF MORE THAN ONE CLAIM AGAINST THE PARTICULAR UNITS SOLD TO USER UNDER THESE TERMS AND CONDITIONS SHALL NOT ENLARGE OR EXTEND THIS LIMIT.

9. *Return Policy.* Except as otherwise provided, TI does not offer any refunds, returns, or exchanges. Furthermore, no return of EVM(s) will be accepted if the package has been opened and no return of the EVM(s) will be accepted if they are damaged or otherwise not in a resalable condition. If User feels it has been incorrectly charged for the EVM(s) it ordered or that delivery violates the applicable order, User should contact TI. All refunds will be made in full within thirty (30) working days from the return of the components(s), excluding any postage or packaging costs.

10. *Governing Law:* These terms and conditions shall be governed by and interpreted in accordance with the laws of the State of Texas, without reference to conflict-of-laws principles. User agrees that non-exclusive jurisdiction for any dispute arising out of or relating to these terms and conditions lies within courts located in the State of Texas and consents to venue in Dallas County, Texas. Notwithstanding the foregoing, any judgment may be enforced in any United States or foreign court, and TI may seek injunctive relief in any United States or foreign court.

IMPORTANT NOTICE

Texas Instruments Incorporated and its subsidiaries (TI) reserve the right to make corrections, enhancements, improvements and other changes to its semiconductor products and services per JESD46, latest issue, and to discontinue any product or service per JESD48, latest issue. Buyers should obtain the latest relevant information before placing orders and should verify that such information is current and complete. All semiconductor products (also referred to herein as "components") are sold subject to TI's terms and conditions of sale supplied at the time of order acknowledgment.

TI warrants performance of its components to the specifications applicable at the time of sale, in accordance with the warranty in TI's terms and conditions of sale of semiconductor products. Testing and other quality control techniques are used to the extent TI deems necessary to support this warranty. Except where mandated by applicable law, testing of all parameters of each component is not necessarily performed.

TI assumes no liability for applications assistance or the design of Buyers' products. Buyers are responsible for their products and applications using TI components. To minimize the risks associated with Buyers' products and applications, Buyers should provide adequate design and operating safeguards.

TI does not warrant or represent that any license, either express or implied, is granted under any patent right, copyright, mask work right, or other intellectual property right relating to any combination, machine, or process in which TI components or services are used. Information published by TI regarding third-party products or services does not constitute a license to use such products or services or a warranty or endorsement thereof. Use of such information may require a license from a third party under the patents or other intellectual property of the third party, or a license from TI under the patents or other intellectual property of TI.

Reproduction of significant portions of TI information in TI data books or data sheets is permissible only if reproduction is without alteration and is accompanied by all associated warranties, conditions, limitations, and notices. TI is not responsible or liable for such altered documentation. Information of third parties may be subject to additional restrictions.

Resale of TI components or services with statements different from or beyond the parameters stated by TI for that component or service voids all express and any implied warranties for the associated TI component or service and is an unfair and deceptive business practice. TI is not responsible or liable for any such statements.

Buyer acknowledges and agrees that it is solely responsible for compliance with all legal, regulatory and safety-related requirements concerning its products, and any use of TI components in its applications, notwithstanding any applications-related information or support that may be provided by TI. Buyer represents and agrees that it has all the necessary expertise to create and implement safeguards which anticipate dangerous consequences of failures, monitor failures and their consequences, lessen the likelihood of failures that might cause harm and take appropriate remedial actions. Buyer will fully indemnify TI and its representatives against any damages arising out of the use of any TI components in safety-critical applications.

In some cases, TI components may be promoted specifically to facilitate safety-related applications. With such components, TI's goal is to help enable customers to design and create their own end-product solutions that meet applicable functional safety standards and requirements. Nonetheless, such components are subject to these terms.

No TI components are authorized for use in FDA Class III (or similar life-critical medical equipment) unless authorized officers of the parties have executed a special agreement specifically governing such use.

Only those TI components which TI has specifically designated as military grade or "enhanced plastic" are designed and intended for use in military/aerospace applications or environments. Buyer acknowledges and agrees that any military or aerospace use of TI components which have **not** been so designated is solely at the Buyer's risk, and that Buyer is solely responsible for compliance with all legal and regulatory requirements in connection with such use.

TI has specifically designated certain components as meeting ISO/TS16949 requirements, mainly for automotive use. In any case of use of non-designated products, TI will not be responsible for any failure to meet ISO/TS16949.

Products

Audio	www.ti.com/audio
Amplifiers	amplifier.ti.com
Data Converters	dataconverter.ti.com
DLP® Products	www.dlp.com
DSP	dsp.ti.com
Clocks and Timers	www.ti.com/clocks
Interface	interface.ti.com
Logic	logic.ti.com
Power Mgmt	power.ti.com
Microcontrollers	microcontroller.ti.com
RFID	www.ti-rfid.com
OMAP Applications Processors	www.ti.com/omap
Wireless Connectivity	www.ti.com/wirelessconnectivity

Applications

Automotive and Transportation	www.ti.com/automotive
Communications and Telecom	www.ti.com/communications
Computers and Peripherals	www.ti.com/computers
Consumer Electronics	www.ti.com/consumer-apps
Energy and Lighting	www.ti.com/energy
Industrial	www.ti.com/industrial
Medical	www.ti.com/medical
Security	www.ti.com/security
Space, Avionics and Defense	www.ti.com/space-avionics-defense
Video and Imaging	www.ti.com/video

TI E2E Community

e2e.ti.com