

LMH2110 8-GHz Logarithmic RMS Power Detector with 45-dB Dynamic Range

1 Features

- Wide Supply Range from 2.7 V to 5 V
- Logarithmic Root Mean Square Response
- 45-dB Linear-in-dB Power Detection Range
- Multi-Band Operation from 50 MHz to 8 GHz
- LOG Conformance Better than ± 0.5 dB
- Highly Temperature Insensitive, ± 0.25 dB
- Modulation Independent Response, 0.08 dB
- Minimal Slope and Intercept Variation
- Shutdown Functionality
- Tiny 6-Bump DSBGA Package

2 Applications

- Multi-Mode, Multi-Band RF Power Control
 - GSM/EDGE
 - CDMA/CDMA2000
 - W-CDMA
 - OFDMA
 - LTE
- Infrastructure RF Power Control

3 Description

The LMH2110 is a 45-dB Logarithmic RMS power detector particularly suited for accurate power measurement of modulated RF signals that exhibit large peak-to-average ratios; that is, large variations of the signal envelope. Such signals are encountered in W-CDMA and LTE cell phones. The RMS measurement topology inherently ensures a modulation insensitive measurement.

The device has an RF frequency range from 50 MHz to 8 GHz. It provides an accurate, temperature and supply insensitive output voltage that relates linearly to the RF input power in dBm. The LMH2110 device has excellent conformance to a logarithmic response, enabling easy integration by using slope and intercept only, reducing calibration effort significantly. The device operates with a single supply from 2.7 V to 5 V. The LMH2110 has an RF power detection range from -40 dBm to 5 dBm and is ideally suited for use in combination with a directional coupler. Alternatively, a resistive divider can be used.

The device is active for EN = High; otherwise, it is in a low power-consumption shutdown mode. To save power and prevent discharge of an external filter capacitance, the output (OUT) is high-impedance during shutdown.

Device Information⁽¹⁾

PART NUMBER	PACKAGE	BODY SIZE (MAX)
LMH2110	DSBGA (6)	1.27 mm x 0.87 mm

(1) For all available packages, see the orderable addendum at the end of the data sheet.

Typical Application Circuit

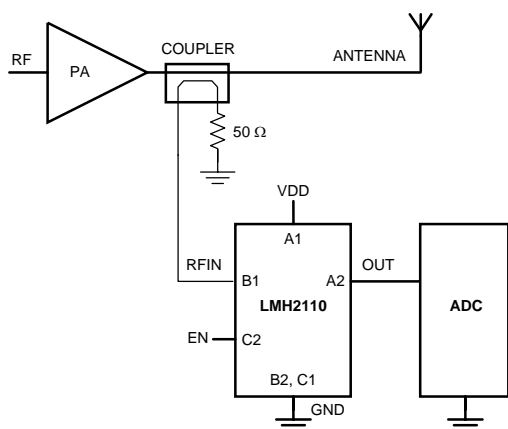

Output Voltage and Log Conformance Error vs. RF Input Power at 1900 MHz

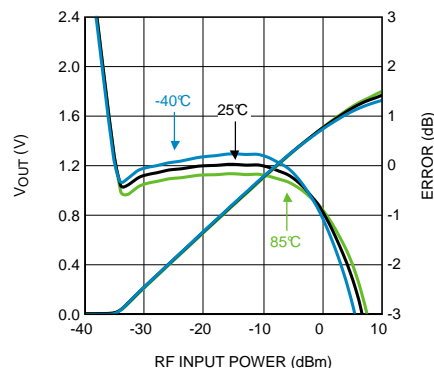

Table of Contents

1 Features 1 2 Applications 1 3 Description 1 4 Revision History 2 5 Pin Configuration and Functions 3 6 Specifications 4 6.1 Absolute Maximum Ratings 4 6.2 ESD Ratings 4 6.3 Recommended Operating Conditions 4 6.4 Thermal Information 4 6.5 2.7-V and 4.5-V DC and AC Electrical Characteristics 5 6.6 Timing Requirements 8 6.7 Typical Characteristics 9 7 Detailed Description 16 7.1 Overview 16 7.2 Functional Block Diagram 16	7.3 Feature Description 16 7.4 Device Functional Modes 20 8 Application and Implementation 21 8.1 Application Information 21 8.2 Typical Applications 21 9 Power Supply Recommendations 29 10 Layout 29 10.1 Layout Guidelines 29 10.2 Layout Example 29 11 Device and Documentation Support 30 11.1 Community Resources 30 11.2 Trademarks 30 11.3 Electrostatic Discharge Caution 30 11.4 Glossary 30 12 Mechanical, Packaging, and Orderable Information 30
--	---

4 Revision History

NOTE: Page numbers for previous revisions may differ from page numbers in the current version.

Changes from Revision C (March 2013) to Revision D	Page
<ul style="list-style-type: none"> • Added <i>Pin Configuration and Functions</i> section, <i>ESD Ratings</i> table, <i>Feature Description</i> section, <i>Device Functional Modes</i>, <i>Application and Implementation</i> section, <i>Power Supply Recommendations</i> section, <i>Layout</i> section, <i>Device and Documentation Support</i> section, and <i>Mechanical, Packaging, and Orderable Information</i> section 1 	1
Changes from Revision B (October 2013) to Revision C	Page
<ul style="list-style-type: none"> • Changed layout of National Data Sheet to TI format 29 	29

5 Pin Configuration and Functions

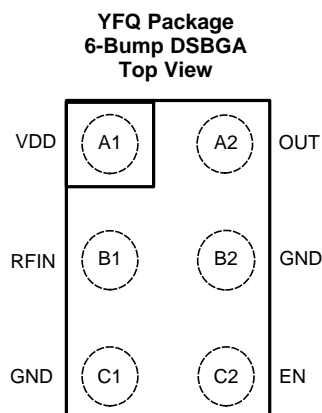

Pin Functions

PIN		TYPE	DESCRIPTION
NUMBER	NAME		
A1	VDD	Power Supply	Positive supply voltage.
A2	OUT	Output	Ground referenced detector output voltage.
B1	RFIN	Analog Input	RF input signal to the detector, internally terminated with 50 Ω .
B2	GND	Power Supply	Power Ground. May be left floating in case grounding is not feasible.
C1	GND	Power Supply	Power Ground.
C2	EN	Logic Input	The device is enabled for EN = High, and in shutdown mode for EN = Low. EN must be < 2.5 V to have low I_{EN} . For EN > 2.5 V, I_{EN} increases slightly, while device is still functional. Absolute maximum rating for EN = 3.6 V.

6 Specifications

6.1 Absolute Maximum Ratings

over operating free-air temperature range (unless otherwise noted)⁽¹⁾⁽²⁾

		MIN	MAX	UNIT
Supply voltage	V _{BAT} – GND		5.5	V
RF input	Input power		12	dBm
	DC voltage		1	V
Enable input voltage		GND – 0.4 < V _{EN} and V _{EN} < Min (V _{DD} – 0.4 V, 3.6 V)		
Junction temperature ⁽³⁾			150	°C
Maximum lead temperature (Soldering, 10 sec)			260	°C
Storage temperature, T _{stg}		–65	150	°C

- Stresses beyond those listed under *Absolute Maximum Ratings* may cause permanent damage to the device. These are stress ratings only, which do not imply functional operation of the device at these or any other conditions beyond those indicated under *Recommended Operating Conditions*. Exposure to absolute-maximum-rated conditions for extended periods may affect device reliability.
- If Military/Aerospace specified devices are required, contact the Texas Instruments Sales Office/ Distributors for availability and specifications.
- The maximum power dissipation is a function of T_{J(MAX)}, R_{θJA}. The maximum allowable power dissipation at any ambient temperature is P_D = (T_{J(MAX)} – T_A)/R_{θJA}. All numbers apply for packages soldered directly into a PC board.

6.2 ESD Ratings

		VALUE	UNIT
V _(ESD)	Electrostatic discharge	Human-body model (HBM), per ANSI/ESDA/JEDEC JS-001 ⁽¹⁾	±2000
		Charged-device model (CDM), per JEDEC specification JESD22-C101 ⁽²⁾	±1000
		Machine Model	±200

- JEDEC document JEP155 states that 500-V HBM allows safe manufacturing with a standard ESD control process.
- JEDEC document JEP157 states that 250-V CDM allows safe manufacturing with a standard ESD control process.

6.3 Recommended Operating Conditions

over operating free-air temperature range (unless otherwise noted)⁽¹⁾

	MIN	MAX	UNIT
Supply voltage	2.7	5	V
Operating temperature	–40	85	°C
RF frequency	50	8000	MHz
RF input power	–40	5	dBm

- Stresses beyond those listed under *Absolute Maximum Ratings* may cause permanent damage to the device. These are stress ratings only, which do not imply functional operation of the device at these or any other conditions beyond those indicated under *Recommended Operating Conditions*. Exposure to absolute-maximum-rated conditions for extended periods may affect device reliability.

6.4 Thermal Information

THERMAL METRIC ⁽¹⁾		LMH2110	UNIT
		YFQ (DSBGA)	
		6 PINS	
R _{θJA}	Junction-to-ambient thermal resistance	133.7	°C/W
R _{θJC(top)}	Junction-to-case (top) thermal resistance	1.7	°C/W
R _{θJB}	Junction-to-board thermal resistance	22.6	°C/W
Ψ _{JT}	Junction-to-top characterization parameter	5.7	°C/W
Ψ _{JB}	Junction-to-board characterization parameter	22.2	°C/W

- For more information about traditional and new thermal metrics, see the *Semiconductor and IC Package Thermal Metrics* application report, [SPRA953](#).

6.5 2.7-V and 4.5-V DC and AC Electrical Characteristics

Unless otherwise specified: all limits are ensured to $T_A = 25^\circ\text{C}$, $V_{\text{BAT}} = 2.7\text{ V}$ and 4.5 V (worst of the 2 is specified), $\text{RF}_{\text{IN}} = 1900\text{ MHz CW}$ (Continuous Wave, unmodulated).⁽¹⁾

PARAMETER		TEST CONDITIONS	MIN ⁽²⁾	TYP ⁽³⁾	MAX ⁽²⁾	UNIT	
SUPPLY INTERFACE							
I_{BAT}	Supply current	Active mode: EN = HIGH, no signal present at RF_{IN}	3.7	4.8	5.5	mA	
		Active mode: EN = HIGH, no signal present at RF_{IN} Limits apply at temperature extremes.	2.9		5.9		
		Shutdown: EN = LOW, no signal present at RF_{IN} .	$V_{\text{BAT}} = 2.7\text{ V}$		3.7	4.7	μA
			$V_{\text{BAT}} = 4.5\text{ V}$		4.6	5.7	
		Shutdown: EN = LOW, no signal present at RF_{IN} . Limits apply at temperature extremes.	$V_{\text{BAT}} = 2.7\text{ V}$			5	μA
			$V_{\text{BAT}} = 4.5\text{ V}$			6.1	
		EN = Low, $\text{RF}_{\text{IN}} = 0\text{ dBm}$, 1900 MHz	$V_{\text{BAT}} = 2.7\text{ V}$		3.5	4.7	μA
$V_{\text{BAT}} = 4.5\text{ V}$			4.6	5.7			
EN = Low, $\text{RF}_{\text{IN}} = 0\text{ dBm}$, 1900 MHz Limits apply at temperature extremes.	$V_{\text{BAT}} = 2.7\text{ V}$			5	μA		
	$V_{\text{BAT}} = 4.5\text{ V}$			6.1			
PSRR	Power Supply Rejection Ratio ⁽⁴⁾	$\text{RF}_{\text{IN}} = -10\text{ dBm}$, 1900 MHz, $2.7\text{ V} < V_{\text{BAT}} < 5\text{ V}$		56		dB	
		$\text{RF}_{\text{IN}} = -10\text{ dBm}$, 1900 MHz, $2.7\text{ V} < V_{\text{BAT}} < 5\text{ V}$ Limits apply at temperature extremes.	45				
LOGIC ENABLE INTERFACE							
V_{LOW}	EN logic low input level (Shutdown mode)	Limits apply at temperature extremes.			0.6	V	
V_{HIGH}	EN logic high input level	Limits apply at temperature extremes.	1.1			V	
I_{EN}	Current into EN pin	Limits apply at temperature extremes.			50	nA	
INPUT/OUTPUT INTERFACE							
R_{IN}	Input resistance		44	50	56	Ω	
V_{OUT}	Minimum output voltage (pedestal)	No input signal		1.5		mV	
		No input signal, limits apply at temperature extremes	0		8		
R_{OUT}	Output impedance	EN = High, $\text{RF}_{\text{IN}} = -10\text{ dBm}$, 1900 MHz, $I_{\text{LOAD}} = 1\text{ mA}$, DC measurement		0.2	2	Ω	
		EN = High, $\text{RF}_{\text{IN}} = -10\text{ dBm}$, 1900 MHz, $I_{\text{LOAD}} = 1\text{ mA}$, DC measurement, limits apply at temperature extremes.			3		
I_{OUT}	Output short circuit current	Sinking, $\text{RF}_{\text{IN}} = -10\text{ dBm}$, OUT connected to 2.5 V	37	42		mA	
		Sinking, $\text{RF}_{\text{IN}} = -10\text{ dBm}$, OUT connected to 2.5 V Limits apply at temperature extremes.	32				
		Sourcing, $\text{RF}_{\text{IN}} = -10\text{ dBm}$, OUT connected to GND	40	46			
		Sourcing, $\text{RF}_{\text{IN}} = -10\text{ dBm}$, OUT connected to GND Limits apply at temperature extremes.	34				
$I_{\text{OUT,SD}}$	Output leakage current in shutdown mode	EN = Low, OUT connected to 2 V Limits apply at temperature extremes.			50	nA	
e_n	Output referred noise ⁽⁴⁾	$\text{RF}_{\text{IN}} = -10\text{ dBm}$, 1900 MHz, output spectrum at 10 kHz		3		$\mu\text{V}\sqrt{\text{Hz}}$	
V_N	Integrated output referred noise ⁽⁴⁾	Integrated over frequency band 1 kHz – 6.5 kHz, $\text{RF}_{\text{IN}} = -10\text{ dBm}$, 1900 MHz		210		μV_{RMS}	

- (1) [2.7-V and 4.5-V DC and AC Electrical Characteristics](#) values apply only for factory testing conditions at the temperature indicated. Factory testing conditions result in very limited self-heating of the device such that $T_J = T_A$. Parametric performance is not ensured in the [2.7-V and 4.5-V DC and AC Electrical Characteristics](#) under conditions of internal self-heating where $T_J > T_A$.
- (2) All limits are specified by test or statistical analysis.
- (3) Typical values represent the most likely parametric norm as determined at the time of characterization. Actual typical values may vary over time and depend on the application and configuration. The typical values are not tested and are not specified on shipped production material.
- (4) This parameter is specified by design and/or characterization and is not tested in production.

2.7-V and 4.5-V DC and AC Electrical Characteristics (continued)

Unless otherwise specified: all limits are ensured to $T_A = 25^\circ\text{C}$, $V_{\text{BAT}} = 2.7\text{ V}$ and 4.5 V (worst of the 2 is specified),

$\text{RF}_{\text{IN}} = 1900\text{ MHz CW}$ (Continuous Wave, unmodulated).⁽¹⁾

PARAMETER		TEST CONDITIONS	MIN ⁽²⁾	TYP ⁽³⁾	MAX ⁽²⁾	UNIT
RF DETECTOR TRANSFER						
$\text{RF}_{\text{IN}} = 50\text{ MHz}$ (fit range -20 dBm to -10 dBm)⁽⁵⁾						
P_{MIN}	Minimum power level, bottom end of dynamic range	Log conformance error within $\pm 1\text{ dB}$		-39		dBm
P_{MAX}	Maximum power level, top end of dynamic range	Log conformance error within $\pm 1\text{ dB}$		7		dBm
V_{MIN}	Minimum output voltage	At P_{MIN}		3		mV
V_{MAX}	Maximum output voltage	At P_{MAX}		1.96		V
K_{SLOPE}	Logarithmic slope		42.2	44.3	46.4	mV/dB
P_{INT}	Logarithmic Intercept		-38.6	-38.3	-38.0	dBm
DR	Dynamic Range for specified accuracy	$\pm 1\text{-dB}$ Log conformance error (E_{LC})		46		dB
		$\pm 1\text{-dB}$ Log conformance error (E_{LC}) Limits apply at temperature extremes.		45		
		$\pm 3\text{-dB}$ Log Conformance Error (E_{LC})		51		
		$\pm 3\text{-dB}$ Log conformance error (E_{LC}) Limits apply at temperature extremes.		50		
		$\pm 0.5\text{-dB}$ input referred variation over temperature (E_{VOT}), from P_{MIN} Limits apply at temperature extremes.		42		
RF DETECTOR TRANSFER						
$\text{RF}_{\text{IN}} = 900\text{ MHz}$ (fit range -20 dBm to -10 dBm)⁽⁵⁾						
P_{MIN}	Minimum power level, bottom end of dynamic range	Log conformance error within $\pm 1\text{ dB}$		-38		dBm
P_{MAX}	Maximum power level, top end of dynamic range	Log conformance error within $\pm 1\text{ dB}$		0		dBm
V_{MIN}	Minimum output voltage	At P_{MIN}		3		mV
V_{MAX}	Maximum output voltage	At P_{MAX}		1.58		V
K_{SLOPE}	Logarithmic slope		41.8	43.9	46	mV/dB
P_{INT}	Logarithmic intercept		-37.4	-37	-36.7	dBm
DR	Dynamic range for specified accuracy	$\pm 1\text{-dB}$ Log conformance error (E_{LC})		38		dB
		$\pm 1\text{-dB}$ Log conformance error (E_{LC}) Limits apply at temperature extremes.		37		
		$\pm 3\text{-dB}$ Log conformance error (E_{LC})		45		
		$\pm 3\text{-dB}$ Log conformance error (E_{LC}) Limits apply at temperature extremes.		44		
		$\pm 0.5\text{-dB}$ Input referred variation over temperature (E_{VOT}), from P_{MIN} Limits apply at temperature extremes.		44		
		$\pm 0.3\text{-dB}$ Error for a 1dB Step (E1dB STEP)		41		
		$\pm 0.3\text{-dB}$ Error for a 1dB Step (E1dB STEP) Limits apply at temperature extremes.		38		
		$\pm 1\text{-dB}$ Error for a 10dB Step (E10dB 30 STEP) Limits apply at temperature extremes.		32		
E_{MOD}	Input-referred variation due to modulation	W-CDMA Release 6/7/8, $-38\text{ dBm} < \text{RF}_{\text{IN}} < -5\text{ dBm}$		0.08		dB
		LTE, $-38\text{ dBm} < \text{RF}_{\text{IN}} < -5\text{ dBm}$		0.19		

(5) All limits are specified by design and measurements which are performed on a limited number of samples. Limits represent the mean $\pm 3\text{-sigma}$ values. The typical value represents the statistical mean value.

2.7-V and 4.5-V DC and AC Electrical Characteristics (continued)

Unless otherwise specified: all limits are ensured to $T_A = 25^\circ\text{C}$, $V_{\text{BAT}} = 2.7\text{ V}$ and 4.5 V (worst of the 2 is specified),

$\text{RF}_{\text{IN}} = 1900\text{ MHz CW}$ (Continuous Wave, unmodulated).⁽¹⁾

PARAMETER		TEST CONDITIONS	MIN ⁽²⁾	TYP ⁽³⁾	MAX ⁽²⁾	UNIT
RF DETECTOR TRANSFER						
$\text{RF}_{\text{IN}} = 1900\text{ MHz}$ (fit range -20 dBm to -10 dBm)⁽⁵⁾						
P_{MIN}	Minimum power level, bottom end of dynamic range	Log conformance error within $\pm 1\text{ dB}$		-36		dBm
P_{MAX}	Maximum power level, top end of dynamic range	Log conformance error within $\pm 1\text{ dB}$		0		dBm
V_{MIN}	Minimum output voltage	At P_{MIN}		3		mV
V_{MAX}	Maximum output voltage	At P_{MAX}		1.5		V
K_{SLOPE}	Logarithmic slope		41.8	43.9	46.1	mV/dB
P_{INT}	Logarithmic Intercept		-35.5	-35.1	-34.7	dBm
DR	Dynamic range for specified accuracy	$\pm 1\text{-dB}$ Log conformance error (E_{LC}) Limits apply at temperature extremes.		36		dB
		$\pm 3\text{-dB}$ Log conformance Error (E_{LC})		45		
		$\pm 3\text{-dB}$ Log conformance error (E_{LC}) Limits apply at temperature extremes.		43		
		$\pm 0.5\text{-dB}$ Input referred variation over temperature (E_{VOT}), from P_{MIN} Limits apply at temperature extremes.		41		
		$\pm 0.3\text{-dB}$ error for a 1-dB Step (E1dB STEP)		40		
		$\pm 0.3\text{-dB}$ error for a 1-dB Step (E1dB STEP) Limits apply at temperature extremes.		38		
		$\pm 1\text{-dB}$ error for a 10-dB Step (E10-dB 30 STEP) Limits apply at temperature extremes.		30		
E_{MOD}	Input-referred variation due to modulation	W-CDMA Release 6/7/8, $-38\text{ dBm} < \text{RF}_{\text{IN}} < -5\text{ dBm}$		0.09		dB
		LTE, $-38\text{ dBm} < \text{RF}_{\text{IN}} < -5\text{ dBm}$		0.18		
$\text{RF}_{\text{IN}} = 3500\text{ MHz}$, fit range -15 dBm to -5 dBm)⁽⁵⁾						
P_{MIN}	Minimum power level, bottom end of dynamic range	Log conformance error within $\pm 1\text{ dB}$		-31		dBm
P_{MAX}	Maximum power level, top end of dynamic range	Log conformance error within $\pm 1\text{ dB}$		6		dBm
V_{MIN}	Minimum output voltage	At P_{MIN}		2		mV
V_{MAX}	Maximum output voltage	At P_{MAX}		1.52		V
K_{SLOPE}	Logarithmic slope		41.8	44	46.1	mV/dB
P_{INT}	Logarithmic Intercept		-30.5	-29.7	-28.8	dBm
DR	Dynamic range for specified accuracy	$\pm 1\text{-dB}$ Log conformance error (E_{LC})		37		dB
		$\pm 1\text{-dB}$ Log conformance error (E_{LC}) Limits apply at temperature extremes.		36		
		$\pm 3\text{-dB}$ Log conformance error (E_{LC})		44		
		$\pm 3\text{-dB}$ Log conformance error (E_{LC}) Limits apply at temperature extremes.		42		
		$\pm 0.5\text{-dB}$ Input referred variation over temperature (E_{VOT}), from P_{MIN} Limits apply at temperature extremes.		39		

2.7-V and 4.5-V DC and AC Electrical Characteristics (continued)

Unless otherwise specified: all limits are ensured to $T_A = 25^\circ\text{C}$, $V_{BAT} = 2.7\text{ V}$ and 4.5 V (worst of the 2 is specified),

$RF_{IN} = 1900\text{ MHz CW}$ (Continuous Wave, unmodulated).⁽¹⁾

PARAMETER		TEST CONDITIONS	MIN ⁽²⁾	TYP ⁽³⁾	MAX ⁽²⁾	UNIT
$RF_{IN} = 5800\text{ MHz}$, fit range -20 dBm to 3 dBm⁽⁵⁾						
P_{MIN}	Minimum power level, bottom end of dynamic range	Log conformance error within $\pm 1\text{ dB}$		-22		dBm
P_{MAX}	Maximum power level, top end of dynamic range	Log conformance error within $\pm 1\text{ dB}$		10		dBm
V_{MIN}	Minimum output voltage	At P_{MIN}		3		mV
V_{MAX}	Maximum output voltage	At P_{MAX}		1.34		V
K_{SLOPE}	Logarithmic slope		42.5	44.8	47.1	mV/dB
P_{INT}	Logarithmic Intercept		-22	-21	-19.9	dBm
DR	Dynamic range for specified accuracy	$\pm 1\text{-dB}$ Log conformance error (E_{LC})		32		dB
		$\pm 1\text{-dB}$ Log conformance error (E_{LC}) Limits apply at temperature extremes.		31		
		$\pm 3\text{-dB}$ Log conformance error (E_{LC})		39		
		$\pm 3\text{-dB}$ Log conformance error (E_{LC}) Limits apply at temperature extremes.		37		
		$\pm 0.5\text{-dB}$ Input referred variation over temperature (E_{VOT}), from P_{MIN} Limits apply at temperature extremes.		33		

6.6 Timing Requirements

		MIN	NOM	MAX	UNIT
t_{ON}	Turnon time from shutdown $RF_{IN} = -10\text{ dBm}$, 1900 MHz, EN LOW-HIGH transition to OUT at 90%		15	19	μs
t_R	Rise time ⁽¹⁾ Signal at RF_{IN} from -20 dBm to 0 dBm , 10% to 90%, 1900 MHz		2.2		μs
t_F	Fall time ⁽¹⁾ Signal at RF_{IN} from 0 dBm to -20 dBm , 90% to 10%, 1900 MHz		31		μs

(1) This parameter is specified by design and/or characterization and is not tested in production.

6.7 Typical Characteristics

Unless otherwise specified: $T_A = 25^\circ\text{C}$, $V_{\text{BAT}} = 2.7\text{ V}$, $R_{\text{FIN}} = 1900\text{ MHz CW}$ (Continuous Wave, unmodulated). Specified errors are input referred.

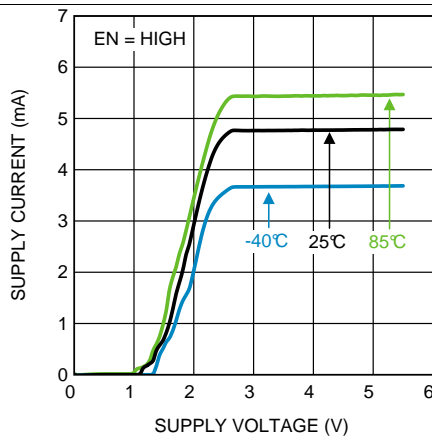

Figure 1. Supply Current vs. Supply Voltage (Active)

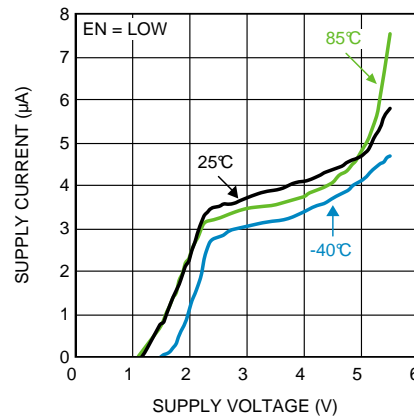

Figure 2. Supply Current vs. Supply Voltage (Shutdown)

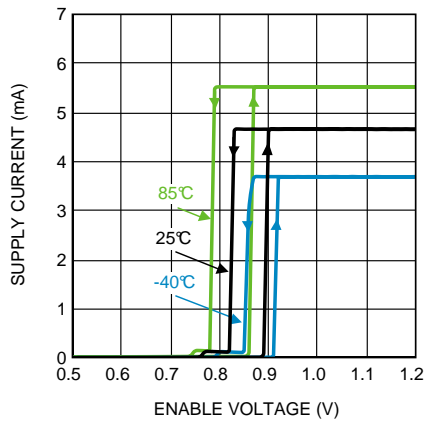

Figure 3. Supply Current vs. Enable Voltage (EN)

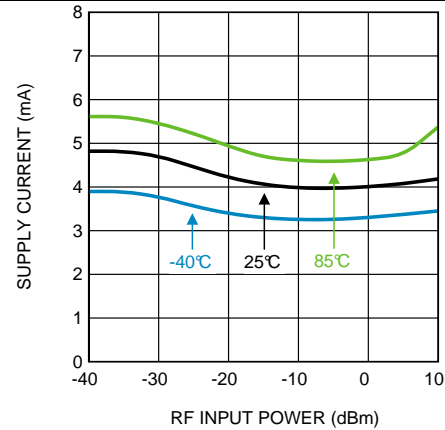

Figure 4. Supply Current vs. RF Input Power

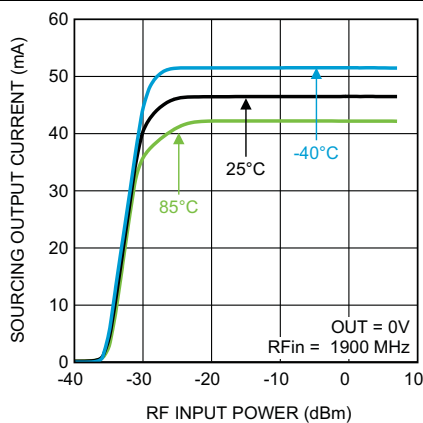

Figure 5. Sourcing Output Current vs. RF Input Power

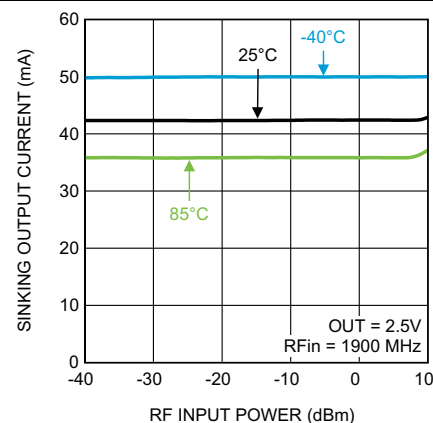

Figure 6. Sinking Output Current vs. RF Input Power

Typical Characteristics (continued)

Unless otherwise specified: $T_A = 25^\circ\text{C}$, $V_{\text{BAT}} = 2.7\text{ V}$, $R_{\text{FIN}} = 1900\text{ MHz CW}$ (Continuous Wave, unmodulated). Specified errors are input referred.

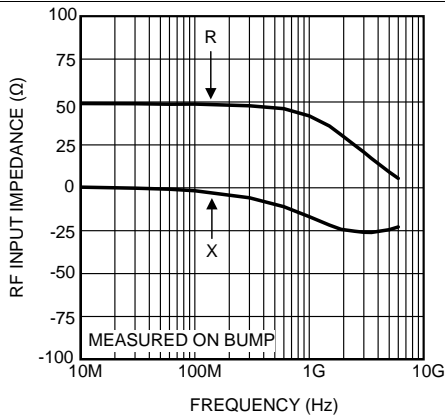

Figure 7. RF Input Impedance vs. Frequency, Resistance (R) and Reactance (X)

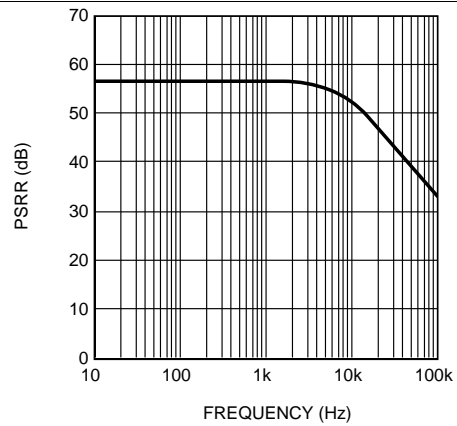

Figure 8. Power Supply Rejection Ratio vs. Frequency

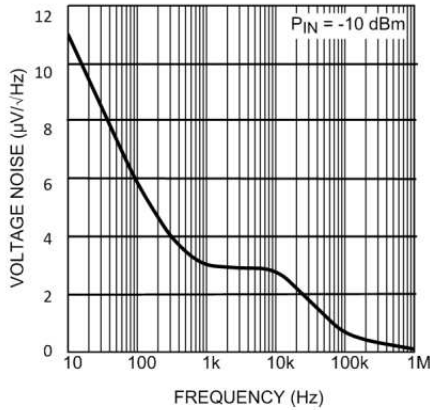

Figure 9. Output Voltage Noise vs. Frequency

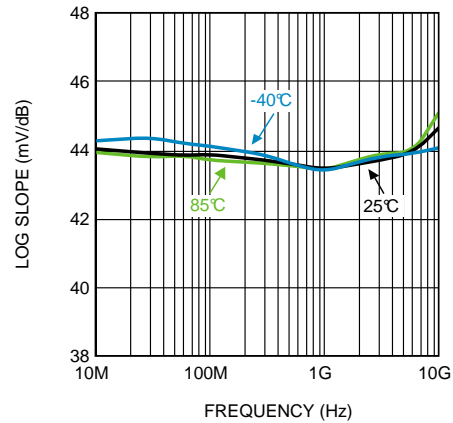

Figure 10. Log Slope vs. Frequency

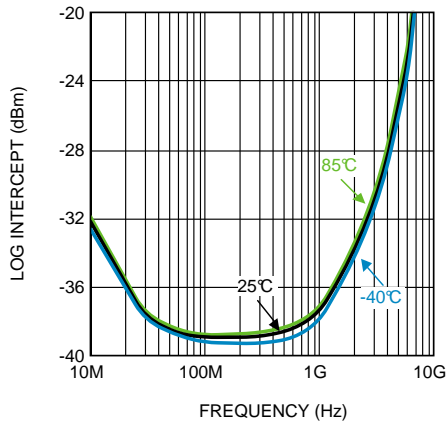

Figure 11. Log Intercept vs. Frequency

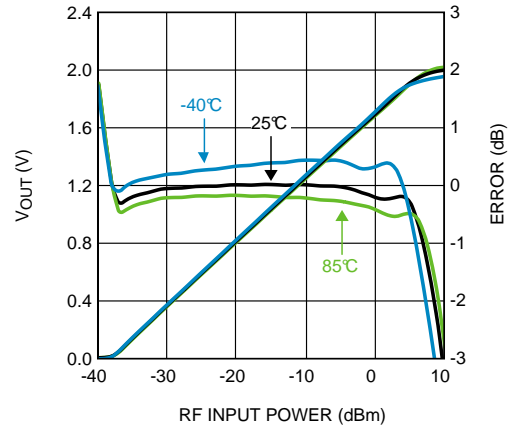

Figure 12. Output Voltage and Log Conformance Error vs. RF Input Power at 50 MHz

Typical Characteristics (continued)

Unless otherwise specified: $T_A = 25^\circ\text{C}$, $V_{\text{BAT}} = 2.7\text{ V}$, $\text{RF}_{\text{IN}} = 1900\text{ MHz CW}$ (Continuous Wave, unmodulated). Specified errors are input referred.

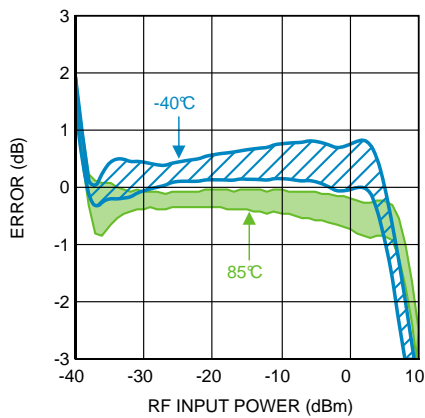

Figure 13. Log Conformance Error (50 Units) vs. RF Input Power at 50 MHz

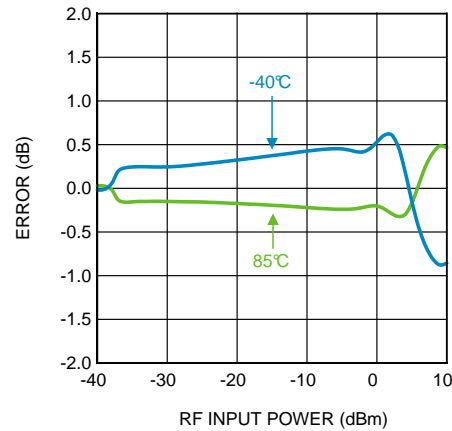

Figure 14. Temperature Variation vs. RF Input Power at 50 MHz

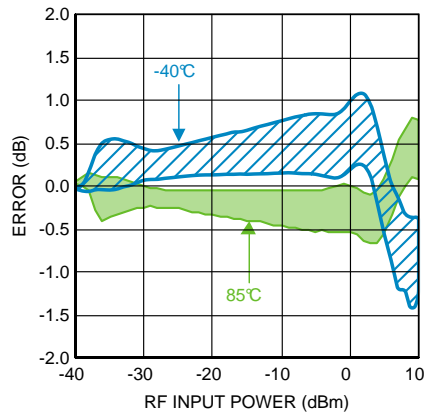

Figure 15. Temperature Variation (50 Units) vs. RF Input Power at 50 MHz

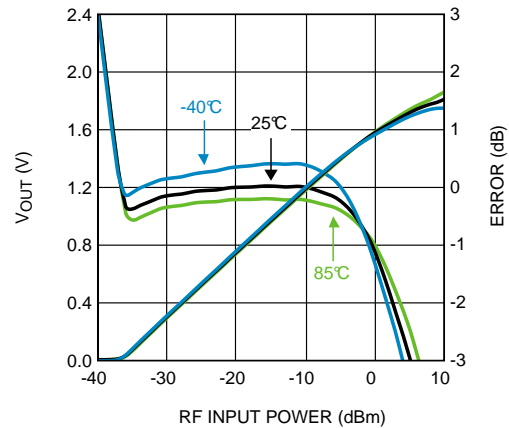

Figure 16. Output Voltage and Log Conformance Error vs. RF Input Power at 900 MHz

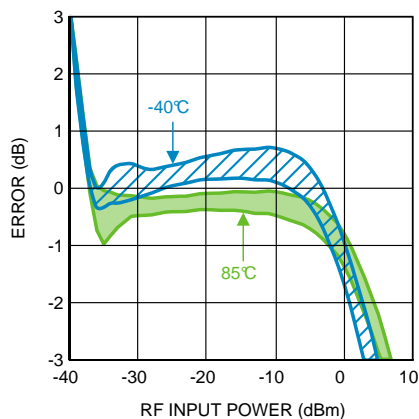

Figure 17. Log Conformance Error (50 Units) vs. RF Input Power at 900 MHz

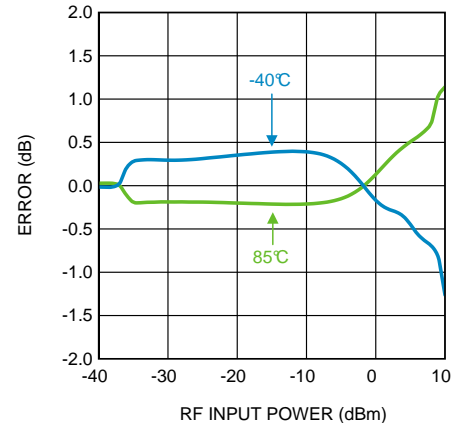

Figure 18. Temperature Variation vs. RF Input Power at 900 MHz

Typical Characteristics (continued)

Unless otherwise specified: $T_A = 25^\circ\text{C}$, $V_{\text{BAT}} = 2.7\text{ V}$, $\text{RF}_{\text{IN}} = 1900\text{ MHz CW}$ (Continuous Wave, unmodulated). Specified errors are input referred.

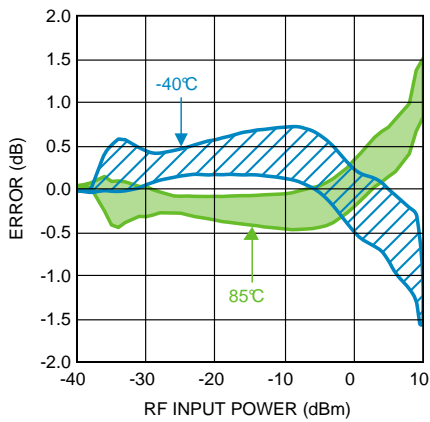

Figure 19. Temperature Variation (50 Units) vs. RF Input Power at 900 MHz

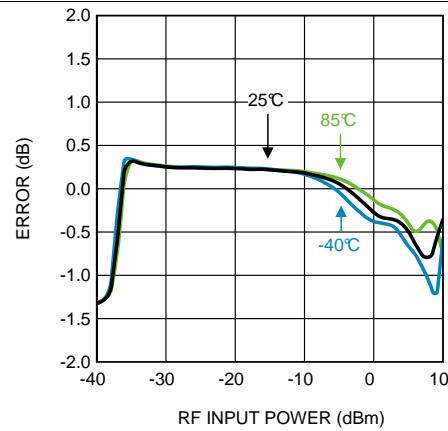

Figure 20. 1-dB Power Step Error vs. RF Input Power at 900 MHz

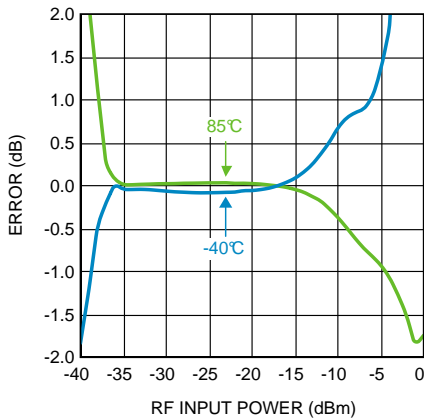

Figure 21. 10 dB Power Step Error vs. RF Input Power at 900 MHz

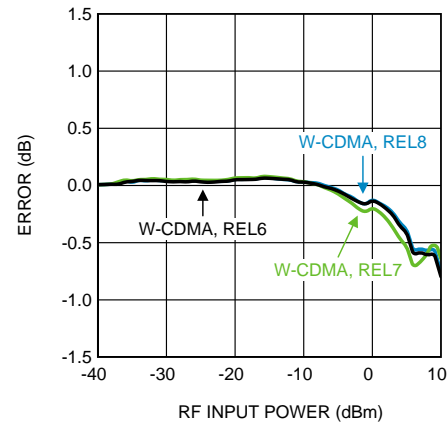

Figure 22. W-CDMA Variation vs. RF Input Power at 900 MHz

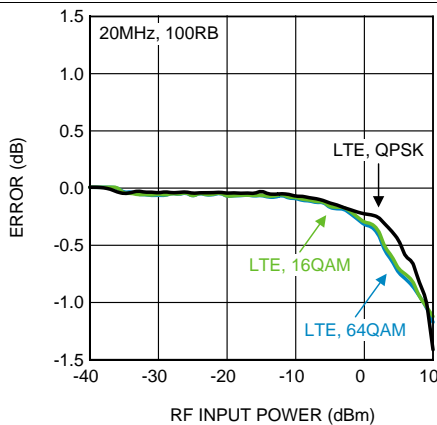

Figure 23. LTE Variation vs. RF Input Power at 900 MHz

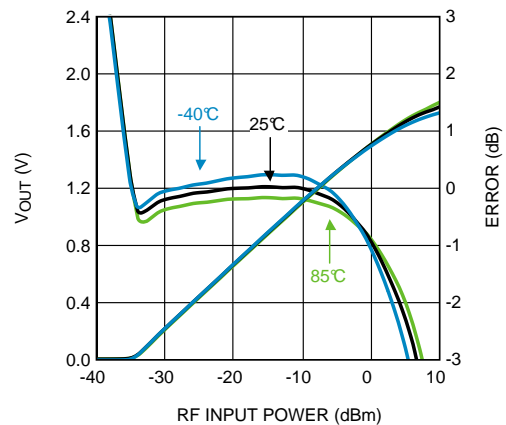

Figure 24. Output Voltage and Log Conformance Error vs. RF Input Power at 1900 MHz

Typical Characteristics (continued)

Unless otherwise specified: $T_A = 25^\circ\text{C}$, $V_{\text{BAT}} = 2.7\text{ V}$, $\text{RF}_{\text{IN}} = 1900\text{ MHz CW}$ (Continuous Wave, unmodulated). Specified errors are input referred.

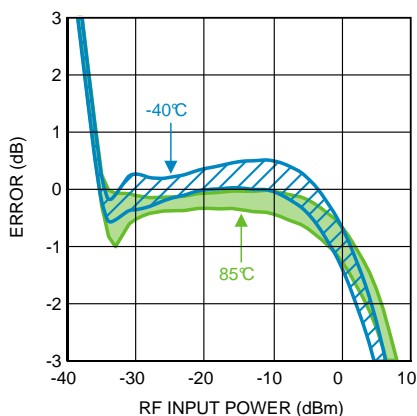

Figure 25. Log Conformance Error (50 Units) vs. RF Input Power at 1900 MHz

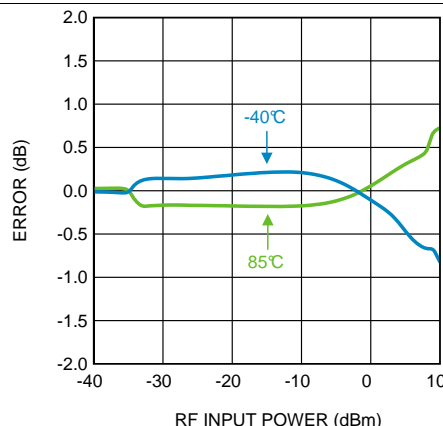

Figure 26. Temperature Variation vs. RF Input Power at 1900 MHz

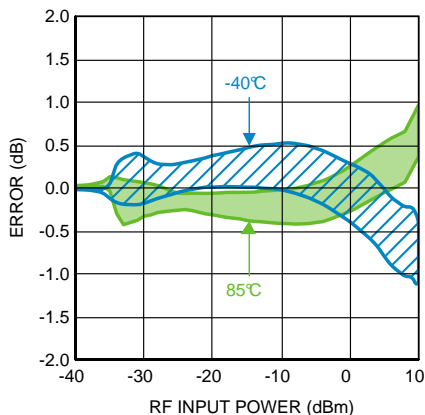

Figure 27. Temperature Variation (50 Units) vs. RF Input Power at 1900 MHz

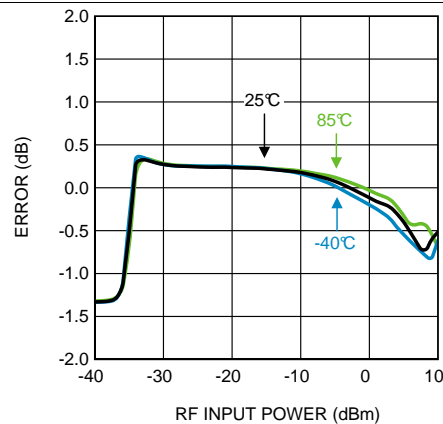

Figure 28. 1-dB Power Step Error vs. RF Input Power at 1900 MHz

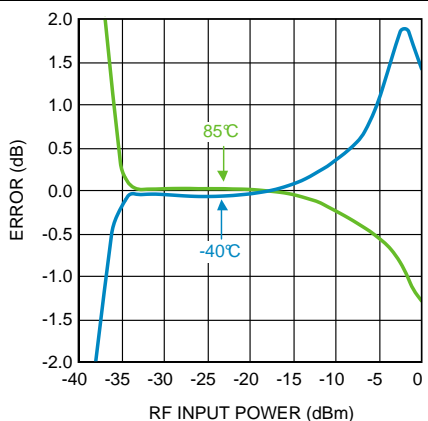

Figure 29. 10-dB Power Step Error vs. RF Input Power at 1900 MHz

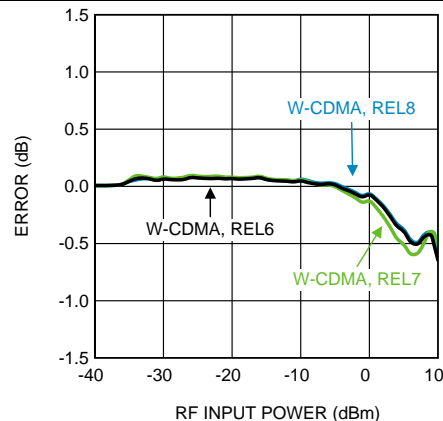

Figure 30. W-CDMA Variation vs. RF Input Power at 1900 MHz

Typical Characteristics (continued)

Unless otherwise specified: $T_A = 25^\circ\text{C}$, $V_{\text{BAT}} = 2.7\text{ V}$, $\text{RF}_{\text{IN}} = 1900\text{ MHz CW}$ (Continuous Wave, unmodulated). Specified errors are input referred.

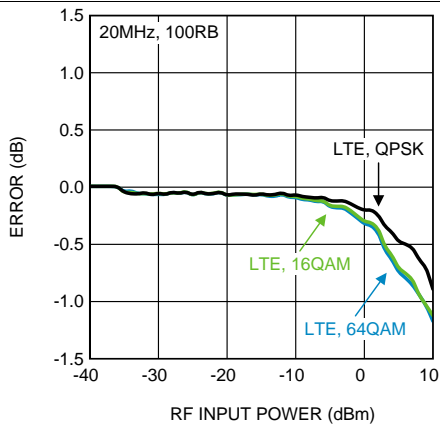

Figure 31. LTE Input referred Variation vs. RF Input Power at 1900 MHz

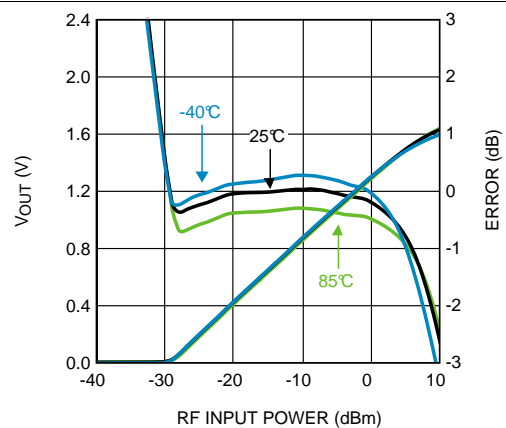

Figure 32. Output Voltage and Log Conformance Error vs. RF Input Power at 3500 MHz

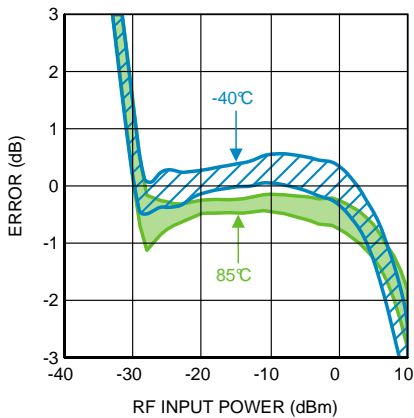

Figure 33. Log Conformance Error (50 Units) vs. RF Input Power at 3500 MHz

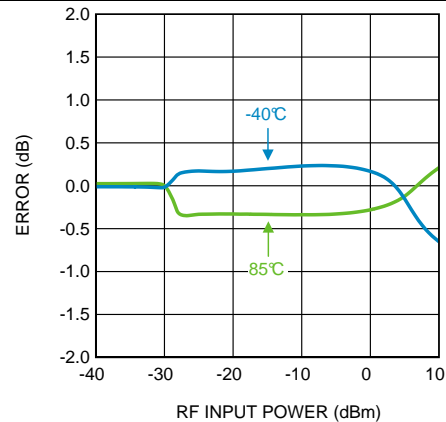

Figure 34. Temperature Variation vs. RF Input Power at 3500 MHz

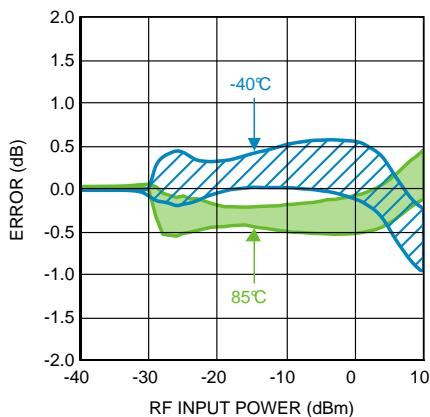

Figure 35. Temperature Variation (50 Units) vs. RF Input Power at 3500 MHz

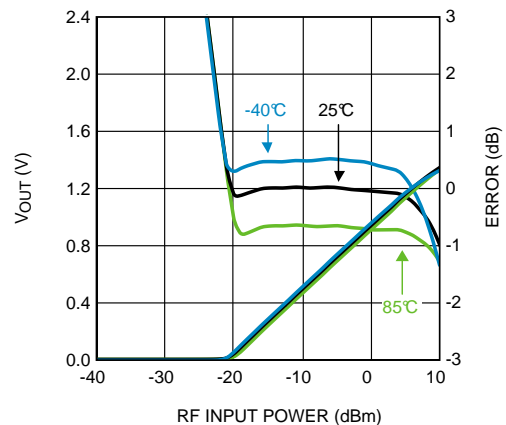

Figure 36. Output Voltage and Log Conformance Error vs. RF Input Power at 5800 MHz

Typical Characteristics (continued)

Unless otherwise specified: $T_A = 25^\circ\text{C}$, $V_{\text{BAT}} = 2.7\text{ V}$, $R_{\text{F IN}} = 1900\text{ MHz CW}$ (Continuous Wave, unmodulated). Specified errors are input referred.

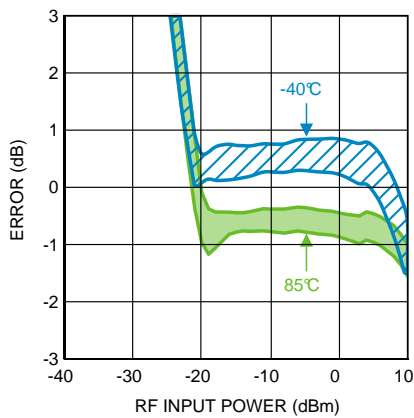

Figure 37. Log Conformance Error (50 Units) vs. RF Input Power at 5800 MHz

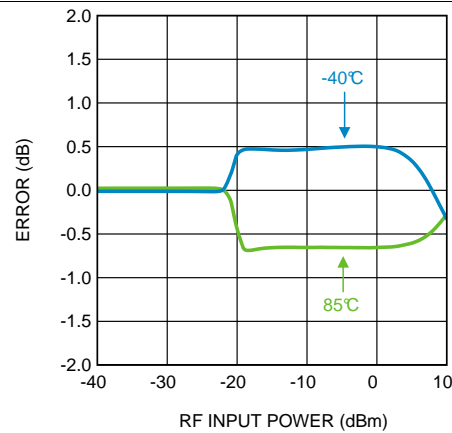

Figure 38. Temperature Variation vs. RF Input Power at 5800 MHz

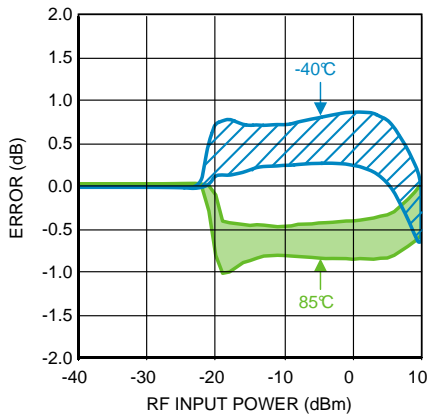

Figure 39. Temperature Variation (50 Units) vs. RF Input Power at 5800 MHz

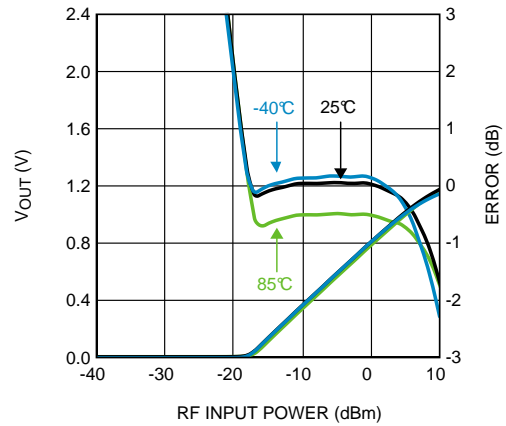

Figure 40. Output Voltage and Log Conformance Error vs. RF Input Power at 8000 MHz

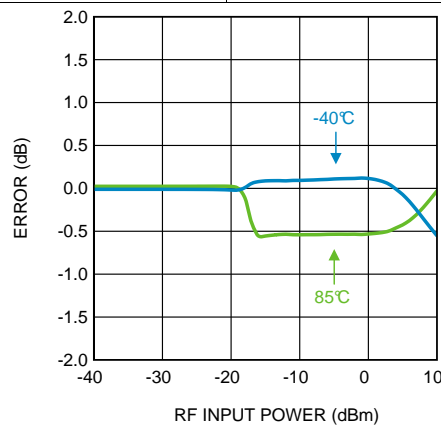

Figure 41. Temperature Variation vs. RF Input Power at 8000 MHz

7 Detailed Description

7.1 Overview

The LMH2110 is a high-performance logarithmic root mean square (RMS) power detector which measures the actual power content of a signal. The device has a RF input power detection range from -40 dBm to 5 dBm and provides accurate output voltage that relates linearly to the RF input power in dBm. This output voltage exhibits high temperature insensitivity ranging ± 0.25 dB.

The device has an internal low dropout linear regulator (LDO) making the device insensitive to input supply variation and allowing operation from a wide input supply range from 2.7 V to 5 V. Additional features include multi-band operation from 50 MHz to 8 GHz, shutdown functionality to save power, and minimal slope and intercept variation.

7.2 Functional Block Diagram

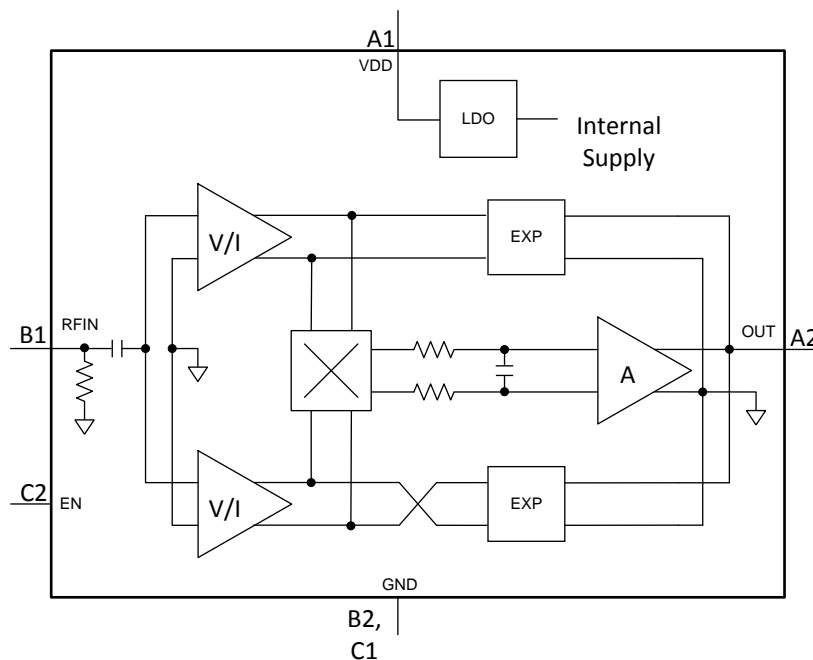

7.3 Feature Description

7.3.1 Accurate Power Measurement

Detectors have evolved over the years along with the communication standards. Newer communication standards like LTE and W-CDMA raise the need for more advanced accurate power detectors. To be able to distinguish the various detector types it is important to understand the ideal power measurement and how a power measurement is implemented.

Power is a metric for the average energy content of a signal. By definition it is not a function of the signal shape over time. In other words, the power content of a 0 -dBm sine wave is identical to the power content of a 0 -dBm square wave or a 0 -dBm W-CDMA signal; all these signals have the same average power content.

Feature Description (continued)

The average power can be described by [Equation 1](#):

$$P = \frac{1}{T} \int_0^T \frac{v(t)^2}{R} dt = \frac{V_{RMS}^2}{R}$$

where

- T is the time interval over which is averaged
 - v(t) is the instantaneous voltage at time t
 - R is the resistance in which the power is dissipated
 - V_{RMS} is the equivalent RMS voltage
- (1)

According to aforementioned formula for power, an exact power measurement can be done via measuring the RMS voltage (V_{RMS}) of a signal. The RMS voltage is described by:

$$V_{RMS} = \sqrt{\frac{1}{T} \int v(t)^2 dt}$$
(2)

Implementing the exact formula for RMS can be challenging. A simplification can be made in determining the average power when information about the waveform is available. If the signal shape is known, the relationship between RMS value and, for instance, the peak value of the RF signal is also known. It thus enables a measurement based on measuring peak voltage rather than measuring the RMS voltage. To calculate the RMS value (and therewith the average power), the measured peak voltage is translated into an RMS voltage based on the waveform characteristics. A few examples:

- Sine wave: $V_{RMS} = V_{PEAK} / \sqrt{2}$
- Square wave: $V_{RMS} = V_{PEAK}$
- Saw-tooth wave: $V_{RMS} = V_{PEAK} / \sqrt{3}$

For more complex waveforms it is not always easy to determine the exact relationship between RMS value and peak value. A peak measurement can then become impractical. An approximation can be used for the V_{RMS} to V_{PEAK} relationship but it can result in a less-accurate average power estimate.

Depending on the detection mechanism, power detectors may produce a slightly different output signal in response to more complex waveforms, even though the average power level of these signals are the same. This error is due to the fact that not all power detectors strictly implement the definition for signal power, being the RMS of the signal. To cover for the systematic error in the output response of a detector, calibration can be used. After calibration a look-up table corrects for the error. Multiple look-up tables can be created for different modulation schemes.

7.3.2 Types of RF Detectors

The following is an overview of detectors based on their detection principle. Detectors discussed in detail are:

- [Peak Detectors](#)
- [LOG Amp Detectors](#)
- [RMS Detectors](#)

7.3.2.1 Peak Detectors

A peak detector is one of the simplest types of detectors. According to the naming, the peak detector *stores* the highest value arising in a certain time window. However, usually a peak detector is used with a relative long holding time when compared to the carrier frequency and a relative short holding time with respect to the envelope frequency. In this way a peak detector is used as AM demodulator or envelope tracker ([Figure 42](#)).

Feature Description (continued)

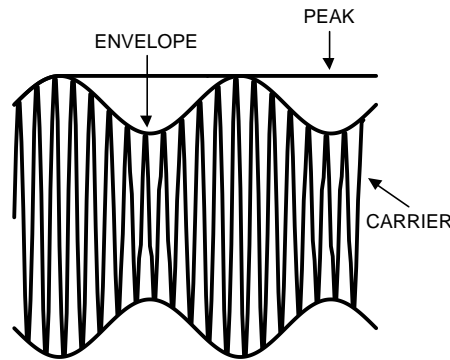

Figure 42. Peak Detection vs. Envelope Tracking

A peak detector usually has a linear response. An example of this is a diode detector (Figure 43). The diode rectifies the RF input voltage and subsequently the RC filter determines the averaging (holding) time. The selection of the holding time configures the diode detector for its particular application. For envelope tracking a relatively small RC time constant is chosen, such that the output voltage tracks the envelope nicely. A configuration with a relatively large time constant can be used for supply regulation of the power amplifier (PA). Controlling the supply voltage of the PA can reduce power consumption significantly. The optimal mode of operation is to set the supply voltage such that it is just above the maximum output voltage of the PA. A diode detector with relative large RC time constant measures this maximum (peak) voltage.

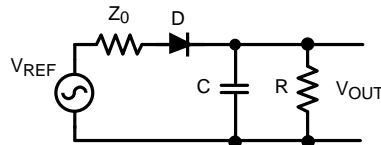

Figure 43. Diode Detector

Because peak detectors measure a peak voltage, their response is inherently depended on the signal shape or modulation form as discussed in the previous section. Knowledge about the signal shape is required to determine an RMS value. For complex systems having various modulation schemes, the amount of calibration and look-up tables can become unmanageable.

7.3.2.2 LOG Amp Detectors

LOG Amp detectors are widely used RF power detectors for GSM and the early W-CDMA systems. The transfer function of a LOG amp detector has a linear-in-dB response, which means that the output in volts changes linearly with the RF power in dBm. This is convenient because most communication standards specify transmit power levels in dBm as well. LOG amp detectors implement the logarithmic function by a piecewise linear approximation. Consequently, the LOG amp detector does not implement an exact power measurement, which implies a dependency on the signal shape. In systems using various modulation schemes calibration and lookup tables might be required.

7.3.2.3 RMS Detectors

An RMS detector has a response that is insensitive to the signal shape and modulation form. This is because its operation is based on exact determination of the average power, that is, it implements:

$$V_{RMS} = \sqrt{\frac{1}{T} \int v(t)^2 dt} \tag{3}$$

Feature Description (continued)

RMS detectors are in particular suited for the newer communication standards like W-CDMA and LTE that exhibit large peak-to-average ratios and different modulation schemes (signal shapes). This is a key advantage compared to other types of detectors in applications that employ signals with high peak-to-average power variations or different modulation schemes. For example, the RMS detector response to a 0-dBm modulated W-CDMA signal and a 0-dBm unmodulated carrier is essentially equal. This eliminates the need for long calibration procedures and large calibration tables in the baseband due to different applied modulation schemes.

7.3.3 LMH2110 RF Power Detector

For optimal performance of the LMH2110, the device must be configured correctly in the application (see [Functional Block Diagram](#)).

For measuring the RMS (power) level of a signal, the time average of the squared signal needs to be measured as described in [Accurate Power Measurement](#). This is implemented in the LMH2110 by means of a multiplier and a low-pass filter in a negative-feedback loop. A simplified block diagram of the LMH2110 is depicted in [Functional Block Diagram](#). The core of the loop is a multiplier. The two inputs of the multiplier are fed by (i_1 , i_2):

$$i_1 = i_{LF} + i_{RF} \quad (4)$$

$$i_2 = i_{LF} - i_{RF}$$

where

- i_{LF} is a current depending on the DC output voltage of the RF detector, and
- i_{RF} is a current depending on the RF input signal. (5)

The output of the multiplier (i_{OUT}) is the product of these two current and equals:

$$i_{out} = \frac{i_{LF}^2 - i_{RF}^2}{I_0}$$

where

- I_0 is a normalizing current. (6)

By a low-pass filter at the output of the multiplier the DC term of this current is isolated and integrated. The input of the amplifier A acts as the nulling point of the negative feedback loop, yielding:

$$\int i_{LF}^2 dt = \int i_{RF}^2 dt \quad (7)$$

which implies that the average power content of the current related to the output voltage of the LMH2110 is made equal to the average power content of the current related to the RF input signal.

For a negative-feedback system, the transfer function is given by the inverse function of the feedback block. Therefore, to have a logarithmic transfer for this RF detector, the feedback network implements an exponential function resulting in an overall transfer function for the LMH2110 of:

$$V_{out} = V_0 \log \left(\frac{1}{V_x} \sqrt{\int V_{RF}^2 dt} \right)$$

where

- V_0 and V_x are normalizing voltages. (8)

As a result of the feedback loop a square-root is also implemented, yielding the RMS function.

Given this architecture for the RF detector, the high-performance of the LMH2110 can be understood. In theory the accuracy of the logarithmic transfer is set by:

- The exponential feedback network, which basically needs to process a DC signal only.
- A high loop gain for the feedback loop, which is specified by the amplifier gain A.

The RMS functionality is inherent to the feedback loop and the use of a multiplier; thus, a very accurate LOG-RMS RF power detector is obtained.

Feature Description (continued)

To ensure a low dependency on the supply voltage, the internal detector circuitry is supplied via a low drop-out (LDO) regulator. This enables the usage of a wide range of supply voltage (2.7 V to 5 V) in combination with a low sensitivity of the output signal for the external supply voltage.

7.3.3.1 RF Input

Refer to [Application With Resistive Divider](#) for more details and applications.

7.3.3.2 Enable

To save power, the LMH2110 can be brought into a low-power shutdown mode by means of the enable pin (EN). The device is active for EN = HIGH ($V_{EN} > 1.1$ V) and in the low-power shutdown mode for EN = LOW ($V_{EN} < 0.6$ V). In this state the output of the LMH2110 is switched to a high impedance mode. This high impedance mode prevents the discharge of the optional low-pass filter which is good for the power efficiency. Using the shutdown function, care must be taken not to exceed the absolute maximum ratings. Because the device has an internal operating voltage of 2.5 V, the voltage level on the enable must not be higher than 3 V to prevent damage to the device. Also enable voltage levels lower than 400 mV below GND must be prevented. In both cases the ESD devices start to conduct when the enable voltage range is exceeded, and excessive current is drawn. A correct operation is not ensured then. The absolute maximum ratings are also exceeded when the enable (EN) is switched to HIGH (from shutdown to active mode) while the supply voltage is switched off. This situation must be prevented at all times. A possible solution to protect the device is to add a resistor of 1 k Ω in series with the enable input to limit the current.

7.3.3.3 Output

Refer to [Application With Low-Pass Output Filter for Residual Ripple Reduction](#) for more details and applications.

7.3.3.4 Supply

The LMH2110 has an internal LDO to handle supply voltages between 2.7 V to 5 V. This enables a direct connection to the battery in cell-phone applications. The high PSRR of the LMH2110 ensures that the performance is constant over its power supply range.

7.4 Device Functional Modes

To save power, the LMH2120 has an Enable/Disable feature that can bring the device in low-power shutdown mode. For implementation details, refer to [Enable](#).

8 Application and Implementation

NOTE

Information in the following applications sections is not part of the TI component specification, and TI does not warrant its accuracy or completeness. TI's customers are responsible for determining suitability of components for their purposes. Customers must validate and test their design implementation to confirm system functionality.

8.1 Application Information

The LMH2110 is a 45-dB Logarithmic RMS power detector particularly suited for accurate power measurements of modulated RF signals that exhibit large peak-to-average ratios (PARs). The RMS detector implements the exact definition of power resulting in a power measurement insensitive to high PARs. Such signals are encountered, for example, in LTE and W-CDMA applications. The LMH2110 has an RF frequency range from 50 MHz to 8 GHz. It provides an output voltage that relates linearly to the RF input power in dBm. Its output voltage is highly insensitive to temperature and supply variations.

8.2 Typical Applications

8.2.1 Application With Transmit Power Control

The LMH2110 can be used in a wide variety of applications such as LTE, W-CDMA, CDMA, and GSM. Transmit-power-control-loop circuits make the transmit power level insensitive to PA inaccuracy. This is desirable because power amplifiers are non-linear devices and temperature dependent, making it hard to estimate the exact transmit power level. If a control loop is used, the inaccuracy of the PA is eliminated from the overall accuracy of the transmit power level. The accuracy of the transmit power level now depends on the RF detector accuracy instead. The LMH2110 is especially suited for transmit power control applications, because it accurately measures transmit power and is insensitive to temperature, supply voltage and modulation variations.

Figure 44 shows a simplified schematic of a typical transmit power control system. The output power of the PA is measured by the LMH2110 through a directional coupler. The measured output voltage of the LMH2110 is digitized by the ADC inside the baseband chip. Accordingly, the baseband controls the PA output power level by changing the gain control signal of the RF VGA. Although the output ripple of the LMH2110 is typically low enough, an optional low-pass filter can be placed in between the LMH2110 and the ADC to further reduce the ripple.

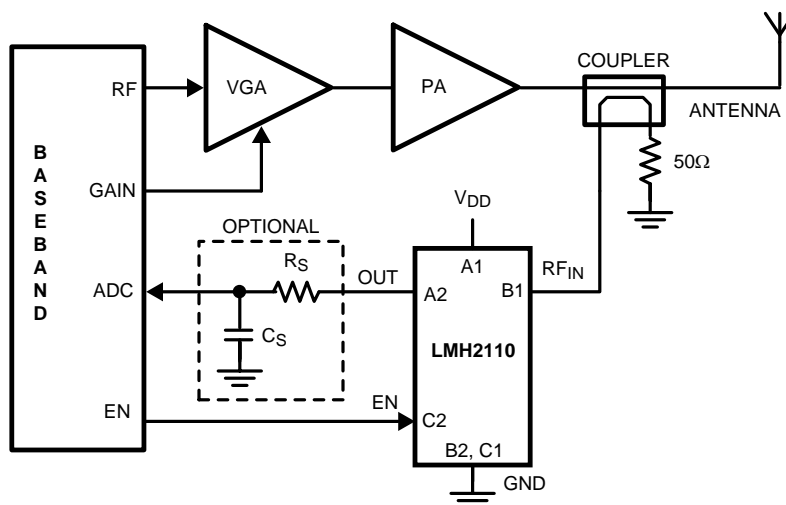

Figure 44. Transmit Power Control System

Typical Applications (continued)

8.2.1.1 Design Requirements

Some of the design requirements for this logarithmic RMS power detector include:

Table 1. Design Parameters

DESIGN PARAMETER	EXAMPLE VALUE
Supply voltage	2.7 V
RF input frequency (unmodulated continuous wave)	1900 MHz
Minimum power level	-36 dBm
Maximum power level	0 dBm
Maximum output voltage	1.5 V

8.2.1.2 Detailed Design Procedure

8.2.1.2.1 Specifying Detector Performance

The performance of the LMH2110 can be expressed by a variety of parameters.

8.2.1.2.1.1 Dynamic Range

The LMH2110 is designed to have a predictable and accurate response over a certain input power range. This is called the dynamic range (DR) of a detector. For determining the dynamic range a couple of different criteria can be used. The most commonly used ones are:

- Log conformance error, E_{LC}
- Variation over temperature error, E_{VOT}
- 1-dB step error, $E_{1\text{ dB}}$
- 10-dB step error, $E_{10\text{ dB}}$
- Variation due to modulation, E_{MOD}

The specified dynamic range is the range in which the specified error metric is within a predefined window. See [Log Conformance Error](#), [Variation Over Temperature Error](#), [Variation Over Temperature Error](#), [1-dB Step Error](#), [10-dB Step Error](#), and [Variation Due to Modulation](#) for an explanation of these errors.

8.2.1.2.1.2 Log Conformance Error

The LMH2110 implements a logarithmic function. In order to describe how close the transfer is to an ideal logarithmic function the log conformance error is used. To calculate the log conformance error the detector transfer function is modeled as a linear-in-dB relationship between the input power and the output voltage.

The ideal linear-in-dB transfer is modeled by 2 parameters:

- Slope
- Intercept

and is described by Equation 9:

$$V_{OUT} = K_{SLOPE} (P_{IN} - P_{INT})$$

where

- K_{SLOPE} is the slope of the line in mV/dB
- P_{IN} the input power level
- P_{INT} is the power level in dBm at which the line intercepts $V_{OUT} = 0$ V (see Figure 45). (9)

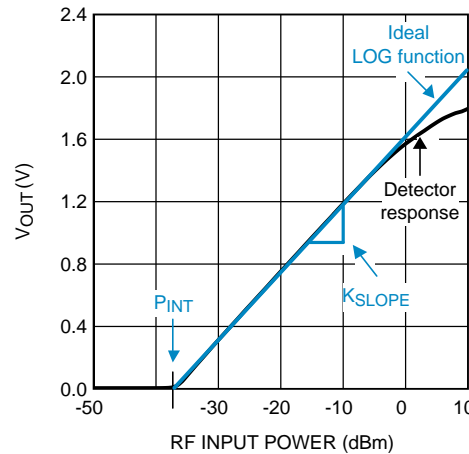

Figure 45. Ideal Logarithmic Response

To determine the log conformance error two steps are required:

1. Determine the best fitted line at 25°C.
2. Determine the difference between the actual data and the best fitted line.

The best fit can be determined by standard routines. A careful selection of the fit range is important. The fit range must be within the normal range of operation of the device. Outcome of the fit is K_{SLOPE} and P_{INT} .

Subsequently, the difference between the actual data and the best fitted line is determined. The log conformance is specified as an input referred error. The output referred error is therefore divided by the K_{SLOPE} to obtain the input referred error. The log conformance error is calculated by Equation 10:

$$E_{LC} = \frac{V_{OUT} - K_{SLOPE\ 25^{\circ}C} (P_{IN} - P_{INT\ 25^{\circ}C})}{K_{SLOPE\ 25^{\circ}C}}$$

where

- V_{OUT} is the measured output voltage at a power level at P_{IN} at a temperature. $K_{SLOPE\ 25^{\circ}C}$ (mV/dB).
- $P_{INT\ 25^{\circ}C}$ (dBm) are the parameters of the best fitted line of the 25°C transfer. (10)

In Figure 46 both the error with respect to the ideal LOG response as well as the error due to temperature variation are included in this error metric. This is because the measured data for all temperatures is compared to the fitted line at 25°C. The measurement result of a typical LMH2110 in Figure 46 shows a dynamic range of 36 dB for $E_{LC} = \pm 1$ dB.

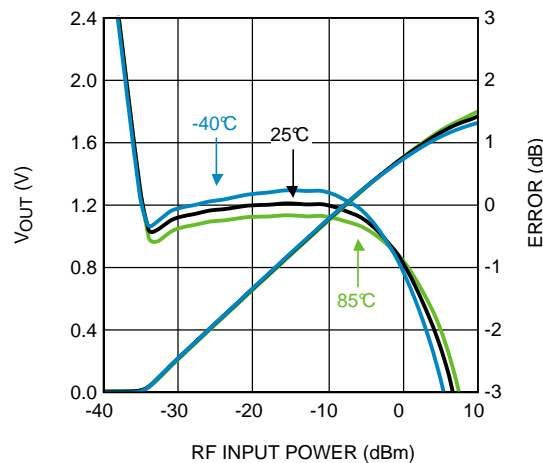
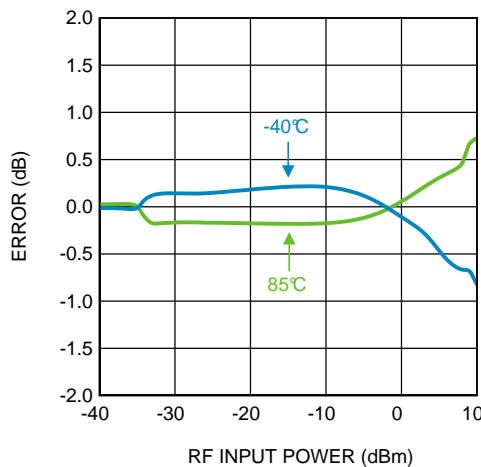

Figure 46. V_{OUT} and E_{LC} vs. RF input Power at 1900 MHz

8.2.1.2.1.3 Variation Over Temperature Error

In contrast to the log conformance error, the variation over temperature error (E_{VOT}) purely measures the error due to temperature variation. The measured output voltage at 25°C is subtracted from the output voltage at another temperature. Subsequently, it is translated into an input referred error by dividing it by K_{SLOPE} at 25°C. Variation over temperature is given by Equation 11:

$$E_{VOT} = (V_{OUT_TEMP} - V_{OUT\ 25^\circ C}) / K_{SLOPE\ 25^\circ C} \quad (11)$$

The variation over temperature is shown in Figure 47, where a dynamic range of 41 dB is obtained (from $P_{MIN} = -36$ dBm) for $E_{VOT} = \pm 0.5$ dB.

Figure 47. E_{VOT} vs. RF Input Power at 1900 MHz

8.2.1.2.1.4 1-dB Step Error

This parameter is a measure for the error for a 1-dB power step. According to a 3GPP specification, the error must be less than ± 0.3 dB. Often, this condition is used to define a useful dynamic range of the detector.

The 1-dB step error is calculated in 3 steps:

1. Determine the maximum sensitivity.
2. Determine average sensitivity.
3. Calculate the 1-dB step error.

First the maximum sensitivity (S_{MAX}) is calculated per temperature by determining the maximum difference between two output voltages for a 1-dB step within the power range:

$$S_{MAX} = V_{OUT P+1} - V_{OUT P} \quad (12)$$

To calculate the 1-dB step error an average sensitivity (S_{AVG}) is used which is the average of the maximum sensitivity and an allowed minimum sensitivity (S_{MIN}). The allowed minimum sensitivity is determined by the application. In this datasheet $S_{MIN} = 30 \text{ mV/dB}$ is used. Subsequently, the average sensitivity can be calculated by:

$$S_{AVG} = (S_{MAX} + S_{MIN}) / 2 \quad (13)$$

The 1-dB error is then calculated by:

$$E_{1 \text{ dB}} = (S_{ACTUAL} - S_{AVG}) / S_{AVG}$$

where

- S_{ACTUAL} (actual sensitivity) is the difference between two output voltages for a 1-dB step at a given power level. (14)

Figure 48 shows the typical 1-dB step error at 1900 MHz, where a dynamic range of 38 dB over temperature is obtained for $E_{1dB} = \pm 0.3 \text{ dB}$.

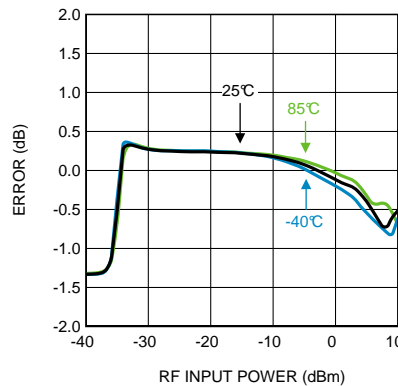

Figure 48. 1-dB Step Error vs. RF Input Power at 1900 MHz

8.2.1.2.1.5 10-dB Step Error

This error is defined in a different manner than the 1-dB step error. This parameter shows the input power error over temperature when a 10-dB power step is made. The 10-dB step at 25°C is taken as a reference.

To determine the 10-dB step error, first the output voltage levels (V_1 and V_2) for power levels P and $P+10 \text{ dB}$ at the 25°C are determined (Figure 49). Subsequently these 2 output voltages are used to determine the corresponding power levels at temperature T (P_T and $P_T + X$). The difference between those two power levels minus 10 results in the 10-dB step error.

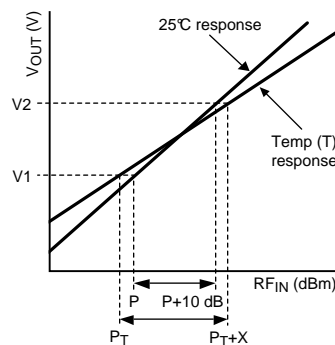

Figure 49. Graphical Representation of 10-dB Step Calculations

Figure 50 shows the typical 10-dB step error at 1900 MHz, where a dynamic range of 30 dB is obtained for $E_{10dB} = \pm 1$ dB.

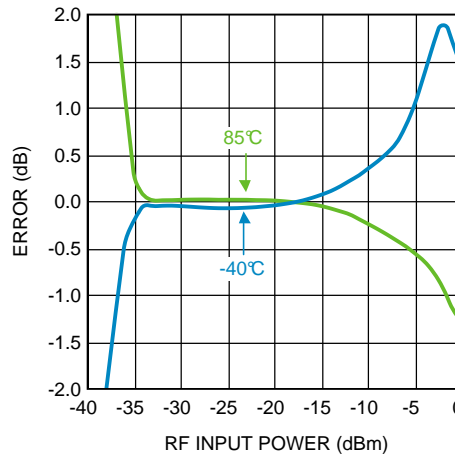

Figure 50. 10 dB Step Error vs. RF Input Power at 1900 MHz

8.2.1.2.1.6 Variation Due to Modulation

The response of an RF detector may vary due to different modulation schemes. How much it varies depends on the modulation form and the type of detector. Modulation forms with high peak-to-average ratios (PAR) can cause significant variation, especially with traditional RF detectors. This is because the measurement is not an actual RMS measurement and is therefore waveform dependent.

To calculate the variation due to modulation (E_{MOD}), the measurement result for an un-modulated RF carrier is subtracted from the measurement result of a modulated RF carrier. The calculations are similar to those for variation over temperature. The variation due to modulation can be calculated by:

$$E_{MOD} = (V_{OUT_MOD} - V_{OUT_CW}) / K_{SLOPE}$$

where

- V_{OUT_MOD} is the measured output voltage for an applied power level of a modulated signal.
- V_{OUT_CW} is the output voltage as a result of an applied un-modulated signal having the same power level. (15)

Figure 51 shows the variation due to modulation for W-CDMA, where a E_{MOD} of 0.09 dB is obtained for a dynamic range from -38 dBm to -5 dBm.

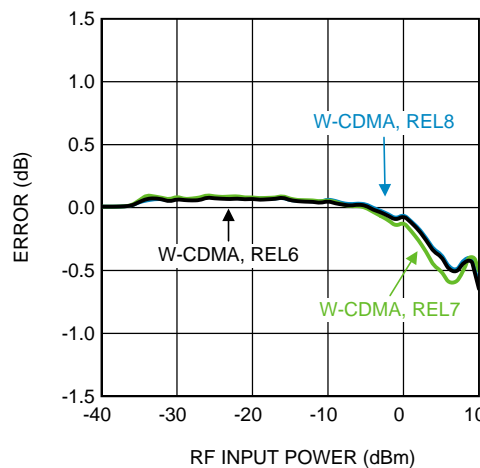
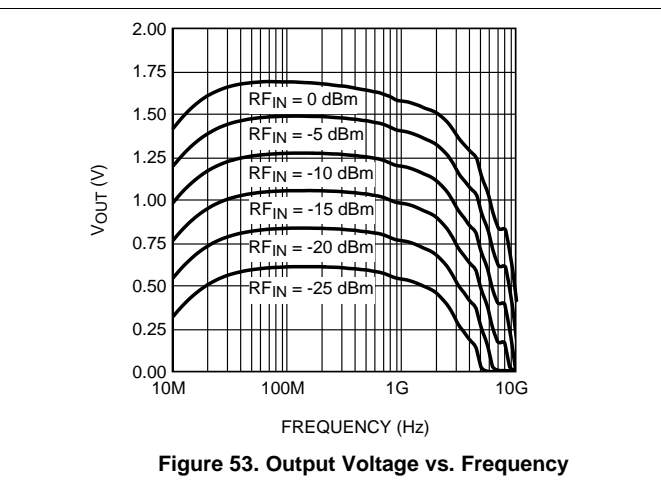
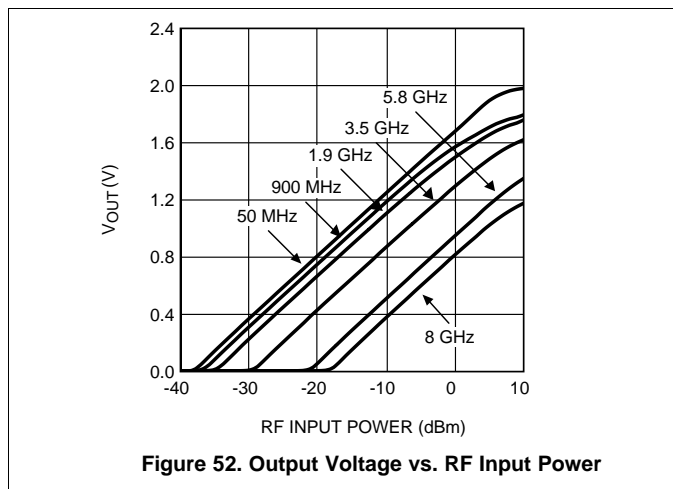

Figure 51. Variation Due to Modulation for W-CDMA

8.2.1.3 Application Curves



8.2.2 Application With Resistive Divider

RF systems typically use a characteristic impedance of 50 Ω. The LMH2110 is no exception to this. The RF input pin of the LMH2110 has an input impedance of 50 Ω. It enables an easy, direct connection to a directional coupler without the need for additional components (Figure 44). For an accurate power measurement the input power range of the LMH2110 needs to be aligned with the output power range of the power amplifier. This can be done by selecting a directional coupler with the correct coupling factor.

Because the LMH2110 has a constant input impedance, a resistive divider can also be used instead of a directional coupler (Figure 54).

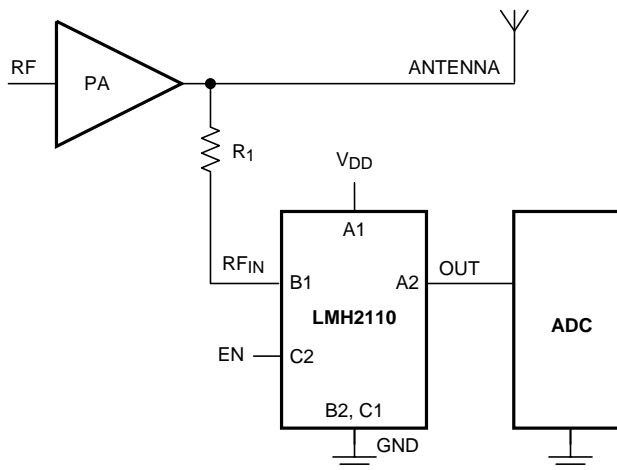

Figure 54. Application With Resistive Divider

Resistor R_1 implements an attenuator together with the detector input impedance to match the output range of the PA to the input range of the LMH2110. The attenuation (A_{dB}) realized by R_1 and the effective input impedance of the LMH2110 equals:

$$A_{dB} = 20 \text{LOG} \left[1 + \frac{R_1}{R_{IN}} \right] \quad (16)$$

Solving Equation 16 for R_1 yields:

$$R_1 = \left[10^{\frac{A_{dB}}{20}} - 1 \right] R_{IN} \quad (17)$$

Suppose the desired attenuation is 30 dB with a given LMH2110 input impedance of 50 Ω , the resistor R_1 needs to be 1531 Ω . A practical value is 1.5 k Ω . Although this is a cheaper solution than the application with directional coupler, it also comes with a disadvantage. After calculating the resistor value it is possible that the realized attenuation is less than expected. This is because of the parasitic capacitance of resistor R_1 which results in a lower actual realized attenuation. Whether the attenuation is reduced depends on the frequency of the RF signal and the parasitic capacitance of resistor R_1 . Because the parasitic capacitance varies from resistor to resistor, exact determination of the realized attenuation can be difficult. A way to reduce the parasitic capacitance of resistor R_1 is to realize it as a series connection of several separate resistors.

8.2.3 Application With Low-Pass Output Filter for Residual Ripple Reduction

The output of the LMH2110 provides a DC voltage that is a measure for the applied RF power to the input pin. The output voltage has a linear-in-dB response for an applied RF signal.

RF power detectors can have some residual ripple on the output due to the modulation of the applied RF signal. The residual ripple on the output of the LMH2110 device is small though and, therefore, additional filtering is usually not needed. This is because its internal averaging mechanism reduces the ripple significantly. For some modulation types however, having very high peak-to-average ratios, additional filtering might be useful.

Filtering can be applied by an external low-pass filter. Filtering reduces not only the ripple, but also increases the response time. In other words, it takes longer before the output reaches its final value. A trade-off must be made between allowed ripple and allowed response time. The filtering technique is depicted in Figure 55. The filtering of the low pass output filter is realized by resistor R_S and capacitor C_S . The -3 -dB bandwidth of this filter can be calculated by:

$$f_{-3\text{ dB}} = 1 / (2\pi R_S C_S) \quad (18)$$

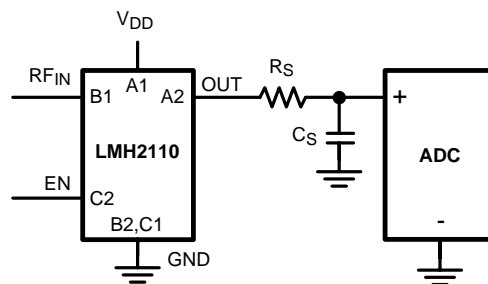

Figure 55. Low-Pass Output Filter for Residual Ripple Reduction

The output impedance of the LMH2110 is HIGH in shutdown. This is especially beneficial in pulsed mode systems. It ensures a fast settling time when the device returns from shutdown into active mode and reduces power consumption.

In pulse mode systems, the device is active only during a fraction of the time. During the remaining time the device is in low-power shutdown. Pulsed mode system applications usually require that the output value is available at all times. This can be realized by a capacitor connected between the output and GND that “stores” the output voltage level. To apply this principle, capacitor discharging must be minimized in shutdown mode. The connected ADC input must therefore have a high input impedance to prevent a possible discharge path through the ADC. When an additional filter is applied at the output, the capacitor of the RC-filter can be used to store the output value. An LMH2110 with a high impedance shutdown mode saves power in pulse mode systems. This is because the capacitor C_S does not need to be fully re-charged each cycle.

9 Power Supply Recommendations

The LMH2110 is designed to operate from an input voltage supply range between 2.7 V to 5 V. This input voltage must be well regulated. Enable voltage levels lower than 400 mV below GND could lead to incorrect operation of the device. Also, the resistance of the input supply rail must be low enough to ensure correct operation of the device.

10 Layout

10.1 Layout Guidelines

As with any other RF device, pay close careful attention to the board layout. If the board layout is not properly designed, performance might be less than can be expected for the application.

The LMH2110 is designed to be used in RF applications, having a characteristic impedance of 50 Ω . To achieve this impedance, the input of the LMH2110 needs to be connected via a 50- Ω transmission line. Transmission lines can be created on PCBs using microstrip or (grounded) coplanar waveguide (GCPW) configurations.

In order to minimize injection of RF interference into the LMH2110 through the supply lines, the PCB traces for VDD and GND must be minimized for RF signals. This can be done by placing a small decoupling capacitor between the VDD and GND. It must be placed as close as possible to the VDD and GND pins of the LMH2110.

10.2 Layout Example

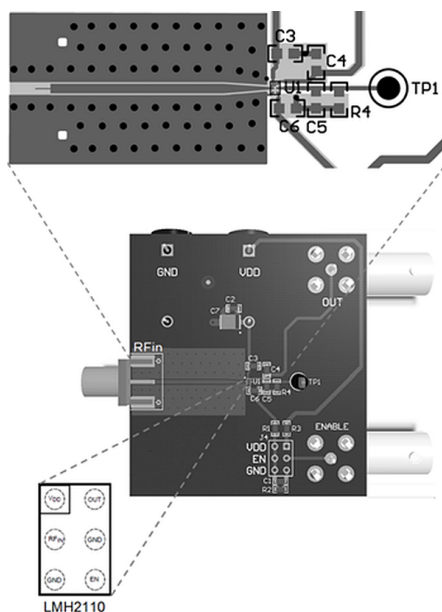

Figure 56. LMH2110 Layout

11 Device and Documentation Support

11.1 Community Resources

The following links connect to TI community resources. Linked contents are provided "AS IS" by the respective contributors. They do not constitute TI specifications and do not necessarily reflect TI's views; see TI's [Terms of Use](#).

TI E2E™ Online Community *TI's Engineer-to-Engineer (E2E) Community*. Created to foster collaboration among engineers. At e2e.ti.com, you can ask questions, share knowledge, explore ideas and help solve problems with fellow engineers.

Design Support *TI's Design Support* Quickly find helpful E2E forums along with design support tools and contact information for technical support.

11.2 Trademarks

E2E is a trademark of Texas Instruments.
All other trademarks are the property of their respective owners.

11.3 Electrostatic Discharge Caution



These devices have limited built-in ESD protection. The leads should be shorted together or the device placed in conductive foam during storage or handling to prevent electrostatic damage to the MOS gates.

11.4 Glossary

[SLYZ022](#) — *TI Glossary*.

This glossary lists and explains terms, acronyms, and definitions.

12 Mechanical, Packaging, and Orderable Information

The following pages include mechanical, packaging, and orderable information. This information is the most current data available for the designated devices. This data is subject to change without notice and revision of this document. For browser-based versions of this data sheet, refer to the left-hand navigation.

PACKAGING INFORMATION

Orderable Device	Status (1)	Package Type	Package Drawing	Pins	Package Qty	Eco Plan (2)	Lead finish/ Ball material (6)	MSL Peak Temp (3)	Op Temp (°C)	Device Marking (4/5)	Samples
LMH2110TM/NOPB	ACTIVE	DSBGA	YFQ	6	250	RoHS & Green	SNAGCU	Level-1-260C-UNLIM	-40 to 85	P	Samples
LMH2110TMX/NOPB	ACTIVE	DSBGA	YFQ	6	3000	RoHS & Green	SNAGCU	Level-1-260C-UNLIM	-40 to 85	P	Samples

(1) The marketing status values are defined as follows:

ACTIVE: Product device recommended for new designs.

LIFEBUY: TI has announced that the device will be discontinued, and a lifetime-buy period is in effect.

NRND: Not recommended for new designs. Device is in production to support existing customers, but TI does not recommend using this part in a new design.

PREVIEW: Device has been announced but is not in production. Samples may or may not be available.

OBSOLETE: TI has discontinued the production of the device.

(2) **RoHS:** TI defines "RoHS" to mean semiconductor products that are compliant with the current EU RoHS requirements for all 10 RoHS substances, including the requirement that RoHS substance do not exceed 0.1% by weight in homogeneous materials. Where designed to be soldered at high temperatures, "RoHS" products are suitable for use in specified lead-free processes. TI may reference these types of products as "Pb-Free".

RoHS Exempt: TI defines "RoHS Exempt" to mean products that contain lead but are compliant with EU RoHS pursuant to a specific EU RoHS exemption.

Green: TI defines "Green" to mean the content of Chlorine (Cl) and Bromine (Br) based flame retardants meet JS709B low halogen requirements of <=1000ppm threshold. Antimony trioxide based flame retardants must also meet the <=1000ppm threshold requirement.

(3) MSL, Peak Temp. - The Moisture Sensitivity Level rating according to the JEDEC industry standard classifications, and peak solder temperature.

(4) There may be additional marking, which relates to the logo, the lot trace code information, or the environmental category on the device.

(5) Multiple Device Markings will be inside parentheses. Only one Device Marking contained in parentheses and separated by a "~" will appear on a device. If a line is indented then it is a continuation of the previous line and the two combined represent the entire Device Marking for that device.

(6) Lead finish/Ball material - Orderable Devices may have multiple material finish options. Finish options are separated by a vertical ruled line. Lead finish/Ball material values may wrap to two lines if the finish value exceeds the maximum column width.

Important Information and Disclaimer:The information provided on this page represents TI's knowledge and belief as of the date that it is provided. TI bases its knowledge and belief on information provided by third parties, and makes no representation or warranty as to the accuracy of such information. Efforts are underway to better integrate information from third parties. TI has taken and continues to take reasonable steps to provide representative and accurate information but may not have conducted destructive testing or chemical analysis on incoming materials and chemicals. TI and TI suppliers consider certain information to be proprietary, and thus CAS numbers and other limited information may not be available for release.

In no event shall TI's liability arising out of such information exceed the total purchase price of the TI part(s) at issue in this document sold by TI to Customer on an annual basis.

TAPE AND REEL INFORMATION

QUADRANT ASSIGNMENTS FOR PIN 1 ORIENTATION IN TAPE

*All dimensions are nominal

Device	Package Type	Package Drawing	Pins	SPQ	Reel Diameter (mm)	Reel Width W1 (mm)	A0 (mm)	B0 (mm)	K0 (mm)	P1 (mm)	W (mm)	Pin1 Quadrant
LMH2110TM/NOPB	DSBGA	YFQ	6	250	178.0	8.4	1.04	1.4	0.76	4.0	8.0	Q1
LMH2110TMX/NOPB	DSBGA	YFQ	6	3000	178.0	8.4	1.04	1.4	0.76	4.0	8.0	Q1

TAPE AND REEL BOX DIMENSIONS

*All dimensions are nominal

Device	Package Type	Package Drawing	Pins	SPQ	Length (mm)	Width (mm)	Height (mm)
LMH2110TM/NOPB	DSBGA	YFQ	6	250	208.0	191.0	35.0
LMH2110TMX/NOPB	DSBGA	YFQ	6	3000	208.0	191.0	35.0

YFQ0006

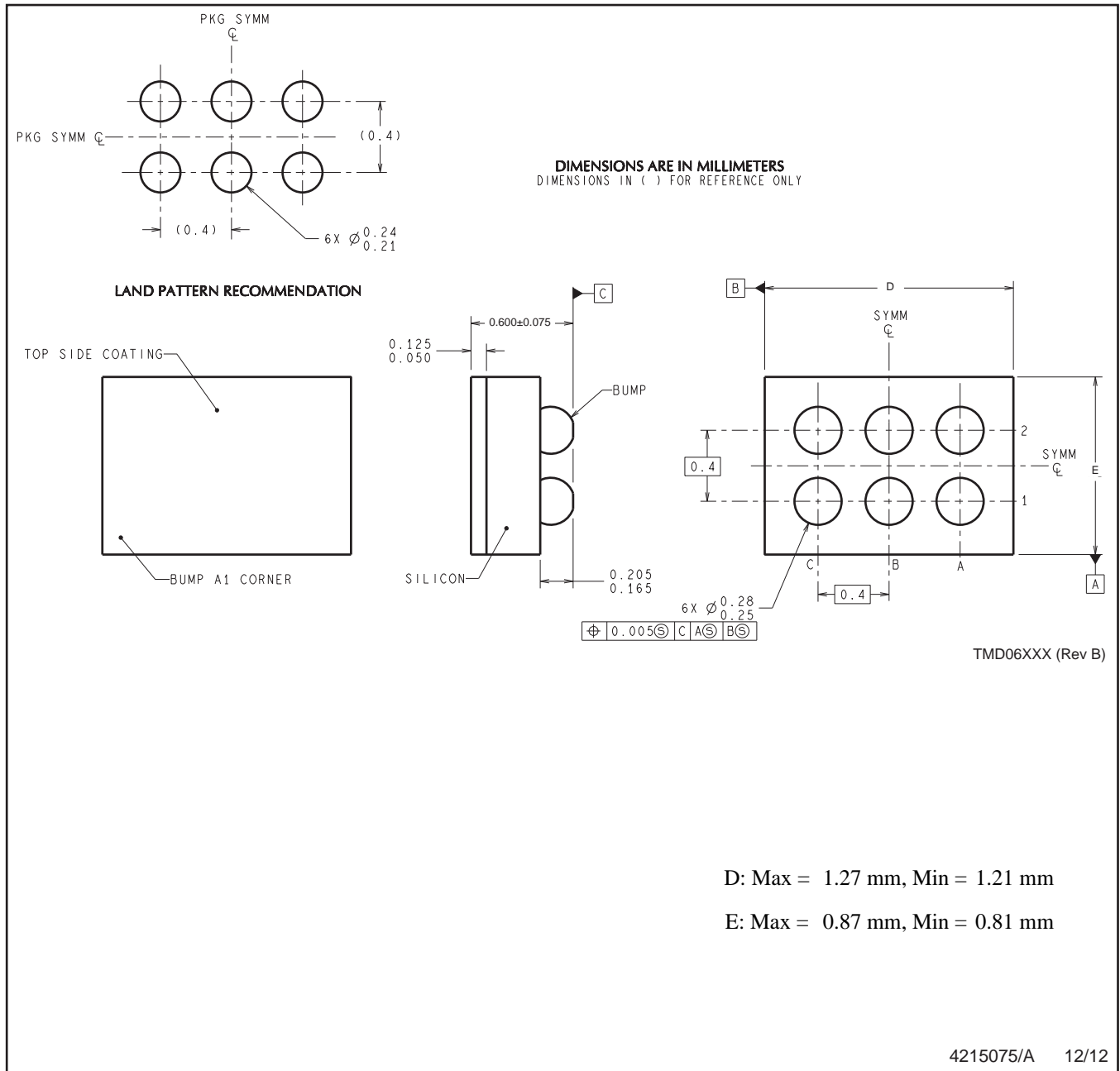

D: Max = 1.27 mm, Min = 1.21 mm

E: Max = 0.87 mm, Min = 0.81 mm

NOTES: A. All linear dimensions are in millimeters. Dimensioning and tolerancing per ASME Y14.5M-1994.
 B. This drawing is subject to change without notice.

IMPORTANT NOTICE AND DISCLAIMER

TI PROVIDES TECHNICAL AND RELIABILITY DATA (INCLUDING DATA SHEETS), DESIGN RESOURCES (INCLUDING REFERENCE DESIGNS), APPLICATION OR OTHER DESIGN ADVICE, WEB TOOLS, SAFETY INFORMATION, AND OTHER RESOURCES "AS IS" AND WITH ALL FAULTS, AND DISCLAIMS ALL WARRANTIES, EXPRESS AND IMPLIED, INCLUDING WITHOUT LIMITATION ANY IMPLIED WARRANTIES OF MERCHANTABILITY, FITNESS FOR A PARTICULAR PURPOSE OR NON-INFRINGEMENT OF THIRD PARTY INTELLECTUAL PROPERTY RIGHTS.

These resources are intended for skilled developers designing with TI products. You are solely responsible for (1) selecting the appropriate TI products for your application, (2) designing, validating and testing your application, and (3) ensuring your application meets applicable standards, and any other safety, security, regulatory or other requirements.

These resources are subject to change without notice. TI grants you permission to use these resources only for development of an application that uses the TI products described in the resource. Other reproduction and display of these resources is prohibited. No license is granted to any other TI intellectual property right or to any third party intellectual property right. TI disclaims responsibility for, and you will fully indemnify TI and its representatives against, any claims, damages, costs, losses, and liabilities arising out of your use of these resources.

TI's products are provided subject to [TI's Terms of Sale](#) or other applicable terms available either on [ti.com](https://www.ti.com) or provided in conjunction with such TI products. TI's provision of these resources does not expand or otherwise alter TI's applicable warranties or warranty disclaimers for TI products.

TI objects to and rejects any additional or different terms you may have proposed.

Mailing Address: Texas Instruments, Post Office Box 655303, Dallas, Texas 75265
Copyright © 2024, Texas Instruments Incorporated