

Keystone Architecture DDR3 Memory Controller

User's Guide



Literature Number: SPRUGV8E
November 2010—Revised January 2015

| | |
|--|-----------|
| Preface | 11 |
| 1 Introduction | 13 |
| 1.1 Purpose of the Peripheral | 14 |
| 1.2 Features | 14 |
| 1.3 Industry Standard(s) Compliance Statement | 14 |
| 2 Peripheral Architecture | 16 |
| 2.1 Clock Interface | 17 |
| 2.2 SDRAM Memory Map | 17 |
| 2.3 Signal Descriptions..... | 17 |
| 2.4 Protocol Descriptions | 18 |
| 2.4.1 Mode Register Set (MRS or EMRS) | 19 |
| 2.4.2 Refresh Mode | 20 |
| 2.4.3 Activation | 20 |
| 2.4.4 Deactivation | 20 |
| 2.4.5 READ Command | 20 |
| 2.4.6 Write (WR) Command | 21 |
| 2.5 Address Mapping | 22 |
| 2.6 DDR3 Memory Controller Interface | 27 |
| 2.6.1 Arbitration | 28 |
| 2.6.2 Command Starvation | 29 |
| 2.6.3 Possible Race Condition | 29 |
| 2.6.4 Class of Service | 29 |
| 2.7 Refresh Scheduling | 30 |
| 2.8 Self-Refresh Mode | 30 |
| 2.8.1 Extended Temperature Range | 31 |
| 2.9 Reset Considerations | 31 |
| 2.10 Turnaround Time | 32 |
| 2.11 DDR3 SDRAM Memory Initialization | 32 |
| 2.11.1 DDR3 Initialization Sequence | 34 |
| 2.12 Dual Rank Support | 34 |
| 2.13 Leveling..... | 34 |
| 2.13.1 Full Leveling (Auto Leveling)..... | 34 |
| 2.13.2 Incremental Leveling..... | 35 |
| 2.13.2.1 Ramp Incremental Leveling..... | 36 |
| 2.13.3 Impact On Bandwidth..... | 36 |
| 2.13.4 Programming Full Leveling | 36 |
| 2.13.4.1 Leveling Timeout..... | 37 |
| 2.13.4.2 Read Data Eye Training Errata For Full Leveling | 37 |
| 2.13.5 Programming Incremental Leveling..... | 38 |
| 2.13.5.1 Standalone Incremental Leveling | 38 |
| 2.13.6 Programming Ratio Forced Leveling | 38 |
| 2.13.7 Using Invert Clock Out..... | 38 |
| 2.14 Interrupt Support | 39 |
| 2.15 EDMA Event Support | 39 |
| 2.16 Emulation Considerations | 39 |

| | | |
|----------|---|-----------|
| 2.17 | ECC | 39 |
| 2.18 | Power Management..... | 40 |
| 2.18.1 | SDRAM Self-Refresh Mode..... | 40 |
| 2.18.2 | SDRAM Power-Down Mode | 40 |
| 2.19 | Performance Monitoring | 40 |
| 3 | Using the DDR3 Memory Controller | 43 |
| 3.1 | Connecting the DDR3 Memory Controller to DDR3 SDRAM..... | 44 |
| 3.2 | Configuring DDR3 Memory Controller Registers to Meet DDR3 SDRAM Specifications..... | 48 |
| 3.2.1 | Programming the SDRAM Configuration Register (SDCFG)..... | 48 |
| 3.2.2 | Programming the SDRAM Refresh Control Register (SDRFC) | 48 |
| 3.2.3 | Configuring SDRAM Timing Registers (SDTIM1, SDTIM2, SDTIM3, SDTIM4) | 49 |
| 3.2.4 | Configuring Leveling Registers | 50 |
| 3.2.5 | Configuring Read Latency | 50 |
| 4 | DDR3 Memory Controller Registers | 52 |
| 4.1 | Module ID and Revision Register (MIDR)..... | 55 |
| 4.2 | DDR3 Memory Controller Status Register (STATUS)..... | 56 |
| 4.3 | SDRAM Configuration Register (SDCFG) | 57 |
| 4.4 | SDRAM Refresh Control Register (SDRFC)..... | 59 |
| 4.5 | SDRAM Timing 1 (SDTIM1) Register | 60 |
| 4.6 | SDRAM Timing 2 (SDTIM2) Register | 61 |
| 4.7 | SDRAM Timing 3 (SDTIM3) Register | 62 |
| 4.8 | Power Management Control Register (PMCTL) | 63 |
| 4.9 | VBUSM Configuration Register (VBUSM_CONFIG) | 65 |
| 4.10 | Performance Counter 1 Register (PERF_CNT_1)..... | 66 |
| 4.11 | Performance Counter 2 Register (PERF_CNT_2)..... | 67 |
| 4.12 | Performance Counter Config Register (PERF_CNT_CFG) | 68 |
| 4.13 | Performance Counter Master Region Select Register (PERF_CNT_SEL) | 69 |
| 4.14 | Performance Counter Time Register (PERF_CNT_TIM) | 70 |
| 4.15 | Interrupt Raw Status Register (IRQSTATUS_RAW_SYS) | 71 |
| 4.16 | Interrupt Status Register (IRQSTATUS_SYS)..... | 72 |
| 4.17 | Interrupt Enable Set Register (IRQSTATUS_SET_SYS) | 73 |
| 4.18 | Interrupt Enable Clear Register (IRQSTATUS_CLR_SYS)..... | 74 |
| 4.19 | SDRAM Output Impedance Calibration Configuration Register (ZQCFG)..... | 75 |
| 4.20 | Read-Write Leveling Ramp Window Register (RDWR_LVL_RMP_WIN) | 77 |
| 4.21 | Read-Write Leveling Ramp Control Register (RDWR_LVL_RMP_CTRL)..... | 78 |
| 4.22 | Read-Write Leveling Control Register (RDWR_LVL_CTRL) | 79 |
| 4.23 | DDR PHY Control 1 Register (DDR_PHY_CTRL_1)..... | 80 |
| 4.24 | Priority to Class-Of-Service Mapping Register (PRI_COS_MAP) | 81 |
| 4.25 | Master ID to Class-Of-Service 1 Mapping Register (MSTID_COS_1_MAP)..... | 82 |
| 4.26 | Master ID to Class-Of-Service 2 Mapping Register (MSTID_COS_2_MAP)..... | 83 |
| 4.27 | ECC Control Register (ECCCTL) | 84 |
| 4.28 | ECC Address Range 1 Register (ECCADDR1) | 85 |
| 4.29 | ECC Address Range 2 Register (ECCADDR2) | 86 |
| 4.30 | Read Write Execution Threshold Register (RWTHRESH)..... | 87 |
| 4.31 | DDR3 Configuration 0 Register (DDR3_CONFIG_0) | 88 |
| 4.32 | DDR3 Configuration 1 Register (DDR3_CONFIG_1) | 89 |
| 4.33 | DDR3 Configuration 2 Register (DDR3_CONFIG_2) | 89 |
| 4.34 | DDR3 Configuration 3 Register (DDR3_CONFIG_3) | 90 |
| 4.35 | DDR3 Configuration 4 Register (DDR3_CONFIG_4) | 90 |
| 4.36 | DDR3 Configuration 5 Register (DDR3_CONFIG_5) | 91 |
| 4.37 | DDR3 Configuration 6 Register (DDR3_CONFIG_6) | 91 |
| 4.38 | DDR3 Configuration 7 Register (DDR3_CONFIG_7) | 92 |
| 4.39 | DDR3 Configuration 8 Register (DDR3_CONFIG_8) | 92 |

| | | |
|-------------------------------|---|------------|
| 4.40 | DDR3 Configuration 9 Register (DDR3_CONFIG_9) | 93 |
| 4.41 | DDR3 Configuration 10 Register (DDR3_CONFIG_10) | 93 |
| 4.42 | DDR3 Configuration 12 Register (DDR3_CONFIG_12) | 94 |
| 4.43 | DDR3 Configuration 14 Register (DDR3_CONFIG_14) | 94 |
| 4.44 | DDR3 Configuration 15 Register (DDR3_CONFIG_15) | 95 |
| 4.45 | DDR3 Configuration 16 Register (DDR3_CONFIG_16) | 95 |
| 4.46 | DDR3 Configuration 17 Register (DDR3_CONFIG_17) | 96 |
| 4.47 | DDR3 Configuration 18 Register (DDR3_CONFIG_18) | 96 |
| 4.48 | DDR3 Configuration 19 Register (DDR3_CONFIG_19) | 97 |
| 4.49 | DDR3 Configuration 20 Register (DDR3_CONFIG_20) | 97 |
| 4.50 | DDR3 Configuration 21 Register (DDR3_CONFIG_21) | 98 |
| 4.51 | DDR3 Configuration 22 Register (DDR3_CONFIG_22) | 98 |
| 4.52 | DDR3 Configuration 23 Register (DDR3_CONFIG_23) | 99 |
| 4.53 | DDR3 Configuration 24 Register (DDR3_CONFIG_24) | 99 |
| 4.54 | DDR3 Configuration 25 Register (DDR3_CONFIG_25) | 100 |
| 4.55 | DDR3 Configuration 26 Register (DDR3_CONFIG_26) | 100 |
| 4.56 | DDR3 Configuration 27 Register (DDR3_CONFIG_27) | 101 |
| 4.57 | DDR3 Configuration 28 Register (DDR3_CONFIG_28) | 101 |
| 4.58 | DDR3 Configuration 29 Register (DDR3_CONFIG_29) | 102 |
| 4.59 | DDR3 Configuration 30 Register (DDR3_CONFIG_30) | 102 |
| 4.60 | DDR3 Configuration 31 Register (DDR3_CONFIG_31) | 103 |
| 4.61 | DDR3 Configuration 32 Register (DDR3_CONFIG_32) | 103 |
| 4.62 | DDR3 Configuration 33 Register (DDR3_CONFIG_33) | 104 |
| 4.63 | DDR3 Configuration 34 Register (DDR3_CONFIG_34) | 104 |
| 4.64 | DDR3 Configuration 35 Register (DDR3_CONFIG_35) | 105 |
| 4.65 | DDR3 Configuration 36 Register (DDR3_CONFIG_36) | 105 |
| 4.66 | DDR3 Configuration 37 Register (DDR3_CONFIG_37) | 106 |
| 4.67 | DDR3 Configuration 38 Register (DDR3_CONFIG_38) | 106 |
| 4.68 | DDR3 Configuration 39 Register (DDR3_CONFIG_39) | 107 |
| 4.69 | DDR3 Configuration 40 Register (DDR3_CONFIG_40) | 107 |
| 4.70 | DDR3 Configuration 41 Register (DDR3_CONFIG_41) | 108 |
| 4.71 | DDR3 Configuration 42 Register (DDR3_CONFIG_42) | 108 |
| 4.72 | DDR3 Configuration 43 Register (DDR3_CONFIG_43) | 109 |
| 4.73 | DDR3 Configuration 44 Register (DDR3_CONFIG_44) | 109 |
| 4.74 | DDR3 Configuration 45 Register (DDR3_CONFIG_45) | 110 |
| 4.75 | DDR3 Configuration 46 Register (DDR3_CONFIG_46) | 110 |
| 4.76 | DDR3 Configuration 47 Register (DDR3_CONFIG_47) | 111 |
| 4.77 | DDR3 Configuration 48 Register (DDR3_CONFIG_48) | 111 |
| 4.78 | DDR3 Configuration 49 Register (DDR3_CONFIG_49) | 112 |
| 4.79 | DDR3 Configuration 50 Register (DDR3_CONFIG_50) | 112 |
| 4.80 | DDR3 Configuration 51 Register (DDR3_CONFIG_51) | 113 |
| 4.81 | DDR3 Configuration 52 Register (DDR3_CONFIG_52) | 113 |
| 4.82 | DDR3 Configuration 53 Register (DDR3_CONFIG_53) | 114 |
| 4.83 | DDR3 Configuration 54 Register (DDR3_CONFIG_54) | 114 |
| 4.84 | DDR3 Configuration 55 Register (DDR3_CONFIG_55) | 115 |
| 4.85 | DDR3 Configuration 56 Register (DDR3_CONFIG_56) | 115 |
| 4.86 | DDR3 Configuration 57 Register (DDR3_CONFIG_57) | 116 |
| 4.87 | DDR3 Configuration 58 Register (DDR3_CONFIG_58) | 116 |
| 4.88 | DDR3 Configuration 59 Register (DDR3_CONFIG_59) | 117 |
| 4.89 | DDR3 Configuration 60 Register (DDR3_CONFIG_60) | 117 |
| Revision History | | 119 |

List of Figures

| | | |
|-------|---|----|
| 2-1. | DDR3 Memory Control Signals..... | 17 |
| 2-2. | READ Command | 21 |
| 2-3. | WRITE Command | 21 |
| 2-4. | Logical Address-to-DDR3 SDRAM Address Map (EBANK=0) | 26 |
| 2-5. | DDR3 SDRAM Column, Row, and Bank Access (EBANK=0) | 26 |
| 2-6. | DDR3 Memory Controller FIFO Block Diagram | 27 |
| 3-1. | Connecting Two 16 MB x 16 x 8 Banks (4Gb Total) Devices | 45 |
| 3-2. | Connecting One 8 MB x 16 x 8 Banks (1Gb Total) Device | 46 |
| 3-3. | Connecting Two 16 MB x 8 x 8 Banks (2Gb Total) Devices | 47 |
| 4-1. | Module ID and Revision Register (MIDR)..... | 55 |
| 4-2. | DDR3 Memory Controller Status Register (STATUS)..... | 56 |
| 4-3. | SDRAM Configuration Register (SDCFG) | 57 |
| 4-4. | SDRAM Refresh Control Register (SDRFC)..... | 59 |
| 4-5. | SDRAM Timing 1 (SDTIM1) Register | 60 |
| 4-6. | SDRAM Timing 2 (SDTIM2) Register | 61 |
| 4-7. | SDRAM Timing 3 (SDTIM3) Register | 62 |
| 4-8. | Power Management Control Register (PMCTL) | 63 |
| 4-9. | VBUSM Configuration Register (VBUSM_CONFIG) | 65 |
| 4-10. | Performance Counter 1 Register (PERF_CNT_1)..... | 66 |
| 4-11. | Performance Counter 2 Register (PERF_CNT_2)..... | 67 |
| 4-12. | Performance Counter Config Register (PERF_CNT_CFG) | 68 |
| 4-13. | Performance Counter Master Region Select Register (PERF_CNT_SEL)..... | 69 |
| 4-14. | Performance Counter Time Register (PERF_CNT_TIM) | 70 |
| 4-15. | Interrupt Raw Status Register (IRQSTATUS_RAW_SYS) | 71 |
| 4-16. | Interrupt Status Register (IRQSTATUS_SYS)..... | 72 |
| 4-17. | Interrupt Enable Set Register (IRQSTATUS_SET_SYS) | 73 |
| 4-18. | Interrupt Enable Clear Register (IRQSTATUS_CLR_SYS)..... | 74 |
| 4-19. | SDRAM Output Impedance Calibration Configuration Register (ZQCFG)..... | 75 |
| 4-20. | Read-Write Leveling Ramp Window Register (RDWR_LVL_RMP_WIN) | 77 |
| 4-21. | Read-Write Leveling Ramp Control Register (RDWR_LVL_RMP_CTRL)..... | 78 |
| 4-22. | Read-Write Leveling Control Register (RDWR_LVL_CTRL) | 79 |
| 4-23. | DDR PHY Control 1 Register (DDR_PHY_CTRL_1)..... | 80 |
| 4-24. | Priority to Class-Of-Service Mapping Register (PRI_COS_MAP) | 81 |
| 4-25. | Master ID to Class-Of-Service 1 Mapping Register (MSTID_COS_1_MAP)..... | 82 |
| 4-26. | Master ID to Class-Of-Service 2 Mapping Register (MSTID_COS_2_MAP)..... | 83 |
| 4-27. | ECC Control Register (ECCCTL) | 84 |
| 4-28. | ECC Address Range 1 Register (ECCADDR1) | 85 |
| 4-29. | ECC Address Range 2 Register (ECCADDR2)..... | 86 |
| 4-30. | Read Write Execution Threshold Register (RWTHRESH)..... | 87 |
| 4-31. | DDR3 Configuration 0 Register (DDR3_CONFIG_0) | 88 |
| 4-32. | DDR3 Configuration 1 Register (DDR3_CONFIG_1) | 89 |
| 4-33. | DDR3 Configuration 2 Register (DDR3_CONFIG_2) | 89 |
| 4-34. | DDR3 Configuration 3 Register (DDR3_CONFIG_3) | 90 |
| 4-35. | DDR3 Configuration 4 Register (DDR3_CONFIG_4) | 90 |
| 4-36. | DDR3 Configuration 5 Register (DDR3_CONFIG_5) | 91 |
| 4-37. | DDR3 Configuration 6 Register (DDR3_CONFIG_6) | 91 |
| 4-38. | DDR3 Configuration 7 Register (DDR3_CONFIG_7) | 92 |

| | | |
|-------|---|-----|
| 4-39. | DDR3 Configuration 8 Register (DDR3_CONFIG_8) | 92 |
| 4-40. | DDR3 Configuration 9 Register (DDR3_CONFIG_9) | 93 |
| 4-41. | DDR3 Configuration 10 Register (DDR3_CONFIG_10) | 93 |
| 4-42. | DDR3 Configuration 12 Register (DDR3_CONFIG_12) | 94 |
| 4-43. | DDR3 Configuration 14 Register (DDR3_CONFIG_14) | 94 |
| 4-44. | DDR3 Configuration 15 Register (DDR3_CONFIG_15) | 95 |
| 4-45. | DDR3 Configuration 16 Register (DDR3_CONFIG_16) | 95 |
| 4-46. | DDR3 Configuration 17 Register (DDR3_CONFIG_17) | 96 |
| 4-47. | DDR3 Configuration 18 Register (DDR3_CONFIG_18) | 96 |
| 4-48. | DDR3 Configuration 19 Register (DDR3_CONFIG_19) | 97 |
| 4-49. | DDR3 Configuration 20 Register (DDR3_CONFIG_20) | 97 |
| 4-50. | DDR3 Configuration 21 Register (DDR3_CONFIG_21) | 98 |
| 4-51. | DDR3 Configuration 22 Register (DDR3_CONFIG_22) | 98 |
| 4-52. | DDR3 Configuration 23 Register (DDR3_CONFIG_23) | 99 |
| 4-53. | DDR3 Configuration 24 Register (DDR3_CONFIG_24) | 99 |
| 4-54. | DDR3 Configuration 25 Register (DDR3_CONFIG_25) | 100 |
| 4-55. | DDR3 Configuration 26 Register (DDR3_CONFIG_26) | 100 |
| 4-56. | DDR3 Configuration 27 Register (DDR3_CONFIG_27) | 101 |
| 4-57. | DDR3 Configuration 28 Register (DDR3_CONFIG_28) | 101 |
| 4-58. | DDR3 Configuration 29 Register (DDR3_CONFIG_29) | 102 |
| 4-59. | DDR3 Configuration 30 Register (DDR3_CONFIG_30) | 102 |
| 4-60. | DDR3 Configuration 31 Register (DDR3_CONFIG_31) | 103 |
| 4-61. | DDR3 Configuration 32 Register (DDR3_CONFIG_32) | 103 |
| 4-62. | DDR3 Configuration 33 Register (DDR3_CONFIG_33) | 104 |
| 4-63. | DDR3 Configuration 34 Register (DDR3_CONFIG_34) | 104 |
| 4-64. | DDR3 Configuration 35 Register (DDR3_CONFIG_35) | 105 |
| 4-65. | DDR3 Configuration 36 Register (DDR3_CONFIG_36) | 105 |
| 4-66. | DDR3 Configuration 37 Register (DDR3_CONFIG_37) | 106 |
| 4-67. | DDR3 Configuration 38 Register (DDR3_CONFIG_38) | 106 |
| 4-68. | DDR3 Configuration 39 Register (DDR3_CONFIG_39) | 107 |
| 4-69. | DDR3 Configuration 40 Register (DDR3_CONFIG_40) | 107 |
| 4-70. | DDR3 Configuration 41 Register (DDR3_CONFIG_41) | 108 |
| 4-71. | DDR3 Configuration 42 Register (DDR3_CONFIG_42) | 108 |
| 4-72. | DDR3 Configuration 43 Register (DDR3_CONFIG_43) | 109 |
| 4-73. | DDR3 Configuration 44 Register (DDR3_CONFIG_44) | 109 |
| 4-74. | DDR3 Configuration 45 Register (DDR3_CONFIG_45) | 110 |
| 4-75. | DDR3 Configuration 46 Register (DDR3_CONFIG_46) | 110 |
| 4-76. | DDR3 Configuration 47 Register (DDR3_CONFIG_47) | 111 |
| 4-77. | DDR3 Configuration 48 Register (DDR3_CONFIG_48) | 111 |
| 4-78. | DDR3 Configuration 49 Register (DDR3_CONFIG_49) | 112 |
| 4-79. | DDR3 Configuration 50 Register (DDR3_CONFIG_50) | 112 |
| 4-80. | DDR3 Configuration 51 Register (DDR3_CONFIG_51) | 113 |
| 4-81. | DDR3 Configuration 52 Register (DDR3_CONFIG_52) | 113 |
| 4-82. | DDR3 Configuration 53 Register (DDR3_CONFIG_53) | 114 |
| 4-83. | DDR3 Configuration 54 Register (DDR3_CONFIG_54) | 114 |
| 4-84. | DDR3 Configuration 55 Register (DDR3_CONFIG_55) | 115 |
| 4-85. | DDR3 Configuration 56 Register (DDR3_CONFIG_56) | 115 |
| 4-86. | DDR3 Configuration 57 Register (DDR3_CONFIG_57) | 116 |
| 4-87. | DDR3 Configuration 58 Register (DDR3_CONFIG_58) | 116 |

| | |
|---|-----|
| 4-88. DDR3 Configuration 59 Register (DDR3_CONFIG_59) | 117 |
| 4-89. DDR3 Configuration 60 Register (DDR3_CONFIG_60) | 117 |

List of Tables

| | | |
|-------|--|----|
| 2-1. | DDR3 Memory Controller Signal Descriptions | 17 |
| 2-2. | DDR3 SDRAM Commands | 18 |
| 2-3. | Truth Table for DDR3 SDRAM Commands..... | 19 |
| 2-4. | Bank Configuration Register Fields for Address Mapping | 22 |
| 2-5. | Logical Address-to-SDRAM Address Mapping for IBANK_POS = 0 | 23 |
| 2-6. | Address Mapping Example (IBANK_POS=0, IBANK=3, PAGESIZE=3, EBANK=1, 64-bit SDRAM) | 23 |
| 2-7. | Logical Address-to-SDRAM Address Mapping for IBANK_POS = 1 | 23 |
| 2-8. | Logical Address-to-SDRAM Address Mapping for IBANK_POS = 2 | 24 |
| 2-9. | Logical Address-to-SDRAM Address Mapping for IBANK_POS = 3 | 25 |
| 2-10. | DDR3 Memory Controller FIFO Description | 27 |
| 2-11. | Device and DDR3 Memory Controller Reset Relationship | 31 |
| 2-12. | Turnaround Time | 32 |
| 2-13. | DDR3 SDRAM Extended Mode Register 2 Configuration | 33 |
| 2-14. | DDR3 SDRAM Extended Mode Register 1 Configuration | 33 |
| 2-15. | DDR3 SDRAM Mode Register 0 Configuration | 33 |
| 2-16. | DATAx register to byte lane mapping | 36 |
| 2-17. | Performance Counter Filter Configuration | 41 |
| 3-1. | SDCFG Configuration | 48 |
| 3-2. | DDR3 Memory Refresh Specification..... | 48 |
| 3-3. | SDRFC Configuration..... | 49 |
| 3-4. | See the register section for the SDTIM* register where the field exists | 49 |
| 3-5. | See the register section for the SDTIM* register where the field exists | 50 |
| 3-6. | See the register section for the SDTIM* register where the field exists | 50 |
| 4-1. | DDR3 Memory Controller Registers (See datasheet memory map for base address) | 52 |
| 4-2. | DDR3 PHY Leveling Registers (See device datasheet for base address) | 53 |
| 4-3. | Module ID and Revision Register (MIDR) Field Descriptions | 55 |
| 4-4. | DDR3 Memory Controller Status Register (STATUS) Field Descriptions | 56 |
| 4-5. | SDRAM Configuration Register (SDCFG) Field Descriptions | 57 |
| 4-6. | SDRAM Refresh Control (SDRFC) Register Field Descriptions | 59 |
| 4-7. | SDRAM Timing 1 (SDTIM1) Register Field Descriptions | 60 |
| 4-8. | SDRAM Timing 2 (SDTIM2) Register Field Descriptions | 61 |
| 4-9. | SDRAM Timing 3 (SDTIM3) Register Field Descriptions | 62 |
| 4-10. | Power Management Control Register (PMCTL) Field Descriptions | 63 |
| 4-11. | VBUSM Configuration Register (VBUSM_CONFIG) Field Descriptions | 65 |
| 4-12. | Performance Counter 1 Register (PERF_CNT_1) Field Descriptions..... | 66 |
| 4-13. | Performance Counter 2 Register (PERF_CNT_2) Field Descriptions..... | 67 |
| 4-14. | Performance Counter Config Register (PERF_CNT_CFG) Field Descriptions | 68 |
| 4-15. | Performance Counter Master Region Select Register (PERF_CNT_SEL) Field Descriptions..... | 69 |
| 4-16. | Performance Counter Time Register (PERF_CNT_TIM) Field Descriptions | 70 |
| 4-17. | Interrupt Raw Status Register (IRQSTATUS_RAW_SYS) Field Descriptions | 71 |
| 4-18. | Interrupt Status Register (IRQSTATUS_SYS) Field Descriptions | 72 |
| 4-19. | Interrupt Enable Set Register (IRQSTATUS_SET_SYS) Field Descriptions | 73 |
| 4-20. | Interrupt Enable Clear Register (IRQSTATUS_CLR_SYS) Field Descriptions | 74 |
| 4-21. | SDRAM Output Impedance Calibration Configuration Register (ZQCFG) Field Descriptions | 75 |
| 4-22. | Read-Write Leveling Ramp Window Register (RDWR_LVL_RMP_WIN) Field Descriptions | 77 |
| 4-23. | Read-Write Leveling Ramp Control Register (RDWR_LVL_RMP_CTRL) Field Descriptions | 78 |
| 4-24. | Read-Write Leveling Control Register (RDWR_LVL_CTRL) Field Descriptions..... | 79 |

| | | |
|-------|---|-----|
| 4-25. | DDR PHY Control 1 Register (DDR_PHY_CTRL_1) Field Descriptions..... | 80 |
| 4-26. | Priority to Class-Of-Service Mapping Register (PRICOSMAP) Field Descriptions | 81 |
| 4-27. | Master ID to Class-Of-Service Mapping 1 Register (MSTID_COS_1_MAP) Field Descriptions | 82 |
| 4-28. | Master ID to Class-Of-Service Mapping 2 Register (MSTID_COS_2_MAP) Field Descriptions | 83 |
| 4-29. | ECC Control Register (ECCCTL) Field Descriptions | 84 |
| 4-30. | ECC Address Range 1 Register Field Descriptions | 85 |
| 4-31. | ECC Address Range 2 Register Field Descriptions | 86 |
| 4-32. | Read Write Execution Threshold Register (RWTHRESH) Field Descriptions | 87 |
| 4-33. | DDR3_CONFIG_0 Register (0x02620404) Field Descriptions..... | 88 |
| 4-34. | DDR3_CONFIG_1 Register (0x02620408) Field Descriptions | 89 |
| 4-35. | DDR3_CONFIG_2 Register (0x0262040C) Field Descriptions | 89 |
| 4-36. | DDR3_CONFIG_3 Register (0x02620410) Field Descriptions | 90 |
| 4-37. | DDR3_CONFIG_4 Register (0x02620414) Field Descriptions | 90 |
| 4-38. | DDR3_CONFIG_5 Register (0x02620418) Field Descriptions | 91 |
| 4-39. | DDR3_CONFIG_6 Register (0x0262041C) Field Descriptions | 91 |
| 4-40. | DDR3_CONFIG_7 Register (0x02620420) Field Descriptions | 92 |
| 4-41. | DDR3_CONFIG_8 Register (0x02620424) Field Descriptions | 92 |
| 4-42. | DDR3_CONFIG_9 Register (0x02620428) Field Descriptions | 93 |
| 4-43. | DDR3_CONFIG_10 Register (0x0262042C) Field Descriptions | 93 |
| 4-44. | DDR3_CONFIG_12 Register (0x02620434) Field Descriptions | 94 |
| 4-45. | DDR3_CONFIG_14 Register (0x0262043C) Field Descriptions | 94 |
| 4-46. | DDR3_CONFIG_15 Register (0x02620440) Field Descriptions | 95 |
| 4-47. | DDR3_CONFIG_16 Register (0x02620444) Field Descriptions | 95 |
| 4-48. | DDR3_CONFIG_17 Register (0x02620448) Field Descriptions | 96 |
| 4-49. | DDR3_CONFIG_18 Register (0x0262044C) Field Descriptions | 96 |
| 4-50. | DDR3_CONFIG_19 Register (0x02620450) Field Descriptions | 97 |
| 4-51. | DDR3_CONFIG_20 Register (0x02620454) Field Descriptions | 97 |
| 4-52. | DDR3_CONFIG_21 Register (0x02620458) Field Descriptions | 98 |
| 4-53. | DDR3_CONFIG_22 Register (0x0262045C) Field Descriptions | 98 |
| 4-54. | DDR3_CONFIG_23 Register (0x02620460) Field Descriptions | 99 |
| 4-55. | DDR3_CONFIG_24 Register (0x02620464) Field Descriptions | 99 |
| 4-56. | DDR3_CONFIG_25 Register (0x02620468) Field Descriptions..... | 100 |
| 4-57. | DDR3_CONFIG_26 Register (0x0262046C) Field Descriptions | 100 |
| 4-58. | DDR3_CONFIG_27 Register (0x02620470) Field Descriptions | 101 |
| 4-59. | DDR3_CONFIG_28 Register (0x02620474) Field Descriptions | 101 |
| 4-60. | DDR3_CONFIG_29 Register (0x02620478) Field Descriptions | 102 |
| 4-61. | DDR3_CONFIG_30 Register (0x0262047C) Field Descriptions | 102 |
| 4-62. | DDR3_CONFIG_31 Register (0x02620480) Field Descriptions | 103 |
| 4-63. | DDR3_CONFIG_32 Register (0x02620484) Field Descriptions | 103 |
| 4-64. | DDR3_CONFIG_33 Register (0x02620488) Field Descriptions | 104 |
| 4-65. | DDR3_CONFIG_34 Register (0x0262048C) Field Descriptions | 104 |
| 4-66. | DDR3_CONFIG_35 Register (0x02620490) Field Descriptions | 105 |
| 4-67. | DDR3_CONFIG_36 Register (0x02620494) Field Descriptions | 105 |
| 4-68. | DDR3_CONFIG_37 Register (0x02620498) Field Descriptions..... | 106 |
| 4-69. | DDR3_CONFIG_38 Register (0x0262049C) Field Descriptions | 106 |
| 4-70. | DDR3_CONFIG_39 Register (0x026204A0) Field Descriptions..... | 107 |
| 4-71. | DDR3_CONFIG_40 Register (0x026204A4) Field Descriptions..... | 107 |
| 4-72. | DDR3_CONFIG_41 Register (0x026204A8) Field Descriptions..... | 108 |
| 4-73. | DDR3_CONFIG_42 Register (0x026204AC) Field Descriptions | 108 |

| | | |
|-------|---|-----|
| 4-74. | DDR3_CONFIG_43 Register (0x026204B0) Field Descriptions..... | 109 |
| 4-75. | DDR3_CONFIG_44 Register (0x026204B4) Field Descriptions..... | 109 |
| 4-76. | DDR3_CONFIG_45 Register (0x026204B8) Field Descriptions..... | 110 |
| 4-77. | DDR3_CONFIG_46 Register (0x026204BC) Field Descriptions | 110 |
| 4-78. | DDR3_CONFIG_47 Register (0x026204C0) Field Descriptions | 111 |
| 4-79. | DDR3_CONFIG_48 Register (0x026204C4) Field Descriptions | 111 |
| 4-80. | DDR3_CONFIG_49 Register (0x026204C8) Field Descriptions | 112 |
| 4-81. | DDR3_CONFIG_50 Register (0x026204CC) Field Descriptions | 112 |
| 4-82. | DDR3_CONFIG_51 Register (0x026204D0) Field Descriptions | 113 |
| 4-83. | DDR3_CONFIG_52 Register (0x026204D4) Field Descriptions | 113 |
| 4-84. | DDR3_CONFIG_53 Register (0x026204D8) Field Descriptions | 114 |
| 4-85. | DDR3_CONFIG_54 Register (0x026204DC) Field Descriptions | 114 |
| 4-86. | DDR3_CONFIG_55 Register (0x026204E0) Field Descriptions..... | 115 |
| 4-87. | DDR3_CONFIG_56 Register (0x026204E4) Field Descriptions..... | 115 |
| 4-88. | DDR3_CONFIG_57 Register (0x026204E8) Field Descriptions..... | 116 |
| 4-89. | DDR3_CONFIG_58 Register (0x026204EC) Field Descriptions | 116 |
| 4-90. | DDR3_CONFIG_59 Register (0x026204F0) Field Descriptions..... | 117 |
| 4-91. | DDR3_CONFIG_60 Register (0x026204F4) Field Descriptions..... | 117 |

Preface

About This Manual

The DDR3 memory controller is used to interface with JESD79-3C standard compliant SDRAM devices. Memory types such as DDR1 SDRAM, DDR2 SDRAM, SDR SDRAM, SBSRAM, and asynchronous memories are not supported. The DDR3 memory controller SDRAM can be used for program and data storage.

Notational Conventions

This document uses the following conventions:

- Commands and keywords are in **boldface** font.
- Arguments for which you supply values are in *italic* font.
- Terminal sessions and information the system displays are in screen font.
- Information you must enter is in **boldface screen font**.
- Elements in square brackets ([]) are optional.

Notes use the following conventions:

NOTE: Means reader take note. Notes contain helpful suggestions or references to material not covered in the publication.

The information in a caution or a warning is provided for your protection. Please read each caution and warning carefully.

CAUTION

Indicates the possibility of service interruption if precautions are not taken.

WARNING

Indicates the possibility of damage to equipment if precautions are not taken.

Related Documentation from Texas Instruments

| | |
|--|-------------------------|
| <i>C66x CorePac User Guide</i> | SPRUGW0 |
| <i>C66x CPU and Instruction Set Reference Guide</i> | SPRUGH7 |
| <i>Enhanced Direct Memory Access 3 (EDMA3) for KeyStone Devices User Guide</i> | SPRUGS5 |
| <i>External Memory Interface (EMIF16) for KeyStone Devices User Guide</i> | SPRUGZ3 |
| <i>Interrupt Controller (INTC) for KeyStone Devices User Guide</i> | SPRUGW4 |

Introduction

This document describes the operation of the DDR3 module in the KeyStone II devices. (Refer to the device-specific data manual for exact device applicability.) The DDR3 module is accessible across all the cores and all system masters that are not cores.

| Topic | Page |
|---|-------------|
| 1.1 Purpose of the Peripheral..... | 14 |
| 1.2 Features..... | 14 |
| 1.3 Industry Standard(s) Compliance Statement..... | 14 |

1.1 Purpose of the Peripheral

The DDR3 memory controller is used to interface with JESD79-3C standard compliant SDRAM devices. Memory types such as DDR1 SDRAM, DDR2 SDRAM, SDR SDRAM, SBSRAM, and asynchronous memories are not supported. The DDR3 memory controller SDRAM can be used for program and data storage. The KeyStone device has one instance.

1.2 Features

The DDR3 controller supports the following features:

- Supports JEDEC standard JESD79-3C – DDR3 compliant devices
- 33-bit address for 8 GB of address space
- 16/32/64-bit data bus width support
- CAS latencies: 5, 6, 7, 8, 9, 10, and 11
- 1, 2, 4, and 8 internal banks
- Burst Length: 8
- Burst Type: sequential
- 8GB address space available over one or two chip selects
- Page sizes: 256, 512, 1024, and 2048-word
- SDRAM auto initialization from reset or configuration change
- Self-refresh mode
- Prioritized refresh scheduling
- Programmable SDRAM refresh rate and backlog counter
- Programmable SDRAM timing parameters
- Big and little endian modes
- ECC on SDRAM data bus
- 8-bit ECC per 64-bit data quanta without additional cycle latency
- Two latency classes supported
- UDIMM Address mirroring is not supported

1.3 Industry Standard(s) Compliance Statement

The DDR3 controller is compliant with the JESD79-3C DDR3 SDRAM standard.

Peripheral Architecture

The DDR3 controller interfaces with most standard DDR3 SDRAM devices. It supports self-refresh mode and prioritized refresh. In addition, it provides flexibility through programmable parameters such as the refresh rate, CAS latency, and many SDRAM timing parameters. The following sections describe the architecture of the DDR3 controller as well as how to interface and configure it to perform read and write operations to DDR3 SDRAM devices. Examples for interfacing the DDR3 controller to a common DDR3 SDRAM device are shown in [Section 3.1](#).

| Topic | Page |
|--|-----------|
| 2.1 Clock Interface | 17 |
| 2.2 SDRAM Memory Map | 17 |
| 2.3 Signal Descriptions | 17 |
| 2.4 Protocol Descriptions | 18 |
| 2.5 Address Mapping | 22 |
| 2.6 DDR3 Memory Controller Interface | 27 |
| 2.7 Refresh Scheduling | 30 |
| 2.8 Self-Refresh Mode | 30 |
| 2.9 Reset Considerations | 31 |
| 2.10 Turnaround Time | 32 |
| 2.11 DDR3 SDRAM Memory Initialization | 32 |
| 2.12 Dual Rank Support | 34 |
| 2.13 Leveling | 34 |
| 2.14 Interrupt Support | 39 |
| 2.15 EDMA Event Support | 39 |
| 2.16 Emulation Considerations | 39 |
| 2.17 ECC | 39 |
| 2.18 Power Management | 40 |
| 2.19 Performance Monitoring | 40 |

2.1 Clock Interface

There are two clocking schemes in the DDR3 controller - the clocking scheme used to drive the DDR3 controller and the clocking scheme used to drive the DDR3 I/O interface. The DDR3 controller is clocked by the DSP/2 clock domain. The I/O interface is driven by the DDR3 memory clock (half the data rate).

2.2 SDRAM Memory Map

For information describing the DDR3 memory map, see the device-specific data manual.

2.3 Signal Descriptions

The DDR3 memory controller signals are shown in [Figure 2-1](#) and described in [Figure 2-1](#).

- The maximum data bus is 64-bits wide.
- The address bus is 33-bits wide.
- Two differential output clocks driven by internal clock sources.
- Command signals: Row and column address strobe, write enable strobe, data strobe, and data mask.
- Two chip selects and two clock enable signals.

Figure 2-1. DDR3 Memory Control Signals

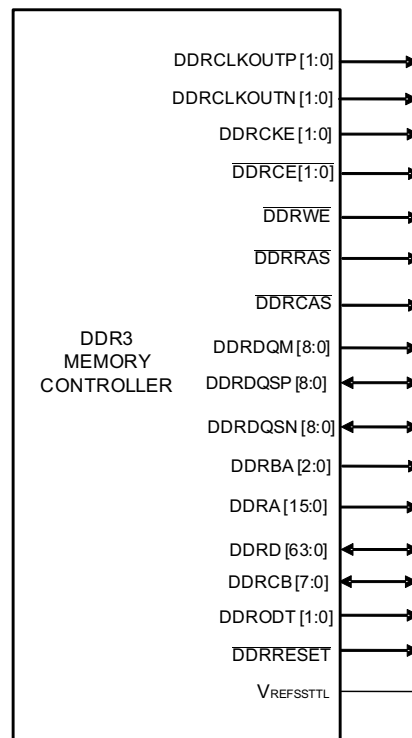

Table 2-1. DDR3 Memory Controller Signal Descriptions

| Pin | Description |
|--------------|--|
| DDRD [63:0] | Bidirectional data bus. Input for data reads and output for data writes. |
| DDRCB [7:0] | Bidirectional data bus (check bits) for ECC byte lane. Input for data reads and output for data writes. |
| DDRA [15:0] | External address output. |
| DDRCE0 | Active-low chip enable for memory space CE0. DDRCE0z is used to enable the DDR3 SDRAM memory device during external memory accesses. |
| DDRCE1 | Active-low chip enable for memory space CE1. DDRCE1z is used to enable the DDR3 SDRAM memory device during external memory accesses. |
| DDRDQM [8:0] | Active-high output data mask. |

Table 2-1. DDR3 Memory Controller Signal Descriptions (continued)

| Pin | Description |
|---|--|
| DDR3CLKOUTP [1:0]/ DDR3CLKOUTN [1:0] | Differential clock outputs. |
| DDRCKE [1:0] | Clock enable (used for self-refresh mode). |
| DDRCAS | Active-low column address strobe. |
| DDRRAS | Active-low row address strobe. |
| DDRWE | Active-low write enable. |
| DDRQSP [8:0]/ DDRQSN [8:0] | Differential data strobe bidirectional signals. |
| DDRODT [1:0] | On-die termination signal(s) to external DDR3 SDRAM |
| DDRBA [2:0] | Bank-address control outputs |
| VREFSSTTL | DDR3 Memory Controller reference voltage. This voltage must be supplied externally. For more details, see the device-specific data manual. |
| DDRSRATE [1:0] | See the section on Slew Rate Control in the Hardware Design Guide for Keystone Devices (SPRAB12) for details. |

2.4 Protocol Descriptions

The DDR3 memory controller supports the DDR3 SDRAM commands listed in [Table 2-2](#).

Table 2-2. DDR3 SDRAM Commands

| Command | Function |
|-------------|--|
| ACT | Activates the selected bank and row. |
| PREA | Precharge all command. Deactivates (precharges) all banks. |
| PRE | Precharge single command. Deactivates (precharges) a single bank. |
| DES | Device Deselect. |
| EMRS | Extended Mode Register set. Allows altering the contents of the mode register. |
| MRS | Mode register set. Allows altering the contents of the mode register. |
| NOP | No operation. |
| PDE | Power down entry |
| PDX | Power down exit |
| RD | Inputs the starting column address and begins the read operation. |
| REF | Autorefresh cycle |
| SRE | Self-refresh entry |
| SRX | Self-refresh exit |
| WR | Inputs the starting column address and begins the write operation. |
| ZQCS | ZQ Calibration short operation |
| ZQCL | ZQ Calibration long operation |

Table 2-3 shows the signal truth table for the DDR3 SDRAM commands.

Table 2-3. Truth Table for DDR3 SDRAM Commands⁽¹⁾

| DDR3 SDRAM Signals | CKE | | CS# | RAS# | CAS# | WE# | BA [2:0] | A [15:13] | A12 | A10 | A [9:0], A11 |
|--------------------------------|----------------|---------------|-----|--------|--------|-------|-------------|------------------|-----------|-----------|-----------------|
| DDR3 Memory controller signals | DDRCKE | | DCE | DDRRAS | DDRCAS | DDRWE | DDRBA [2:0] | DDRA [15:13] | DDRA [12] | DDRA [10] | DDRA [9:0],[11] |
| | Previous Cycle | Current Cycle | | | | | | | | | |
| ACT | H | H | L | L | H | H | BA | Row Address (RA) | | | |
| PREA | H | H | L | L | H | L | V | V | V | H | V |
| PRE | H | H | L | L | H | L | BA | V | V | L | V |
| MRS | H | H | L | L | L | L | BA | OP Code | | | |
| EMRS ⁽²⁾ | H | H | L | L | L | L | BA | OP Code | | | |
| RD (BL8) | H | H | L | H | L | H | BA | RFU | V | L | CA |
| WR (BL8) | H | H | L | H | L | L | BA | RFU | V | L | CA |
| REF | H | H | L | L | L | H | V | V | V | V | V |
| SRE ⁽³⁾ | H | L | L | L | L | H | V | V | V | V | V |
| SRX ⁽³⁾⁽⁴⁾ | L | H | H | X | X | X | X | X | X | X | X |
| | | | L | H | H | H | V | X | V | V | V |
| NOP | H | H | L | H | H | H | V | V | V | V | V |
| DES ⁽⁵⁾ | H | H | H | X | X | X | X | X | X | X | X |
| PDE ⁽⁶⁾ | H | L | L | H | H | H | V | V | V | V | V |
| | | | X | X | X | X | X | X | X | X | X |
| PDX ⁽⁶⁾ | L | H | L | H | H | H | V | V | V | V | V |
| | | | X | X | X | X | X | X | X | X | X |
| ZQCL | H | H | L | H | H | L | X | X | X | H | X |
| ZQCS | H | H | L | H | H | L | X | X | X | L | X |

⁽¹⁾ LEGEND: H = Logic High, L = Logic Low, X = Don't Care, RA = Row Address, CA = Column Address, RFU = Reserved for future use, V = Valid

⁽²⁾ For extended mode register set (EMRS) command, bank address (BA) pins select an extended mode register (EMR).

⁽³⁾ ODT function is not available during self-refresh.

⁽⁴⁾ Self-refresh exit (SRE) is asynchronous.

⁽⁵⁾ The Deselect (DES) command performs the same function as No Operation (NOP).

⁽⁶⁾ The Power down mode does not perform any self-refresh operation.

2.4.1 Mode Register Set (MRS or EMRS)

DDR3 SDRAM contains mode and extended mode registers that configure the DDR3 memory for operation. These registers control burst type, burst length, CAS latency, DLL enable/disable, etc.

The DDR3 memory controller programs the mode and extended mode registers of the DDR3 memory by issuing MRS and EMRS commands. MRS and EMRS commands can be issued during DDR3 initialization as well as during normal operation as long as the external SDRAM is in idle state. When the MRS or EMRS command is executed, the value on DDRBA [1:0] selects the mode register to be written and the data on DDRA [12:0] is loaded into the register. DDRA [15:13] and DDRBA [2] are reserved and are programmed to 0 during MRS (or EMRS).

Each mode register allows programming of different sets of DDR3 SDRAM parameters. The DDR3 memory controller programs the mode registers in compliance with the JEDEC JESD79-3C spec. For more information about mode registers and how they are programmed, see the JEDEC spec.

2.4.2 Refresh Mode

The DDR3 memory controller issues refresh commands (REF) to the DDR3 SDRAM device. REF is automatically preceded by a Precharge-all (PREA) command, ensuring the deactivation of all CE spaces and banks selected.

Following the PREA command, the DDR3 memory controller begins performing refreshes at a rate defined by the refresh rate (REFRESH_RATE) field in the SDRAM refresh control register (SDRFC). In general, a refresh command needs to be issued to the DDR3 SDRAM regularly every tREFI interval. To allow for efficient operation, refresh commands can be postponed a maximum of 8 times. Also, at any given time a maximum of 16 refresh commands can be issued within a 2 xtREFI interval. For more information on refresh command timing, see the JEDEC spec.

2.4.3 Activation

The ACTIVE command is used to open (or activate) a row in a specific bank for a subsequent access. DDRBA [2:0] select the bank, and the address provided on DDRA[15:0] selects the row. This row remains active (or open) for accesses until a precharge command is issued to that bank. A PRECHARGE command must be issued before opening a different row in the same bank.

When the DDR3 memory controller issues an ACT command, a delay of tRCD is incurred before a read or write command is issued. Reads or writes to the currently active row and bank of memory can achieve much higher throughput than reads or writes to random areas because every time a new row is accessed, the ACT command must be issued and a delay of tRCD incurred.

2.4.4 Deactivation

The precharge command is used to deactivate the open row in a particular bank (PRE) or the open row in all banks (PREA). The bank(s) will be available for a subsequent row activation a specified time (tRP) after the precharge command is issued, except in the case of concurrent auto precharge, where a read or write command to a different bank is allowed as long as it does not interrupt the data transfer in the current bank and does not violate any other timing parameters. A PRE command is allowed if there is no open row in that bank (idle state) or if the previously open row is already in the process of precharging. During a PREA command, DDRA [10] is driven high to ensure deactivation of all banks.

2.4.5 READ Command

[Figure 2-2](#) shows the DDR3 memory controller performing a read burst from DDR3 SDRAM. The READ command initiates a burst read operation to an active row. The column address is driven on DDRA [15:0], and the bank address is driven on DDRBA [2:0].

The DDR3 memory controller uses a burst length of 8, and has a programmable CAS latency of 5, 6, 7, 8, 9, 10, or 11. The CAS latency is five cycles in [Figure 2-2](#). Read latency can be programmed in the DDR PHY Control 1 register and can take integer values from CL+1 to CL+7. In this figure it has been programmed to CL + 1. Because the default burst size is 8, the DDR3 memory controller returns 8 words of data for every read command. Word size is nothing but the DDR3 interface bus width.

If additional accesses are not pending to the DDR3 memory controller, the read burst completes and the unneeded data is disregarded. If additional accesses are pending, based on the arbitration result, the DDR3 memory controller can terminate the read burst and start a new read burst.

Figure 2-2. READ Command

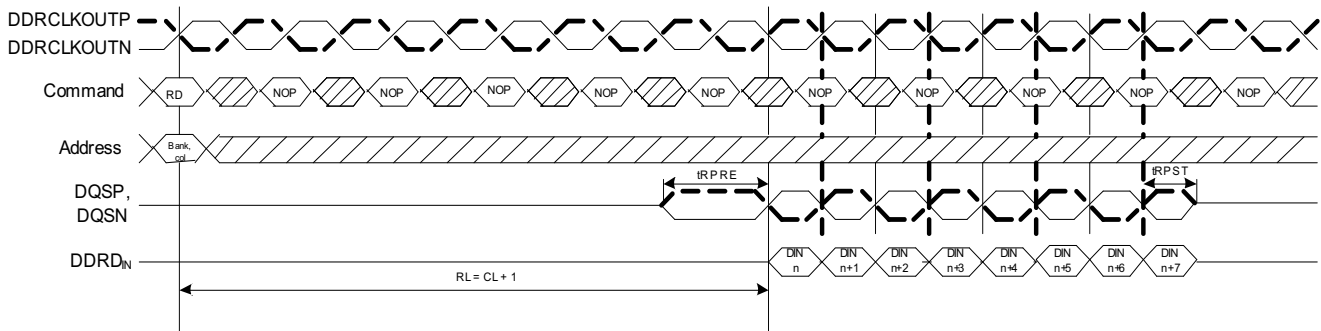

NOP commands are shown for ease of illustration; other commands may be valid at these times

2.4.6 Write (WR) Command

Prior to a WRT command, the desired bank and row are activated by the ACT command. Following the WRT command, a write latency is incurred. Write latency is equal to CAS latency minus 1. All writes have a burst length of 8.

Figure 2-3 shows the timing for a write on the DDR3 memory controller. If the transfer request is for less than 8 words, depending on the scheduling result and the pending commands, the DDR3 memory controller can:

- Mask out the additional data using DDRDQM outputs
- Terminate the write burst and start a new write burst

Figure 2-3. WRITE Command

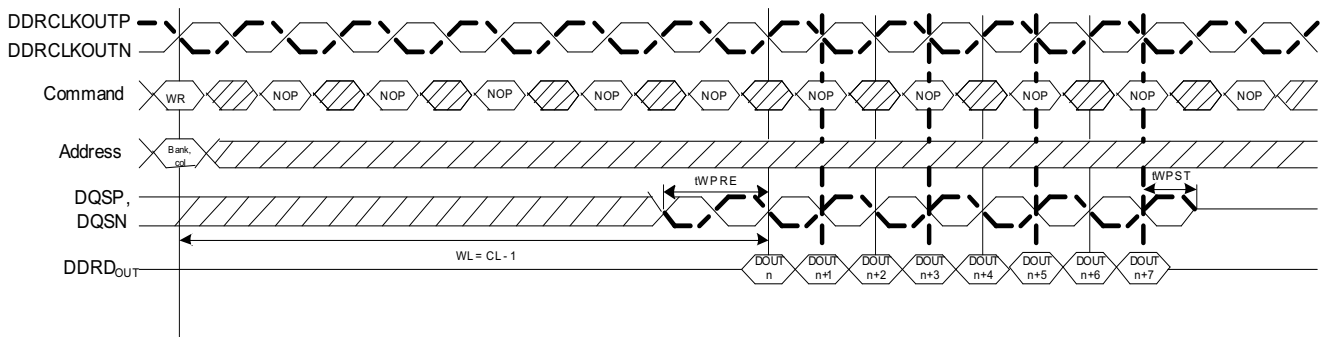

NOP commands are shown for ease of illustration; other commands may be valid at these times

2.5 Address Mapping

The DDR3 memory controller views external DDR3 SDRAM as one continuous block of memory across the two chip-selects. If smaller devices are used, the memory is seen to roll over. The DDR3 memory controller receives DDR3 memory access requests along with a 33-bit logical address from the rest of the system. The controller uses the logical address to generate a row/page, column, bank address, and chip selects for the DDR3 SDRAM. The number of bank and column address bits used is determined by the IBANK and PAGESIZE fields. The chip selection pins used are determined by the EBANK field (Table 2-4).

Table 2-4. Bank Configuration Register Fields for Address Mapping

| Bit Field | Bit Value | Bit Description |
|-----------|-----------|---|
| IBANK | | Defines the number of internal banks on external DDR3 memory |
| | 0 | 1 bank |
| | 1h | 2 banks |
| | 2h | 4 banks |
| PAGESIZE | 3h | 8 banks |
| | | Defines the page size of each page of the external DDR3 memory |
| | 0 | 256 words (requires 8 column address bits) |
| | 1h | 512 words (requires 9 column address bits) |
| EBANK | 2h | 1024 words (requires 10 column address bits) |
| | 3h | 2048 words (requires 11 column address bits) |
| | | External chip select setup. Defines whether SDRAM accesses use 1 or 2 chip select lines |
| EBANK | 0 | Use only chip enable 0 for all SDRAM accesses |
| | 1 | Use chip enables 0 and 1 for SDRAM accesses |

NOTE: IBANK should always be programmed to 3h since DDR3 memory devices offer only 8-bank support unlike DDR2 with the option of 4-bank or 8-bank memory devices.

The IBANK_POS bit field in the SDRAM Config Register (SDCFG) determines how many banks the DDR3 controller can interleave amongst. For IBANK_POS = 0, as source address increments across SDRAM page boundaries, the DDR3 controller moves to the same page in the next bank on current device (chip-select).

After the page has been accessed in all banks of the current device, the same page is accessed in all banks in the next device. This is followed by accessing the next page in the first device and the process continues. To the DDR3 SDRAM, this process looks as shown on Figure 2-5. Thus IBANK_POS = 0 serves to maximize number of open banks within overall SDRAM space. The ROWSIZE parameter is not used by the DDR3 controller if IBANK_POS = 0. See Figure 2-5.

Thus 16 banks (eight internal banks across two chip selects) can be kept open at a time, interleaving among all of them.

Table 2-5. Logical Address-to-SDRAM Address Mapping for IBANK_POS = 0

| Logical Address [32:N] | | | | | | | |
|---|---------|---|--------|---|--------|--|---------|
| Row Address | | Chip Select | | Bank Address[2:0] | | Column Address | |
| ROW SIZE | nrb | EBANK | ncs | IBANK | nbb | PAGE SIZE | ncb |
| Don't care | 16 bits | 0 | 0 bits | 0 | 0 bits | 0 | 8 bits |
| | | 1 | 1 bit | 1 | 1 bit | 1 | 9 bits |
| | | | | 2 | 2 bits | 2 | 10 bits |
| | | | | 3 | 3 bits | 3 | 11 bits |
| Logical address mapping for row address | | Logical address mapping for chip select | | Logical address mapping for bank address[1:0] | | Logical address mapping for column address | |
| MSB | LSB | MSB | LSB | MSB | LSB | MSB | LSB |
| M3+nrb-1 | M3+1 | M3=M2+ncs-1 | M2+1 | M2=M1+nbb-1 | M1+1 | M1=N+ncb-1 | N |

NOTE: N=1 for 16-bit SDRAM, N=2 for 32-bit SDRAM and N=3 for 64-bit SDRAM. ROWSIZE is not used for IBANK_POS = 0. nrb = Number of row bits. ncs = Number of chip select bits. nbb = Number of bank select bits determined by bank address [2:0].

For example, if IBANK = 3, PAGESIZE = 3 and EBANK = 1, the address mapping for a 64-bit SDRAMs would be as shown below in [Table 2-6](#). For 64-bit, N = 3.

**Table 2-6. Address Mapping Example
(IBANK_POS=0, IBANK=3, PAGESIZE=3, EBANK=1, 64-bit SDRAM)**

| SDCFG bit | | | Logical Address | | | |
|-----------|-------|----------|-----------------|-------|-------|--------|
| IBANK | EBANK | PAGESIZE | 33:18 | 17 | 16:14 | 13:3 |
| 3 | 1 | 3 | Don't care | ncs=1 | nbb=3 | ncb=11 |

For IBANK_POS = 1, interleaving is the same as IBANK_POS = 0 but limited to 4 banks per device (per chip select). Thus 16 banks (8 internal banks across 2 chip selects) can be kept open at a time, but interleaving among only 8 of them. The address mapping is shown in [Table 2-7](#).

Table 2-7. Logical Address-to-SDRAM Address Mapping for IBANK_POS = 1

| Logical Address [32:N] | | | | | | | | | |
|---|--------|---|---------|---|--------|---|--------|--|---------|
| Bank Address [2] | | Row Address | | Chip Select | | Bank Address [1:0] | | Column Address | |
| IBANK | nbb2 | ROW SIZE | nrb | EBANK | ncs | IBANK | nbb10 | PAGE SIZE | ncb |
| 0 | 0 bits | 0 | 9 bits | 0 | 0 bits | 0 | 0 bits | 0 | 8 bits |
| 1 | 0 bits | 1 | 10 bits | 1 | 1 bit | 1 | 1 bit | 1 | 9 bits |
| 2 | 0 bits | 2 | 11 bits | | | 2 | 2 bits | 2 | 10 bits |
| 3 | 1 bit | 3 | 12 bits | | | 3 | 2 bits | 3 | 11 bits |
| | | 4 | 13 bits | | | | | | |
| | | 5 | 14 bits | | | | | | |
| | | 6 | 15 bits | | | | | | |
| | | 7 | 16 bits | | | | | | |
| Logical address mapping for bank_address[2] | | Logical address mapping for row address | | Logical address mapping for chip select | | Logical address mapping for bank address[1:0] | | Logical address mapping for column address | |
| MSB | LSB | MSB | LSB | MSB | LSB | MSB | LSB | MSB | LSB |
| M4+nbb2-1 | M4+1 | M4=M3+nrb-1 | M3+1 | M3=M2+ncs-1 | M2+1 | M2=M1+nbb10-1 | M1+1 | M1=N+ncb-1 | N |

NOTE: N=1 for 16-bit SDRAM; N=2 for 32-bit SDRAM; N=3 for 64-bit SDRAM. ncb = Number of column address bits. nrb = Number of row bits. ncs = Number of chip select bits. nbb10 = Number of bank select bits determined by bank address [1:0]. nbb2 = Number of bank select bits determined by bank address[2].

For IBANK_POS = 2, interleaving is the same as IBANK_POS = 0 but limited to 2 banks per device (per chip select). Thus 16 banks (8 internal banks across 2 chip selects) can be kept open at a time, but interleaving among only 4 of them. The address mapping is shown in Table 2-8. An address mapping table for the desired configuration can be generated on the lines of Table 2-6.

Table 2-8. Logical Address-to-SDRAM Address Mapping for IBANK_POS = 2

| Logical Address [32:N] | | | | | | | | | |
|---|--------|---|---------|---|--------|---|--------|--|---------|
| Bank Address [2:1] | | Row Address | | Chip Select | | Bank Address [0] | | Column Address | |
| IBANK | nbb21 | ROW SIZE | nrb | EBANK | ncs | IBANK | nbb0 | PAGE SIZE | ncb |
| 0 | 0 bits | 0 | 9 bits | 0 | 0 bits | 0 | 0 bits | 0 | 8 bits |
| 1 | 0 bits | 1 | 10 bits | 1 | 1 bit | 1 | 1 bit | 1 | 9 bits |
| 2 | 1 bit | 2 | 11 bits | | | 2 | 1 bit | 2 | 10 bits |
| 3 | 2 bits | 3 | 12 bits | | | 3 | 1 bit | 3 | 11 bits |
| | | 4 | 13 bits | | | | | | |
| | | 5 | 14 bits | | | | | | |
| | | 6 | 15 bits | | | | | | |
| | | 7 | 16 bits | | | | | | |
| Logical address mapping for bank_address[2:1] | | Logical address mapping for row address | | Logical address mapping for chip select | | Logical address mapping for bank address[0] | | Logical address mapping for column address | |
| MSB | LSB | MSB | LSB | MSB | LSB | MSB | LSB | MSB | LSB |
| M4+nbb21-1 | M4+1 | M4=M3+nrb-1 | M3+1 | M3=M2+ncs-1 | M2+1 | M2=M1+nbb0-1 | M1+1 | M1=N+ncb-1 | N |

NOTE: N=1 for 16-bit SDRAM; N=2 for 32-bit SDRAM; N=3 for 64-bit SDRAM. ncb = Number of column address bits. nrb = Number of row bits. ncs = Number of chip select bits. nbb0 = Number of bank select bits determined by bank address [0]. nbb21 = Number of bank select bits determined by bank address[2:1]

For IBANK_POS = 3, interleaving among banks within a device (per chip select) is not permitted. Thus, 16 banks (8 internal banks across 2 chip selects) can be kept open at a time, but interleaving among only 2 of them. [Table 2-9](#) shows the address mapping. Address mapping for the desired configuration can be generated on the lines of [Table 2-6](#).

Table 2-9. Logical Address-to-SDRAM Address Mapping for IBANK_POS = 3

| Logical Address [32:N] | | | | | | | |
|---|--------|---|---------|---|--------|--|---------|
| Bank Address [2:0] | | Row Address | | Chip Select | | Column Address | |
| IBANK | nbb20 | ROW SIZE | nrb | EBANK | ncs | PAGE SIZE | ncb |
| 0 | 0 bits | 0 | 9 bits | 0 | 0 bits | 0 | 8 bits |
| 1 | 1 bit | 1 | 10 bits | 1 | 1 bit | 1 | 9 bits |
| 2 | 2 bits | 2 | 11 bits | | | 2 | 10 bits |
| Logical address mapping for bank_address[2:0] | | Logical address mapping for row address | | Logical address mapping for chip select | | Logical address mapping for column address | |
| MSB | LSB | MSB | LSB | MSB | LSB | MSB | LSB |
| M3+nbb20-1 | M3+1 | M3=M2+nrb-1 | M2+1 | M2=M1+ncs-1 | M1+1 | M1=N+ncb-1 | N |

The DDR3 memory controller never opens more than one page per bank. The active row is left open until it becomes necessary to close it, thus decreasing the deactivate-reactivate overhead.

The number of banks between which the controller can interleave is maximum when IBANK_POS=0 and reduces progressively as IBANK_POS is increased from 1 to 3. Thus, maximum performance is obtained when IBANK_POS=0. However, to trade off performance for power savings, the application can program IBANK_POS to a non-zero value.

Figure 2-4. Logical Address-to-DDR3 SDRAM Address Map (EBANK=0)

| Col. 0 | Col. 1 | Col. 2 | Col. 3 | Col. 4 | ... | Col. M-1 | Col. M | |
|--------|--------|--------|--------|--------|-----|----------|--------|---------------|
| | | | | | ... | | | Row 0, bank 0 |
| | | | | | ... | | | Row 0, bank 1 |
| | | | | | ... | | | Row 0, bank 2 |
| * | * | * | * | * | ... | * | * | * |
| * | * | * | * | * | ... | * | * | * |
| * | * | * | * | * | ... | * | * | * |
| | | | | | ... | | | Row 0, bank P |
| | | | | | ... | | | Row 1, bank 0 |
| | | | | | ... | | | Row 1, bank 1 |
| | | | | | ... | | | Row 1, bank 2 |
| * | * | * | * | * | ... | * | * | * |
| * | * | * | * | * | ... | * | * | * |
| * | * | * | * | * | ... | * | * | * |
| | | | | | ... | | | Row 1, bank P |
| | | | | | ... | | | * |
| | | | | | ... | | | * |
| | | | | | ... | | | * |
| | | | | | ... | | | Row N, bank 0 |
| | | | | | ... | | | Row N, bank 1 |
| | | | | | ... | | | Row N, bank 2 |
| * | * | * | * | * | ... | * | * | * |
| * | * | * | * | * | ... | * | * | * |
| * | * | * | * | * | ... | * | * | * |
| | | | | | ... | | | Row N, bank P |

A M is number of columns (as determined by PAGESIZE) minus 1, P is number of banks (as determined by IBANK) minus 1, and N is number of rows (as determined by both PAGESIZE and IBANK) minus 1.

Figure 2-5. DDR3 SDRAM Column, Row, and Bank Access (EBANK=0)

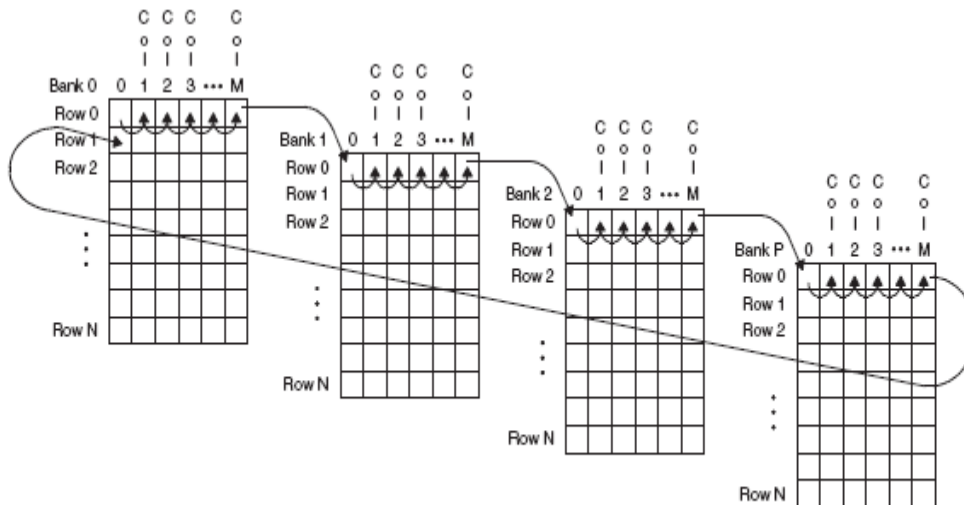

A M is number of columns (as determined by PAGESIZE) minus 1, P is number of banks (as determined by IBANK) minus 1, and N is number of rows (as determined by both PAGESIZE and IBANK) minus 1.

2.6 DDR3 Memory Controller Interface

To move data efficiently from on-chip resources to an external DDR3 SDRAM device, the DDR3 memory controller makes use of a Command FIFO, a Write Data FIFO, a Write Status FIFO, a Read Command FIFO, and two Read Data FIFOs and command and data schedulers. Table 2-10 describes the purpose of each FIFO. Figure 2-6 shows the block diagram of the DDR3 memory controller FIFOs. Commands, write data, and read data arrive at the DDR3 memory controller parallel to each other. The same peripheral bus is used to write and read data from external memory as well as internal memory-mapped registers (MMR).

Table 2-10. DDR3 Memory Controller FIFO Description

| FIFO | Description | Depth |
|--------------------|--|-------------------|
| Command | Stores all commands coming from on-chip requestors | 16 |
| Write Data | Stores write data coming from on-chip requestors to memory | 20 (512-bit wide) |
| Write Status | Stores the write status information for each write transaction | 7 |
| Read Command | Stores all read transactions that are to be issued to on-chip requestors | 22 |
| SDRAM Read Data | Stores read data coming from SDRAM memory to on-chip requestors | 22 (256-bit wide) |
| Register Read Data | Stores read data coming from MMRs to on-chip requestors | 2 (256-bit wide) |

Figure 2-6. DDR3 Memory Controller FIFO Block Diagram

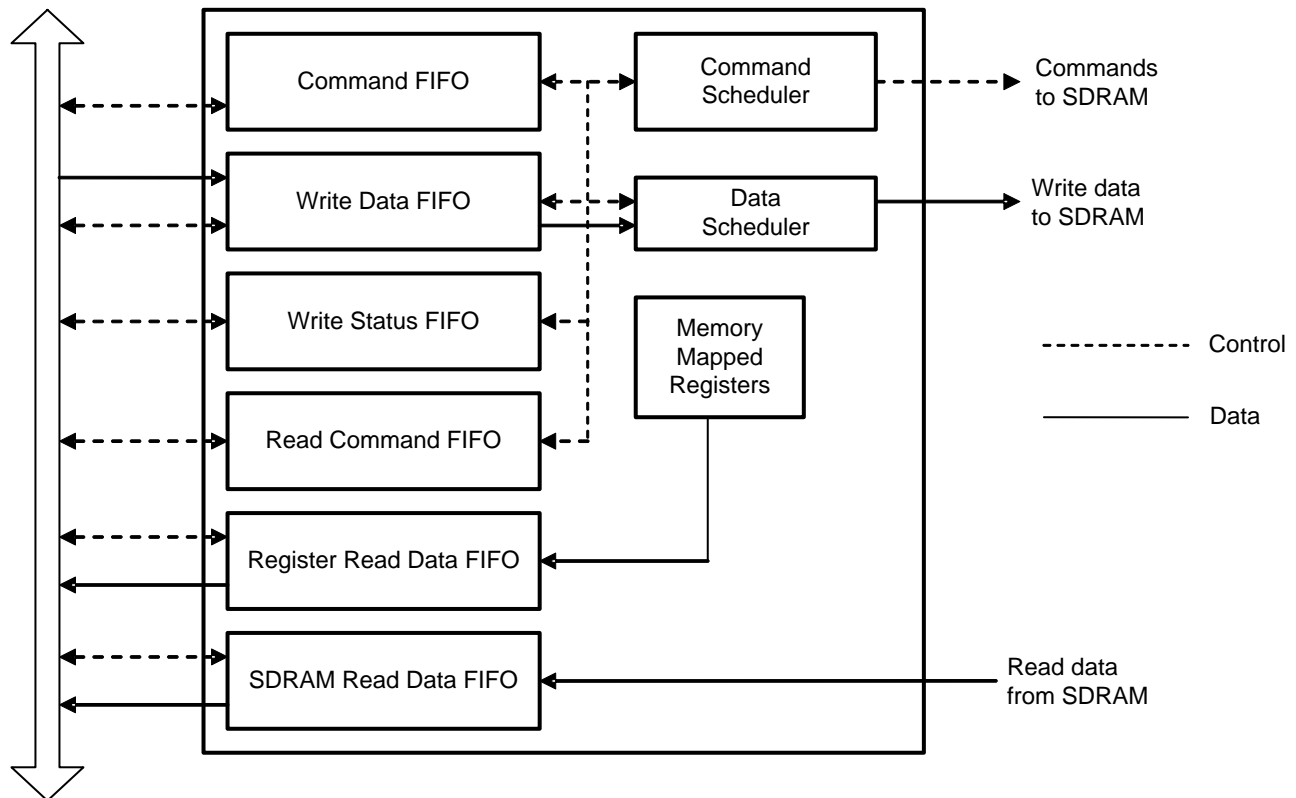

2.6.1 Arbitration

The DDR3 memory controller performs command reordering and scheduling in an attempt to achieve efficient transfers with maximum throughput. The goal is to maximize the utilization of the data, address, and command buses while hiding the overhead of opening and closing DDR3 SDRAM rows. Command reordering takes place within the command FIFO.

The DDR3 memory controller examines all the commands stored in the command FIFO to schedule commands to the external memory. For each master, the DDR3 memory controller reorders the commands based on the following rules:

- The DDR3 controller will advance a read command before an older write command from the same master if the read is to a different block address (2048 bytes) and the read priority is equal to or greater than the write priority.
- The DDR3 controller will block a read command, regardless of the master or priority if that read command is to the same block address (2048 bytes) as an older write command.

Thus, one pending read or write for a master might exist.

- Among all pending reads, the DDR3 controller selects all reads that have their corresponding SDRAM banks already open.
- Among all pending writes, the DDR3 controller selects all writes that have their corresponding SDRAM banks already open.

As a result of the above reordering, several pending reads and writes may exist that have their corresponding banks open. The highest priority read is selected from pending reads, and the highest priority write from pending writes. If two or more commands have the highest priority, the oldest command is selected. As a result, there might exist a final read and a final write command. Either the read or the write command will be selected depending on the value programmed in the [Section 4.30](#).

The DDR3 controller supports interleaving of commands for maximum efficiency. In other words, the controller will partially execute one command and switch to executing another higher priority command before finishing the first command.

Apart from reads and writes the DDR3 controller also needs to open and close SDRAM banks, and maintain the refresh counts for an SDRAM. The priority of SDRAM commands with respect to refresh levels are as follows:

1. (Highest priority) SDRAM refresh request due to Refresh Must level of refresh urgency reached.
2. Read request without a higher priority write (from the reordering algorithm above)
3. Write request.
4. SDRAM Activate commands.
5. SDRAM Deactivate commands.
6. SDRAM Power-Down request.
7. SDRAM refresh request due to Refresh May or Release level of refresh urgency reached.
8. (Lowest priority) SDRAM self-refresh request.

2.6.2 Command Starvation

While running the scheduling algorithm described in [Section 2.6.1](#), the DDR3 memory controller is subject to the following:

1. A continuous stream of high priority commands can block lower priority commands.
2. A continuous stream of SDRAM commands to a row in an open bank can block commands to another row in the same bank.

To avoid a continuous blocking effect, the priority of the oldest command is momentarily raised over all other commands when the latency counter for the oldest command expires. The latency counter for the oldest command (PR_OLD_COUNT) is configurable in the Latency Configuration Register. In addition to this, the order of command accesses can also be tailored by grouping commands into two categories or “classes” and assigning different latency expiration counters to each category. See [Section 2.6.4](#) for more information.

On top of the above scheduling, the highest priority condition is a removal of hard or soft reset. If this occurs, the DDR3 controller abandons whatever it is currently doing and commences its startup sequence. In this case, commands and data stored in the FIFOs are lost. The startup sequence also commences whenever the SDRAM Config register is written and INITREF_DIS field in SDRAM Refresh Control register (SDRFC) is set to 0. In this case, commands and data stored in the FIFOs are not lost. The DDR3 controller will ensure that in-flight read or write transactions to the SDRAM are complete before starting the initialization sequence.

2.6.3 Possible Race Condition

A race condition may exist when certain masters write data to the DDR3 memory controller. For example, if master A passes a software message via a buffer in DDR3 memory and does not wait for indication that the write completes, when master B attempts to read the software message it may read stale data and therefore receive an incorrect message. In order to confirm that a write from master A has landed before a read from master B is performed, master A must wait for the write to complete before indicating to master B that the data is ready to be read. For example, an EDMA transfer controller should wait for the transfer completion event to occur before signaling a CorePac to read the message from DDR3.

If master A does not wait for indication that a write is complete, it must perform the following workaround:

1. Perform the required write.
2. Perform a dummy write to the DDR3 memory controller module ID and revision register.
3. Perform a dummy read to the DDR3 memory controller module ID and revision register.
4. Indicate to master B that the data is ready to be read after completion of the read in step 3. The completion of the read in step 3 ensures that the previous write was done.

2.6.4 Class of Service

The commands in the Command FIFO can be mapped to two classes of service: 1 and 2. The mapping of commands to a particular class of service can be done based on the priority or the master ID. The mapping based on priority can be done by setting the appropriate values in the Priority to Class of Service Mapping register. The mapping based on master ID can be done by setting the appropriate values of master ID and the masks in the Master ID to Class of Service Mapping registers.

There are three master ID and mask values that can be set for each class of service. In conjunction with the masks, each class of service can have a maximum of 144 master IDs mapped to it. For example, a master ID value of 0xFF along with a mask value of 0x3 will map all master IDs from 0xF8 to 0xFF to that particular class of service. By default all commands will be mapped to class of service 2.

Each class of service has an associated latency counter. The value of this counter can be set in the Latency Configuration register. When the latency counter for a command expires, i.e., reaches the value programmed for the class of service that the command belongs to, that command will be the one that is executed next. If there is more than one command that has expired latency counters, the command with the highest priority will be executed first. One exception to this rule is as follows: if any of the commands with the expired latency counters is also the oldest command in the queue, that command will be executed first irrespective of priority. This is done to prevent a continuous block effect as described in [Section 2.6.1](#).

2.7 Refresh Scheduling

The DDR3 controller uses two counters to schedule AUTO REFRESH commands:

- a 13-bit decrementing refresh interval counter
- a four-bit refresh backlog counter

The interval counter is loaded with the REFRESH_RATE field value at reset. The interval counter decrements by one each cycle until it reaches zero at which point it reloads from REFRESH_RATE and restarts decrementing. The counter also reloads and restarts decrementing whenever the REFRESH_RATE field is updated.

The refresh backlog counter records the number of AUTO REFRESH commands that are currently outstanding. The backlog counter increments by one each time the interval counter reloads (unless it has reached its maximum value of 15). The backlog counter decrements by one each time the DDR3 controller issues an AUTO REFRESH command (unless it is already at zero). Following a refresh command, the DDR3 memory controller waits T_RFC cycles, defined in the SDRAM timing 3 register (SDTIM1), before rechecking the refresh urgency level.

For the range of values that the backlog counter can take, there are three levels of urgency with which the DDR3 controller should perform an auto refresh cycle (in which it issues AUTO REFRESH commands), as follows:

- Refresh May level is reached whenever the backlog count is greater than 0, to indicate that there is a refresh backlog, so if the DDR3 controller is not busy and none of the SDRAM banks are open, it should perform an auto refresh cycle.
- Refresh Release level is reached whenever the backlog count is greater than 4, to indicate that the refresh backlog is getting high, so if the DDR3 controller is not busy it should perform an auto refresh cycle even if any banks are open.
- Refresh Must level is reached whenever the backlog count is greater than 7, to indicate that the refresh backlog is getting excessive and the DDR3 controller should perform an auto refresh cycle before servicing any new memory access requests.

The DDR3 controller starts servicing new memory accesses after Refresh Release level is cleared. If any of the commands in the Command FIFO have class-of-service latency counters that are expired, the DDR3 controller will not wait for Refresh Release level to be cleared but will only perform one refresh command and exit the refresh state.

The refresh counters do not operate when SDRAM has been put into self-refresh mode. Also, the refresh counters start tracking the missed refreshes only after initialization is complete.

2.8 Self-Refresh Mode

The DDR3 memory controller supports self-refresh mode for low power. The controller maintains DDRCKE low to maintain the self-refresh state. In self-refresh, the memory maintains valid data while consuming a minimal amount of power.

Self-refresh mode is set by programming the LP_MODE in the Power Management Control register (PMCTL) to 2. The controller automatically puts the SDRAM into self-refresh after the controller is idle for SR_TIM DDR3CLKOUT cycles. (See [Section 4.8](#) for more information.)

The memory is brought out of self-refresh under any of the following conditions:

- If the LP_MODE field is set not equal to 2
- A memory access is requested
- SR_TIM bit in PMCTL is cleared

In a situation where memory accesses and a self-refresh command are sent to the DDR3 memory controller, the controller always prioritizes the memory access. Thus, if a reset is triggered when memory accesses and a self-refresh command are queued in the controller, it is likely that self-refresh will not be entered.

The user must ensure that all memory accesses have been completed, and verify that self-refresh is set in the STATUS register before initiating a reset.

NOTE: The DDR3 memory controller completes all pending memory accesses and refreshes before it puts SDRAM into self-refresh. If a request for a memory access is received, the DDR3 memory controller services the memory access request then returns to the self-refresh state upon completion.

CAUTION

A special case may exist where the DDR3 controller violates the DDR3 JEDEC standard by issuing excessive refreshes (more than 16) within twice the tREFI interval when in self refresh mode. A workaround exists to conform to the JEDEC standard. Refer to the Errata document for your device for the advisory and workaround.

2.8.1 Extended Temperature Range

The normal operating temperature range for DDR3 SDRAMs is typically 0 to 85°C. When operating in self-refresh mode within the extended temperature range (85°C to 95°C), the memory device must be refreshed at 2x the normal refresh rate. For this purpose, either the auto self-refresh (ASR) or self-refresh temperature (SRT) feature should be used. Under normal operating conditions, both ASR and SRT should be disabled (equal to 0). When ASR is enabled, the internal refresh rate of the SDRAM automatically switches to 2x the refresh rate when the operating case temperature T_c is greater than 85°C when in Self-refresh mode. When SRT is enabled, the internal refresh rate of the SDRAM is forced to 2x the refresh rate regardless of T_c. Both SRT and ASR cannot be enabled at the same time. One must be disabled if the other is enabled.

NOTE: ASR and SRT are used only in self-refresh mode (LP_MODE=0x2). When operating in extended temperature range with LP_MODE = 0x0 (not in self-refresh), it is up to the user to program the manual refresh rate to 2x the normal refresh rate for proper operation. If it is guaranteed that T_c will exceed 85°C, it is recommended that SRT=1 to force the refresh rate to 2x regardless of operating temperature.

2.9 Reset Considerations

The DDR3 memory controller can be reset through a hard reset or a soft reset. A hard reset resets the state machine, the FIFOs, and the internal registers. A soft reset only resets the state machine and the FIFOs. A soft reset does not reset the internal registers except for the interrupt registers. Register accesses cannot be performed while either reset is asserted.

The DDR3 memory controller hard and soft reset are derived from device-level resets. [Table 2-11](#) shows the relationship between the device-level resets and the DDR3 memory controller resets. For more information on the device-level resets, see the device-specific data manual.

Table 2-11. Device and DDR3 Memory Controller Reset Relationship

| DDR3 Memory Controller | Reset Effect | Initiated by |
|------------------------|---|---|
| Hard reset | Resets control logic and all DDR3 memory controller registers | <ul style="list-style-type: none"> Please refer to the reset controller description in your device data manual |
| Soft reset | Resets control logic and interrupt registers | <ul style="list-style-type: none"> Please refer to the reset controller description in your device data manual |

2.10 Turnaround Time

Table 2-12 shows the turn around time that the DDR3 memory controller introduces on the data bus for various back-to-back accesses. Note that the DDR3 memory controller takes advantage of the CAS latencies and packs the commands as close as possible on the control bus to introduce the following turn around time on the data bus.

Table 2-12. Turnaround Time

| Previous Access | Next Access | Turnaround Time (DDR3 memory clock cycles) |
|-----------------|--------------------------------------|--|
| SDRAM Write | SDRAM Write to same chip select | 0 |
| SDRAM Write | SDRAM Write to different chip select | T_CSTA + 1 |
| SDRAM Read | SDRAM Read to same chip select | 0 |
| SDRAM Read | SDRAM Read to different chip select | T_CSTA + 1 |
| SDRAM Write | SDRAM Read | T_WTR + 1 + CL |
| SDRAM Read | SDRAM Write | T_RTW + 1 |

2.11 DDR3 SDRAM Memory Initialization

DDR3 SDRAM initialization is achieved by programming memory mapped registers in the DDR3 controller configuration space and the Bootcfg space in a specific sequence. The software programming sequence is described in the Keystone I DDR3 Initialization Application Note. This sequence of software programming steps, causes the controller to issue MRS and EMRS commands to program mode and extended mode registers in the SDRAM device. These registers control parameters such as burst type, burst length, and CAS latency. The sequence of commands during the initialization sequence described in Section 2.11.1. The initialization sequence performed by the DDR3 memory controller is compliant with the JESD79-3C specification.

The DDR3 memory controller performs the initialization sequence under the following conditions:

- Automatically following a hard or soft reset (see Section 2.11.1)
- Following a write to the SDRAM configuration register (SDCFG) (see Section 2.11.1)

At the end of the initialization sequence, the DDR3 memory controller performs an auto-refresh cycle, leaving the DDR3 memory controller in an idle state with all banks deactivated.

During the initialization sequence, the DDR3 memory controller issues MRS and EMRS commands that configure the DDR3 SDRAM mode registers with the values described in Table 2-13 and Table 2-14.

When a reset occurs, the DDR3 memory controller immediately begins the initialization sequence. Under this condition, commands and data stored in the DDR3 memory controller FIFOs will be lost. However, when the initialization sequence is initiated by a write to the SDCFG Register, data and commands stored in the DDR3 memory controller FIFOs will not be lost and the DDR3 memory controller will ensure read and write commands are completed before starting the initialization sequence.

As the default values of the Mode Register (MR) and extended mode registers 1, 2, 3 are not defined, contents of Mode/Extended Mode Registers must be fully initialized and/or reinitialized, i.e., written, after power up and/or reset for proper operation. Also the contents of the Mode/Extended Mode Registers can be altered by re-executing the MRS/EMRS command during normal operation. The mode/extended mode registers are selected by varying the bank address bits BA [1:0]. BA [2] and A [15:13] are reserved for future use and must be programmed to zero.

The extended mode register 3 is configured with a value of 0h.

Table 2-13. DDR3 SDRAM Extended Mode Register 2 Configuration⁽¹⁾

| Mode Register Bit | Mode Register Field | Init Value | Description |
|-------------------|---------------------|---------------|--|
| 15-11 | Reserved | 0x0 | Reserved |
| 10-9 | Rtt_WR | SDCFG.DYN_ODT | Dynamic ODT value from SDRAM Config Register |
| 8 | Reserved | 0x0 | Reserved |
| 7 | SRT | SDRCR.SRT | Self-Refresh temperature range from SDRAM Refresh Control register |
| 6 | ASR | SDRCR.ASR | Auto self-refresh enable from SDRAM Refresh Control register |
| 5-3 | CWL | SDCFG.CWL | CAS write latency from SDRAM Config register |
| 2-0 | PASR | SDRCR.PASR | Partial array self-refresh from SDRAM Refresh Control register |

⁽¹⁾ Bank Address bits to select EMR 2 are BA [1:0] = 0x2.

Table 2-14. DDR3 SDRAM Extended Mode Register 1 Configuration⁽¹⁾

| Mode Register Bit | Mode Register Field | Init Value | Description |
|-------------------|-------------------------|----------------------|--|
| 12 | Qoff | 0x0 | Output Buffer Enabled |
| 11 | TDQS | 0x0 | TDQS enable/disable |
| 10 | Reserved | 0x0 | Reserved |
| 9 | Rtt_nom | SDCFG.DDRTERM[2] | DDR3 termination resistor value from SDRAM Config register |
| 8 | Reserved | 0x0 | Reserved |
| 7 | Level | 0x0 | Write Leveling Disabled |
| 6 | Rtt_nom | SDCFG.DDRTERM[1] | DDR3 termination resistor value from SDRAM Config register |
| 5 | Output driver impedance | SDCFG.SDRAM_DRIVE[1] | SDRAM drive strength from SDRAM Config register |
| 4-3 | Additive Latency | 0x0 | Additive latency = 0 |
| 2 | Rtt_nom | SDCFG.DDRTERM [0] | DDR3 termination resistor value from SDRAM Config register |
| 1 | Output driver impedance | SDCFG.SDRAM_DRIVE[0] | SDRAM drive strength from SDRAM Config register |
| 0 | DLL Enable | 0x0 | DLL enable/disable from SDRAM Config register |

⁽¹⁾ Bank Address bits to select EMR 1 are BA [1:0] = 0x1.

Table 2-15. DDR3 SDRAM Mode Register 0 Configuration⁽¹⁾

| Mode Register Bit | Mode Register Field | Init Value | Description |
|-------------------|------------------------------|---------------|---|
| 12 | DLL control for Precharge PD | 0x0 | Fast exit active powerdown exit time |
| 11-9 | Write Recovery | SDTIM1.T_WR | Write recovery for auto precharge from SDAM Timing 1 Register |
| 8 | DLL Reset | 0x1 | DLL Reset |
| 7 | Mode | 0x0 | Normal Mode from SDRAM Config Register |
| 6-4 | CAS Latency | SDCFG.CL[3:1] | CAS Latency from SDRAM Config Register |
| 3 | Read Burst Type | 0x0 | sequential/interleave burst type |
| 2 | CAS Latency | SDCFG.CL[0] | CAS Latency from SDRAM Config Register |
| 1-0 | Burst length | 0x0 | Burst length of 8 |

⁽¹⁾ Bank Address bits to select MR are BA [1:0] = 0x0.

2.11.1 DDR3 Initialization Sequence

On coming out of reset if the SDRAM_TYPE field in the SDRAM Config register is equal to 3 and the INITREF_DIS bit in the SDRAM Refresh Control register is set to 0, the DDR3 Controller performs a DDR3 SDRAM initialization sequence. The sequence follows the JEDEC standard. Please refer to the JEDEC spec for the initialization sequence.

The DDR3 memory controller also performs the initialization sequence whenever the SDRAM Config register is written. But in this case, the sequence starts at step 3. The DDR3 memory controller does not perform any transactions until the DDR3 initialization sequence is complete.

2.12 Dual Rank Support

The Keystone-I device also offers dual rank support. The device uses both chip selects (DCE0 and DCE1), with each chip select enabling access to one of the two SDRAM ranks. To enable dual rank access:

1. Set use_rank0_delays bit in the DDR3_CONFIG_12 register to 1. This directs the PHY leveling logic to use one set of optimal leveling values to access both ranks. This write must immediately follow the completion of the leveling process.
2. Set the EBANK bit in the SDCFG register to 1. This directs the controller to use both chip selects, one for each rank.

See the section on Dual Rank Support in the Keystone-I DDR3 Initialization App note for the proper sequence of initialization steps. Although dual rank access is supported, address mirroring is not.

2.13 Leveling

The DDR3 controller supports a new feature called leveling to compensate for the command and DQS skew as a result of the fly-by topology. Leveling compensates the skew for both reads and writes. Both full leveling and incremental leveling are supported. The controller does not perform full leveling after initialization. It must be first enabled by software after initialization.

2.13.1 Full Leveling (Auto Leveling)

Full leveling or auto leveling consists of write leveling, read data eye training and read DQS gate training. Write leveling is used to compensate for the command-to-DQS delay for writes. Read DQS gate training is used by the internal DDR3 controller logic before read data eye leveling to determine the most appropriate time to ensure a valid DQS coming into the DDR3 controller from the SDRAM. Read data eye training then tries to align the valid DQS to the center of the DQ line for reads by adjusting the DQS delay relative to DQ.

Leveling (both full and incremental) can be enabled by writing a '1' to the RDWRLVL_EN field in the Read-Write Leveling Ramp Control register (RDWR_LVL_RMP_CTRL). Once enabled, full leveling can be triggered by writing a '1' to the RDWRLVLFULL_START bit in the Read-Write Leveling Control Register (RDWR_LVL_CTRL). Once triggered, all three full levelings (write leveling, read DQS gate training and read data eye training) will be performed. Thus there is no independent control over individual leveling types for full leveling.

NOTE: Full leveling violates the refresh interval; data inside DDR3 can be lost if full leveling is performed during normal operation. It is recommended that full leveling be performed after initialization and before any transactions to the DDR3 memory device are initiated. Any subsequent full leveling will not guarantee the data integrity inside the memory. During normal operation, temperature and voltage can be better tracked by incremental leveling.

2.13.2 Incremental Leveling

Incremental leveling is a feature that can be used to track voltage and temperature (V-T) changes over time as these can negatively impact the DQS de-skewing process that has occurred after full leveling. After performing full leveling once, incremental leveling can be performed periodically to more accurately track V-T drifts. Incremental leveling allows for greater control over the individual leveling types - write, read DQS gate and read data eye. Each of these levelings can be programmed to occur at a different rate. The rate is measured in terms of refresh periods. RDWRLVLINC_PRE is the base period defined in terms of number of refresh intervals. WRLVLINC_INT, RDLVLGATEINC_INT, and RDLVLINC_INT fields in the RDWR_LVL_CTRL register can be used to program independent leveling intervals (in number of the base period) for write leveling, gate training and read data eye leveling respectively. The respective leveling is triggered when its interval expires.

2.13.2.1 Ramp Incremental Leveling

What was described above can be referred to as standalone incremental leveling which is software-triggered. Ramp incremental leveling can only be used for DSPs that support Smart-reflex Class-3 (SR Class-3). Because SR Class-3 is not supported by Keystone-I devices, the ramp incremental leveling feature is also not supported.

2.13.3 Impact On Bandwidth

The DDR3 controller does not perform any reads/writes during incremental leveling. So a faster incremental leveling rate will have a larger impact on throughput than programming a smaller rate. Also, programming the intervals such that they all don't expire at the same time can minimize the impact on bandwidth.

NOTE: At this time there are no “best practices” recommendations for setting the incremental leveling intervals. The choice is entirely up to the application depending on the bandwidth tradeoff and environmental conditions expected.

2.13.4 Programming Full Leveling

Leveling (both full and incremental) is executed separately for each byte lane (clock-DQS pair). Therefore, the leveling process converges separately for each byte lane. To ensure that leveling converges correctly, the DDR3 controller must be given an initial set of values to use during leveling. The leveling process uses these initial values to arrive at a set of converged values for each byte lane. These initial values should be plugged into a set of memory-mapped registers in the Boot configuration section.

The user should note that the DATAx registers in steps 2 and 3 below map to specific byte lanes as follows (note the difference between C665x and other device variants). The mapping is consistent for write leveling and gate leveling initial values i.e. DATA *n*_PHY_WRLVL_INIT_RATIO and DATA *n*_PHY_GATELVL_INIT_RATIO map to the same byte lane. DATA *m*_PHY_WRLVL_INIT_RATIO and DATA *m*_PHY_GATELVL_INIT_RATIO map to the same byte lane.

Table 2-16. DATAx register to byte lane mapping

| Register | C665x devices (36-bit) | All other Keystone-I devices (72-bit) |
|----------|------------------------|---------------------------------------|
| DATA0_* | Byte lane 3 | Byte lane 7 |
| DATA1_* | Byte lane 2 | Byte lane 6 |
| DATA2_* | Byte lane 1 | Byte lane 5 |
| DATA3_* | Byte lane 0 | Byte lane 4 |
| DATA4_* | NA | Byte lane 3 |
| DATA5_* | NA | Byte lane 2 |
| DATA6_* | NA | Byte lane 1 |
| DATA7_* | NA | Byte lane 0 |
| DATA8_* | ECC Byte lane | ECC Byte lane |

The steps to program full leveling are as follows:

1. Unlock the Boot configuration module by writing 0x83E70B13 to the KICK0 and 0x95A4F1E0 to the KICK1 registers.
2. Program the write leveling initial values into the DATA0_PHY_WRLVL_INIT_RATIO to DATA8_PHY_WRLVL_INIT_RATIO fields of the DDR3_CONFIG_2 to DDR3_CONFIG_10 registers respectively. (See the tables in sections [Section 4.33](#) to [Section 4.41](#)).

NOTE: The values to enter into the registers depend on the board topology and the DDR3 clock frequency in use. The DDR3 clock frequency (half the data rate) and trace lengths for each byte lane (CK-DQS pair) should be plugged in the appropriate fields in the accompanying PHY calculation spreadsheet which generates the values to be programmed into the boot config registers mentioned above.

3. Program the gate leveling initial values into the DATA0_PHY_GATELVL_RATIO to DATA8_PHY_GATELVL_RATIO fields of the DDR3_CONFIG_14 to DDR3_CONFIG_22 registers respectively. (See the tables in sections [Section 4.43](#) to [Section 4.51](#)).

NOTE: The values to enter into the registers depend on the board topology and the DDR3 clock frequency in use. The DDR3 clock frequency (half the data rate) and trace lengths for each byte lane (CK-DQS pair) should be plugged in the appropriate fields in the accompanying PHY calculation spreadsheet which generates the values to be programmed into the boot config registers mentioned above.

4. Program CMD_PHY_DLL_LOCK_DIFF field in DDR3_CONFIG_0 register to 0xF. (See [Section 4.31](#).)
5. Enable global leveling (Set RDWRLVL_EN = 1 in RDWR_LVL_RMP_CTRL).
6. Trigger full leveling (Set RDWRLVLFULL_START = 1 in RDWR_LVL_CTRL).
7. Read back any of the DDR3 controller registers.
This ensures full leveling is complete because this step is executed only after full leveling completes.

2.13.4.1 Leveling Timeout

The DDR3 controller attempts to converge to the correct leveling values within a reasonable time frame after full leveling is triggered. If a leveling type (write, gate or read data eye) does not converge within the time frame the controller will leave in the unconverged values for each byte lane which will affect DDR3 stability since the de-skew will not be accurate. In such a case, a timeout bit for that leveling will be set in the SDRAM Status Register (WRLVLTO, RDLVLGATETO, and RDLVLTO). The timeouts are global values for all byte lanes that will be set even if one of the byte lanes times out. Plugging in incorrect initial values for a byte lane can typically result in a timeout.

2.13.4.2 Read Data Eye Training Errata For Full Leveling

On certain KeyStone DSPs, the read data eye training has issues converging to the correct values during the full leveling process. See the device-specific Errata document for this and other advisories and usage notes.

2.13.5 Programming Incremental Leveling

This assumes that global leveling is enabled (RDWRLVL_EN=1) and full leveling has already been performed.

2.13.5.1 Standalone Incremental Leveling

Steps to program standalone incremental leveling are:

1. Program RDWRLVLINC_PRE to set the pre-scalar in terms of refresh intervals.
2. Program non-zero values for WRLVLINC_INT, RDLVLGATEINC_INT, and RDLVLINC_INT to decide each of the leveling intervals.
3. Step 2 will trigger incremental leveling. To disable a type of incremental leveling, just program its interval to zero.

2.13.6 Programming Ratio Forced Leveling

The user can disable auto leveling and instead use a set of ratio forced register values present in [Section 4.52](#) and [Section 4.53](#) for devices other than C665x and TCI6612/13/14. These values control the DQ and DQS delay for all byte lanes for write leveling, read DQS gate training and read data eye training. Similar to auto-leveling, these values also depend on board characteristics (trace lengths) and the DDR3 frequency of operation.

For devices other than C665x and TCI6612/13/14, independent control over each byte lane is not possible. A single value needs to be used for all byte lanes. Thus the DQ and DQS skews across byte lanes must be very small. The values to be programmed are WR_DATA_SLAVE_RATIO, WR_DQS_SLAVE_RATIO, RD_DQS_SLAVE_RATIO, and FIFO_WE_SLAVE_RATIO and can be found in the PHY calculation spreadsheet.

For C665x and TCI6612/13/14 devices, independent control is possible over each byte lane through registers DDR3_CONFIG_REG_25 through DDR3_CONFIG_REG_60.

2.13.7 Using Invert Clock Out

For write leveling (both full and incremental) to function correctly, the skew between command and data lines from DSP to an SDRAM should satisfy certain command-to-data skew requirements. The skew is defined as follows:

- $\text{write_leveling}_{\text{skew}} = \text{command}_{\text{delay}} - \text{data}_{\text{delay}}$

Both $\text{command}_{\text{delay}}$ and $\text{data}_{\text{delay}}$ are measured from the DSP to the SDRAM.

The JEDEC standard parameters tJIT (per, lck) and tWLS defined as the clock period jitter when DLL is locking and write leveling setup time respectively, demand a minimum $\text{write_leveling}_{\text{skew}}$ that must be satisfied. The minimum skew is a function of the DDR3 speed bin that is being used. If $\text{write_leveling}_{\text{skew}}$ is greater than the minimum skew, CMD_PHY_INVERT_CLKOUT in DDR3_CONFIG_12 register can be left to its default value of 0. If $\text{write_leveling}_{\text{skew}}$ is smaller than the minimum required skew, CMD_PHY_INVERT_CLKOUT should be set to 1. This essentially adds a half-clock cycle delay to the $\text{write_leveling}_{\text{skew}}$ and thus increases the skew above the minimum skew requirements.

Similar to the minimum skew requirements, there also exists a maximum skew that cannot be exceeded for the write leveling algorithm to function correctly. Maximum skew is also a function of the DDR3 speed bin in use. Both minimum and maximum skews have routing implications for command and data lines. For min/max routing limits with `CMD_PHY_INVERT_CLKOUT = 0` or `1`, refer to the DDR3 Design Guide (SPRABI1A).

NOTE: When setting `CMD_PHY_INVERT_CLKOUT` to `1`, the `CMD_PHY_CTRL_SLAVE_RATIO` field in `DDR3_CONFIG_0` should be programmed to `0x100`. If set to `0`, program the default value of `0x80`.

NOTE: From the equation, if command lines are shorter than the data lines the resulting skew will be negative. There is a maximum negative skew that the write leveling algorithm can tolerate. For more information refer to the DDR3 Design Guide (SPRABI1A)

2.14 Interrupt Support

The DDR3 memory controller generates one error interrupt. Please check the section on interrupts in the device data manual for details on how the ECC error interrupt is routed. The source of the interrupt can be checked in the Interrupt Raw Status Register.

2.15 EDMA Event Support

The DDR3 memory controller is a DMA slave peripheral and therefore does not generate EDMA events. Data read and write requests may be made directly by masters including the EDMA controller.

2.16 Emulation Considerations

The DDR3 memory controller will remain fully functional during emulation halts to allow emulation access to external memory.

2.17 ECC

For data integrity, the DDR3 memory controller supports ECC on the data written to or read from the ECC protected address ranges in memory. The ECC algorithm is a single-error-correct-double-error-detect (SEDED) algorithm and uses the (72,64) Hamming code. Eight-bit ECC is calculated over 64-bit data quanta. ECC is enabled by setting `ECC_EN = 1` in the ECC Control register. ECC is disabled by setting `ECC_EN=0`. By default, `ECC_EN=0`. The address ranges can be programmed in the ECC Address Range 1 and 2 register. The system must ensure that any bursts accesses starting in the ECC protected region must not cross over into the unprotected region and vice-versa.

NOTE: The ECC is stored inside the SDRAM during writes. After enabling ECC and before performing any functional reads or writes, all DDR3 memory space configured as ECC should be first written with known data that is 64-bit aligned and multiples of 64-bit. This is to ensure the correct ECC values are stored in the ECC SDRAM prior to functional use.

A write access with byte count that is not a multiple of 64-bit quanta, or with a non-64-bit-aligned address performed within the address range protected by ECC, will result in a write ECC error interrupt. In this case, the DDR3 memory controller writes to the SDRAM. However, the ECC value written to the SDRAM will be corrupted. The controller will NOT trigger a write ECC error if a write access with a multiple of 64-bit quanta and with 64-bit aligned address but with partial byte enables set, is performed within the address range protected by ECC (this can be the case if the Multicore Navigator PktDMA writes to a descriptor placed in DDR3). The data and corrupted ECC value will be written to the SDRAM, but will go undetected and may be detected as 1-bit or 2-bit errors when read back.

If there is a one-bit error, the DDR3 memory controller corrects the data and sends it on the read interface. For 2-bit errors, the DDR3 memory controller generates a read ECC error interrupt. Note that in both cases, the data in SDRAM is still corrupted. It is the responsibility of system software to go and correct the data in the SDRAM.

NOTE: The user should note that the single error correct, double error detect (SECEDED) algorithm used by the ECC logic cannot detect more than 2-bit errors per 64-bit quanta. For these errors, the output of the algorithm is unknown i.e. it may erroneously detect as 1-bit, 2-bit or no errors. More than 2-bit errors are expected to be very rare in a well designed system.

See [Section 4.27](#) through [Section 4.29](#) for ECC-related registers.

NOTE: If ECC is disabled, the ECC byte lane is held in reset to save power. Hence, full-leveling must be triggered after enabling ECC to ensure that the ECC byte lane is leveled.

2.18 Power Management

2.18.1 SDRAM Self-Refresh Mode

(See [Section 2.8](#).)

2.18.2 SDRAM Power-Down Mode

The DDR3 memory controller supports power-down mode. Automatic power-down is enabled by setting the LP_MODE field in the Power Management Control register (PMCTL) to 4. The memory is put into power-down after the controller is idle for PD_TIM number of DDR3CLKOUT cycles. In power-down mode, the DDR3 memory controller does not stop the clocks to the memory. The controller maintains DDRCKE low to maintain the power-down state. When the SDRAM is in power-down, the DDR3 memory controller services register accesses as normal.

The memory is brought out of power-down under any of the following conditions:

- If the LP_MODE field is set not equal to 4
- A memory access is requested
- Refresh Must level is reached

2.19 Performance Monitoring

The DDR3 controller provides a set of performance counter registers which can be used to monitor or calculate the bandwidth and efficiency of the DDR traffic. The counters can be configured to count events such as total number of SDAM accesses, SDRAM activates, reads, write and so on. The Performance Counter 1 and 2 Registers (PERF_CNT_1 and PERF_CNT_2) act as two 32-bit counters that are able to count events independent of each other. To provide more granularity the counters can also be configured to filter events originating from a particular master or address space. The events to be counted and filter enabled are programmed in the Performance Counter Config Register (PERF_CNT_CFG). The actual value of the filter is programmed in Performance Counter Master Region Select Register (PERF_CNT_SEL). The counters start counting the events independently when commands enter the Command FIFO.

The CNTRN_CFG (N=1,2) fields in the PERF_CNT_CFG register are used to select the event for the counter to count. The PERF_CNT_CFG also includes options to enable or disable the master (CNTRN_MSTID_EN) and address space (CNTRN_REGION_EN) filters for each counter. The filters are disabled by default. If the respective filters are enabled, the master ID value and region select options can be programmed in the PERF_CNT_SEL register. It should be noted that the master ID and region select filters apply only to a certain subset of events that can be counted. The table below shows the events for which the filters are applicable.

Table 2-17. Performance Counter Filter Configuration

| PERF_CNT_CFG. [CNTR_CFG] | Event Selected for counting | PERF_CNT_CFG. [CTNR_REGION_EN] | PERF_CNT_CFG. [CNTR_MSTID_EN] |
|-----------------------------|--|-----------------------------------|----------------------------------|
| 0x0 | Total SDRAM accesses | NA | 0 - Disable, 1 - Enable |
| 0x1 | Total SDRAM activates | NA | 0 - Disable, 1 - Enable |
| 0x2 | Total Reads | 0 - Disable, 1 - Enable | 0 - Disable, 1 - Enable |
| 0x3 | Total Writes | 0 - Disable, 1 - Enable | 0 - Disable, 1 - Enable |
| 0x4 | Number of DDR/2 clock cycles Command FIFO is full | NA | NA |
| 0x5 | Number of DDR/2 clock cycles Write Data FIFO is full | NA | NA |
| 0x6 | Number of DDR/2 clock cycles Read Data FIFO is full | NA | NA |
| 0x7 | Number of DDR/2 clock cycles Write Status FIFO is full | NA | NA |
| 0x8 | Number of priority elevations | 0 - Disable, 1 - Enable | 0 - Disable, 1 - Enable |
| 0x9 | Number of DDR/2 clock cycles that a command was pending | NA | NA |
| 0xA | Number of DDR/2 clock cycles for which DDR i/f was transferring data | NA | NA |
| 0xB | Total number of 1-bit ECC errors | NA | NA |
| 0x C - 0XF | Reserved | | |

See [Chapter 4](#) for details on Performance counter registers.

Using the DDR3 Memory Controller

The following sections show various ways to connect the DDR3 memory controller to DDR3 memory devices. The steps required to configure the DDR3 memory controller for external memory access are also described.

| Topic | Page |
|---|-----------|
| 3.1 Connecting the DDR3 Memory Controller to DDR3 SDRAM | 44 |
| 3.2 Configuring DDR3 Memory Controller Registers to Meet DDR3 SDRAM Specifications | 48 |

3.1 Connecting the DDR3 Memory Controller to DDR3 SDRAM

The following figures show high-level views of the three memory topologies:

- [Figure 3-1](#)
- [Figure 3-2](#)
- [Figure 3-3](#)

All DDR3 SDRAM devices must comply with the JESD79-3C standard.

Not all of the memory topologies shown may be supported by your device. For more information, see the device-specific data manual.

The printed-circuit-board (PCB) layout rules and connection requirements between the DSP and the memory device are described in a separate document. For more information, see the device-specific data manual.

Figure 3-1. Connecting Two 16 MB x 16 x 8 Banks (4Gb Total) Devices

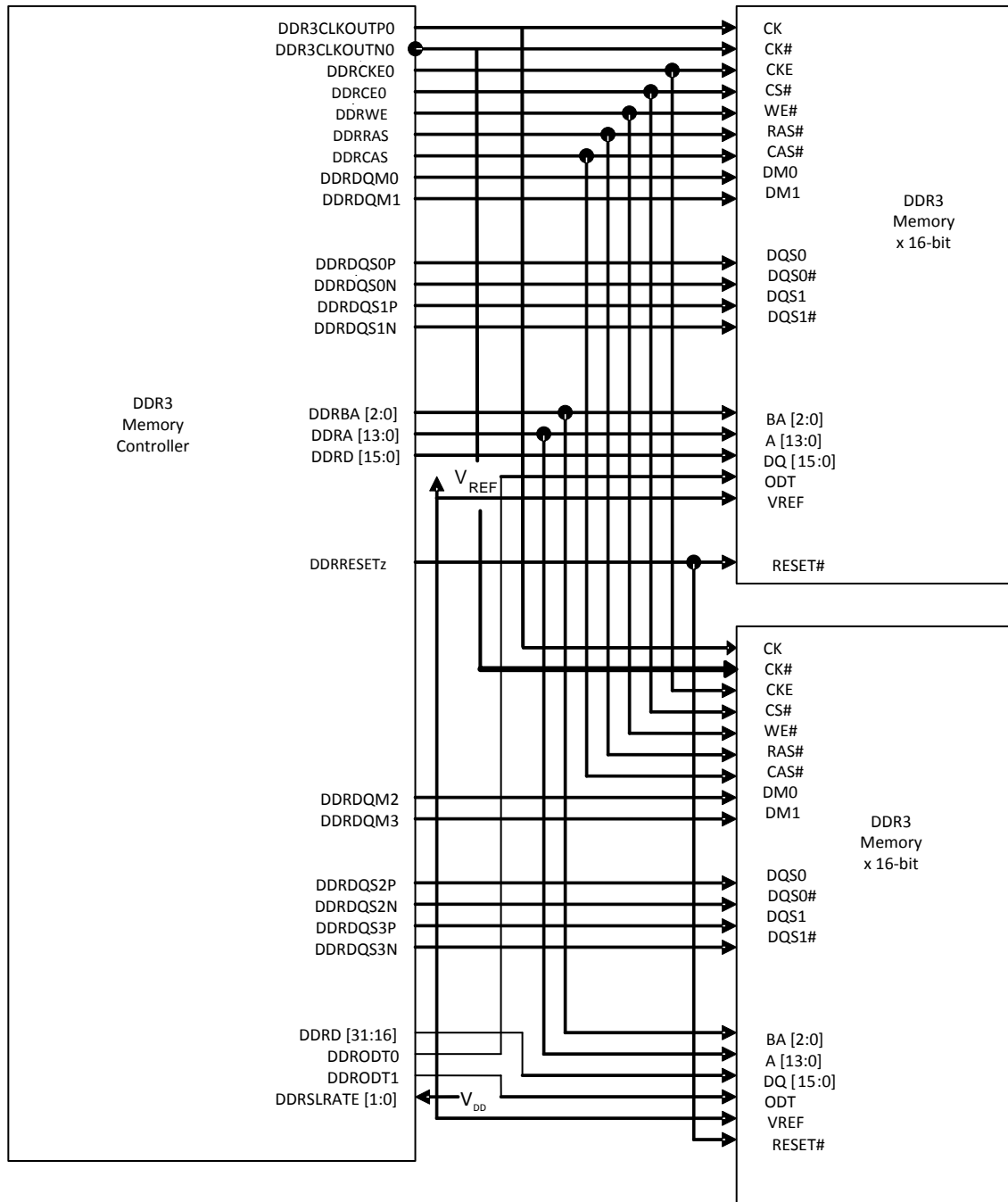

Figure 3-2. Connecting One 8 MB x 16 x 8 Banks (1Gb Total) Device

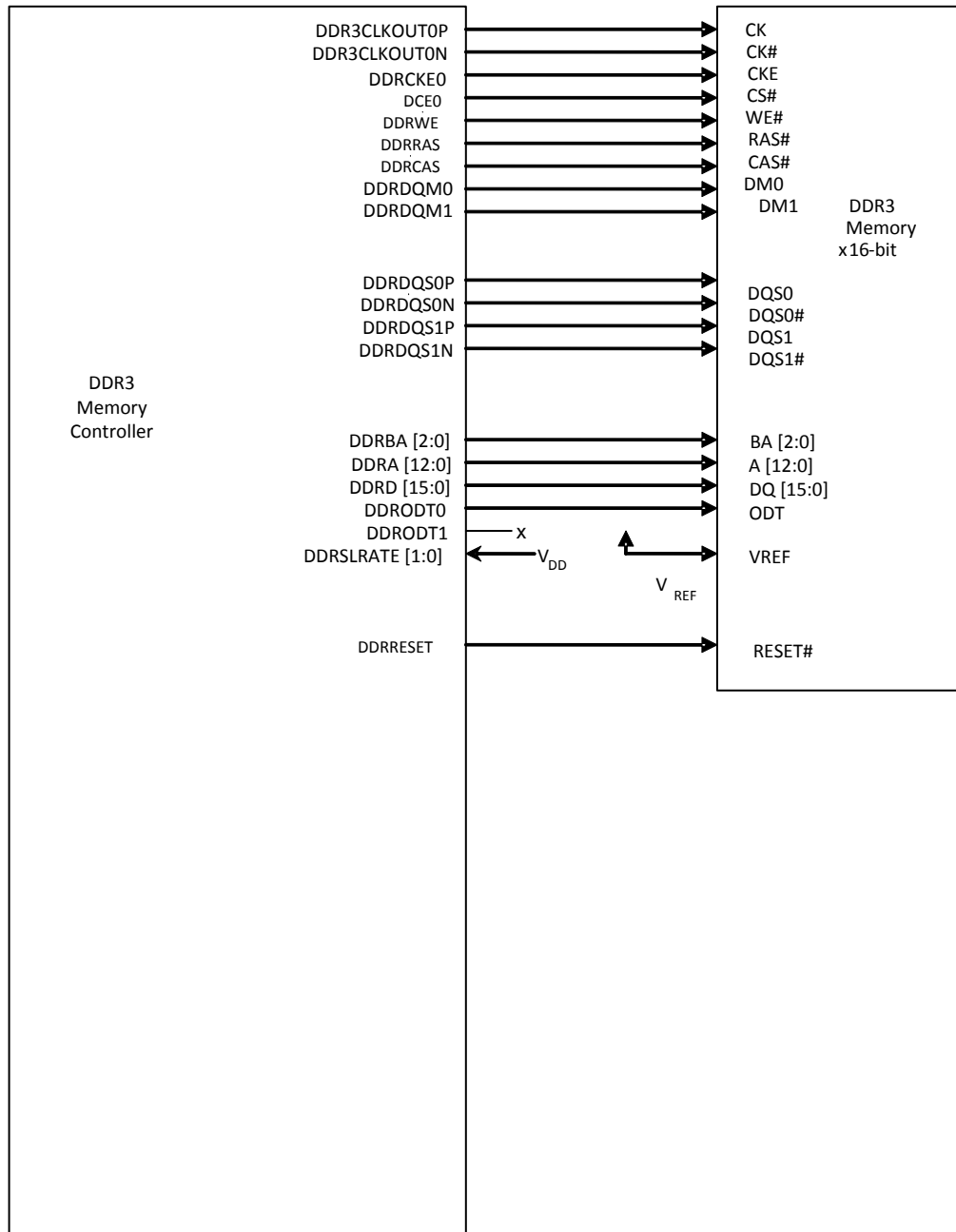
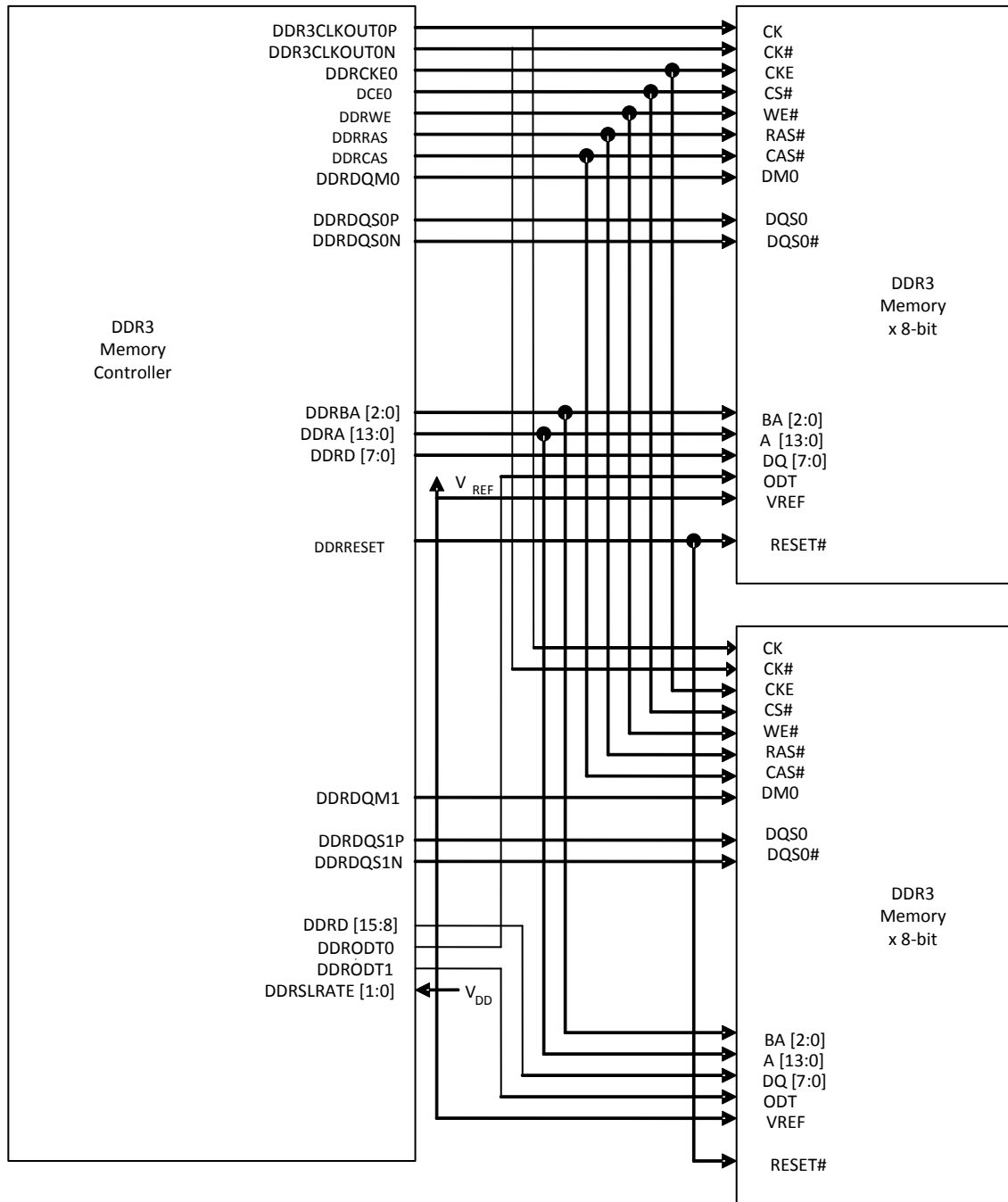

Figure 3-3. Connecting Two 16 MB x 8 x 8 Banks (2Gb Total) Devices



3.2 Configuring DDR3 Memory Controller Registers to Meet DDR3 SDRAM Specifications

The DDR3 memory controller allows a high degree of programmability for shaping DDR3 accesses. This provides the DDR3 memory controller with the flexibility to interface with a variety of DDR3 devices. By programming the SDRAM Configuration Register (SDCFG), SDRAM Refresh Control Register (SDRFC), SDRAM Timing 1 Register (SDTIM1), SDRAM Timing 2 Register (SDTIM2) and SDRAM Timing 3 Register (SDTIM3), the DDR3 memory controller can be configured to meet the data sheet specification for JESD79-3C compliant DDR3 SDRAM devices.

As an example, the following sections describe how to configure each of these registers for access to two 1 Gb, 16-bit wide DDR3 SDRAM devices connected as shown on [Figure 3-2](#), where each device has the following configuration:

- Maximum data rate: 1333 MHz
- Number of banks: 8
- Page size: 1024 words
- CAS latency: 9

It is assumed that the frequency of the DDR3 memory controller clock (DDR3CLKOUT) is set to 666.5 MHz.

3.2.1 Programming the SDRAM Configuration Register (SDCFG)

The SDRAM configuration register (SDCFG) contains register fields that configure the DDR3 memory controller to match the data bus width, CAS latency, number of banks, and page size of the attached DDR3 memory.

[Table 3-1](#) shows the resulting SDCFG configuration.

Table 3-1. SDCFG Configuration

| Field | Value | Function Selection |
|------------|-------|--|
| SDRAM_TYPE | 0x3h | SDRAM Type Select – DDR3 |
| NM | 1h | To configure the DDR3 memory controller for a 32-bit data bus width. |
| CL | 10h | To select a CAS latency of 9. |
| IBANK | 3h | To select 8 internal DDR3 banks. |
| EBANK | 0 | To select only DCE0z to be used. |
| PAGESIZE | 2h | To select 1024-word page size. |

3.2.2 Programming the SDRAM Refresh Control Register (SDRFC)

The SDRAM refresh control register (SDRFC) configures the DDR3 memory controller to meet the refresh requirements of the attached DDR3 device. SDRFC also allows the DDR3 memory controller to enter and exit self refresh.

The REFRESH_RATE field in SDRFC is defined as the rate at which the attached DDR3 device is refreshed in DDR3 cycles. The value of this field may be calculated using the following equation:

$$\text{REFRESH_RATE} = \text{DDR3CLKOUT frequency} \times \text{memory refresh period} \quad (1)$$

According to the DDR3 JEDEC standard, on reset de-assertion the DDRCKE pin must remain low for at least 500µs before becoming active during power-up initialization. This is achieved by programming a 500 µs refresh period in the SDRFC prior to initialization.

[Table 3-2](#) shows the DDR3-1333 refresh rate specification.

Table 3-2. DDR3 Memory Refresh Specification

| Symbol | Description | Value |
|-------------------------|---|--------|
| t_{REFI} | Refresh interval to be programmed during power-up initialization | 500 µs |
| \bar{t}_{REFI} | Average Periodic Refresh Interval (after power-up initialization) | 7.8 µs |

The refresh rate of 500 μ s to be programmed during power-up initialization should be calculated equal to a divide-by-16 value as follows. The DDR3 controller takes care of the divide-by-16 internal logic.

$$\text{REFRESH_RATE} = (666.5 \text{ MHz} \times 500 \mu\text{s})/16 = 515\text{Ch} \quad (2)$$

After power-up initialization, the refresh rate of 7.8 μ s should be programmed as follows:

$$\text{REFRESH_RATE} = 666.5 \text{ MHz} \times 7.8 \mu\text{s} = 1450\text{h} \quad (3)$$

Table 3-3 shows the resulting SDRFC configuration.

Table 3-3. SDRFC Configuration

| Field | Value | Function Selection |
|--------------|----------------|--|
| SRT | 0 | Normal Operating Temperature Range |
| ASR | 0 | Manual Self-Refresh |
| REFRESH_RATE | 515Ch 1450h | Set a divide-by-16 equivalent of 500 μ s during power-up initialization. Set to 1450h DDR3 clock cycles to meet the DDR3 memory refresh rate requirement during normal operation. |

3.2.3 Configuring SDRAM Timing Registers (SDTIM1, SDTIM2, SDTIM3, SDTIM4)

The SDRAM timing 1 register (SDTIM1), SDRAM timing 2 register (SDTIM2), SDRAM timing 3 register (SDTIM3), SDRAM timing 4 register (SDTIM4) configure the DDR3 memory controller to meet the datasheet timing parameters of the attached DDR3 device. Each field in SDTIM1, SDTIM2, SDTIM3, SDTIM4 corresponds to a timing parameter in the DDR3 datasheet specification. Table 3-4, Table 3-5, and Table 3-6 show the register field name and corresponding DDR3 datasheet parameter name and value. These tables also provide a formula to calculate the register field value and show the resulting calculation. Each of the equations includes a minus 1 because the register fields are defined in terms of DDR3 clock cycles minus 1. (See Section 4.5- Section 4.7 for more information.). Some of these timing parameters will also have to be programmed in the DRAM Timing Parameter Registers (See Section 4.50 - Section 4.52)

The objective behind programming the timing values is to calculate them in terms of DRAM clock cycles and round off to the next highest integer value. For example, at 666.5 MHz, the clock period $t_{\text{CK}} = 1.5 \text{ ns}$. So 13.5 ns will be programmed as $(13.5/1.5)-1 = 9 - 1 = 8$ DDR3 clock cycles and 14ns will be 9 DDR3 clock cycles.

Table 3-4. See the register section for the SDTIM* register where the field exists

| Register Field Name | DDR3 SDRAM Datasheet Parameter Name | Description | Datasheet Value (ns) | Formula (Register Field must be \geq) | Field Value (h) |
|---------------------|-------------------------------------|---|--------------------------------|--|-----------------|
| T_RP | t_{RP} | Precharge to Activate or Refresh command | 13.5 | $(t_{\text{RP}}/t_{\text{CK}}) - 1$ | 8 |
| T_RCD | t_{RCD} | Activate command to Read/Write command | 13.5 | $(t_{\text{RCD}}/t_{\text{CK}}) - 1$ | 8 |
| T_WR | t_{WR} | Write recovery time | 6 | $(t_{\text{WR}}/t_{\text{CK}}) - 1$ | 3 |
| T_RAS | t_{RAS} | Active to precharge command | 36 | $(t_{\text{RAS}}/t_{\text{CK}}) - 1$ | 17 |
| T_RC | t_{RC} | Activate to Activate command in same bank | 49.5 | $(t_{\text{RC}}/t_{\text{CK}}) - 1$ | 20 |
| T_RRD | t_{RRD} | Activate to Activate in different bank | $t_{\text{FAW}} = 30\text{ns}$ | $(t_{\text{FAW}}/(4*t_{\text{CK}})) - 1$ | 4 |
| T_WTR | t_{WTR} | Write to Read command delay | 6 | $(t_{\text{WTR}}/t_{\text{CK}}) - 1$ | 3 |

Table 3-5. See the register section for the SDTIM* register where the field exists

| Register Field Name | DDR3 SDRAM Datasheet Parameter Name | Description | Datasheet Value (ns) | Formula (Register Field must be >=) | Field Value (h) |
|---------------------|-------------------------------------|-------------------------------------|----------------------------|-------------------------------------|-----------------|
| T_RTP | t_{RTP} | Read to precharge command delay | 6 | $(t_{RTP}/t_{CK}) - 1$ | 3 |
| T_CKE | t_{CKE} | CKE minimum pulse width | $3(t_{CK} \text{ cycles})$ | $(t_{CKE}) - 1$ | 2 |
| T_XP | t_{XP} | Power-down exit to non-read command | $5(t_{CK} \text{ cycles})$ | $(t_{XP}) - 1$ | 4 |

Table 3-6. See the register section for the SDTIM* register where the field exists

| Register Field Name | DDR3 SDRAM Datasheet Parameter Name | Description | Datasheet Value (ns) | Formula (Register Field must be >=) | Field Value (h) |
|---------------------|-------------------------------------|----------------------------|-----------------------------|-------------------------------------|-----------------|
| T_CSTA | DDR controller parameter | Refer to SDTIM 34 Register | — | — | 5 |
| T_RFC | t_{RFC} | Refresh cycle time | 110 | $(t_{RFC}/t_{CK}) - 1$ | 49 |
| T_ZQCS | t_{ZQcs} | ZQCS command time | $64(t_{CK} \text{ cycles})$ | $(t_{ZQcs}) - 1$ | 3F |

3.2.4 Configuring Leveling Registers

The PHY registers in the Boot configuration section should be programmed according to the instructions in [Section 2.13](#). Full leveling can be enabled by writing a 1 to bit 31 of the RDWR_LVL_RMP_CTRL register and then triggered by writing a 1 to bit 31 of the RDWR_LVL_CTRL register. For forced ratio leveling, program DDR3_CONFIG_23 and DDR3_CONFIG_24 with the effective slave ratio values for devices other than C665x or TCI6612/13/14. For C665x and TCI6612/13/14, program DDR3_CONFIG_REG_25 through DDR3_CONFIG_REG_60 with the effective slave ratio values.

3.2.5 Configuring Read Latency

The read latency can be programmed in the DDR PHY Control 1 Register [4:0]. Read latency can be programmed from a minimum of CAS latency +1 to CAS latency +7. The value programmed should be the required value minus one.

DDR3 Memory Controller Registers

Table 4-1 lists the memory-mapped registers for the DDR3 memory controller. For the memory address of these registers, see the device-specific data manual.

Table 4-1. DDR3 Memory Controller Registers (See datasheet memory map for base address)

| Offset | Acronym | Register Description | Section |
|--------|-------------------|---|------------------------------|
| 000h | MIDR | Module ID and Revision Register | Section 4.1 |
| 004h | STATUS | DDR3 Memory Controller Status Register | Section 4.2 |
| 008h | SDCFG | SDRAM Configuration Register | Section 4.3 |
| 010h | SDRFC | SDRAM Refresh Control Register | Section 4.4 |
| 018h | SDTIM1 | SDRAM Timing 1 Register | Section 4.5 |
| 020h | SDTIM2 | SDRAM Timing 2 Register | Section 4.6 |
| 028h | SDTIM3 | SDRAM Timing 3 Register | Section 4.7 |
| 038h | PMCTL | Power Management Control Register | Section 4.8 |
| 0x54h | LAT_CONFIG | VBUSM Configuration Register | Section 4.9 |
| 0x80 | PERF_CNT_1 | Performance Counter 1 Register | Section 4.10 |
| 0x84 | PERF_CNT_2 | Performance Counter 2 Register | Section 4.11 |
| 0x88 | PERF_CNT_CFG | Performance Counter Config Register | Section 4.12 |
| 0x8C | PERF_CNT_SEL | Performance Counter Master Region Select Register | Section 4.13 |
| 0x90 | PERF_CNT_TIM | Performance Counter Time Register | Section 4.14 |
| 0A4h | IRQSTATUS_RAW_SYS | Interrupt Raw Status Register | Section 4.15 |
| 0ACh | IRQ_STATUS_SYS | Interrupt Status Register | Section 4.16 |
| 0B4h | IRQENABLE_SET_SYS | Interrupt Enable Set Register | Section 4.17 |
| 0BCh | IRQENABLE_CLR_SYS | Interrupt Enable Clear Register | Section 4.18 |
| 0C8h | ZQCONFIG | SDRAM Output Impedance Calibration Configuration Register | Section 4.19 |
| 0D4h | RDWR_LVL_RMP_WIN | Read-Write Leveling Ramp Window Register | Section 4.20 |
| 0D8h | RDWR_LVL_RMP_CTRL | Read-Write Leveling Ramp Control Register | Section 4.21 |
| 0DCh | RDWR_LVL_CTRL | Read-Write Leveling Control Register | Section 4.22 |
| 0E4h | DDR_PHY_CTRL_1 | DDR PHY Control 1 Register | Section 4.23 |
| 100h | PRI_COS_MAP | Priority To Class-Of-Service Mapping Register | Section 4.24 |
| 104h | MSTID_COS_1_MAP | Master ID to Class-Of-Service 1 Mapping Register | Section 4.25 |
| 108h | MSTID_COS_2_MAP | Master ID to Class-Of-Service 2 Mapping Register | Section 4.26 |
| 110h | ECCCTL | ECC Control Register | Section 4.27 |
| 114h | ECCADDR1 | ECC Address Range 1 Register | Section 4.28 |
| 118h | ECCADDR2 | ECC Address Range 2 Register | Section 4.29 |
| 120h | RWTHRESH | Read Write Execution Threshold Register | Section 4.30 |

Table 4-2. DDR3 PHY Leveling Registers (See device datasheet for base address)

| Offset | Acronym | Register Description | Section |
|--|---|--------------------------------|------------------------------|
| 404h | DDR3_CONFIG_0 | DDR3 Configuration 0 Register | Section 4.31 |
| 408h | DDR3_CONFIG_1 | DDR3 Configuration 1 Register | Section 4.32 |
| 40Ch | DDR3_CONFIG_2 | DDR3 Configuration 2 Register | Section 4.33 |
| 410h | DDR3_CONFIG_3 | DDR3 Configuration 3 Register | Section 4.34 |
| 414h | DDR3_CONFIG_4 | DDR3 Configuration 4 Register | Section 4.35 |
| 418h | DDR3_CONFIG_5 | DDR3 Configuration 5 Register | Section 4.36 |
| 41Ch | DDR3_CONFIG_6 | DDR3 Configuration 6 Register | Section 4.37 |
| 420h | DDR3_CONFIG_7 | DDR3 Configuration 7 Register | Section 4.38 |
| 424h | DDR3_CONFIG_8 | DDR3 Configuration 8 Register | Section 4.39 |
| 428h | DDR3_CONFIG_9 | DDR3 Configuration 9 Register | Section 4.40 |
| 42Ch | DDR3_CONFIG_10 | DDR3 Configuration 10 Register | Section 4.41 |
| 434h | DDR3_CONFIG_12 | DDR3 Configuration 12 Register | Section 4.42 |
| 43Ch | DDR3_CONFIG_14 | DDR3 Configuration 14 Register | Section 4.43 |
| 440h | DDR3_CONFIG_15 | DDR3 Configuration 15 Register | Section 4.44 |
| 444h | DDR3_CONFIG_16 | DDR3 Configuration 16 Register | Section 4.45 |
| 448h | DDR3_CONFIG_17 | DDR3 Configuration 17 Register | Section 4.46 |
| 44Ch | DDR3_CONFIG_18 | DDR3 Configuration 18 Register | Section 4.47 |
| 450h | DDR3_CONFIG_19 | DDR3 Configuration 19 Register | Section 4.48 |
| 454h | DDR3_CONFIG_20 | DDR3 Configuration 20 Register | Section 4.49 |
| 458h | DDR3_CONFIG_21 | DDR3 Configuration 21 Register | Section 4.50 |
| 45Ch | DDR3_CONFIG_22 | DDR3 Configuration 22 Register | Section 4.51 |
| 460h | DDR3_CONFIG_23 (NA for TCI6612/13/14 and C665x devices) | DDR3 Configuration 23 Register | Section 4.52 |
| 464h | DDR3_CONFIG_24 (NA for TCI6612/13/14 and C665x devices) | DDR3 Configuration 24 Register | Section 4.53 |
| The following registers are applicable only for C665x and TCI6612/13/14 (Reserved for all other devices). Registers that say 'TCI6612/13/14 only' do not apply to C665x devices. | | | |
| 468h | DDR3_CONFIG_REG_25 | DDR3 Configuration 25 Register | Section 4.54 |
| 46Ch | DDR3_CONFIG_REG_26 | DDR3 Configuration 26 Register | Section 4.55 |
| 470h | DDR3_CONFIG_REG_27 | DDR3 Configuration 27 Register | Section 4.56 |
| 474h | DDR3_CONFIG_REG_28 | DDR3 Configuration 28 Register | Section 4.57 |
| 478h | DDR3_CONFIG_REG_29 (TCI6612/13/14 only) | DDR3 Configuration 29 Register | Section 4.58 |
| 47Ch | DDR3_CONFIG_REG_30 (TCI6612/13/14 only) | DDR3 Configuration 30 Register | Section 4.59 |
| 480h | DDR3_CONFIG_REG_31 (TCI6612/13/14 only) | DDR3 Configuration 31 Register | Section 4.60 |
| 484h | DDR3_CONFIG_REG_32 (TCI6612/13/14 only) | DDR3 Configuration 32 Register | Section 4.61 |
| 488h | DDR3_CONFIG_REG_33 | DDR3 Configuration 33 Register | Section 4.62 |
| 48Ch | DDR3_CONFIG_REG_34 | DDR3 Configuration 34 Register | Section 4.63 |
| 490h | DDR3_CONFIG_REG_35 | DDR3 Configuration 35 Register | Section 4.64 |
| 494h | DDR3_CONFIG_REG_36 | DDR3 Configuration 36 Register | Section 4.65 |
| 498h | DDR3_CONFIG_REG_37 | DDR3 Configuration 37 Register | Section 4.66 |
| 49Ch | DDR3_CONFIG_REG_38 (TCI6612/13/14 only) | DDR3 Configuration 38 Register | Section 4.67 |
| 4A0h | DDR3_CONFIG_REG_39 (TCI6612/13/14 only) | DDR3 Configuration 39 Register | Section 4.68 |
| 4A4h | DDR3_CONFIG_REG_40 (TCI6612/13/14 only) | DDR3 Configuration 40 Register | Section 4.69 |
| 4A8h | DDR3_CONFIG_REG_41 (TCI6612/13/14 only) | DDR3 Configuration 41 Register | Section 4.70 |
| 4ACh | DDR3_CONFIG_REG_42 | DDR3 Configuration 42 Register | Section 4.71 |
| 4B0h | DDR3_CONFIG_REG_43 | DDR3 Configuration 43 Register | Section 4.72 |
| 4B4h | DDR3_CONFIG_REG_44 | DDR3 Configuration 44 Register | Section 4.73 |
| 4B8h | DDR3_CONFIG_REG_45 | DDR3 Configuration 45 Register | Section 4.74 |
| 4BCh | DDR3_CONFIG_REG_46 | DDR3 Configuration 46 Register | Section 4.75 |

Table 4-2. DDR3 PHY Leveling Registers (See device datasheet for base address) (continued)

| Offset | Acronym | Register Description | Section |
|--------|---|--------------------------------|------------------------------|
| 4C0h | DDR3_CONFIG_REG_47 (TCI6612/13/14 only) | DDR3 Configuration 47 Register | Section 4.76 |
| 4C4h | DDR3_CONFIG_REG_48 (TCI6612/13/14 only) | DDR3 Configuration 48 Register | Section 4.77 |
| 4C8h | DDR3_CONFIG_REG_49 (TCI6612/13/14 only) | DDR3 Configuration 49 Register | Section 4.78 |
| 4CCh | DDR3_CONFIG_REG_50 (TCI6612/13/14 only) | DDR3 Configuration 50 Register | Section 4.79 |
| 4D0h | DDR3_CONFIG_REG_51 | DDR3 Configuration 51 Register | Section 4.80 |
| 4D4h | DDR3_CONFIG_REG_52 | DDR3 Configuration 52 Register | Section 4.81 |
| 4D8h | DDR3_CONFIG_REG_53 | DDR3 Configuration 53 Register | Section 4.82 |
| 4DCh | DDR3_CONFIG_REG_54 | DDR3 Configuration 54 Register | Section 4.83 |
| 4E0h | DDR3_CONFIG_REG_55 | DDR3 Configuration 55 Register | Section 4.84 |
| 4E4h | DDR3_CONFIG_REG_56 (TCI6612/13/14 only) | DDR3 Configuration 56 Register | Section 4.85 |
| 4E8h | DDR3_CONFIG_REG_57 (TCI6612/13/14 only) | DDR3 Configuration 57 Register | Section 4.86 |
| 4ECh | DDR3_CONFIG_REG_58 (TCI6612/13/14 only) | DDR3 Configuration 58 Register | Section 4.87 |
| 4F0h | DDR3_CONFIG_REG_59 (TCI6612/13/14 only) | DDR3 Configuration 59 Register | Section 4.88 |
| 4F4h | DDR3_CONFIG_REG_60 | DDR3 Configuration 60 Register | Section 4.89 |

4.1 Module ID and Revision Register (MIDR)

The Module ID and Revision register contains the revision number and identification data of the DDR3 peripheral, and is described in the following figure and table.

Figure 4-1. Module ID and Revision Register (MIDR)

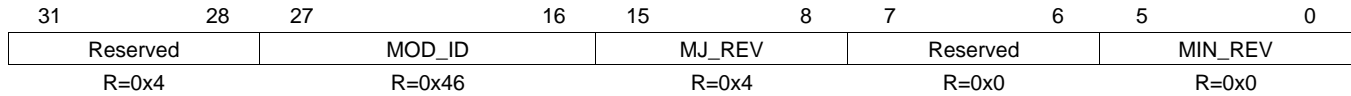

4.2 DDR3 Memory Controller Status Register (STATUS)

This register contains the status of the DDR3 module and is described in the following figure and table.

Figure 4-2. DDR3 Memory Controller Status Register (STATUS)

| | | | | | | | | | |
|-----|----------|------------|---------|---------|----------|-------|----------|---|---|
| 31 | 30 | 7 | 6 | 5 | 4 | 3 | 2 | 1 | 0 |
| BE | Reserved | RDLVGATETO | RDLVLTO | WRLVLTO | Reserved | IFRDY | Reserved | | |
| R=0 | R=0 | R=0 | R=0 | R=0 | R=0 | R=0 | R=0 | | |

Legend: R = Read only; W = Write only; - n = value after reset; -x, value is indeterminate — see the device-specific data manual

Table 4-4. DDR3 Memory Controller Status Register (STATUS) Field Descriptions

| Bit | Field | Attribute | Description |
|------|------------|-----------|---|
| 31 | BE | R | Big Endian. Reflects the value on the BIG_ENDIAN port that defines whether the EMIF is in big or little-endian mode |
| 30 | Reserved | R | Value = 0 This field is tied off to 0x1. |
| 29-7 | Reserved | R | Value = 0 Reserved. The reserved bit location is always read as 0. A value written to this field has no effect. |
| 6 | RDLVGATETO | R | Read DQS Gate Training Timeout <ul style="list-style-type: none"> • 0 = Reset value • 1 = Indicates read DQS gate training has timed out |
| 5 | RDLVLTO | R | Read Data Eye Training Timeout <ul style="list-style-type: none"> • 0 = Reset value • 1 = Read data eye training has timed out |
| 4 | WRLVLTO | R | Write Leveling Timeout <ul style="list-style-type: none"> • 0 = Reset value • 1 = Write Leveling has timed out |
| 3 | Reserved | R | Reserved. The reserved bit location is always read as 0. A value written to this field has no effect. |
| 2 | IFRDY | R | DDR3 memory controller interface logic ready bit. The interface logic controls the signals used to communicate with DDR3 SDRAM devices. This bit displays the status of the interface logic. <ul style="list-style-type: none"> • 0 = Interface logic is not ready; either powered down, not ready, or not locked. • 1 = Interface logic is powered up, locked and ready for operation. |
| 1-0 | Reserved | R | Value = 0 Reserved. The reserved bit location is always read as 0. A value written to this field has no effect. |

4.3 SDRAM Configuration Register (SDCFG)

The SDRAM Configuration Register (SDCFG) contains field that program the DDR3 memory controller to meet the specifications of the DDR3 memory. These fields configure the DDR3 memory controller to match the data bus width, CAS latency, number of internal banks, and page size of the external DDR3 memory. For more information on initializing the configuration registers of the DDR3 memory controller, see [Section 3.2](#).

Figure 4-3. SDRAM Configuration Register (SDCFG)

| | | | | | | | | | | | | |
|------------|----|----|-----------|----|----------|----|----------|----|---------|----|-------------|---|
| 31 | 29 | 28 | 27 | 26 | 24 | 23 | 22 | 21 | 20 | 19 | 18 | |
| SDRAM_TYPE | | | IBANK_POS | | DDR_TERM | | Reserved | | DYN_ODT | | SDRAM_DRIVE | |
| RW=0x0 | | | RW=0x0 | | RW=0x0 | | R=0x0 | | RW=0x0 | | RW=0x0 | |
| 17 | 16 | 15 | 14 | 13 | 10 | 9 | 7 | 6 | 4 | 3 | 2 | 0 |
| CWL | | | NM | | CL | | ROWSIZE | | IBANK | | PAGESIZE | |
| RW=0x0 | | | RW=0x0 | | RW=0x2 | | RW=0x0 | | RW=0x0 | | RW=0x0 | |

Legend: R = Read only; W = Write only; - n = value after reset; -x, value is indeterminate — see the device-specific data manual

Table 4-5. SDRAM Configuration Register (SDCFG) Field Descriptions

| Bit | Field | Attribute | Description |
|-------|-----------------|-----------|--|
| 31-29 | SDRAM_TYPE | RW | Value = 3 SDRAM type selection. Set to 3 for DDR3. All other values reserved. |
| 28-27 | IBANK_POS | RW | Internal bank position. <ul style="list-style-type: none"> 0 = Assigns internal bank address bits from address as shown in Table 2-5 1,2,3 = Assign internal bank address bits from address as shown in Table 2-6 |
| 26-24 | DDR_TERM | RW | Defines termination resistor value. <ul style="list-style-type: none"> 0 = Disables termination 1 = RZQ/4 2 = RZQ/2 3 = RZQ/6 4 = RZQ/12 5 = RZQ/8 |
| 23 | Reserved | R | Value = 0 Reserved. The reserved bit location is always read as 0. A value written to this field has no effect. |
| 22-21 | DYN_ODT | RW | Dynamic On-Die Termination <ul style="list-style-type: none"> 0 = Turn off dynamic ODT. 1 = RZQ/4 2 = RZQ/2 All other values reserved. |
| 20 | DDR_DISABLE_DLL | RW | Disable DLL select. <ul style="list-style-type: none"> 0 = Normal Operation. 1 = Disables DLL inside SDRAM. |
| 19-18 | SDRAM_DRIVE | RW | SDRAM drive strength. <ul style="list-style-type: none"> 0 = RZQ/6 1 = RZQ/7 All other values reserved. |
| 17-16 | CWL | RW | CAS Write Latency. Lower value gives better performance. <ul style="list-style-type: none"> 0 = CAS write latency of 5 1 = CAS write latency of 6 2 = CAS write latency of 7 3 = CAS write latency of 8 |

Table 4-5. SDRAM Configuration Register (SDCFG) Field Descriptions (continued)

| Bit | Field | Attribute | Description |
|-------|----------|-----------|---|
| 15-14 | NM | RW | <p>DDR3 data bus width. A write to this bit field will cause the memory controller to start SDRAM initialization sequence.</p> <ul style="list-style-type: none"> 0 = 64-bit bus width. 1 = 32-bit bus width. 2 = 16-bit bus width. <p>All other values reserved.</p> |
| 13-10 | CL | RW | <p>CAS Latency. The value of this field defines the CAS latency, to be used when accessing connected SDRAM devices. A write to this field will cause the DDR3 memory controller to start the SDRAM initialization sequence.</p> <ul style="list-style-type: none"> 2 = CAS latency of 5. 4 = CAS latency of 6. 6 = CAS latency of 7. 8 = CAS latency of 8. 10 = CAS latency of 9. 12 = CAS latency of 10. 14 = CAS latency of 11. <p>All other values are reserved.</p> |
| 9-7 | ROWSIZE | RW | <p>Row size. Defines the number of row address bits of connected SDRAM devices</p> <ul style="list-style-type: none"> 0 = 9 row bits. 1 = 10 row bits. 2 = 11 row bits. 3 = 12 row bits. 4 = 13 row bits. 5 = 14 row bits. 6 = 15 row bits. 7 = 16 row bits. |
| 6-4 | IBANK | RW | <p>Internal SDRAM bank setup bits. Defines number of banks inside connected SDRAM devices. A write to this bit will cause the DDR3 memory controller to start SDRAM initialization sequence. Values 4-7 are reserved for this field. A word is equal to the bus width of the individual SDRAM devices used (example, 1 byte for x8 and 2bytes for x16 devices)</p> <ul style="list-style-type: none"> 0 = One bank SDRAM devices. 1 = Two bank SDRAM devices. 2 = Four bank SDRAM devices. 3 = Eight bank SDRAM devices. |
| 3 | EBANK | RW | <p>External chip select setup. Defines whether SDRAM accesses use 1 or 2 chip select lines as follows:</p> <ul style="list-style-type: none"> 0 = Use DCE0# for all SDRAM accesses. 1 = Use DEC0# and DCE1# for SDRAM accesses. |
| 2-0 | PAGESIZE | RW | <p>Page size bits. Defines internal page size of the external DDR3 memory. A write to this bit will cause the DDR3 memory controller to start the SDRAM initialization sequence. Values 4-7 are reserved for this field. A word is equal to the bus width of the individual SDRAM devices used (example, 1 byte for x8 and 2bytes for x16 devices)</p> <ul style="list-style-type: none"> 0 = 256-word page requiring 8 column address bits. 1 = 512-word page requiring 9 column address bits. 2 = 1024-word page requiring 10 column address bits. 3 = 2048-word page requiring 11 column address bits. |

4.4 SDRAM Refresh Control Register (SDRFC)

The SDRAM Refresh Control Register (SDRFC) is used to configure the DDR3 memory controller to:

- Enter and Exit the self-refresh state.
- Meet the refresh requirements of the attached DDR3 device by programming a rate at which the DDR3 memory controller issues autorefresh commands.

The SDRFC register is described in the following figure and table.

Figure 4-4. SDRAM Refresh Control Register (SDRFC)

| | | | | | | | | | | |
|-------------|----------|--------|--------|----------|--------|----------|----|--------------|----|---|
| 31 | 30 | 29 | 28 | 27 | 26 | 24 | 23 | 16 | 15 | 0 |
| INITREF_DIS | Reserved | SRT | ASR | Reserved | PASR | Reserved | | REFRESH_RATE | | |
| RW=0x1 | R=0x0 | RW=0x0 | RW=0x0 | R=0x0 | RW=0x0 | R=0x0 | | RW=0x61A8 | | |

Legend: R = Read only; W = Write only; - n = value after reset; -x, value is indeterminate — see the device-specific data manual

Table 4-6. SDRAM Refresh Control (SDRFC) Register Field Descriptions

| Bit | Field | Attribute | Description |
|-------|--------------|-----------|---|
| 31 | INITREF_DIS | RW | Initialization and Refresh Disable. <ul style="list-style-type: none"> • 0 = Normal operation • 1 = Disables SDRAM initialization and refreshes, but carries out SDRAM write/read transactions |
| 30 | Reserved | R | Value = 0 Reserved. The reserved bit location is always read as 0. A value written to this field has no effect. |
| 29 | SRT | RW | DDR3 self-refresh temperature range. A write to this bit will cause the DDR3 memory controller to start SDRAM initialization sequence. <ul style="list-style-type: none"> • 0 = Normal operating temperature range. This must be set to zero if ASR bit is set to 1. • 1 = Extended operating temperature range when ASR bit is set to zero. |
| 28 | ASR | RW | A write to this bit will cause the DDR3 memory controller to start SDRAM initialization sequence. <ul style="list-style-type: none"> • 0 = Use manual self-refresh • 1 = Auto self-refresh enable |
| 27 | Reserved | R | Reserved. The reserved bit location is always read as 0. A value written to this field has no effect |
| 26-24 | PASR | RW | Partial Array self-refresh. These bits get loaded into the extended mode register during initialization. A write to this bit will cause the DDR3 memory controller to start SDRAM initialization sequence. <ul style="list-style-type: none"> • 0 = Full-array. • 1 or 5 = ½ array. • 2 or 6 = ¼ array. • 3 or 7 = 1/8 array. • 4 = ¾ array. |
| 23-16 | Reserved | R | Value = 0 Reserved. The reserved bit location is always read as 0. A value written to this field has no effect |
| 15-0 | REFRESH_RATE | RW | The value in this field is used to define the rate at which connected SDRAM devices will be refreshed. REFRESH_RATE = Refresh period * DDR3 clock frequency. |

4.5 SDRAM Timing 1 (SDTIM1) Register

SDRAM Timing 1 register (SDTIM1) configures the DDR3 memory controller to meet many of the AC timing specifications of the DDR3 memory. Note that DDR3CLKOUT is equal to the period of the DDR3CLKOUT signal. See the DDR3 memory datasheet for information on appropriate values to program each field. The SDTIM1 register is described in the following figure and table.

Figure 4-5. SDRAM Timing 1 (SDTIM1) Register

| | | | | | | | | | | | | | | | |
|----------|----|--------|----|--------|----|--------|----|---------|----|---------|---|--------|---|--------|---|
| 31 | 29 | 28 | 25 | 24 | 21 | 20 | 17 | 16 | 12 | 11 | 6 | 5 | 3 | 2 | 0 |
| Reserved | | T_RP | | T_RCD | | T_WR | | T_RAS | | T_RC | | T_RRD | | T_WTR | |
| R=0x0 | | RW=0xA | | RW=0xA | | RW=0xB | | RW=0x1B | | RW=0x26 | | RW=0x5 | | RW=0x4 | |

Legend: R = Read only; W = Write only; - n = value after reset; -x, value is indeterminate — see the device-specific data manual

Table 4-7. SDRAM Timing 1 (SDTIM1) Register Field Descriptions

| Bit | Field | Attribute | Description |
|-------|----------|-----------|---|
| 31-29 | Reserved | R | Value = 0 Reserved. The reserved bit location is always read as 0. A value written to this field has no effect |
| 28-25 | T_RP | RW | These bits specify the minimum number of DDR3CLKOUT cycles from a precharge command to a refresh or activate command, minus 1. The value of this parameter can be derived from the t_{RP} AC timing parameter in the DDR3 memory data sheet. Calculate using the formula: $T_RP = (t_{RP}/t_{CK}) - 1$ |
| 24-21 | T_RCD | RW | These bits specify the minimum number of DDR3CLKOUT cycles from an activate command to a read or write command, minus 1. The value of this parameter can be derived from the t_{RCD} AC timing parameter in the DDR3 memory data sheet. Calculate using the formula: $T_RCD = (t_{RCD}/t_{CK}) - 1$ |
| 20-17 | T_WR | RW | These bits specify the minimum number of DDR3CLKOUT cycles from the last write transfer to a precharge command, minus 1. The value of this parameter can be derived from the t_{WR} AC timing parameter in the DDR3 memory data sheet. Calculate using the formula: $T_WR = (t_{WR}/t_{CK}) - 1$ |
| 16-12 | T_RAS | RW | These bits specify the minimum number of DDR3CLKOUT cycles from an activate command to precharge command, minus 1. The value of this parameter can be derived from the minimum value of the t_{RAS} AC timing parameter in the DDR3 memory data sheet. Calculate using the formula: $T_RAS = (t_{RAS}/t_{CK}) - 1$ |
| 11-6 | T_RC | RW | These bits specify the minimum number of DDR3CLKOUT cycles from an activate command to an activate command, minus 1. The value of this parameter can be derived from the t_{RC} AC timing parameter in the DDR3 memory data sheet. Calculate using the formula: $T_RC = (t_{RC}/t_{CK}) - 1$ |
| 5-3 | T_RRD | RW | These bits specify the minimum number of DDR3CLKOUT cycles from an activate to an activate in a different bank, minus 1. The value of this parameter can be derived from the t_{FAW} AC timing parameter in the DDR3 memory data sheet. Calculate using the formula: $T_RRD = (t_{FAW}/(4*t_{CK})) - 1$ |
| 2-0 | T_WTR | RW | These bits specify the minimum number of DDR3CLKOUT cycles from the last write to a read command, minus 1. The value of this parameter can be derived from the t_{WTR} AC timing parameter in the DDR3 memory data sheet. Convert the t_{WTR} value from the memory datasheet into ns before using the formula below. Calculate using the formula: $T_WTR = (t_{WTR}/t_{CK}) - 1$ |

4.6 SDRAM Timing 2 (SDTIM2) Register

Like the SDRAM Timing 1 register (SDTIM1), the SDRAM Timing 2 register (SDTIM2) also configures the DDR3 memory controller to meet many of the AC timing specifications of the DDR3 memory. See the DDR3 memory datasheet for information on appropriate values to program each field. The SDTIM2 register is described in the following figure and table.

Figure 4-6. SDRAM Timing 2 (SDTIM2) Register

| | | | | | | | | | | | | |
|----------|--------|----------|----------|---------|----------|----------|----------|--------|----------|--------|----------|----------|
| 31 | 30 | 28 | 27 | 25 | 24 | 16 | 15 | 6 | 5 | 3 | 2 | 0 |
| Reserved | T_XP | Reserved | Reserved | T_XSNR | Reserved | T_XSRD | Reserved | T_RTP | Reserved | T_CKE | Reserved | Reserved |
| R=0x0 | RW=0x6 | R=0x7 | R=0x7 | RW=0x5F | R=0x7 | RW=0x1FF | R=0x7 | RW=0x5 | R=0x7 | RW=0x5 | R=0x7 | R=0x7 |

Legend: R = Read only; W = Write only; - n = value after reset; -x, value is indeterminate — see the device-specific data manual

Table 4-8. SDRAM Timing 2 (SDTIM2) Register Field Descriptions

| Bit | Field | Attribute | Description |
|-------|----------|-----------|--|
| 31 | Reserved | R | Value = 0 Reserved. The reserved bit location is always read as 0. A value written to this field has no effect |
| 30-28 | T_XP | RW | These bits specify the minimum number of DDR3CLKOUT cycles from Power down exit to any command other than a read command, minus 1. The value of this parameter can be derived from the t_{XP} AC timing parameter in the DDR3 memory data sheet. Convert the t_{XP} datasheet parameter value into ns before using formula below. Calculate using the formula: $T_XP = (t_{XP}/t_{CK}) - 1$ |
| 27-25 | Reserved | R | Reserved. A value written to this field has no effect. |
| 24-16 | T_XSNR | RW | These bits specify the minimum number of DDR3CLKOUT cycles from a self-refresh exit to a command that does not require a locked DLL, minus 1. The value of this parameter can be derived from the t_{XS} AC timing parameter in the DDR3 memory data sheet. Calculate using the formula: $T_XSNR = (t_{XS}/t_{CK}) - 1$ |
| 15-6 | T_XSRD | RW | These bits specify the minimum number of DDR3CLKOUT cycles from a self-refresh exit to a command that requires a locked DLL, minus 1. The value of this parameter can be derived from the t_{XSDLL} AC timing parameter in the DDR3 memory data sheet. This parameter typically appears in the datasheet in terms of t_{CK} clock cycles. Calculate using the formula: $T_XSRD = t_{XSDLL} - 1$ |
| 5-3 | T_RTP | RW | These bits specify the minimum number of DDR3CLKOUT cycles from the last read to precharge command, minus 1. The value of this parameter can be derived from the t_{RTP} AC timing parameter in the DDR3 memory data sheet. Convert the t_{RTP} datasheet parameter value into ns before using formula below. Calculate using the formula: $T_RTP = (t_{RTP}/t_{CK}) - 1$ |
| 2-0 | T_CKE | RW | These bits specify the minimum number of DDR3CLKOUT cycles between transitions on the DSDCKE pin, minus 1. The value of this parameter can be derived from the t_{CKE} AC timing parameter in the DDR3 memory data sheet. Calculate using the formula: $T_CKE = (t_{CKE}/t_{CK}) - 1$ |

4.7 SDRAM Timing 3 (SDTIM3) Register

Like the SDRAM Timing 1 and 2 registers (SDTIM1 & SDTIM2), the SDRAM Timing 3 register (SDTIM3) also configures the DDR3 memory controller to meet many of the AC timing specifications of the DDR3 memory. See the DDR3 memory datasheet for information on appropriate values to program each field. The SDTIM3 register is described in the following figure and table.

Figure 4-7. SDRAM Timing 3 (SDTIM3) Register

| | | | | | | | | | | | | | |
|-----------|----|--------|----|---------|----|---------|----|----------|----|---------|---|-----------|---|
| 31 | 28 | 27 | 24 | 23 | 21 | 20 | 15 | 14 | 13 | 12 | 4 | 3 | 0 |
| T_PDLL_UL | | T_CSTA | | T_CKESR | | ZQ_ZQCS | | Reserved | | T_RFC | | T_RAS_MAX | |
| RW=0x0 | | RW=0x0 | | RW=0x3 | | RW=0x3F | | R=0x3 | | RW=0x57 | | RW=0x6 | |

Legend: R = Read only; W = Write only; - n = value after reset; -x, value is indeterminate — see the device-specific data manual

Table 4-9. SDRAM Timing 3 (SDTIM3) Register Field Descriptions

| Bit | Field | Attribute | Description |
|-------|-----------|-----------|---|
| 31-28 | T_PDLL_UL | RW | Value = 0 This field must always be programmed to 0x5. |
| 27-24 | T_CSTA | RW | Minimum DDR3CLKOUT cycles between write-to-write or read-to-read data phases to different chip selects, minus 1. This field should be set according to PHY requirements as 0x5. |
| 23-21 | T_CKESR | RW | Value = 0 Minimum DDR3CLKOUT cycles for which DDR3 should remain in self-refresh. This parameter typically appears as number of t_{CK} clock cycles. $T_CKESR = (t_{CKESR}/t_{CK}) - 1$ |
| 20-15 | ZQ_ZQCS | RW | These bits specify the minimum number of DDR3CLKOUT cycles for a ZQCS command, minus 1. The value of this parameter can be derived from the t_{ZQCS} AC timing parameter in the DDR3 memory data sheet. This parameter typically appears as number of t_{CK} clock cycles. Calculate using the formula $ZQ_ZQCS = t_{ZQCS} - 1$ |
| 14-13 | Reserved | R | Value = 0 Reserved. The reserved bit location is always read as 0. A value written to this field has no effect. |
| 12-4 | T_RFC | RW | These bits specify the minimum number of DDR3CLKOUT cycles from a refresh or load mode command to a refresh or activate command, minus 1. The value of this parameter can be derived from the t_{RFC} AC timing parameter in the DDR3 memory data sheet. Calculate using the formula $T_RFC = (t_{RFC}/t_{CK}) - 1$ |
| 3-0 | T_RAS_MAX | RW | This field must always be programmed to 0xF. |

4.8 Power Management Control Register (PMCTL)

The PMCTL register is described in the following figure and table.

Figure 4-8. Power Management Control Register (PMCTL)

| | | | | | | | | | | | | | | | |
|----------|----|--------|--------|-------|----|----------|---|--------|---------|-------|--|--------|--|--|----------|
| 31 | 16 | 15 | 12 | 11 | 10 | 8 | 7 | 4 | 3 | 0 | | | | | |
| Reserved | | | PD_TIM | | | Reserved | | | LP_MODE | | | SR_TIM | | | Reserved |
| R=0x0 | | RW=0x0 | | R=0x0 | | RW=0x0 | | RW=0x0 | | R=0x0 | | R=0x0 | | | |

Legend: R = Read only; W = Write only; - n = value after reset; -x, value is indeterminate — see the device-specific data manual

Table 4-10. Power Management Control Register (PMCTL) Field Descriptions

| Bit | Field | Attribute | Description |
|-------|----------|-----------|---|
| 31-16 | Reserved | R | Value = 0 Reserved. The reserved bit location is always read as 0. A value written to this field has no effect |
| 15-12 | PD_TIM | RW | Power Management timer for power-down. The DDR3 memory controller will put the SDRAM in power-down mode after the DDR3 controller is idle for PD_TIM number of DDR3CLKOUT cycles and if LP_MODE is set to 4. <ul style="list-style-type: none"> 0 = Immediately enter power-down 1 = Enter power-down after 16 clocks 2 = Enter power-down after 32 clocks 3 = Enter power-down after 64 clocks 4 = Enter power-down after 128 clocks 5 = Enter power-down after 256 clocks 6 = Enter power-down after 512 clocks 7 = Enter power-down after 1024 clocks 8 = Enter power-down after 2048 clocks 9 = Enter power-down after 4096 clocks 10 = Enter power-down after 8912 clocks 11 = Enter power-down after 16384 clocks 12 = Enter power-down after 32768 clocks 13 = Enter power-down after 65536 clocks 14 = Enter power-down after 131072 clocks 15 = Enter power-down after 262144 clocks |
| 11 | Reserved | R | Value = 0 Reserved. The reserved bit location is always read as 0. A value written to this field has no effect |
| 10-8 | LP_MODE | RW | Automatic power management enable. <ul style="list-style-type: none"> 2 = Self-refresh mode 4 = Power-down mode All other values will disable automatic power management. |

Table 4-10. Power Management Control Register (PMCTL) Field Descriptions (continued)

| Bit | Field | Attribute | Description |
|-----|----------|-----------|--|
| 7-4 | SR_TIM | RW | Power management timer for self-refresh. The DDR3 memory controller will put the external SDRAM in self-refresh mode after DDR3 controller has been idle for these number of DDR3CLKOUT cycles and LP_MODE is set to 2. <ul style="list-style-type: none"> • 0 = Immediately enter self-refresh • 1 = Enter self-refresh after 16 clocks • 2 = Enter self-refresh after 32 clocks • 3 = Enter self-refresh after 64 clocks • 4 = Enter self-refresh after 128 clocks • 5 = Enter self-refresh after 256 clocks • 6 = Enter self-refresh after 512 clocks • 7 = Enter self-refresh after 1024 clocks • 8 = Enter self-refresh after 2048 clocks • 9 = Enter self-refresh after 4096 clocks • 10 = Enter self-refresh after 8912 clocks • 11 = Enter self-refresh after 16384 clocks • 12 = Enter self-refresh after 32768 clocks • 13 = Enter self-refresh after 65536 clocks • 14 = Enter self-refresh after 131072 clocks • 15 = Enter self-refresh after 262144 clocks |
| 3-0 | Reserved | R | Reserved |

4.9 VBUSM Configuration Register (VBUSM_CONFIG)

The VBUSM_CONFIG register is described in the following figure and table.

Figure 4-9. VBUSM Configuration Register (VBUSM_CONFIG)

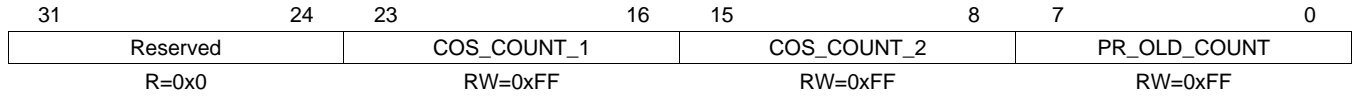

Legend: R = Read only; W = Write only; - n = value after reset; -x, value is indeterminate — see the device-specific data manual

Table 4-11. VBUSM Configuration Register (VBUSM_CONFIG) Field Descriptions

| Bit | Field | Attribute | Description |
|-------|--------------|-----------|--|
| 31-24 | Reserved | R | Value = 0 Reserved. The reserved bit location is always read as 0. A value written to this field has no effect. |
| 23-16 | COS_COUNT_1 | RW | Value = 0xFF Priority raise counter for Class of Service 1. Number of DDR3CLKOUT cycles after which the DDR3 controller momentarily raises the priority of Class of Service 1 commands in Command FIFO. Number of clock cycles = COS_COUNT_1 x 16 clocks |
| 15-8 | COS_COUNT_2 | RW | Value = 0xFF Priority raise counter for Class of Service 2. Number of DDR3CLKOUT cycles after which the DDR3 controller momentarily raises the priority of Class of Service 2 commands in Command FIFO. Number of clock cycles = COS_COUNT_2 x 16 clocks |
| 7-0 | PR_OLD_COUNT | RW | Value = 0xFF Priority raise old counter. Number of DDR3CLKOUT cycles after which DDR3 controller momentarily raises the priority of the oldest command in Command FIFO. Number of clock cycles = PR_OLD_COUNT_2 x 16 clocks |

4.10 Performance Counter 1 Register (PERF_CNT_1)

The PERF_CNT_1 register is described in the following figure and table.

Figure 4-10. Performance Counter 1 Register (PERF_CNT_1)

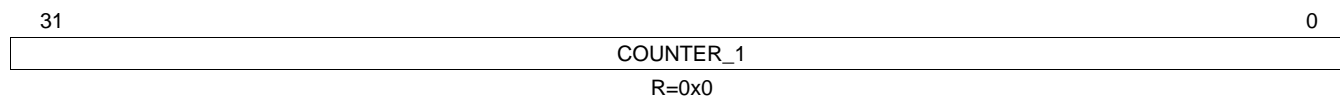

Legend: R = Read only; W = Write only; - n = value after reset; -x, value is indeterminate — see the device-specific data manual

Table 4-12. Performance Counter 1 Register (PERF_CNT_1) Field Descriptions

| Bit | Field | Attribute | Description |
|------|-----------|-----------|---|
| 31-0 | COUNTER_1 | R | 32-bit counter can be programmed as specified in the Performance Counter Config and Performance Counter Master Region Select registers. |

4.11 Performance Counter 2 Register (PERF_CNT_2)

The PERF_CNT_2 register is described in the following figure and table.

Figure 4-11. Performance Counter 2 Register (PERF_CNT_2)

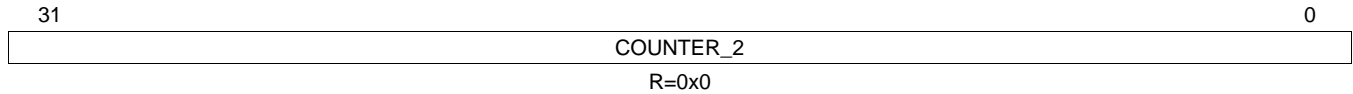

Legend: R = Read only; W = Write only; - n = value after reset; -x, value is indeterminate — see the device-specific data manual

Table 4-13. Performance Counter 2 Register (PERF_CNT_2) Field Descriptions

| Bit | Field | Attribute | Description |
|------|-----------|-----------|---|
| 31-0 | COUNTER_2 | R | 32-bit counter can be programmed as specified in the Performance Counter Config and Performance Counter Master Region Select registers. |

4.12 Performance Counter Config Register (PERF_CNT_CFG)

The PERF_CNT_CFG register is described in the following figure and table.

Figure 4-12. Performance Counter Config Register (PERF_CNT_CFG)

| | | | | | |
|----------------|-----------------|----------|-----------|----|----|
| 31 | 30 | 29 | 20 | 19 | 16 |
| CNTR2_MSTID_EN | CNTR2_REGION_EN | Reserved | CNTR2_CFG | | |
| RW=0x0 | RW=0x0 | R=0x0 | RW=0x1 | | |
| 15 | 14 | 13 | 4 | 3 | 0 |
| CNTR1_MSTID_EN | CNTR1_REGION_EN | Reserved | CNTR1_CFG | | |
| RW=0x0 | RW=0x0 | R=0x0 | RW=0x0 | | |

Legend: R = Read only; W = Write only; - n = value after reset; -x, value is indeterminate — see the device-specific data manual

Table 4-14. Performance Counter Config Register (PERF_CNT_CFG) Field Descriptions

| Bit | Field | Attribute | Description |
|-------|-----------------|-----------|--|
| 31 | CNTR2_MSTID_EN | RW | Master ID filter enable for Performance Counter 2 Register. Set to 1 to enable filtering of events for counter 2 by Master ID. Refer to your device data manual for the master IDs of various masters. |
| 30 | CNTR2_REGION_EN | RW | Memory space region enable for Performance Counter 2 Register. Set to 1 to enable filtering of events for counter 2 by the accessed memory region. |
| 29-20 | Reserved | R | Value = 0x0 Reserved |
| 19-16 | CNTR2_CFG | RW | Filter configuration selected for Performance Counter 2. This field selects the type of event to count for Counter 2. Refer to Table 2-17 for various configuration options. |
| 15 | CNTR1_MSTID_EN | RW | Master ID filter enable for Performance Counter 1 Register. Set to 1 to enable filtering of events for counter 1 by Master ID. Refer to your device data manual for the master IDs of various masters. |
| 14 | CNTR1_REGION_EN | RW | Memory space region enable for Performance Counter 1 Register. Set to 1 to enable filtering of events for counter 1 by the accessed memory region. |
| 13-4 | Reserved | R | Value = 0x0 Reserved |
| 3-0 | CNTR1_CFG | RW | Filter configuration selected for Performance Counter 1. This field selects the type of event to count for Counter 1. Refer to Table 2-17 for various configuration options. |

4.13 Performance Counter Master Region Select Register (PERF_CNT_SEL)

For events that can be configured to enable master ID and/or memory region filters, the value of the master ID and the region select options for the counters are programmed in the PERF_CNT_SEL register. The PERF_CNT_SEL register is described in the following figure and table.

Figure 4-13. Performance Counter Master Region Select Register (PERF_CNT_SEL)

| | | | | | | | | | | | |
|--------|----------|----|-------------|----|--------|----|----------|---|-------------|---|---|
| 31 | 24 | 23 | 20 | 19 | 16 | 15 | 8 | 7 | 4 | 3 | 0 |
| MSTID2 | Reserved | | REGION_SEL2 | | MSTID1 | | Reserved | | REGION_SEL1 | | |
| RW=0x0 | R=0x0 | | RW=0x0 | | RW=0x0 | | R=0x0 | | RW=0x0 | | |

Legend: R = Read only; W = Write only; - n = value after reset; -x, value is indeterminate — see the device-specific data manual

Table 4-15. Performance Counter Master Region Select Register (PERF_CNT_SEL) Field Descriptions

| Bit | Field | Attribute | Description |
|-------|-------------|-----------|---|
| 31-24 | MSTID2 | RW | Master ID for Performance Counter 2 Register. Refer to your device data manual for the master IDs of various masters. |
| 23-20 | Reserved | R | Value = 0x0 Reserved |
| 19-16 | REGION_SEL2 | RW | Region select for Performance Counter 2. <ul style="list-style-type: none"> • 0x0 - DDR3 memory space • 0x7 - DDR3 controller memory mapped registers All other values are reserved. |
| 15-8 | MSTID1 | RW | Master ID for Performance Counter 1 Register. Refer to your device data manual for the master IDs of various masters. |
| 7-4 | Reserved | R | Value = 0x0 Reserved |
| 3-0 | REGION_SEL1 | RW | Region select for Performance Counter 1. <ul style="list-style-type: none"> • 0x0 - DDR3 memory space • 0x7 - DDR3 controller memory mapped registers All other values are reserved. |

4.14 Performance Counter Time Register (PERF_CNT_TIM)

The PERF_CNT_TIM register is described in the following figure and table.

Figure 4-14. Performance Counter Time Register (PERF_CNT_TIM)

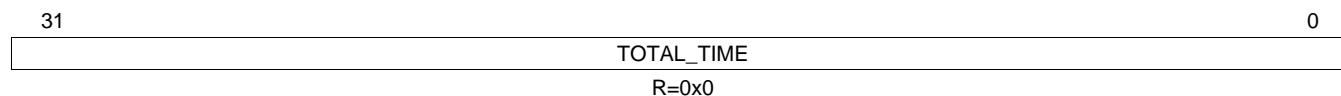

Legend: R = Read only; W = Write only; - n = value after reset; -x, value is indeterminate — see the device-specific data manual

Table 4-16. Performance Counter Time Register (PERF_CNT_TIM) Field Descriptions

| Bit | Field | Attribute | Description |
|------|------------|-----------|---|
| 31-0 | TOTAL_TIME | R | 32-bit counter continuously counts number of DDR/2 clock cycles elapsed after the controller is brought out of reset. |

4.17 Interrupt Enable Set Register (IRQSTATUS_SET_SYS)

The IRQSTATUS_SET_SYS register is described in the following figure and table.

Figure 4-17. Interrupt Enable Set Register (IRQSTATUS_SET_SYS)

| | | | | | | |
|----------|----------------|----------------|----------|---------|---|---|
| 31 | 5 | 4 | 3 | 2 | 1 | 0 |
| Reserved | RD_ECC_ERR_SYS | WR_ECC_ERR_SYS | Reserved | ERR_SYS | | |
| R=0x0 | WOS=0x0 | WOS=0x0 | R=0x0 | WOS=0x0 | | |

Legend: R = Read only; WOS = Write one to set; - n = value after reset; -x, value is indeterminate — see the device-specific data manual

Table 4-19. Interrupt Enable Set Register (IRQSTATUS_SET_SYS) Field Descriptions

| Bit | Field | Attribute | Description |
|------|----------------|-----------|---|
| 31-5 | Reserved | R | Value = 0x0 Reserved. |
| 4 | RD_ECC_ERR_SYS | WOS | Value = 0x0 Enabled set for read ECC error interrupt. Writing a 1 will enable the read ECC error interrupt, set this bit as well as the bit in Interrupt Enable Clear Register. Writing a 0 has no effect. |
| 3 | WR_ECC_ERR_SYS | WOS | Value = 0x0 Enabled set for write ECC error interrupt. Writing a 1 will enable the write ECC error interrupt, set this bit as well as the bit in Interrupt Enable Clear Register. Writing a 0 has no effect. |
| 2-1 | Reserved | R | Value = 0x0 Reserved. |
| 0 | ERR_SYS | WOS | Value = 0x0 Enable set for system VBUSM interrupt for command or address error. Writing a 1 will enable the interrupt, and set this bit as well as the corresponding Interrupt Enable Clear Register. Writing a 0 has no effect. |

4.18 Interrupt Enable Clear Register (IRQSTATUS_CLR_SYS)

The IRQSTATUS_CLR_SYS register is described in the following figure and table.

Figure 4-18. Interrupt Enable Clear Register (IRQSTATUS_CLR_SYS)

| | | | | | | |
|----------|---|----------------|----------------|----------|---|---------|
| 31 | 5 | 4 | 3 | 2 | 1 | 0 |
| Reserved | | RD_ECC_ERR_SYS | WR_ECC_ERR_SYS | Reserved | | ERR_SYS |
| R | | WOC=0x0 | WOC=0x0 | R | | WOC=0x0 |

Legend: R = Read only; WOC = Write one to clear; - n = value after reset; -x, value is indeterminate — see the device-specific data manual

Table 4-20. Interrupt Enable Clear Register (IRQSTATUS_CLR_SYS) Field Descriptions

| Bit | Field | Attribute | Description |
|------|----------------|-----------|--|
| 31-5 | Reserved | R | Value = 0x0 Reserved. |
| 4 | RD_ECC_ERR_SYS | WOC | Value = 0x0 Enabled clear for read ECC error interrupt. Writing a 1 will disable the read ECC error interrupt, clear this bit as well as the bit in Interrupt Enable Clear Register. Writing a 0 has no effect. |
| 3 | WR_ECC_ERR_SYS | WOC | Value = 0x0 Enabled clear for write ECC error interrupt. Writing a 1 will disable the write ECC error interrupt, clear this bit as well as the bit in Interrupt Enable Clear Register. Writing a 0 has no effect. |
| 2-1 | Reserved | R | Value = 0x0 Reserved. |
| 0 | ERR_SYS | WOC | Value = 0x0 Enable clear for system VBUSM interrupt for command or address error. Writing a 1 will disable the interrupt, and clear this bit as well as the corresponding Interrupt Enable Set Register. Writing a 0 has no effect. |

4.19 SDRAM Output Impedance Calibration Configuration Register (ZQCFG)

The ZQCFG register is described in the following figure and table.

Figure 4-19. SDRAM Output Impedance Calibration Configuration Register (ZQCFG)

| | | | |
|----------|----------------|--------------|----------------|
| 31 | 30 | 29 | 28 |
| ZQ_CS1EN | ZQ_CS0EN | ZQ_DUALCALEN | ZQ_SFEXITEN |
| RW=0x1 | RW=0x1 | RW=0x0 | RW=0x1 |
| 27 | 20 | 19 | 18 |
| Reserved | ZQ_ZQINIT_MULT | ZQ_ZQCL_MULT | ZQ_REFINTERVAL |
| R | RW=0x1 | RW=0x3 | RW=0x4C1F |

Legend: R = Read only; W = Write only; - n = value after reset; -x, value is indeterminate — see the device-specific data manual

Table 4-21. SDRAM Output Impedance Calibration Configuration Register (ZQCFG) Field Descriptions

| Bit | Field | Attribute | Description |
|--------|----------------|-----------|--|
| 31 | ZQ_CS1EN | RW | ZQ calibration for CS1 <ul style="list-style-type: none"> 0 = Disable ZQ calibration for CS1 1 = Enable ZQ calibration for CS1 |
| 30 | ZQ_CS0EN | RW | ZQ calibration for CS0 <ul style="list-style-type: none"> 0 = Disable ZQ calibration for CS0 1 = Enable ZQ calibration for CS0 |
| 29 | ZQ_DUALCALEN | RW | ZQ Dual Calibration enable. Allows both ranks to be calibrated simultaneously. <ul style="list-style-type: none"> 0 = Dual ZQ calibration disable 1 = Both chip selects have a separate calibration resistor per device. This bit should always be set to 1. See the Silicon Errata for your device for more details on this issue. |
| 28 | ZQ_SFEXITEN | RW | ZQCL on Self-refresh, Active power-down and precharge power-down exit enable. <ul style="list-style-type: none"> 0 = Disable ZQCL on Self-refresh, Active power-down and precharge power-down exit enable 1 = Enable ZQCL on Self-refresh, Active power-down and precharge power-down exit enable. Set this value to 1 to issue a ZQCL command upon self-refresh exit. |
| 27- 20 | Reserved | R | Value = 0 Reserved. The reserved bit location is always read as 0. A value written to this field has no effect. |
| 19-18 | ZQ_ZQINIT_MULT | RW | Number of ZQCL intervals that make up a ZQINIT interval, minus one. The value of this parameter can be derived from the t_{ZQinit} and t_{ZQoper} AC timing parameters in the DDR3 memory data sheet. Calculate using the formula $T_{ZQ_ZQINIT_MULT} = (t_{ZQinit}/t_{ZQoper} - 1)$ |
| 17 -16 | ZQ_ZQCL_MULT | RW | Number of ZQCS intervals that make up a ZQCL interval, minus one. ZQCS interval is defined by ZQ_ZQCS field in SDRAM Timing 3 (SDTIM3) register. The value of this parameter can be derived using the formula: $T_{ZQ_ZQCL_MULT} = (t_{ZQoper}/t_{ZQCS} - 1)$ |

Table 4-21. SDRAM Output Impedance Calibration Configuration Register (ZQCFG) Field Descriptions (continued)

| Bit | Field | Attribute | Description |
|------|----------------|-----------|--|
| 15-0 | ZQ_REFINTERVAL | RW | <p>Number of refresh periods between ZQCS commands, minus one. This field supports between one refresh period to 256 ms between ZQCS calibration commands. Refresh period is defined by REFRESH_RATE field in SDRAM Refresh control (SDRFC) register.</p> <p>ZQ_REFINTERVAL = number of refresh periods between ZQCS commands.</p> <p>The interval is calculated as $= 0.5\% / [(Tsens \times Tdriftrate) + (Vsens \times Vdriftrate)]$.</p> <p>Tsens = max (dRTTdT, dRONdTM) from the memory device datasheet.</p> <p>Vsens = max(dRTTdV, dRONdVM) from the memory device datasheet</p> <p>Tdriftrate = drift rate in °C/second. This is the temperature drift rate that the SDRAM is subject to in the application. Vdriftrate = drift rate in mV/second. This is the voltage drift rate that the SDRAM is subject to in the application.</p> <p>Example:</p> <p>If Tsens= 1.5%/°C, Vsens = 0.15%/mV, Tdriftrate = 1.2 °C/second and Vdriftrate = 10mV/second,</p> <p>Interval = $0.5 / [(1.5 \times 1.2) + (0.15 \times 10)] = 152\text{ms}$.</p> <p>Since refresh interval = 7.8µs, ZQ_REFINTERVAL = $152\text{ms} / 7.8\mu\text{s} = 0x4C1F$</p> |

4.20 Read-Write Leveling Ramp Window Register (RDWR_LVL_RMP_WIN)

The RDWR_LVL_RMP_WIN register is described in the figure and table below.

Figure 4-20. Read-Write Leveling Ramp Window Register (RDWR_LVL_RMP_WIN)

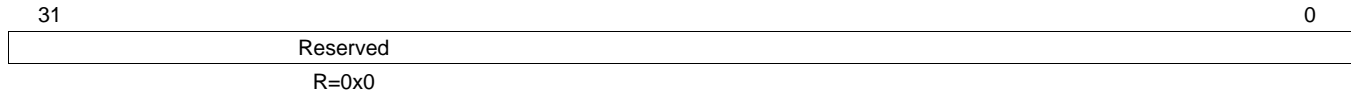

Legend: R = Read only; W = Write only; - n = value after reset; -x, value is indeterminate — see the device-specific data manual

Table 4-22. Read-Write Leveling Ramp Window Register (RDWR_LVL_RMP_WIN) Field Descriptions

| Bit | Field | Attribute | Description |
|------|----------|-----------|--|
| 31-0 | Reserved | R | Value = 0x0. This register is reserved, as ramp incremental leveling is not supported on Keystone-I devices. |

4.21 Read-Write Leveling Ramp Control Register (RDWR_LVL_RMP_CTRL)

The RDWR_LVL_RMP_CTRL register is described in the figure and table below.

Figure 4-21. Read-Write Leveling Ramp Control Register (RDWR_LVL_RMP_CTRL)

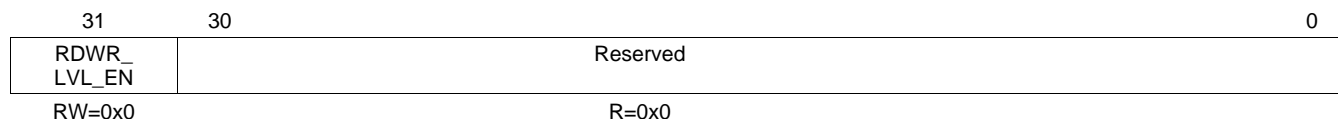

Legend: R = Read only; W = Write only; - n = value after reset; -x, value is indeterminate — see the device-specific data manual

Table 4-23. Read-Write Leveling Ramp Control Register (RDWR_LVL_RMP_CTRL) Field Descriptions

| Bit | Field | Attribute | Description |
|------|-------------|-----------|---|
| 31 | RDWR_LVL_EN | RW | Value = 0x0 Global Read-Write leveling enable. <ul style="list-style-type: none"> • 0 Disable leveling (full and incremental) • 1 Enable leveling (full and incremental) |
| 30-0 | Reserved | R | Value = 0x0 These bits are reserved, as ramp incremental leveling is not supported on Keystone-I devices. |

4.22 Read-Write Leveling Control Register (RDWR_LVL_CTRL)

The RDWR_LVL_CTRL register is described in the figure and table below.

Figure 4-22. Read-Write Leveling Control Register (RDWR_LVL_CTRL)

| | | | | | | | | |
|-------------------|----------------|--------------|------------------|----|----|--------------|---|---|
| 31 | 30 | 24 | 23 | 16 | 15 | 8 | 7 | 0 |
| RDWRLVLFULL_START | RDWRLVLINC_PRE | RDLVLINC_INT | RDLVLGATEINC_INT | | | WRLVLINC_INT | | |
| RW=0x0 | RW=0x0 | RW=0x0 | RW=0x0 | | | RW=0x0 | | |

Legend: R = Read only; W = Write only; - n = value after reset; -x, value is indeterminate — see the device-specific data manual

Table 4-24. Read-Write Leveling Control Register (RDWR_LVL_CTRL) Field Descriptions

| Bit | Field | Description |
|-------|-------------------|---|
| 31 | RDWRLVLFULL_START | Value = 0x0 Full leveling trigger. <ul style="list-style-type: none"> • 0 No effect • 1 Trigger full leveling. This bit will self-clear to zero. |
| 30-24 | RDWRLVLINC_PRE | Value = 0x0 Incremental leveling pre-scalar in number of refresh periods. Value programmed is minus one the required value. Refresh period is defined by REFRESH_RATE in SDRFC register. |
| 23-16 | RDLVLINC_INT | Value = 0x0 Incremental read data eye training interval. Number of RDWRLVLINC_PRE intervals between incremental read data eye training. A value of zero will disable incremental read data eye training. |
| 15-8 | RDLVLGATEINC_INT | Value = 0x0 Incremental read DQS gate training interval. Number of RDWRLVLINC_PRE intervals between incremental read DQS gate training. A value of zero will disable incremental read DQS gate training. |
| 7-0 | WRLVLINC_INT | Value = 0x0 Incremental write leveling interval. Number of RDWRLVLINC_PRE intervals between incremental write leveling. A value of zero will disable incremental write leveling. |

4.23 DDR PHY Control 1 Register (DDR_PHY_CTRL_1)

The DDR_PHY_CTRL_1 register is described in the following figure and table.

Figure 4-23. DDR PHY Control 1 Register (DDR_PHY_CTRL_1)

| | | | | | | | | | |
|----------------|--------------|--------------|----------|----------|----------|----------|----------|--------------|----------|
| 31 | 21 | 20 | 19 | 16 | 15 | 14 | | | |
| Reserved | EN_DYN_PWRDN | Reserved | PHY_RST | Reserved | Reserved | Reserved | | | |
| R=0x0 | RW=0x1 | R=0x0 | RW=0x0 | R=0x0 | RW=0x0 | R=0x0 | | | |
| 13 | 12 | 11 | 10 | 9 | 8 | 7 | 5 | 4 | 0 |
| IDLE_LOCAL_ODT | WR_LOCAL_ODT | RD_LOCAL_ODT | Reserved | Reserved | Reserved | Reserved | Reserved | READ_LATENCY | Reserved |
| RW=0x0 | RW=0x0 | RW=0x1 | R=0x0 | R=0x0 | R=0x0 | R=0x0 | R=0x0 | RW=0xA | R=0x0 |

Legend: R = Read only; W = Write only; - n = value after reset; -x, value is indeterminate — see the device-specific data manual

Table 4-25. DDR PHY Control 1 Register (DDR_PHY_CTRL_1) Field Descriptions

| Bit | Field | Attribute | Description |
|-------|----------------|-----------|--|
| 31-21 | Reserved | R | Value = 0x0 Reserved. |
| 20 | EN_DYN_PWRDN | RW | Value = 0x1 <ul style="list-style-type: none"> Enables dynamically powering down the IO Receiver when not performing a read <ul style="list-style-type: none"> 1 : IO Receiver for DQ, DQS always powered up 0 : IO Receiver for DQ, DQS powered up during a read |
| 19-16 | Reserved | R | Value = 0x0 Reserved |
| 15 | PHY_RST | RW | Controls DDR3 PHY reset <ul style="list-style-type: none"> 0: Writing a 0 brings the DDR3 PHY out of reset 1: Writing a 1 will hold the DDR3 PHY in reset |
| 14 | Reserved | R | Value = 0x0 Reserved |
| 13-12 | IDLE_LOCAL_ODT | RW | Value = 0x0 Program controller termination during idle cycles. |
| 11-10 | WR_LOCAL_ODT | RW | Value = 0x0 Program controller termination during write access. |
| 9-8 | RD_LOCAL_ODT | RW | Value = 0x1 Program controller termination during read access. |
| 7-5 | Reserved | RW | Value = 0x0 Reserved |
| 4-0 | READ_LATENCY | RW | Value = 0xA This field defines the read latency from DDR SDRAM in terms of DDR3 clock cycles. The value depends on the CAS latency used. The user can choose any value between max and min values given below. The programmed value should always be programmed as the chosen value minus one. <ul style="list-style-type: none"> Maximum value possible = CAS latency + 7 Minimum value possible = CAS Latency + 1 |

4.24 Priority to Class-Of-Service Mapping Register (PRI_COS_MAP)

The PRI_COS_MAP register is described in the following figure and table.

Figure 4-24. Priority to Class-Of-Service Mapping Register (PRI_COS_MAP)

| | | | | | | | | | |
|----------------|----------|-----------|-----------|-----------|-----------|-----------|-----------|-----------|---|
| 31 | 30 | 16 | 15 | 14 | 13 | 12 | 11 | 10 | |
| PRI_COS_MAP_EN | Reserved | | PRI_7_COS | | PRI_6_COS | | PRI_5_COS | | |
| RW=0x0 | R=0x0 | | RW=0x0 | | RW=0x0 | | RW=0x0 | | |
| 9 | 8 | 7 | 6 | 5 | 4 | 3 | 2 | 1 | 0 |
| PRI_4_COS | | PRI_3_COS | | PRI_2_COS | | PRI_1_COS | | PRI_0_COS | |
| RW=0x0 | | RW=0x0 | | RW=0x0 | | RW=0x0 | | RW=0x0 | |

Legend: R = Read only; W = Write only; - n = value after reset; -x, value is indeterminate — see the device-specific data manual

Table 4-26. Priority to Class-Of-Service Mapping Register (PRICOSMAP) Field Descriptions

| Bit | Field | Description |
|-------|----------------|---|
| 31 | PRI_COS_MAP_EN | Value = 0x0 Priority to Class-of-service mapping <ul style="list-style-type: none"> 0 = Disable Priority to Class-of-service mapping 1 = Enable Priority to Class-of-service mapping |
| 30-16 | Reserved | Value = 0 Reserved. The reserved bit location is always read as 0. A value written to this field has no effect. |
| 15-14 | PRI_7_COS | Class-of-service for commands with priority of 7 (lowest priority). <ul style="list-style-type: none"> 1 = Map to Class-of-service 1 2 = Map to Class-of-service 2 0 or 3 will not assign any class of service. |
| 13-12 | PRI_6_COS | Class-of-service for commands with priority of 6. <ul style="list-style-type: none"> 1 = Map to Class-of-service 1 2 = Map to Class-of-service 2 0 or 3 will not assign any class of service. |
| 11-10 | PRI_5_COS | Class-of-service for commands with priority of 5. <ul style="list-style-type: none"> 1 = Map to Class-of-service 1 2 = Map to Class-of-service 2 0 or 3 will not assign any class of service. |
| 9-8 | PRI_4_COS | Class-of-service for commands with priority of 4. <ul style="list-style-type: none"> 1 = Map to Class-of-service 1 2 = Map to Class-of-service 2 0 or 3 will not assign any class of service. |
| 7-6 | PRI_3_COS | Class-of-service for commands with priority of 3. <ul style="list-style-type: none"> 1 = Map to Class-of-service 1 2 = Map to Class-of-service 2 0 or 3 will not assign any class of service. |
| 5-4 | PRI_2_COS | Class-of-service for commands with priority of 2. <ul style="list-style-type: none"> 1 = Map to Class-of-service 1 2 = Map to Class-of-service 2 0 or 3 will not assign any class of service. |
| 3-2 | PRI_1_COS | Class-of-service for commands with priority of 1. <ul style="list-style-type: none"> 1 = Map to Class-of-service 1 2 = Map to Class-of-service 2 0 or 3 will not assign any class of service. |
| 1-0 | PRI_0_COS | Class-of-service for commands with priority of 0 (highest priority). <ul style="list-style-type: none"> 1 = Map to Class-of-service 1 2 = Map to Class-of-service 2 0 or 3 will not assign any class of service. |

4.25 Master ID to Class-Of-Service 1 Mapping Register (MSTID_COS_1_MAP)

The MSTID_COS_1_MAP register is described in the following figure and table.

Figure 4-25. Master ID to Class-Of-Service 1 Mapping Register (MSTID_COS_1_MAP)

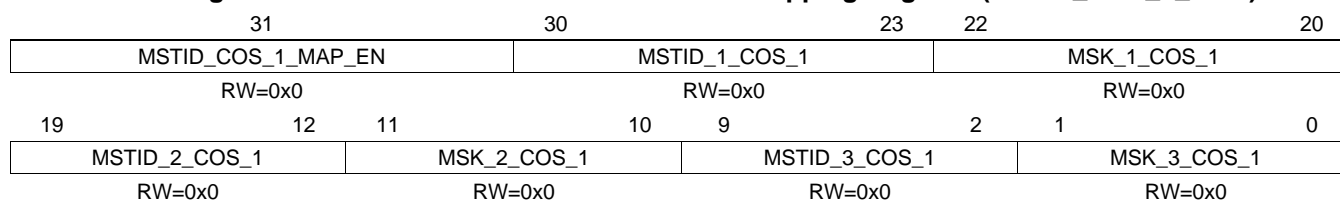

Legend: R = Read only; W = Write only; - n = value after reset; -x, value is indeterminate — see the device-specific data manual

Table 4-27. Master ID to Class-Of-Service Mapping 1 Register (MSTID_COS_1_MAP) Field Descriptions

| Bit | Field | Description |
|-------|--------------------|--|
| 31 | MSTID_COS_1_MAP_EN | Master ID to Class-of-service 1 mapping. <ul style="list-style-type: none"> • 0 = Disable Master ID to Class-of-service 1 mapping • 1 = Enable Master ID to Class-of-service 1 mapping |
| 30-23 | MSTID_1_COS_1 | Value = 0x0 Master ID value 1 for Class-of-service 1. |
| 22-20 | MSK_1_COS_1 | Mask for master ID value 1 for Class-of-service 1. <ul style="list-style-type: none"> • 0 = Disable masking • 1 = Mask master ID bit 0 • 2 = Mask master ID bits 1-0 • 3 = Mask master ID bits 2-0 |
| 19-12 | MSTID_2_COS_1 | Value = 0x0 Master ID value 2 for Class-of-service 1. |
| 11-10 | MSK_2_COS_1 | Mask for master ID value 2 for Class-of-service 1. <ul style="list-style-type: none"> • 0 = Disable masking • 1 = Mask master ID bit 0 • 2 = Mask master ID bits 1-0 • 3 = Mask master ID bits 2-0 |
| 9-2 | MSTID_3_COS_1 | Value = 0x0 Master ID value 3 for Class-of-service 1. |
| 1-0 | MSK_3_COS_1 | Mask for master ID value 3 for Class-of-service 1. <ul style="list-style-type: none"> • 0 = Disable masking • 1 = Mask master ID bit 0 • 2 = Mask master ID bits 1-0 • 3 = Mask master ID bits 2-0 |

4.26 Master ID to Class-Of-Service 2 Mapping Register (MSTID_COS_2_MAP)

The MSTID_COS_2_MAP register is described in the following figure and table.

Figure 4-26. Master ID to Class-Of-Service 2 Mapping Register (MSTID_COS_2_MAP)

| | | | | | | | | | | | | |
|--------------------|---------------|-------------|---------------|-------------|---------------|-------------|----|----|---|---|---|---|
| 31 | 30 | 23 | 22 | 20 | 19 | 12 | 11 | 10 | 9 | 2 | 1 | 0 |
| MSTID_COS_2_MAP_EN | MSTID_1_COS_2 | MSK_1_COS_2 | MSTID_2_COS_2 | MSK_2_COS_2 | MSTID_3_COS_2 | MSK_3_COS_2 | | | | | | |
| RW=0x0 | RW=0x0 | RW=0x0 | RW=0x0 | RW=0x0 | RW=0x0 | RW=0x0 | | | | | | |

Legend: R = Read only; W = Write only; - n = value after reset; -x, value is indeterminate — see the device-specific data manual

Table 4-28. Master ID to Class-Of-Service Mapping 2 Register (MSTID_COS_2_MAP) Field Descriptions

| Bit | Field | Description |
|-------|--------------------|--|
| 31 | MSTID_COS_2_MAP_EN | Master ID to Class-of-service 2 mapping. <ul style="list-style-type: none"> 0 = Disable Master ID to Class-of-service 2 mapping 1 = Enable Master ID to Class-of-service 2 mapping |
| 30-23 | MSTID_1_COS_2 | Value = 0x0 Master ID value 1 for Class-of-service 2. |
| 22-20 | MSK_1_COS_2 | Mask for master ID value 1 for Class-of-service 2. <ul style="list-style-type: none"> 0 = Disable masking 1 = Mask master ID bit 0 2 = Mask master ID bits 1-0 3 = Mask master ID bits 2-0 |
| 19-12 | MSTID_2_COS_2 | Value = 0x0 Master ID value 2 for Class-of-service 2. |
| 11-10 | MSK_2_COS_2 | Mask for master ID value 2 for Class-of-service 2. <ul style="list-style-type: none"> 0 = Disable masking 1 = Mask master ID bit 0 2 = Mask master ID bits 1-0 3 = Mask master ID bits 2-0 |
| 9-2 | MSTID_3_COS_2 | Value = 0x0 Master ID value 3 for Class-of-service 2. |
| 1-0 | MSK_3_COS_2 | Mask for master ID value 3 for Class-of-service 2. <ul style="list-style-type: none"> 0 - Disable masking 1 = Mask master ID bit 0 2 = Mask master ID bits 1-0 3 = Mask master ID bits 2-0 |

4.27 ECC Control Register (ECCCTL)

The ECCCTL register is described in the following figure and table.

Figure 4-27. ECC Control Register (ECCCTL)

| | | | | | |
|--------|-------------------|----------|-------------------|-------------------|---|
| 31 | 30 | 29 | 2 | 1 | 0 |
| ECC_EN | ECC_ADDR_RNG_PROT | Reserved | ECC_ADDR_RNG_2_EN | ECC_ADDR_RNG_1_EN | |
| RW=0x0 | RW=0x0 | R=0x0 | RW=0x0 | RW=0x0 | |

Legend: R = Read only; W = Write only; - n = value after reset; -x, value is indeterminate — see the device-specific data manual

Table 4-29. ECC Control Register (ECCCTL) Field Descriptions

| Bit | Field | Description |
|------|-------------------|---|
| 31 | ECC_EN | ECC enable. Enabling ECC will cause the DDR3 controller to start the SDRAM initialization sequence. <ul style="list-style-type: none"> 0 = Disable ECC 1 = Enable ECC |
| 30 | ECC_ADDR_RNG_PROT | This bit is used to determine whether ECC calculation is allowed within address ranges described by ECC Address Range 1 and 2 Registers, provided ECC_EN is set to enable ECC. <ul style="list-style-type: none"> 0 = Disable ECC calculation within address ranges defined in ECC Address Range 1 and 2 registers and enable calculation for accesses outside of these address ranges 1 = Enable ECC calculation within address ranges defined in ECC Address Range 1 and 2 registers and disable calculation for accesses outside of these address ranges |
| 29-2 | Reserved | Reserved. The reserved bit location is always read as 0. A value written to this field has no effect. |
| 1 | ECC_ADDR_RNG_2_EN | ECC Address Range 2 enable. <ul style="list-style-type: none"> 0 = Disable ECC Address Range 2 1 = Enable ECC Address Range 2 |
| 0 | ECC_ADDR_RNG_1_EN | ECC Address Range 1 enable. <ul style="list-style-type: none"> 0 = Disable ECC Address Range 1 1 = Enable ECC Address Range 1 |

4.28 ECC Address Range 1 Register (ECCADDR1)

The ECCADDR1 register is described in the following figure and table.

Figure 4-28. ECC Address Range 1 Register (ECCADDR1)

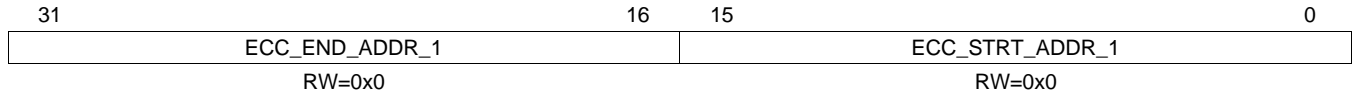

Legend: R = Read only; W = Write only; - n = value after reset; -x, value is indeterminate — see the device-specific data manual

Table 4-30. ECC Address Range 1 Register Field Descriptions

| Bit | Field | Description |
|-------|-----------------|---|
| 31-16 | ECC_END_ADDR_1 | End address [32-17] of 33-bit address for ECC address range 1 |
| 15-0 | ECC_STRT_ADDR_1 | Start address [32-17] of 33-bit address for ECC address range 1 |

NOTE: The range is inclusive of start and end addresses.

4.29 ECC Address Range 2 Register (ECCADDR2)

The ECCADDR2 register is described in the following figure and table.

Figure 4-29. ECC Address Range 2 Register (ECCADDR2)

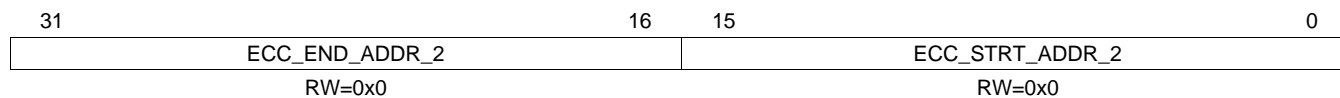

Legend: R = Read only; W = Write only; - n = value after reset; -x, value is indeterminate — see the device-specific data manual

Table 4-31. ECC Address Range 2 Register Field Descriptions

| Bit | Field | Description |
|-------|-----------------|---|
| 31-16 | ECC_END_ADDR_2 | End address [32-17] of 33-bit address for ECC address range 2 |
| 15-0 | ECC_STRT_ADDR_2 | Start address [32-17] of 33-bit address for ECC address range 2 |

NOTE: The range is inclusive of start and end addresses.

4.30 Read Write Execution Threshold Register (RWTHRESH)

The RWTHRESH register is described in the following figure and table.

Figure 4-30. Read Write Execution Threshold Register (RWTHRESH)

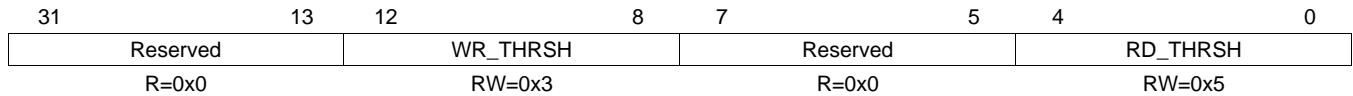

Legend: R = Read only; W = Write only; - n = value after reset; -x, value is indeterminate — see the device-specific data manual

Table 4-32. Read Write Execution Threshold Register (RWTHRESH) Field Descriptions

| Bit | Field | Description |
|-------|----------|---|
| 31-13 | Reserved | Value = 0x0 Reserved. The reserved bit location is always read as 0. A value written to this field has no effect. |
| 12-8 | WR_THRSH | Write Threshold. Number of SDRAM write bursts after which the arbitration will switch to executing read commands. The value programmed is always minus 1 the required number. |
| 7-5 | Reserved | Value = 0x0 Reserved. The reserved bit location is always read as 0. A value written to this field has no effect. |
| 4-0 | RD_THRSH | Read Threshold. Number of SDRAM read bursts after which the arbitration will switch to executing write commands. The value programmed is always minus 1 the required number. |

4.31 DDR3 Configuration 0 Register (DDR3_CONFIG_0)

The DDR3_CONFIG_0 register is described in the following figure and table.

Figure 4-31. DDR3 Configuration 0 Register (DDR3_CONFIG_0)

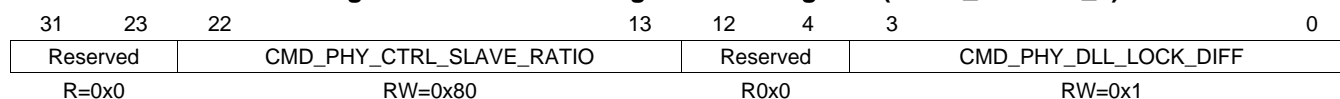

Legend: R = Read only; W = Write only; - n = value after reset; -x, value is indeterminate — see the device-specific data manual

Table 4-33. DDR3_CONFIG_0 Register (0x02620404) Field Descriptions

| Bits | Name | Description |
|-------|--------------------------|---|
| 31-23 | Reserved | Reset = 0x0010000 Reserved. Do not write to this field. |
| 22-13 | CMD_PHY_CTRL_SLAVE_RATIO | Reset = 0x80 Program this to 0x100 if CMD_PHY_INVERT_CLKOUT in DDR3_CONFIG_12 is set to 1. |
| 12-4 | Reserved | Reset = 0x000 |
| 3-0 | CMD_PHY_DLL_LOCK_DIFF | Reset = 0x1 Decides when DLL inside the DDR3 controller goes out of lock in case of jitter on the clock. Recommend program to 0xF. |

4.32 DDR3 Configuration 1 Register (DDR3_CONFIG_1)

The DDR3_CONFIG_1 register is described in the following figure and table. This register is used to program the appropriate DQ-to-DQS timing relationship during writes for C665x devices and TCI6612/13/14. Do not program this register for any other device. Refer to the Keystone-I DDR3 Initialization app note for the proper programming sequence.

Figure 4-32. DDR3 Configuration 1 Register (DDR3_CONFIG_1)

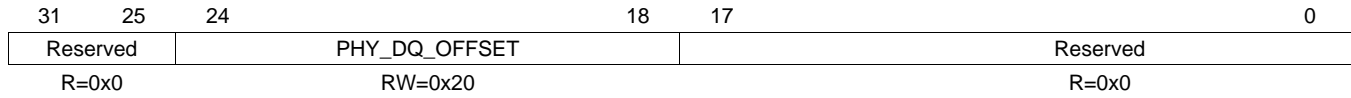

Legend: R = Read only; W = Write only; - n = value after reset; -x, value is indeterminate — see the device-specific data manual

Table 4-34. DDR3_CONFIG_1 Register (0x02620408) Field Descriptions

| Bits | Name | Description |
|-------|---------------|--|
| 31-25 | Reserved | Reset = 0x0010000 Reserved. Do not write to this field. |
| 24-18 | PHY_DQ_OFFSET | Reset = 0x20 for C665x/TCI6612/13/14 Reset = 0x40 for other devices This field should be programmed to 0x40 for C665x and TCI6612/13/14 devices only, to set the proper DQ-DQS timing relationship for writes, and left unchanged for other devices because the default value already centers the DQ with the DQS. 0x40 is the only valid value. Other values are not supported. |
| 17-0 | Reserved | Reset = 0x000 Reserved |

4.33 DDR3 Configuration 2 Register (DDR3_CONFIG_2)

The DDR3_CONFIG_2 register is described in the following figure and table.

Figure 4-33. DDR3 Configuration 2 Register (DDR3_CONFIG_2)

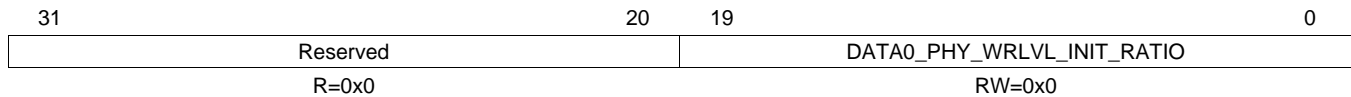

Legend: R = Read only; W = Write only; - n = value after reset; -x, value is indeterminate — see the device-specific data manual

Table 4-35. DDR3_CONFIG_2 Register (0x0262040C) Field Descriptions

| Bits | Name | Description |
|-------|----------------------------|---|
| 31-20 | Reserved | Reset = 0x0 Reserved. |
| 19-0 | DATA0_PHY_WRLVL_INIT_RATIO | Reset = 0x0 Plug in the reg_phy_wrlvl_init_ratio value for Byte lane 3 for C665x devices or Byte lane 7 for all other devices from the PHY calculation spreadsheet |

4.34 DDR3 Configuration 3 Register (DDR3_CONFIG_3)

The DDR3_CONFIG_3 register is described in the following figure and table.

Figure 4-34. DDR3 Configuration 3 Register (DDR3_CONFIG_3)

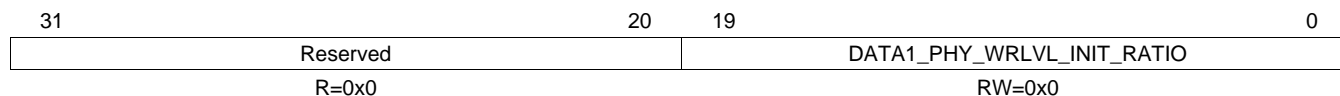

Legend: R = Read only; W = Write only; - n = value after reset; -x, value is indeterminate — see the device-specific data manual

Table 4-36. DDR3_CONFIG_3 Register (0x02620410) Field Descriptions

| Bits | Name | Description |
|-------|----------------------------|--|
| 31-20 | Reserved | Reset = 0x0 Reserved. |
| 19-0 | DATA1_PHY_WRLVL_INIT_RATIO | Reset = 0x0 Plug in the reg_phy_wrlvl_init_ratio value for Byte lane 2 for C665x devices or Byte lane 6 for all other devices from the PHY calculation spreadsheet. |

4.35 DDR3 Configuration 4 Register (DDR3_CONFIG_4)

The DDR3_CONFIG_4 register is described in the following figure and table.

Figure 4-35. DDR3 Configuration 4 Register (DDR3_CONFIG_4)

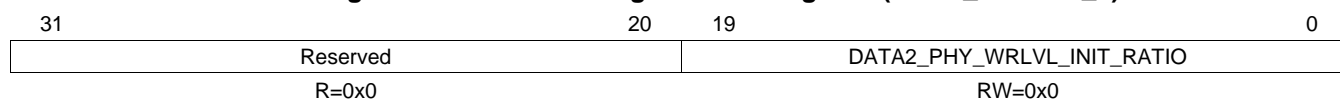

Legend: R = Read only; W = Write only; - n = value after reset; -x, value is indeterminate — see the device-specific data manual

Table 4-37. DDR3_CONFIG_4 Register (0x02620414) Field Descriptions

| Bits | Name | Description |
|-------|----------------------------|--|
| 31-20 | Reserved | Reset = 0x0 Reserved. |
| 19-0 | DATA2_PHY_WRLVL_INIT_RATIO | Reset = 0x0 Plug in the reg_phy_wrlvl_init_ratio value for Byte lane 1 for C665x devices or Byte lane 5 for all other devices from the PHY calculation spreadsheet. |

4.36 DDR3 Configuration 5 Register (DDR3_CONFIG_5)

DDR3 Configuration Register 5 is used for full leveling, and is described in the following figure and table.

Figure 4-36. DDR3 Configuration 5 Register (DDR3_CONFIG_5)

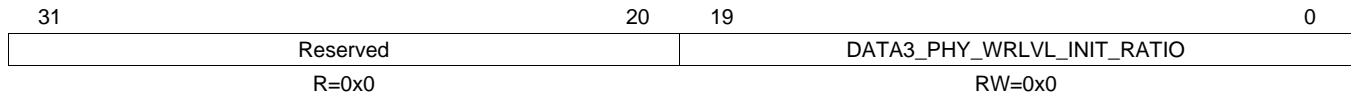

Legend: R = Read only; W = Write only; - n = value after reset; -x, value is indeterminate — see the device-specific data manual

Table 4-38. DDR3_CONFIG_5 Register (0x02620418) Field Descriptions

| Bits | Name | Description |
|-------|----------------------------|--|
| 31-20 | Reserved | Reset = 0x0 Reserved. |
| 19-0 | DATA3_PHY_WRLVL_INIT_RATIO | Reset = 0x0 Plug in the reg_phy_wrlvl_init_ratio value for Byte lane 0 for C665x devices or Byte lane 4 for all other devices from the PHY calculation spreadsheet. |

4.37 DDR3 Configuration 6 Register (DDR3_CONFIG_6)

DDR3 Configuration Register 6 is used for full leveling, and is described in the following figure and table.

Figure 4-37. DDR3 Configuration 6 Register (DDR3_CONFIG_6)

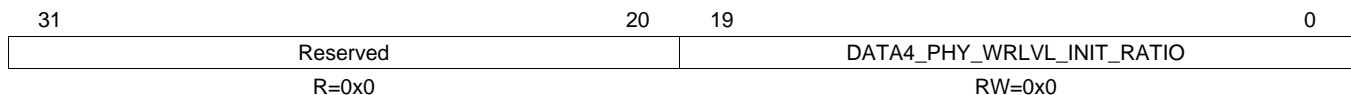

Legend: R = Read only; W = Write only; - n = value after reset; -x, value is indeterminate — see the device-specific data manual

Table 4-39. DDR3_CONFIG_6 Register (0x0262041C) Field Descriptions

| Bits | Name | Description |
|-------|----------------------------|--|
| 31-20 | Reserved | Reset = 0x0 Reserved. |
| 19-0 | DATA4_PHY_WRLVL_INIT_RATIO | Reset = 0x0 Plug in the reg_phy_wrlvl_init_ratio value for Byte lane 3 from the PHY calculation spreadsheet (NA for C665x devices). |

4.38 DDR3 Configuration 7 Register (DDR3_CONFIG_7)

DDR3 Configuration Register 7 is used for full leveling, and is described in the following figure and table.

Figure 4-38. DDR3 Configuration 7 Register (DDR3_CONFIG_7)

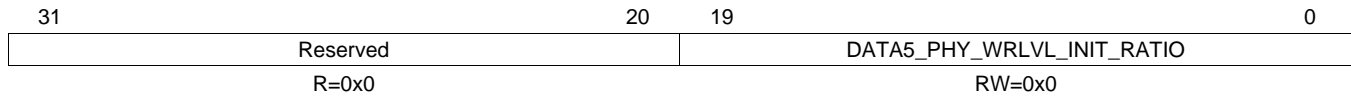

Legend: R = Read only; W = Write only; - n = value after reset; -x, value is indeterminate — see the device-specific data manual

Table 4-40. DDR3_CONFIG_7 Register (0x02620420) Field Descriptions

| Bits | Name | Description |
|-------|----------------------------|--|
| 31-20 | Reserved | Reset = 0x0 Reserved. |
| 19-0 | DATA5_PHY_WRLVL_INIT_RATIO | Reset = 0x0 Plug in the reg_phy_wrlvl_init_ratio value for Byte lane 2 from the PHY calculation spreadsheet (NA for C665x devices). |

4.39 DDR3 Configuration 8 Register (DDR3_CONFIG_8)

DDR3 Configuration Register 8 is used for full leveling, and is described in the following figure and table.

Figure 4-39. DDR3 Configuration 8 Register (DDR3_CONFIG_8)

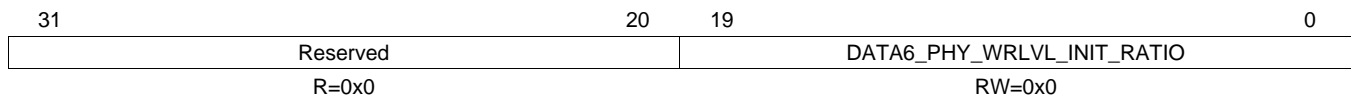

Legend: R = Read only; W = Write only; - n = value after reset; -x, value is indeterminate — see the device-specific data manual

Table 4-41. DDR3_CONFIG_8 Register (0x02620424) Field Descriptions

| Bits | Name | Description |
|-------|----------------------------|--|
| 31-20 | Reserved | Reset = 0x0 Reserved. |
| 19-0 | DATA6_PHY_WRLVL_INIT_RATIO | Reset = 0x0 Plug in the reg_phy_wrlvl_init_ratio value for Byte lane 1 from the PHY calculation spreadsheet (NA for C665x devices). |

4.40 DDR3 Configuration 9 Register (DDR3_CONFIG_9)

DDR3 Configuration Register 9 is used for full leveling, and is described in the following figure and table.

Figure 4-40. DDR3 Configuration 9 Register (DDR3_CONFIG_9)

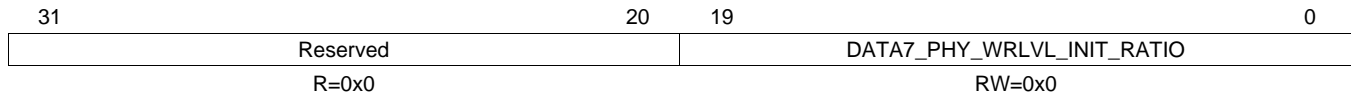

Legend: R = Read only; W = Write only; - *n* = value after reset; -x, value is indeterminate — see the device-specific data manual

Table 4-42. DDR3_CONFIG_9 Register (0x02620428) Field Descriptions

| Bits | Name | Description |
|-------|----------------------------|--|
| 31-20 | Reserved | Reset = 0x0 Reserved. |
| 19-0 | DATA7_PHY_WRLVL_INIT_RATIO | Reset = 0x0 Plug in the reg_phy_wrlvl_init_ratio value for Byte lane 0 from the PHY calculation spreadsheet (NA for C665x devices). |

4.41 DDR3 Configuration 10 Register (DDR3_CONFIG_10)

DDR3 Configuration Register 10 is used for full leveling, and is described in the following figure and table.

Figure 4-41. DDR3 Configuration 10 Register (DDR3_CONFIG_10)

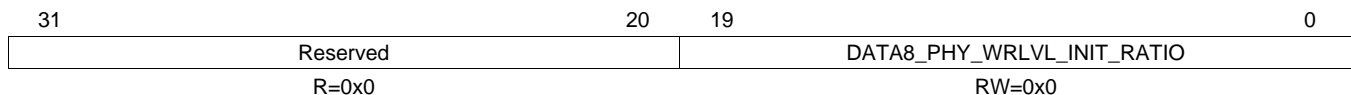

Legend: R = Read only; W = Write only; - *n* = value after reset; -x, value is indeterminate — see the device-specific data manual

Table 4-43. DDR3_CONFIG_10 Register (0x0262042C) Field Descriptions

| Bits | Name | Description |
|-------|----------------------------|--|
| 31-20 | Reserved | Reset = 0x0 Reserved. |
| 19-0 | DATA8_PHY_WRLVL_INIT_RATIO | Reset = 0x0 Plug in the reg_phy_wrlvl_init_ratio value for Byte lane 8 (ECC byte lane) from the PHY calculation spreadsheet (same for all devices). |

4.42 DDR3 Configuration 12 Register (DDR3_CONFIG_12)

DDR3 Configuration Register 12 is used if using invert clock out. See [Section 2.13.7](#) on invert clockout for routing conditions under which invert clock out should be used.

Figure 4-42. DDR3 Configuration 12 Register (DDR3_CONFIG_12)

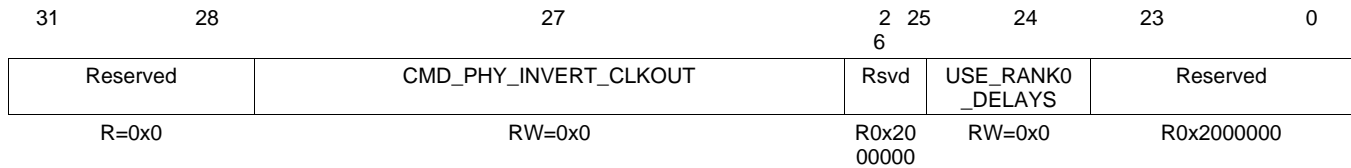

Legend: R = Read only; W = Write only; - n = value after reset; -x, value is indeterminate — see the device-specific data manual

Table 4-44. DDR3_CONFIG_12 Register (0x02620434) Field Descriptions

| Bits | Name | Description |
|-------|-----------------------|---|
| 31-28 | Reserved | Reset = 0x0 Reserved. |
| 27 | CMD_PHY_INVERT_CLKOUT | Reset = 0x0 <ul style="list-style-type: none"> • 0 - Don't use invert clock out • 1 - Use invert clockout. |
| 26-25 | Reserved | Reset = 0x2000000 Reserved. |
| 24 | USE_RANK0_DELAYS | This should be set to 1 after leveling is completed if using both chip selects for dual rank access. Note that this is part of a sequence of steps to enable dual rank support. See the DDR3 Initialization app note for details on how to sequence the initialization steps for dual rank support. |
| 23-0 | Reserved | Reset = 0x2000000 Reserved. |

4.43 DDR3 Configuration 14 Register (DDR3_CONFIG_14)

DDR3 Configuration Register 14 is used for full leveling, and is described in the following figure and table.

Figure 4-43. DDR3 Configuration 14 Register (DDR3_CONFIG_14)

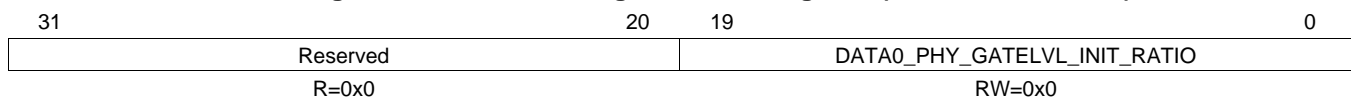

Legend: R = Read only; W = Write only; - n = value after reset; -x, value is indeterminate — see the device-specific data manual

Table 4-45. DDR3_CONFIG_14 Register (0x0262043C) Field Descriptions

| Bits | Name | Description |
|-------|------------------------------|--|
| 31-20 | Reserved | Reset = 0x0 Reserved. |
| 19-0 | DATA0_PHY_GATELVL_INIT_RATIO | Reset = 0x0 Plug in the reg_phy_gatelvl_init_ratio value for Byte lane 3 for C665x devices or Byte lane 7 for all other devices from the PHY calculation spreadsheet. |

4.44 DDR3 Configuration 15 Register (DDR3_CONFIG_15)

DDR3 Configuration Register 15 is used for full leveling, and is described in the following figure and table.

Figure 4-44. DDR3 Configuration 15 Register (DDR3_CONFIG_15)

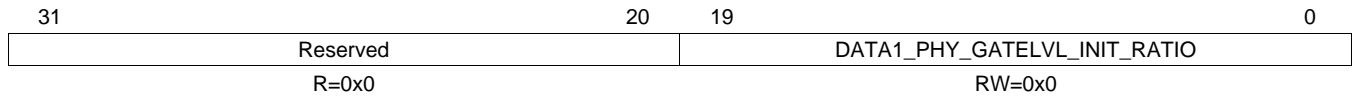

Legend: R = Read only; W = Write only; - n = value after reset; -x, value is indeterminate — see the device-specific data manual

Table 4-46. DDR3_CONFIG_15 Register (0x02620440) Field Descriptions

| Bits | Name | Description |
|-------|------------------------------|--|
| 31-20 | Reserved | Reset = 0x0 Reserved. |
| 19-0 | DATA1_PHY_GATELVL_INIT_RATIO | Reset = 0x0 Plug in the reg_phy_gatelvl_init_ratio value for Byte lane 2 for C665x devices or Byte lane 6 for all other devices from the PHY calculation spreadsheet. |

4.45 DDR3 Configuration 16 Register (DDR3_CONFIG_16)

DDR3 Configuration Register 16 is used for full leveling, and is described in the following figure and table.

Figure 4-45. DDR3 Configuration 16 Register (DDR3_CONFIG_16)

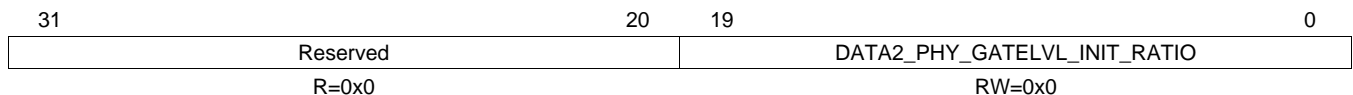

Legend: R = Read only; W = Write only; - n = value after reset; -x, value is indeterminate — see the device-specific data manual

Table 4-47. DDR3_CONFIG_16 Register (0x02620444) Field Descriptions

| Bits | Name | Description |
|-------|------------------------------|--|
| 31-20 | Reserved | Reset = 0x0 Reserved. |
| 19-0 | DATA2_PHY_GATELVL_INIT_RATIO | Reset = 0x0 Plug in the reg_phy_gatelvl_init_ratio value for Byte lane 1 for C665x devices or Byte lane 5 for all other devices from the PHY calculation spreadsheet. |

4.46 DDR3 Configuration 17 Register (DDR3_CONFIG_17)

DDR3 Configuration Register 17 is used for full leveling, and is described in the following figure and table.

Figure 4-46. DDR3 Configuration 17 Register (DDR3_CONFIG_17)

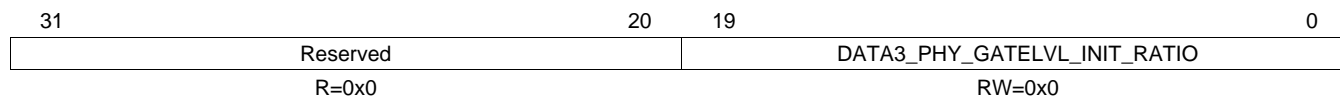

Legend: R = Read only; W = Write only; - n = value after reset; -x, value is indeterminate — see the device-specific data manual

Table 4-48. DDR3_CONFIG_17 Register (0x02620448) Field Descriptions

| Bits | Name | Description |
|-------|------------------------------|--|
| 31-20 | Reserved | Reset = 0x0 Reserved. |
| 19-0 | DATA3_PHY_GATELVL_INIT_RATIO | Reset = 0x0 Plug in the reg_phy_gatelvl_init_ratio value for Byte lane 0 for C665x devices or Byte lane 4 for all other devices from the PHY calculation spreadsheet. |

4.47 DDR3 Configuration 18 Register (DDR3_CONFIG_18)

DDR3 Configuration Register 18 is used for full leveling, and is described in the following figure and table.

Figure 4-47. DDR3 Configuration 18 Register (DDR3_CONFIG_18)

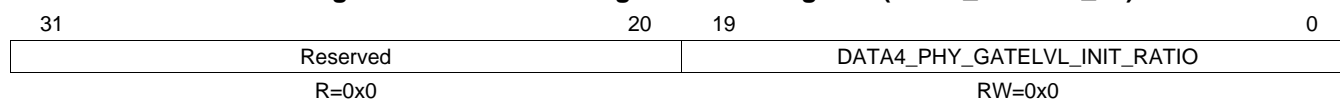

Legend: R = Read only; W = Write only; - n = value after reset; -x, value is indeterminate — see the device-specific data manual

Table 4-49. DDR3_CONFIG_18 Register (0x0262044C) Field Descriptions

| Bits | Name | Description |
|-------|------------------------------|--|
| 31-20 | Reserved | Reset = 0x0 Reserved. |
| 19-0 | DATA4_PHY_GATELVL_INIT_RATIO | Reset = 0x0 Plug in the reg_phy_gatelvl_init_ratio value for Byte lane 3 from the PHY calculation spreadsheet (NA for C665x devices). |

4.48 DDR3 Configuration 19 Register (DDR3_CONFIG_19)

DDR3 Configuration Register 19 is used for full leveling, and is described in the following figure and table.

Figure 4-48. DDR3 Configuration 19 Register (DDR3_CONFIG_19)

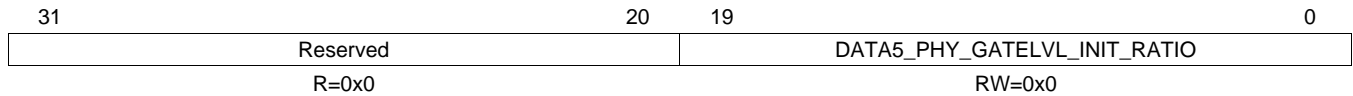

Legend: R = Read only; W = Write only; - n = value after reset; -x, value is indeterminate — see the device-specific data manual

Table 4-50. DDR3_CONFIG_19 Register (0x02620450) Field Descriptions

| Bits | Name | Description |
|-------|------------------------------|--|
| 31-20 | Reserved | Reset = 0x0 Reserved. |
| 19-0 | DATA5_PHY_GATELVL_INIT_RATIO | Reset = 0x0 Plug in the reg_phy_gatelvl_init_ratio value for Byte lane 2 from the PHY calculation spreadsheet (NA for C665x devices). |

4.49 DDR3 Configuration 20 Register (DDR3_CONFIG_20)

DDR3 Configuration Register 20 is used for full leveling, and is described in the following figure and table.

Figure 4-49. DDR3 Configuration 20 Register (DDR3_CONFIG_20)

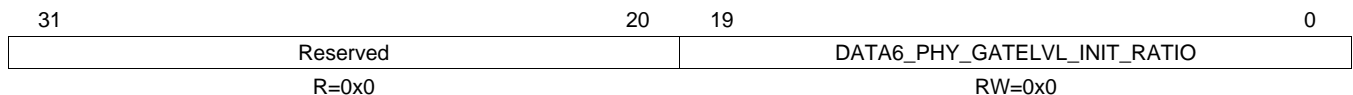

Legend: R = Read only; W = Write only; - n = value after reset; -x, value is indeterminate — see the device-specific data manual

Table 4-51. DDR3_CONFIG_20 Register (0x02620454) Field Descriptions

| Bits | Name | Description |
|-------|------------------------------|--|
| 31-20 | Reserved | Reset = 0x0 Reserved. |
| 19-0 | DATA6_PHY_GATELVL_INIT_RATIO | Reset = 0x0 Plug in the reg_phy_gatelvl_init_ratio value for Byte lane 1 from the PHY calculation spreadsheet (NA for C665x devices). |

4.50 DDR3 Configuration 21 Register (DDR3_CONFIG_21)

DDR3 Configuration Register 21 is used for full leveling, and is described in the following figure and table.

Figure 4-50. DDR3 Configuration 21 Register (DDR3_CONFIG_21)

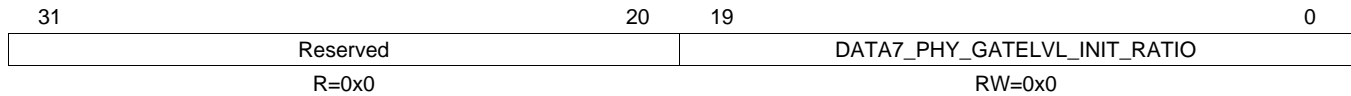

Legend: R = Read only; W = Write only; - n = value after reset; -x, value is indeterminate — see the device-specific data manual

Table 4-52. DDR3_CONFIG_21 Register (0x02620458) Field Descriptions

| Bits | Name | Description |
|-------|------------------------------|--|
| 31-20 | Reserved | Reset = 0x0 Reserved. |
| 19-0 | DATA7_PHY_GATELVL_INIT_RATIO | Reset = 0x0 Plug in the reg_phy_gatelvl_init_ratio value for Byte lane 0 from the PHY calculation spreadsheet (NA for C665x devices). |

4.51 DDR3 Configuration 22 Register (DDR3_CONFIG_22)

DDR3 Configuration Register 22 is used for full leveling, and is described in the following figure and table.

Figure 4-51. DDR3 Configuration 22 Register (DDR3_CONFIG_22)

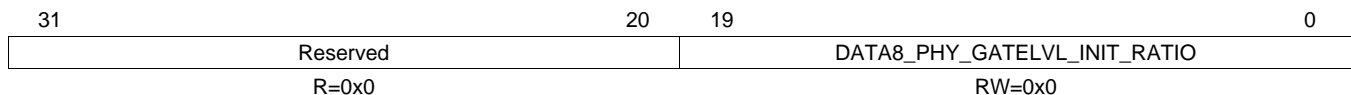

Legend: R = Read only; W = Write only; - n = value after reset; -x, value is indeterminate — see the device-specific data manual

Table 4-53. DDR3_CONFIG_22 Register (0x0262045C) Field Descriptions

| Bits | Name | Description |
|-------|------------------------------|--|
| 31-20 | Reserved | Reset = 0x0 Reserved. |
| 19-0 | DATA8_PHY_GATELVL_INIT_RATIO | Reset = 0x0 Plug in the reg_phy_gatelvl_init_ratio value for Byte lane 8 (ECC byte lane) from the PHY calculation spreadsheet (same for all devices). |

4.52 DDR3 Configuration 23 Register (DDR3_CONFIG_23)

NOTE: NA for TCI6612/13/14 and C665x devices.

DDR3 Configuration Register 23 is used for forced ratio leveling, and is described in the following figure and table.

Figure 4-52. DDR3 Configuration 23 Register (DDR3_CONFIG_23)

| | | | | | | | |
|----------|----|---------------------|----|--------------------|----|--------------------|---|
| 31 | 30 | 29 | 20 | 19 | 10 | 9 | 0 |
| Reserved | | WR_DATA_SLAVE_RATIO | | WR_DQS_SLAVE_RATIO | | RD_DQS_SLAVE_RATIO | |
| R=0x0 | | RW=0xA6 | | RW=0x66 | | RW=0x34 | |

Legend: R = Read only; W = Write only; - n = value after reset; -x, value is indeterminate — see the device-specific data manual

Table 4-54. DDR3_CONFIG_23 Register (0x02620460) Field Descriptions

| Bits | Name | Description |
|-------|---------------------|---|
| 31-30 | Reserved | Reset = 0x0 Reserved. |
| 29-20 | WR_DATA_SLAVE_RATIO | Reset = 0xA6 Plug in the effective reg_phy_wr_data_slave_ratio value from the PHY calculation spreadsheet. |
| 19-10 | WR_DQS_SLAVE_RATIO | Reset = 0x66 Plug in the effective reg_phy_wr_dqs_slave_ratio value from the PHY calculation spreadsheet. |
| 9-0 | RD_DQS_SLAVE_RATIO | Reset = 0x34 Plug in the effective reg_phy_rd_dqs_slave_ratio value from the PHY calculation spreadsheet. |

4.53 DDR3 Configuration 24 Register (DDR3_CONFIG_24)

NOTE: NA for TCI6612/13/14 and C665x devices.

DDR3 Configuration Register 24 is used for forced ratio leveling, and is described in the following figure and table.

Figure 4-53. DDR3 Configuration 24 Register (DDR3_CONFIG_24)

| | | | |
|----------|----|---------------------|---|
| 31 | 11 | 10 | 0 |
| Reserved | | FIFO_WE_SLAVE_RATIO | |
| R=0x0 | | RW=0xF | |

Legend: R = Read only; W = Write only; - n = value after reset; -x, value is indeterminate — see the device-specific data manual

Table 4-55. DDR3_CONFIG_24 Register (0x02620464) Field Descriptions

| Bits | Name | Description |
|-------|---------------------|---|
| 31-11 | Reserved | Reset = 0x0 Reserved. |
| 10-0 | FIFO_WE_SLAVE_RATIO | Reset = 0x15 Plug in the effective reg_phy_fifo_we_slave_ratio value from the PHY calculation spreadsheet. |

4.54 DDR3 Configuration 25 Register (DDR3_CONFIG_25)

DDR3 Configuration Register 25 is used for forced ratio leveling, and is described in the following figure and table.

Figure 4-54. DDR3 Configuration 25 Register (DDR3_CONFIG_25)

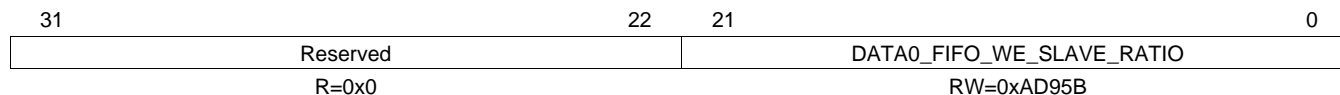

Legend: R = Read only; W = Write only; - n = value after reset; -x, value is indeterminate — see the device-specific data manual

Table 4-56. DDR3_CONFIG_25 Register (0x02620468) Field Descriptions

| Bits | Name | Description |
|-------|---------------------------|--|
| 31-22 | Reserved | Reset = 0x0 Reserved. |
| 21-0 | DATA0_FIFO_WE_SLAVE_RATIO | Reset = 0x000AD95B Plug in the effective reg_phy_fifo_we_slave_ratio value from the PHY calculation spreadsheet for Byte lane 3 for C665x devices or Byte lane 7 for TCI6612/13/14. |

4.55 DDR3 Configuration 26 Register (DDR3_CONFIG_26)

DDR3 Configuration Register 26 is used for forced ratio leveling, and is described in the following figure and table.

Figure 4-55. DDR3 Configuration 26 Register (DDR3_CONFIG_26)

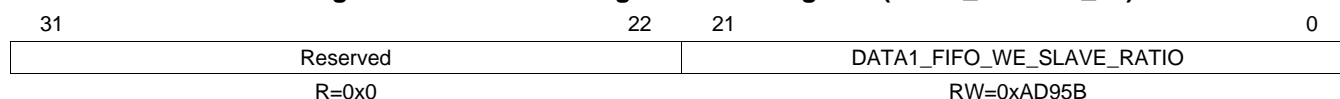

Legend: R = Read only; W = Write only; - n = value after reset; -x, value is indeterminate — see the device-specific data manual

Table 4-57. DDR3_CONFIG_26 Register (0x0262046C) Field Descriptions

| Bits | Name | Description |
|-------|---------------------------|--|
| 31-22 | Reserved | Reset = 0x0 Reserved. |
| 21-0 | DATA1_FIFO_WE_SLAVE_RATIO | Reset = 0x000AD95B Plug in the effective reg_phy_fifo_we_slave_ratio value from the PHY calculation spreadsheet for Byte lane 2 for C665x devices or Byte lane 6 for TCI6612/13/14. |

4.56 DDR3 Configuration 27 Register (DDR3_CONFIG_27)

DDR3 Configuration Register 27 is used for forced ratio leveling, and is described in the following figure and table.

Figure 4-56. DDR3 Configuration 27 Register (DDR3_CONFIG_27)

| | | | |
|----------|----|---------------------------|---|
| 31 | 22 | 21 | 0 |
| Reserved | | DATA2_FIFO_WE_SLAVE_RATIO | |
| R=0x0 | | RW=0xAD95B | |

Legend: R = Read only; W = Write only; - n = value after reset; -x, value is indeterminate — see the device-specific data manual

Table 4-58. DDR3_CONFIG_27 Register (0x02620470) Field Descriptions

| Bits | Name | Description |
|-------|---------------------------|--|
| 31-22 | Reserved | Reset = 0x0 Reserved. |
| 21-0 | DATA2_FIFO_WE_SLAVE_RATIO | Reset = 0x000AD95B Plug in the effective reg_phy_fifo_we_slave_ratio value from the PHY calculation spreadsheet for Byte lane 1 for C665x devices or Byte lane 5 for TCI6612/13/14. |

4.57 DDR3 Configuration 28 Register (DDR3_CONFIG_28)

DDR3 Configuration Register 28 is used for forced ratio leveling, and is described in the following figure and table.

Figure 4-57. DDR3 Configuration 28 Register (DDR3_CONFIG_28)

| | | | |
|----------|----|---------------------------|---|
| 31 | 22 | 21 | 0 |
| Reserved | | DATA3_FIFO_WE_SLAVE_RATIO | |
| R=0x0 | | RW=0xAD95B | |

Legend: R = Read only; W = Write only; - n = value after reset; -x, value is indeterminate — see the device-specific data manual

Table 4-59. DDR3_CONFIG_28 Register (0x02620474) Field Descriptions

| Bits | Name | Description |
|-------|---------------------------|--|
| 31-22 | Reserved | Reset = 0x0 Reserved. |
| 21-0 | DATA3_FIFO_WE_SLAVE_RATIO | Reset = 0x000AD95B Plug in the effective reg_phy_fifo_we_slave_ratio value from the PHY calculation spreadsheet for Byte lane 0 for C665x devices or Byte lane 4 for TCI6612/13/14. |

4.58 DDR3 Configuration 29 Register (DDR3_CONFIG_29)

NOTE: TCI6612/13/14 only.

DDR3 Configuration Register 29 is used for forced ratio leveling, and is described in the following figure and table.

Figure 4-58. DDR3 Configuration 29 Register (DDR3_CONFIG_29)

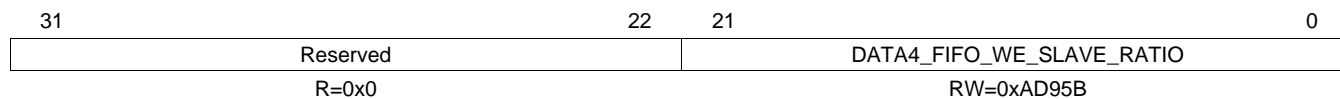

Legend: R = Read only; W = Write only; - n = value after reset; -x, value is indeterminate — see the device-specific data manual

Table 4-60. DDR3_CONFIG_29 Register (0x02620478) Field Descriptions

| Bits | Name | Description |
|-------|---------------------------|---|
| 31-22 | Reserved | Reset = 0x0 Reserved. |
| 21-0 | DATA4_FIFO_WE_SLAVE_RATIO | Reset = 0x000AD95B Plug in the effective reg_phy_fifo_we_slave_ratio value from the PHY calculation spreadsheet for Byte lane 3 for TCI6612/13/14. |

4.59 DDR3 Configuration 30 Register (DDR3_CONFIG_30)

NOTE: TCI6612/13/14 only.

DDR3 Configuration Register 30 is used for forced ratio leveling, and is described in the following figure and table.

Figure 4-59. DDR3 Configuration 30 Register (DDR3_CONFIG_30)

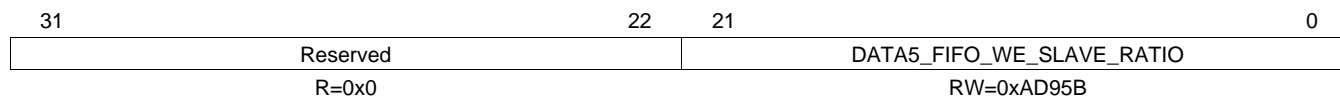

Legend: R = Read only; W = Write only; - n = value after reset; -x, value is indeterminate — see the device-specific data manual

Table 4-61. DDR3_CONFIG_30 Register (0x0262047C) Field Descriptions

| Bits | Name | Description |
|-------|---------------------------|---|
| 31-22 | Reserved | Reset = 0x0 Reserved. |
| 21-0 | DATA5_FIFO_WE_SLAVE_RATIO | Reset = 0x000AD95B Plug in the effective reg_phy_fifo_we_slave_ratio value from the PHY calculation spreadsheet for Byte lane 2 for TCI6612/13/14. |

4.60 DDR3 Configuration 31 Register (DDR3_CONFIG_31)

NOTE: TCI6612/13/14 only.

DDR3 Configuration Register 31 is used for forced ratio leveling, and is described in the following figure and table.

Figure 4-60. DDR3 Configuration 31 Register (DDR3_CONFIG_31)

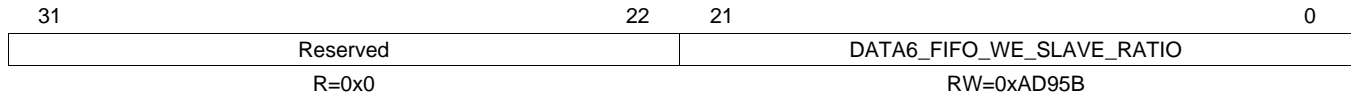

Legend: R = Read only; W = Write only; - n = value after reset; -x, value is indeterminate — see the device-specific data manual

Table 4-62. DDR3_CONFIG_31 Register (0x02620480) Field Descriptions

| Bits | Name | Description |
|-------|---------------------------|---|
| 31-22 | Reserved | Reset = 0x0 Reserved. |
| 21-0 | DATA6_FIFO_WE_SLAVE_RATIO | Reset = 0x000AD95B Plug in the effective reg_phy_fifo_we_slave_ratio value from the PHY calculation spreadsheet for Byte lane 1 for TCI6612/13/14. |

4.61 DDR3 Configuration 32 Register (DDR3_CONFIG_32)

NOTE: TCI6612/13/14 only.

DDR3 Configuration Register 32 is used for forced ratio leveling, and is described in the following figure and table.

Figure 4-61. DDR3 Configuration 32 Register (DDR3_CONFIG_32)

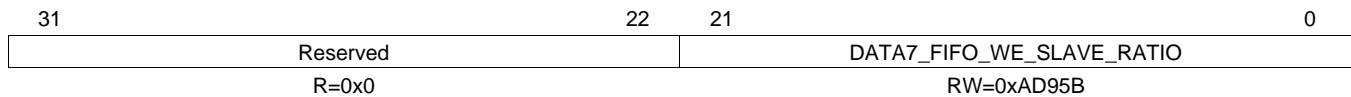

Legend: R = Read only; W = Write only; - n = value after reset; -x, value is indeterminate — see the device-specific data manual

Table 4-63. DDR3_CONFIG_32 Register (0x02620484) Field Descriptions

| Bits | Name | Description |
|-------|---------------------------|---|
| 31-22 | Reserved | Reset = 0x0 Reserved. |
| 21-0 | DATA7_FIFO_WE_SLAVE_RATIO | Reset = 0x000AD95B Plug in the effective reg_phy_fifo_we_slave_ratio value from the PHY calculation spreadsheet for Byte lane 0 for TCI6612/13/14. |

4.62 DDR3 Configuration 33 Register (DDR3_CONFIG_33)

DDR3 Configuration Register 33 is used for forced ratio leveling, and is described in the following figure and table.

Figure 4-62. DDR3 Configuration 33 Register (DDR3_CONFIG_33)

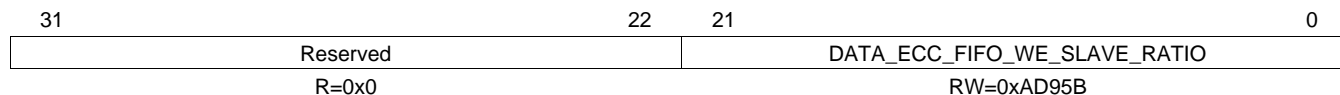

Legend: R = Read only; W = Write only; - n = value after reset; -x, value is indeterminate — see the device-specific data manual

Table 4-64. DDR3_CONFIG_33 Register (0x02620488) Field Descriptions

| Bits | Name | Description |
|-------|------------------------------|---|
| 31-22 | Reserved | Reset = 0x0 Reserved. |
| 21-0 | DATA_ECC_FIFO_WE_SLAVE_RATIO | Reset = 0x000AD95B Plug in the effective reg_phy_fifo_we_slave_ratio value from the PHY calculation spreadsheet for ECC Byte lane (same for both devices). |

4.63 DDR3 Configuration 34 Register (DDR3_CONFIG_34)

DDR3 Configuration Register 34 is used for forced ratio leveling, and is described in the following figure and table.

Figure 4-63. DDR3 Configuration 34 Register (DDR3_CONFIG_34)

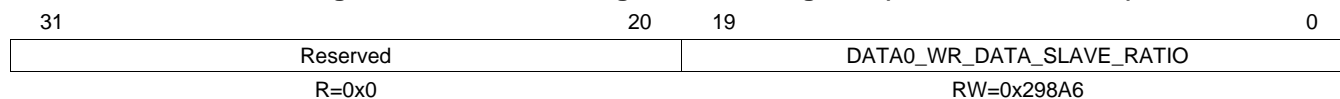

Legend: R = Read only; W = Write only; - n = value after reset; -x, value is indeterminate — see the device-specific data manual

Table 4-65. DDR3_CONFIG_34 Register (0x0262048C) Field Descriptions

| Bits | Name | Description |
|-------|---------------------------|--|
| 31-20 | Reserved | Reset = 0x0 Reserved. |
| 19-0 | DATA0_WR_DATA_SLAVE_RATIO | Reset = 0x000298A6 Plug in the effective reg_phy_wr_data_slave_ratio value from the PHY calculation spreadsheet for Byte lane 3 for C665x devices or Byte lane 7 for TCI6612/13/14. |

4.64 DDR3 Configuration 35 Register (DDR3_CONFIG_35)

DDR3 Configuration Register 35 is used for forced ratio leveling, and is described in the following figure and table.

Figure 4-64. DDR3 Configuration 35 Register (DDR3_CONFIG_35)

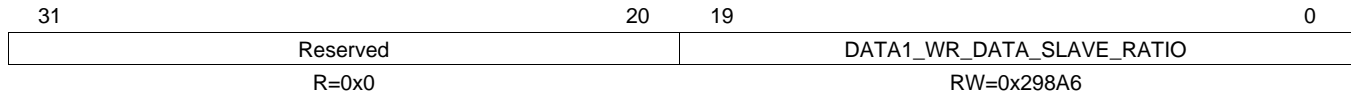

Legend: R = Read only; W = Write only; - n = value after reset; -x, value is indeterminate — see the device-specific data manual

Table 4-66. DDR3_CONFIG_35 Register (0x02620490) Field Descriptions

| Bits | Name | Description |
|-------|---------------------------|--|
| 31-20 | Reserved | Reset = 0x0 Reserved. |
| 19-0 | DATA1_WR_DATA_SLAVE_RATIO | Reset = 0x000298A6 Plug in the effective reg_phy_wr_data_slave_ratio value from the PHY calculation spreadsheet for Byte lane 2 for C665x devices or Byte lane 6 for TCI6612/13/14. |

4.65 DDR3 Configuration 36 Register (DDR3_CONFIG_36)

DDR3 Configuration Register 36 is used for forced ratio leveling, and is described in the following figure and table.

Figure 4-65. DDR3 Configuration 36 Register (DDR3_CONFIG_36)

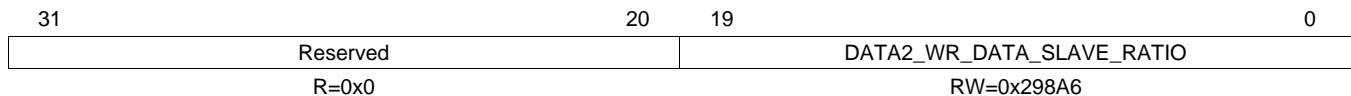

Legend: R = Read only; W = Write only; - n = value after reset; -x, value is indeterminate — see the device-specific data manual

Table 4-67. DDR3_CONFIG_36 Register (0x02620494) Field Descriptions

| Bits | Name | Description |
|-------|---------------------------|--|
| 31-20 | Reserved | Reset = 0x0 Reserved. |
| 19-0 | DATA2_WR_DATA_SLAVE_RATIO | Reset = 0x000298A6 Plug in the effective reg_phy_wr_data_slave_ratio value from the PHY calculation spreadsheet for Byte lane 1 for C665x devices or Byte lane 5 for TCI6612/13/14. |

4.66 DDR3 Configuration 37 Register (DDR3_CONFIG_37)

DDR3 Configuration Register 37 is used for forced ratio leveling, and is described in the following figure and table.

Figure 4-66. DDR3 Configuration 37 Register (DDR3_CONFIG_37)

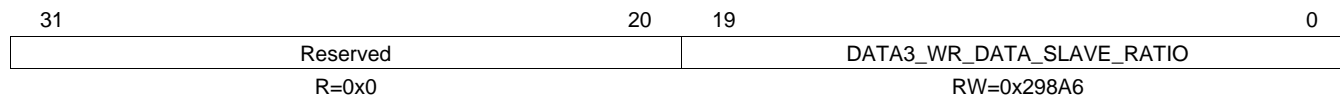

Legend: R = Read only; W = Write only; - n = value after reset; -x, value is indeterminate — see the device-specific data manual

Table 4-68. DDR3_CONFIG_37 Register (0x02620498) Field Descriptions

| Bits | Name | Description |
|-------|---------------------------|--|
| 31-20 | Reserved | Reset = 0x0 Reserved. |
| 19-0 | DATA3_WR_DATA_SLAVE_RATIO | Reset = 0x000298A6 Plug in the effective reg_phy_wr_data_slave_ratio value from the PHY calculation spreadsheet for Byte lane 0 for C665x devices or Byte lane 4 for TCI6612/13/14. |

4.67 DDR3 Configuration 38 Register (DDR3_CONFIG_38)

NOTE: TCI6612/13/14 only.

DDR3 Configuration Register 38 is used for forced ratio leveling, and is described in the following figure and table.

Figure 4-67. DDR3 Configuration 38 Register (DDR3_CONFIG_38)

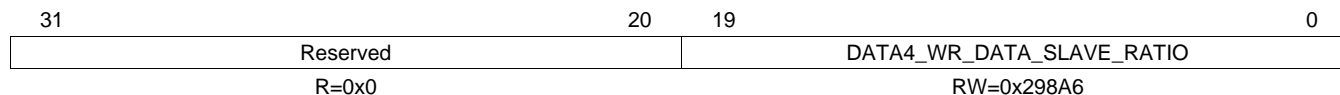

Legend: R = Read only; W = Write only; - n = value after reset; -x, value is indeterminate — see the device-specific data manual

Table 4-69. DDR3_CONFIG_38 Register (0x0262049C) Field Descriptions

| Bits | Name | Description |
|-------|---------------------------|---|
| 31-20 | Reserved | Reset = 0x0 Reserved. |
| 19-0 | DATA4_WR_DATA_SLAVE_RATIO | Reset = 0x000298A6 Plug in the effective reg_phy_wr_data_slave_ratio value from the PHY calculation spreadsheet for Byte lane 3 for TCI6612/13/14. |

4.68 DDR3 Configuration 39 Register (DDR3_CONFIG_39)

NOTE: TCI6612/13/14 only.

DDR3 Configuration Register 39 is used for forced ratio leveling, and is described in the following figure and table.

Figure 4-68. DDR3 Configuration 39 Register (DDR3_CONFIG_39)

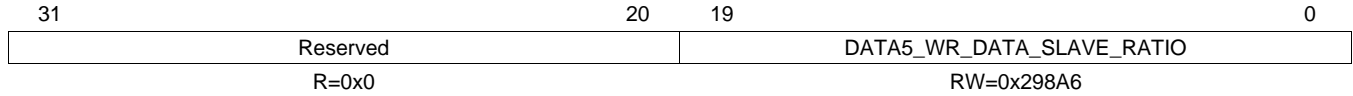

Legend: R = Read only; W = Write only; - n = value after reset; -x, value is indeterminate — see the device-specific data manual

Table 4-70. DDR3_CONFIG_39 Register (0x026204A0) Field Descriptions

| Bits | Name | Description |
|-------|---------------------------|---|
| 31-20 | Reserved | Reset = 0x0 Reserved. |
| 19-0 | DATA5_WR_DATA_SLAVE_RATIO | Reset = 0x000298A6 Plug in the effective reg_phy_wr_data_slave_ratio value from the PHY calculation spreadsheet for Byte lane 2 for TCI6612/13/14. |

4.69 DDR3 Configuration 40 Register (DDR3_CONFIG_40)

NOTE: (TCI6612/13/14 only)

DDR3 Configuration Register 40 is used for forced ratio leveling, and is described in the following figure and table.

Figure 4-69. DDR3 Configuration 40 Register (DDR3_CONFIG_40)

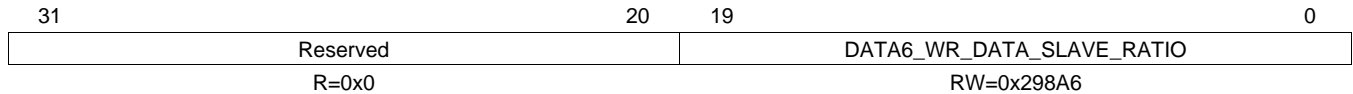

Legend: R = Read only; W = Write only; - n = value after reset; -x, value is indeterminate — see the device-specific data manual

Table 4-71. DDR3_CONFIG_40 Register (0x026204A4) Field Descriptions

| Bits | Name | Description |
|-------|---------------------------|---|
| 31-20 | Reserved | Reset = 0x0 Reserved. |
| 19-0 | DATA6_WR_DATA_SLAVE_RATIO | Reset = 0x000298A6 Plug in the effective reg_phy_wr_data_slave_ratio value from the PHY calculation spreadsheet for Byte lane 1 for TCI6612/13/14. |

4.70 DDR3 Configuration 41 Register (DDR3_CONFIG_41)

NOTE: TCI6612/13/14 only.

DDR3 Configuration Register 41 is used for forced ratio leveling, and is described in the following figure and table.

Figure 4-70. DDR3 Configuration 41 Register (DDR3_CONFIG_41)

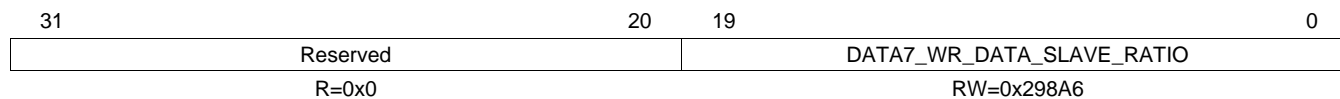

Legend: R = Read only; W = Write only; - n = value after reset; -x, value is indeterminate — see the device-specific data manual

Table 4-72. DDR3_CONFIG_41 Register (0x026204A8) Field Descriptions

| Bits | Name | Description |
|-------|---------------------------|---|
| 31-20 | Reserved | Reset = 0x0 Reserved. |
| 19-0 | DATA7_WR_DATA_SLAVE_RATIO | Reset = 0x000298A6 Plug in the effective reg_phy_wr_data_slave_ratio value from the PHY calculation spreadsheet for Byte lane 0 for TCI6612/13/14. |

4.71 DDR3 Configuration 42 Register (DDR3_CONFIG_42)

DDR3 Configuration Register 42 is used for forced ratio leveling, and is described in the following figure and table.

Figure 4-71. DDR3 Configuration 42 Register (DDR3_CONFIG_42)

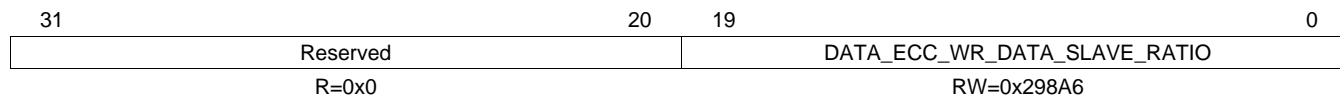

Legend: R = Read only; W = Write only; - n = value after reset; -x, value is indeterminate — see the device-specific data manual

Table 4-73. DDR3_CONFIG_42 Register (0x026204AC) Field Descriptions

| Bits | Name | Description |
|-------|------------------------------|--|
| 31-20 | Reserved | Reset = 0x0 Reserved. |
| 19-0 | DATA_ECC_WR_DATA_SLAVE_RATIO | Reset = 0x000298A6 Plug in the effective reg_phy_wr_data_slave_ratio value from the PHY calculation spreadsheet for ECC Byte lane (same for both devices) |

4.72 DDR3 Configuration 43 Register (DDR3_CONFIG_43)

DDR3 Configuration Register 43 is used for forced ratio leveling, and is described in the following figure and table.

Figure 4-72. DDR3 Configuration 43 Register (DDR3_CONFIG_43)

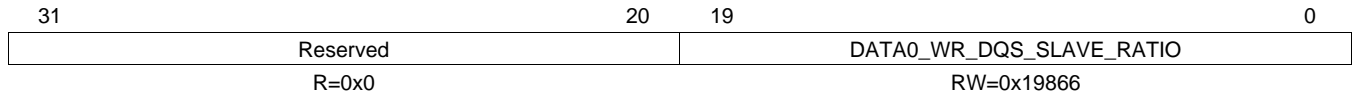

Legend: R = Read only; W = Write only; - n = value after reset; -x, value is indeterminate — see the device-specific data manual

Table 4-74. DDR3_CONFIG_43 Register (0x026204B0) Field Descriptions

| Bits | Name | Description |
|-------|--------------------------|---|
| 31-20 | Reserved | Reset = 0x0 Reserved. |
| 19-0 | DATA0_WR_DQS_SLAVE_RATIO | Reset = 0x00019866 Plug in the effective reg_phy_wr_dqs_slave_ratio value from the PHY calculation spreadsheet for Byte lane 3 for C665x devices or Byte lane 7 for TCI6612/13/14. |

4.73 DDR3 Configuration 44 Register (DDR3_CONFIG_44)

DDR3 Configuration Register 44 is used for forced ratio leveling, and is described in the following figure and table.

Figure 4-73. DDR3 Configuration 44 Register (DDR3_CONFIG_44)

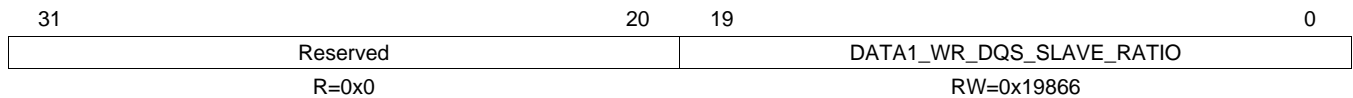

Legend: R = Read only; W = Write only; - n = value after reset; -x, value is indeterminate — see the device-specific data manual

Table 4-75. DDR3_CONFIG_44 Register (0x026204B4) Field Descriptions

| Bits | Name | Description |
|-------|--------------------------|---|
| 31-20 | Reserved | Reset = 0x0 Reserved. |
| 19-0 | DATA1_WR_DQS_SLAVE_RATIO | Reset = 0x00019866 Plug in the effective reg_phy_wr_dqs_slave_ratio value from the PHY calculation spreadsheet for Byte lane 2 for C665x devices or Byte lane 6 for TCI6612/13/14. |

4.74 DDR3 Configuration 45 Register (DDR3_CONFIG_45)

DDR3 Configuration Register 45 is used for forced ratio leveling, and is described in the following figure and table.

Figure 4-74. DDR3 Configuration 45 Register (DDR3_CONFIG_45)

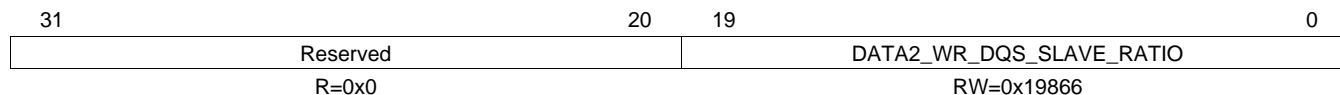

Legend: R = Read only; W = Write only; - n = value after reset; -x, value is indeterminate — see the device-specific data manual

Table 4-76. DDR3_CONFIG_45 Register (0x026204B8) Field Descriptions

| Bits | Name | Description |
|-------|--------------------------|---|
| 31-20 | Reserved | Reset = 0x0 Reserved. |
| 19-0 | DATA2_WR_DQS_SLAVE_RATIO | Reset = 0x00019866 Plug in the effective reg_phy_wr_dqs_slave_ratio value from the PHY calculation spreadsheet for Byte lane 1 for C665x devices or Byte lane 5 for TCI6612/13/14. |

4.75 DDR3 Configuration 46 Register (DDR3_CONFIG_46)

DDR3 Configuration Register 46 is used for forced ratio leveling, and is described in the following figure and table.

Figure 4-75. DDR3 Configuration 46 Register (DDR3_CONFIG_46)

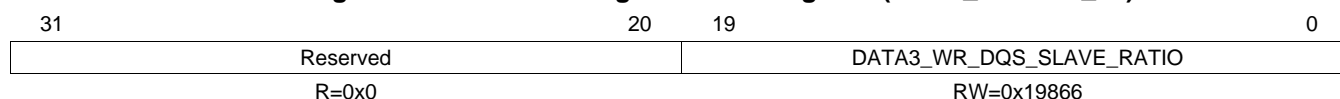

Legend: R = Read only; W = Write only; - n = value after reset; -x, value is indeterminate — see the device-specific data manual

Table 4-77. DDR3_CONFIG_46 Register (0x026204BC) Field Descriptions

| Bits | Name | Description |
|-------|--------------------------|---|
| 31-20 | Reserved | Reset = 0x0 Reserved. |
| 19-0 | DATA3_WR_DQS_SLAVE_RATIO | Reset = 0x00019866 Plug in the effective reg_phy_wr_dqs_slave_ratio value from the PHY calculation spreadsheet for Byte lane 0 for C665x devices or Byte lane 4 for TCI6612/13/14. |

4.76 DDR3 Configuration 47 Register (DDR3_CONFIG_47)

NOTE: TCI6612/13/14 only.

DDR3 Configuration Register 47 is used for forced ratio leveling, and is described in the following figure and table.

Figure 4-76. DDR3 Configuration 47 Register (DDR3_CONFIG_47)

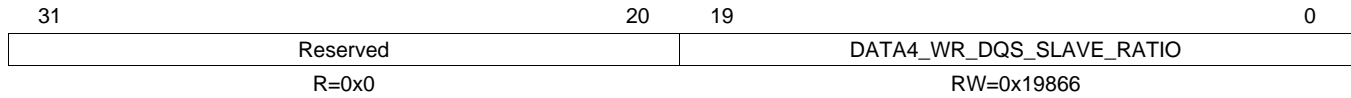

Legend: R = Read only; W = Write only; - n = value after reset; -x, value is indeterminate — see the device-specific data manual

Table 4-78. DDR3_CONFIG_47 Register (0x026204C0) Field Descriptions

| Bits | Name | Description |
|-------|--------------------------|--|
| 31-20 | Reserved | Reset = 0x0 Reserved. |
| 19-0 | DATA4_WR_DQS_SLAVE_RATIO | Reset = 0x00019866 Plug in the effective reg_phy_wr_dqs_slave_ratio value from the PHY calculation spreadsheet for Byte lane 3 for TCI6612/13/14. |

4.77 DDR3 Configuration 48 Register (DDR3_CONFIG_48)

NOTE: TCI6612/13/14 only.

DDR3 Configuration Register 48 is used for forced ratio leveling, and is described in the following figure and table.

Figure 4-77. DDR3 Configuration 48 Register (DDR3_CONFIG_48)

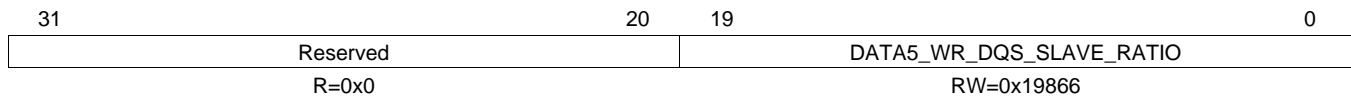

Legend: R = Read only; W = Write only; - n = value after reset; -x, value is indeterminate — see the device-specific data manual

Table 4-79. DDR3_CONFIG_48 Register (0x026204C4) Field Descriptions

| Bits | Name | Description |
|-------|--------------------------|--|
| 31-20 | Reserved | Reset = 0x0 Reserved. |
| 19-0 | DATA5_WR_DQS_SLAVE_RATIO | Reset = 0x00019866 Plug in the effective reg_phy_wr_dqs_slave_ratio value from the PHY calculation spreadsheet for Byte lane 2 for TCI6612/13/14. |

4.78 DDR3 Configuration 49 Register (DDR3_CONFIG_49)

NOTE: TCI6612/13/14 only.

DDR3 Configuration Register 49 is used for forced ratio leveling, and is described in the following figure and table.

Figure 4-78. DDR3 Configuration 49 Register (DDR3_CONFIG_49)

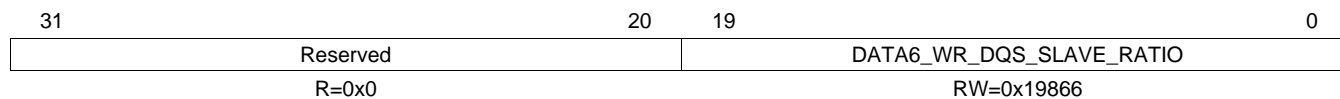

Legend: R = Read only; W = Write only; - n = value after reset; -x, value is indeterminate — see the device-specific data manual

Table 4-80. DDR3_CONFIG_49 Register (0x026204C8) Field Descriptions

| Bits | Name | Description |
|-------|--------------------------|--|
| 31-20 | Reserved | Reset = 0x0 Reserved. |
| 19-0 | DATA6_WR_DQS_SLAVE_RATIO | Reset = 0x00019866 Plug in the effective reg_phy_wr_dqs_slave_ratio value from the PHY calculation spreadsheet for Byte lane 1 for TCI6612/13/14. |

4.79 DDR3 Configuration 50 Register (DDR3_CONFIG_50)

NOTE: TCI6612/13/14 only.

DDR3 Configuration Register 50 is used for forced ratio leveling, and is described in the following figure and table.

Figure 4-79. DDR3 Configuration 50 Register (DDR3_CONFIG_50)

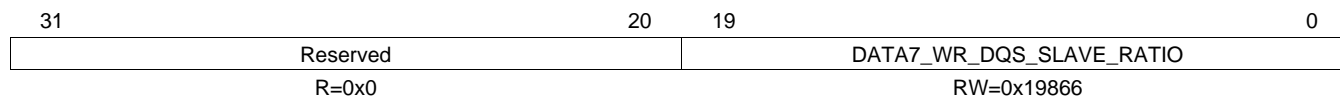

Legend: R = Read only; W = Write only; - n = value after reset; -x, value is indeterminate — see the device-specific data manual

Table 4-81. DDR3_CONFIG_50 Register (0x026204CC) Field Descriptions

| Bits | Name | Description |
|-------|--------------------------|--|
| 31-20 | Reserved | Reset = 0x0 Reserved. |
| 19-0 | DATA7_WR_DQS_SLAVE_RATIO | Reset = 0x00019866 Plug in the effective reg_phy_wr_dqs_slave_ratio value from the PHY calculation spreadsheet for Byte lane 0 for TCI6612/13/14. |

4.80 DDR3 Configuration 51 Register (DDR3_CONFIG_51)

DDR3 Configuration Register 51 is used for forced ratio leveling, and is described in the following figure and table.

Figure 4-80. DDR3 Configuration 51 Register (DDR3_CONFIG_51)

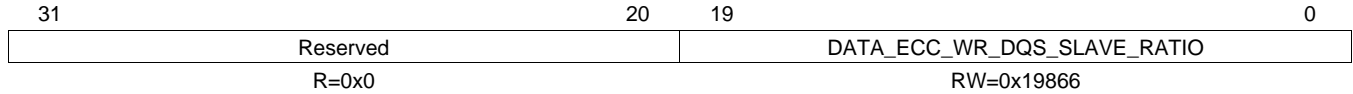

Legend: R = Read only; W = Write only; - n = value after reset; -x, value is indeterminate — see the device-specific data manual

Table 4-82. DDR3_CONFIG_51 Register (0x026204D0) Field Descriptions

| Bits | Name | Description |
|-------|-----------------------------|---|
| 31-20 | Reserved | Reset = 0x0 Reserved. |
| 19-0 | DATA_ECC_WR_DQS_SLAVE_RATIO | Reset = 0x00019866 Plug in the effective reg_phy_wr_dqs_slave_ratio value from the PHY calculation spreadsheet for ECC Byte lane (same for both devices) |

4.81 DDR3 Configuration 52 Register (DDR3_CONFIG_52)

DDR3 Configuration Register 52 is used for forced ratio leveling, and is described in the following figure and table.

Figure 4-81. DDR3 Configuration 52 Register (DDR3_CONFIG_52)

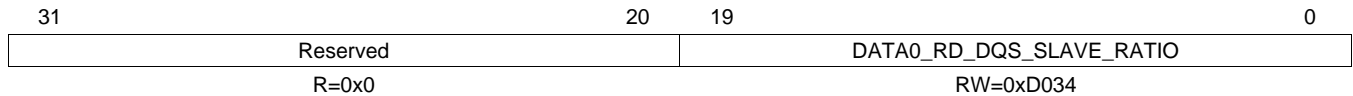

Legend: R = Read only; W = Write only; - n = value after reset; -x, value is indeterminate — see the device-specific data manual

Table 4-83. DDR3_CONFIG_52 Register (0x026204D4) Field Descriptions

| Bits | Name | Description |
|-------|--------------------------|---|
| 31-20 | Reserved | Reset = 0x0 Reserved. |
| 19-0 | DATA0_RD_DQS_SLAVE_RATIO | Reset = 0x0000D034 Plug in the effective reg_phy_rd_dqs_slave_ratio value from the PHY calculation spreadsheet for Byte lane 3 for C665x devices or Byte Lane 7 for TC16612/13/14. |

4.82 DDR3 Configuration 53 Register (DDR3_CONFIG_53)

DDR3 Configuration Register 53 is used for forced ratio leveling, and is described in the following figure and table.

Figure 4-82. DDR3 Configuration 53 Register (DDR3_CONFIG_53)

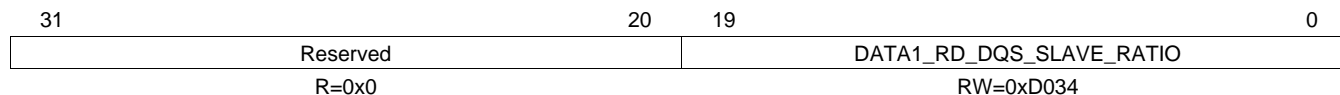

Legend: R = Read only; W = Write only; - n = value after reset; -x, value is indeterminate — see the device-specific data manual

Table 4-84. DDR3_CONFIG_53 Register (0x026204D8) Field Descriptions

| Bits | Name | Description |
|-------|--------------------------|---|
| 31-20 | Reserved | Reset = 0x0 Reserved. |
| 19-0 | DATA1_RD_DQS_SLAVE_RATIO | Reset = 0x0000D034 Plug in the effective reg_phy_rd_dqs_slave_ratio value from the PHY calculation spreadsheet for Byte lane 2 for C665x devices or Byte Lane 6 for TC16612/13/14. |

4.83 DDR3 Configuration 54 Register (DDR3_CONFIG_54)

DDR3 Configuration Register 54 is used for forced ratio leveling, and is described in the following figure and table.

Figure 4-83. DDR3 Configuration 54 Register (DDR3_CONFIG_54)

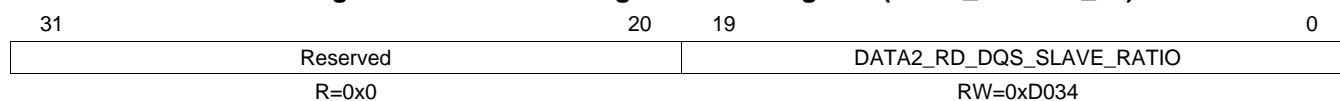

Legend: R = Read only; W = Write only; - n = value after reset; -x, value is indeterminate — see the device-specific data manual

Table 4-85. DDR3_CONFIG_54 Register (0x026204DC) Field Descriptions

| Bits | Name | Description |
|-------|--------------------------|---|
| 31-20 | Reserved | Reset = 0x0 Reserved. |
| 19-0 | DATA2_RD_DQS_SLAVE_RATIO | Reset = 0x0000D034 Plug in the effective reg_phy_rd_dqs_slave_ratio value from the PHY calculation spreadsheet for Byte lane 1 for C665x devices or Byte Lane 5 for TC16612/13/14. |

4.84 DDR3 Configuration 55 Register (DDR3_CONFIG_55)

DDR3 Configuration Register 55 is used for forced ratio leveling, and is described in the following figure and table.

Figure 4-84. DDR3 Configuration 55 Register (DDR3_CONFIG_55)

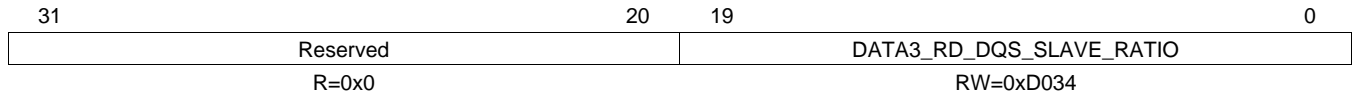

Legend: R = Read only; W = Write only; - n = value after reset; -x, value is indeterminate — see the device-specific data manual

Table 4-86. DDR3_CONFIG_55 Register (0x026204E0) Field Descriptions

| Bits | Name | Description |
|-------|--------------------------|---|
| 31-20 | Reserved | Reset = 0x0 Reserved. |
| 19-0 | DATA3_RD_DQS_SLAVE_RATIO | Reset = 0x0000D034 Plug in the effective reg_phy_rd_dqs_slave_ratio value from the PHY calculation spreadsheet for Byte lane 0 for C665x devices or Byte Lane 4 for TCI6612/13/14. |

4.85 DDR3 Configuration 56 Register (DDR3_CONFIG_56)

NOTE: TCI6612/13/14 only.

DDR3 Configuration Register 56 is used for forced ratio leveling, and is described in the following figure and table.

Figure 4-85. DDR3 Configuration 56 Register (DDR3_CONFIG_56)

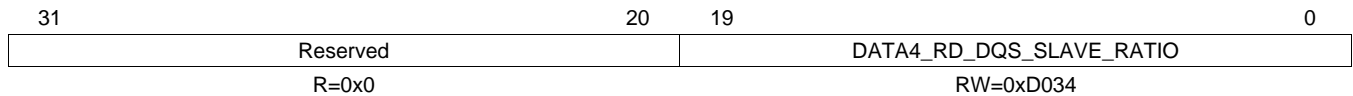

Legend: R = Read only; W = Write only; - n = value after reset; -x, value is indeterminate — see the device-specific data manual

Table 4-87. DDR3_CONFIG_56 Register (0x026204E4) Field Descriptions

| Bits | Name | Description |
|-------|--------------------------|--|
| 31-20 | Reserved | Reset = 0x0 Reserved. |
| 19-0 | DATA4_RD_DQS_SLAVE_RATIO | Reset = 0x0000D034 Plug in the effective reg_phy_rd_dqs_slave_ratio value from the PHY calculation spreadsheet for Byte Lane 3 for TCI6612/13/14. |

4.86 DDR3 Configuration 57 Register (DDR3_CONFIG_57)

NOTE: TCI6612/13/14 only.

DDR3 Configuration Register 57 is used for forced ratio leveling, and is described in the following figure and table.

Figure 4-86. DDR3 Configuration 57 Register (DDR3_CONFIG_57)

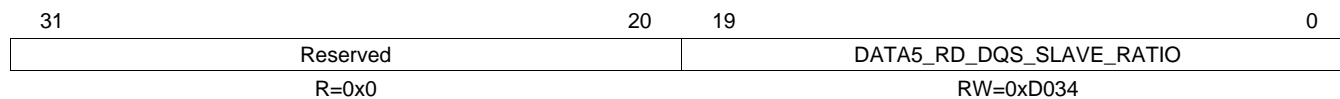

Legend: R = Read only; W = Write only; - n = value after reset; -x, value is indeterminate — see the device-specific data manual

Table 4-88. DDR3_CONFIG_57 Register (0x026204E8) Field Descriptions

| Bits | Name | Description |
|-------|--------------------------|--|
| 31-20 | Reserved | Reset = 0x0 Reserved. |
| 19-0 | DATA5_RD_DQS_SLAVE_RATIO | Reset = 0x0000D034 Plug in the effective reg_phy_rd_dqs_slave_ratio value from the PHY calculation spreadsheet for Byte Lane 2 for TCI6612/13/14. |

4.87 DDR3 Configuration 58 Register (DDR3_CONFIG_58)

NOTE: TCI6612/13/14 only.

DDR3 Configuration Register 58 is used for forced ratio leveling, and is described in the following figure and table.

Figure 4-87. DDR3 Configuration 58 Register (DDR3_CONFIG_58)

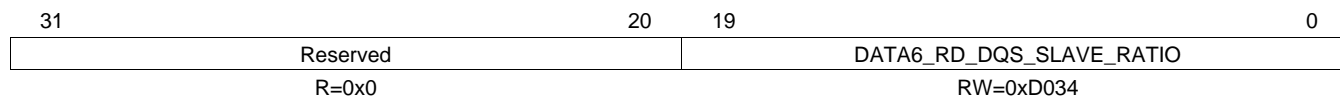

Legend: R = Read only; W = Write only; - n = value after reset; -x, value is indeterminate — see the device-specific data manual

Table 4-89. DDR3_CONFIG_58 Register (0x026204EC) Field Descriptions

| Bits | Name | Description |
|-------|--------------------------|--|
| 31-20 | Reserved | Reset = 0x0 Reserved. |
| 19-0 | DATA6_RD_DQS_SLAVE_RATIO | Reset = 0x0000D034 Plug in the effective reg_phy_rd_dqs_slave_ratio value from the PHY calculation spreadsheet for Byte Lane 1 for TCI6612/13/14. |

4.88 DDR3 Configuration 59 Register (DDR3_CONFIG_59)

NOTE: TCI6612/13/14 only.

DDR3 Configuration Register 59 is used for forced ratio leveling, and is described in the following figure and table.

Figure 4-88. DDR3 Configuration 59 Register (DDR3_CONFIG_59)

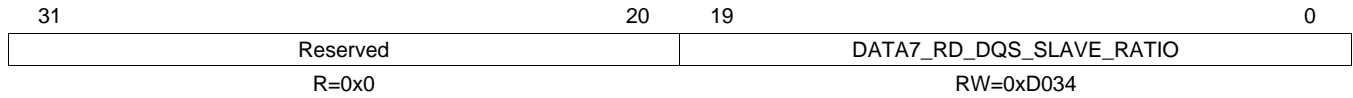

Legend: R = Read only; W = Write only; - n = value after reset; -x, value is indeterminate — see the device-specific data manual

Table 4-90. DDR3_CONFIG_59 Register (0x026204F0) Field Descriptions

| Bits | Name | Description |
|-------|--------------------------|--|
| 31-20 | Reserved | Reset = 0x0 Reserved. |
| 19-0 | DATA7_RD_DQS_SLAVE_RATIO | Reset = 0x0000D034 Plug in the effective reg_phy_rd_dqs_slave_ratio value from the PHY calculation spreadsheet for Byte Lane 0 for TCI6612/13/14. |

4.89 DDR3 Configuration 60 Register (DDR3_CONFIG_60)

DDR3 Configuration Register 60 is used for forced ratio leveling, and is described in the following figure and table.

Figure 4-89. DDR3 Configuration 60 Register (DDR3_CONFIG_60)

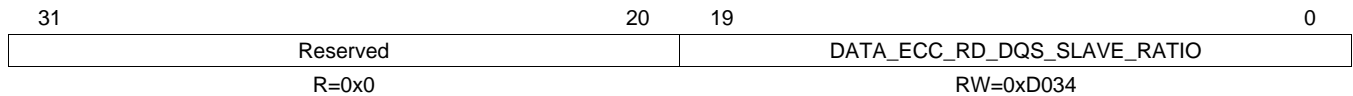

Legend: R = Read only; W = Write only; - n = value after reset; -x, value is indeterminate — see the device-specific data manual

Table 4-91. DDR3_CONFIG_60 Register (0x026204F4) Field Descriptions

| Bits | Name | Description |
|-------|-----------------------------|---|
| 31-20 | Reserved | Reset = 0x0 Reserved. |
| 19-0 | DATA_ECC_RD_DQS_SLAVE_RATIO | Reset = 0x0000D034 Plug in the effective reg_phy_rd_dqs_slave_ratio value from the PHY calculation spreadsheet for ECC Byte Lane (same for both devices) |

Revision History

| Changes from D Revision (April 2014) to E Revision | Page |
|--|-------------|
| • Updated Self-Refresh Mode section..... | 30 |
| • Added Dual Rank Support section..... | 34 |
| • Updated Ramp Incremental Leveling section. | 36 |
| • Updated SDRAM Configuration Register (SDCFG). | 57 |
| • Updated SDRAM Timing 2 (SDTIM2) Register. | 61 |
| • Updated SDRAM Timing 3 (SDTIM3) Register. | 62 |
| • Updated Read-Write Leveling Ramp Window Register..... | 77 |
| • Updated Read-Write Leveling Ramp Control Register..... | 78 |
| • Updated Read-Write Leveling Control Register..... | 79 |
| • Added DDR3 Configuration 1 Register (DDR3_CONFIG_1)..... | 89 |
| • Added Bit 24: USE_RANK0_DELAYS to DDR3_CONFIG_12 Register (0x02620434). | 94 |

IMPORTANT NOTICE

Texas Instruments Incorporated and its subsidiaries (TI) reserve the right to make corrections, enhancements, improvements and other changes to its semiconductor products and services per JESD46, latest issue, and to discontinue any product or service per JESD48, latest issue. Buyers should obtain the latest relevant information before placing orders and should verify that such information is current and complete. All semiconductor products (also referred to herein as "components") are sold subject to TI's terms and conditions of sale supplied at the time of order acknowledgment.

TI warrants performance of its components to the specifications applicable at the time of sale, in accordance with the warranty in TI's terms and conditions of sale of semiconductor products. Testing and other quality control techniques are used to the extent TI deems necessary to support this warranty. Except where mandated by applicable law, testing of all parameters of each component is not necessarily performed.

TI assumes no liability for applications assistance or the design of Buyers' products. Buyers are responsible for their products and applications using TI components. To minimize the risks associated with Buyers' products and applications, Buyers should provide adequate design and operating safeguards.

TI does not warrant or represent that any license, either express or implied, is granted under any patent right, copyright, mask work right, or other intellectual property right relating to any combination, machine, or process in which TI components or services are used. Information published by TI regarding third-party products or services does not constitute a license to use such products or services or a warranty or endorsement thereof. Use of such information may require a license from a third party under the patents or other intellectual property of the third party, or a license from TI under the patents or other intellectual property of TI.

Reproduction of significant portions of TI information in TI data books or data sheets is permissible only if reproduction is without alteration and is accompanied by all associated warranties, conditions, limitations, and notices. TI is not responsible or liable for such altered documentation. Information of third parties may be subject to additional restrictions.

Resale of TI components or services with statements different from or beyond the parameters stated by TI for that component or service voids all express and any implied warranties for the associated TI component or service and is an unfair and deceptive business practice. TI is not responsible or liable for any such statements.

Buyer acknowledges and agrees that it is solely responsible for compliance with all legal, regulatory and safety-related requirements concerning its products, and any use of TI components in its applications, notwithstanding any applications-related information or support that may be provided by TI. Buyer represents and agrees that it has all the necessary expertise to create and implement safeguards which anticipate dangerous consequences of failures, monitor failures and their consequences, lessen the likelihood of failures that might cause harm and take appropriate remedial actions. Buyer will fully indemnify TI and its representatives against any damages arising out of the use of any TI components in safety-critical applications.

In some cases, TI components may be promoted specifically to facilitate safety-related applications. With such components, TI's goal is to help enable customers to design and create their own end-product solutions that meet applicable functional safety standards and requirements. Nonetheless, such components are subject to these terms.

No TI components are authorized for use in FDA Class III (or similar life-critical medical equipment) unless authorized officers of the parties have executed a special agreement specifically governing such use.

Only those TI components which TI has specifically designated as military grade or "enhanced plastic" are designed and intended for use in military/aerospace applications or environments. Buyer acknowledges and agrees that any military or aerospace use of TI components which have **not** been so designated is solely at the Buyer's risk, and that Buyer is solely responsible for compliance with all legal and regulatory requirements in connection with such use.

TI has specifically designated certain components as meeting ISO/TS16949 requirements, mainly for automotive use. In any case of use of non-designated products, TI will not be responsible for any failure to meet ISO/TS16949.

Products

| | |
|------------------------------|--|
| Audio | www.ti.com/audio |
| Amplifiers | amplifier.ti.com |
| Data Converters | dataconverter.ti.com |
| DLP® Products | www.dlp.com |
| DSP | dsp.ti.com |
| Clocks and Timers | www.ti.com/clocks |
| Interface | interface.ti.com |
| Logic | logic.ti.com |
| Power Mgmt | power.ti.com |
| Microcontrollers | microcontroller.ti.com |
| RFID | www.ti-rfid.com |
| OMAP Applications Processors | www.ti.com/omap |
| Wireless Connectivity | www.ti.com/wirelessconnectivity |

Applications

| | |
|-------------------------------|--|
| Automotive and Transportation | www.ti.com/automotive |
| Communications and Telecom | www.ti.com/communications |
| Computers and Peripherals | www.ti.com/computers |
| Consumer Electronics | www.ti.com/consumer-apps |
| Energy and Lighting | www.ti.com/energy |
| Industrial | www.ti.com/industrial |
| Medical | www.ti.com/medical |
| Security | www.ti.com/security |
| Space, Avionics and Defense | www.ti.com/space-avionics-defense |
| Video and Imaging | www.ti.com/video |

TI E2E Community

e2e.ti.com