

IWR1443BOOST Evaluation Module mmWave Sensing Solution

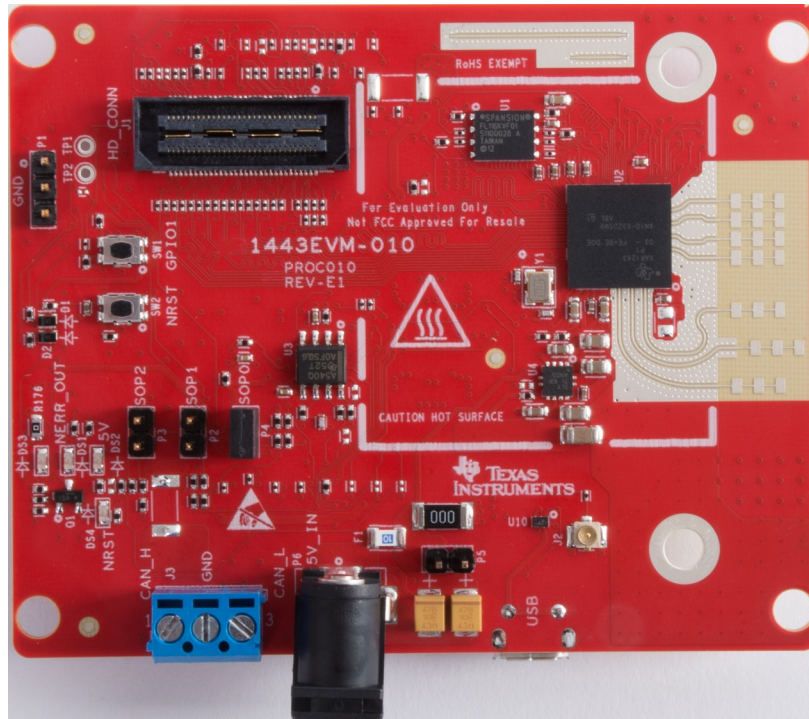

Contents

1	Getting Started	3
1.1	Introduction	3
1.2	Key Features	3
1.3	What is Included	3
2	Hardware.....	4
2.1	Block Diagram.....	5
2.2	Connecting BoosterPack™ to LaunchPad™ or MMWAVE-DEVPACK	6
2.3	Power Connections.....	7
2.4	Connectors	7
2.5	PC Connection.....	11
2.6	Antenna.....	12
2.7	Jumpers, Switches, and LEDs	14
3	Design Files and Software Tools.....	16
3.1	Software, Development Tools, and Example Codes	16
4	Mechanical Mounting of PCB.....	16
5	PCB Storage and Handling Recommendations	17
6	Regulatory Information	17
7	Troubleshooting	17

List of Figures

1	EVM Front View.....	4
2	EVM Rear View	5
3	IWR14xxBOOST Block Diagram	5
4	3V3 and 5-V Mark on the LaunchPad™ (White Triangle).....	6
5	Power Connector	7
6	20-Pin BoosterPack™ Connectors (J5 and J6).....	7
7	High Density Connector (60 Pin)	9
8	CAN Connector.....	10
9	XDS110 Ports.....	11
10	PCB Antenna	12
11	Antenna Pattern in H-Plane.....	13
12	Antenna Pattern in E-Plane	13
13	SOP Jumpers.....	14
14	Current Measurement Point	14
15	Vertical Assembly of the EVM	16

List of Tables

1	20-Pin Connector Definition (J6).....	8
2	20-Pin Connector Definition (J5).....	8
3	HD Connector Pin Definition	9
4	Pin Names	11
5	SOP Modes	14
6	Push Buttons.....	15
7	LEDs	15

1 ⁽¹⁾⁽²⁾⁽³⁾ Getting Started

1.1 Introduction

The IWR1443 BoosterPack™ is an easy-to-use evaluation board for the single-chip IWR1443 mmWave sensing device from TI, with direct connectivity to the TI MCU LaunchPad™ ecosystem. The evaluation board contains everything needed to start developing on a low-power ARM®-R4F controller. The evaluation board includes onboard emulation for programming and debugging, onboard buttons, and LEDs, for quick integration of a simple user interface. The standard 20-pin BoosterPack headers make the evaluation board compatible with a wide variety of TI MCU LaunchPads and enables easy prototyping.

1.2 Key Features

- 40-pin LaunchPad standard that leverages the LaunchPad ecosystem
- XDS110-based JTAG emulation with serial port, for onboard QSPI flash programming
- Backchannel UART through USB to PC, for logging purposes
- Onboard antenna
- 60-pin high density (HD) connector, for raw ADC data over CSI, or the high-speed debug interface
- Onboard CAN transceiver
- One button and two LEDs, for user interaction
- 5-V power jack, to power the board

1.3 What is Included

1.3.1 Kit Contents

- IWR1443BOOST
- Mounting brackets, screws, and nuts, to allow placing the PCB vertical
- Micro USB cable to connect to the PC

NOTE: *Not* included: 5 V, >2.5-A supply brick with 2.1-mm barrel jack (center positive). TI recommends using an external power supply that complies with applicable regional safety standards such as UL, CSA, VDE, CCC, PSE, and so on. The cable length of the power cord must be < 3 m.

1.3.2 mmWave Proximity Demo

TI provides sample demo codes to easily get started with the IWR1443 evaluation module and experience the functionality of the IWR1443 mmWave sensor. For details on getting started with these demos, see the [mmWave SDK User Guide](#).

⁽¹⁾ BoosterPack, LaunchPad are trademarks of Texas Instruments.

⁽²⁾ ARM is a registered trademark of ARM Limited.

⁽³⁾ Windows is a registered trademark of Microsoft Corporation.

2 Hardware

Figure 1 and Figure 2 show the front and rear views of the evaluation board, respectively.

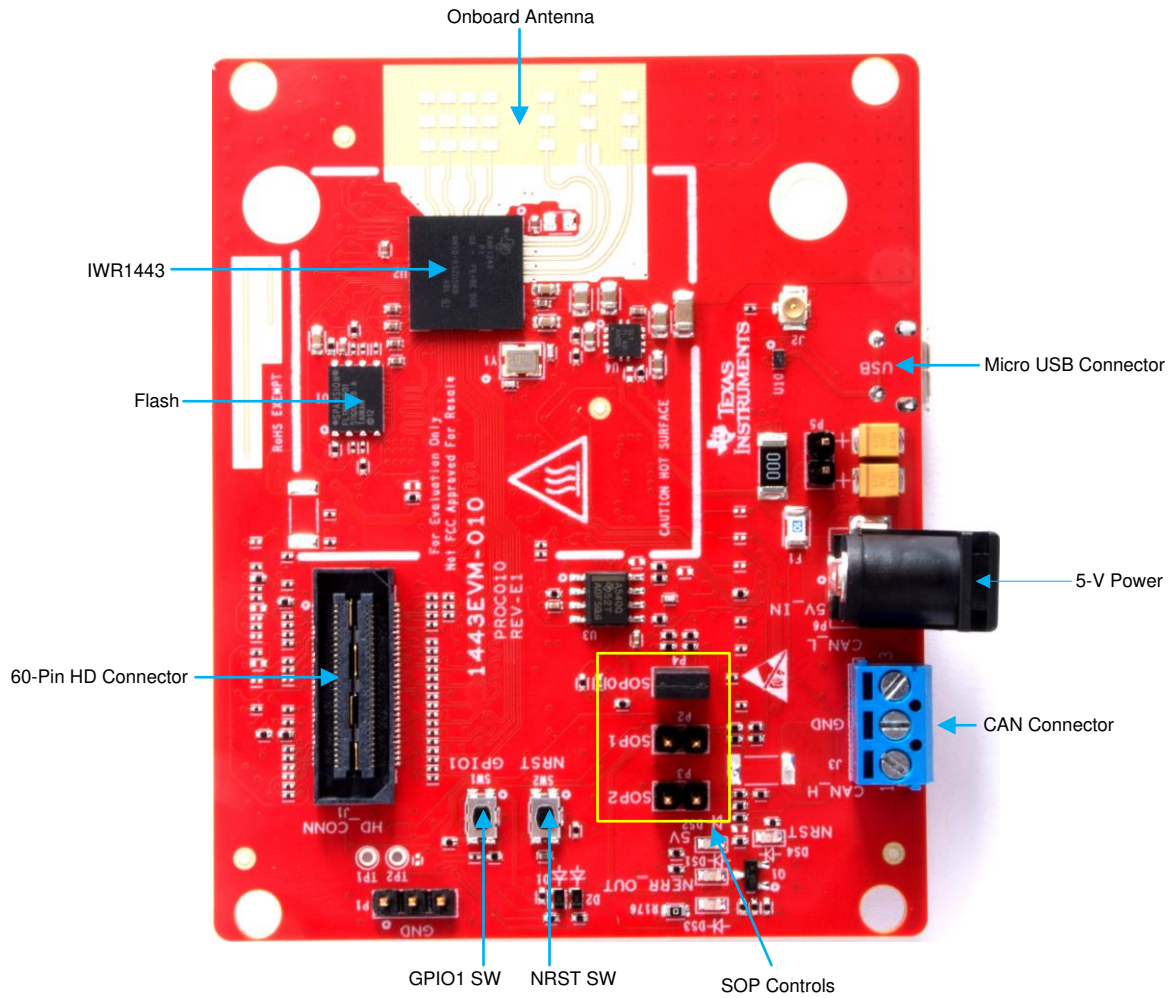

Figure 1. EVM Front View

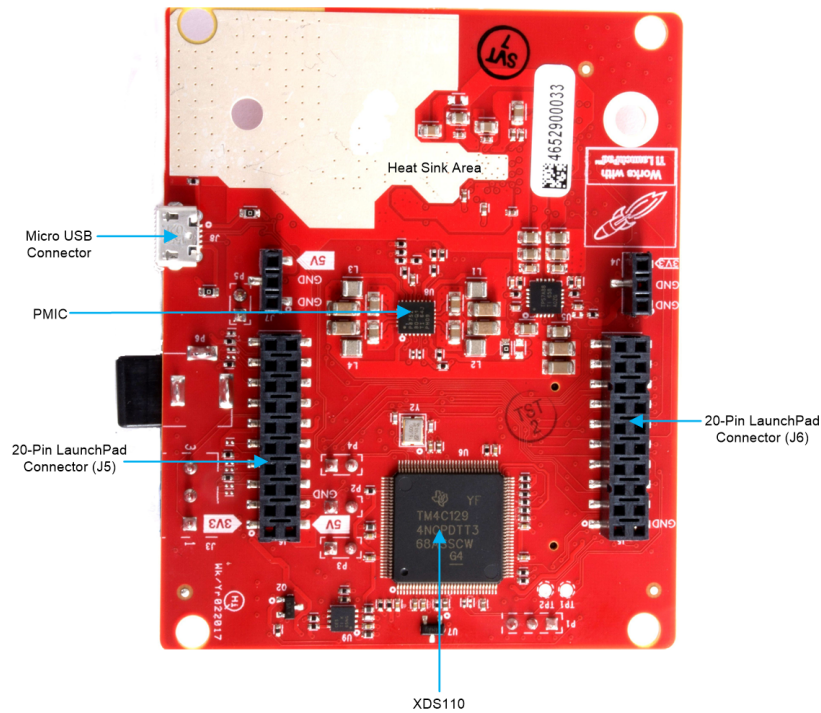
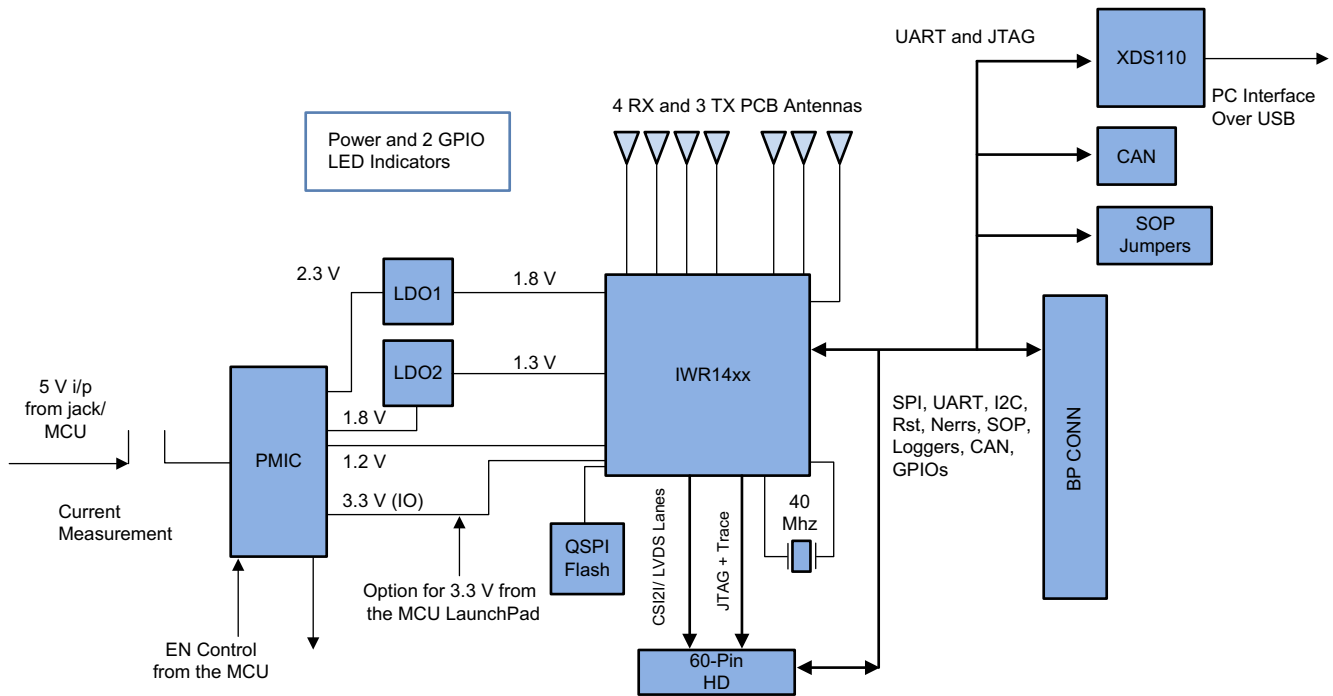

Figure 2. EVM Rear View

2.1 Block Diagram



Copyright © 2017, Texas Instruments Incorporated

Figure 3. IWR14xxBOOST Block Diagram

2.2 Connecting BoosterPack™ to LaunchPad™ or MMWAVE-DEVPACK

This BoosterPack can be stacked on top of the Launchpad, or the [MMWAVE-DEVPACK](#), using the two 20-pin connectors. The connectors do not have a key to prevent the misalignment of the pins or reverse connection. Therefore, ensure reverse mounting does not take place. On the IWR1443 BoosterPack, we have provided 3V3 marking near pin 1 (see [Figure 4](#)). This same marking is provided on compatible LaunchPads which must aligned before powering up the boards.

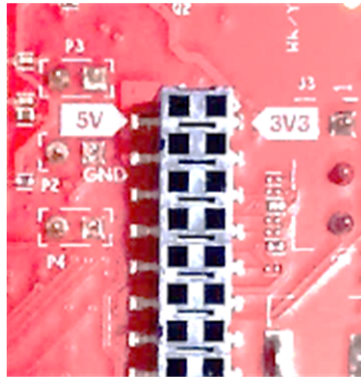

Figure 4. 3V3 and 5-V Mark on the LaunchPad™ (White Triangle)

2.3 Power Connections

The BoosterPack is powered by the 5-V power jack (5-A current limit). As soon as the power is provided, the NRST and 5-V LEDs glow, indicating that the board is powered up (see [Figure 5](#)).

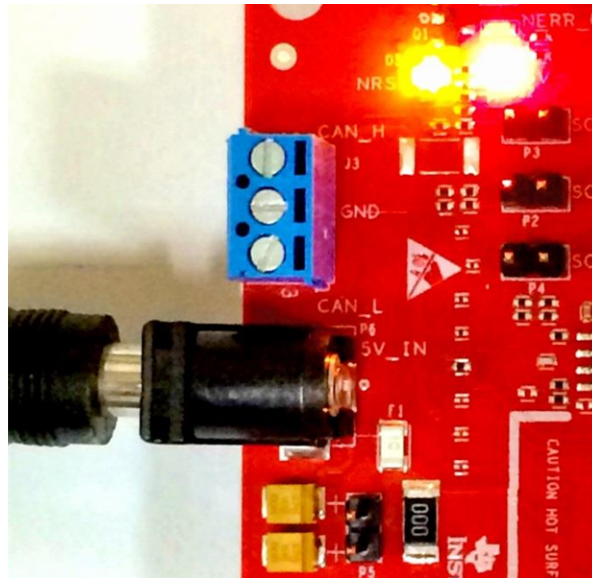

Figure 5. Power Connector

NOTE: After the 5-V power supply is provided to the EVM, TI recommends pressing the NRST switch (SW2) once to ensure a reliable boot up state.

2.4 Connectors

2.4.1 20-Pin BoosterPack™ Connectors

The BoosterPack has the standard LaunchPad connectors (J5 and J6) which enable the BoosterPack to be directly connected to all TI MCU LaunchPads (see [Table 1](#)). While connecting the BoosterPack to other LaunchPads, ensure the pin 1 orientation is correct by matching the 3V3 and 5-V signal marking on the boards (see [Figure 6](#)).

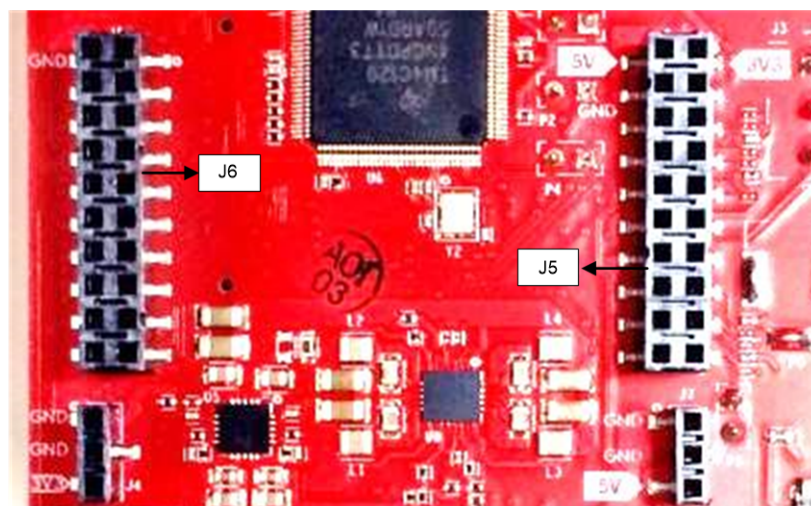

Figure 6. 20-Pin BoosterPack™ Connectors (J5 and J6)

Table 1 and Table 2 provide the connector-pin information.

Table 1. 20-Pin Connector Definition (J6)

Pin Number	Description	Pin Number	Description
1	AR_NERR_OUT	2	GND
3	AR_NERRIN	4	NC
5	AR_MCUCLKOUT	6	AR_CS1
7	NC	8	AR_GPIO_1
9	AR_MSS_LOGGER	10	AR_NRST_MCU
11	AR_WARMRST	12	AR_MOSI1
13	AR_BSS_LOGGER	14	AR_MISO1
15	MCU_SOP2	16	AR_HOSTINTR1
17	MCU_SOP1	18	AR_GPIO_2
19	MCU_SOP0	20	NC

Table 2. 20-Pin Connector Definition (J5)

Pin Number	Description	Pin Number	Description
1	MCU_3V3	2	MCU_5v (5V_IN)
3	NC	4	GND
5	AR_RS232TX	6	AR_ANATEST1
7	AR_RS232RX	8	AR_ANATEST2
9	AR_SYNC_IN	10	AR_ANATEST3
11	NC	12	AR_ANATEST4
13	AR_SPICLK1	14	PGOOD (onboard VIO)
15	AR_GPIO_0	16	PMIC_EN1
17	AR_SCL	18	AR_SYNC_OUT_SOP1
19	AR_SDA	20	AR_PMIC_CLKOUT_SOP2

- PGOOD – This signal indicates the state of the onboard VIO supply for the IWR device coming from the onboard PMIC. A high on the PGOOD signal (3.3 V) indicates that the supply is stable. Because the IOs are not failsafe, the MCU must ensure that it does not drive any IO signals to the IWR device before this IO supply is stable. Otherwise, there could be leakage current into the IOs.
- PMIC Enable – This signal goes onboard PMIC enable. The MCU can use this signal to completely shut down the PMIC and IWR device to save power. The power up of the PMIC takes approximately 5 ms once the Enable signal is released.

NOTE: To enable this feature, the R102 resistor must be populated on the EVM.

- ANA1/2/3/4 – These are inputs to the GPADCs (general purpose ADC) available on the IWR1443 device.

2.4.2 60-Pin High Density (HD) Connector

The 60-pin HD connector provides high speed CSI/LVDS data, and controls signals (SPI, UART, I2C, NRST, NERR, and SOPs) and JTAG debug signals (see [Table 3](#)). This connector can be connected to the MMWAVE-DEVPACK board and interface with the TSW1400 (see [Figure 7](#)).



Figure 7. High Density Connector (60 Pin)

Table 3. HD Connector Pin Definition

Pin Number	Description	Pin Number	Description
1	5 V	2	5V_IN
3	5 V	4	AR_TDO_SOP0
5	AR_TDI	6	AR_TCK
7	AR_CS1	8	AR_TMS
9	AR_SPICLK1	10	AR_HOSTINTR1
11	AR_MOSI1	12	AR_MISO1
13	PGOOD (onboard VIO)	14	AR_NERR_OUT
15	NC	16	AR_SYNC_IN
17	NC	18	GND
19	NC	20	AR_LVDS_VALIDP
21	NC	22	AR_LVDS_VALIDM
23	NC	24	GND
25	NC	26	AR_LVDSSCSI_FRCLKP
27	NC	28	AR_LVDSSCSI_FRCLKM
29	NC	30	GND
31	NC	32	AR_LVDSSCSI_3P
33	NC	34	AR_LVDSSCSI_3M
35	NC	36	GND
37	NC	38	AR_LVDSSCSI_2P
39	NC	40	AR_LVDSSCSI_2M
41	NC	42	GND
43	NC	44	AR_LVDSSCSI_CLKP

Table 3. HD Connector Pin Definition (continued)

Pin Number	Description	Pin Number	Description
45	NC	46	AR_LVDSSCSI_CLKM
47	NC	48	GND
49	NC	50	AR_LVDSSCSI_1P
51	AR_SDA	52	AR_LVDSSCSI_1M
53	AR_SCL	54	GND
55	AR_RS232RX	56	AR_LVDSSCSI_0P
57	AR_RS232TX	58	AR_LVDSSCSI_0M
59	AR_NRST_MCU	60	GND

PGOOD – This signal indicates that the state of the onboard VIO supply for the IWR device coming from the onboard PMIC. A high on the PGOOD signal (3.3 V) indicates the supply is stable. Because the I/Os are not failsafe, the MCU must ensure that it does not drive any I/O signals to the IWR device before this I/O supply is stable, to avoid leakage current into the I/Os.

2.4.3 CAN Interface Connector

The J3 connector provides the CAN_L and CAN_H signals (see [Figure 8](#)) from the onboard CAN transceiver (SN65HVDA540). These signals can be directly wired to the CAN bus.

Because the digital CAN signals (TX and RX) are muxed with the SPI signals on the IWR device, one of the two paths must be selected. To enable the CAN interface, the R11 and R12 resistors must be populated with 0 Ω, and the R4, R6, R28, and R63 resistors must be removed to disconnect the SPI path.

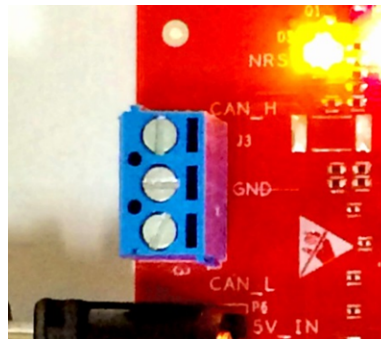

Figure 8. CAN Connector

2.5 PC Connection

Connectivity is provided using the micro USB connector over the onboard XDS110 (TM4C1294NCPDT) emulator. This connection provides the following interfaces to the PC:

- JTAG for CCS connectivity
- Control UART for flashing the onboard serial flash, downloading FW using RADAR studio, and getting application data sent over the UART
- MSS logger UART, which can be used to get MSS code logs on the PC

When the USB is connected to the PC the device manager recognizes the following COM ports, as shown in [Figure 9](#):

- XDS110 Class Application/User UART → the control UART port
- XDS110 Class Auxiliary Data port → the MSS logger port

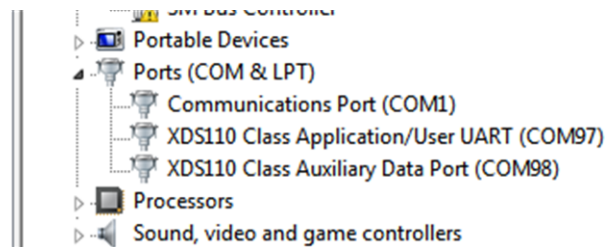

Figure 9. XDS110 Ports

If Windows® is unable to recognize the COM ports previously shown, install the emupack available [here](#)

[Table 4](#) lists the UART ports corresponding pin names on IWR1443 package.

Table 4. Pin Names

	Pin Name	Pin Number	Signal Name in Data Sheet	EVM Signal Reference
Control UART port TX	RS232_TX	N6	RS232_TX	AR_RS232TX
Control UART port RX	RS232_RX	N5	RS232_RX	AR_RS232RX
MSS logger port	SPI_CLK_2	R5	MSS_UARTB_TX	AR_MSS_LOGGER

2.5.1 Erasing Onboard Serial Flash

Before loading the code to the serial flash or connecting the board to RADAR Studio, TI recommends completely erasing the onboard serial flash. The instructions to erase the onboard serial flash are in the [mmWave SDK User Guide](#).

2.5.2 Connection With MMWAVE-DEVPACK

Users may be required to use the DevPack along with the BoosterPack for the following use cases:

- Connecting to RADAR studio. This tool provides capability to configure the mmWave front end from the PC. This tool is available in the [DFP package](#).
- Capturing high-speed LVDS data using the TSW1400 platform from TI. This device allows the user to capture raw ADC data over the high-speed debug interface and post process it in the PC. The RADAR Studio tool provides an interface to the TSW1400 platform as well, so that the front end configurations and data capture can be done using a single interface. Details on this board can be found at <http://www.ti.com/tool/tsw1400evm>

For details on these use cases, see the [mmWave-DevPack User Guide](#).

Mmwave SDK out-of-box demos do not require DevPack. For other labs, check the hardware requirements of the lab user guide.

2.6 Antenna

The BoosterPack includes onboard etched antennas for the four receivers and three transmitters, which enables tracking multiple objects with their distance and angle information. This antenna design enables estimation of both azimuth and elevation angles, which enables object detection in a 3-D plane (see [Figure 10](#)).

In the mmwave SDK, the antenna configuration is selected using bitmask. For example, 2 transmit antennas can be enabled through bitmask 0b101 (such as tx1 and tx3). The corresponding physical location of rx1 to rx4 and tx1 to tx3 and are labeled in [Figure 10](#).

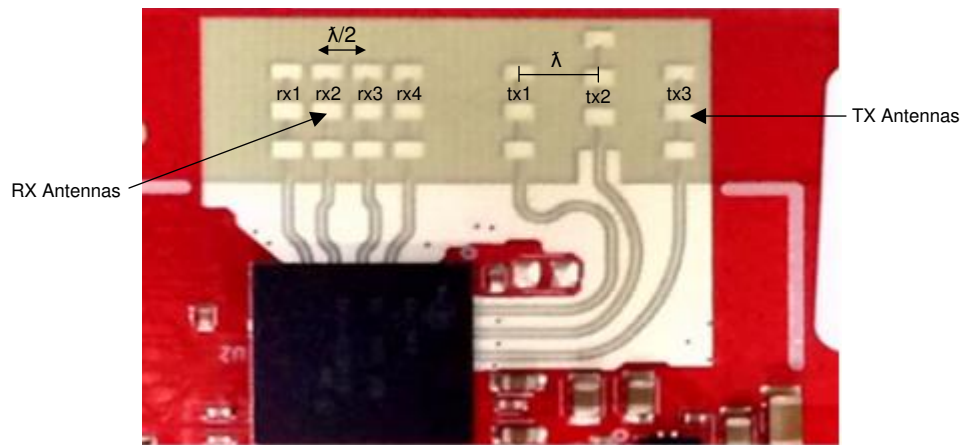

Figure 10. PCB Antenna

The antenna peak gain is > 10.5 dBi across the frequency band of 76 to 81 GHz. The radiation pattern of the antenna in the horizontal plan (H-plane) and elevation plan (E-plane) is as shown in [Figure 11](#) and [Figure 12](#).

The beamwidth of the antenna design can be determined from the radiation patterns. For example, at 78 GHz, based on 3-dB drop in the gain as compared to bore sight, the horizontal 3dB-beamwidth is approximately ± 28 degrees (see [Figure 11](#)), and elevation 3dB-beamwidth is approximately ± 14 degrees (see [Figure 12](#)). Similarly, the horizontal 6dB-beamwidth is approximately ± 50 degrees (see [Figure 11](#)) and the elevation 6dB-beamwidth is approximately ± 20 degrees (see [Figure 12](#)).

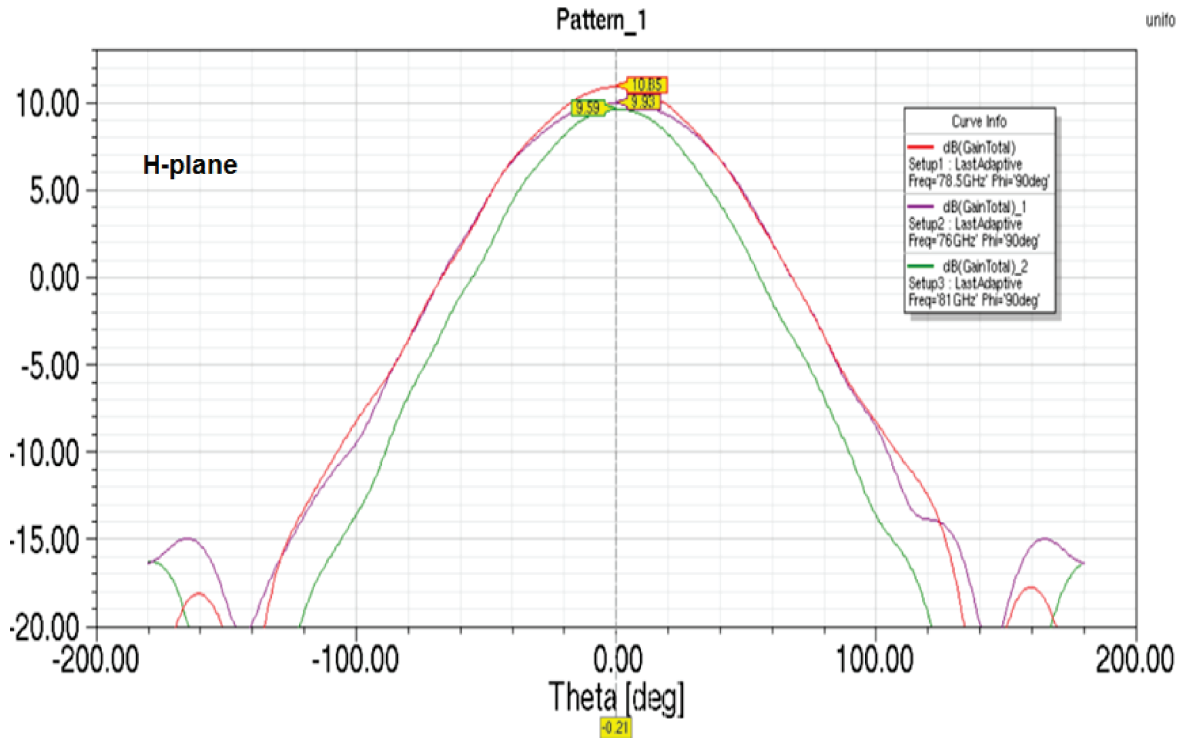

Figure 11. Antenna Pattern in H-Plane

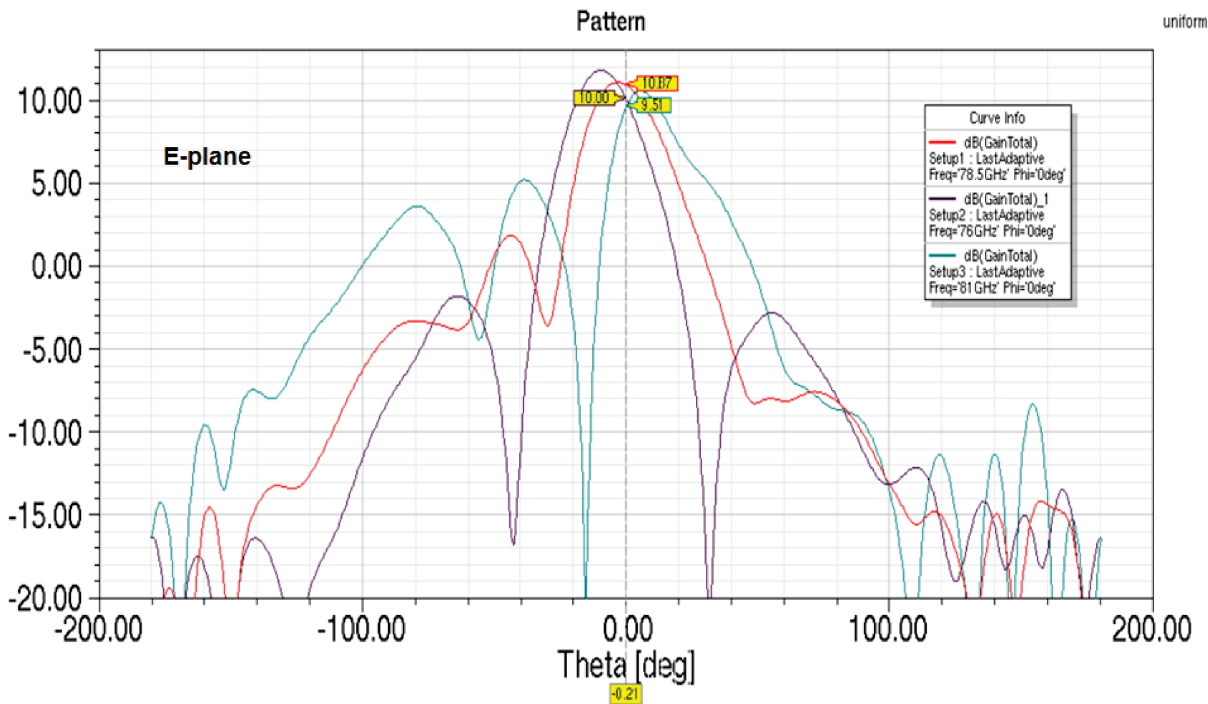

Figure 12. Antenna Pattern in E-Plane

2.7 Jumpers, Switches, and LEDs

2.7.1 Sense On Power Jumpers

The IWR1443 device can be set to operate in three different modes, based on the state of the SOP (sense on power) lines (see [Figure 13](#)). These lines are *only* sensed during boot up of the IWR device. The state of the device is described by [Table 5](#).

A closed jumper refers to a 1 and an open jumper refers to a 0 state of the SOP signal going to the IWR device.

Table 5. SOP Modes

Reference	Use	Comments
P3 (SOP 2)	SOP[2:0]	101 (SOP mode 5) = Flash programming
P2 (SOP 1)		001 (SOP mode 4) = Functional mode
P4 (SOP 0)		011 (SOP mode 2) = Dev mode



Figure 13. SOP Jumpers

2.7.2 Current Measurement

The P5 jumper enables measurement of the current being consumed by the reference design (IWR device + PMIC + LDOs) at the 5-V level.

To measure the current, R118 must be removed and a series ammeter can be put across the P5 pins (see [Figure 14](#)).



Figure 14. Current Measurement Point

2.7.3 Push Buttons and LEDs

Table 6 and Table 7 list the push button and LED uses, respectively.

Table 6. Push Buttons







Reference	Use	Comments	Image
SW2	RESET	<p>This button is used to reset the IWR1443 device. This signal is also brought out on the 20-pin connector and 60-pin HD connector, so that an external processor can control the IWR device.</p> <p>The onboard XDS110 can also use this reset.</p>	
SW1	GPIO_1	<p>When this button is pushed, the GPIO_1 is pulled to V_{cc}.</p>	

Table 7. LEDs

Reference	Color	Use	Comments	Image
DS2	Red	5-V supply indication	This LED indicates the presence of the 5-V supply.	
DS4	Yellow	nRESET	This LED is used to indicate the state of nRESET pin. If this LED is on, the device is out of reset. This LED glows only after the 5-V supply is provided.	
DS1	Red	NERR_OUT	This LED turns on if there is any hardware error in the IWR device.	
DS3	Yellow	GPIO_1	This LED turns on when the GPIO is logic-1.	

3 Design Files and Software Tools

The schematics, assembly, and BOM are available [here](#). The design and layout database files are available [here](#).

NOTE: Boards with a Rev 'C' sticker have had capacitor C56 (VBGAP decoupling capacitor) changed from 0.22 μF to 0.047 μF (part number CGA2B3X7R1H473K050BB). TI recommends that customers incorporate this change with an equivalent capacitor in their designs.

3.1 Software, Development Tools, and Example Codes

To enable quick development of an end application on the R4F core in the IWR1443, TI provides a software development kit (SDK) which includes demo codes, software drivers, an emulation package for debug, and so on. The SDK is available at [mmwave-sdk](#).

4 Mechanical Mounting of PCB

The field of view of the radar sensor is orthogonal to the PCB. The L-brackets provided with the IWR1443 EVM kit, along with the screws and nuts help in the vertical mounting of the EVM. [Figure 15](#) shows how the L-brackets can be assembled.

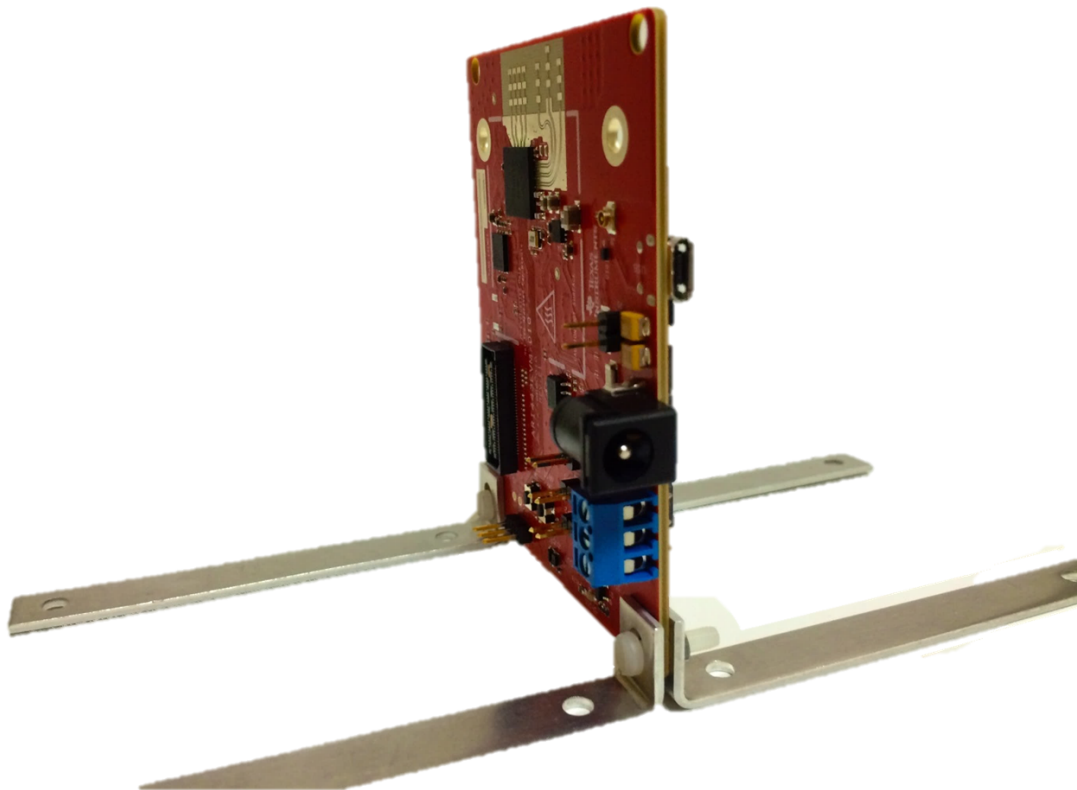

Figure 15. Vertical Assembly of the EVM

5 PCB Storage and Handling Recommendations

The immersion silver finish of the PCB provides a better high-frequency performance but is also prone to oxidation in an open environment. This oxidation causes the surface around the antenna region to blacken. To avoid this effect, store the PCB in an ESD cover and keep it at controlled room temperature with low humidity conditions. All ESD precautions must be taken while using and handling the EVM.

6 Regulatory Information

The IWR1443 evaluation module (IWR1443BOOST) is in compliance with Directive 2014/53/EU. The full text of TI's EU Declaration of Conformity is available [here](#).

The compliance has been verified in the operating bands 76 – 77 GHz and 77 – 81 GHz. Should the user choose to configure the EVM to operate outside the test conditions, it should be operated inside a protected or controlled environment, such as a shielded chamber. This evaluation board is intended only for development, and is not for use in an end product or part of an end product. Developers and integrators that incorporate the chipset in any end products are responsible for obtaining applicable regulatory approvals for such an end product.

The European RF exposure radiation limit is fulfilled if a minimum distance of 5 cm between the users body and the radio transmitter is respected.

NOTE: The EUT has been tested in the 76 – 77 GHz band (2 Tx at a time) at a maximum peak power of 26 dBm EIRP, and in the 77 – 81 GHz band (1 Tx at a time) with maximum peak power of 21 dBm EIRP across the temperature range of –20°C to 60°C.

7 Troubleshooting

EVM board power-up failure: refer to [Section 2.2](#) for desired power connections. Both the NRST and 5-V LEDs should glow brightly. When a non-functional or non-sufficient current capacity power supply is used with this EVM, the EVM LEDs do not turn on. Refer to [Section 2.7.3](#) for LED information.

Revision History

NOTE: Page numbers for previous revisions may differ from page numbers in the current version.

Changes from April 1, 2018 to May 30, 2020	Page
• Changed UART1 to Control UART.	11
• Added Pin Names table.	11
• Added Signal Name column to Pin Names table.	11
• Changed MSS Logger Port Pin Name from Reserved to SPI_CLK_2.	11
• Changed MSS Logger Port Signal Name from SPI_CLK_2 to MSS_UARTB_TX.	11
• Updated Connection With MMWAVE-DEVPACK section.	11
• Updated Antenna section.	12
• Updated PCB Antenna image.	12
• Added Note.	16

IMPORTANT NOTICE AND DISCLAIMER

TI PROVIDES TECHNICAL AND RELIABILITY DATA (INCLUDING DATASHEETS), DESIGN RESOURCES (INCLUDING REFERENCE DESIGNS), APPLICATION OR OTHER DESIGN ADVICE, WEB TOOLS, SAFETY INFORMATION, AND OTHER RESOURCES "AS IS" AND WITH ALL FAULTS, AND DISCLAIMS ALL WARRANTIES, EXPRESS AND IMPLIED, INCLUDING WITHOUT LIMITATION ANY IMPLIED WARRANTIES OF MERCHANTABILITY, FITNESS FOR A PARTICULAR PURPOSE OR NON-INFRINGEMENT OF THIRD PARTY INTELLECTUAL PROPERTY RIGHTS.

These resources are intended for skilled developers designing with TI products. You are solely responsible for (1) selecting the appropriate TI products for your application, (2) designing, validating and testing your application, and (3) ensuring your application meets applicable standards, and any other safety, security, or other requirements. These resources are subject to change without notice. TI grants you permission to use these resources only for development of an application that uses the TI products described in the resource. Other reproduction and display of these resources is prohibited. No license is granted to any other TI intellectual property right or to any third party intellectual property right. TI disclaims responsibility for, and you will fully indemnify TI and its representatives against, any claims, damages, costs, losses, and liabilities arising out of your use of these resources.

TI's products are provided subject to TI's Terms of Sale (www.ti.com/legal/termsofsale.html) or other applicable terms available either on ti.com or provided in conjunction with such TI products. TI's provision of these resources does not expand or otherwise alter TI's applicable warranties or warranty disclaimers for TI products.

Mailing Address: Texas Instruments, Post Office Box 655303, Dallas, Texas 75265
Copyright © 2020, Texas Instruments Incorporated