

PMP15002 Test Results

Note that this reference design is not an orderable device from TI, but shows the performance of a UCC28704/UCC24636 in a constant voltage/ constant current controller in a typical 15-W USB adapter application.

Contents

1	Photos	2
2	Design Features	2
3	Electrical Characteristics	2
	3.1 Electrical Performance Specifications	2
	3.2 Efficiency & No-Load Power Consumption.....	3
	3.3 V-I Curve	5
	3.4 Turn-on Delay Time	6
	3.5 Startup Waveforms	7
	3.6 Ripple and Noise	8
	3.7 Dynamic Response.....	10
	3.8 Switching Node Waveforms.....	12
4	EMI Test	13
	4.1 Conducted EMI	13
	4.2 Radiated EMI.....	13
5	Thermal Test	15
6	Schematic	17
7	Key Design Notes	18
	7.1 Design Goal Parameters.....	18
	7.2 Design Tips.....	18

1 Photos

The photographs below show the PMP15002 prototype assembly.



Top View



Bottom View

2 Design Features

- Designed using UCC28704, a simple and low cost CC-CV primary side regulated Flyback controller eliminating Optical Coupler
- Quasi-resonant/DCM Flyback with Synchronous Rectification
- <75mW No-load power consumption
- high efficiency over entire operating range: DOE VI and CoC V5 tier 2 Compliant at 150 mΩ cable end
- Fully tested and passed EN55022 Class B Conducted & Radiated EMI

3 Electrical Characteristics

3.1 Electrical Performance Specifications

PARAMETER	TEST CONDITIONS	MIN	NOM	MAX	UNITS
Input Characteristics					
Voltage range, V_{IN}		85	115/230	265	V_{RMS}
Line frequency		47	60/50	63	Hz
No-load power consumption				75	mW
Output Characteristics (Output voltage was measured at 100 mΩ cable end)					
Output voltage, V_{out}	$V_{INmin} \leq V_{IN} \leq V_{INmax}, 0A \leq I_{OUT} \leq I_{OUTmax}$	4.85	5	5.15	V
Output load current, CV mode, I_{OUTMAX}	$V_{INmin} \leq V_{IN} \leq V_{INmax}$	3.2	3.3	3.4	A
Output voltage regulation	Line Regulation: $V_{INmin} \leq V_{IN} \leq V_{INmax}, I_{OUT} = I_{OUTmax}$			3	%
	Load Regulation: $0A \leq I_{OUT} \leq I_{OUTmax}$			3	%
Output voltage ripple	$V_{INmin} \leq V_{IN} \leq V_{INmax}, 0A \leq I_{OUT} \leq I_{OUTmax}$			150	mV
Output over current, I_{OCC}	$V_{INmin} \leq V_{IN} \leq V_{INmax}$	3.3		3.5	A
Minimum output	$V_{INmin} \leq V_{IN} \leq V_{INmax}, I_{OUT} = I_{OCC}$	2.45	2.6	2.75	V

voltage, CC mode					
Brown-out protections	$I_{OUT} = I_{OUTmax}$		66		V_{RMS}
Transient response undershoot	$I_{OUT} = 0\text{ A to }0.5\text{A load transient}$	4.7			V
System Characteristics					
Switching frequency, fsw		1.2		55	kHz
Average efficiency	25%, 50%, 75%, 100% load average at nominal input voltages; Output voltage was measured at board end		88		%
Operating temperature			25		°C
Conducted EMI	Output floating	EN 55022 B and FCC PART 15 B			
Radiated EMI	Output floating	EN 55022 B and FCC PART 15 B			

3.2 Efficiency & No-Load Power Consumption

Both the U.S. Department of Energy Level VI and European Union code of conduct (CoC) Version 5.0 Tier 2 went into effect in 2016, and set higher efficiency standards for power supplies than ever before.

The efficiency of this PMP15002 design can meet COC Tier2 and DOE VI even with 150mΩ cable.

3.2.1 Remark:

The nominal output of PMP15002 at 150 mΩ cable end is 5V/3A

COC Version 5.0 Tier 2 Compliance for 5V/3A:

Average efficiency: $\geq 0.0834 \cdot \ln(5 \cdot 3) - 0.0011 \cdot (5 \cdot 3) + 0.609 = 81.84\%$

Efficiency at 10% load: $\geq 0.0834 \cdot \ln(5 \cdot 3) - 0.00127 \cdot (5 \cdot 3) + 0.518 = 72.48\%$

No-Load Power Consumption: $\leq 75\text{mW}$

DOE Level VI Compliance for 5V/3A:

Average efficiency: $\geq 0.0834 \cdot \ln(5 \cdot 3) - 0.0014 \cdot (5 \cdot 3) + 0.609 = 81.39\%$

*Average efficiency is the simple arithmetic average of efficiency measurements made at 25%, 50%, 75%, 100% of full rated output current in active mode

3.2.2 Chart

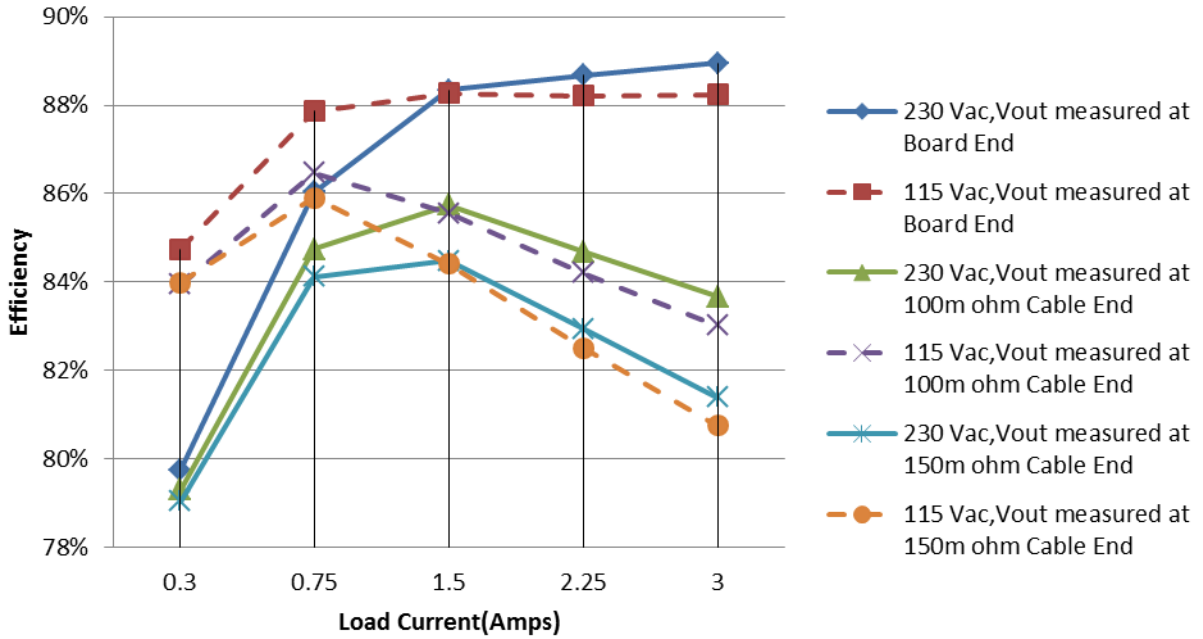

3.2.3 No-Load Power Consumption

Vin (Vac)	Input Power (mW)
90	40.7
115	42.4
132	43.8
180	48.5
230	56.9
265	70

3.2.4 Efficiency Data

Vout was measured at board end.

Vin	PIN (W)	Vout (V)	Iout (A)	Load(%)	EFFICIENCY	Avg. Eff.	COC V5 Tier2
230 Vac, 50 Hz	1.869	4.982	0.299	10%	79.75%	88.00%	81.84%
	4.391	5.044	0.749	25%	86.04%		
	8.709	5.134	1.499	50%	88.35%		
	13.233	5.218	2.249	75%	88.68%		
	17.848	5.294	2.998	100%	88.95%		
115 Vac, 60 Hz	1.759	4.983	0.299	10%	84.75%		72.48%

	4.309	5.054	0.749	25%	87.86%	88.15%	81.84%
	8.719	5.135	1.499	50%	88.27%		
	13.3	5.217	2.249	75%	88.21%		
	18.0	5.294	2.998	100%	88.24%		

Vout was measured at 100 mΩ cable end

Vin	PIN (W)	Vout (V)	Iout (A)	Load(%)	EFFICIENCY	Avg. Eff.	COC V5 Tier2
230 Vac, 50 Hz	1.869	4.954	0.299	10%	79.30%	84.71%	81.84%
	4.391	4.968	0.749	25%	84.74%		
	8.703	4.980	1.499	50%	85.75%		
	13.238	4.986	2.249	75%	84.68%		
	17.853	4.982	2.998	100%	83.66%		
115 Vac, 60 Hz	1.766	4.953	0.299	10%	83.95%	84.81%	81.84%
	4.311	4.977	0.749	25%	86.47%		
	8.721	4.979	1.499	50%	85.55%		
	13.303	4.982	2.249	75%	84.21%		
	17.982	4.979	2.998	100%	83.02%		

Vout was measured at 150 mΩ cable end

Vin	PIN (W)	Vout (V)	Iout (A)	Load(%)	EFFICIENCY	Avg. Eff.	COC V5 Tier2
230 Vac, 50 Hz	1.869	4.938	0.299	10%	79.03%	83.23%	81.84%
	4.391	4.932	0.749	25%	84.12%		
	8.709	4.910	1.499	50%	84.48%		
	13.233	4.881	2.249	75%	82.95%		
	17.848	4.845	2.998	100%	81.39%		
115 Vac, 60 Hz	1.759	4.938	0.299	10%	83.99%	83.39%	81.84%
	4.309	4.942	0.749	25%	85.91%		
	8.719	4.911	1.499	50%	84.41%		
	13.3	4.880	2.249	75%	82.51%		
	18.0	4.845	2.998	100%	80.75%		

3.3 V-I Curve

Vout was measured at 100 mΩ cable end

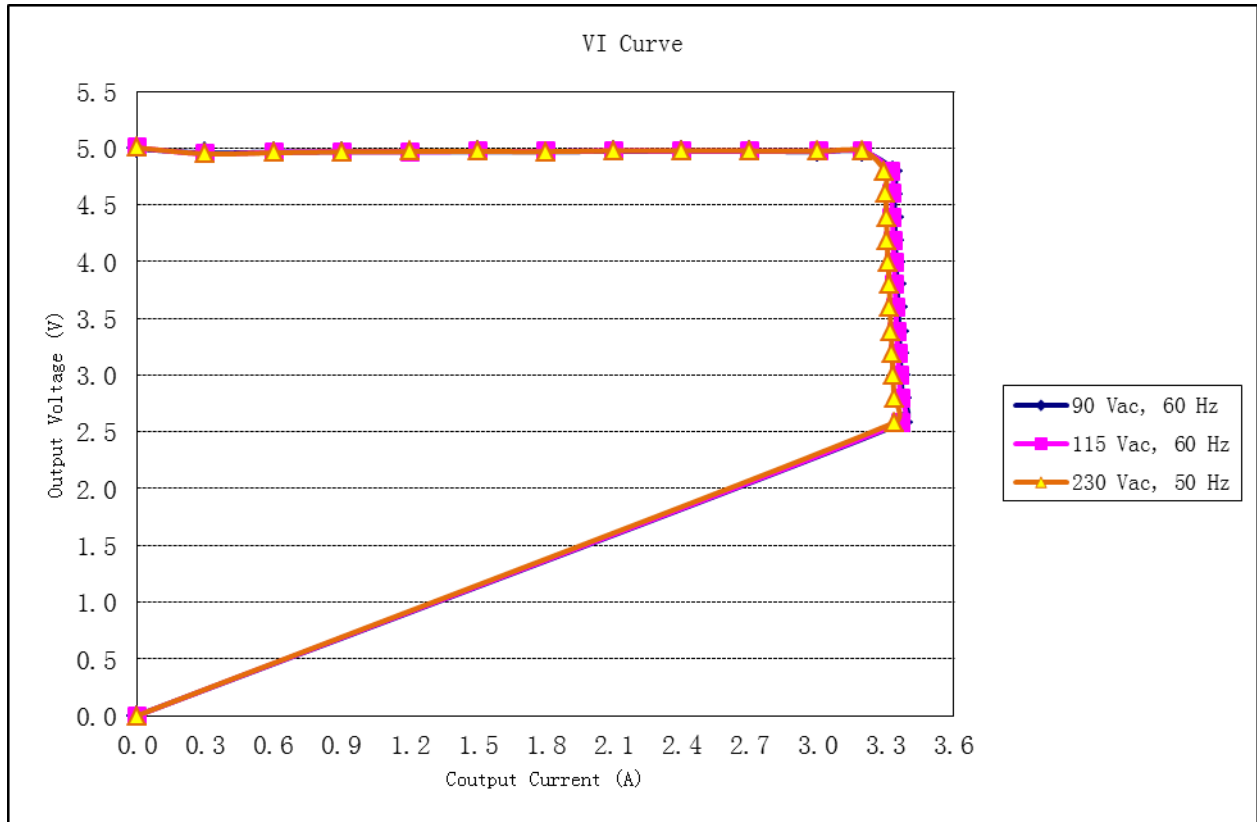

3.4 Turn-on Delay Time

Input voltage	Output current	Turn on delay time
90 Vac, 47 Hz	0 A	1.97 s
90 Vac, 47 Hz	3 A	1.92 s

*Output Voltage experience a 10% overshoot during a no-load start up. This overshoot is a by-product of enhanced load transient scheme of UCC28704 which enable a better response of load transient. Refer to section 8.2.3 of UCC28704 datasheet for the detail explanation. V_{OCV} is the regulated output voltage.

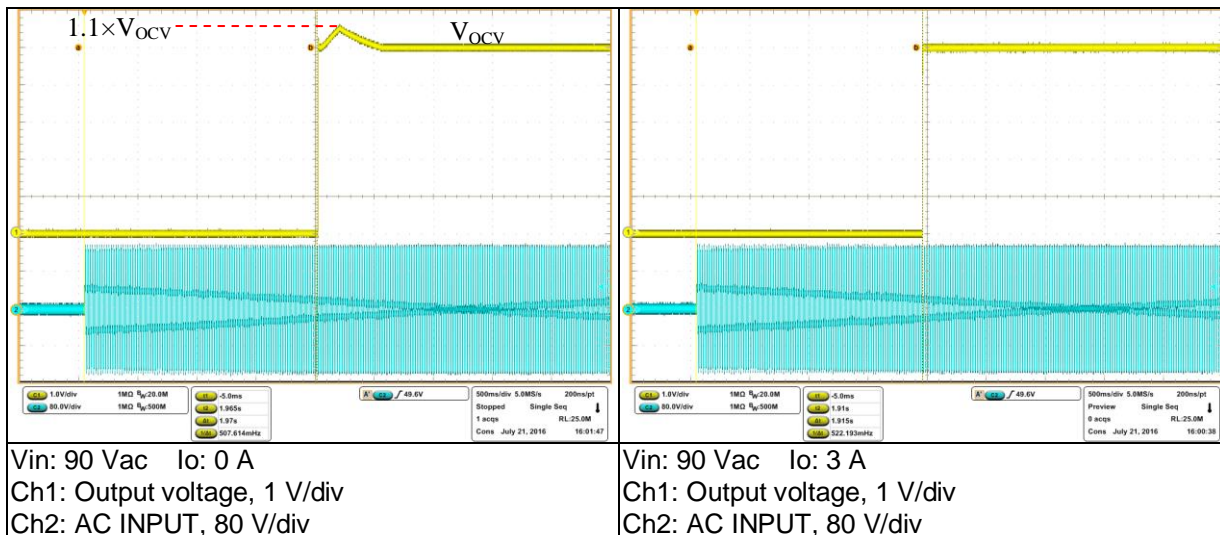

3.5 Startup Waveforms

*Output Voltage experience a 10% overshoot during a no-load start up. This overshoot is a by-product of enhanced load transient scheme of UCC28704 which enable a better response of load transient. Refer to section 8.2.3 of UCC28704 datasheet for the detail explanation.

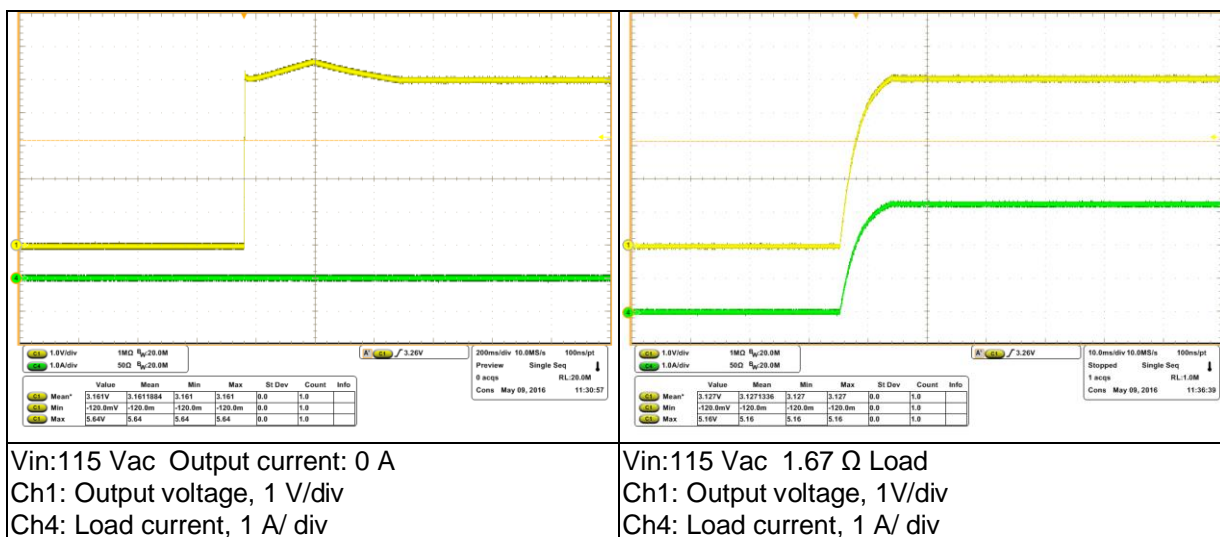

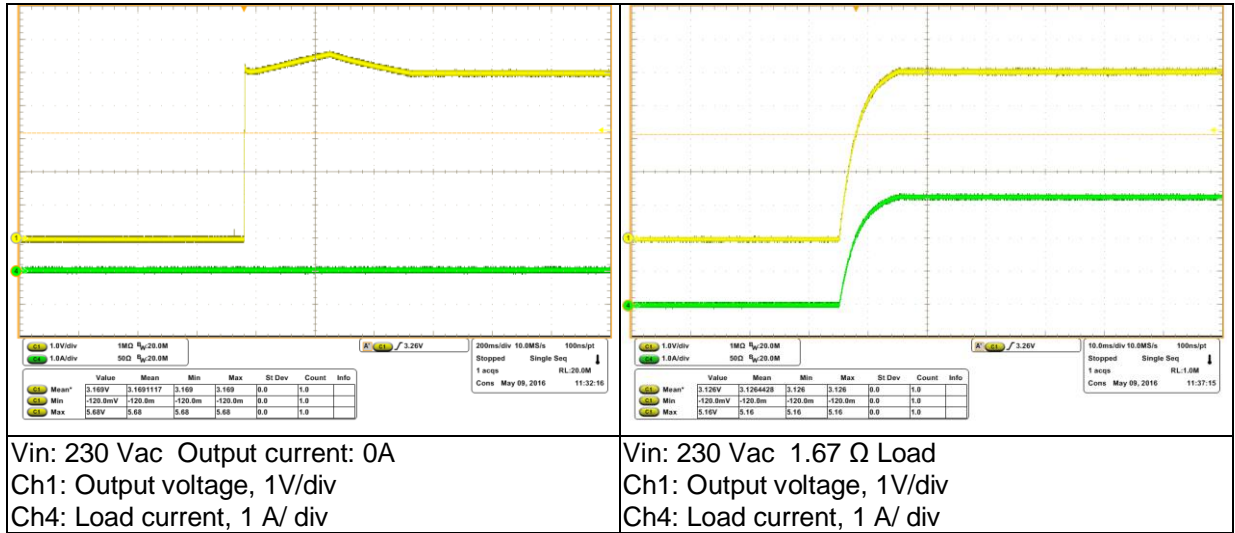

3.6 Ripple and Noise

Measured results taken at the end of a 100 m Ω cable with a 10 μ F Aluminum electrolytic capacitor in parallel with a 0.1 μ F ceramic capacitor.

The ripple and noise voltage should be less than 150mV at full input range and load range.

Io(A)	Ripple and Noise (mV)			
	265 Vac, 50 Hz	230Vac, 50Hz	115 Vac, 60 Hz	85 Vac, 50 Hz
0.0	14.4	19.2	18	18
0.1	16.8	19.2	19.2	19.2
0.2	26.4	36	63.6	76.8
0.3	26.4	27.6	72	91.2
0.4	55.2	74.4	93.6	105.6
0.5	70.8	88.8	118.8	110.4
0.6	78	104.4	117.6	45.6
0.7	96	135.6	54	50.4
0.8	40.8	111.6	46.8	45.6
0.9	40.8	58.8	50.4	45.6
1.0	46.8	57.6	55.2	55.2
1.1	44.4	51.6	50.4	56.4
1.2	50.4	54	54	54
1.3	49.2	58.8	61.2	57.6
1.4	51.6	57.6	62.4	60
1.5	54	61.2	62.4	61.2
1.6	58.8	61.2	63.6	63.6
1.7	60	66	64.8	63.6
1.8	62.4	69.6	64.8	68.4

1.9	62.4	67.2	70.8	68.4
2.0	63.6	68.4	67.2	68.4
2.1	60	68.4	67.2	67.2
2.2	61.2	68.4	66	69.6
2.3	57.6	67.2	67.2	73.2
2.4	63.6	66	67.2	67.2
2.5	60	66	67.2	69.6
2.6	62.4	64.8	68.4	69.6
2.7	56.4	66	66	68.4
2.8	61.2	66	64.8	66
2.9	58.8	66	66	67.2
3.0	61.2	68.4	66	69.6

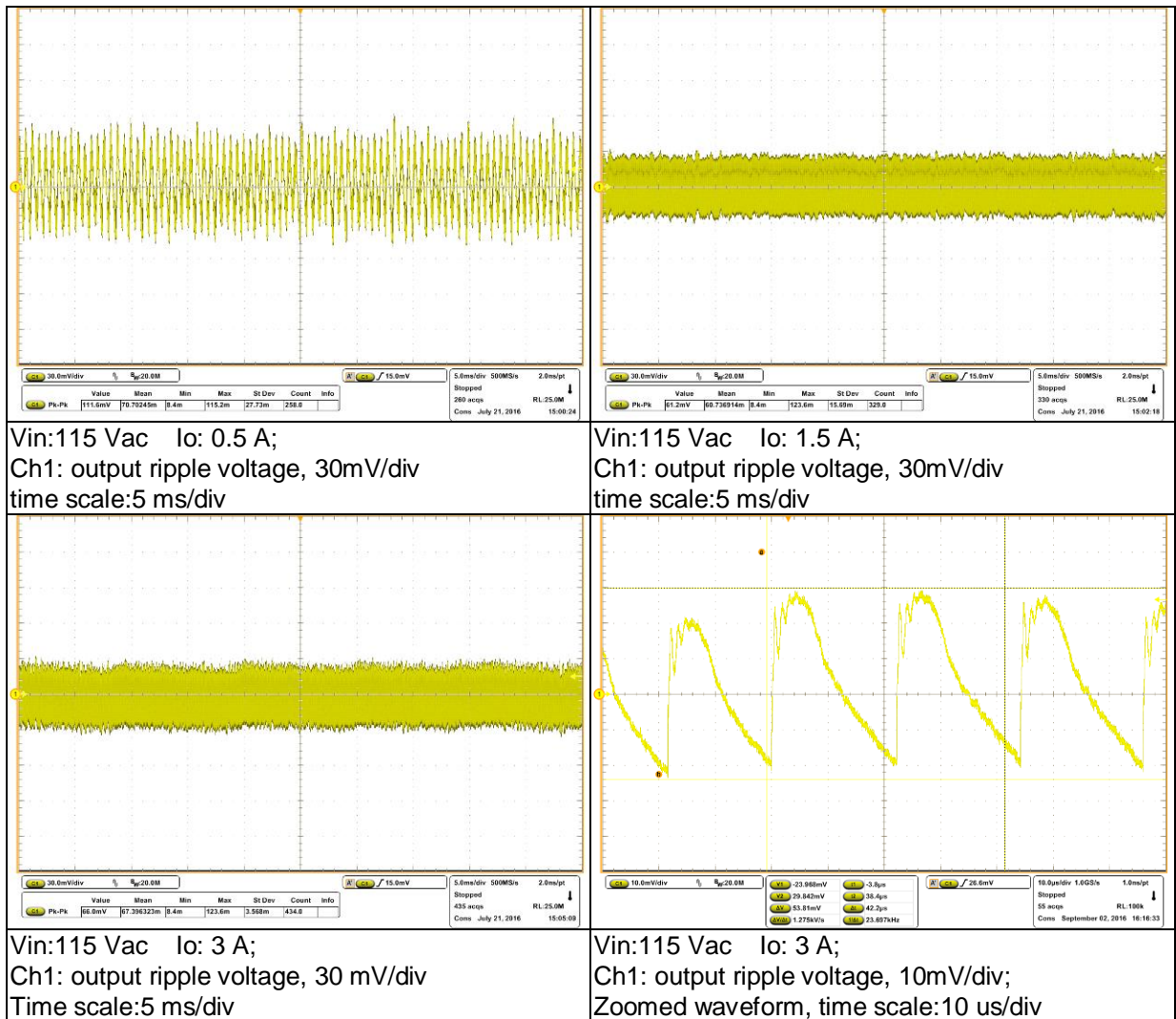

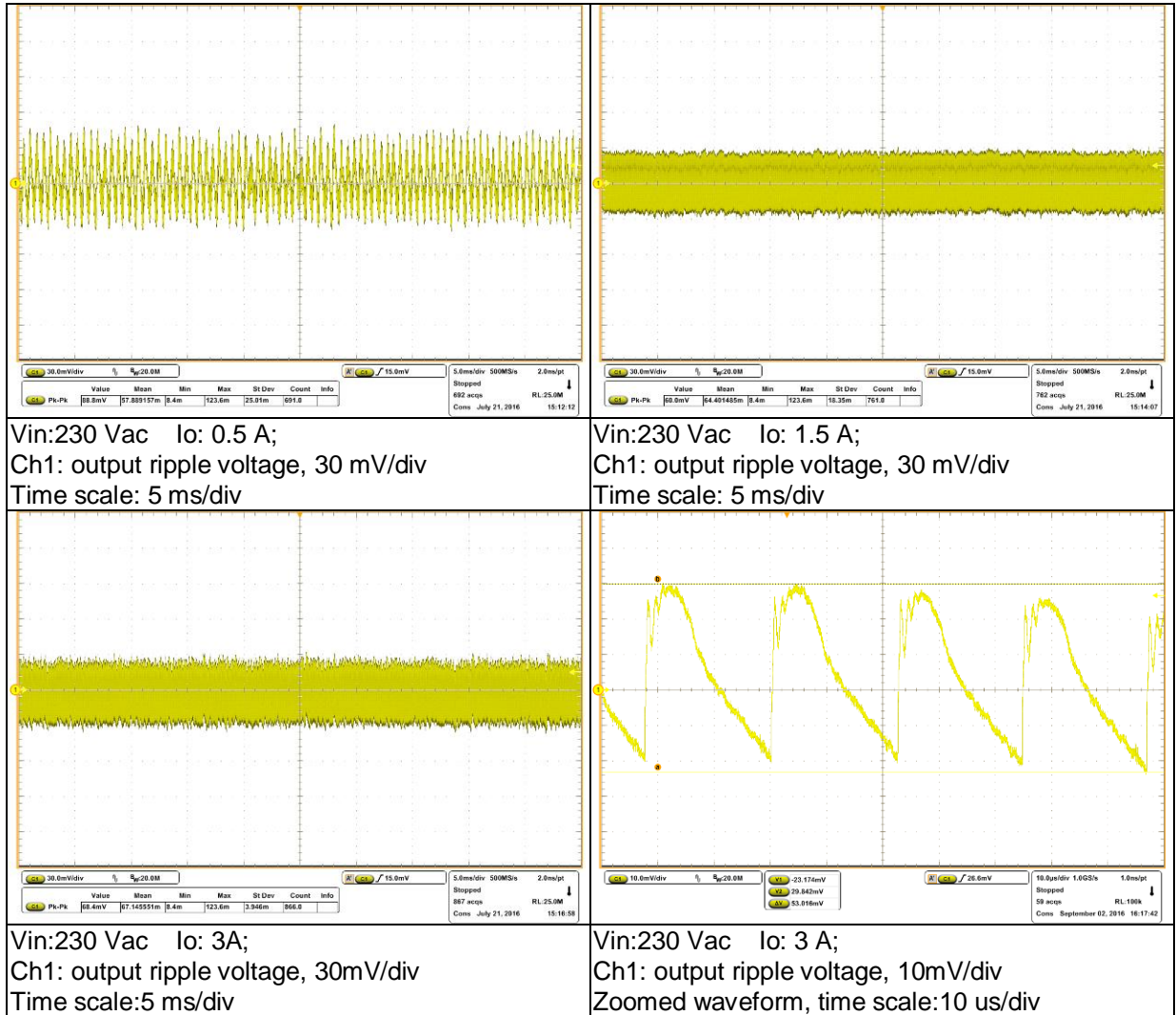

3.7 Dynamic Response

Output voltage was measured at 100mΩ cable end

Input voltage	Output current	Min voltage (V)	Max voltage (V)	Mean (V)
115 Vac, 60 Hz	0~500 mA	4.72	5.12	4.97
115 Vac, 60 Hz	20%-50% of full load	4.72	5.16	4.954
115 Vac, 60 Hz	10%-90% of full load	4.56	5.32	4.948
230 Vac, 50 Hz	0~500 mA	4.72	5.12	4.973
230 Vac, 50 Hz	20%-50% of full load	4.72	5.16	4.953
230 Vac, 50 Hz	10%-90% of full load	4.56	5.36	4.952

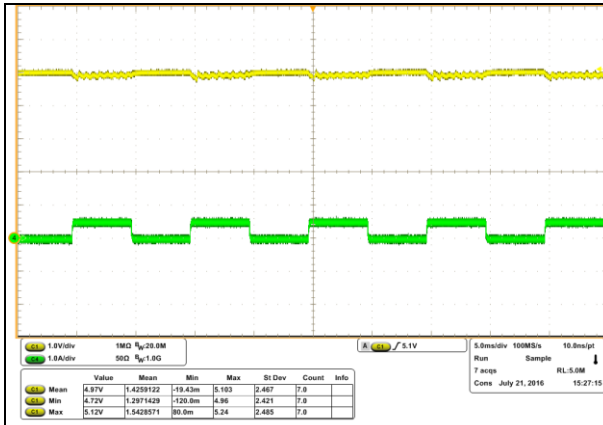

Vin:115 Vac test condition: 0-500mA, 1A/us,
10ms cycle
Ch1: output voltage
Ch4: output current

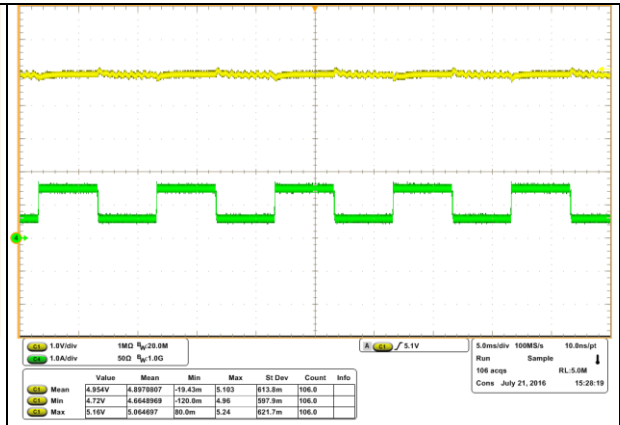

Vin:115 Vac test condition: 20%-50% of full load,
1A/us, 10ms cycle
Ch1: output voltage
Ch4: output current

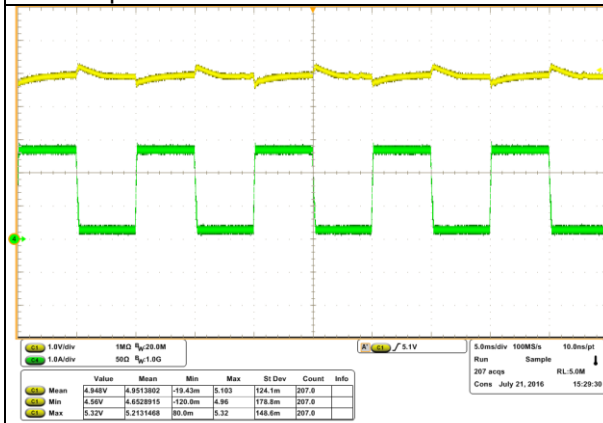

Vin:115 Vac test condition: 10%-90% of full load,
1A/us, 10ms cycle
Ch1: output voltage
Ch4: output current

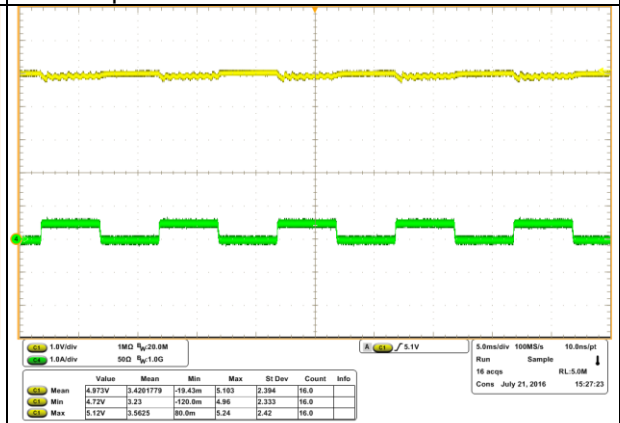

Vin:230 Vac test condition: 0-500mA, 1A/us,
10ms cycle
Ch1: output voltage
Ch4: output current

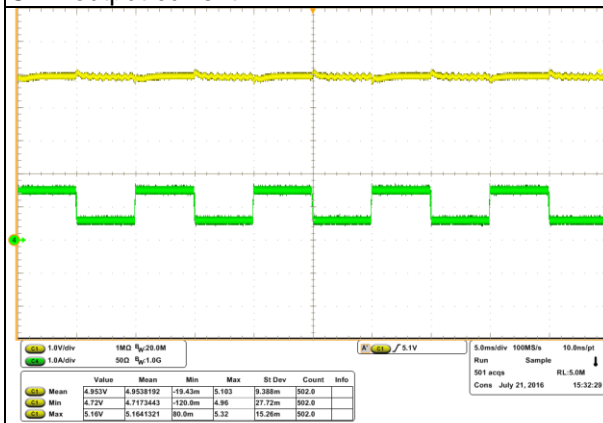

Vin:230 Vac test condition: 20%-50% of full load,
1A/us, 10ms cycle
Ch1: output voltage
Ch4: output current

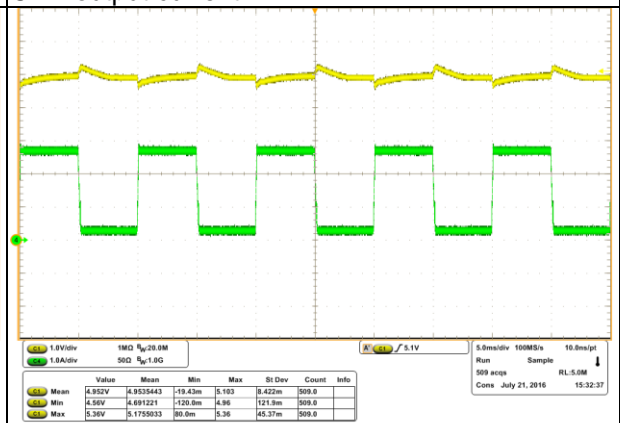

Vin:230 Vac test condition: 10%-90% of full load,
1A/us, 10ms cycle
Ch1: output voltage
Ch4: output current

3.8 Switching Node Waveforms

3.8.1 85 Vac, 60 Hz Input, 3 A output

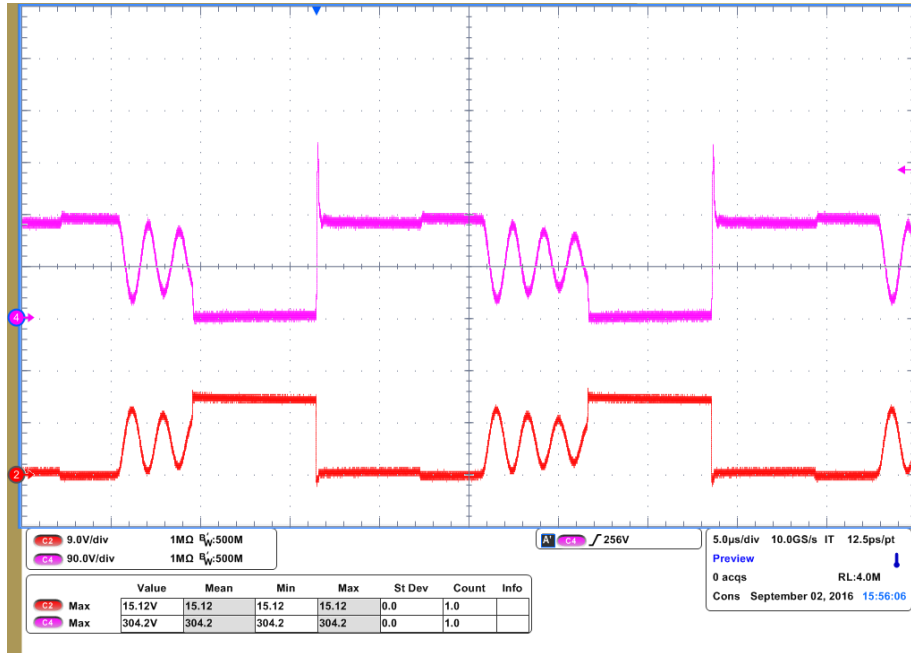

Ch2: Output Rectifier MOSFET drain to source; Ch4: Primary MOSFET drain to source

3.8.2 265 Vac, 60 Hz Input, 3 A output

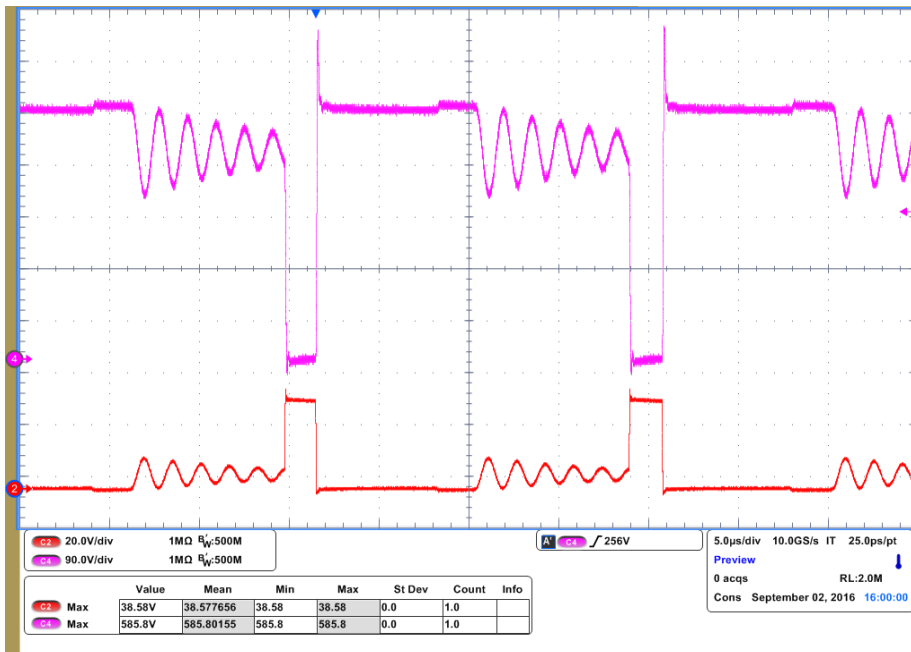

Ch2: Output Rectifier MOSFET drain to source; Ch4: Primary MOSFET drain to source

4 EMI Test

4.1 Conducted EMI

Note: 1.67 Ω resistive load, floating output

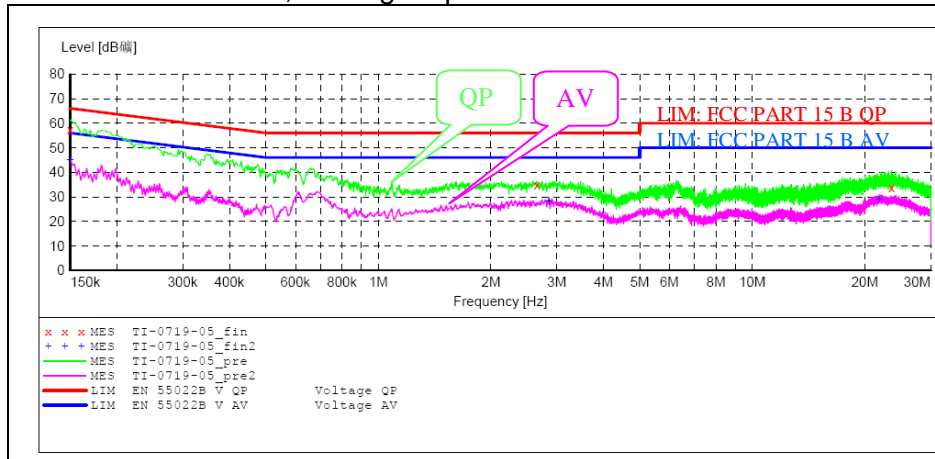

Vin: 120 Vac, 60 Hz

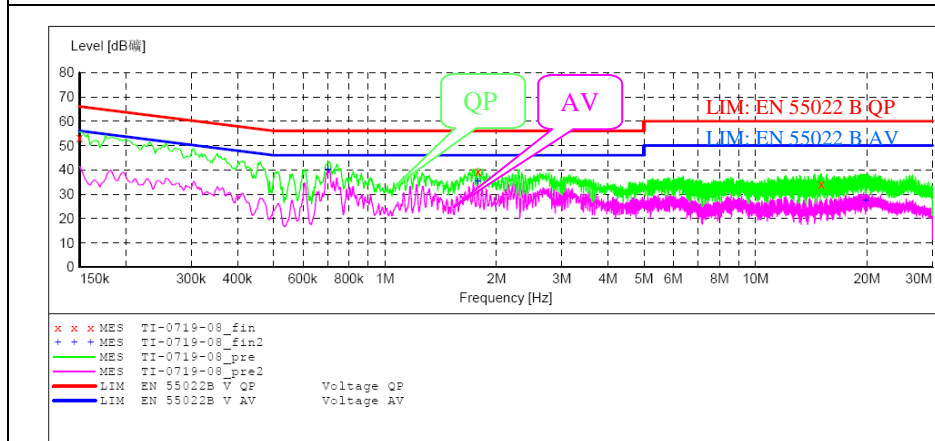

Vin: 230 Vac, 60 Hz

4.2 Radiated EMI

Note: 1.67 Ω resistive load, floating output

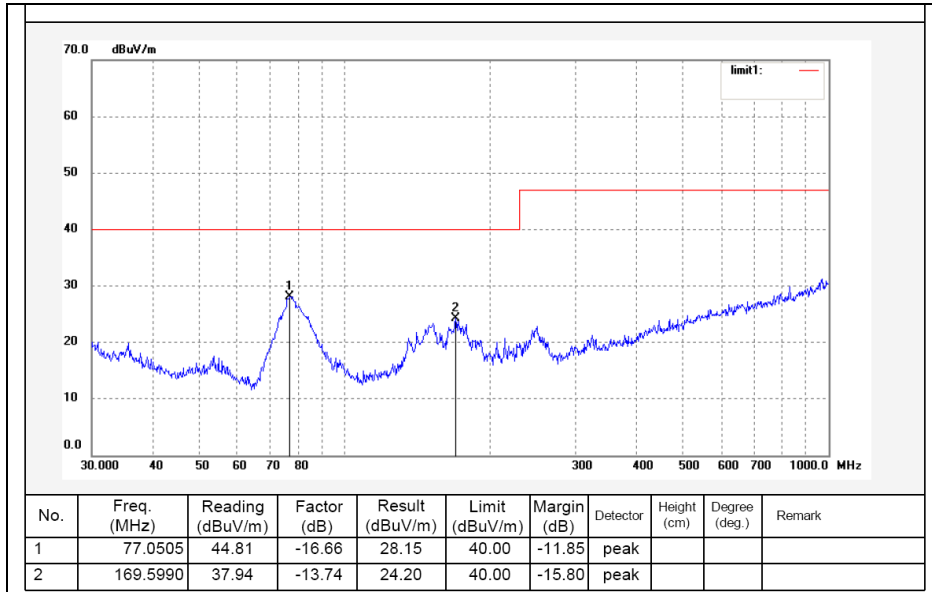

Vin: 120 Vac, 60 Hz; Polarization: Horizontal

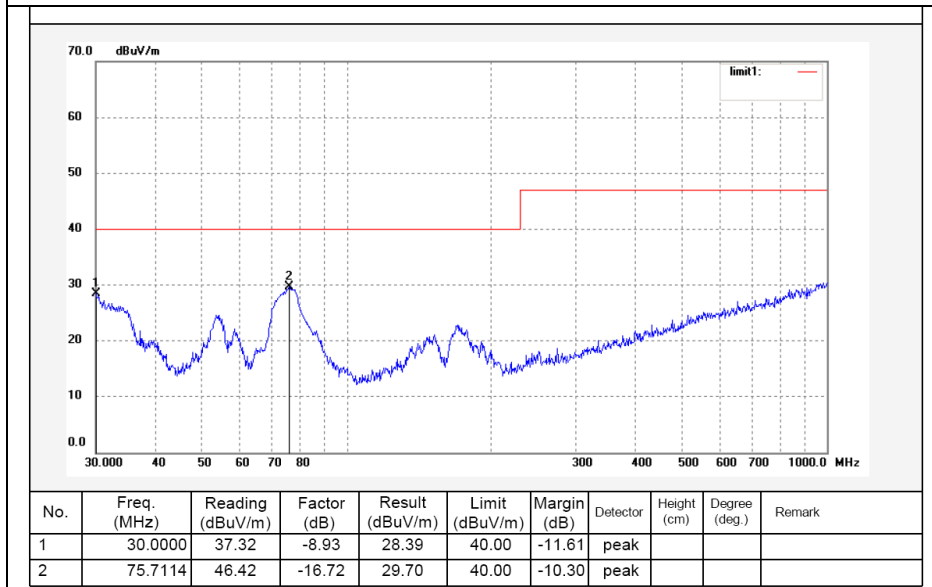

Vin: 120 Vac, 60 Hz; Polarization: Vertical

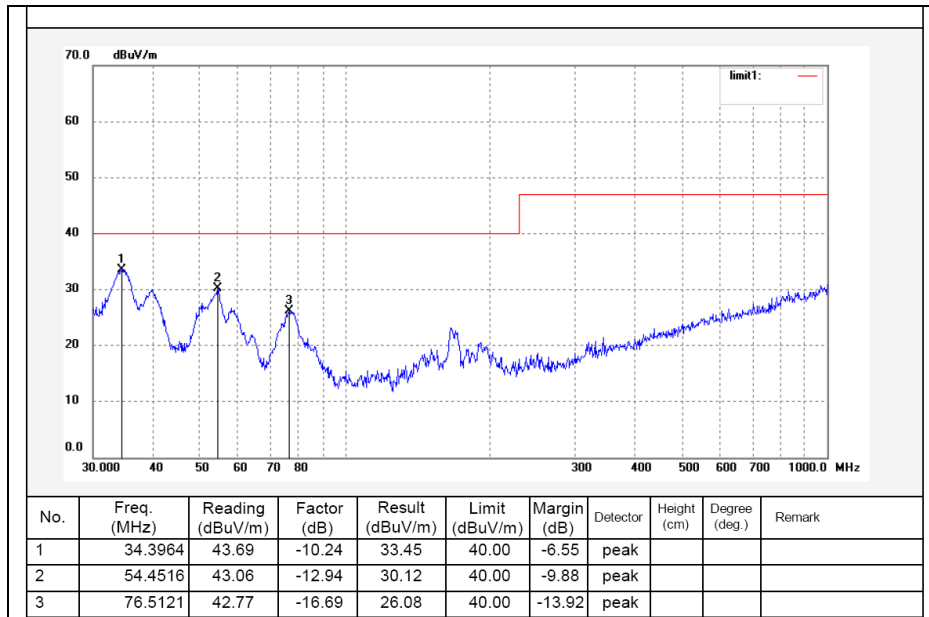

Vin: 230 Vac, 50 Hz; Polarization: Horizontal

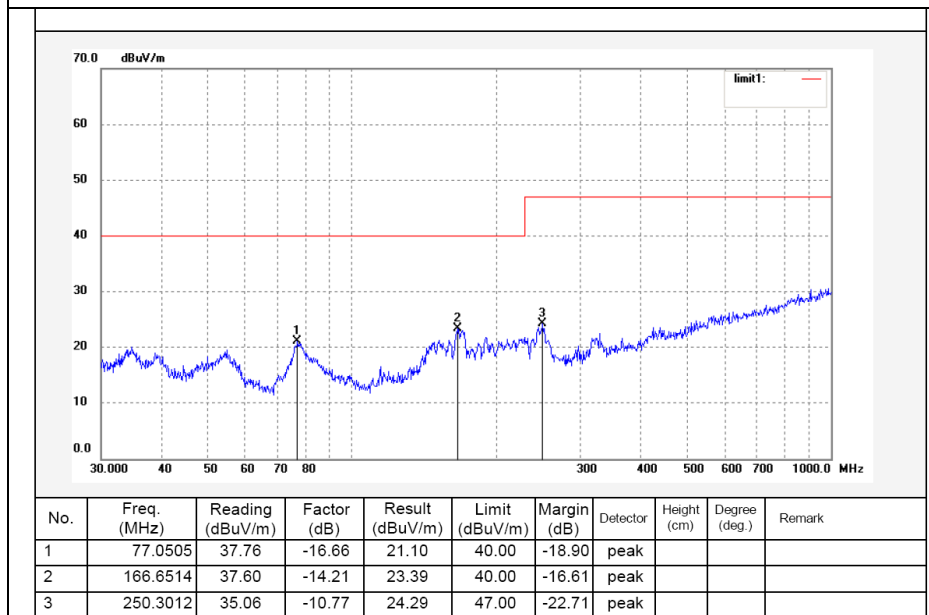

Vin: 230 Vac, 50 Hz; Polarization: Vertical

5 Thermal Test

Open frame, ambient temperature 25°C, No air flow

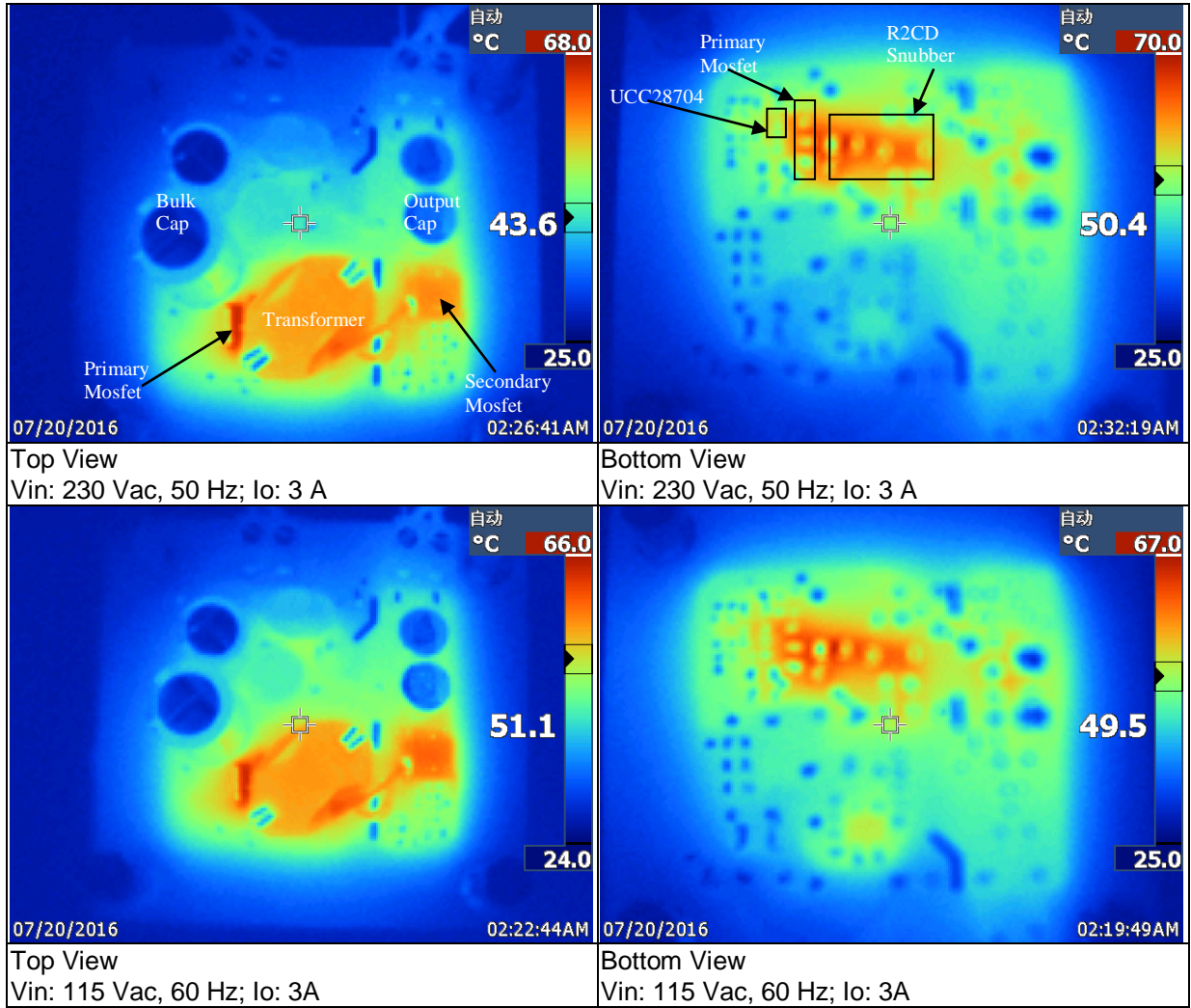

6 Schematic

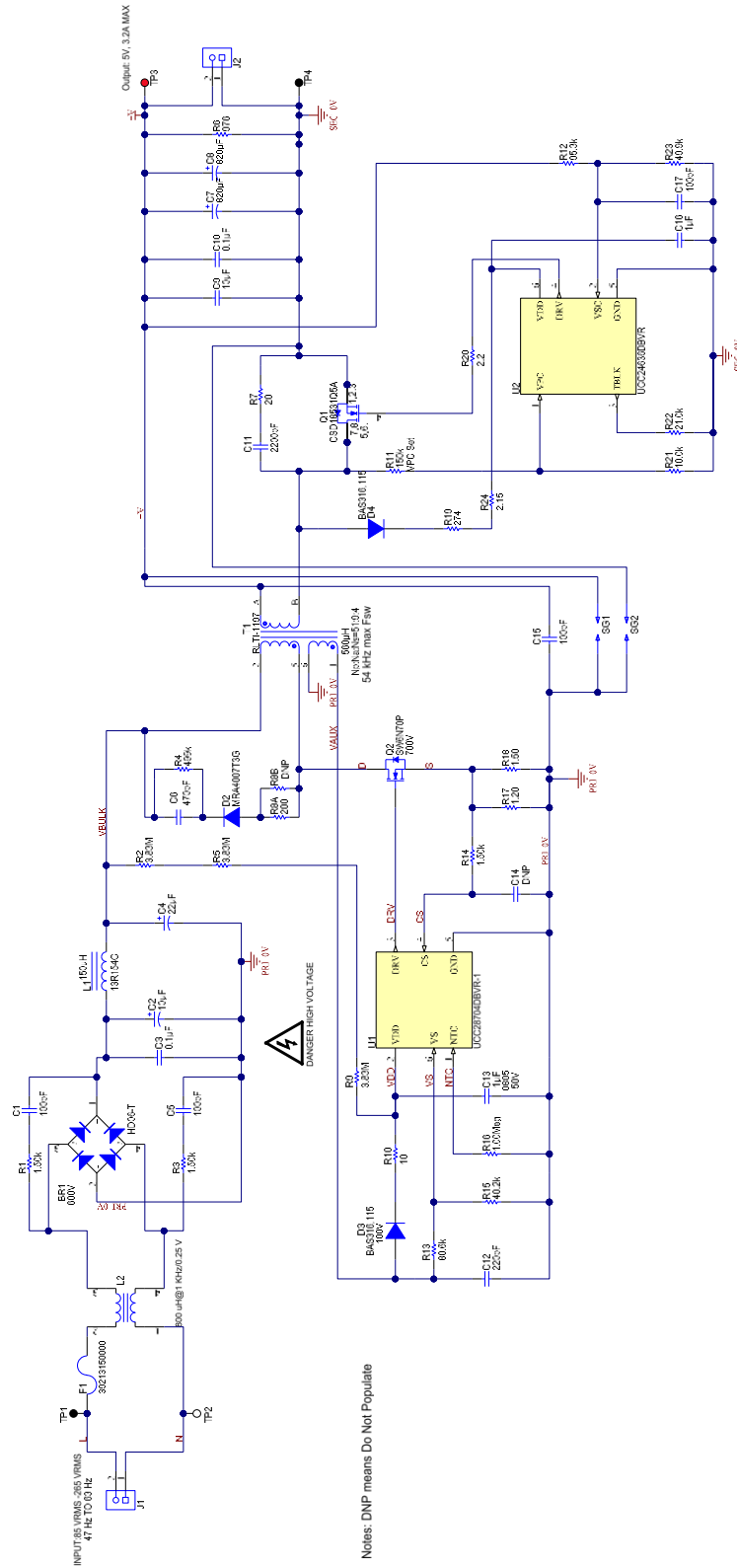

7 Key Design Notes

7.1 Design Goal Parameters

Input Voltage:	85 Vac to 265 Vac
Output Voltage:	5 V
Load Current:	3 A
Output Power	15 W
Constant Current:	3.3 A
Desired Switching frequency:	52k Hz (at full load)
Ripple and Noise:	≤150mV
Target efficiency:	88%
EMI target:	EN55022B/FCC PART 15 Class B with maximum 100p Y cap

7.2 Design Tips

UCC28704 is TI's latest highly integrated, 6-pin primary-side regulated PWM controller for designing high efficiency AC-to-DC power supplies with low standby power consumption to comply with global efficiency standards.

UCC24636 is a compact, 6-pin secondary-side synchronous rectifier MOSFET controller and driver for high efficiency flyback converts operating in Discontinuous (DCM) and Transition mode (TM).

Transformer used is RM7, with 3C94 material. The turn ratio $N_p:N_s = 51:9:4$, Primary Inductance $L_p = 560\mu\text{H}$

7.2.1 Tips to achieve high efficiency

- Synchronization rectification using UCC24636
- Lower the turns of auxiliary winding
- Sandwich winding method for transformer
- Use standard recovery diode MRA4007 for D2 in primary R2CD snubber. Refer to application note [snva744](#).

7.2.2 Tips to improve EMI performance

- Adjust the turns and directions of inside two cancelling windings of transformer
- Connect core of transformer to primary GND
- Use RC (R1,C1,R3,C5) to improve the 4 MHz-10 MHz band
- Use the Si MOSFET SW6N70P instead of CoolMOS or similar
- Use RC snubber (C11, R7) on secondary side to damping the ringing
- Use R2CD snubber with standard recovery diode MRA4007 in primary side
- Use different differential mode choke and common mode choke
- Put small capacitor (C12) across the auxiliary winding
- Keep distance between common mode choke and the noise source such as MOSFET and transformer
- Layout carefully. Refer to the section 10.2 in UCC28704 datasheet for the layout example

7.2.3 Design considerations in Using with synchronous Rectifiers

- To avoid stable issue, special design considerations need to be observed. The key parameters to be considered carefully are t_{BW} , t_{DMAG} and working frequency. Where t_{BW} is the SR bump width, t_{DMAG} is the secondary rectifier conduction time. Refer to section 8.2.2.9 of UCC28704 datasheet for the detail explanation.

7.2.4 Other considerations

- Bias UCC24636 by Drain of Q1 through D4 and R19. This way could guarantee UCC24636 still work even V_{out} goes down to 2.5V.
- The NTC function is not used in this design. So a 1 Meg resistor is used to make sure the voltage on NTC pin exceed the NTC shut-down threshold. Customer could use NTC function by using NTC (Negative temperature coefficient) resistor.

IMPORTANT NOTICE AND DISCLAIMER

TI PROVIDES TECHNICAL AND RELIABILITY DATA (INCLUDING DATASHEETS), DESIGN RESOURCES (INCLUDING REFERENCE DESIGNS), APPLICATION OR OTHER DESIGN ADVICE, WEB TOOLS, SAFETY INFORMATION, AND OTHER RESOURCES "AS IS" AND WITH ALL FAULTS, AND DISCLAIMS ALL WARRANTIES, EXPRESS AND IMPLIED, INCLUDING WITHOUT LIMITATION ANY IMPLIED WARRANTIES OF MERCHANTABILITY, FITNESS FOR A PARTICULAR PURPOSE OR NON-INFRINGEMENT OF THIRD PARTY INTELLECTUAL PROPERTY RIGHTS.

These resources are intended for skilled developers designing with TI products. You are solely responsible for (1) selecting the appropriate TI products for your application, (2) designing, validating and testing your application, and (3) ensuring your application meets applicable standards, and any other safety, security, or other requirements. These resources are subject to change without notice. TI grants you permission to use these resources only for development of an application that uses the TI products described in the resource. Other reproduction and display of these resources is prohibited. No license is granted to any other TI intellectual property right or to any third party intellectual property right. TI disclaims responsibility for, and you will fully indemnify TI and its representatives against, any claims, damages, costs, losses, and liabilities arising out of your use of these resources.

TI's products are provided subject to TI's Terms of Sale (<https://www.ti.com/legal/termsofsale.html>) or other applicable terms available either on [ti.com](https://www.ti.com) or provided in conjunction with such TI products. TI's provision of these resources does not expand or otherwise alter TI's applicable warranties or warranty disclaimers for TI products.

Mailing Address: Texas Instruments, Post Office Box 655303, Dallas, Texas 75265
Copyright © 2021, Texas Instruments Incorporated