

ALM2403-Q1 Automotive, Low-Distortion, Dual-Channel Operational Amplifier With Integrated Protection for Resolver Drive

1 Features

- AEC-Q100 qualified for automotive applications:
 - Temperature grade 1: -40°C to $+125^{\circ}\text{C}$, T_A
- **Functional-safety capable**
 - [Documentation available to aid functional safety system design](#)
- High output current drive: 500 mA, peak (per channel)
 - Replaces discrete op amps and transistors
- Wide supply range for both supplies (up to 24 V)
- Overtemperature shutdown
- Current limit
- Shutdown pin for low I_Q applications
- 21-MHz gain bandwidth with 50-V/ μs slew rate
- Package: 14-pin HTSSOP (PWP)

2 Applications

- Resolver-based automotive and industrial applications
- [Inverter and motor control](#)
- Brake system
- [Electric power steering \(EPS\)](#)
- [Rearview mirror module](#)
- [Automotive eMirrors](#)
- [Servo drive power stage module](#)
- [Flight control system](#)

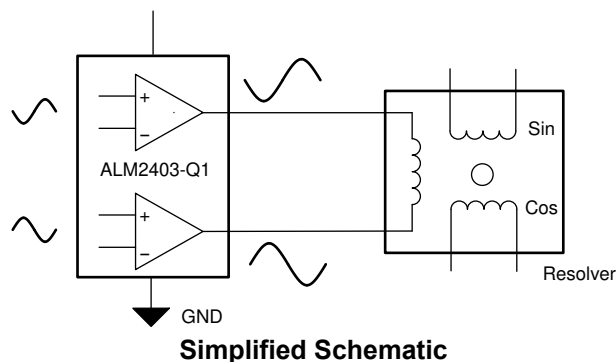

3 Description

The ALM2403-Q1 is a dual-power op amp with features and performance that make this device preferable for resolver-based applications. The high-gain bandwidth and slew rate of the device, along with a continuous high-output current-drive capability, make this device an excellent choice to provide the low distortion and differential high-amplitude excitation required for exciting the resolver primary coil. Current limiting and overtemperature detection enhance overall system robustness, especially when driving analog signals over wires that are susceptible to faults.

The small HTSSOP package with thermal pad and low $R_{\theta JA}$ allows high currents to be delivered to loads while minimizing board space. The higher gain bandwidth of the ALM2403-Q1 allows the device to be configured as a filter stage while still providing high output drive, thus significantly reducing the total solution size of a resolver drive signal chain. This reduced solution size is a key advantage offered by the ALM2403-Q1 when used in automotive and industrial applications.

Package Information

| PART NUMBER | PACKAGE ⁽¹⁾ | BODY SIZE (NOM) |
|-------------|------------------------|-------------------|
| ALM2403-Q1 | HTSSOP (14) | 5.00 mm × 4.40 mm |

- (1) For all available packages, see the package option addendum at the end of the data sheet.

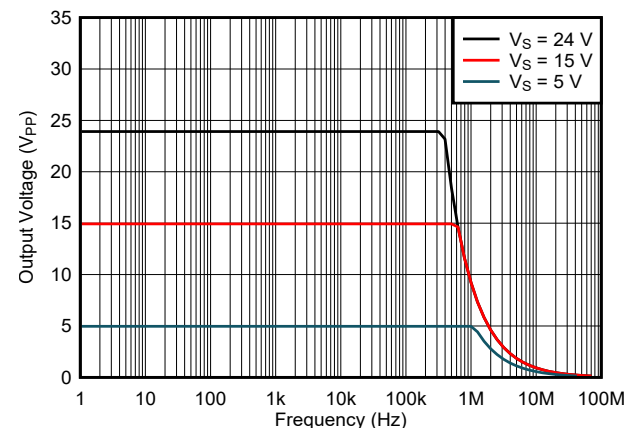

Table of Contents

| | | | |
|--|----|---|----|
| 1 Features | 1 | 7.4 Device Functional Modes..... | 14 |
| 2 Applications | 1 | 8 Application and Implementation | 15 |
| 3 Description | 1 | 8.1 Application Information..... | 15 |
| 4 Revision History | 2 | 8.2 Typical Application..... | 15 |
| 5 Pin Configuration and Functions | 3 | 8.3 Power Supply Recommendations..... | 19 |
| 6 Specifications | 4 | 8.4 Layout..... | 19 |
| 6.1 Absolute Maximum Ratings..... | 4 | 9 Device and Documentation Support | 21 |
| 6.2 ESD Ratings..... | 4 | 9.1 Documentation Support..... | 21 |
| 6.3 Recommended Operating Conditions..... | 4 | 9.2 Receiving Notification of Documentation Updates.... | 21 |
| 6.4 Thermal Information..... | 4 | 9.3 Support Resources..... | 21 |
| 6.5 Electrical Characteristics..... | 5 | 9.4 Trademarks..... | 21 |
| 6.6 Typical Characteristics..... | 7 | 9.5 Electrostatic Discharge Caution..... | 21 |
| 7 Detailed Description | 12 | 9.6 Glossary..... | 21 |
| 7.1 Overview..... | 12 | 10 Mechanical, Packaging, and Orderable | |
| 7.2 Functional Block Diagram..... | 12 | Information | 21 |
| 7.3 Feature Description..... | 13 | | |

4 Revision History

NOTE: Page numbers for previous revisions may differ from page numbers in the current version.

| Changes from Revision * (November 2020) to Revision A (May 2022) | Page |
|--|-------------|
| • Changed output current from 650 mA to 500 mA in <i>Features</i> | 1 |
| • Changed title and Y-axis unit in front-page plot | 1 |
| • Changed pin names to synchronize pin naming throughout document..... | 3 |
| • Changed thermal pad description text for clarity..... | 3 |
| • Changed voltage range for V_{OTF/SH_DN} in the <i>Absolute Maximum Ratings</i> | 4 |
| • Changed all V_S voltages to single-supply nomenclature in the <i>Electrical Characteristics</i> and <i>Typical Characteristics</i> | 5 |
| • Deleted test conditions from enable high and low input voltages in the <i>Electrical Characteristics</i> | 5 |
| • Moved shutdown current parameter to Power Supply section in the <i>Electrical Characteristics</i> | 5 |
| • Changed Figures 6-12 through 6-16 to correct axis units and values..... | 7 |
| • Changed functional block diagram to correct inaccuracies..... | 12 |
| • Changed EMC capacitance from 50 nF to 10 nF in Table 8-1, <i>Design Parameters</i> | 16 |
| • Added test condition to first bullet of <i>Detailed Design Procedure</i> | 17 |
| • Changed R3 to R2 in 2nd paragraph of <i>Filter Design</i> section..... | 17 |
| • Changed terms in Equation 4 to Equation 6 for clarity..... | 18 |
| • Changed Figure 8-4, <i>2nd-Order MFB LP Filter AC Output Characteristics</i> | 19 |
| • Changed values in Table 8-2, <i>Signal Attenuation vs Frequency</i> | 19 |
| • Changed Figure 8-6, <i>ALM2403-Q1 Layout Example</i> , to match EVM layout..... | 20 |

5 Pin Configuration and Functions

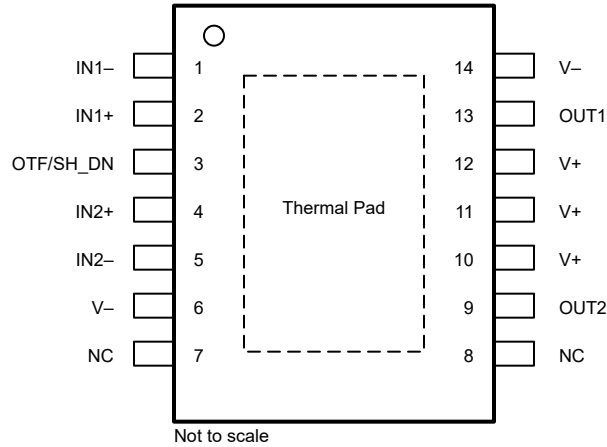

Figure 5-1. PWP Package, 14-Pin HTSSOP (Top View)

Table 5-1. Pin Functions

| PIN | | TYPE | DESCRIPTION |
|-------------|-------------|--------------|--|
| NO. | NAME | | |
| 1 | IN1– | Input | Inverting op amp input for channel 1 |
| 2 | IN1+ | Input | Noninverting op amp input for channel 1 |
| 3 | OTF/SH_DN | Input/Output | Overtemperature flag and shutdown (see Table 7-1 , <i>Shutdown Truth Table</i>) |
| 4 | IN2+ | Input | Noninverting op amp input for channel 2 |
| 5 | IN2– | Input | Inverting op amp input for channel 2 |
| 6, 14 | V– | — | Negative supply pin (both negative supply pins must be used and connected together) |
| 7, 8 | NC | — | No internal connection (do not connect) |
| 9 | OUT2 | Output | Op amp output for channel 2 |
| 10, 11, 12 | V+ | — | Positive supply pin |
| 13 | OUT1 | Output | Op amp output for channel 1 |
| Thermal Pad | Thermal Pad | — | Connect the exposed thermal pad to the most negative supply on the device, V–, for best thermal performance. The thermal pad can also be left floating electrically; the heat spread of the pad can be thermally maximized and conducted into the PCB. |

6 Specifications

6.1 Absolute Maximum Ratings

over operating free-air temperature range (unless otherwise noted)⁽¹⁾

| | | | MIN | MAX | UNIT |
|------------------------|-------------------------------------|--|------------|-------------------|------|
| V _S | Supply voltage | Single-supply, V _S = (V+) – GND | | 26 | V |
| | | Dual-supply, V _S = (V+) – (V–) | | ±13 | |
| | Signal input voltage | Common-mode | (V–) – 0.7 | (V+) + 0.7 | V |
| | | Differential | | (V+) – (V–) + 0.2 | |
| V _{OTF/SH_DN} | OTF/SH_DN pin voltage | | (V–) – 0.2 | (V–) + 5.7 | V |
| | Signal input current | | | ±10 | mA |
| | Output short circuit ⁽²⁾ | | Continuous | Continuous | |
| T _A | Operating temperature | | –55 | 150 | °C |
| T _J | Junction temperature | | | 150 | °C |
| T _{stg} | Storage temperature | | –65 | 150 | °C |

- (1) Operation outside the Absolute Maximum Ratings may cause permanent device damage. Absolute Maximum Ratings do not imply functional operation of the device at these or any other conditions beyond those listed under Recommended Operating Conditions. If used outside the Recommended Operating Conditions but within the Absolute Maximum Ratings, the device may not be fully functional, and this may affect device reliability, functionality, performance, and shorten the device lifetime.
- (2) Short-circuit to ground, one amplifier per package.

6.2 ESD Ratings

| | | | VALUE | UNIT |
|--------------------|-------------------------|---|-------|------|
| V _(ESD) | Electrostatic discharge | Human-body model (HBM), per AEC Q100-002 ⁽¹⁾ HBM ESD classification level 2 | ±2000 | V |
| | | Charged-device model (CDM), per AEC Q100-011 CDM ESD classification level C5 | ±750 | |

- (1) AEC Q100-002 indicates that HBM stressing shall be in accordance with the ANSI/ESDA/JEDEC JS-001 specification.

6.3 Recommended Operating Conditions

over operating free-air temperature range (unless otherwise noted)

| | | | MIN | NOM | MAX | UNIT |
|----------------|-----------------------|--|------|-----|-----|------|
| V _S | Supply voltage | Single-supply, V _S = (V+) – GND | 5 | | 24 | V |
| | | Dual-supply, V _S = (V+) – (V–) | ±2.5 | | ±12 | |
| T _A | Operating temperature | | –40 | | 125 | °C |

6.4 Thermal Information

| THERMAL METRIC ⁽¹⁾ | | ALM2403-Q1 | UNIT |
|-------------------------------|--|--------------|------|
| | | PWP (HTSSOP) | |
| | | 14 PINS | |
| R _{θJA} | Junction-to-ambient thermal resistance | 46.9 | °C/W |
| R _{θJC(top)} | Junction-to-case (top) thermal resistance | 42.1 | °C/W |
| R _{θJB} | Junction-to-board thermal resistance | 22.6 | °C/W |
| ψ _{JT} | Junction-to-top characterization parameter | 1.2 | °C/W |
| ψ _{JB} | Junction-to-board characterization parameter | 22.5 | °C/W |
| R _{θJC(bot)} | Junction-to-case (bottom) thermal resistance | 5.9 | °C/W |

- (1) For more information about traditional and new thermal metrics, see the [Semiconductor and IC Package Thermal Metrics](#) application report.

6.5 Electrical Characteristics

at $T_A = 25^\circ\text{C}$, $V_S = V_+ = 24\text{ V}$, $V_- = \text{GND}$, $R_L = 10\text{ k}\Omega$ connected to $V_S / 2$, and $V_{CM} = V_{OUT} = V_S / 2$ (unless otherwise noted)

| PARAMETER | | TEST CONDITIONS | MIN | TYP | MAX | UNIT |
|---------------------------|-----------------------------------|--|---|-----------------|---------------|--------------------------------------|
| OFFSET VOLTAGE | | | | | | |
| V_{OS} | Input offset voltage | | | ± 6 | ± 25 | mV |
| dV_{OS}/dT | Input offset voltage drift | $T_A = -40^\circ\text{C}$ to $+125^\circ\text{C}$ | | ± 15 | ± 50 | $\mu\text{V}/^\circ\text{C}$ |
| PSRR | Power-supply rejection ratio | $V_S = 5\text{ V}$ to 24 V | | ± 10 | ± 47 | $\mu\text{V}/\text{V}$ |
| | | $V_S = 5\text{ V}$ to 24 V , $T_A = -40^\circ\text{C}$ to $+125^\circ\text{C}$ | | | ± 50 | |
| | Channel separation | $f = 10\text{ kHz}$ | | 120 | | dB |
| INPUT BIAS CURRENT | | | | | | |
| I_B | Input bias current | | | 10 | ± 100 | pA |
| | | $T_A = -40^\circ\text{C}$ to $+125^\circ\text{C}$ | | | | ± 100 |
| I_{OS} | Input offset current | | | 10 | ± 200 | pA |
| | | $T_A = -40^\circ\text{C}$ to $+125^\circ\text{C}$ | | | | ± 100 |
| NOISE | | | | | | |
| | Input voltage noise | $f = 0.1\text{ Hz}$ to 10 Hz | | 8 | | μV_{RMS} |
| e_N | Input voltage noise density | $f = 1\text{ kHz}$ | | 150 | | $\text{nV}/\sqrt{\text{Hz}}$ |
| | | $f = 100\text{ kHz}$ | | 22 | | |
| i_N | Input current noise | $f = 1\text{ kHz}$ | | 48 | | $\text{fA}/\sqrt{\text{Hz}}$ |
| INPUT VOLTAGE | | | | | | |
| V_{CM} | Common-mode voltage | | $(V_-) - 0.2$ | | $(V_+) + 0.2$ | V |
| CMRR | Common-mode rejection ratio | $(V_-) - 0.5\text{ V} < V_{CM} < (V_+) + 0.5\text{ V}$, $10\text{ V} \leq V_S < 24\text{ V}$ | 49 | 72 | | dB |
| | | $(V_-) - 0.2\text{ V} < V_{CM} < (V_+) + 0.2\text{ V}$, $T_A = -40^\circ\text{C}$ to $+125^\circ\text{C}$, $10\text{ V} < V_S < 24\text{ V}$ | 52 | | | |
| | | $(V_-) + 2.5\text{ V} < V_{CM} < (V_+) - 2.5\text{ V}$, $10\text{ V} < V_S < 24\text{ V}$ | 80 | 94 | | |
| | | $(V_-) + 2.5\text{ V} < V_{CM} < (V_+) - 2.5\text{ V}$, $T_A = -40^\circ\text{C}$ to $+125^\circ\text{C}$, $10\text{ V} < V_S < 24\text{ V}$ | 75 | | | |
| | | $(V_-) - 0.5\text{ V} < V_{CM} < (V_+) + 0.5\text{ V}$, $5\text{ V} < V_S < 24\text{ V}$ | 44 | 59 | | |
| INPUT CAPACITANCE | | | | | | |
| Z_{ID} | Differential | | | $1 \parallel 2$ | | $\text{G}\Omega \parallel \text{pF}$ |
| Z_{ICM} | Common-mode | | | $1 \parallel 2$ | | |
| OPEN-LOOP GAIN | | | | | | |
| A_{OL} | Open-loop voltage gain | $(V_-) + 0.5\text{ V} < V_O < (V_+) - 0.5\text{ V}$, $V_S = 24\text{ V}$ | | 103 | 111 | dB |
| | | | $T_A = -40^\circ\text{C}$ to $+125^\circ\text{C}$ | 96 | | |
| | | $(V_-) + 1.5\text{ V} < V_O < (V_+) - 1.5\text{ V}$, $R_L = 225\ \Omega$, $V_S = 24\text{ V}$ | | 96 | 104 | |
| | | | $T_A = -40^\circ\text{C}$ to $+125^\circ\text{C}$ | 94 | | |
| FREQUENCY RESPONSE | | | | | | |
| GBW | Gain-bandwidth product | $V_S = 24\text{ V}$ | | 21 | | MHz |
| SR | Slew rate | 10-V step, gain = +1 | | 50 | | $\text{V}/\mu\text{s}$ |
| t_s | Settling time | To 0.1%, 10-V step, gain = +1, $C_L = 10\text{ pF}$ | | 0.31 | | μs |
| | | To 0.1%, 10-V step, gain = -1, $C_L = 10\text{ pF}$ | | 0.40 | | |
| | Overload recovery time | $V_{IN} \times \text{gain} > V_S$ | | 0.28 | | μs |
| THD+N | Total harmonic distortion + noise | $V_S = 15\text{ V}$, $V_O = 10\text{ V}_{\text{pp}}$, gain = -1, $f = 10\text{ kHz}$, $R_L = 100\ \Omega$ | | 74 | | dB |

6.5 Electrical Characteristics (continued)

at $T_A = 25^\circ\text{C}$, $V_S = V_+ = 24\text{ V}$, $V_- = \text{GND}$, $R_L = 10\text{ k}\Omega$ connected to $V_S / 2$, and $V_{\text{CM}} = V_{\text{OUT}} = V_S / 2$ (unless otherwise noted)

| PARAMETER | | TEST CONDITIONS | MIN | TYP | MAX | UNIT |
|-------------------------|--------------------------------|---|-----|-----|-----|------------------|
| OUTPUT | | | | | | |
| | Voltage output swing from rail | $I_{\text{OUT}} = \pm 5\text{ mA}$ | | 35 | 60 | mV |
| I_{SC} | Short-circuit current | Sinking | | 400 | | mA |
| | | Sourcing | | 500 | | |
| ENABLE | | | | | | |
| $V_{\text{IH_OTF}}$ | Enable high input voltage | | 1.2 | | | V |
| $V_{\text{IL_OTF}}$ | Enable low input voltage | | | | 0.5 | V |
| | Enable hysteresis | | | 220 | | mV |
| $t_{\text{OTF/SH_DN}}$ | Enable start-up time | | | 5 | | μs |
| POWER SUPPLY | | | | | | |
| I_{Q} | Total quiescent current | $I_{\text{O}} = 0\text{ A}$ | | 3.6 | 5.5 | mA |
| | | $I_{\text{O}} = 0\text{ A}$, $T_A = -40^\circ\text{C}$ to $+125^\circ\text{C}$ | | | 6 | |
| I_{SD} | Shutdown current | $V_{\text{OTF/SH_DN}} = 0\text{ V}$ | | | 260 | μA |
| TEMPERATURE | | | | | | |
| | Thermal shutdown | | | 172 | | $^\circ\text{C}$ |
| | Thermal shutdown recovery | | | 150 | | $^\circ\text{C}$ |

6.6 Typical Characteristics

at $T_A = 25^\circ\text{C}$, $V_S = 24\text{ V}$, $V_{CM} = V_S/2$, and $R_L = 10\text{ k}\Omega$ (unless otherwise noted)

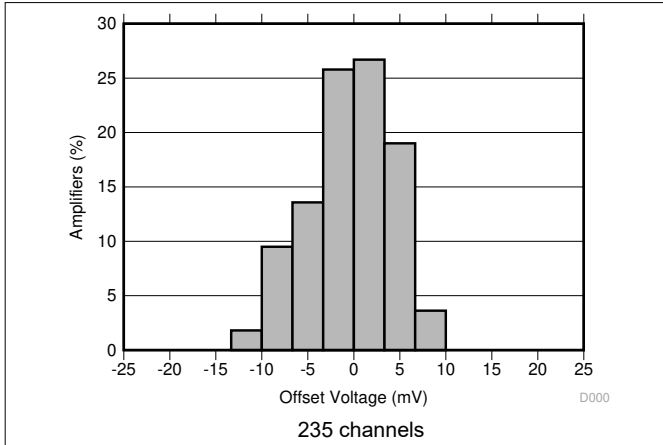

Figure 6-1. Offset Voltage Production Distribution

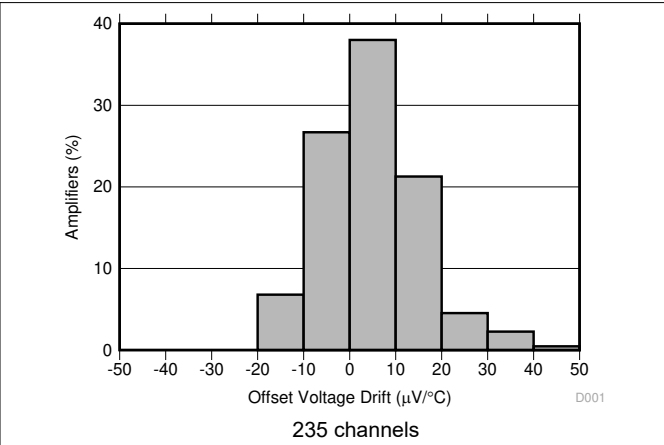

Figure 6-2. Offset Voltage Drift Production Distribution

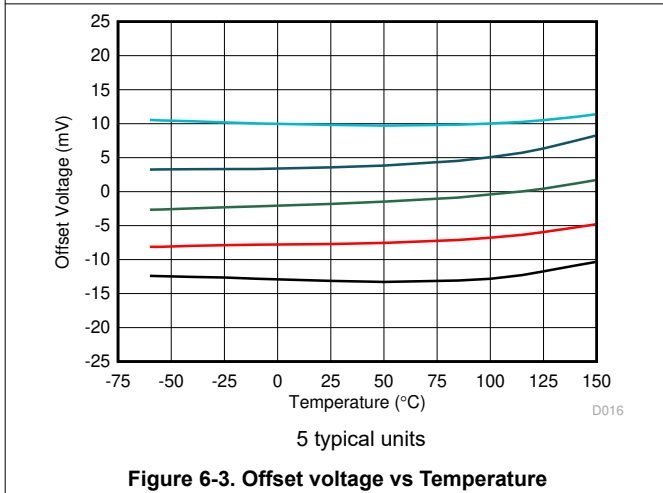

Figure 6-3. Offset voltage vs Temperature

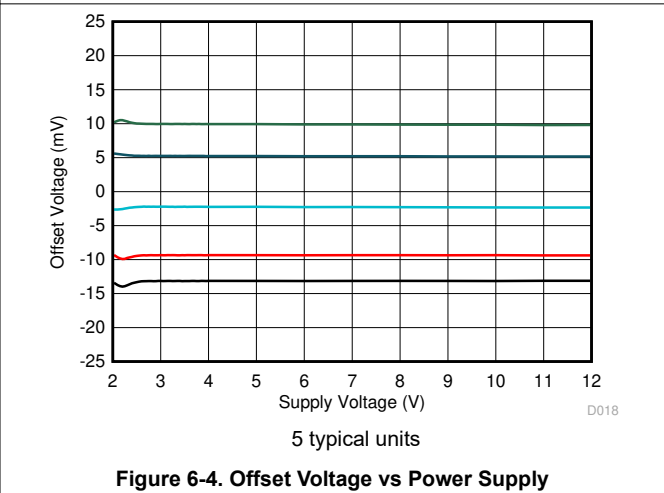

Figure 6-4. Offset Voltage vs Power Supply

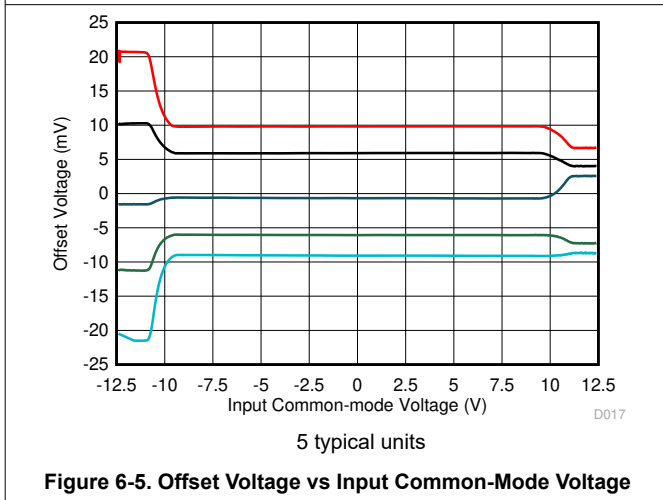

Figure 6-5. Offset Voltage vs Input Common-Mode Voltage

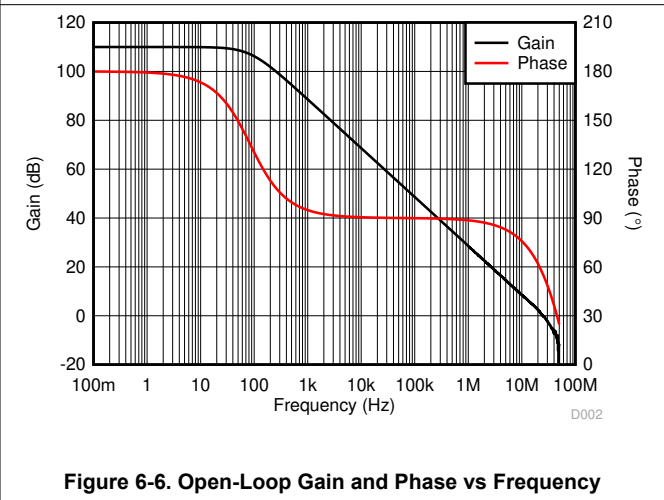

Figure 6-6. Open-Loop Gain and Phase vs Frequency

6.6 Typical Characteristics (continued)

at $T_A = 25^\circ\text{C}$, $V_S = 24\text{ V}$, $V_{CM} = V_S/2$, and $R_L = 10\text{ k}\Omega$ (unless otherwise noted)

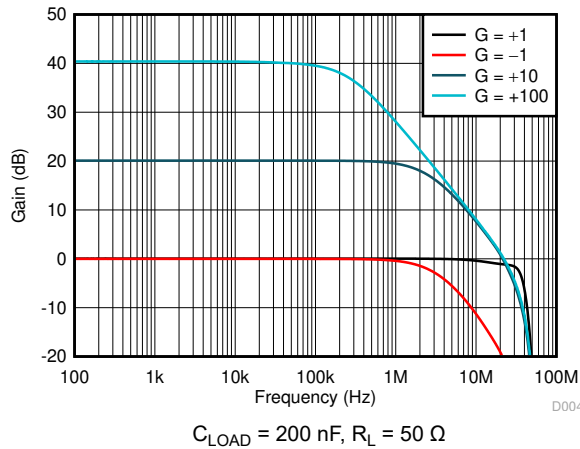

Figure 6-7. Closed-Loop Gain vs Frequency

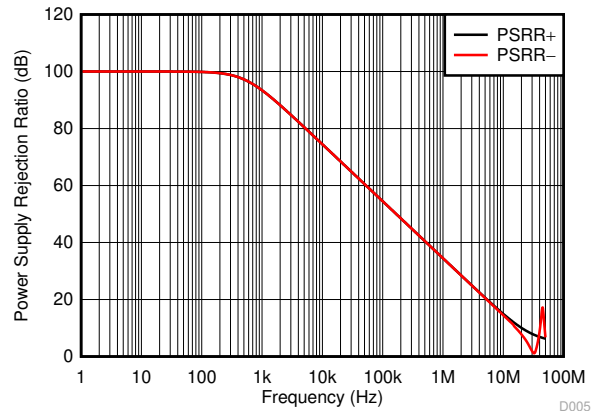

Figure 6-8. PSRR vs Frequency

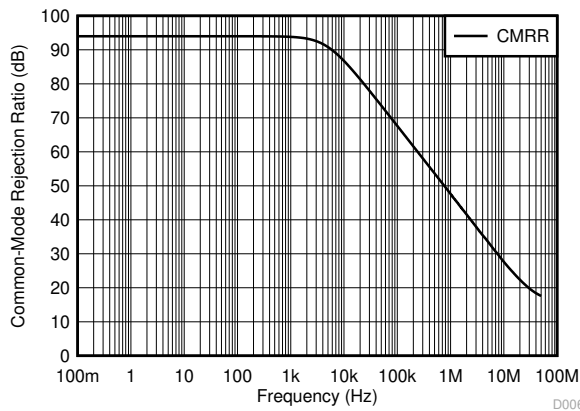

Figure 6-9. CMRR vs Frequency

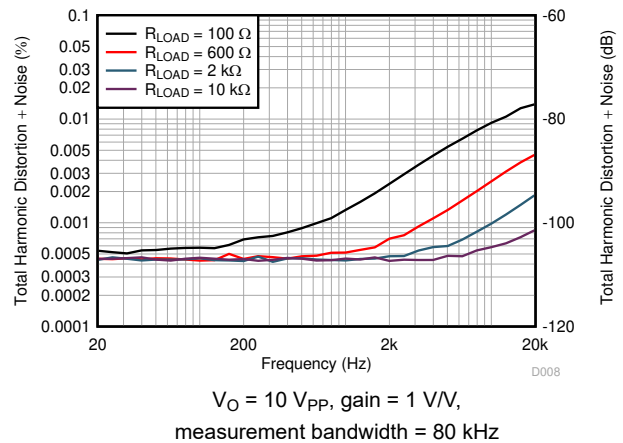

Figure 6-10. THD+N Ratio vs Frequency

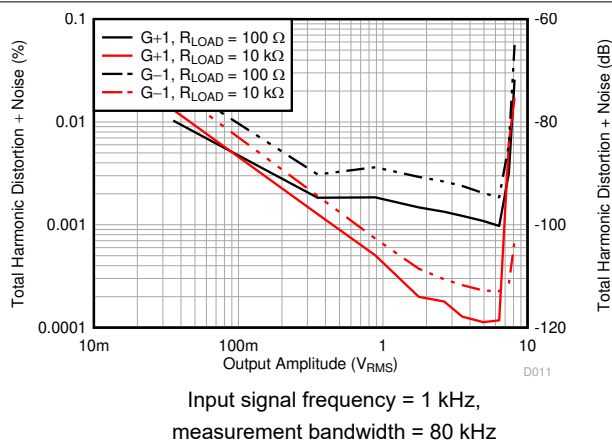

Figure 6-11. THD+N vs Output Amplitude

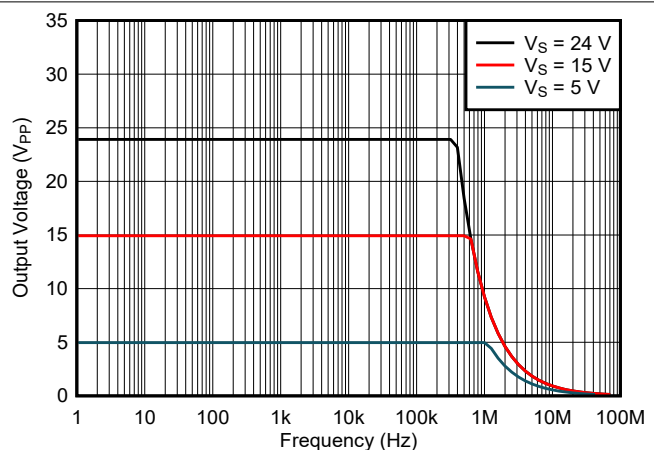

Figure 6-12. Output Voltage vs Frequency

6.6 Typical Characteristics (continued)

at $T_A = 25^\circ\text{C}$, $V_S = 24\text{ V}$, $V_{CM} = V_S/2$, and $R_L = 10\text{ k}\Omega$ (unless otherwise noted)

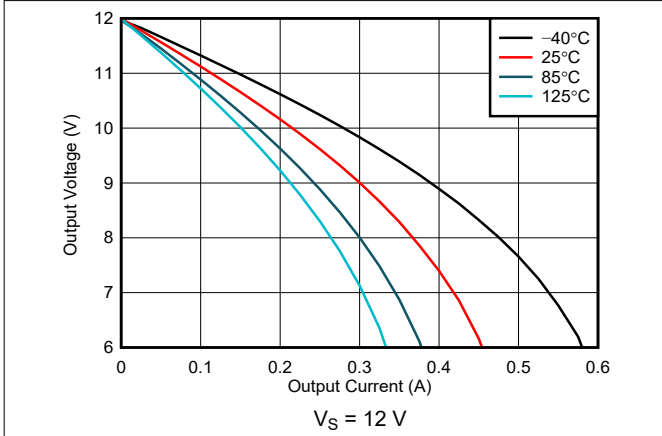

Figure 6-13. Output Voltage Swing vs Output Source Current

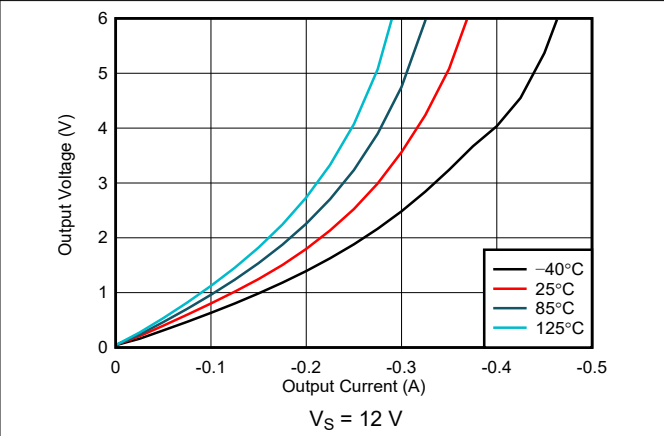

Figure 6-14. Output Voltage Swing vs Output Sink Current

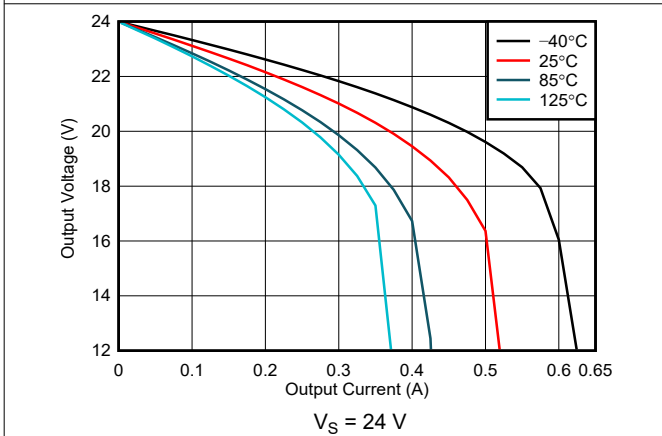

Figure 6-15. Output Voltage Swing vs Output Source Current

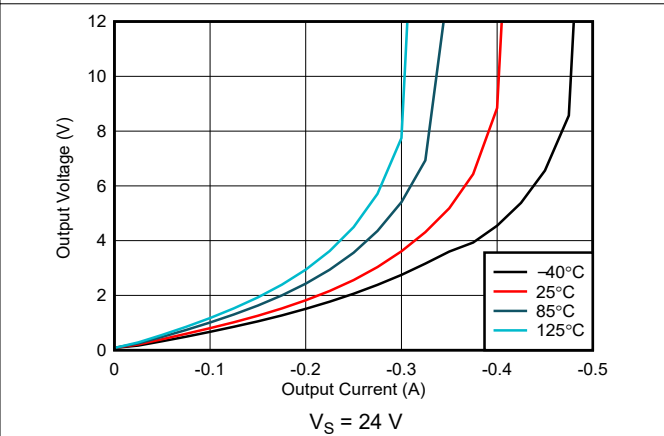

Figure 6-16. Output Voltage Swing vs Output Sink Current

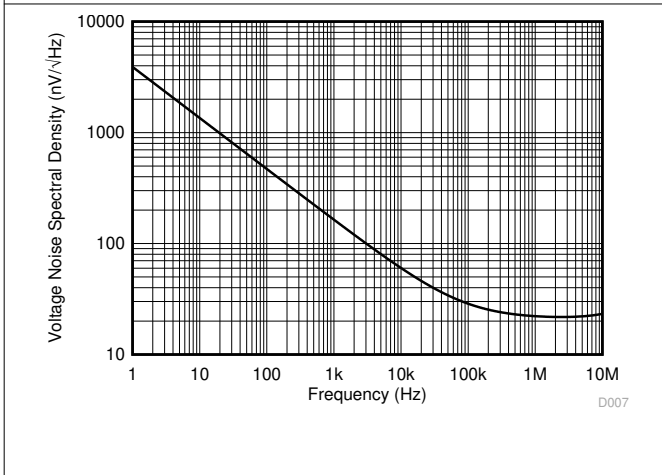

Figure 6-17. Input Voltage Spectral Noise Density vs Frequency

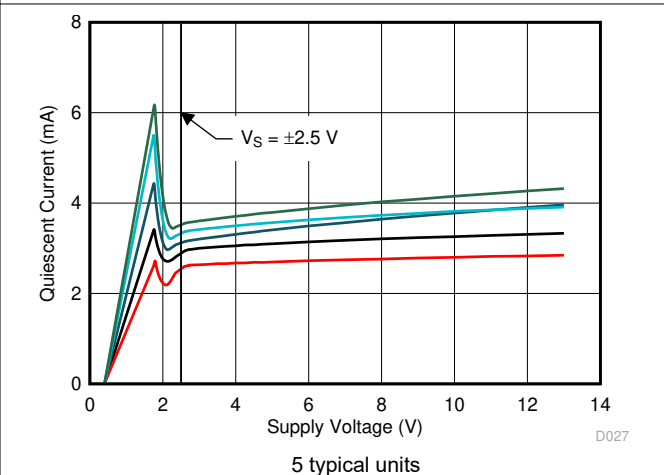

Figure 6-18. Quiescent Current vs Power Supply

6.6 Typical Characteristics (continued)

at $T_A = 25^\circ\text{C}$, $V_S = 24\text{ V}$, $V_{CM} = V_S/2$, and $R_L = 10\text{ k}\Omega$ (unless otherwise noted)

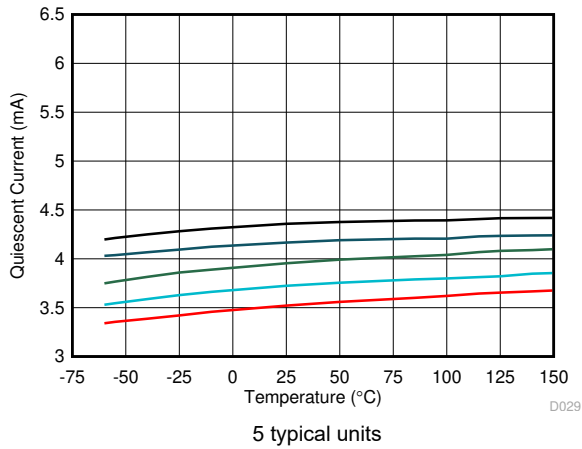

Figure 6-19. Quiescent Current vs Temperature

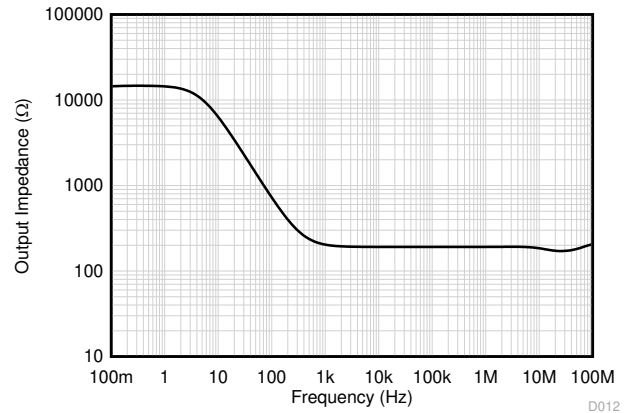
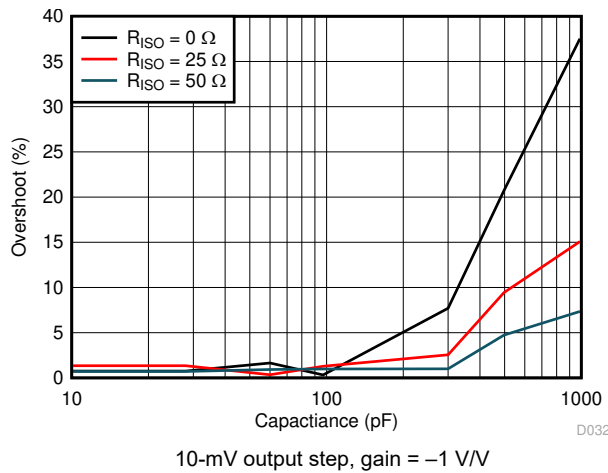
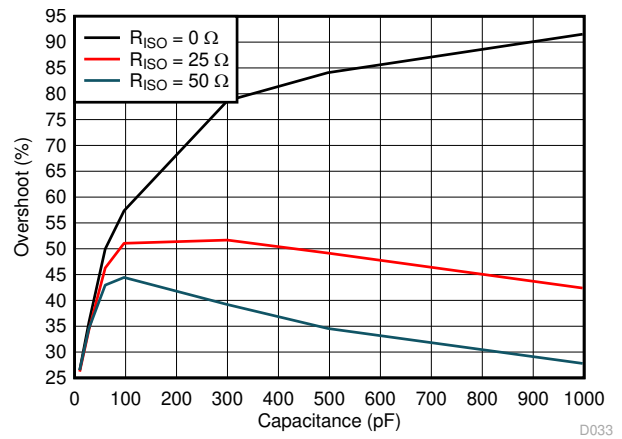

Figure 6-20. Open-Loop Output Impedance vs Frequency



10-mV output step, gain = -1 V/V

Figure 6-21. Small-Signal Overshoot vs Capacitive Load



10-mV output step, gain = 1 V/V

Figure 6-22. Small-Signal Overshoot vs Capacitive Load

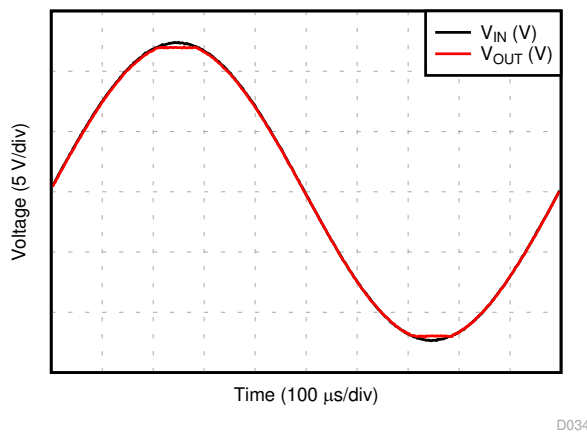

Figure 6-23. No Phase Reversal

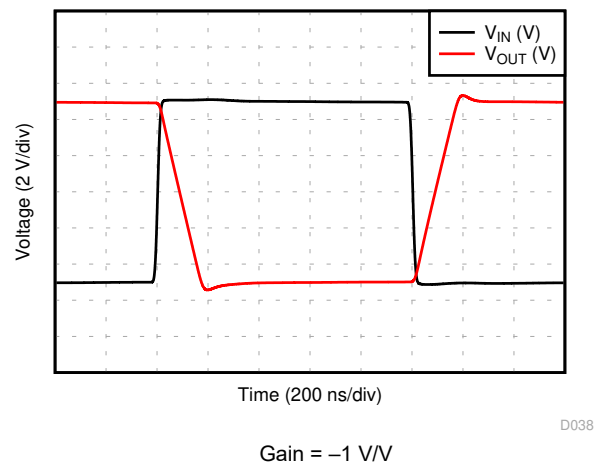

Figure 6-24. Large-Signal Step Response

6.6 Typical Characteristics (continued)

at $T_A = 25^\circ\text{C}$, $V_S = 24\text{ V}$, $V_{CM} = V_S/2$, and $R_L = 10\text{ k}\Omega$ (unless otherwise noted)

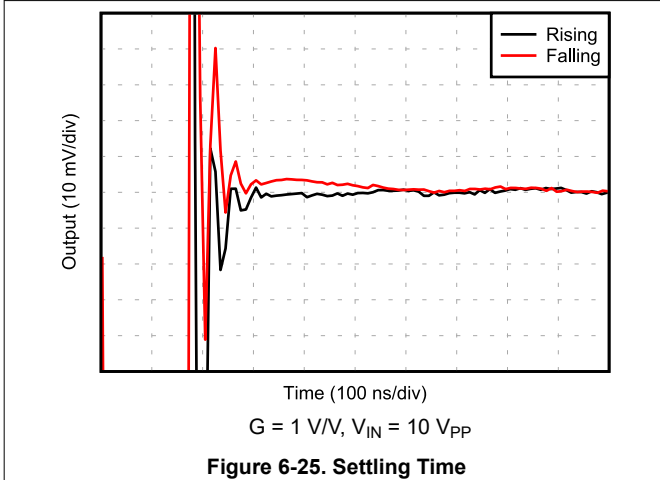

Figure 6-25. Settling Time

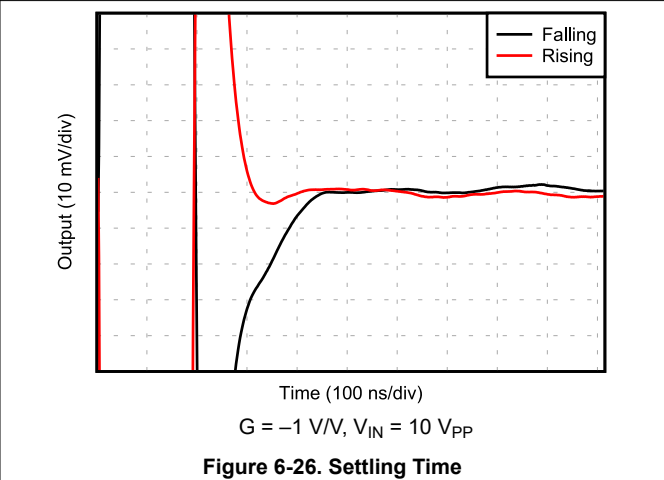

Figure 6-26. Settling Time

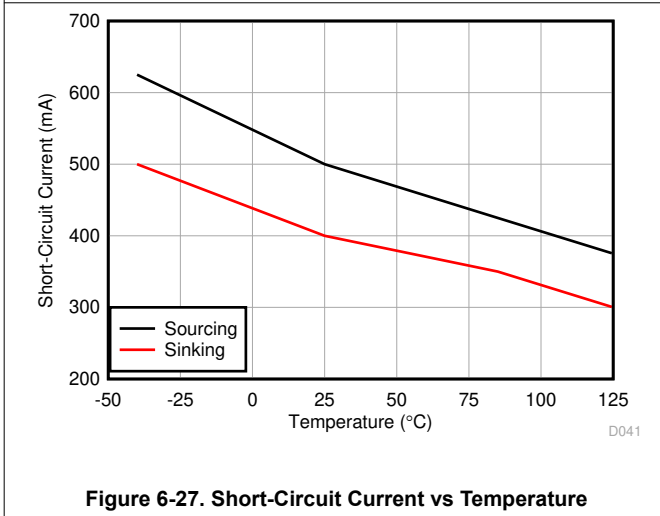

Figure 6-27. Short-Circuit Current vs Temperature

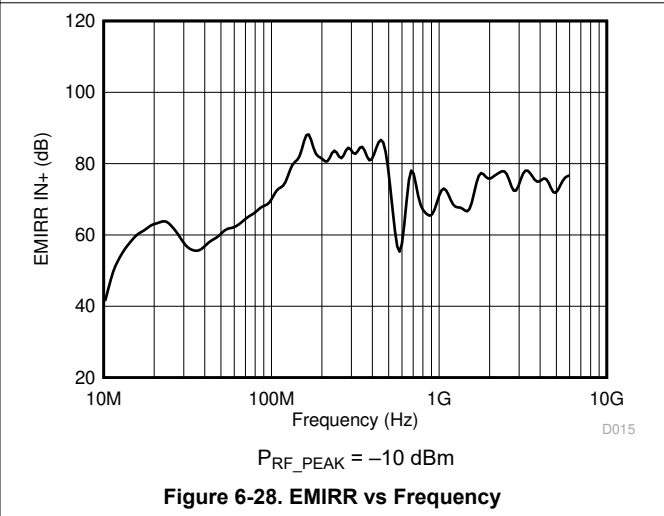

Figure 6-28. EMIRR vs Frequency

7 Detailed Description

7.1 Overview

The ALM2403-Q1 is a dual-power op amp qualified for use in automotive applications. Key features for this device are low offset voltage, high output current drive capability, and high FPBW capability. The device also offers protection features such as thermal shutdown and current limit. The 14-pin HTSSOP package minimizes board space and power dissipation.

7.2 Functional Block Diagram

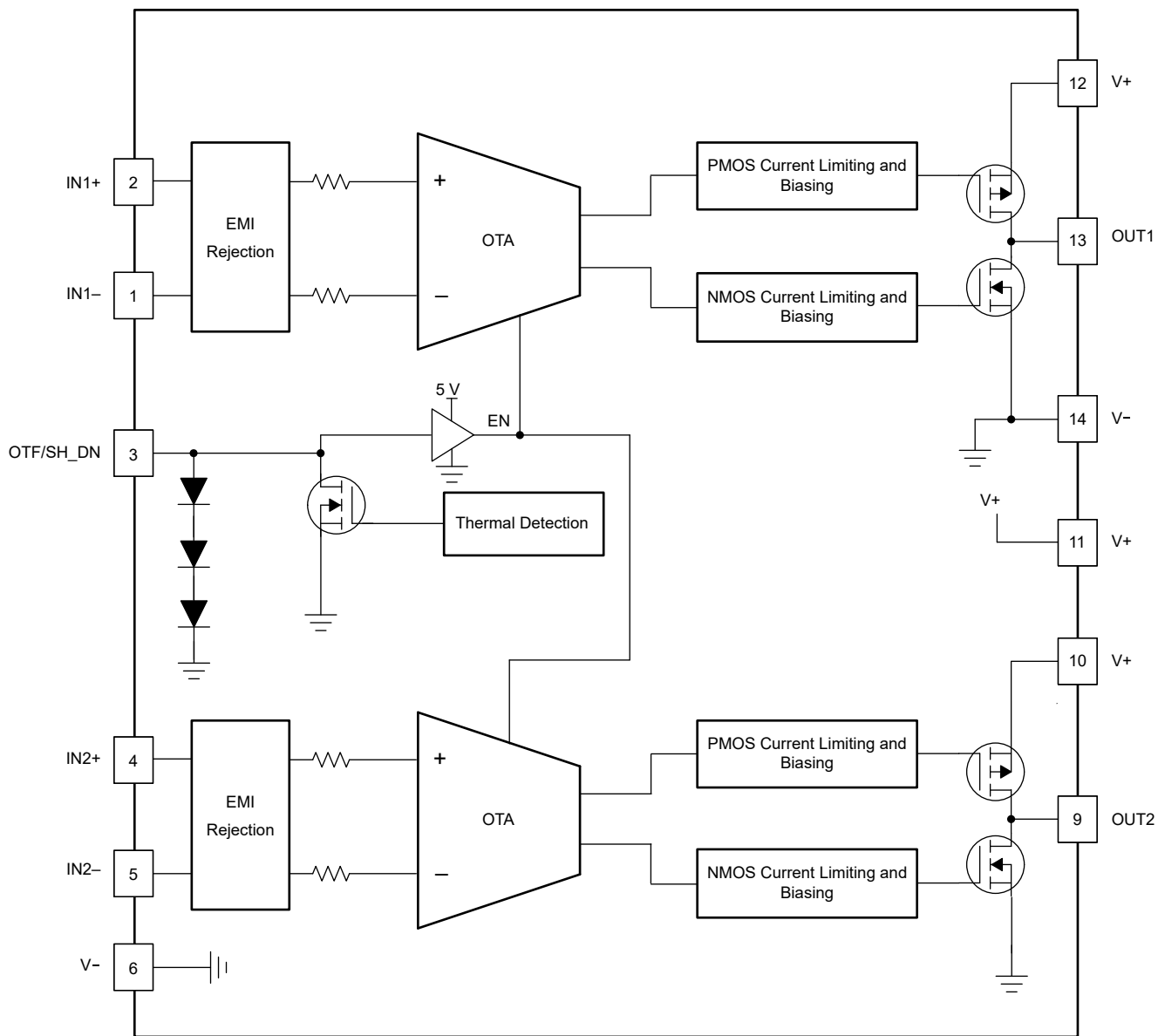

7.3 Feature Description

7.3.1 Overtemperature and Shutdown Pin (OTF/SH_DN)

The overtemperature and shutdown pin, OTF/SH_DN, is bidirectional and allows both op amps to be put into a low I_Q state (approximately 200 μA per amplifier) when forced low or to less than V_{IL_OTF} . As a result of being bidirectional, and the respective enable and disable functionality, this pin must be pulled high or greater than V_{IH_OTF} through a pullup resistor. The use of a 10-k Ω pullup resistor leads to a drive current of approximately 210 μA when used with a pullup voltage of 3.3 V.

When the junction temperature of the ALM2403-Q1 exceeds the specified limits, OTF/SH_DN goes low to alert the application that both the outputs have turned off because of an overtemperature event.

When OTF/SH_DN is pulled low and the op amps are shut down, the op amps are in an open loop, even when there is negative feedback applied. This occurrence is due to the loss of the open-loop gain in the op amps when the biasing is disabled.

7.3.2 Thermal Shutdown

If the die temperature exceeds safe limits, all outputs are disabled, and the OTF/SH_DN pin is driven low. After the die temperature has fallen to a safe level, operation automatically resumes. The OTF/SH_DN pin is released after operation has resumed.

When operating the die at a high temperature, the op amp toggles on and off between the thermal shutdown hysteresis. In this event, the safe limits for the die temperature must be taken in to account. Do not continuously operate the device in thermal hysteresis for long periods of time.

7.3.3 Current-Limit and Short-Circuit Protection

Each op amp in the ALM2403-Q1 has separate internal current limiting for the PMOS (high-side) and NMOS (low-side) output transistors. If the output is shorted to ground, then the PMOS (high-side) current limit is activated, and limits the current to 500 mA nominally. If the output is shorted to supply, then the NMOS (low-side) current limit is activated and limits the current to 400 mA nominally at 25°C. The current limit value is inversely proportional to temperature; therefore, the current limit value increases at low temperatures.

When current is limited, the safe limits for the die temperature must be taken in to account. With too much power dissipation, the die temperature can surpass thermal shutdown limits; the op amp shuts down and reactivates after the die has fallen below thermal limits.

CAUTION

Do not continuously operate the device in thermal hysteresis for long periods of time because this action may cause irreversible damage to the device.

7.3.4 Input Common-Mode Range

The input common-mode range of the ALM2403-Q1 is between $(V_-) - 0.2\text{ V}$ and $(V_+) + 0.2\text{ V}$. Staying within this range allows the op amps to perform and operate within specification. Operating beyond these limits can cause distortion and nonlinearities.

7.3.5 Reverse Body Diodes in Output-Stage Transistors

Designed as a high-voltage, high current operational amplifier, the ALM2403-Q1 delivers robust output drive capability. A class AB output stage with common-source transistors is used to achieve full rail-to-rail output swing capability. Different load conditions change the ability of the amplifier to swing close to the rails.

Each output transistor has internal reverse diodes between drain and source that conduct if the output is forced to greater than the supply or less than ground (reverse current flow). These diodes can be used as flyback protection in inductive-load-driving applications. Limit the use of these diodes to pulsed operation in order to minimize junction temperature overheating due to $(V_F \times I_F)$. Internal current-limiting circuitry does not operate when current is flown in the reverse direction and the reverse diodes are active. A method to protect these reverse body diodes is shown in [Section 8.2.2.1.2](#).

7.3.6 EMI Filtering

Op amps vary with regard to the susceptibility of the device to electromagnetic interference (EMI). If conducted EMI enters the op amp, the dc offset observed at the amplifier output may shift from the nominal value while EMI is present. This shift is a result of signal rectification associated with the internal semiconductor junctions. While all op-amp pin functions can be affected by EMI, the signal input pins are likely to be the most susceptible. The ALM2403-Q1 incorporates an internal input low-pass filter that reduces the amplifiers response to EMI. Both common-mode and differential mode filtering are provided by this filter.

Texas Instruments has developed the ability to accurately measure and quantify the immunity of an operational amplifier over a broad frequency spectrum extending from 10 MHz to 990 MHz. The EMI rejection ratio (EMIRR) metric allows op amps to be directly compared by the EMI immunity. Detailed information can also be found in the [EMI Rejection Ratio of Operational Amplifiers application report](#), available for download from www.ti.com.

7.4 Device Functional Modes

7.4.1 Open-Loop and Closed-Loop Operation

As a result of the very-high, open-loop dc gain of the ALM2403-Q1, the device functions as a comparator in open loop for most applications. A majority of electrical characteristics are verified in negative feedback, closed-loop configurations. Certain dc electrical characteristics, like offset, may have a higher drift across temperature and lifetime when continuously operated in open loop over the lifetime of the device.

7.4.2 Shutdown

When the OTF/SH_DN pin is left floating or is grounded, the op amp shuts down to a low I_Q state and does not operate; the op amp outputs go to a high-impedance state.

Table 7-1. Shutdown Truth Table

| PIN NAME | LOGIC STATE | OP AMP STATE |
|-----------|--------------------------|----------------------------|
| OTF/SH_DN | High ($> V_{IH_OTF}$) | Operating |
| | Low ($< V_{IL_OTF}$) | Shutdown (low I_Q state) |

8 Application and Implementation

Note

Information in the following applications sections is not part of the TI component specification, and TI does not warrant its accuracy or completeness. TI's customers are responsible for determining suitability of components for their purposes, as well as validating and testing their design implementation to confirm system functionality.

8.1 Application Information

The ALM2403-Q1 is a dual-power op amp with performance and protection features that are optimal for many applications. For op amps, there are many general design considerations that must be taken into account. The following subsections describe what to consider for most closed-loop applications. [Section 8.2](#) gives a specific example of the ALM2403-Q1 being used in a resolver application.

8.1.1 Capacitive Load and Stability

The ALM2403-Q1 is designed for applications where driving a capacitive load is required. As with all op amps, specific instances can occur where the ALM2403-Q1 device can become unstable. The particular op-amp circuit configuration, layout, gain, and output loading are some of the factors to consider when establishing whether or not an amplifier is stable in operation. An op amp in a unity-gain (1-V/V) buffer configuration that drives a capacitive load exhibits a greater tendency to become unstable compared to an amplifier operated at a higher-noise gain. The capacitive load, in conjunction with the op-amp output resistance, creates a pole within the feedback loop that degrades the phase margin. The degradation of the phase margin increases as the capacitive loading increases. When operating in a unity-gain configuration, the ALM2403-Q1 remains stable with a pure capacitive load up to approximately 30 pF. Increasing the amplifier closed-loop gain allows the amplifier to drive increasingly larger capacitance. This increased capability is evident when observing the overshoot response of the amplifier at higher voltage gains.

One technique for increasing the capacitive load drive capability of the amplifier operating in a unity-gain configuration is to insert a small resistor (R_S ; typically, 100 m Ω to 10 Ω) in series with the output, as shown in [Figure 8-1](#). This resistor significantly reduces the overshoot and ringing associated with large capacitive loads.

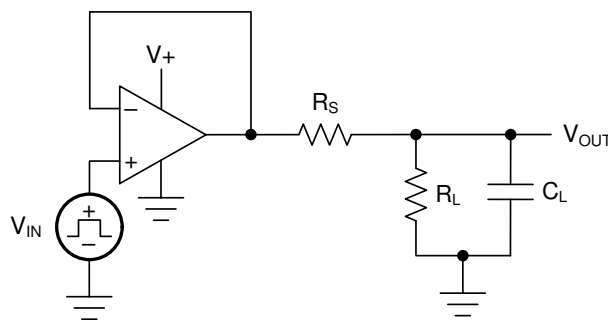

Figure 8-1. Capacitive Load Drive

8.2 Typical Application

High-power ac and brushless dc (BLDC) motor-drive applications need position feedback to efficiently and accurately drive the motor. Position feedback can be achieved by using optical encoders, hall sensors, or resolvers. Resolvers are the main choice when environmental or longevity requirements are challenging and extensive.

A resolver acts as a transformer with one primary coil and two secondary coils. The primary coil, or excitation coil, is located on the rotor of the resolver. As the rotor of the resolver spins, the excitation coil induces a current into the sine and cosine sensing coils. These coils are oriented 90 degrees from one another, and the voltage from the sine and cosine coils is translated into a vector position by the microcontroller or resolver-to-digital converter chip.

Resolver excitation coils can have a very low dc resistance ($< 100 \Omega$), requiring a sink and a source of up to 200 mA from the excitation driver. The ALM2403-Q1 can source and sink this current while providing current-limiting and thermal-shutdown protection. Incorporating these protections in a resolver design can increase the life of the end product.

The input to the ALM2403-Q1 can be an analog sine wave generated by the resolver-to-digital converter chip or a pulse-width modulation (PWM) signal generated from a microcontroller I/O pin. In the case of the latter, a filter stage is needed to extract a lower bandwidth sine wave from the PWM signal. This sine wave would then be the input signal to the ALM2403-Q1. As a result of high gain bandwidth, the ALM2403-Q1 can be configured as a filter stage while providing the required output drive. This configuration significantly reduces the total solution size and design complexity of the resolver-drive signal chain. The fundamental design steps to achieve this functionality are shown in this application example, and can be applied to other inductive-load applications as well.

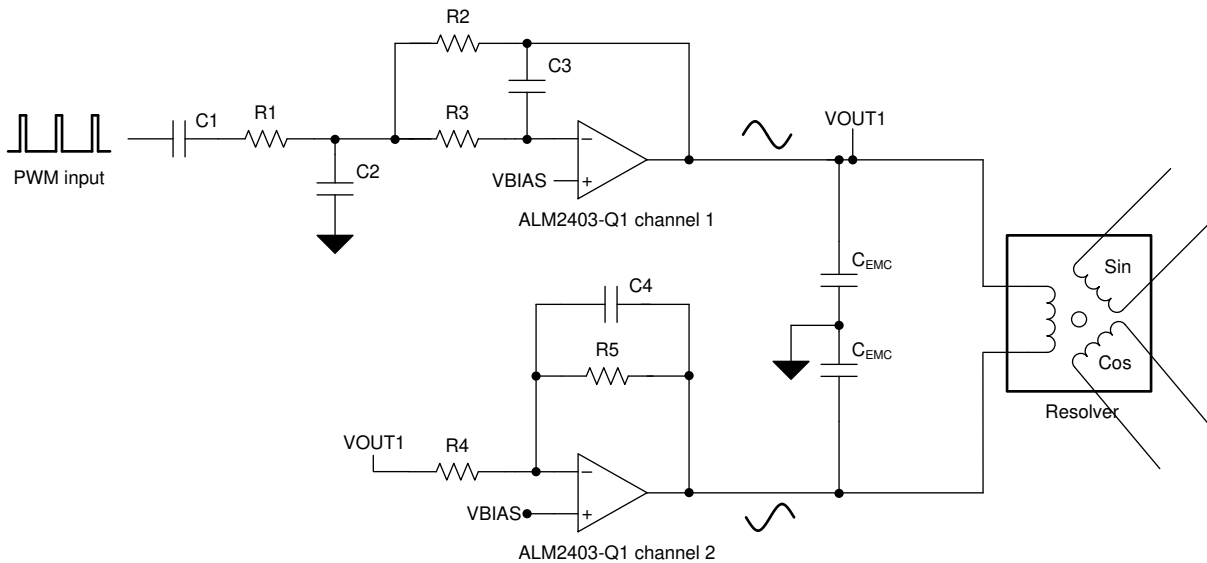

Figure 8-2. Resolver-Based Application

8.2.1 Design Requirements

For this design example, use the parameters listed in [Table 8-1](#) as the input parameters.

Table 8-1. Design Parameters

| DESIGN PARAMETER | EXAMPLE VALUE |
|-----------------------------------|---|
| Ambient temperature range | -40°C to $+125^{\circ}\text{C}$ |
| Available supply voltages | 15 V |
| EMC capacitance (CL) | 10 nF |
| Resolver excitation input voltage | $7 V_{\text{RMS}}$ |
| Excitation frequency | 10 kHz |
| PWM signal frequency | 320 kHz |
| PWM signal amplitude | 3.3 V |
| Functional safety capable | Yes |
| Short-to-battery protection | Yes |

8.2.2 Detailed Design Procedure

When using the ALM2403-Q1 in a resolver application, determine:

- Resolver excitation input impedance or resistance and inductance: $Z_O = 100 + j188$, $R = 100 \Omega$, and $L = 3 \text{ mH}$ at 10 kHz
- Resolver transformation ratio ($V_{\text{SINCOS}} / V_{\text{EXC}}$): 0.5 V/V at 10 kHz
- Package and $R_{\theta\text{JA}}$: HTSSOP, 46.9°C/W
- Op amp maximum junction temperature: 150°C
- Op amp bandwidth: 21 MHz
- Op amp slew rate: 50 V/ μS

8.2.2.1 Resolver Excitation Amplifier Combined With MFB 2nd-Order, Low-Pass Filter

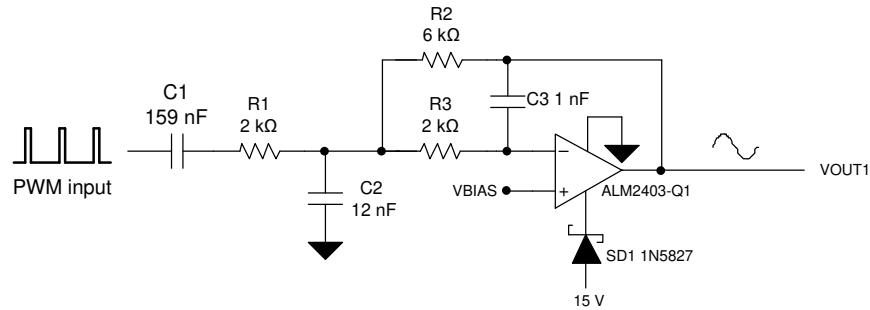

Figure 8-3. Two-Pole MFB Filter

When designing a low-pass filter, the most important design criteria is to decide the corner frequency. In this design example, the resolver excitation frequency is 10 kHz and PWM frequency is 320 kHz. Thus, we want to make sure that the low-pass filter corner frequency is greater than 10 kHz, and there is maximum attenuation of harmonic interference generated from the PWM signal. [Figure 8-3](#) shows a single channel of the ALM2403-Q1 configured as a 2-pole multiple feedback (MFB) filter with a -40 dB/decade rolloff. The MFB topology enables a steep rolloff while reducing BOM count. The output from this circuit is a sine wave that can then be inverted using the second channel of the ALM2403-Q1; see [Figure 8-2](#). Thus, both ALM2403-Q1 channels combined provide the required resolver excitation signal.

8.2.2.1.1 Filter Design

The corner frequency of the 2nd-order MFB filter is set to approximately twenty times less than the PWM frequency. The corner frequency defined at -3 dB is shown in [Equation 1](#).

$$f_p = \frac{1}{2 \times \pi \times \sqrt{R_3 \times C_3 \times R_2 \times C_2}} \quad (1)$$

The 2nd-order MFB active filter uses an inverted input topology and the op amp gain is determined by the ratios of resistors R2 and R1:

$$\text{Gain} = -\frac{R_2}{R_1} \quad (2)$$

The gain settings are based on the output drive requirements and PWM signal amplitude. With different gain settings, the filter characteristics, such as rolloff, can change. The design must be fine-tuned to meet optimal performance needs.

The quality (Q) factor of the low-pass filter is configured with $Q = 1$. The purpose of designing for this Q factor is to minimize attenuation around the corner frequency of 10 kHz, thus extending the pass-band gain. The Q factor of the 2nd-order MFB filter is given by [Equation 3](#):

$$Q = \frac{\sqrt{C_2 / C_3}}{\sqrt{R_3 / R_2} + \sqrt{R_2 / R_3} + \sqrt{R_3 \times R_2 / R_1}} \quad (3)$$

8.2.2.1.2 Short-to-Battery Protection

Resolver-based applications require the power op amp stage to provide the resolver excitation signal over long cables. In many applications, such as automotive traction inverters, the cables are housed in a harness and a short-circuit condition between different cables in the same harness can occur. In this situation, the output of the ALM2403-Q1 can see a higher voltage than provided at the positive supply pin. This condition causes the body diode in the output stage PMOS to become forward-biased and start conducting. As a precaution, use a blocking diode in series with the positive power supply; see also [Figure 8-3](#).

For related information, see the [ALM2403-Q1 Overvoltage Protection of Resolver-Based Circuits application note](#).

8.2.2.2 Power Dissipation and Thermal Reliability

Power dissipation is critical to many industrial and automotive applications. Resolvers are typically chosen over other position feedback techniques because of reliability and accuracy in harsh conditions and high temperatures.

The ALM2403-Q1 is capable of high output current with power-supply voltages up to 24 V. Internal power dissipation increases when operating at high supply voltages. The power dissipated in the op amp (P_{OPA}) is calculated using [Equation 4](#):

$$P_{OPA} = (V_S - V_{OUT}) \times I_{OUT} = (V_S - V_{OUT}) \times \frac{V_{OUT}}{R_L} \quad (4)$$

To calculate the worst-case power dissipation in the op amp, the ac and dc cases must be considered separately.

In the case of constant output current (dc) to a resistive load, the maximum power dissipation in the op amp occurs when the output voltage is half the positive supply voltage. This calculation assumes that the op amp is sourcing current from the positive supply to a grounded load. If the op amp sinks current from a grounded load, modify [Equation 5](#) to include the negative supply voltage instead of the positive.

$$P_{OPA(MAX_DC)} = P_{OPA}\left(\frac{V_S}{2}\right) = \frac{(V_S)^2}{4 \times R_L} \quad (5)$$

The ac maximum of average power dissipation in the op amp for a sinusoidal output current (ac) to a resistive load occurs when the peak output voltage is $2/\pi$ times the supply voltage, given symmetrical supply voltages, as shown in [Equation 6](#):

$$P_{OPA(PEAK_AC)} = P_{OPA}\left(\frac{2 \times V_S}{\pi}\right) = \frac{2 \times (V_S)^2}{\pi^2 \times R_L} \quad (6)$$

After the total power dissipation is determined, the junction temperature at the worst expected ambient temperature case must be determined by using [Equation 7](#):

$$T_{J(MAX)} = P_{OPA} \times R_{\theta JA} + T_{A(MAX)} \quad (7)$$

8.2.2.2.1 Improving Package Thermal Performance

The value of $R_{\theta JA}$ depends on the printed circuit board (PCB) layout. An external heat sink, a cooling mechanism such as a cold air fan, or both, can help reduce $R_{\theta JA}$, and thus improve device thermal capabilities. See TI's design support web page at www.ti.com/thermal for general guidance on improving device thermal performance.

8.2.3 Application Curves

The roll of characteristics and output waveform for the designed MFB filter are shown in Figure 8-4 and Figure 8-5. The attenuation is specified in Table 8-2.

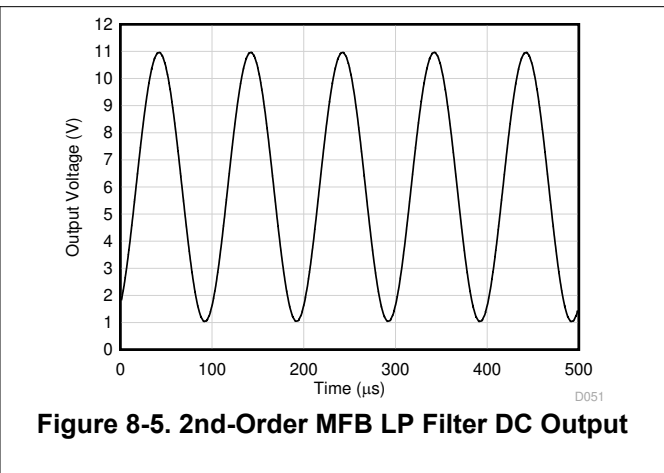
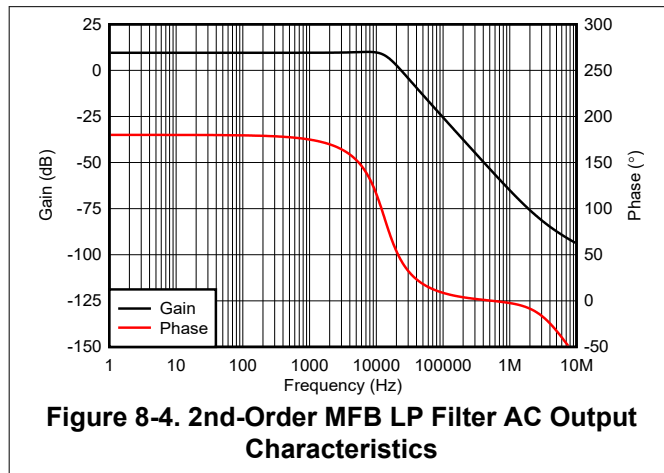

Table 8-2. Signal Attenuation vs Frequency

| 2ND-ORDER MFB LPF FREQUENCY (kHz) | ATTENUATION (dB) |
|-----------------------------------|------------------|
| DC | 9.54 |
| 10.0 | 9.70 |
| 15.4 | 6.54 |
| 19 | 3.54 |
| 30 | -4.38 |
| 320 | -45.9 |

8.3 Power Supply Recommendations

The ALM2403-Q1 is recommended for continuous operation from 5 V to 24 V (± 2.5 V to ± 12 V) for V_S , and many specifications apply from -40°C to $+125^\circ\text{C}$.

Place 0.1- μF bypass capacitors close to the power-supply pins to reduce errors coupling from noisy or high-impedance power supplies.

CAUTION

Supply voltages larger than 26 V can permanently damage the device (see Section 6.1).

8.4 Layout

8.4.1 Layout Guidelines

For best operational performance of the device, use good PCB layout practices, including:

- Noise can propagate into analog circuitry through the power pins of the circuit as a whole, as well as the operational amplifier. Bypass capacitors are used to reduce the coupled noise by providing low impedance power sources local to the analog circuitry.
 - Connect low-ESR, 0.1- μF ceramic bypass capacitors between each supply pin and ground, placed as close as possible to the device. A single bypass capacitor from $V+$ to ground is applicable for single-supply applications.
- Separate grounding for analog and digital portions of circuitry is one of the simplest and most-effective methods of noise suppression. One or more layers on multilayer PCBs are usually devoted to ground planes.

A ground plane helps distribute heat and reduces EMI noise pickup. Make sure to physically separate digital and analog grounds, paying attention to the flow of the ground current. For more detailed information, see [Circuit Board Layout Techniques](#).

- To reduce parasitic coupling, run the input traces as far away as possible from the supply or output traces. If keeping the traces separate is not possible, then cross the sensitive trace perpendicular, as opposed to in parallel with the noisy trace.
- Keep the length of input traces as short as possible. Always remember that the input traces are the most sensitive part of the circuit.

8.4.2 Layout Example

This layout does not verify optimum thermal impedance performance. See TI's design support web page at www.ti.com/thermal for general guidance on improving device thermal performance.

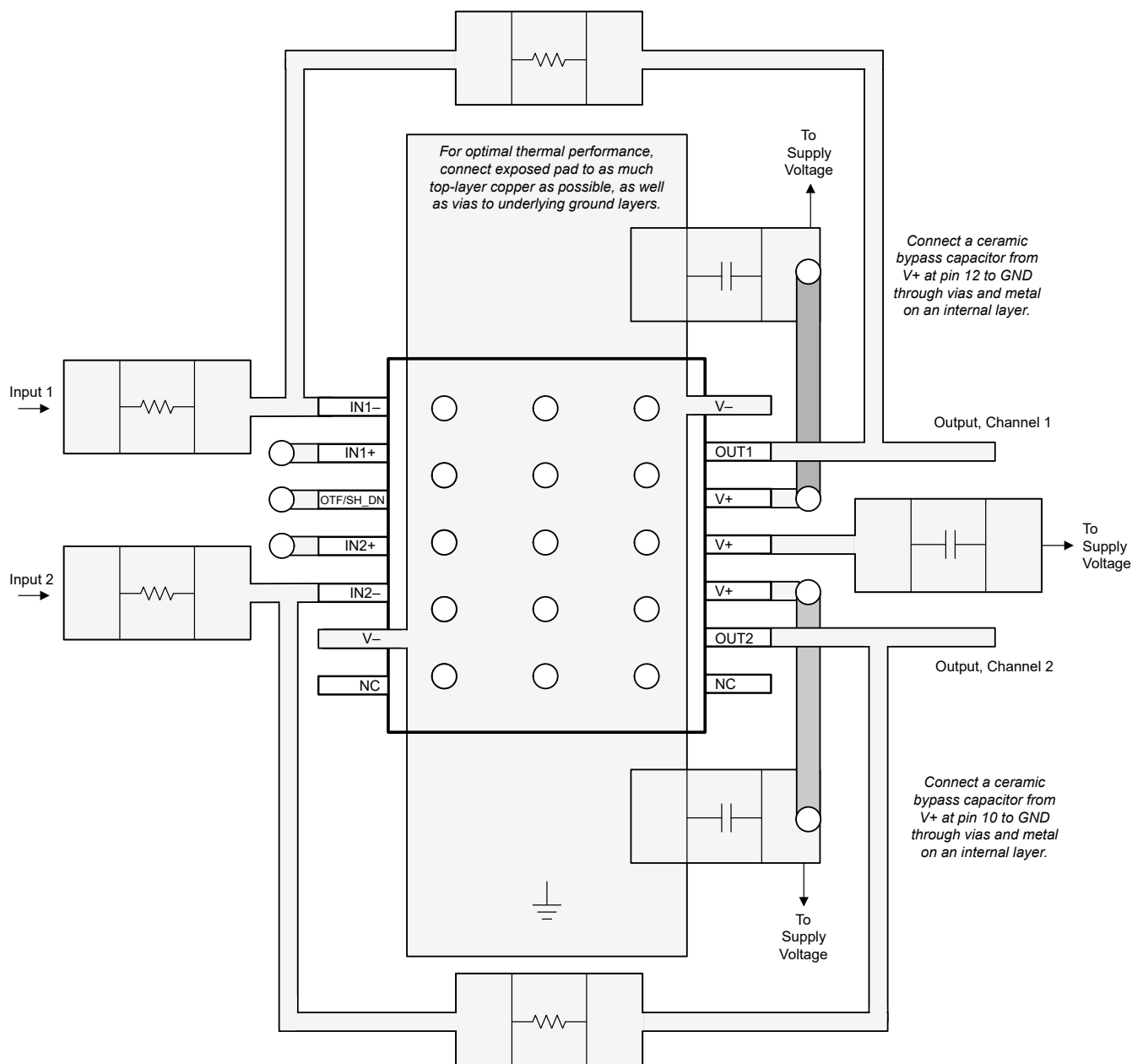

Figure 8-6. ALM2403-Q1 Layout Example

9 Device and Documentation Support

9.1 Documentation Support

9.1.1 Related Documentation

For related documentation see the following: [ALM2403-Q1 Evaluation Module user's guide](#).

9.2 Receiving Notification of Documentation Updates

To receive notification of documentation updates, navigate to the device product folder on [ti.com](#). Click on *Subscribe to updates* to register and receive a weekly digest of any product information that has changed. For change details, review the revision history included in any revised document.

9.3 Support Resources

[TI E2E™ support forums](#) are an engineer's go-to source for fast, verified answers and design help — straight from the experts. Search existing answers or ask your own question to get the quick design help you need.

Linked content is provided "AS IS" by the respective contributors. They do not constitute TI specifications and do not necessarily reflect TI's views; see TI's [Terms of Use](#).

9.4 Trademarks

TI E2E™ is a trademark of Texas Instruments.
All trademarks are the property of their respective owners.

9.5 Electrostatic Discharge Caution



This integrated circuit can be damaged by ESD. Texas Instruments recommends that all integrated circuits be handled with appropriate precautions. Failure to observe proper handling and installation procedures can cause damage.

ESD damage can range from subtle performance degradation to complete device failure. Precision integrated circuits may be more susceptible to damage because very small parametric changes could cause the device not to meet its published specifications.

9.6 Glossary

[TI Glossary](#) This glossary lists and explains terms, acronyms, and definitions.

10 Mechanical, Packaging, and Orderable Information

The following pages include mechanical, packaging, and orderable information. This information is the most current data available for the designated devices. This data is subject to change without notice and revision of this document. For browser-based versions of this data sheet, refer to the left-hand navigation.

PACKAGING INFORMATION

| Orderable Device | Status (1) | Package Type | Package Drawing | Pins | Package Qty | Eco Plan (2) | Lead finish/ Ball material (6) | MSL Peak Temp (3) | Op Temp (°C) | Device Marking (4/5) | Samples |
|------------------|---------------|--------------|-----------------|------|-------------|-----------------|--------------------------------------|----------------------|--------------|-------------------------|---------|
| ALM2403QPWPRQ1 | ACTIVE | HTSSOP | PWP | 14 | 2000 | RoHS & Green | NIPDAU | Level-3-260C-168 HR | -40 to 125 | A2403Q | Samples |

(1) The marketing status values are defined as follows:

ACTIVE: Product device recommended for new designs.

LIFEBUY: TI has announced that the device will be discontinued, and a lifetime-buy period is in effect.

NRND: Not recommended for new designs. Device is in production to support existing customers, but TI does not recommend using this part in a new design.

PREVIEW: Device has been announced but is not in production. Samples may or may not be available.

OBSELETE: TI has discontinued the production of the device.

(2) **RoHS:** TI defines "RoHS" to mean semiconductor products that are compliant with the current EU RoHS requirements for all 10 RoHS substances, including the requirement that RoHS substance do not exceed 0.1% by weight in homogeneous materials. Where designed to be soldered at high temperatures, "RoHS" products are suitable for use in specified lead-free processes. TI may reference these types of products as "Pb-Free".

RoHS Exempt: TI defines "RoHS Exempt" to mean products that contain lead but are compliant with EU RoHS pursuant to a specific EU RoHS exemption.

Green: TI defines "Green" to mean the content of Chlorine (Cl) and Bromine (Br) based flame retardants meet JS709B low halogen requirements of <=1000ppm threshold. Antimony trioxide based flame retardants must also meet the <=1000ppm threshold requirement.

(3) MSL, Peak Temp. - The Moisture Sensitivity Level rating according to the JEDEC industry standard classifications, and peak solder temperature.

(4) There may be additional marking, which relates to the logo, the lot trace code information, or the environmental category on the device.

(5) Multiple Device Markings will be inside parentheses. Only one Device Marking contained in parentheses and separated by a "-" will appear on a device. If a line is indented then it is a continuation of the previous line and the two combined represent the entire Device Marking for that device.

(6) Lead finish/Ball material - Orderable Devices may have multiple material finish options. Finish options are separated by a vertical ruled line. Lead finish/Ball material values may wrap to two lines if the finish value exceeds the maximum column width.

Important Information and Disclaimer:The information provided on this page represents TI's knowledge and belief as of the date that it is provided. TI bases its knowledge and belief on information provided by third parties, and makes no representation or warranty as to the accuracy of such information. Efforts are underway to better integrate information from third parties. TI has taken and continues to take reasonable steps to provide representative and accurate information but may not have conducted destructive testing or chemical analysis on incoming materials and chemicals. TI and TI suppliers consider certain information to be proprietary, and thus CAS numbers and other limited information may not be available for release.

In no event shall TI's liability arising out of such information exceed the total purchase price of the TI part(s) at issue in this document sold by TI to Customer on an annual basis.

TAPE AND REEL INFORMATION

QUADRANT ASSIGNMENTS FOR PIN 1 ORIENTATION IN TAPE

*All dimensions are nominal

| Device | Package Type | Package Drawing | Pins | SPQ | Reel Diameter (mm) | Reel Width W1 (mm) | A0 (mm) | B0 (mm) | K0 (mm) | P1 (mm) | W (mm) | Pin1 Quadrant |
|---------------|--------------|-----------------|------|------|--------------------|--------------------|---------|---------|---------|---------|--------|---------------|
| ALM2403QPWRQ1 | HTSSOP | PWP | 14 | 2000 | 330.0 | 12.4 | 6.9 | 5.6 | 1.6 | 8.0 | 12.0 | Q1 |

TAPE AND REEL BOX DIMENSIONS

*All dimensions are nominal

| Device | Package Type | Package Drawing | Pins | SPQ | Length (mm) | Width (mm) | Height (mm) |
|----------------|--------------|-----------------|------|------|-------------|------------|-------------|
| ALM2403QPWPRQ1 | HTSSOP | PWP | 14 | 2000 | 356.0 | 356.0 | 35.0 |

GENERIC PACKAGE VIEW

PWP 14

PowerPAD TSSOP - 1.2 mm max height

4.4 x 5.0, 0.65 mm pitch

PLASTIC SMALL OUTLINE

This image is a representation of the package family, actual package may vary.
Refer to the product data sheet for package details.

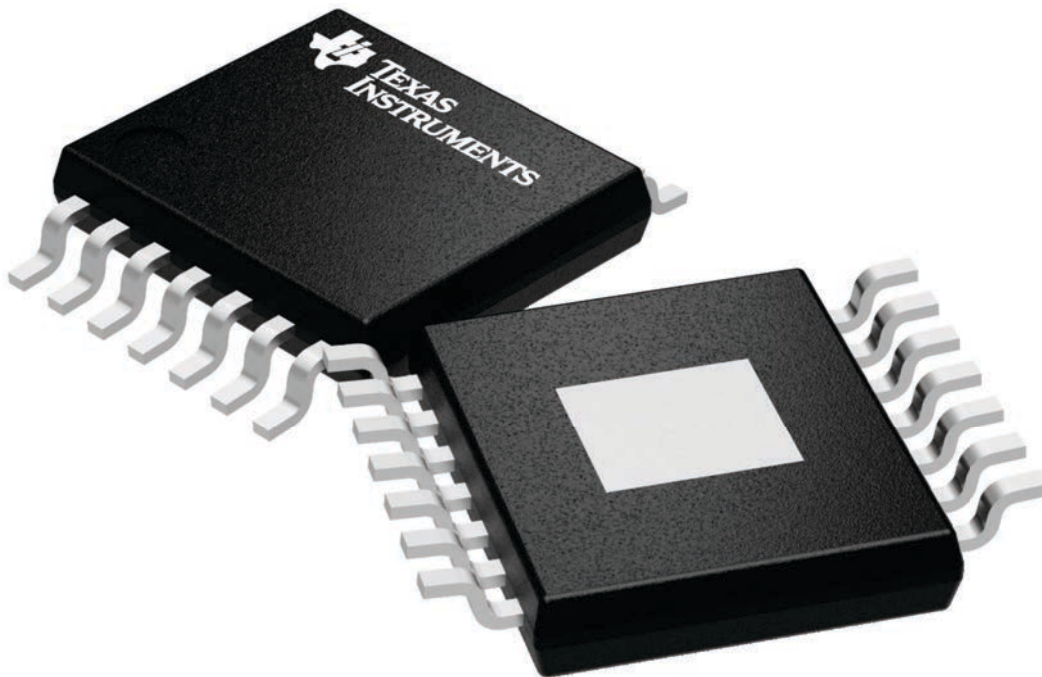

4224995/A

IMPORTANT NOTICE AND DISCLAIMER

TI PROVIDES TECHNICAL AND RELIABILITY DATA (INCLUDING DATA SHEETS), DESIGN RESOURCES (INCLUDING REFERENCE DESIGNS), APPLICATION OR OTHER DESIGN ADVICE, WEB TOOLS, SAFETY INFORMATION, AND OTHER RESOURCES "AS IS" AND WITH ALL FAULTS, AND DISCLAIMS ALL WARRANTIES, EXPRESS AND IMPLIED, INCLUDING WITHOUT LIMITATION ANY IMPLIED WARRANTIES OF MERCHANTABILITY, FITNESS FOR A PARTICULAR PURPOSE OR NON-INFRINGEMENT OF THIRD PARTY INTELLECTUAL PROPERTY RIGHTS.

These resources are intended for skilled developers designing with TI products. You are solely responsible for (1) selecting the appropriate TI products for your application, (2) designing, validating and testing your application, and (3) ensuring your application meets applicable standards, and any other safety, security, regulatory or other requirements.

These resources are subject to change without notice. TI grants you permission to use these resources only for development of an application that uses the TI products described in the resource. Other reproduction and display of these resources is prohibited. No license is granted to any other TI intellectual property right or to any third party intellectual property right. TI disclaims responsibility for, and you will fully indemnify TI and its representatives against, any claims, damages, costs, losses, and liabilities arising out of your use of these resources.

TI's products are provided subject to [TI's Terms of Sale](#) or other applicable terms available either on [ti.com](https://www.ti.com) or provided in conjunction with such TI products. TI's provision of these resources does not expand or otherwise alter TI's applicable warranties or warranty disclaimers for TI products.

TI objects to and rejects any additional or different terms you may have proposed.

Mailing Address: Texas Instruments, Post Office Box 655303, Dallas, Texas 75265
Copyright © 2024, Texas Instruments Incorporated