

AMC23C15 Dual, Fast Response, Reinforced Isolated Window Comparator With Adjustable Threshold

1 Features

- Wide high-side supply range: 3V to 27V
- Low-side supply range: 2.7V to 5.5V
- Dual window comparator:
 - Window comparator 1: $\pm 5\text{mV}$ to $\pm 300\text{mV}$ adjustable threshold
 - Window comparator 2: $\pm 60\text{mV}$ fixed threshold
- Supports positive-comparator mode:
 - Cmp0: 600mV to 2.7V adjustable threshold
 - Cmp2: 60mV fixed threshold
 - Cmp1 and Cmp3: Disabled
- Reference current for threshold adjustment: $100\mu\text{A}$, $\pm 1\%$
- Trip threshold error: $\pm 1\%$ (max) at 250mV
- Open-drain outputs
- Propagation delay: 280ns (typ)
- High CMTI: 15V/ns (min)
- Safety-related certifications:
 - 7000V_{PK} reinforced isolation per DIN EN IEC 60747-17 (VDE 0884-17)
 - 5000V_{RMS} isolation for 1 minute per UL1577
- Fully specified over the extended industrial temperature range: -40°C to $+125^\circ\text{C}$

2 Applications

- Overcurrent or overvoltage detection in:
 - [Solid-state relays \(SSR\)](#)
 - [Motor drives](#)
 - [Frequency inverters](#)
 - [Solar inverters](#)
 - [DC/DC converters](#)

3 Description

The AMC23C15 is a dual, isolated window comparator with a short response time. The open-drain outputs are separated from the input circuitry by an isolation barrier that is highly resistant to magnetic interference. This barrier is certified to provide reinforced galvanic isolation of up to 5kV_{RMS} according to VDE 0884-17 and UL1577, and supports a working voltage of up to 1kV_{RMS} .

Both comparators have windows that are centered around 0V, meaning that the comparators trip if the input exceeds the thresholds in a positive or negative direction. One comparator has fixed thresholds of $\pm 60\text{mV}$. The second comparator has adjustable thresholds from $\pm 5\text{mV}$ to $\pm 300\text{mV}$ through a single external resistor.

The AMC23C15 also supports a positive-comparator only mode. When the voltage on the REF pin is greater than 550mV, the negative comparators are disabled and only the positive comparators are functional. The reference voltage in this mode can be as high as 2.7V. This mode is particularly useful for monitoring positive voltage supplies.

The AMC23C15 is available in an 8-pin, wide-body SOIC package and is specified over the extended industrial temperature range of -40°C to $+125^\circ\text{C}$.

Package Information

PART NUMBER	PACKAGE ⁽¹⁾	PACKAGE SIZE ⁽²⁾
AMC23C15	DWV (SOIC, 8)	5.85mm × 11.5mm

- (1) For all available packages, see the orderable addendum at the end of the data sheet.
- (2) The package size (length × width) is a nominal value and includes pins, where applicable.

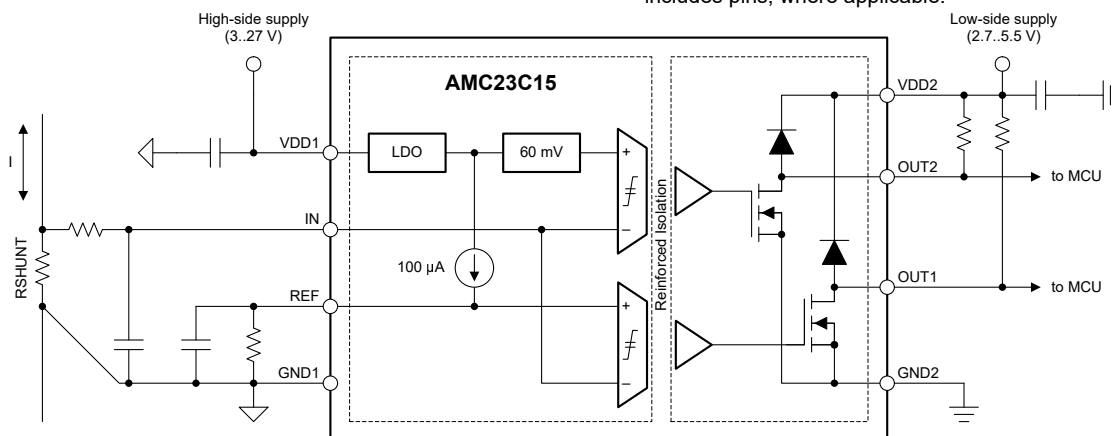

Typical Application



Table of Contents

1 Features	1	6.2 Functional Block Diagram.....	22
2 Applications	1	6.3 Feature Description.....	23
3 Description	1	6.4 Device Functional Modes.....	29
4 Pin Configuration and Functions	3	7 Application and Implementation	29
5 Specifications	4	7.1 Application Information.....	29
5.1 Absolute Maximum Ratings.....	4	7.2 Typical Application.....	29
5.2 ESD Ratings.....	4	7.3 Best Design Practices.....	32
5.3 Recommended Operating Conditions.....	5	7.4 Power Supply Recommendations.....	33
5.4 Thermal Information	5	7.5 Layout.....	33
5.5 Power Ratings.....	5	8 Device and Documentation Support	34
5.6 Insulation Specifications (Reinforced Isolation).....	6	8.1 Documentation Support.....	34
5.7 Safety-Related Certifications	7	8.2 Receiving Notification of Documentation Updates...	34
5.8 Safety Limiting Values	7	8.3 Support Resources.....	34
5.9 Electrical Characteristics	8	8.4 Trademarks.....	34
5.10 Switching Characteristics	10	8.5 Electrostatic Discharge Caution.....	34
5.11 Timing Diagrams.....	10	8.6 Glossary.....	34
5.12 Insulation Characteristics Curves.....	11	9 Revision History	34
5.13 Typical Characteristics.....	12	10 Mechanical, Packaging, and Orderable Information	35
6 Detailed Description	22		
6.1 Overview.....	22		

4 Pin Configuration and Functions

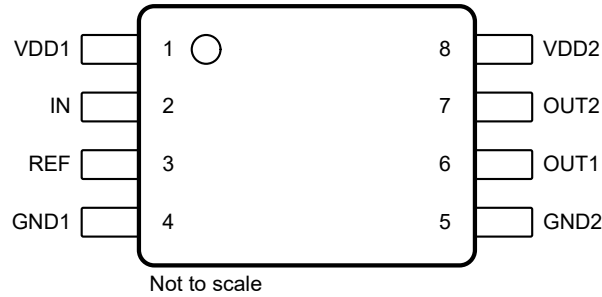

Figure 4-1. DWV Package, 8-Pin SOIC (Top View)

Table 4-1. Pin Functions

PIN		TYPE	DESCRIPTION
NO.	NAME		
1	VDD1	High-side power	High-side power supply. ⁽¹⁾
2	IN	Analog input	Common analog input pin for window comparator 1 and 2.
3	REF	Analog input	Reference pin that defines the trip threshold for window comparator 1. The voltage on this pin also affects the hysteresis of comparator Cmp0, as explained in the Reference Input section. This pin is internally connected to a 100- μ A current source. Connect a resistor from REF to GND1 to define the trip threshold, and a capacitor from REF to GND1 to filter the reference voltage. For best transient noise immunity, place the capacitor as closely to the pin as possible. This pin can also be driven by an external voltage source.
4	GND1	High-side ground	High-side ground.
5	GND2	Low-side ground	Low-side ground.
6	OUT1	Digital output	Open-drain output of window comparator 1. Connect to an external pullup resistor or leave unconnected (floating) when not used.
7	OUT2	Digital output	Open-drain output of window comparator 2. Connect to an external pullup resistor or leave unconnected (floating) when not used.
8	VDD2	Low-side power	Low-side power supply. ⁽¹⁾

(1) See the [Layout](#) section for power-supply decoupling recommendations.

5 Specifications

5.1 Absolute Maximum Ratings

see⁽¹⁾

		MIN	MAX	UNIT
Power-supply voltage	VDD1 to GND1	-0.3	30	V
	VDD2 to GND2	-0.3	6.5	
Analog input voltage	REF to GND1	-0.5	6.5	V
	IN to GND1	-6	5.5	
Digital output voltage	OUT1, OUT2 to GND2	-0.5	VDD2 + 0.5	V
Input current	Continuous, any pin except power-supply pins	-10	10	mA
Temperature	Junction, T _J		150	°C
	Storage, T _{stg}	-65	150	

- (1) Operation outside the *Absolute Maximum Ratings* may cause permanent device damage. *Absolute Maximum Ratings* do not imply functional operation of the device at these or any other conditions beyond those listed under *Recommended Operating Conditions*. If used outside the *Recommended Operating Conditions* but within the *Absolute Maximum Ratings*, the device may not be fully functional, and this may affect device reliability, functionality, performance, and shorten the device lifetime.

5.2 ESD Ratings

			VALUE	UNIT
V _(ESD)	Electrostatic discharge	Human-body model (HBM), per ANSI/ESDA/JEDEC JS-001 ⁽¹⁾	±2000	V
		Charged-device model (CDM), per ANSI/ESDA/JEDEC JS-002 ⁽²⁾	±1000	

- (1) JEDEC document JEP155 states that 500-V HBM allows safe manufacturing with a standard ESD control process.
 (2) JEDEC document JEP157 states that 250-V CDM allows safe manufacturing with a standard ESD control process.

5.3 Recommended Operating Conditions

over operating ambient temperature range (unless otherwise noted)

			MIN	NOM	MAX	UNIT
POWER SUPPLY						
V _{VDD1}	High-side power-supply voltage	VDD1 to GND1	3.0	5	27	V
V _{VDD2}	Low-side power supply voltage	VDD2 to GND2	2.7	3.3	5.5	V
ANALOG INPUT						
V _{IN}	Input voltage	IN to GND1, VDD1 ≤ 4.3 V	-0.4	VDD1 - 0.3		V
		IN to GND1, VDD1 > 4.3 V	-0.4	4		
V _{REF}	Reference voltage, window comparator mode	REF to GND1	20 ⁽²⁾	300		mV
	Reference voltage, positive-comparator mode	Low hysteresis mode	20 ⁽²⁾	450		
		High hysteresis mode (Cmp0 only)	600	2700 ⁽¹⁾		
	Reference voltage headroom	VDD1 - V _{REF}	1.4			V
	Filter capacitance on REF pin		20	100	nF	
DIGITAL OUTPUTS						
	Digital output voltage	OUT1, OUT2 to GND2	GND2		VDD2	V
	Sink current	OUT1, OUT2	0	4		mA
TEMPERATURE RANGE						
T _A	Specified ambient temperature		-40	25	125	°C

- (1) Reference voltages (V_{REF}) > 1.6V require V_{VDD1} > V_{VDD1,MIN} to maintain minimum headroom (V_{VDD1} - V_{REF}) of 1.4V.
(2) The device has been tested with V_{REF} as low as 5mV. The device remains functional but relative switching threshold accuracy can decrease because of offset errors.

5.4 Thermal Information

THERMAL METRIC ⁽¹⁾		DWV (SOIC)	UNIT
		8 PINS	
R _{θJA}	Junction-to-ambient thermal resistance	102.8	°C/W
R _{θJC(top)}	Junction-to-case (top) thermal resistance	45.1	°C/W
R _{θJB}	Junction-to-board thermal resistance	63.0	°C/W
Ψ _{JT}	Junction-to-top characterization parameter	14.3	°C/W
Ψ _{JB}	Junction-to-board characterization parameter	61.1	°C/W
R _{θJC(bot)}	Junction-to-case (bottom) thermal resistance	n/a	°C/W

- (1) For more information about traditional and new thermal metrics, see the [Semiconductor and IC Package Thermal Metrics](#) application note.

5.5 Power Ratings

PARAMETER	TEST CONDITIONS	VALUE	UNIT
P _D	VDD1 = 25 V, VDD2 = 5.5 V	110	mW
	VDD1 = VDD2 = 5.5 V	34	
	VDD1 = VDD2 = 3.6 V	22	
P _{D1}	VDD1 = 25 V	98	mW
	VDD1 = 5.5 V	21	
	VDD1 = 3.6 V	14	
P _{D2}	VDD2 = 5.5 V	12	mW
	VDD2 = 3.6 V	8	

5.6 Insulation Specifications (Reinforced Isolation)

over operating ambient temperature range (unless otherwise noted)

PARAMETER		TEST CONDITIONS	VALUE	UNIT
GENERAL				
CLR	External clearance ⁽¹⁾	Shortest pin-to-pin distance through air	≥ 8.5	mm
CPG	External creepage ⁽¹⁾	Shortest pin-to-pin distance across the package surface	≥ 8.5	mm
DTI	Distance through insulation	Minimum internal gap (internal clearance) of the double insulation	≥ 15.4	μm
CTI	Comparative tracking index	DIN EN 60112 (VDE 0303-11); IEC 60112	≥ 600	V
	Material group	According to IEC 60664-1	I	
	Overvoltage category per IEC 60664-1	Rated mains voltage ≤ 600V _{RMS}	I-III	
		Rated mains voltage ≤ 1000V _{RMS}	I-II	
DIN EN IEC 60747-17 (VDE 0884-17)⁽²⁾				
V _{IORM}	Maximum repetitive peak isolation voltage	At AC voltage	1410	V _{PK}
V _{IOWM}	Maximum-rated isolation working voltage	At AC voltage (sine wave)	1000	V _{RMS}
		At DC voltage	1410	V _{DC}
V _{IOTM}	Maximum transient isolation voltage	V _{TEST} = V _{IOTM} , t = 60s (qualification test), V _{TEST} = 1.2 × V _{IOTM} , t = 1s (100% production test)	7070	V _{PK}
V _{IMP}	Maximum impulse voltage ⁽³⁾	Tested in air, 1.2/50μs waveform per IEC 62368-1	7700	V _{PK}
V _{IOSM}	Maximum surge isolation voltage ⁽⁴⁾	Tested in oil (qualification test), 1.2/50μs waveform per IEC 62368-1	10000	V _{PK}
q _{pd}	Apparent charge ⁽⁵⁾	Method a, after input/output safety test subgroups 2 and 3, V _{pd(ini)} = V _{IOTM} , t _{ini} = 60s, V _{pd(m)} = 1.2 × V _{IORM} , t _m = 10s	≤ 5	pC
		Method a, after environmental tests subgroup 1, V _{pd(ini)} = V _{IOTM} , t _{ini} = 60s, V _{pd(m)} = 1.6 × V _{IORM} , t _m = 10s	≤ 5	
		Method b1, at preconditioning (type test) and routine test, V _{pd(ini)} = 1.2 × V _{IOTM} , t _{ini} = 1s, V _{pd(m)} = 1.875 × V _{IORM} , t _m = 1s	≤ 5	
		Method b2, at routine test (100% production) ⁽⁷⁾ V _{pd(ini)} = V _{pd(m)} = 1.2 × V _{IOTM} , t _{ini} = t _m = 1s	≤ 5	
C _{IO}	Barrier capacitance, input to output ⁽⁶⁾	V _{IO} = 0.5 V _{PP} at 1MHz	≅ 1.5	pF
R _{IO}	Insulation resistance, input to output ⁽⁶⁾	V _{IO} = 500V at T _A = 25°C	> 10 ¹²	Ω
		V _{IO} = 500V at 100°C ≤ T _A ≤ 125°C	> 10 ¹¹	
		V _{IO} = 500V at T _S = 150°C	> 10 ⁹	
	Pollution degree		2	
	Climatic category		55/125/21	
UL1577				
V _{ISO}	Withstand isolation voltage	V _{TEST} = V _{ISO} , t = 60s (qualification test), V _{TEST} = 1.2 × V _{ISO} , t = 1s (100% production test)	5000	V _{RMS}

- (1) Apply creepage and clearance requirements according to the specific equipment isolation standards of an application. Care must be taken to maintain the creepage and clearance distance of a board design to ensure that the mounting pads of the isolator on the printed circuit board (PCB) do not reduce this distance. Creepage and clearance on a PCB become equal in certain cases. Techniques such as inserting grooves, ribs, or both on a PCB are used to help increase these specifications.
- (2) This coupler is suitable for *safe electrical insulation* only within the safety ratings. Compliance with the safety ratings shall be ensured by means of suitable protective circuits.
- (3) Testing is carried out in air to determine the surge immunity of the package.
- (4) Testing is carried in oil to determine the intrinsic surge immunity of the isolation barrier.
- (5) Apparent charge is electrical discharge caused by a partial discharge (pd).
- (6) All pins on each side of the barrier are tied together, creating a two-pin device.
- (7) Either method b1 or b2 is used in production.

5.7 Safety-Related Certifications

VDE	UL
DIN EN IEC 60747-17 (VDE 0884-17), EN IEC 60747-17, DIN EN IEC 62368-1 (VDE 0868-1), EN IEC 62368-1, IEC 62368-1 Clause : 5.4.3 ; 5.4.4.4 ; 5.4.9	Recognized under 1577 component recognition and CSA component acceptance NO 5 programs
Reinforced insulation	Single protection
Certificate number: 40040142	File number: E181974

5.8 Safety Limiting Values

Safety limiting⁽¹⁾ intends to minimize potential damage to the isolation barrier upon failure of input or output circuitry. A failure of the I/O can allow low resistance to ground or the supply and, without current limiting, dissipate sufficient power to overheat the die and damage the isolation barrier potentially leading to secondary system failures.

PARAMETER		TEST CONDITIONS	MIN	TYP	MAX	UNIT
I _S	Safety input, output, or supply current	R _{θJA} = 102.8°C/W, VDD1 = VDD2 = 5.5 V, T _J = 150°C, T _A = 25°C			220	mA
		R _{θJA} = 102.8°C/W, VDD1 = VDD2 = 3.6 V, T _J = 150°C, T _A = 25°C			340	
P _S	Safety input, output, or total power	R _{θJA} = 102.8°C/W, T _J = 150°C, T _A = 25°C			1220	mW
T _S	Maximum safety temperature				150	°C

- (1) The maximum safety temperature, T_S, has the same value as the maximum junction temperature, T_J, specified for the device. The I_S and P_S parameters represent the safety current and safety power, respectively. Do not exceed the maximum limits of I_S and P_S. These limits vary with the ambient temperature, T_A.
The junction-to-air thermal resistance, R_{θJA}, in the *Thermal Information* table is that of a device installed on a high-K test board for leaded surface-mount packages. Use these equations to calculate the value for each parameter:
T_J = T_A + R_{θJA} × P, where P is the power dissipated in the device.
T_{J(max)} = T_S = T_A + R_{θJA} × P_S, where T_{J(max)} is the maximum junction temperature.
P_S = I_S × AVDD_{max} + I_S × DVDD_{max}, where AVDD_{max} is the maximum high-side voltage and DVDD_{max} is the maximum controller-side supply voltage.

5.9 Electrical Characteristics

minimum and maximum specifications apply from $T_A = -40^{\circ}\text{C}$ to 125°C , $V_{DD1} = 3.0\text{ V}$ to 27 V , $V_{DD2} = 2.7\text{ V}$ to 5.5 V , $V_{REF} = 20\text{ mV}$ to $2.7\text{ V}^{(1)}$, and $V_{IN} = -400\text{ mV}$ to $4\text{ V}^{(3)}$; typical specifications are at $T_A = 25^{\circ}\text{C}$, $V_{DD1} = 5\text{ V}$, $V_{DD2} = 3.3\text{ V}$, and $V_{REF} = 250\text{ mV}$ (unless otherwise noted)

PARAMETER		TEST CONDITIONS	MIN	TYP	MAX	UNIT
ANALOG INPUT						
R_{IN}	Input resistance	IN pin, $0 \leq V_{IN} \leq 4\text{ V}$		1		$\text{G}\Omega$
I_{BIAS}	Input bias current	IN pin, $0 \leq V_{IN} \leq 4\text{ V}^{(4)}$		0.1	25	nA
		IN pin, $-400\text{ mV} \leq V_{IN} \leq 0\text{ V}^{(5)}$	-310	-0.5		
C_{IN}	Input capacitance	IN pin		4		pF
REFERENCE PIN						
I_{REF}	Reference current	REF to GND1, $20\text{ mV} < V_{REF} \leq 2.7\text{ V}$	99	100	101	μA
V_{MSEL}	Mode selection threshold ⁽²⁾	V_{REF} rising	500	550	600	mV
		V_{REF} falling	450	500	550	
	Mode selection threshold hysteresis			50		mV
60-mV FIXED-THRESHOLD COMPARATORS (CMP2 and CMP3)						
V_{IT+}	Positive-going trip threshold	Cmp2		64		mV
E_{IT+}	Positive-going trip threshold error	Cmp2	-3.5		3.5	mV
V_{IT-}	Negative-going trip threshold	Cmp2		60		mV
E_{IT-}	Negative-going trip threshold error	Cmp2	-3.5		3.5	mV
V_{IT-}	Negative-going trip threshold	Cmp3		-64		mV
E_{IT-}	Negative-going trip threshold error	Cmp3	-4.5		4.5	mV
V_{IT+}	Positive-going trip threshold	Cmp3		-60		mV
E_{IT+}	Positive-going trip threshold error	Cmp3	-4.5		4.5	mV
V_{HYS}	Trip threshold hysteresis	Cmp2 and Cmp3; $(V_{IT+} - V_{IT-})$		4		mV
VARIABLE-THRESHOLD COMPARATORS (CMP0 AND CMP1)						
V_{IT+}	Positive-going trip threshold	Cmp0		$V_{REF} + V_{HYS}$		mV
E_{IT+}	Positive-going trip threshold error	Cmp0, $(V_{IT+} - V_{REF} - V_{HYS})$, $V_{REF} = 20\text{ mV}$, $V_{HYS} = 4\text{ mV}$	-2		2	mV
		Cmp0, $(V_{IT+} - V_{REF} - V_{HYS})$, $V_{REF} = 250\text{ mV}$, $V_{HYS} = 4\text{ mV}$	-2		2	
		Cmp0, $(V_{IT+} - V_{REF} - V_{HYS})$, $V_{REF} = 2\text{ V}$, $V_{HYS} = 25\text{ mV}$	-5		5	
V_{IT-}	Negative-going trip threshold	Cmp0		V_{REF}		mV
E_{IT-}	Negative-going trip threshold error	Cmp0, $(V_{IT-} - V_{REF})$, $V_{REF} = 20\text{ mV}$	-2.5		2.5	mV
		Cmp0, $(V_{IT-} - V_{REF})$, $V_{REF} = 250\text{ mV}$	-2.5		2.5	
		Cmp0, $(V_{IT-} - V_{REF})$, $V_{REF} = 2\text{ V}$	-5		5	
V_{IT-}	Negative-going trip threshold	Cmp1		$-V_{REF} - V_{HYS}$		mV
E_{IT-}	Negative-going trip threshold error	Cmp1, $(V_{IT-} + V_{REF} + V_{HYS})$, $V_{REF} = 20\text{ mV}$, $V_{HYS} = 4\text{ mV}$	-3		3	mV
		Cmp1, $(V_{IT-} + V_{REF} + V_{HYS})$, $V_{REF} = 250\text{ mV}$, $V_{HYS} = 4\text{ mV}$	-3		3	
V_{IT+}	Positive-going trip threshold	Cmp1		$-V_{REF}$		mV
E_{IT+}	Positive-going trip threshold error	Cmp1, $(V_{IT+} + V_{REF})$, $V_{REF} = 20\text{ mV}$	-3.5		3.5	mV
		Cmp1, $(V_{IT+} + V_{REF})$, $V_{REF} = 250\text{ mV}$	-3.5		3.5	
V_{HYS}	Trip threshold hysteresis	Cmp0 and Cmp1, $(V_{IT+} - V_{IT-})$, $V_{REF} \leq 450\text{ mV}$		4		mV
		Cmp0 only, $(V_{IT+} - V_{IT-})$, $V_{REF} \geq 600\text{ mV}$		25		
DIGITAL OUTPUTS						
V_{OL}	Low-level output voltage	$I_{SINK} = 4\text{ mA}$		80	250	mV
I_{LKG}	Open-drain output leakage current	$V_{DD2} = 5\text{ V}$, $V_{OUT} = 5\text{ V}$		5	100	nA
CMTI	Common-mode transient immunity	$ V_{IN} - V_{REF} \geq 4\text{ mV}$, $R_{PULLUP} = 10\text{ k}\Omega$	15	40		V/ns

5.9 Electrical Characteristics (continued)

minimum and maximum specifications apply from $T_A = -40^\circ\text{C}$ to 125°C , $V_{DD1} = 3.0\text{ V}$ to 27 V , $V_{DD2} = 2.7\text{ V}$ to 5.5 V , $V_{REF} = 20\text{ mV}$ to 2.7 V ⁽¹⁾, and $V_{IN} = -400\text{ mV}$ to 4 V ⁽³⁾; typical specifications are at $T_A = 25^\circ\text{C}$, $V_{DD1} = 5\text{ V}$, $V_{DD2} = 3.3\text{ V}$, and $V_{REF} = 250\text{ mV}$ (unless otherwise noted)

PARAMETER		TEST CONDITIONS	MIN	TYP	MAX	UNIT
POWER SUPPLY						
VDD1 _{UV}	VDD1 undervoltage detection threshold	VDD1 rising			3	V
		VDD1 falling			2.9	
VDD1 _{POR}	VDD1 power-on reset threshold	VDD1 falling			2.3	V
VDD2 _{UV}	VDD2 undervoltage detection threshold	VDD2 rising			2.7	V
		VDD2 falling			2.1	
I _{DD1}	High-side supply current	3.0 V ≤ VDD1 ≤ 3.4 V			4.0	mA
		3.4 V < VDD1 ≤ 27 V		3.2	4.3	
I _{DD2}	Low-side supply current			1.8	2.2	mA

- (1) Reference voltages >1.6 V require $V_{DD1} > V_{DD1_{MIN}}$. See the *Recommended Operation Conditions* table for details.
- (2) The voltage level V_{REF} determines if the device operates as window-comparator with positive and negative thresholds or as simple comparator with positive thresholds only. See the *Reference Input* section for more details.
- (3) But not exceeding the maximum input voltage specified in the *Recommended Operation Conditions* table.
- (4) The typical value is measured at $V_{IN} = 0.4\text{ V}$.
- (5) The typical value is measured at $V_{IN} = -400\text{ mV}$.

5.10 Switching Characteristics

over operating ambient temperature range (unless otherwise noted)

PARAMETER	TEST CONDITIONS	MIN	TYP	MAX	UNIT	
OPEN-DRAIN OUTPUTS						
t_{pH}	Propagation delay time, $ V_{IN} $ rising ⁽¹⁾	$V_{DD2} = 3.3\text{ V}, V_{REF} = 250\text{ mV}, V_{OVERDRIVE} = 10\text{ mV}, C_L = 15\text{ pF}$		280	410	ns
		$V_{DD2} = 3.3\text{ V}, V_{REF} = 2\text{ V}, V_{OVERDRIVE} = 50\text{ mV}, C_L = 15\text{ pF}$		240	370	
t_{pL}	Propagation delay time, $ V_{IN} $ falling ⁽¹⁾	$V_{DD2} = 3.3\text{ V}, V_{REF} = 250\text{ mV}, V_{OVERDRIVE} = 10\text{ mV}, C_L = 15\text{ pF}$		280	410	ns
		$V_{DD2} = 3.3\text{ V}, V_{REF} = 2\text{ V}, V_{OVERDRIVE} = 50\text{ mV}, C_L = 15\text{ pF}$		240	370	
t_f	Output signal fall time	$R_{PULLUP} = 4.7\text{ k}\Omega, C_L = 15\text{ pF}$		2		ns
MODE SELECTION						
t_{HSEL}	Comparator hysteresis selection deglitch time	Cmp0, V_{REF} rising or falling		10		μs
t_{DIS13}	Comparator disable deglitch time	Cmp1 and Cmp3, V_{REF} rising		10		μs
t_{EN13}	Comparator enable deglitch time	Cmp1 and Cmp3, V_{REF} falling		100		μs
START-UP TIMING						
$t_{LS,STA}$	Low-side start-up time	V_{DD2} step to 2.7 V, $V_{DD1} \geq 3.0\text{ V}$		40		μs
$t_{HS,STA}$	High-side start-up time	V_{DD1} step to 3.0 V, $V_{DD2} \geq 2.7\text{ V}$		45		μs
$t_{HS,BLK}$	High-side blanking time			200		μs
$t_{HS,FLT}$	High-side-fault detection delay time			100		μs

(1) Valid for OUT1 and OUT2

5.11 Timing Diagrams

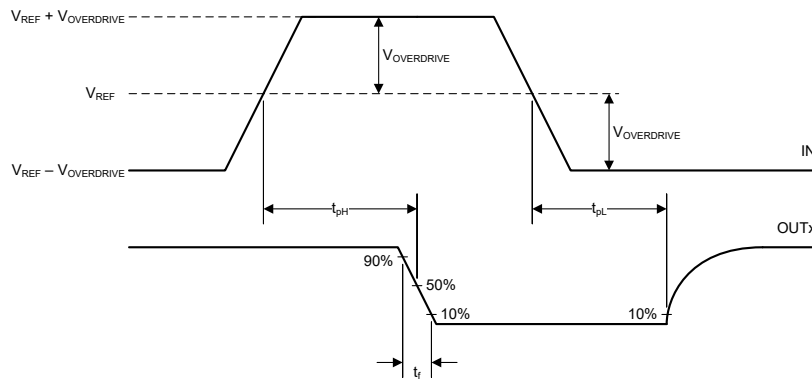

Figure 5-1. Rise, Fall, and Delay Time Definition

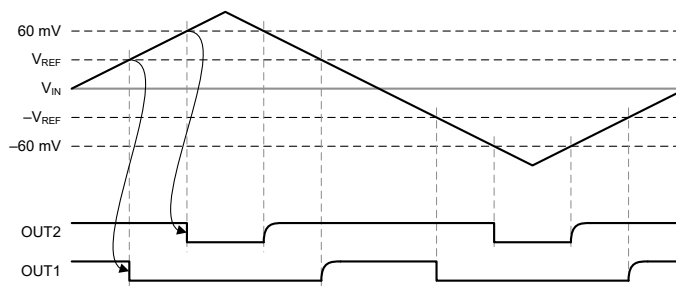

Figure 5-2. Functional Timing Diagram

5.12 Insulation Characteristics Curves

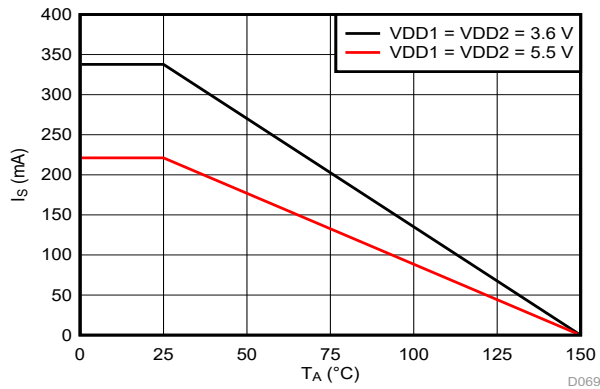

Figure 5-3. Thermal Derating Curve for Safety-Limiting Current per VDE

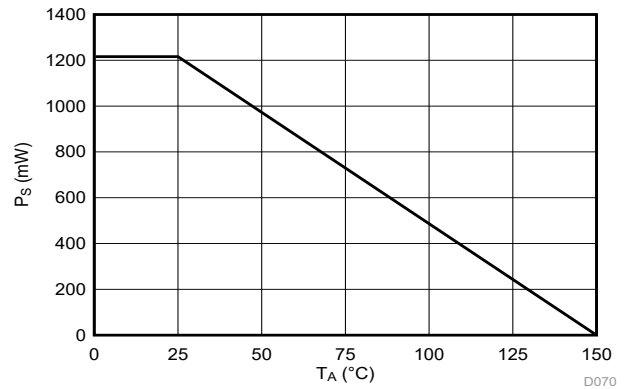
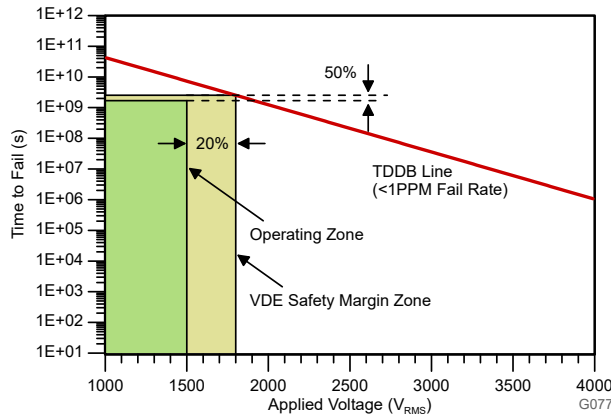

Figure 5-4. Thermal Derating Curve for Safety-Limiting Power per VDE



TA up to 150°C, stress-voltage frequency = 60Hz, isolation working voltage = 1000VRMS, operating lifetime > 400 years

Figure 5-5. Reinforced Isolation Capacitor Lifetime Projection

5.13 Typical Characteristics

At VDD1 = 5V and VDD2 = 3.3V (unless otherwise noted)

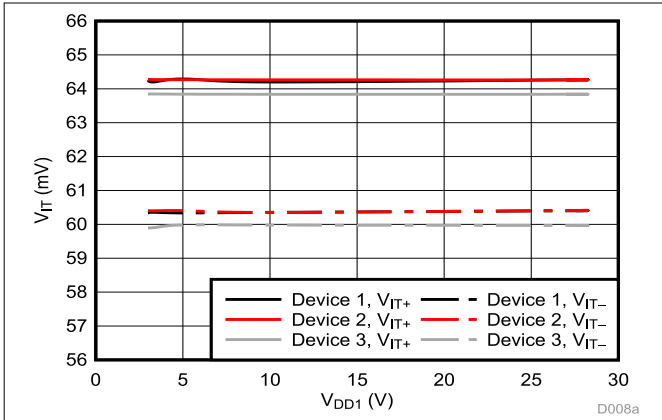

Figure 5-6. Cmp2 Trip Threshold vs Supply Voltage

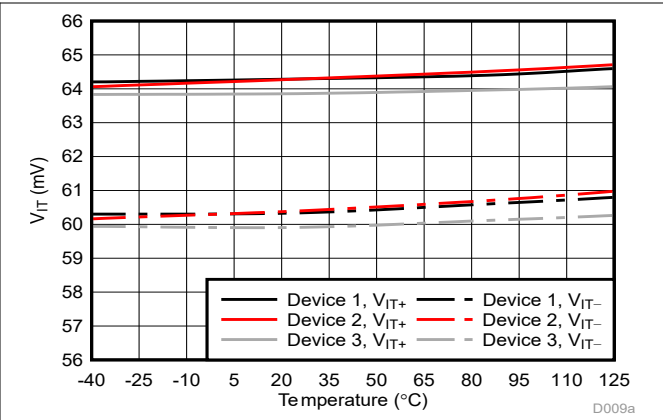

Figure 5-7. Cmp2 Trip Threshold vs Temperature

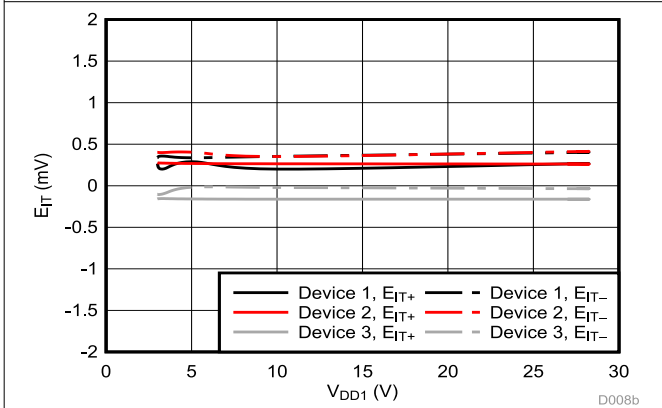

Figure 5-8. Cmp2 Trip Threshold Error vs Supply Voltage

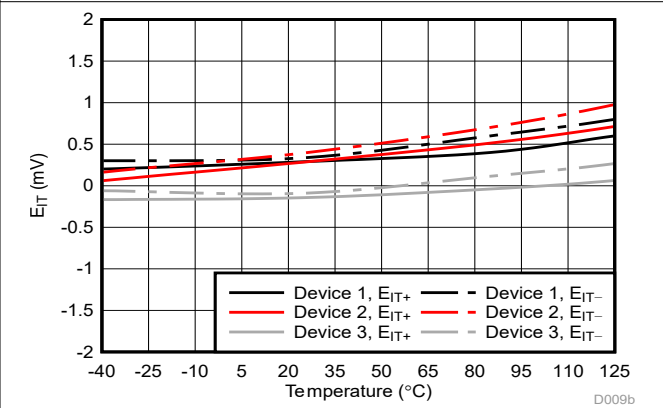

Figure 5-9. Cmp2 Trip Threshold Error vs Temperature

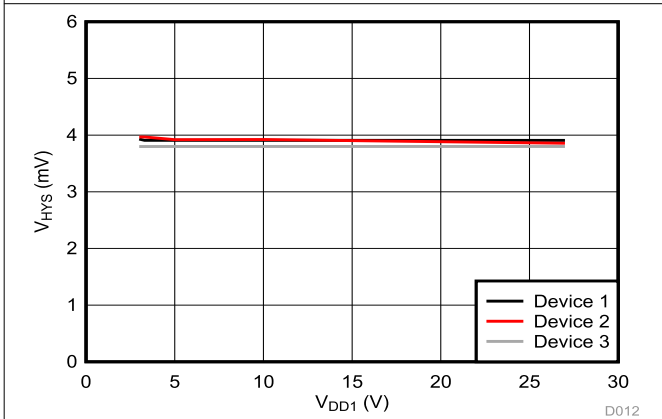

Figure 5-10. Cmp2 Trip Threshold Hysteresis vs Supply Voltage

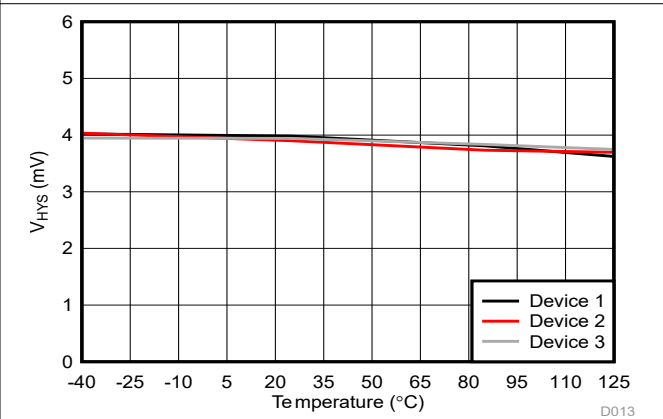
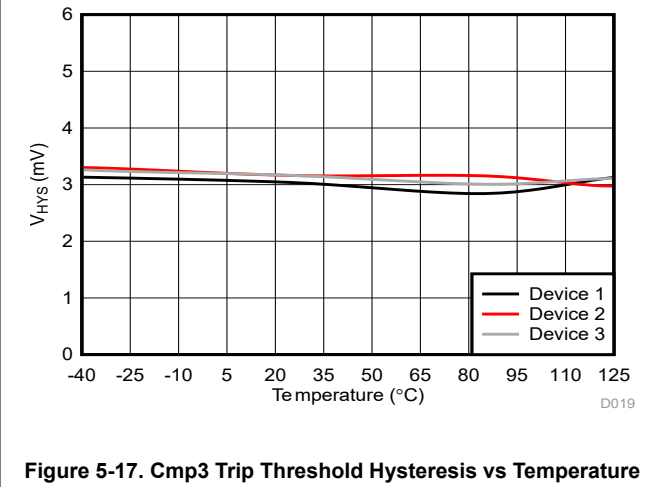
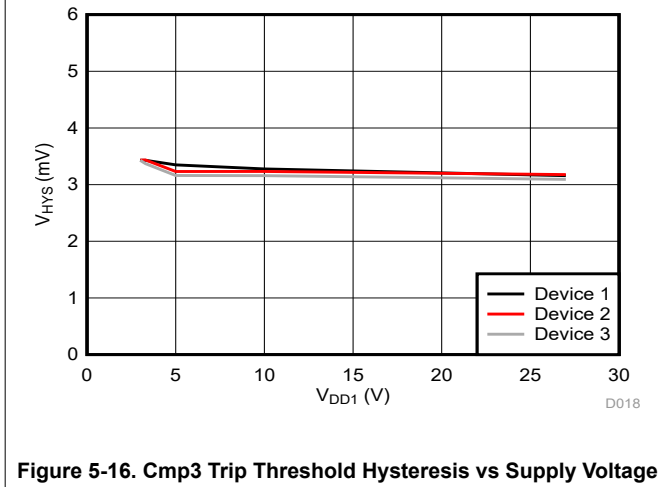
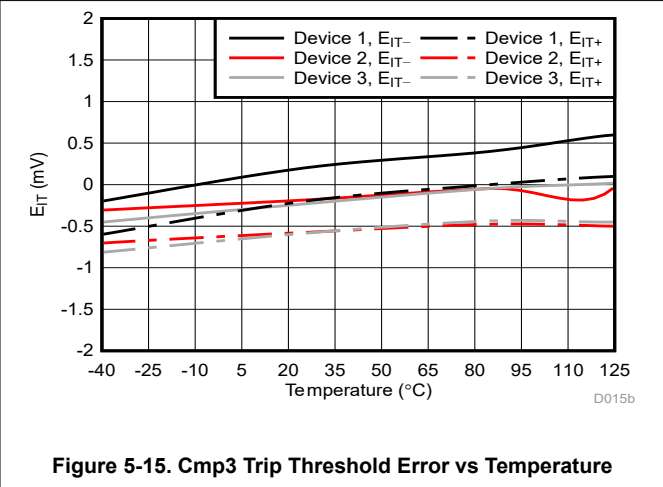
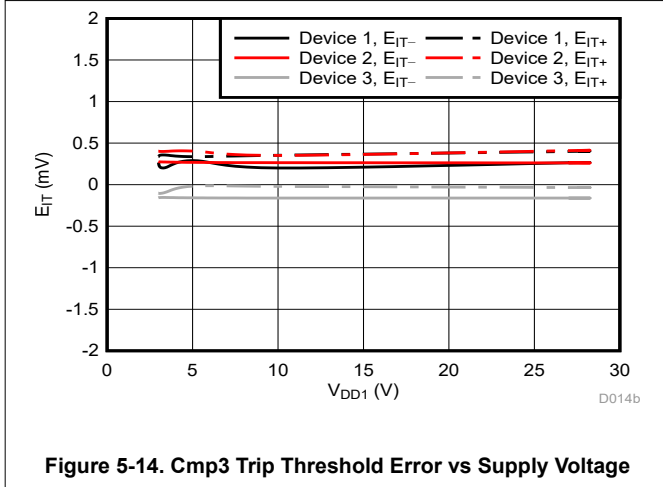
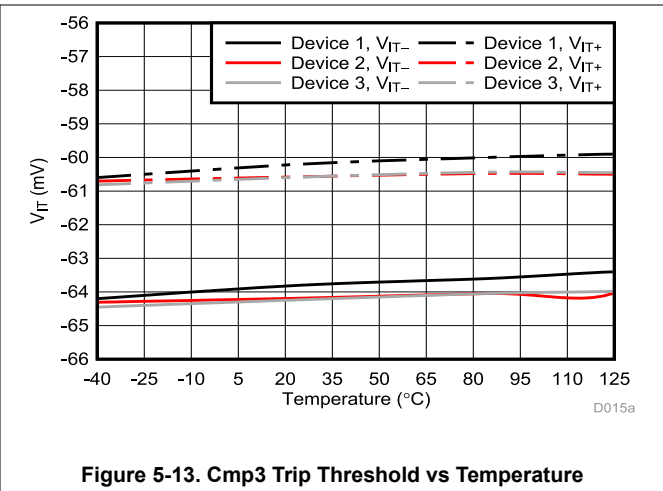
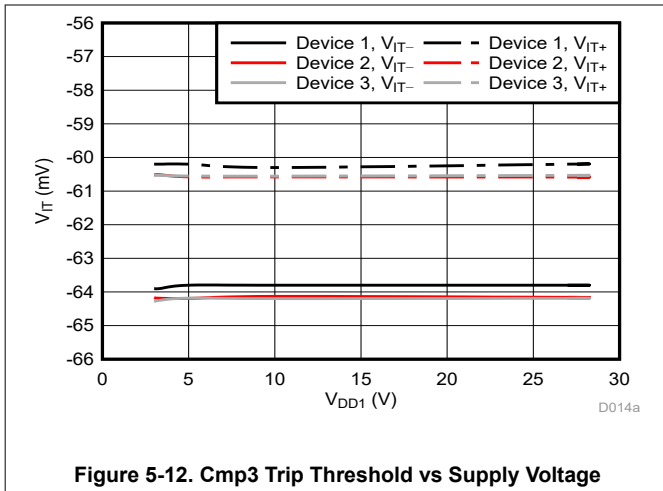

Figure 5-11. Cmp2 Trip Threshold Hysteresis vs Temperature

5.13 Typical Characteristics (continued)

At VDD1 = 5V and VDD2 = 3.3V (unless otherwise noted)



5.13 Typical Characteristics (continued)

At VDD1 = 5V and VDD2 = 3.3V (unless otherwise noted)

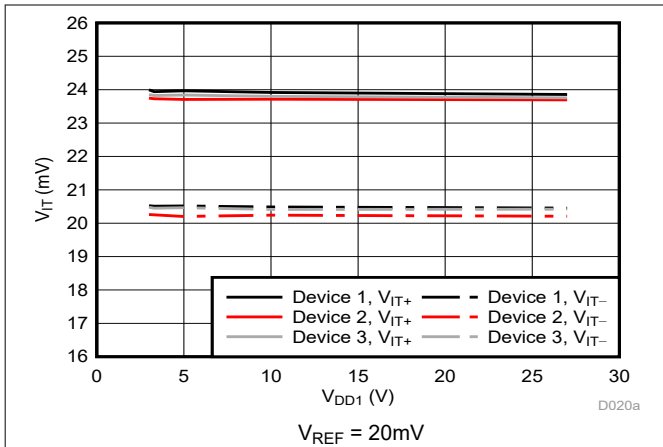

Figure 5-18. Cmp0 Trip Threshold vs Supply Voltage

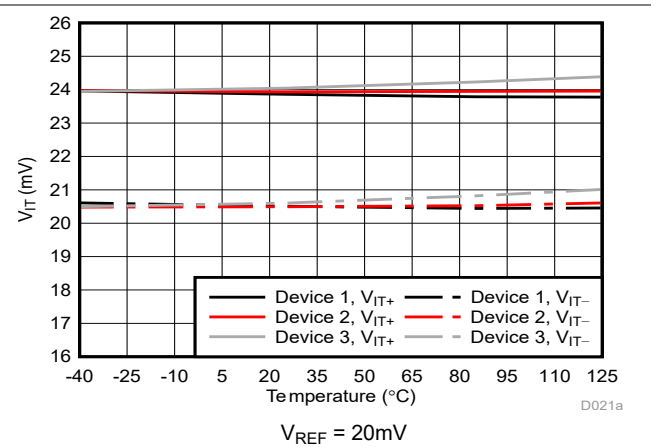

Figure 5-19. Cmp0 Trip Threshold vs Temperature

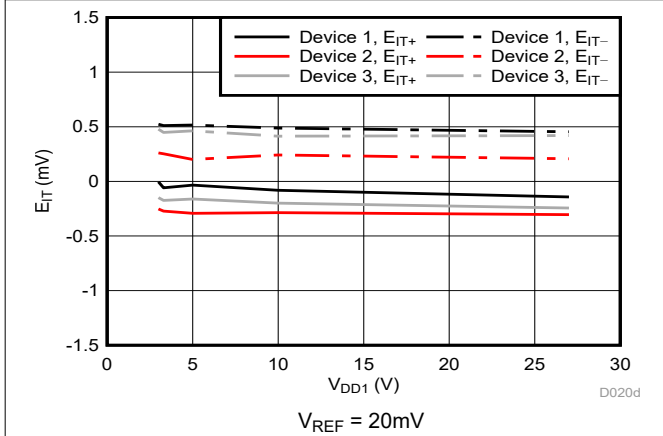

Figure 5-20. Cmp0 Trip Threshold Error vs Supply Voltage

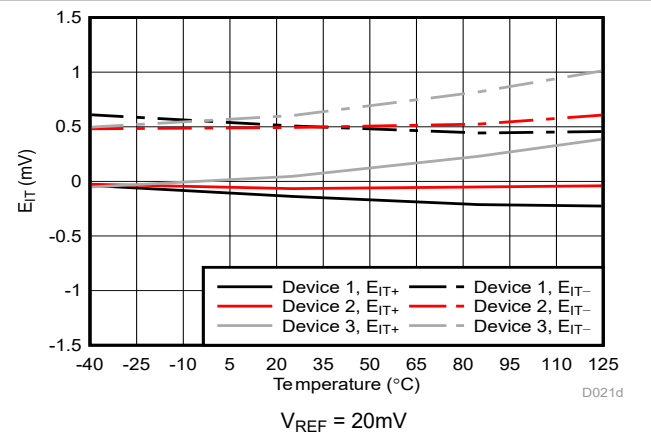

Figure 5-21. Cmp0 Trip Threshold Error vs Temperature

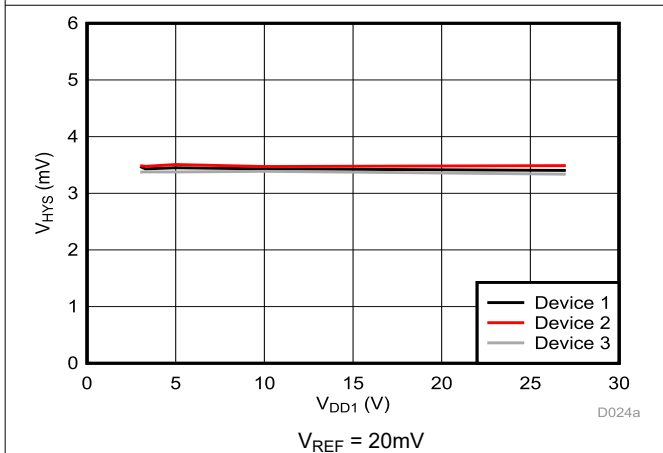

Figure 5-22. Cmp0 Trip Threshold Hysteresis vs Supply Voltage

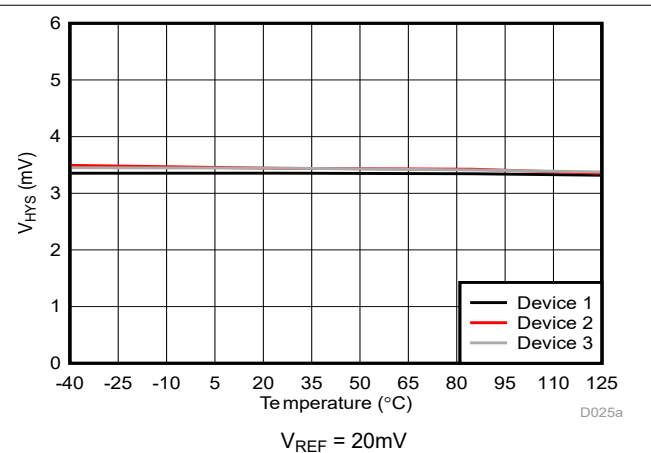

Figure 5-23. Cmp0 Trip Threshold Hysteresis vs Temperature

5.13 Typical Characteristics (continued)

At VDD1 = 5V and VDD2 = 3.3V (unless otherwise noted)

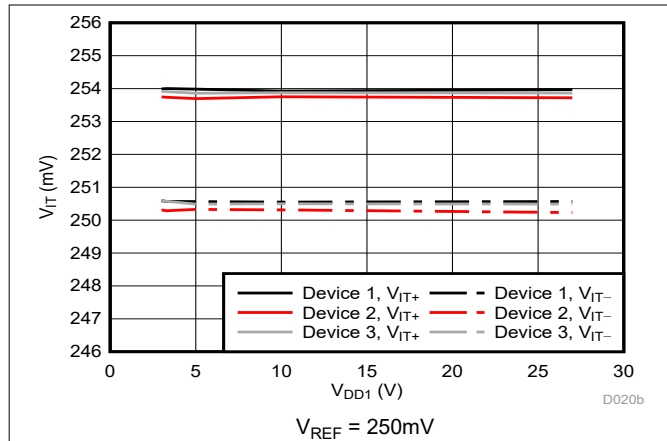

Figure 5-24. Cmp0 Trip Threshold vs Supply Voltage

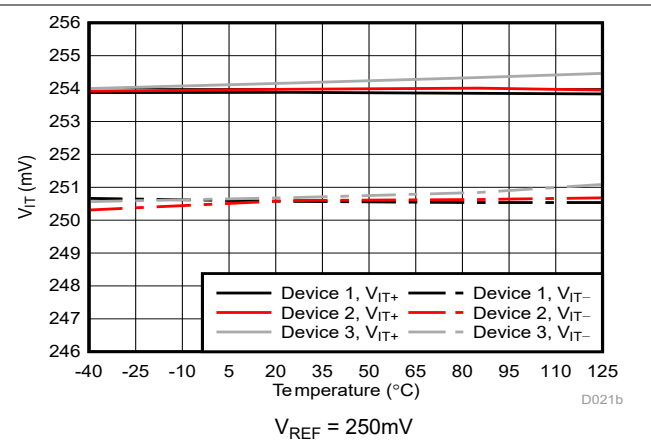

Figure 5-25. Cmp0 Trip Threshold vs Temperature

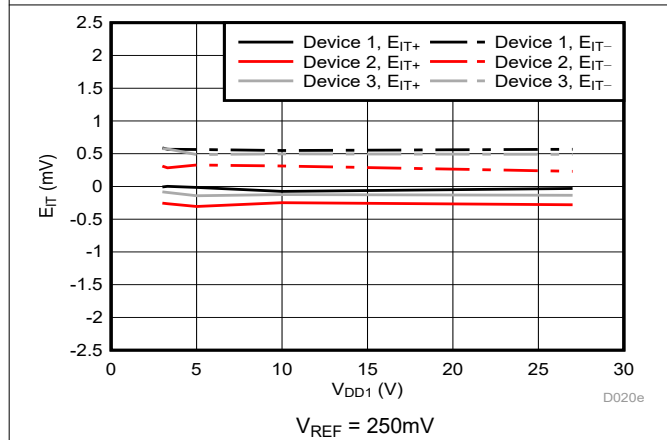

Figure 5-26. Cmp0 Trip Threshold Error vs Supply Voltage

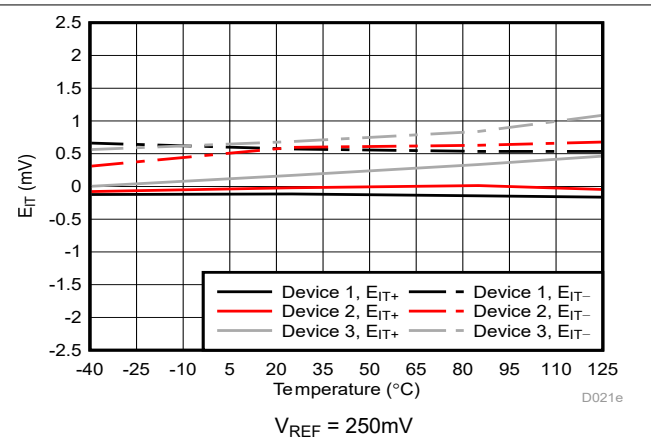

Figure 5-27. Cmp0 Trip Threshold Error vs Temperature

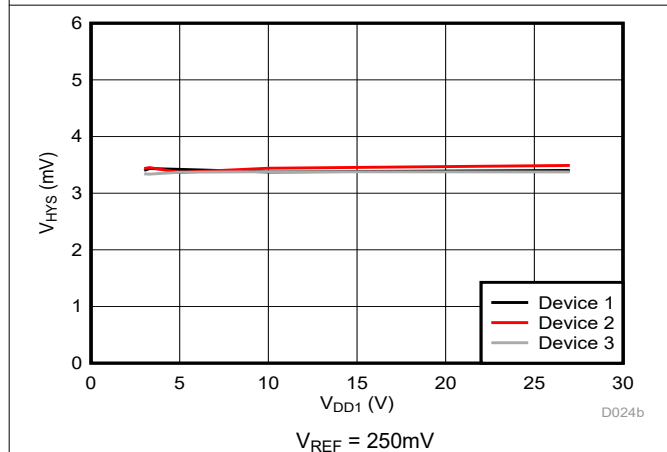

Figure 5-28. Cmp0 Trip Threshold Hysteresis vs Supply Voltage

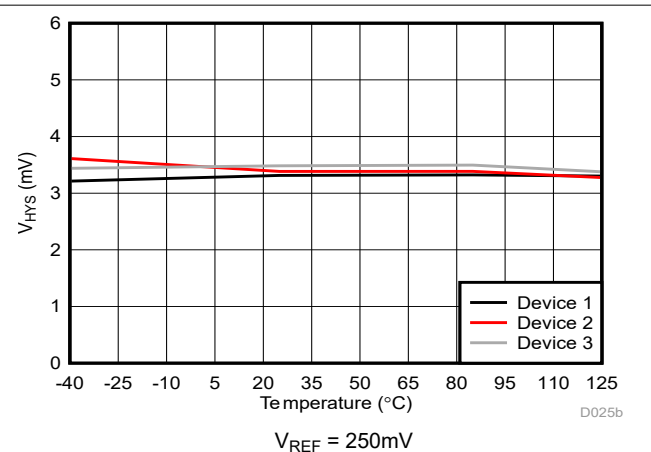

Figure 5-29. Cmp0 Trip Threshold Hysteresis vs Temperature

5.13 Typical Characteristics (continued)

At VDD1 = 5V and VDD2 = 3.3V (unless otherwise noted)

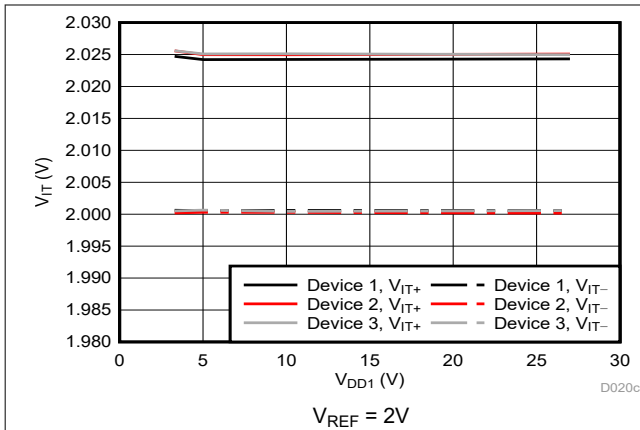

Figure 5-30. Cmp0 Trip Threshold vs Supply Voltage

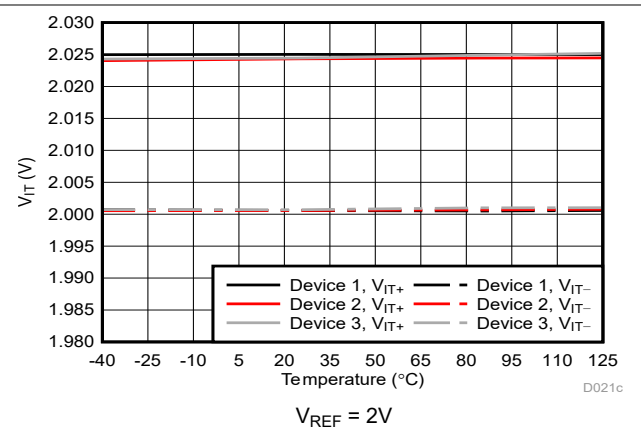

Figure 5-31. Cmp0 Trip Threshold vs Temperature

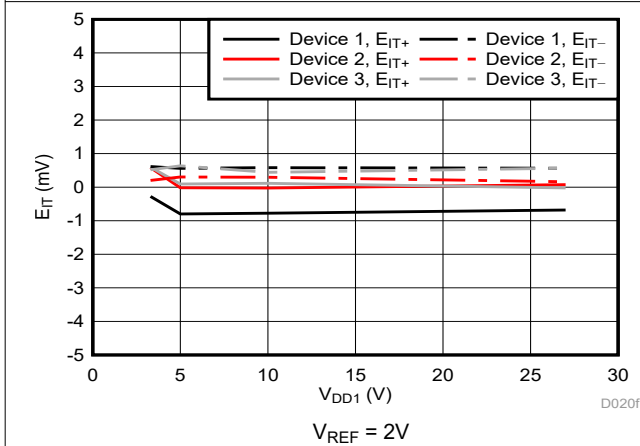

Figure 5-32. Cmp0 Trip Threshold Error vs Supply Voltage

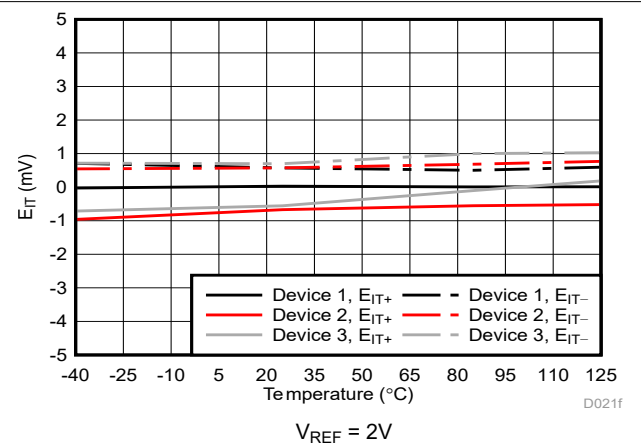

Figure 5-33. Cmp0 Trip Threshold Error vs Temperature

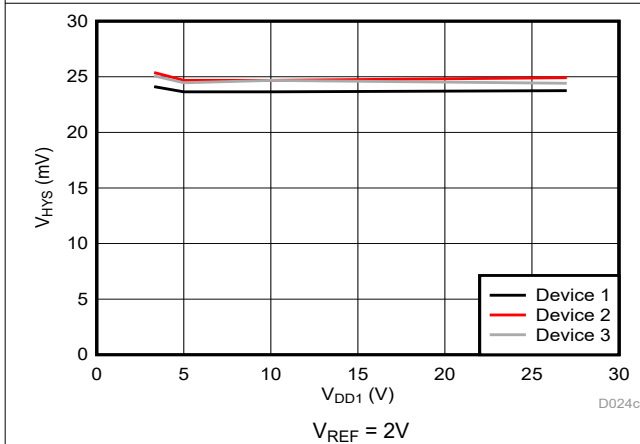

Figure 5-34. Cmp0 Trip Threshold Hysteresis vs Supply Voltage

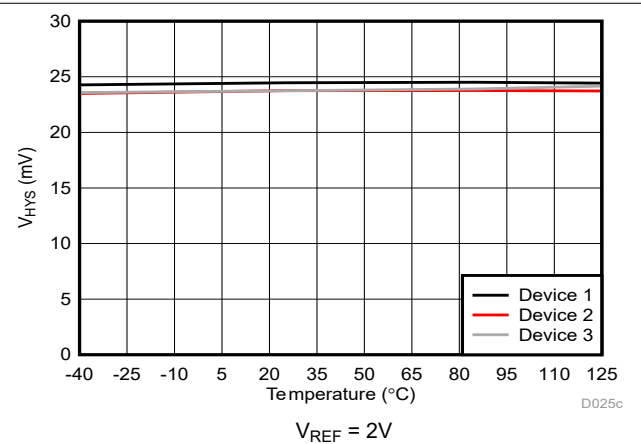

Figure 5-35. Cmp0 Trip Threshold Hysteresis vs Temperature

5.13 Typical Characteristics (continued)

At VDD1 = 5V and VDD2 = 3.3V (unless otherwise noted)

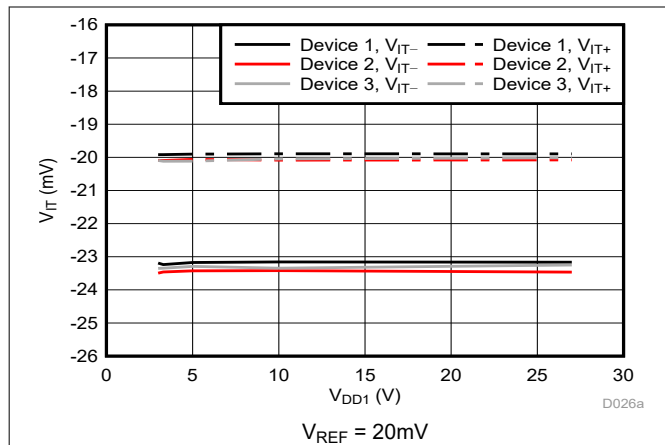

Figure 5-36. Cmp1 Trip Threshold vs Supply Voltage

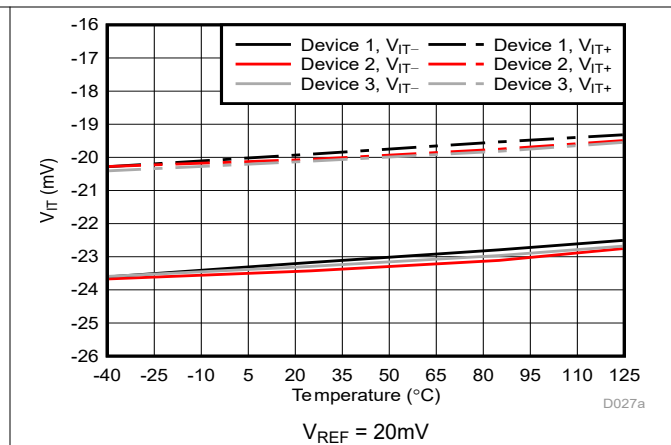

Figure 5-37. Cmp1 Trip Threshold vs Temperature

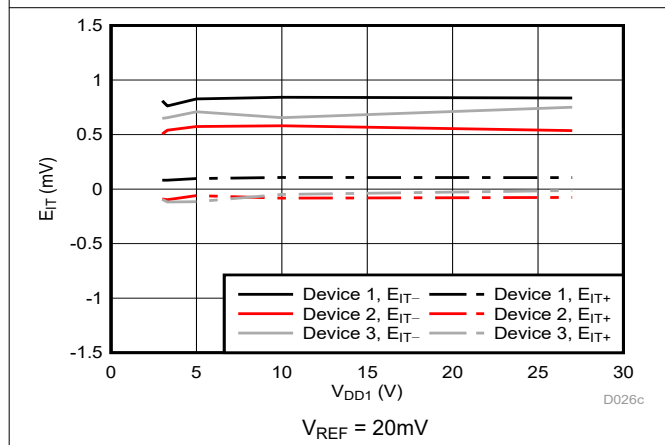

Figure 5-38. Cmp1 Trip Threshold Error vs Supply Voltage

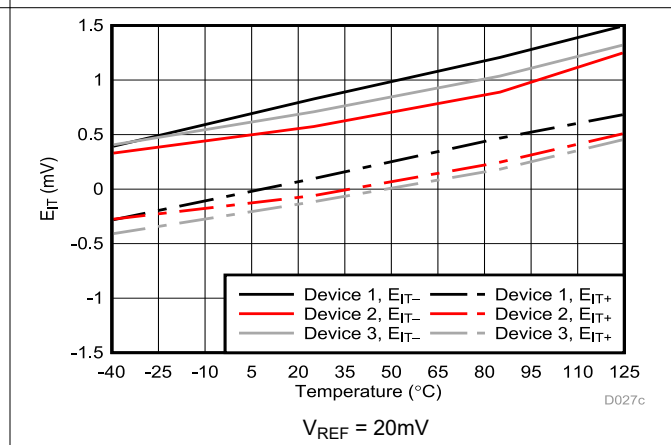

Figure 5-39. Cmp1 Trip Threshold Error vs Temperature

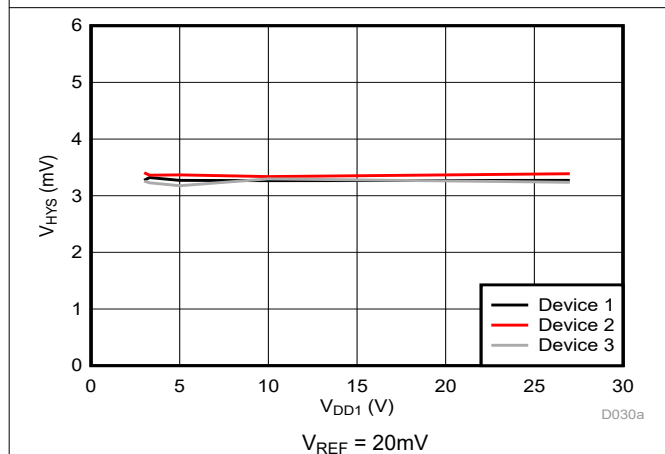

Figure 5-40. Cmp1 Trip Threshold Hysteresis vs Supply Voltage

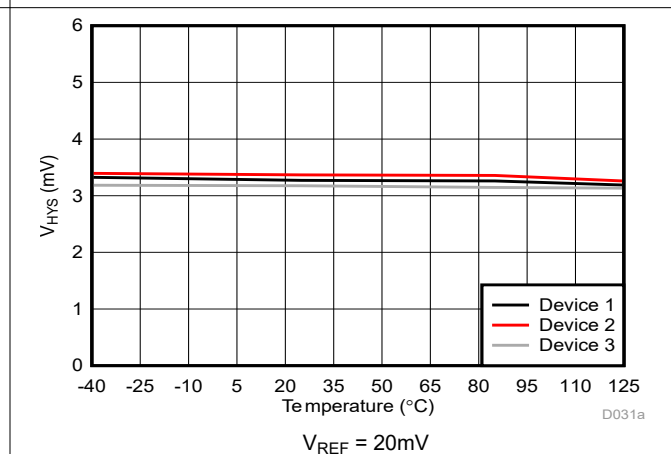

Figure 5-41. Cmp1 Trip Threshold Hysteresis vs Temperature

5.13 Typical Characteristics (continued)

At VDD1 = 5V and VDD2 = 3.3V (unless otherwise noted)

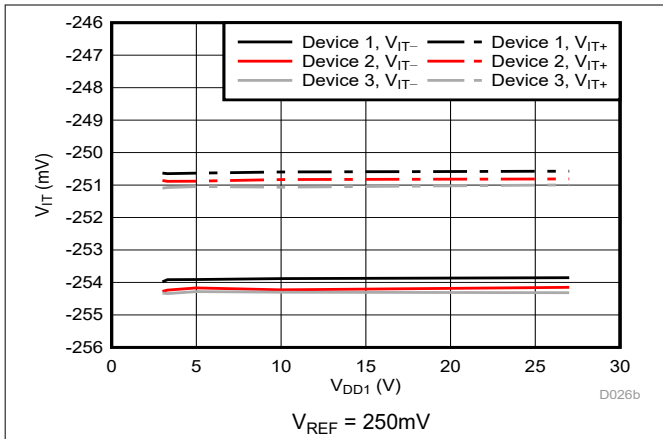

Figure 5-42. Cmp1 Trip Threshold vs Supply Voltage

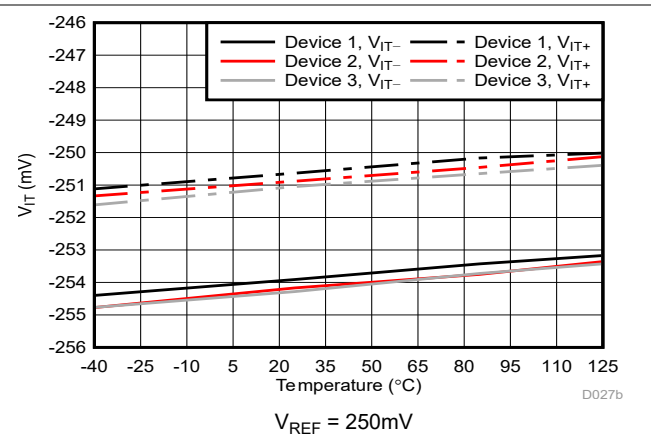

Figure 5-43. Cmp1 Trip Threshold vs Temperature

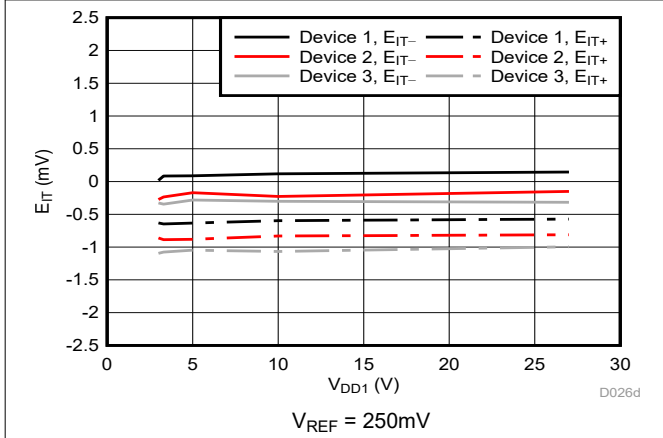

Figure 5-44. Cmp1 Trip Threshold Error vs Supply Voltage

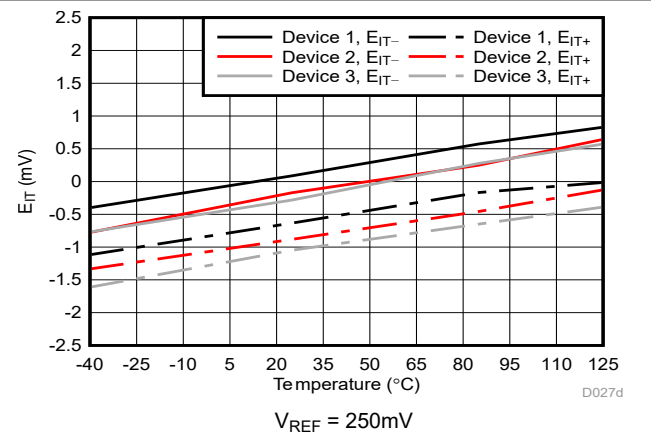

Figure 5-45. Cmp1 Trip Threshold Error vs Temperature

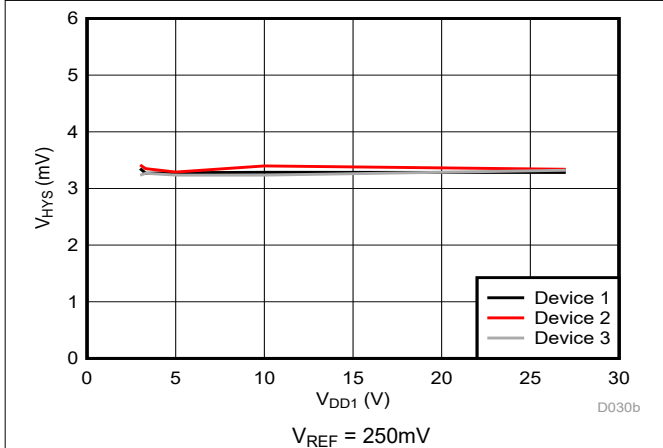

Figure 5-46. Cmp1 Trip Threshold Hysteresis vs Supply Voltage

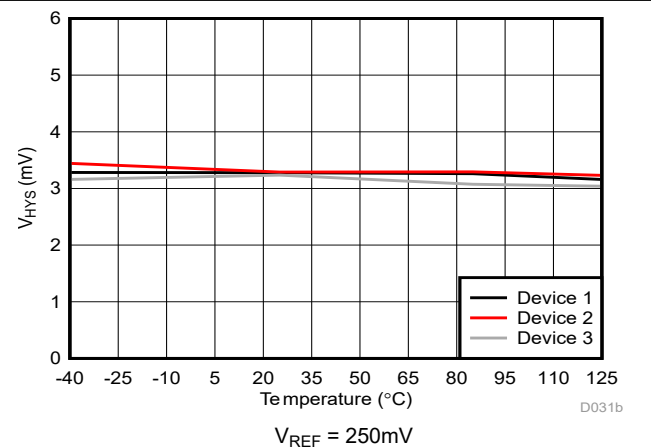

Figure 5-47. Cmp1 Trip Threshold Hysteresis vs Temperature

5.13 Typical Characteristics (continued)

At VDD1 = 5V and VDD2 = 3.3V (unless otherwise noted)

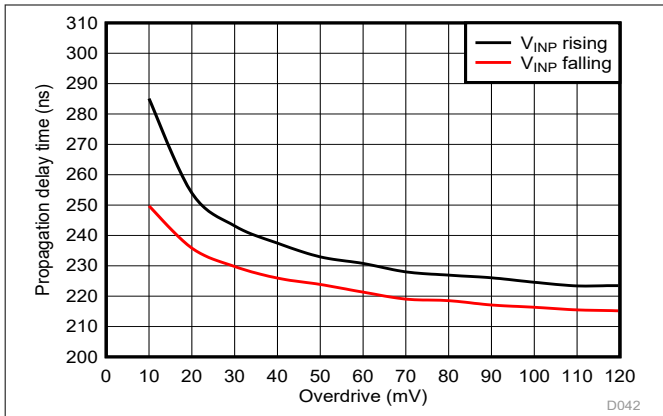

Figure 5-48. Cmp2 Propagation Delay vs Overdrive

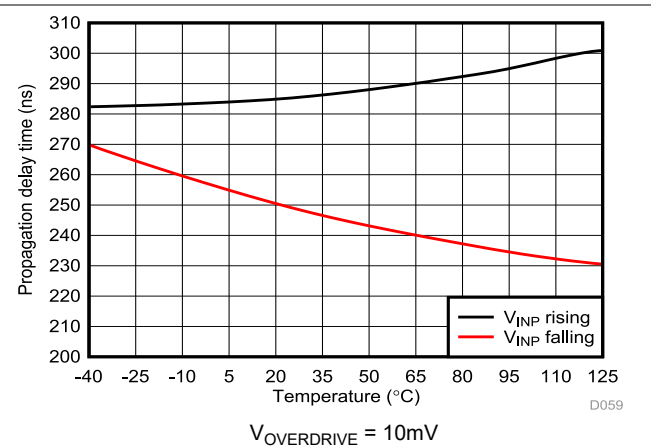

Figure 5-49. Cmp2 Propagation Delay vs Temperature

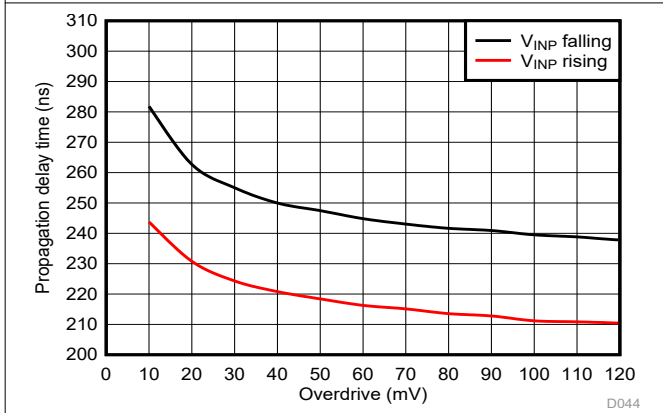

Figure 5-50. Cmp3 Propagation Delay vs Overdrive

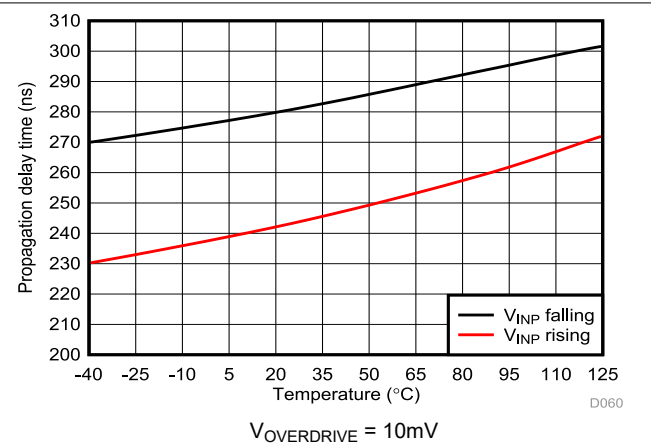

Figure 5-51. Cmp3 Propagation Delay vs Temperature

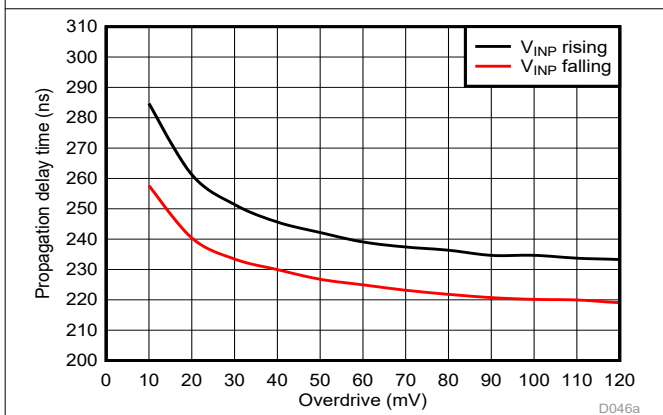

Figure 5-52. Cmp0 Propagation Delay vs Overdrive

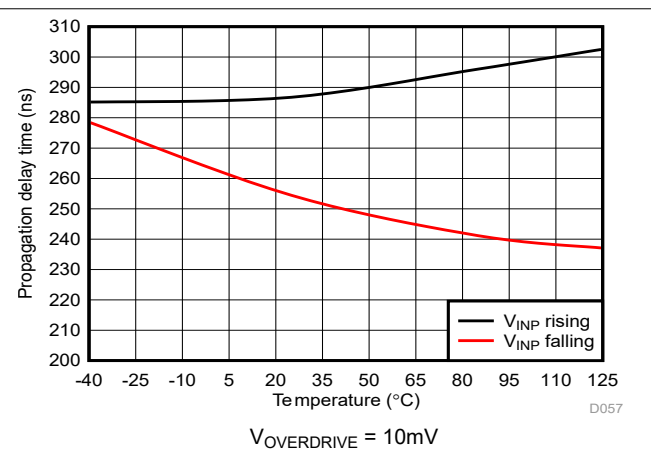

Figure 5-53. Cmp0 Propagation Delay vs Temperature

5.13 Typical Characteristics (continued)

At VDD1 = 5V and VDD2 = 3.3V (unless otherwise noted)

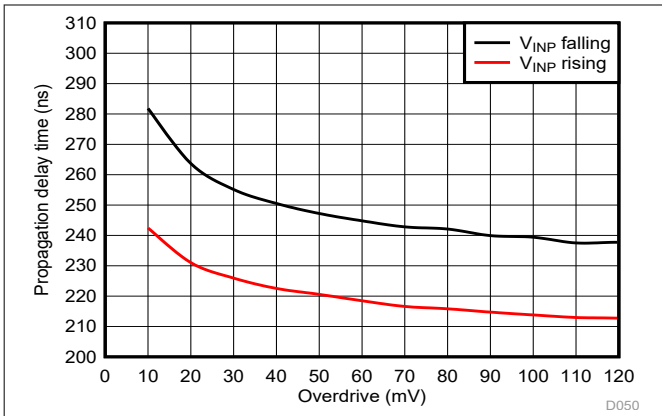
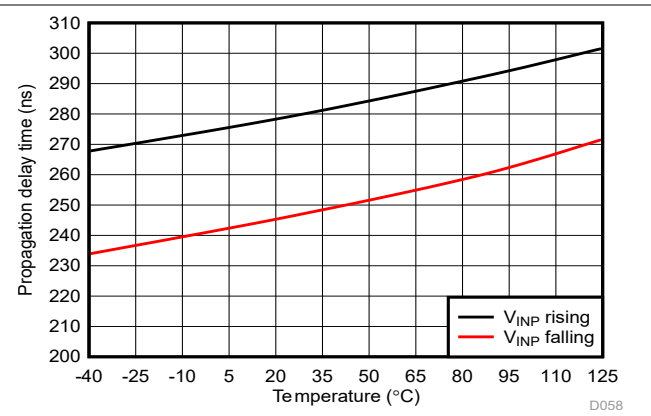

Figure 5-54. Cmp1 Propagation Delay vs Overdrive



V_{OVERDRIVE} = 10mV

Figure 5-55. Cmp1 Propagation Delay vs Temperature

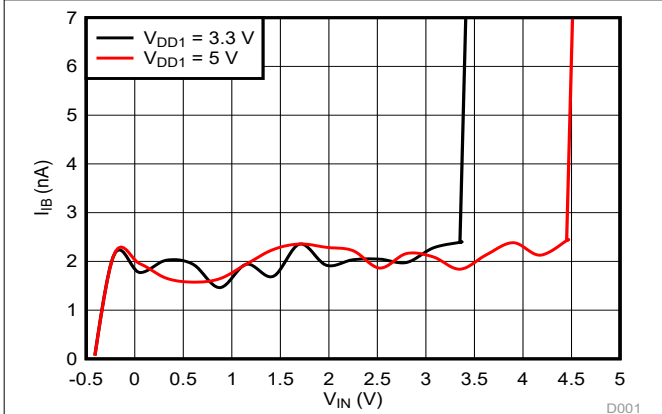
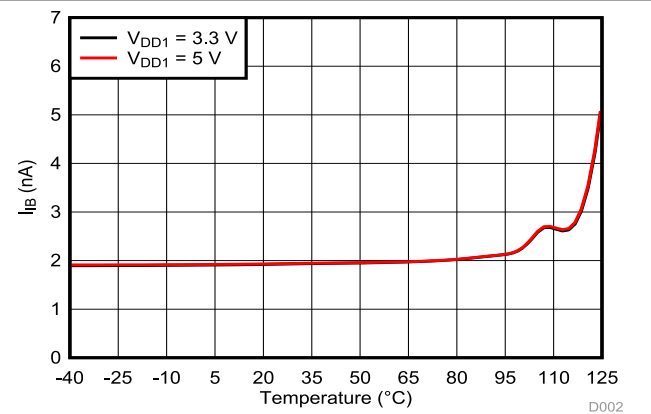

Figure 5-56. Input Bias Current vs Input Voltage



V_{IN} = 2V

Figure 5-57. Input Bias Current vs Temperature

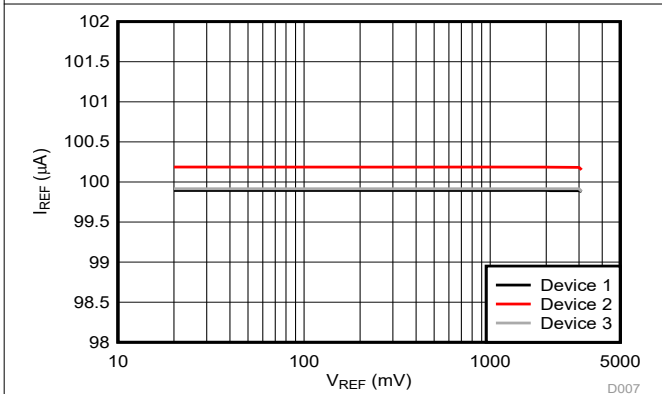

Figure 5-58. Reference Current vs Reference Voltage

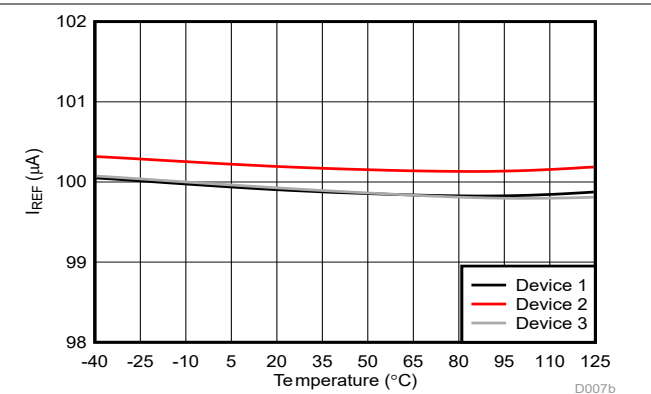

Figure 5-59. Reference Current vs Temperature

5.13 Typical Characteristics (continued)

At VDD1 = 5V and VDD2 = 3.3V (unless otherwise noted)

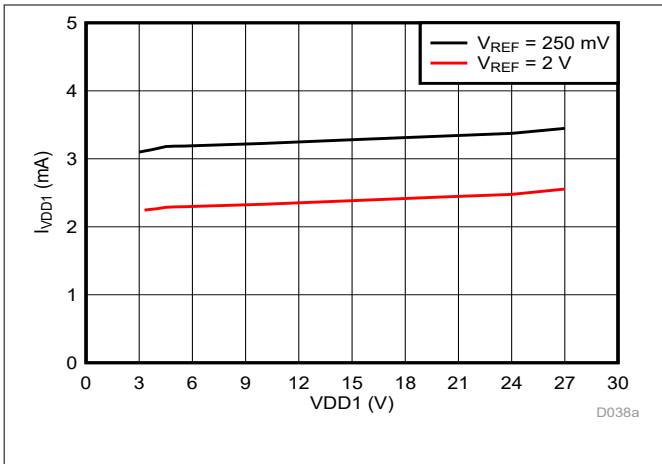

Figure 5-60. High-Side Supply Current vs Supply Voltage

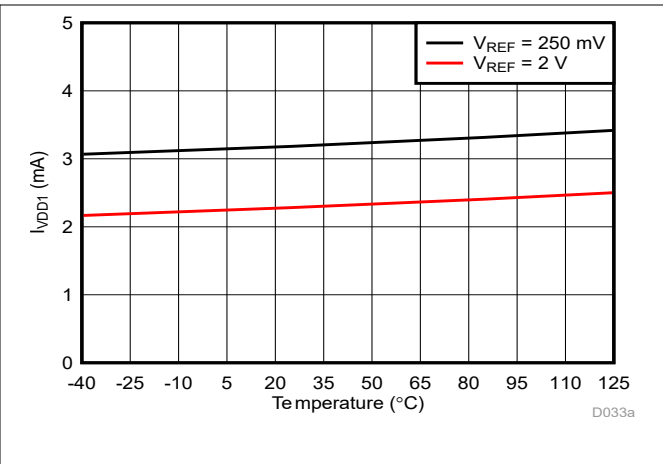

Figure 5-61. High-Side Supply Current vs Temperature

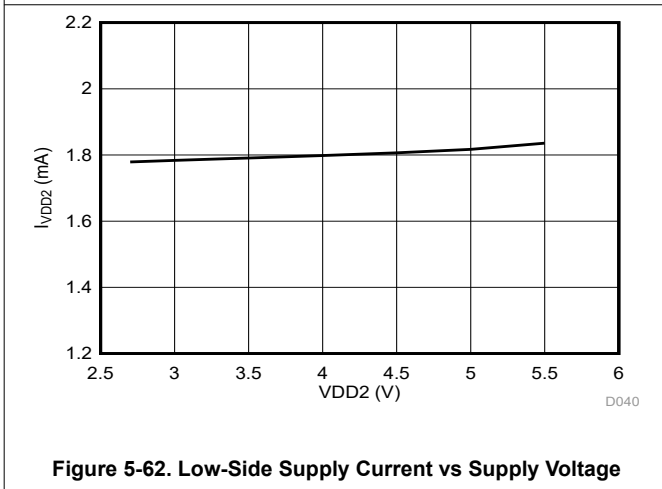

Figure 5-62. Low-Side Supply Current vs Supply Voltage

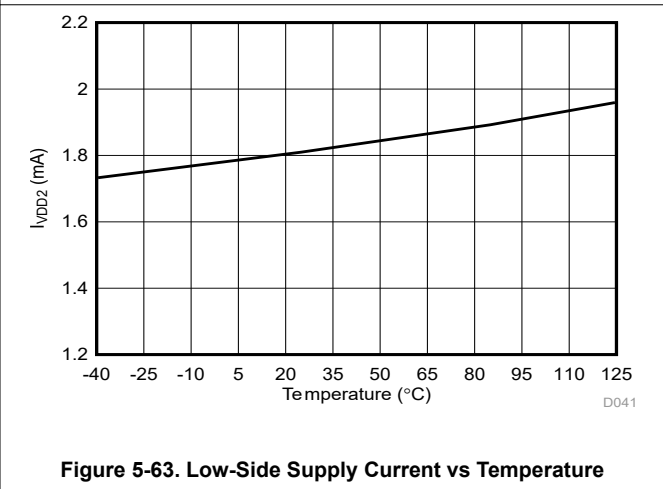

Figure 5-63. Low-Side Supply Current vs Temperature

6 Detailed Description

6.1 Overview

The AMC23C15 is a dual, isolated window comparator with open-drain outputs. Window comparator 1 is comprised of comparator Cmp0 and Cmp1 and window comparator 2 is comprised of Cmp2 and Cmp3. Cmp0 and Cmp2 compare the input voltage (V_{IN}) against the respective positive thresholds (V_{IT+}) and Cmp1 and Cmp3 compare the input voltage (V_{IN}) against the respective negative thresholds (V_{IT-}). The respective V_{IT+} and V_{IT-} thresholds are of equal magnitude but opposite signs, therefore both window comparators have windows that are centered around 0V. Window comparator 2 has fixed thresholds of $\pm 60\text{mV}$. Window comparator 1 has adjustable thresholds from $\pm 5\text{mV}$ to $\pm 300\text{mV}$ through an internally generated $100\mu\text{A}$ reference current and a single external resistor.

The open-drain outputs are actively pulled low when the input voltage (V_{IN}) is outside the respective comparison window, but are otherwise in a high-impedance state.

When the voltage on the REF pin is greater than V_{MSEL} , the device operates in positive-comparator mode. This mode is particularly useful for monitoring positive voltage supplies. Both negative comparators (Cmp1 and Cmp3) are disabled and only the positive comparators (Cmp0 and Cmp2) are functional. The reference voltage in this mode can be as high as 2.7V.

Galvanic isolation between the high- and low-voltage side of the device is achieved by transmitting the comparator states across a SiO_2 -based, reinforced capacitive isolation barrier. This isolation barrier supports a high level of magnetic field immunity, as described in the [ISO72x Digital Isolator Magnetic-Field Immunity application note](#). The digital modulation scheme used in the AMC23C15 to transmit data across the isolation barrier, and the isolation barrier characteristics, result in high reliability and common-mode transient immunity.

6.2 Functional Block Diagram

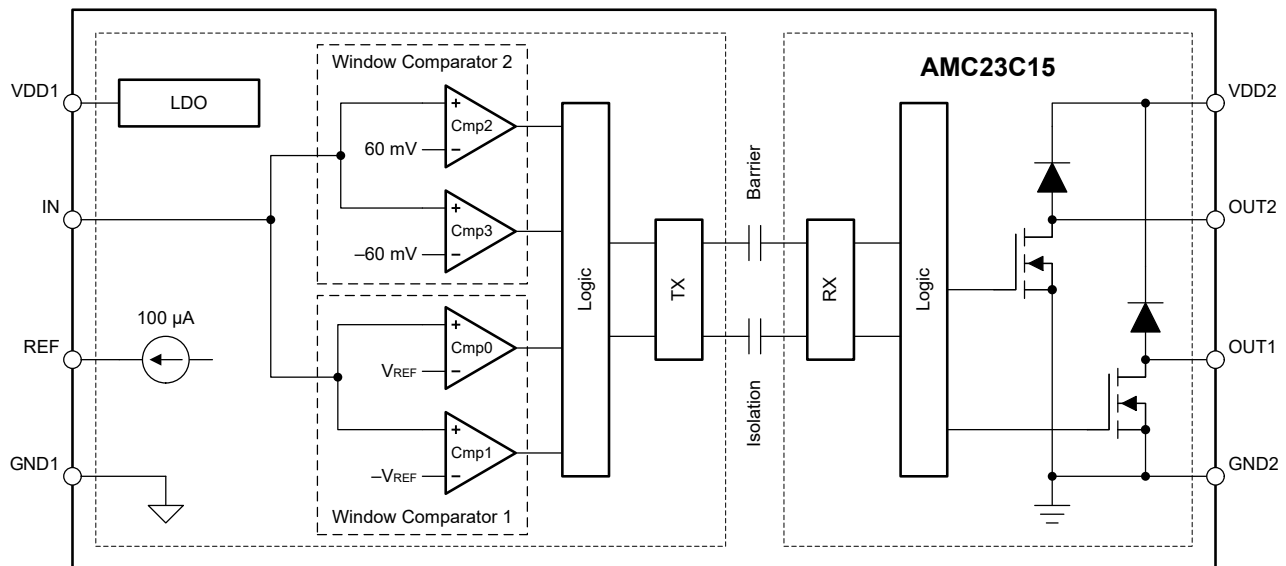

6.3 Feature Description

6.3.1 Analog Input

The AMC23C15 has a single input that drives both window comparators. Window comparator 1 has an adjustable threshold and window comparator 2 has a fixed threshold.

The positive comparators trip when the input voltage (V_{IN}) rises above the respective V_{IT+} threshold that is defined as the reference value plus the internal hysteresis voltage (for example, 64mV for the fixed-threshold comparator). The positive comparators release when V_{IN} drops below the respective V_{IT-} threshold that equals the reference value (for example, 60mV for the fixed-threshold comparator). The negative comparators trip when V_{IN} drops below the respective V_{IT-} threshold that is defined as the negative reference value minus the internal hysteresis voltage (for example, -64mV for the fixed-threshold comparator). The negative comparators release when V_{IN} rises above the respective V_{IT+} threshold that equals the negative reference value (for example -60mV for the fixed-threshold comparator).

The difference between V_{IT+} and V_{IT-} is referred to as the *comparator hysteresis* and is 4mV for reference voltages below 450mV. The integrated hysteresis makes the AMC23C15 less sensitive to input noise and provides stable operation in noisy environments without having to add external positive feedback to create hysteresis. The hysteresis of Cmp0 increases to 25mV for reference values (V_{REF}) greater than 600mV. See the [Reference Input](#) description for more details.

Figure 6-1 shows a timing diagram of the relationship between hysteresis and switching thresholds.

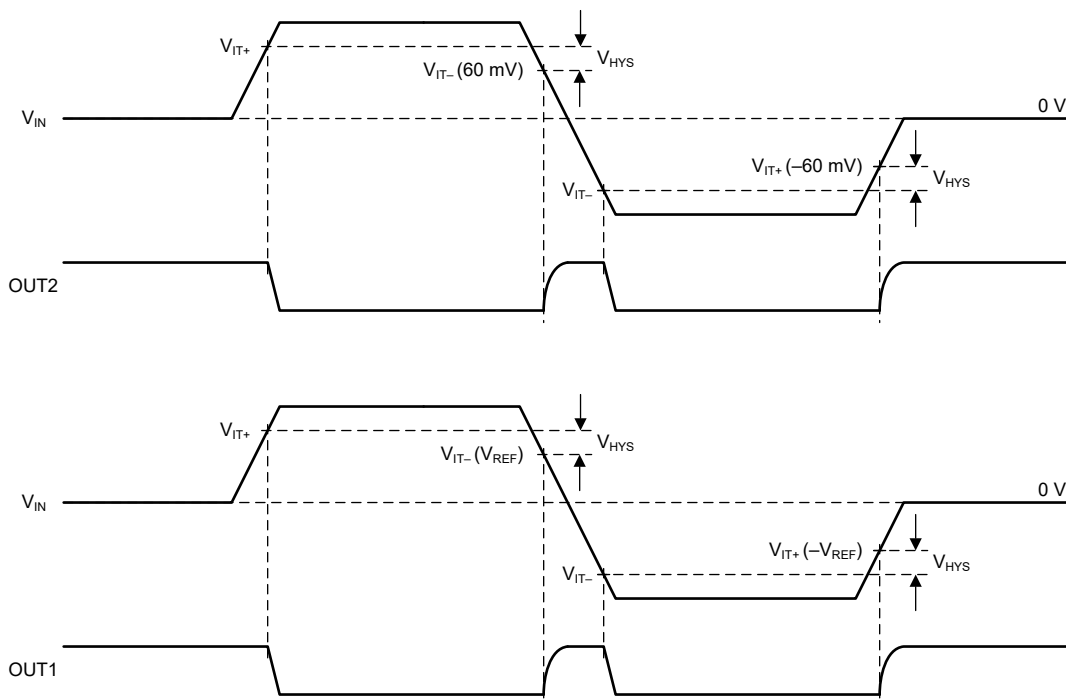

Figure 6-1. Switching Thresholds and Hysteresis

6.3.2 Reference Input

The voltage on the REF pin determines the trip threshold of window comparator 1. The internal precision current source forces a 100µA current through an external resistor connected from the REF pin to GND1. The resulting voltage across the resistor (V_{REF}) equals the magnitude of the positive and negative trip thresholds, see [Figure 6-1](#). Place a 100nF capacitor parallel to the resistor to filter the reference voltage. This capacitor must be charged by the 100µA current source during power-up and the charging time can exceed the high-side blanking time ($t_{HS,BLK}$). In this case, as shown in [Figure 6-2](#), window comparator 1 can output an incorrect state after the high-side blanking time has expired until V_{REF} reaches the final value. See the [Power-Up and Power-Down Behavior](#) section for more details on power-up behavior.

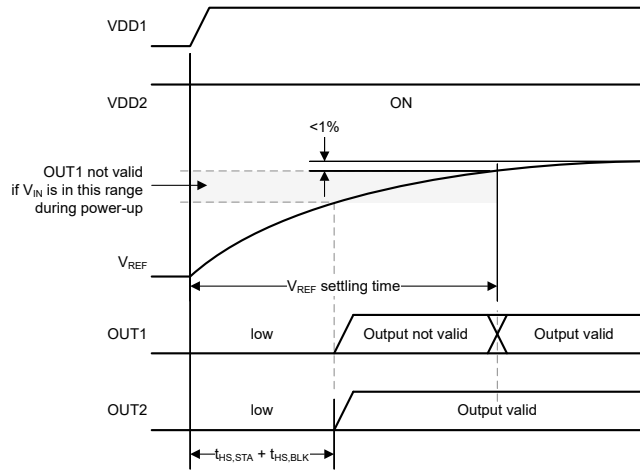

Figure 6-2. Output Behavior for Long Settling Times of the Reference Voltage

The voltage on the REF pin also determines the functionality of the negative comparators (Cmp1, Cmp3) and the hysteresis of the positive comparator (Cmp0) shown in the [Functional Block Diagram](#). If V_{REF} exceeds the V_{MSEL} threshold defined in the [Electrical Characteristics](#) table, both negative comparators (Cmp1 and Cmp3) are disabled and the hysteresis of Cmp0 is increased from 4mV (typical) to 25mV. Positive-comparator mode is intended for voltage-monitoring applications that require higher input voltages and higher noise immunity.

The reference pin can be driven by an external voltage source to change the comparator thresholds during operation. However, do not drive V_{REF} dynamically across the V_{MSEL} threshold during normal operation because doing so changes the hysteresis of the Cmp0 comparator and can lead to unintentional switching of the OUT1 output.

[Figure 6-3](#) shows a mode selection timing diagram.

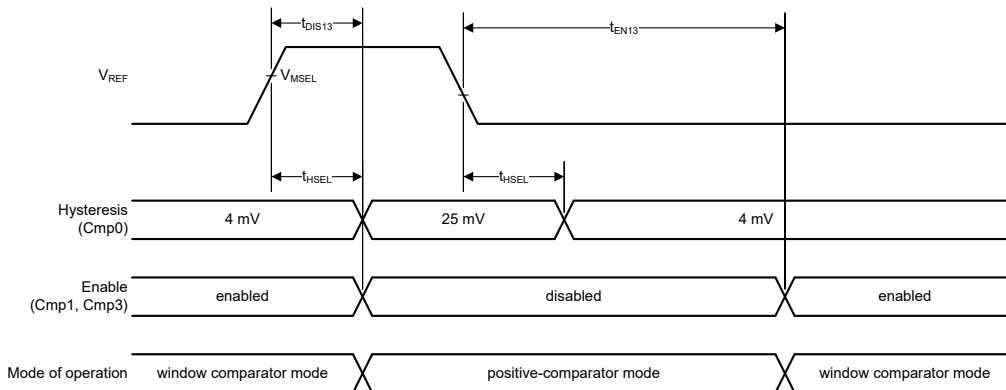

Figure 6-3. Mode Selection

6.3.3 Isolation Channel Signal Transmission

The AMC23C15 uses an on-off keying (OOK) modulation scheme, as shown in Figure 6-4, to transmit the comparator output states across the SiO₂-based isolation barrier. The transmit driver (TX) shown in the [Functional Block Diagram](#) transmits an internally-generated, high-frequency carrier across the isolation barrier to represent a digital *one* and does not send a signal to represent a digital *zero*.

The receiver (RX) on the other side of the isolation barrier recovers and demodulates the signal and provides the data for the logic that drives the open-drain output buffers. The AMC23C15 transmission channel is optimized to achieve the highest level of common-mode transient immunity (CMTI) and the lowest level of radiated emissions caused by the high-frequency carrier and RX/TX buffer switching.

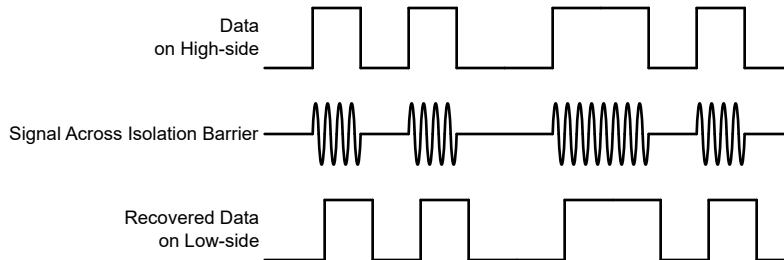

Figure 6-4. OOK-Based Modulation Scheme

6.3.4 Open-Drain Digital Outputs

The AMC23C15 has two open-drain outputs, one for each window comparator. As illustrated in Figure 6-1, OUT1 is actively pulled low when $|V_{IN}|$ exceeds the threshold values defined by the voltage on the REF pin. OUT2 is actively pulled low when $|V_{IN}|$ exceeds the threshold values defined by the internal 60mV reference.

The open-drain outputs are diode-connected to the VDD2 supply, see the [Functional Block Diagram](#), which means the outputs cannot be pulled more than 500mV above the VDD2 supply before significant current begins to flow into the OUTx pins. In particular, the open-drain outputs are clamped to one diode voltage above ground if VDD2 is at the GND2 level. This behavior is indicated by the gray shadings in Figure 6-5 through Figure 6-10.

On a system level, the CMTI performance of an open-drain signal line depends on the value of the pullup resistor. During a common-mode transient event with a high slew rate (high dV/dt), the open-drain signal line can be pulled low because of parasitic capacitive coupling between the high side and the low side of the printed circuit board (PCB). The effect of the parasitic coupling on the signal level is a function of the pullup strength and a lower value pullup resistor results in better CMTI performance. The AMC23C15 is characterized by a relatively weak pullup resistor value of 10kΩ to make sure that the specified CMTI performance is met in a typical application with a 4.7kΩ or lower pullup resistor.

6.3.5 Power-Up and Power-Down Behavior

Both open-drain outputs power up in a high-impedance (Hi-Z) state when the low-side supply (VDD2) turns on. After power-up, if the high-side is not functional yet, both outputs are actively pulled low. As shown in [Figure 6-5](#), this condition happens after the low-side start-up time plus the high-side fault detection delay time ($t_{LS,STA} + t_{HS,FLT}$). Similarly, if the high-side supply drops below the undervoltage threshold (VDD1_{UV}), as described in [Figure 6-8](#), for more than the high-side fault detection delay time during normal operation, both outputs are pulled low. This delay allows the system to shut down reliably when the high-side supply is missing.

Communication start between the high-side and low-side of the comparator is delayed by the high-side blanking time ($t_{HS,BLK}$, a time constant implemented on the high-voltage side) to allow the internal 60-mV reference and the voltage on the REF pin to settle and to avoid unintentional switching of the comparator outputs during power-up.

[Figure 6-5](#) through [Figure 6-10](#) depict typical power-up and power-down scenarios.

In [Figure 6-5](#), the low-side supply (VDD2) turns on but the high-side supply (VDD1) remains off. Both outputs power up in the default Hi-Z state. After $t_{HS,FLT}$, both outputs are pulled low indicating a no-power fault on the high side.

In [Figure 6-6](#), the high-side supply (VDD1) turns on long after the low-side supply (VDD2) turns on. Both outputs are initially in an active-low state, see [Figure 6-5](#). After the high-side supply is enabled, there is a duration of $t_{HS,STA} + t_{HS,BLK}$ before the device assumes normal operation and both outputs reflect the current state of the window comparators.

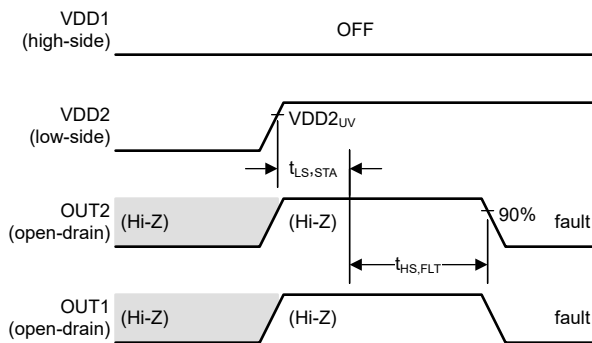

Figure 6-5. VDD2 Turns On, VDD1 Stays Off

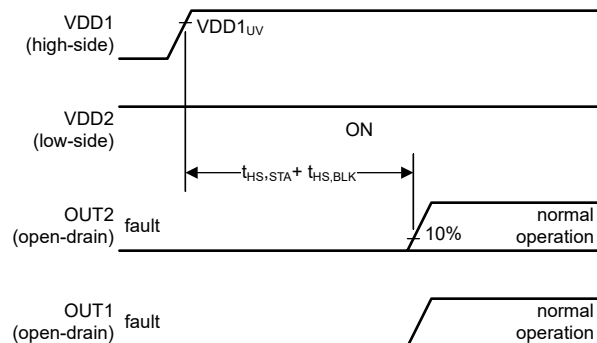

Figure 6-6. VDD2 is On; VDD1 Turns On (Long Delay)

In [Figure 6-7](#), the low-side supply (VDD2) turns on, followed by the high-side supply (VDD1) with only a short delay. Both outputs are initially in a Hi-Z state. The high-side fault detection delay ($t_{HS,FLT}$) is shorter than the high-side blanking time ($t_{HS,BLK}$), and therefore both outputs are pulled low after $t_{HS,FLT}$, indicating that the high-side is not operational yet. After the high-side blanking time ($t_{HS,BLK}$) elapses, the device assumes normal operation and both outputs reflect the current state of the window comparators.

In [Figure 6-8](#), the high-side supply (VDD1) turns off, followed by the low-side supply (VDD2). After the high-side fault detection delay time ($t_{HS,FLT}$), both outputs are actively pulled low. As soon as VDD2 drops below the VDD2_{UV} threshold, both outputs enter a Hi-Z state.

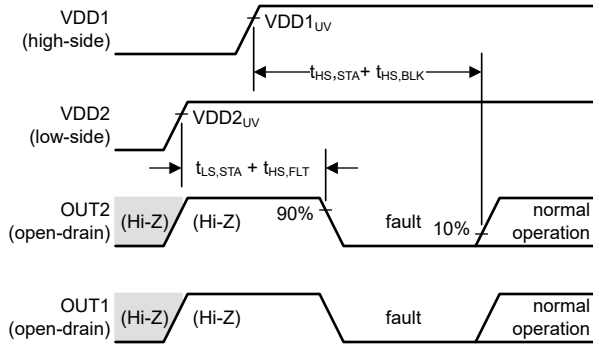

Figure 6-7. VDD2 Turns On, Followed by VDD1 (Short Delay)

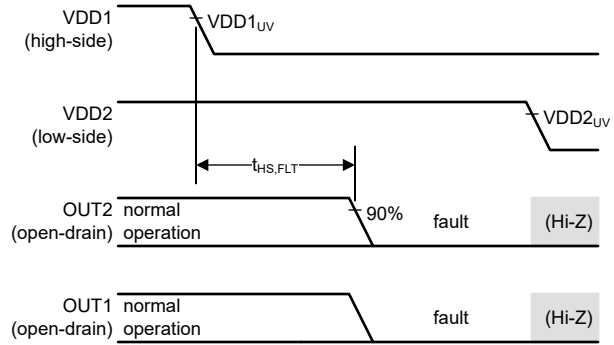

Figure 6-8. VDD1 Turns Off, Followed by VDD2

In [Figure 6-9](#), the low-side supply (VDD2) turns on after the high-side is fully powered up (the delay between VDD1 and VDD2 is greater than $(t_{HS,STA} + t_{HS,BLK})$). Both outputs start in a Hi-Z state. After the low-side start-up time ($t_{LS,STA}$), the device enters normal operation.

In [Figure 6-10](#), the low-side supply (VDD2) turns off, followed by the high-side supply (VDD1). As soon as VDD2 drops below the $VDD2_{UV}$ threshold, both outputs enter a Hi-Z state.

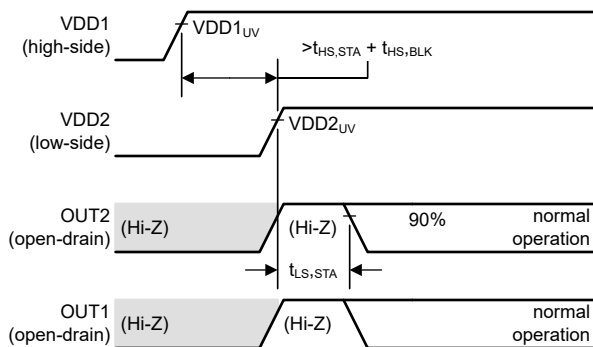

Figure 6-9. VDD1 Turns On, Followed by VDD2 (Long Delay)

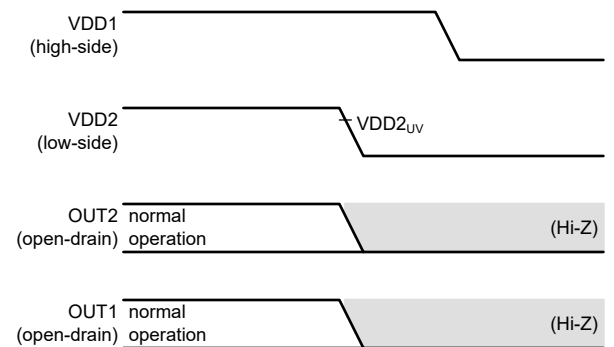

Figure 6-10. VDD2 Turns Off, Followed by VDD1

6.3.6 VDD1 Brownout and Power-Loss Behavior

Brownout is a condition where the VDD1 supply drops below the specified operating voltage range but the device remains functional. Power loss is a condition where the VDD1 supply drops below a level where the device stops being functional. Depending on the duration and the voltage level, a brownout condition can or can not be noticeable at the output of the device. A power-loss condition is always signaled on the output of the isolated comparator.

Figure 6-11 through Figure 6-13 show typical brownout and power-loss scenarios.

In Figure 6-11, VDD1 droops below the undervoltage detection threshold ($VDD1_{UV}$) but recovers before the high-side-fault detection delay time ($t_{HS,FLT}$) expires. The brownout event has no effect on the comparator outputs.

In Figure 6-12, VDD1 droops below the undervoltage detection threshold ($VDD1_{UV}$) for more than the high-side-fault detection delay time ($t_{HS,FLT}$). The brownout condition is detected as a fault and both outputs are pulled low after a delay equal to $t_{HS,FLT}$. The device resumes normal operation as soon as VDD1 recovers above the $VDD1_{UV}$ threshold.

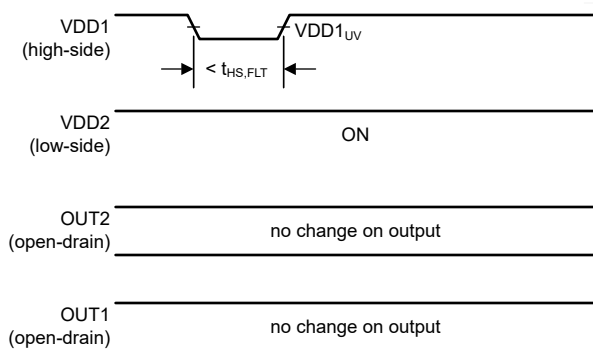

Figure 6-11. Output Response to a Short Brownout Event on VDD1

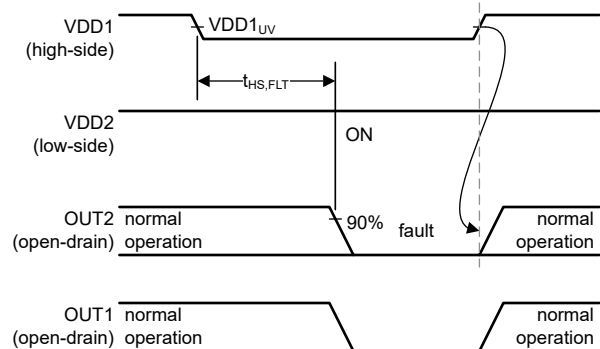

Figure 6-12. Output Response to a Long Brownout Event on VDD1

In Figure 6-13, VDD1 droops below the power-on-reset (POR) threshold ($VDD1_{POR}$). The power-loss condition is detected as a fault and both outputs are pulled low after a delay equal to $t_{HS,FLT}$. The device resumes normal operation after a delay equal to $t_{HS,STA} + t_{HS,BLK}$ after VDD1 recovers above the $VDD1_{UV}$ threshold.

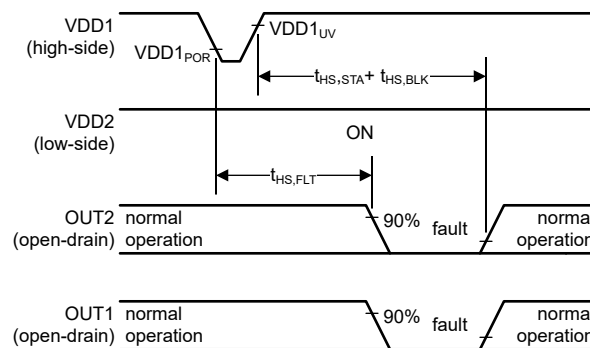

Figure 6-13. Output Response to a Power-Loss Event on VDD1

6.4 Device Functional Modes

The AMC23C15 is operational when the power supplies VDD1 and VDD2 are applied, as specified in the [Recommended Operating Conditions](#) table.

The four comparators on the high-side (Cmp0 to Cmp3) function as two independent window comparators when the voltage on the REF pin is below the V_{MSEL} threshold. If the voltage on the REF pin exceeds the V_{MSEL} threshold, the negative comparators (Cmp1 and Cmp3) are disabled, and Cmp0 and Cmp2 function as two independent positive comparators, as described in the [Reference Input](#) section.

7 Application and Implementation

Note

Information in the following applications sections is not part of the TI component specification, and TI does not warrant its accuracy or completeness. TI's customers are responsible for determining suitability of components for their purposes, as well as validating and testing their design implementation to confirm system functionality.

7.1 Application Information

With low response time, high common-mode transient immunity (CMTI), and a reinforced isolation barrier, the AMC23C15 is designed to provide fast and reliable overcurrent and overvoltage detection for high-voltage applications in harsh and noisy environments.

7.2 Typical Application

7.2.1 Overcurrent and Short-Circuit Current Detection

Fast overcurrent and short-circuit current detection is a common requirement in circuit breakers and solid state relays (SSR), and can be implemented with a single AMC23C15 isolated window comparator as shown in [Figure 7-1](#).

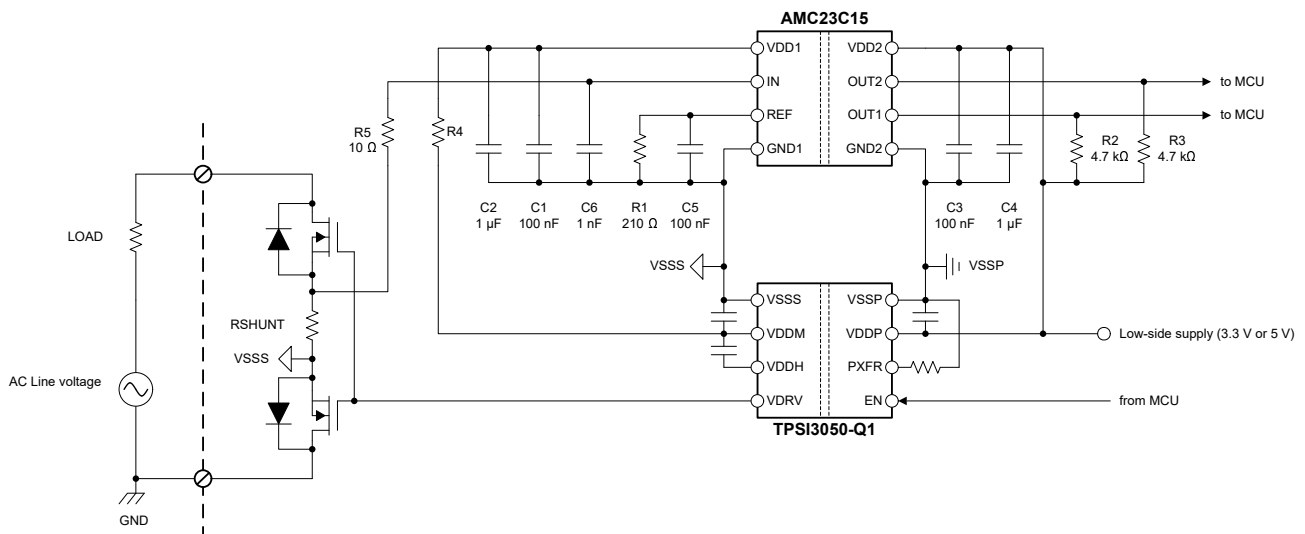

Figure 7-1. Using the AMC23C15 for Overcurrent and Short-Circuit Detection

The load current flowing through a shunt resistor (RSHUNT) connected in series with two back-to-back NMOS power switches of an SSR, and produces a voltage drop that is sensed by the AMC23C15. This voltage is compared against an adjustable threshold for overcurrent detection and a fixed, 60-mV threshold for short-circuit detection, respectively. The sense voltage can be positive or negative in respect to VSSS, which is the ground reference for the isolated comparator, depending on the direction of current flow. The absolute value of the trip threshold for overcurrent detection is set by the external resistor R1. The trip threshold for short-circuit

detection is fixed by the internal 60-mV reference. Overcurrent conditions are signaled on OUT1, and short-circuit conditions are signaled on OUT2. For a detailed description and a reference design of a SSR, see the [Overcurrent and Overtemperature Protection for Solid-State Relays Reference Design design guide](#) available for download on [www.ti.com](#).

As depicted in [Figure 7-1](#), the integrated LDO of the AMC23C15 allows direct connection of the high-side supply input (VDD1) to the VDDM supply that is generated by the isolated switch driver [TPSI3050-Q1](#). No additional isolated power supply or regulator is required to power the high-side of the isolated comparator, which makes the solution very space and cost efficient. The fast response time and high common-mode transient immunity (CMTI) of the AMC23C15 provide reliable and accurate operation even in high-noise environments.

7.2.1.1 Design Requirements

[Table 7-1](#) lists the parameters for the application example in [Figure 7-1](#).

Table 7-1. Design Requirements

PARAMETER	VALUE
High-side supply voltage	3 V to 27 V
Low-side supply voltage	2.7 V to 5.5 V
Shunt-resistor value	1 mΩ
Overcurrent detection threshold	±25 A
Short-circuit current detection threshold	±60 A

7.2.1.2 Detailed Design Procedure

The value of the shunt resistor in this example is 1 mΩ, determined by the internal 60-mV reference of the AMC23C15 and the desired 60-A short-circuit detection threshold.

At the desired 25-A overcurrent detection level, the voltage drop across the shunt resistor is $1\text{ m}\Omega \times 25\text{ A} = 25\text{ mV}$. The positive-going trip threshold of window comparator 1 is $V_{REF} + V_{HYS}$, where V_{HYS} is 4 mV as specified in the [Electrical Characteristics](#) table, and V_{REF} is the voltage across R1 that is connected between the REF and GND1 pins. R1 is calculated as $(V_{TRIP} - V_{HYS}) / I_{REF} = (25\text{ mV} - 4\text{ mV}) / 100\text{ }\mu\text{A} = 210\text{ }\Omega$ and matches a value from the E96 series (1% accuracy).

A 10-Ω, 1-nF RC filter (R5, C6) is placed at the input of the comparator to filter the input signal and reduce noise sensitivity. This filter adds $10\text{ }\Omega \times 1\text{ nF} = 10\text{ ns}$ of propagation delay that must be considered when calculating the overall response time of the protection circuit. Larger filter constants are preferable to increase noise immunity if the system can tolerate the additional delay.

[Table 7-2](#) summarizes the key parameters of the design.

Table 7-2. Overcurrent and Short-Circuit Detection Design Example

PARAMETER	VALUE
Reference resistor value (R1)	210 Ω
Reference capacitor value (C5)	100 nF
Reference voltage	21 mV
Reference voltage settling time (to 90% of final value)	50 μs
Overcurrent trip threshold (rising)	25 mV / 25.0 A
Overcurrent trip threshold (falling)	21 mV / 21 A
Short-circuit current trip threshold (rising)	64 mV / 64 A
Short-circuit current trip threshold (falling)	60 mV / 60.0 A

7.2.2 Application Curves

Figure 7-2 shows the typical response of the AMC23C15 to a bipolar, triangular input waveform with an amplitude of 140mV_{PP}. OUT1 switches when VIN crosses the ±50mV level determined by the REF pin voltage that is biased to 50mV in this example. OUT2 switches when VIN crosses the ±60mV level determined by the fixed internal reference value.

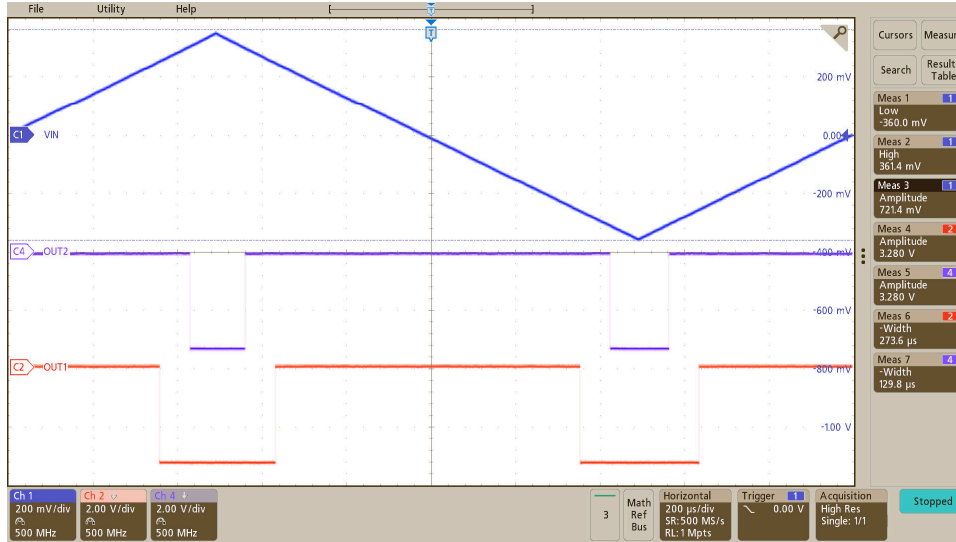
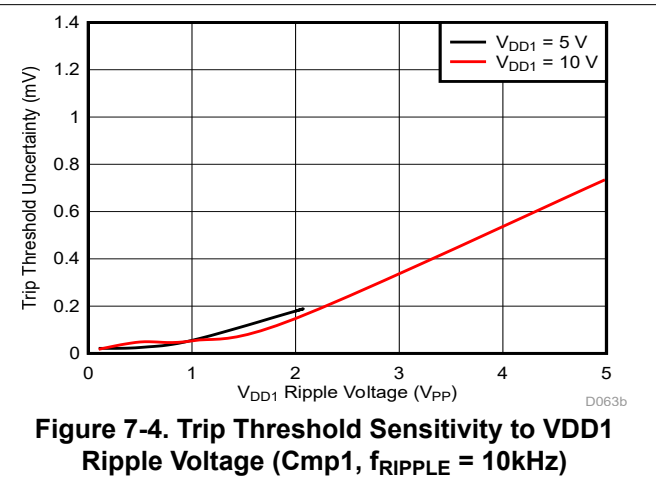
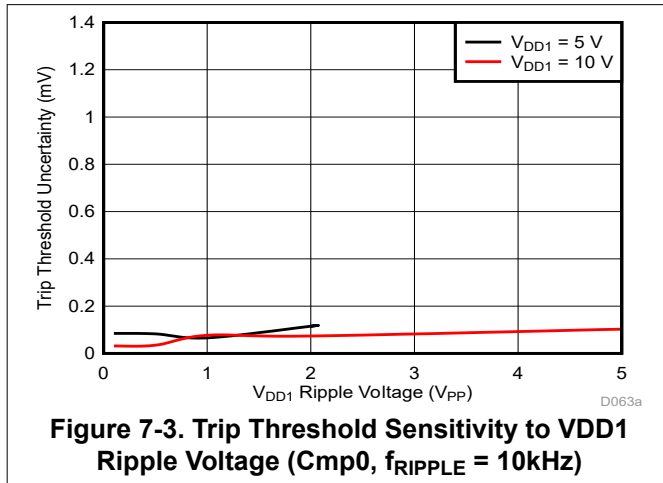
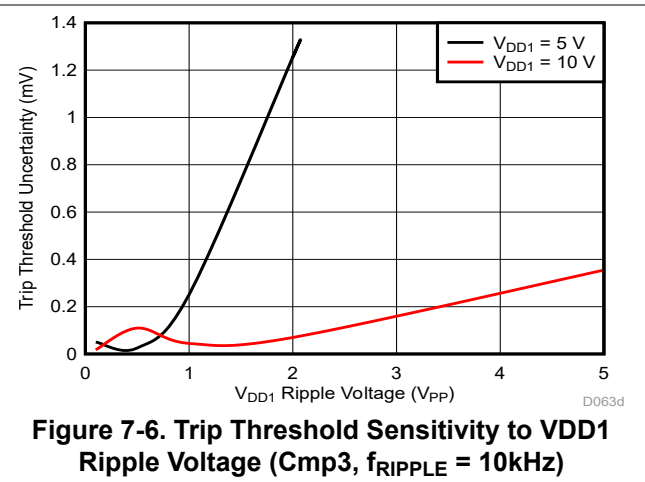
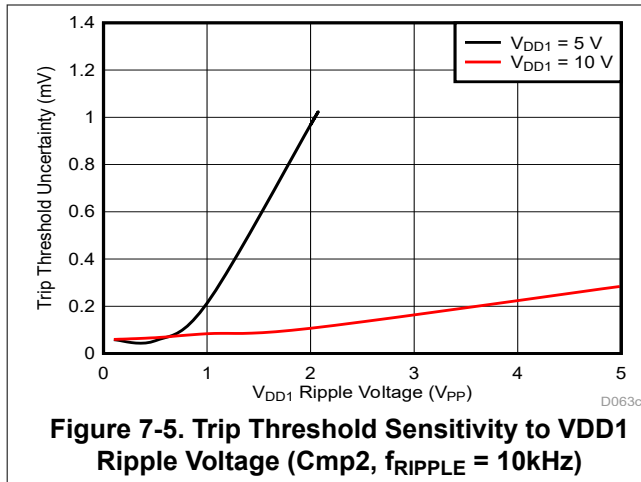

Figure 7-2. Output Response of the AMC23C15 to a Triangular Input Waveform

The integrated LDO of the AMC23C15 greatly relaxes the power-supply requirements on the high-voltage side and allows powering the device from non-regulated transformer, charge pump, and bootstrap supplies. As given by the following images, the internal LDO provides a stable operating voltage to the internal circuitry, allowing the trip thresholds to remain mostly undisturbed even at ripple voltages of 2V_{PP} and higher.





7.3 Best Design Practices

Keep the connection between the low-side of the sense resistor and the GND1 pin of the AMC23C15 short and low impedance. Any voltage drop in the ground line adds error to the voltage sensed at the input of the comparator and leads to inaccuracies in the trip thresholds.

For best common-mode transient immunity, place the filter capacitor C5 as closely to the REF pin as possible as illustrated in [Figure 7-8](#). Use a low-value pullup resistor ($<10\text{k}\Omega$) on the open-drain output, as explained in the [Open-Drain Digital Outputs](#) section, to minimize the effect of capacitive coupling on the open-drain signal line during a common-mode transient event.

Do not exceed the $300\text{mV } V_{REF}$ limit specified in the [Recommended Operating Conditions](#) table for bidirectional current-sensing applications. Do not operate the device with the REF pin biased close to the V_{MSEL} threshold (450mV to the 600mV range) to avoid dynamic switching of the Cmp0 hysteresis as explained in the [Reference Input](#) section.

The AMC23C15 provides a limited $200\mu\text{s}$ blanking time ($t_{HS,BLK}$) to allow the reference voltage (V_{REF}) to settle during start-up. For many applications, the reference voltage takes longer to settle than the $200\mu\text{s}$ blanking time and the output of the comparator can possibly glitch during system start-up as described in [Figure 6-2](#). Consider the reference voltage settling time in the overall system start-up design.

7.4 Power Supply Recommendations

The AMC23C15 does not require any specific power-up sequencing. The high-side power supply (VDD1) is decoupled with a low-ESR, 100nF capacitor (C1) parallel to a low-ESR, 1μF capacitor (C2). The low-side power supply (VDD2) is equally decoupled with a low-ESR, 100nF capacitor (C3) parallel to a low-ESR, 1μF capacitor (C4). Place all four capacitors (C1, C2, C3, and C4) as close to the device as possible. Figure 7-7 shows a decoupling schematic for the AMC23C15.

For high VDD1 supply voltages (>5.5V) place a 10Ω resistor (R4) in series with the VDD1 power supply for additional filtering.

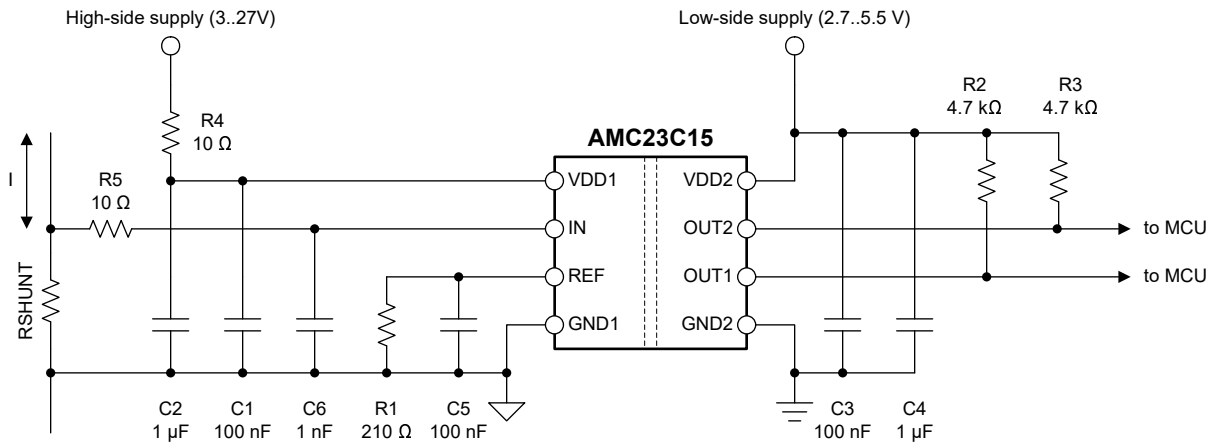

Figure 7-7. Decoupling of the AMC23C15

Capacitors must provide adequate effective capacitance under the applicable DC bias conditions experienced in the application. Multilayer ceramic capacitors (MLCCs) typically exhibit only a fraction of the nominal capacitance under real-world conditions and this factor must be taken into consideration when selecting these capacitors. This problem is especially acute in low-profile capacitors, in which the dielectric field strength is higher than in taller components. Reputable capacitor manufacturers provide capacitance versus DC bias curves that greatly simplify component selection.

7.5 Layout

7.5.1 Layout Guidelines

Figure 7-8 shows a layout recommendation with the critical placement of the decoupling capacitors (as close as possible to the AMC23C15 supply pins) and placement of the other components required by the device.

7.5.2 Layout Example

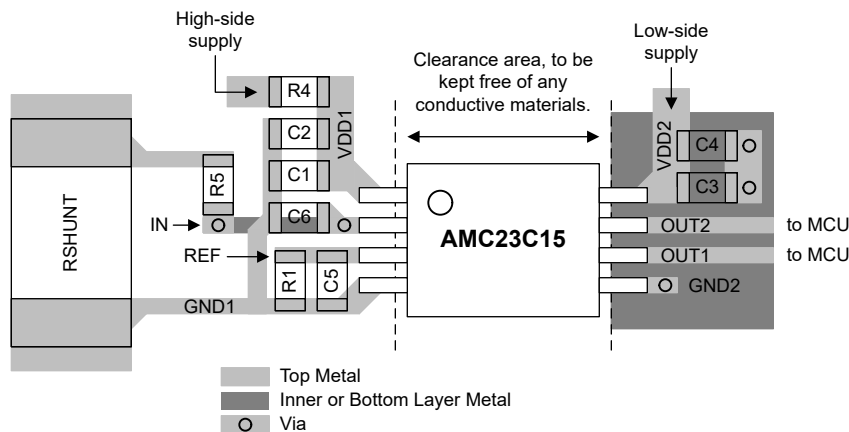

Figure 7-8. Recommended Layout of the AMC23C15

8 Device and Documentation Support

8.1 Documentation Support

8.1.1 Related Documentation

For related documentation, see the following:

- Texas Instruments, [Isolation Glossary application note](#)
- Texas Instruments, [Semiconductor and IC Package Thermal Metrics application note](#)
- Texas Instruments, [ISO72x Digital Isolator Magnetic-Field Immunity application note](#)
- Texas Instruments, [AMC1302 Precision, \$\pm 50\text{mV}\$ Input, Reinforced Isolated Amplifier data sheet](#)
- Texas Instruments, [TPSI3050-Q1 Automotive Reinforced Isolated Switch Driver with Integrated 10V Gate Supply data sheet](#)
- Texas Instruments, [Isolated Amplifier Voltage Sensing Excel Calculator design tool](#)

8.2 Receiving Notification of Documentation Updates

To receive notification of documentation updates, navigate to the device product folder on ti.com. Click on *Notifications* to register and receive a weekly digest of any product information that has changed. For change details, review the revision history included in any revised document.

8.3 Support Resources

[TI E2E™ support forums](#) are an engineer's go-to source for fast, verified answers and design help — straight from the experts. Search existing answers or ask your own question to get the quick design help you need.

Linked content is provided "AS IS" by the respective contributors. They do not constitute TI specifications and do not necessarily reflect TI's views; see TI's [Terms of Use](#).

8.4 Trademarks

TI E2E™ is a trademark of Texas Instruments.

All trademarks are the property of their respective owners.

8.5 Electrostatic Discharge Caution



This integrated circuit can be damaged by ESD. Texas Instruments recommends that all integrated circuits be handled with appropriate precautions. Failure to observe proper handling and installation procedures can cause damage.

ESD damage can range from subtle performance degradation to complete device failure. Precision integrated circuits may be more susceptible to damage because very small parametric changes could cause the device not to meet its published specifications.

8.6 Glossary

[TI Glossary](#) This glossary lists and explains terms, acronyms, and definitions.

9 Revision History

NOTE: Page numbers for previous revisions may differ from page numbers in the current version.

Changes from March 27, 2023 to September 30, 2024 (from Revision * (March 2023) to Revision A (December 2024))

	Page
• Updated the numbering format for tables, figures, and cross-references throughout the document.....	1
• Changed V_{IOWM} from $750V_{RMS}$ to $1000V_{RMS}$	6
• Changed V_{IOWM} from $1060V_{DC}$ to $1410V_{DC}$	6
• Added Safety-Related Certificate number.....	7

10 Mechanical, Packaging, and Orderable Information

The following pages include mechanical, packaging, and orderable information. This information is the most current data available for the designated devices. This data is subject to change without notice and revision of this document. For browser-based versions of this data sheet, refer to the left-hand navigation.

PACKAGING INFORMATION

Orderable Device	Status (1)	Package Type	Package Drawing	Pins	Package Qty	Eco Plan (2)	Lead finish/ Ball material (6)	MSL Peak Temp (3)	Op Temp (°C)	Device Marking (4/5)	Samples
AMC23C15DWVR	ACTIVE	SOIC	DWV	8	1000	RoHS & Green	NIPDAU	Level-3-260C-168 HR	-40 to 125	MC23C15	Samples

(1) The marketing status values are defined as follows:

ACTIVE: Product device recommended for new designs.

LIFEBUY: TI has announced that the device will be discontinued, and a lifetime-buy period is in effect.

NRND: Not recommended for new designs. Device is in production to support existing customers, but TI does not recommend using this part in a new design.

PREVIEW: Device has been announced but is not in production. Samples may or may not be available.

OBSELETE: TI has discontinued the production of the device.

(2) **RoHS:** TI defines "RoHS" to mean semiconductor products that are compliant with the current EU RoHS requirements for all 10 RoHS substances, including the requirement that RoHS substance do not exceed 0.1% by weight in homogeneous materials. Where designed to be soldered at high temperatures, "RoHS" products are suitable for use in specified lead-free processes. TI may reference these types of products as "Pb-Free".

RoHS Exempt: TI defines "RoHS Exempt" to mean products that contain lead but are compliant with EU RoHS pursuant to a specific EU RoHS exemption.

Green: TI defines "Green" to mean the content of Chlorine (Cl) and Bromine (Br) based flame retardants meet JS709B low halogen requirements of <=1000ppm threshold. Antimony trioxide based flame retardants must also meet the <=1000ppm threshold requirement.

(3) MSL, Peak Temp. - The Moisture Sensitivity Level rating according to the JEDEC industry standard classifications, and peak solder temperature.

(4) There may be additional marking, which relates to the logo, the lot trace code information, or the environmental category on the device.

(5) Multiple Device Markings will be inside parentheses. Only one Device Marking contained in parentheses and separated by a "-" will appear on a device. If a line is indented then it is a continuation of the previous line and the two combined represent the entire Device Marking for that device.

(6) Lead finish/Ball material - Orderable Devices may have multiple material finish options. Finish options are separated by a vertical ruled line. Lead finish/Ball material values may wrap to two lines if the finish value exceeds the maximum column width.

Important Information and Disclaimer:The information provided on this page represents TI's knowledge and belief as of the date that it is provided. TI bases its knowledge and belief on information provided by third parties, and makes no representation or warranty as to the accuracy of such information. Efforts are underway to better integrate information from third parties. TI has taken and continues to take reasonable steps to provide representative and accurate information but may not have conducted destructive testing or chemical analysis on incoming materials and chemicals. TI and TI suppliers consider certain information to be proprietary, and thus CAS numbers and other limited information may not be available for release.

In no event shall TI's liability arising out of such information exceed the total purchase price of the TI part(s) at issue in this document sold by TI to Customer on an annual basis.

TAPE AND REEL INFORMATION

QUADRANT ASSIGNMENTS FOR PIN 1 ORIENTATION IN TAPE

*All dimensions are nominal

Device	Package Type	Package Drawing	Pins	SPQ	Reel Diameter (mm)	Reel Width W1 (mm)	A0 (mm)	B0 (mm)	K0 (mm)	P1 (mm)	W (mm)	Pin1 Quadrant
AMC23C15DWVR	SOIC	DWV	8	1000	330.0	16.4	12.05	6.15	3.3	16.0	16.0	Q1

TAPE AND REEL BOX DIMENSIONS

*All dimensions are nominal

Device	Package Type	Package Drawing	Pins	SPQ	Length (mm)	Width (mm)	Height (mm)
AMC23C15DWVR	SOIC	DWV	8	1000	350.0	350.0	43.0



DWV0008A

SOIC - 2.8 mm max height

SOIC

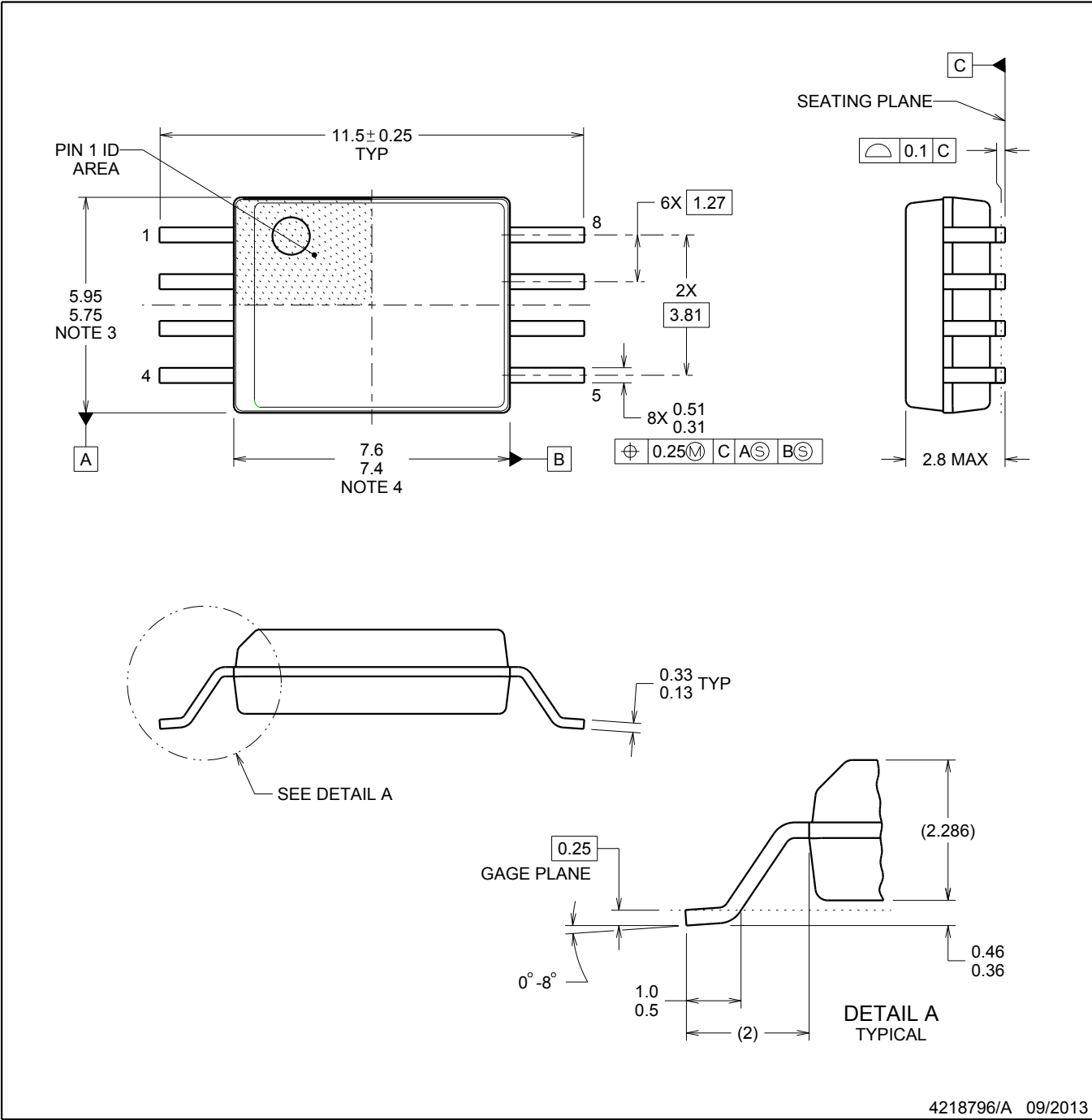

4218796/A 09/2013

NOTES:

1. All linear dimensions are in millimeters. Dimensions in parenthesis are for reference only. Dimensioning and tolerancing per ASME Y14.5M.
2. This drawing is subject to change without notice.
3. This dimension does not include mold flash, protrusions, or gate burrs. Mold flash, protrusions, or gate burrs shall not exceed 0.15 mm, per side.
4. This dimension does not include interlead flash. Interlead flash shall not exceed 0.25 mm, per side.



LAND PATTERN EXAMPLE
9.1 mm NOMINAL CLEARANCE/CREEPAGE
SCALE:6X

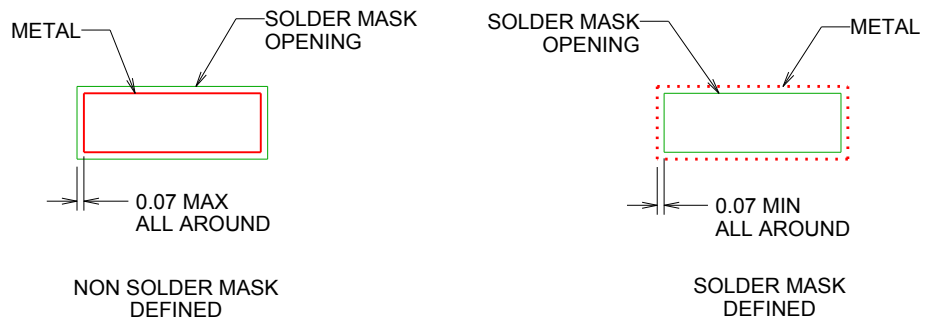

SOLDER MASK DETAILS

4218796/A 09/2013

NOTES: (continued)

- 5. Publication IPC-7351 may have alternate designs.
- 6. Solder mask tolerances between and around signal pads can vary based on board fabrication site.

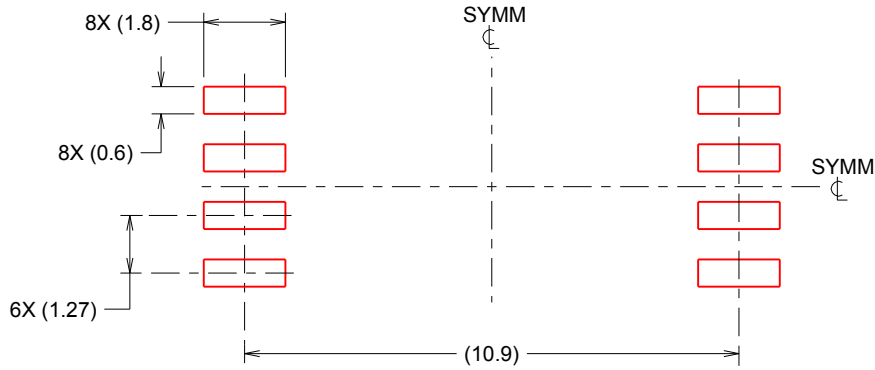

SOLDER PASTE EXAMPLE
 BASED ON 0.125 mm THICK STENCIL
 SCALE:6X

4218796/A 09/2013

NOTES: (continued)

- 7. Laser cutting apertures with trapezoidal walls and rounded corners may offer better paste release. IPC-7525 may have alternate design recommendations.
- 8. Board assembly site may have different recommendations for stencil design.

IMPORTANT NOTICE AND DISCLAIMER

TI PROVIDES TECHNICAL AND RELIABILITY DATA (INCLUDING DATA SHEETS), DESIGN RESOURCES (INCLUDING REFERENCE DESIGNS), APPLICATION OR OTHER DESIGN ADVICE, WEB TOOLS, SAFETY INFORMATION, AND OTHER RESOURCES "AS IS" AND WITH ALL FAULTS, AND DISCLAIMS ALL WARRANTIES, EXPRESS AND IMPLIED, INCLUDING WITHOUT LIMITATION ANY IMPLIED WARRANTIES OF MERCHANTABILITY, FITNESS FOR A PARTICULAR PURPOSE OR NON-INFRINGEMENT OF THIRD PARTY INTELLECTUAL PROPERTY RIGHTS.

These resources are intended for skilled developers designing with TI products. You are solely responsible for (1) selecting the appropriate TI products for your application, (2) designing, validating and testing your application, and (3) ensuring your application meets applicable standards, and any other safety, security, regulatory or other requirements.

These resources are subject to change without notice. TI grants you permission to use these resources only for development of an application that uses the TI products described in the resource. Other reproduction and display of these resources is prohibited. No license is granted to any other TI intellectual property right or to any third party intellectual property right. TI disclaims responsibility for, and you will fully indemnify TI and its representatives against, any claims, damages, costs, losses, and liabilities arising out of your use of these resources.

TI's products are provided subject to [TI's Terms of Sale](#) or other applicable terms available either on [ti.com](https://www.ti.com) or provided in conjunction with such TI products. TI's provision of these resources does not expand or otherwise alter TI's applicable warranties or warranty disclaimers for TI products.

TI objects to and rejects any additional or different terms you may have proposed.

Mailing Address: Texas Instruments, Post Office Box 655303, Dallas, Texas 75265
Copyright © 2024, Texas Instruments Incorporated