

CSD19538Q3A 100-V N-Channel NexFET™ Power MOSFET

1 Features

- Ultra-Low Q_g and Q_{gd}
- Low-Thermal Resistance
- Avalanche Rated
- Lead Free
- RoHS Compliant
- Halogen Free
- SON 3.3-mm x 3.3-mm Plastic Package

2 Applications

- Power Over Ethernet (PoE)
- Power Sourcing Equipment (PSE)
- Motor Control

3 Description

This 100-V, 49-m Ω , SON 3.3-mm x 3.3-mm NexFET™ power MOSFET is designed to minimize conduction losses and reduce board footprint in PoE applications.

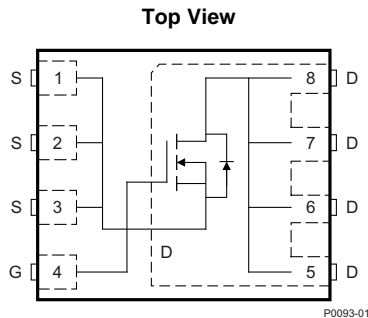

Product Summary

$T_A = 25^\circ\text{C}$		TYPICAL VALUE		UNIT
V_{DS}	Drain-to-Source Voltage	100		V
Q_g	Gate Charge Total (10 V)	4.3		nC
Q_{gd}	Gate Charge Gate to Drain	0.8		nC
$R_{DS(on)}$	Drain-to-Source On Resistance	$V_{GS} = 6\text{ V}$	58	m Ω
		$V_{GS} = 10\text{ V}$	49	
$V_{GS(th)}$	Threshold Voltage	3.2		V

Device Information⁽¹⁾

DEVICE	MEDIA	QTY	PACKAGE	SHIP
CSD19538Q3A	13-Inch Reel	3000	SON	Tape and Reel
CSD19538Q3AT	7-Inch Reel	250	3.30-mm x 3.30-mm Plastic Package	

(1) For all available packages, see the orderable addendum at the end of the data sheet.

Absolute Maximum Ratings

$T_A = 25^\circ\text{C}$		VALUE	UNIT
V_{DS}	Drain-to-Source Voltage	100	V
V_{GS}	Gate-to-Source Voltage	± 20	V
I_D	Continuous Drain Current (Package Limited)	15	A
	Continuous Drain Current (Silicon Limited), $T_C = 25^\circ\text{C}$	14	
	Continuous Drain Current ⁽¹⁾	4.9	
I_{DM}	Pulsed Drain Current ⁽²⁾	37	A
P_D	Power Dissipation ⁽¹⁾	2.8	W
	Power Dissipation, $T_C = 25^\circ\text{C}$	23	
T_J, T_{stg}	Operating Junction Temperature, Storage Temperature	-55 to 150	$^\circ\text{C}$
E_{AS}	Avalanche Energy, Single Pulse $I_D = 12.7\text{ A}, L = 0.1\text{ mH}, R_G = 25\ \Omega$	8.1	mJ

(1) Typical $R_{\theta JA} = 45^\circ\text{C/W}$ on a 1-in², 2-oz Cu pad on a 0.06 in thick FR4 PCB.

(2) Max $R_{\theta JC} = 5.5^\circ\text{C/W}$, pulse duration $\leq 100\ \mu\text{s}$, duty cycle $\leq 1\%$.

$R_{DS(on)}$ vs V_{GS}

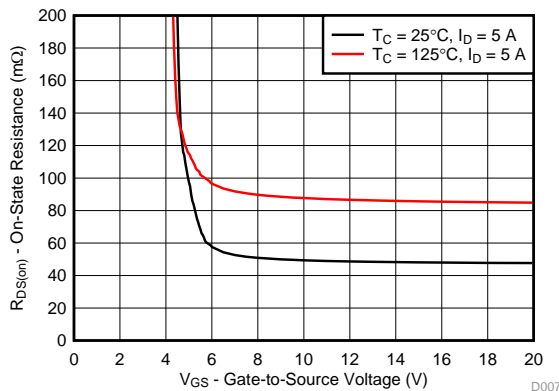

Gate Charge

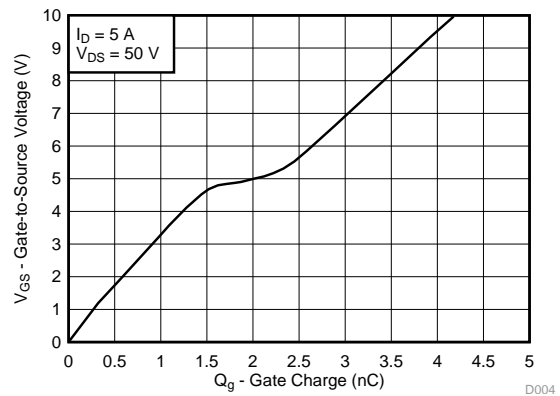

Table of Contents

1 Features	1	6.2 Community Resources.....	7
2 Applications	1	6.3 Trademarks	7
3 Description	1	6.4 Electrostatic Discharge Caution	7
4 Revision History	2	6.5 Glossary	7
5 Specifications	3	7 Mechanical, Packaging, and Orderable Information	8
5.1 Electrical Characteristics.....	3	7.1 Q3A Package Dimensions	8
5.2 Thermal Information	3	7.2 Q3A Recommended PCB Pattern	9
5.3 Typical MOSFET Characteristics.....	4	7.3 Q3A Recommended Stencil Pattern	9
6 Device and Documentation Support	7	7.4 Q3A Tape and Reel Information	10
6.1 Receiving Notification of Documentation Updates....	7		

4 Revision History

Changes from Original (May 2016) to Revision A

Page

• Changed the test voltage V_{DS} in Gate Charge curve from 100 V : to 50 V.....	1
• Changed the test voltage V_{DS} in Figure 4 from 100 V : to 50 V	5
• Added Receiving Notification of Documentation Updates section to <i>Device and Documentation Support</i> section.....	7

5 Specifications

5.1 Electrical Characteristics

 $T_A = 25^\circ\text{C}$

PARAMETER		TEST CONDITIONS	MIN	TYP	MAX	UNIT
STATIC CHARACTERISTICS						
BV_{DSS}	Drain-to-source voltage	$V_{GS} = 0\text{ V}, I_D = 250\ \mu\text{A}$	100			V
I_{DSS}	Drain-to-source leakage current	$V_{GS} = 0\text{ V}, V_{DS} = 80\text{ V}$			1	μA
I_{GSS}	Gate-to-source leakage current	$V_{DS} = 0\text{ V}, V_{GS} = 20\text{ V}$			100	nA
$V_{GS(th)}$	Gate-to-source threshold voltage	$V_{DS} = V_{GS}, I_D = 250\ \mu\text{A}$	2.8	3.2	3.8	V
$R_{DS(on)}$	Drain-to-source on resistance	$V_{GS} = 6\text{ V}, I_D = 5\text{ A}$		58	72	m Ω
		$V_{GS} = 10\text{ V}, I_D = 5\text{ A}$		49	59	
g_{fs}	Transconductance	$V_{DS} = 10\text{ V}, I_D = 5\text{ A}$		6.1		S
DYNAMIC CHARACTERISTICS						
C_{iss}	Input capacitance	$V_{GS} = 0\text{ V}, V_{DS} = 50\text{ V}, f = 1\text{ MHz}$		349	454	pF
C_{oss}	Output capacitance			69	90	pF
C_{rss}	Reverse transfer capacitance			12.6	16.4	pF
R_G	Series gate resistance			4.6	9.2	Ω
Q_g	Gate charge total (10 V)	$V_{DS} = 50\text{ V}, I_D = 5\text{ A}$		4.3		nC
Q_{gd}	Gate charge gate-to-drain			0.8		nC
Q_{gs}	Gate charge gate-to-source			1.6		nC
$Q_{g(th)}$	Gate charge at V_{th}			1		nC
Q_{oss}	Output charge	$V_{DS} = 50\text{ V}, V_{GS} = 0\text{ V}$		12.3		nC
$t_{d(on)}$	Turnon delay time	$V_{DS} = 50\text{ V}, V_{GS} = 10\text{ V}, I_D = 5\text{ A}, R_G = 0\ \Omega$		5		ns
t_r	Rise time			3		ns
$t_{d(off)}$	Turnoff delay time			7		ns
t_f	Fall time			2		ns
DIODE CHARACTERISTICS						
V_{SD}	Diode forward voltage	$I_{SD} = 5\text{ A}, V_{GS} = 0\text{ V}$		0.85	1	V
Q_{rr}	Reverse recovery charge	$V_{DS} = 50\text{ V}, I_F = 5\text{ A}, di/dt = 300\text{ A}/\mu\text{s}$		94		nC
t_{rr}	Reverse recovery time			32		ns

5.2 Thermal Information

 $T_A = 25^\circ\text{C}$ (unless otherwise stated)

THERMAL METRIC		MIN	TYP	MAX	UNIT
$R_{\theta JC}$	Junction-to-case thermal resistance ⁽¹⁾			5.5	$^\circ\text{C}/\text{W}$
$R_{\theta JA}$	Junction-to-ambient thermal resistance ⁽¹⁾⁽²⁾			55	$^\circ\text{C}/\text{W}$

- $R_{\theta JC}$ is determined with the device mounted on a 1-in² (6.45-cm²), 2-oz (0.071-mm) thick Cu pad on a 1.5-in × 1.5-in (3.81-cm × 3.81-cm), 0.06-in (1.52-mm) thick FR4 PCB. $R_{\theta JC}$ is specified by design, whereas $R_{\theta JA}$ is determined by the user's board design.
- Device mounted on FR4 material with 1-in² (6.45-cm²), 2-oz (0.071-mm) thick Cu.

CSD19538Q3A

SLPS583A –MAY 2016–REVISED MARCH 2017

www.ti.com



M0161-01

Max $R_{\theta JA} = 55^{\circ}\text{C/W}$
when mounted on 1-in²
(6.45-cm²) of 2-oz
(0.071-mm) thick Cu.



M0161-02

Max $R_{\theta JA} = 195^{\circ}\text{C/W}$
when mounted on a
minimum pad area of
2-oz (0.071-mm) thick
Cu.

5.3 Typical MOSFET Characteristics

$T_A = 25^{\circ}\text{C}$ (unless otherwise stated)

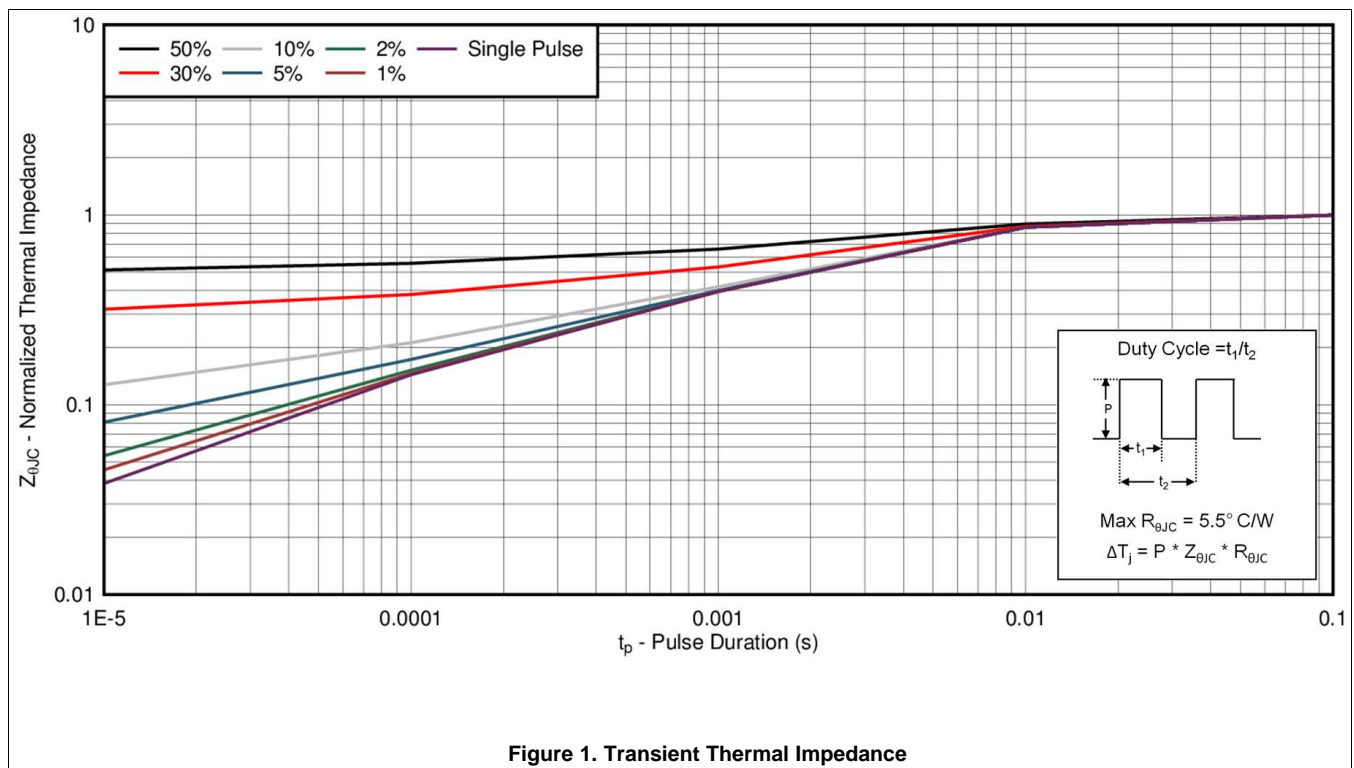

Typical MOSFET Characteristics (continued)

T_A = 25°C (unless otherwise stated)

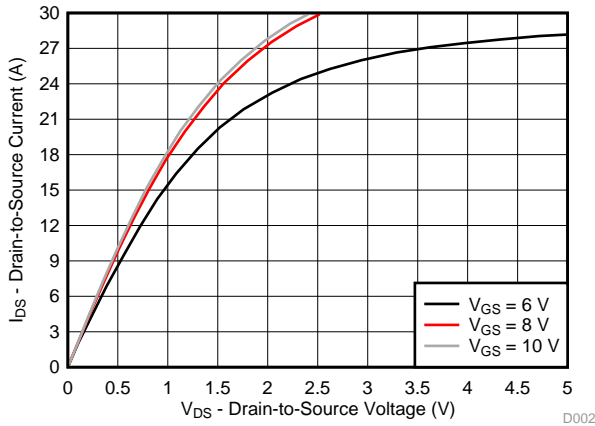

Figure 2. Saturation Characteristics

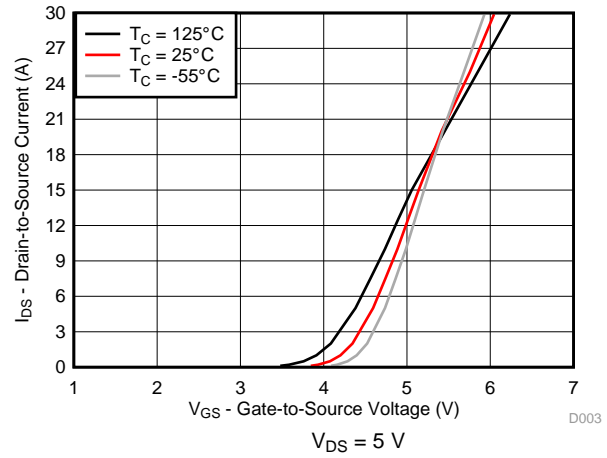

Figure 3. Transfer Characteristics

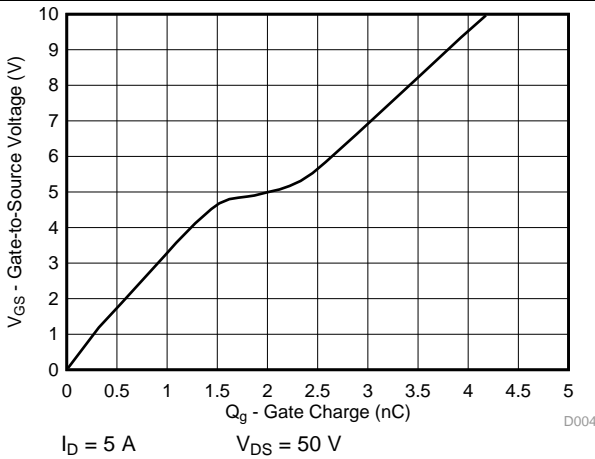

Figure 4. Gate Charge

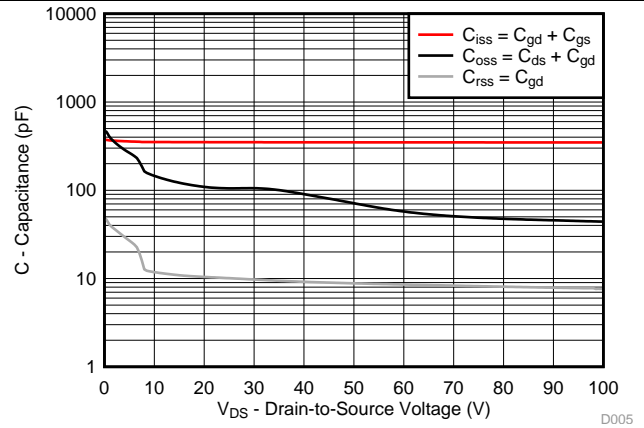

Figure 5. Capacitance

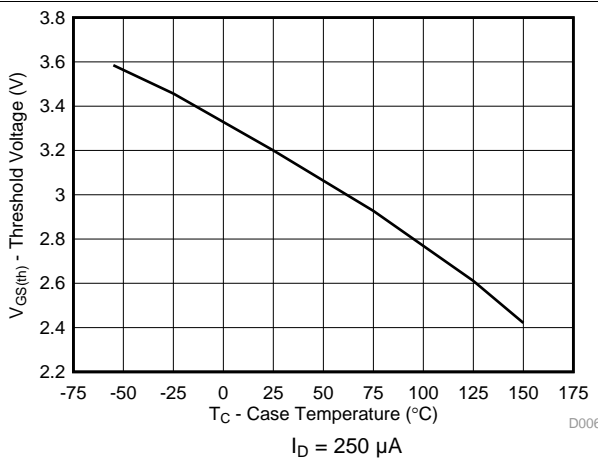

Figure 6. Threshold Voltage vs Temperature

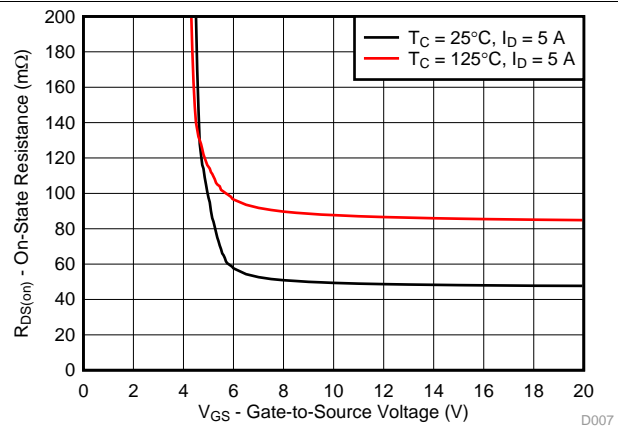

Figure 7. On-State Resistance vs Gate-to-Source Voltage

Typical MOSFET Characteristics (continued)

T_A = 25°C (unless otherwise stated)

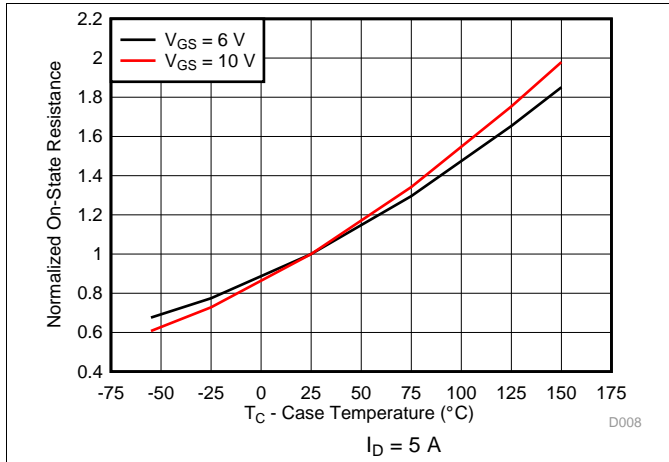

Figure 8. Normalized On-State Resistance vs Temperature

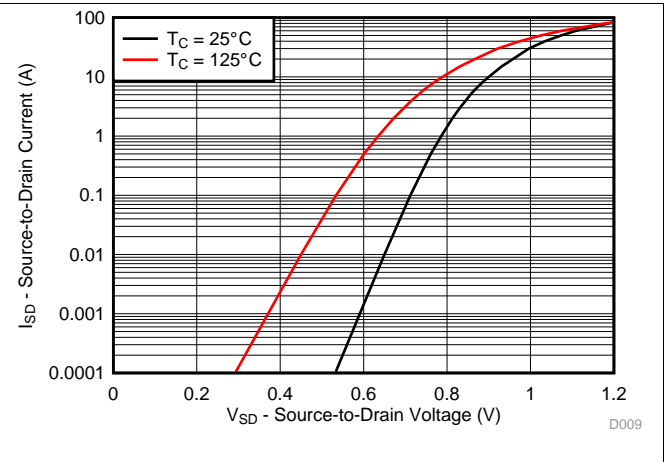

Figure 9. Typical Diode Forward Voltage

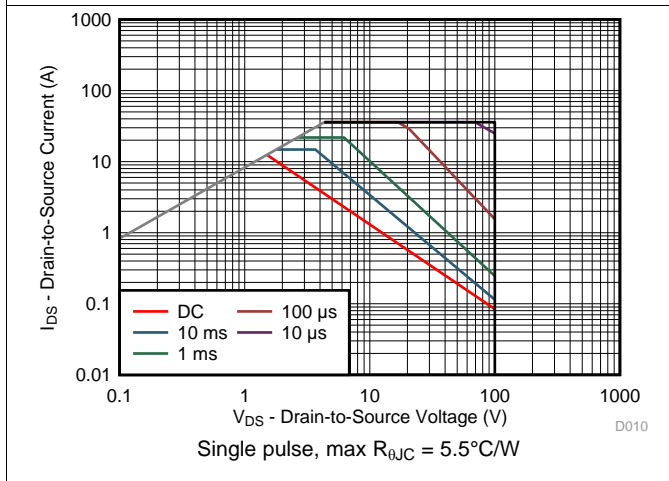

Figure 10. Maximum Safe Operating Area

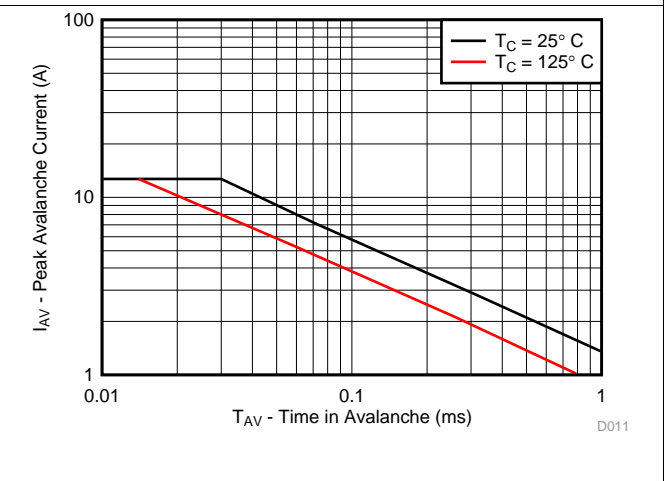

Figure 11. Single Pulse Unclamped Inductive Switching

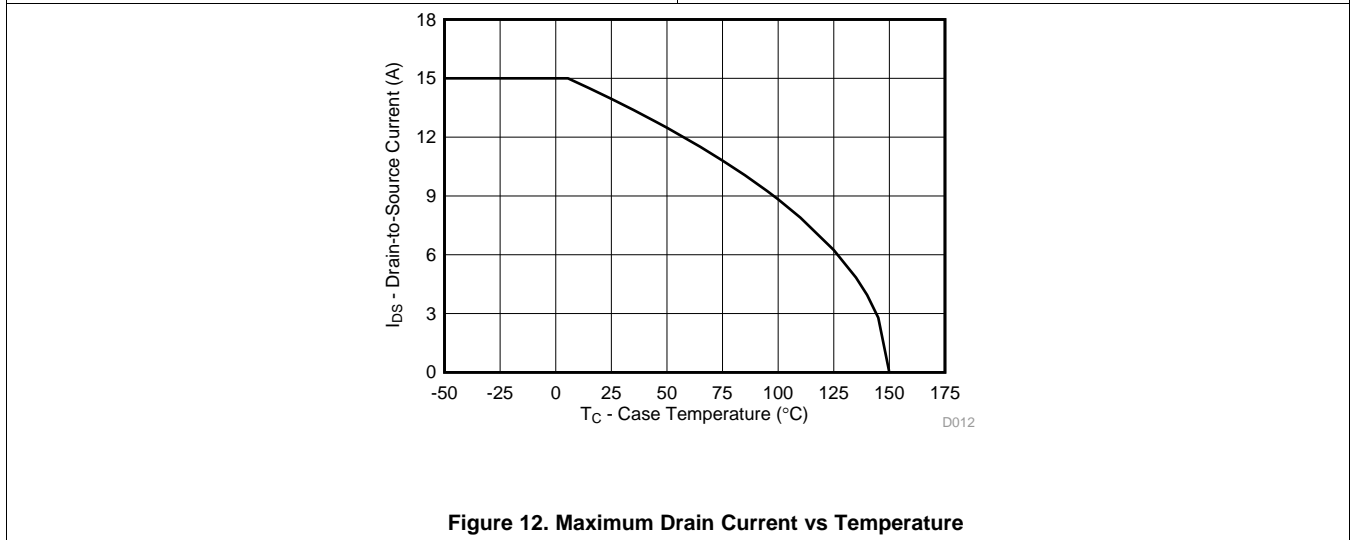

Figure 12. Maximum Drain Current vs Temperature

6 Device and Documentation Support

6.1 Receiving Notification of Documentation Updates

To receive notification of documentation updates, navigate to the device product folder on ti.com. In the upper right corner, click on *Alert me* to register and receive a weekly digest of any product information that has changed. For change details, review the revision history included in any revised document.

6.2 Community Resources

The following links connect to TI community resources. Linked contents are provided "AS IS" by the respective contributors. They do not constitute TI specifications and do not necessarily reflect TI's views; see TI's [Terms of Use](#).

TI E2E™ Online Community *TI's Engineer-to-Engineer (E2E) Community*. Created to foster collaboration among engineers. At e2e.ti.com, you can ask questions, share knowledge, explore ideas and help solve problems with fellow engineers.

Design Support *TI's Design Support* Quickly find helpful E2E forums along with design support tools and contact information for technical support.

6.3 Trademarks

NexFET, E2E are trademarks of Texas Instruments.
All other trademarks are the property of their respective owners.

6.4 Electrostatic Discharge Caution



These devices have limited built-in ESD protection. The leads should be shorted together or the device placed in conductive foam during storage or handling to prevent electrostatic damage to the MOS gates.

6.5 Glossary

[SLYZ022](#) — *TI Glossary*.

This glossary lists and explains terms, acronyms, and definitions.

7 Mechanical, Packaging, and Orderable Information

The following pages include mechanical, packaging, and orderable information. This information is the most current data available for the designated devices. This data is subject to change without notice and revision of this document. For browser-based versions of this data sheet, refer to the left-hand navigation.

7.1 Q3A Package Dimensions

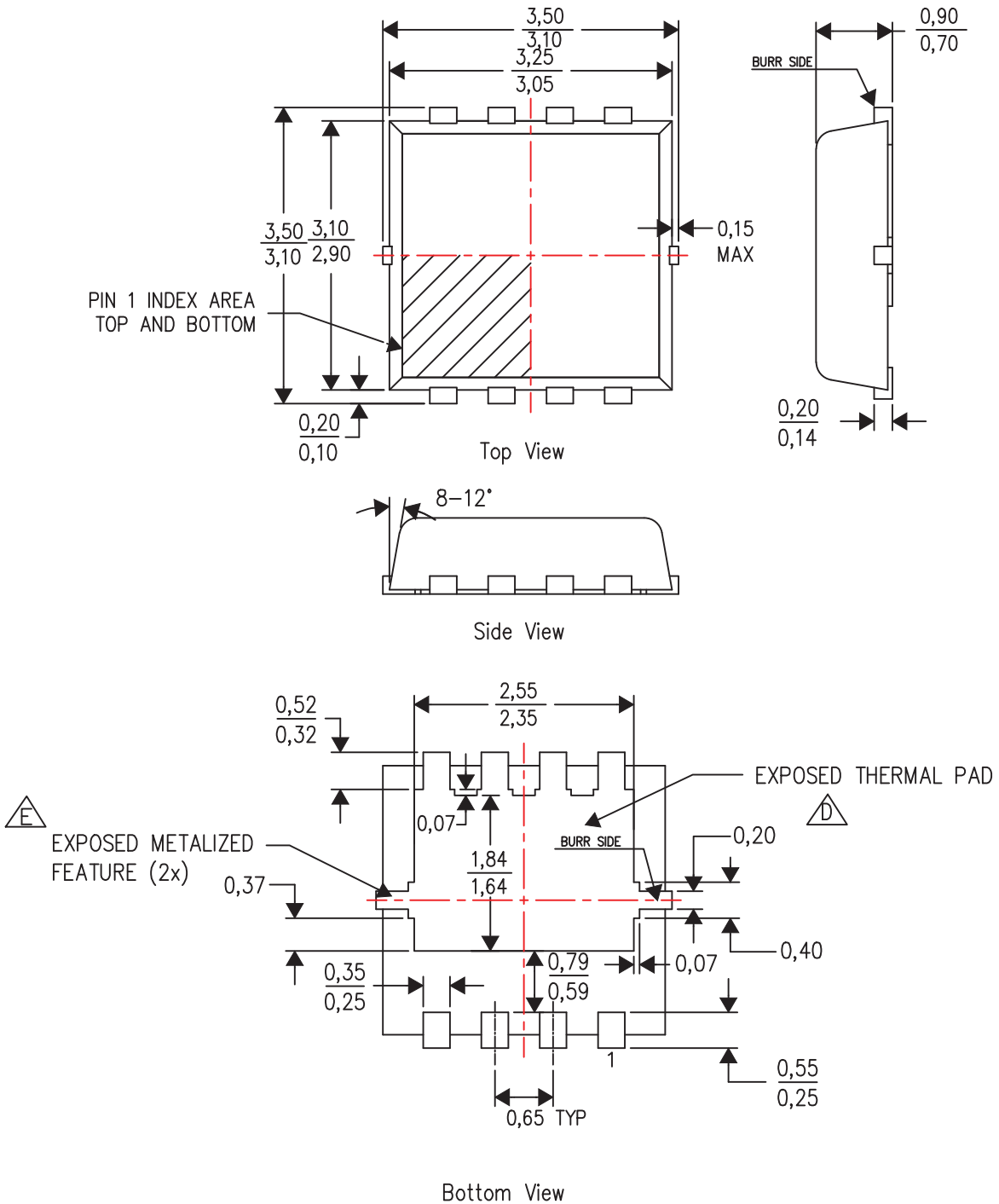

7.2 Q3A Recommended PCB Pattern

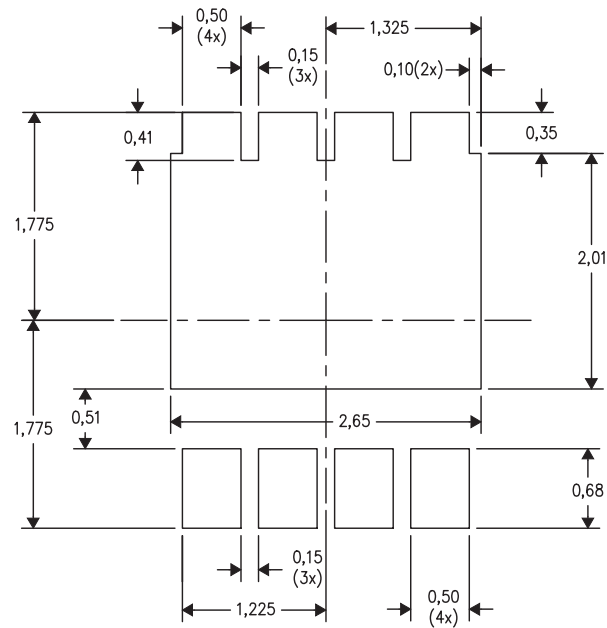

For recommended circuit layout for PCB designs, see [Reducing Ringing Through PCB Layout Techniques](#) (SLPA005).

7.3 Q3A Recommended Stencil Pattern

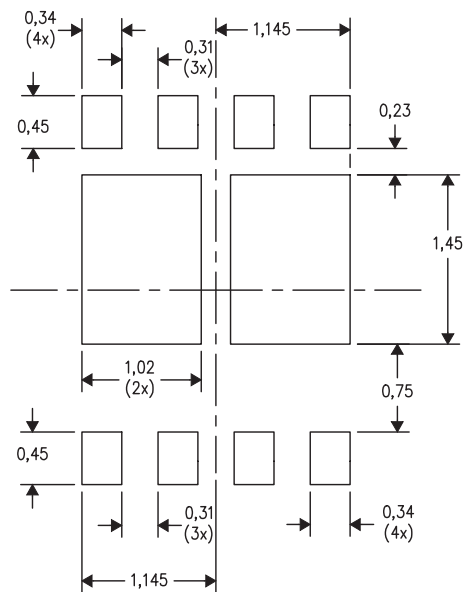

7.4 Q3A Tape and Reel Information



M0144-01

- Notes:
1. 10-sprocket hole-pitch cumulative tolerance ± 0.2 .
 2. Camber not to exceed 1 mm in 100 mm, noncumulative over 250 mm.
 3. Material: black static-dissipative polystyrene.
 4. All dimensions are in mm, unless otherwise specified.
 5. Thickness: 0.3 ± 0.05 mm.
 6. MSL1 260°C (IR and convection) PbF-reflow compatible.

PACKAGING INFORMATION

Orderable Device	Status (1)	Package Type	Package Drawing	Pins	Package Qty	Eco Plan (2)	Lead finish/ Ball material (6)	MSL Peak Temp (3)	Op Temp (°C)	Device Marking (4/5)	Samples
CSD19538Q3A	ACTIVE	VSONP	DNH	8	2500	RoHS & Green	SN	Level-1-260C-UNLIM	-55 to 150	19538	Samples
CSD19538Q3AT	ACTIVE	VSONP	DNH	8	250	RoHS & Green	SN	Level-1-260C-UNLIM	-55 to 150	19538	Samples

(1) The marketing status values are defined as follows:

ACTIVE: Product device recommended for new designs.

LIFEBUY: TI has announced that the device will be discontinued, and a lifetime-buy period is in effect.

NRND: Not recommended for new designs. Device is in production to support existing customers, but TI does not recommend using this part in a new design.

PREVIEW: Device has been announced but is not in production. Samples may or may not be available.

OBSOLETE: TI has discontinued the production of the device.

(2) **RoHS:** TI defines "RoHS" to mean semiconductor products that are compliant with the current EU RoHS requirements for all 10 RoHS substances, including the requirement that RoHS substance do not exceed 0.1% by weight in homogeneous materials. Where designed to be soldered at high temperatures, "RoHS" products are suitable for use in specified lead-free processes. TI may reference these types of products as "Pb-Free".

RoHS Exempt: TI defines "RoHS Exempt" to mean products that contain lead but are compliant with EU RoHS pursuant to a specific EU RoHS exemption.

Green: TI defines "Green" to mean the content of Chlorine (Cl) and Bromine (Br) based flame retardants meet JS709B low halogen requirements of <=1000ppm threshold. Antimony trioxide based flame retardants must also meet the <=1000ppm threshold requirement.

(3) MSL, Peak Temp. - The Moisture Sensitivity Level rating according to the JEDEC industry standard classifications, and peak solder temperature.

(4) There may be additional marking, which relates to the logo, the lot trace code information, or the environmental category on the device.

(5) Multiple Device Markings will be inside parentheses. Only one Device Marking contained in parentheses and separated by a "~" will appear on a device. If a line is indented then it is a continuation of the previous line and the two combined represent the entire Device Marking for that device.

(6) Lead finish/Ball material - Orderable Devices may have multiple material finish options. Finish options are separated by a vertical ruled line. Lead finish/Ball material values may wrap to two lines if the finish value exceeds the maximum column width.

Important Information and Disclaimer:The information provided on this page represents TI's knowledge and belief as of the date that it is provided. TI bases its knowledge and belief on information provided by third parties, and makes no representation or warranty as to the accuracy of such information. Efforts are underway to better integrate information from third parties. TI has taken and continues to take reasonable steps to provide representative and accurate information but may not have conducted destructive testing or chemical analysis on incoming materials and chemicals. TI and TI suppliers consider certain information to be proprietary, and thus CAS numbers and other limited information may not be available for release.

In no event shall TI's liability arising out of such information exceed the total purchase price of the TI part(s) at issue in this document sold by TI to Customer on an annual basis.

DNH0008A



PACKAGE OUTLINE

VSONP - 0.9 mm max height

PLASTIC SMALL OUTLINE - NO LEAD

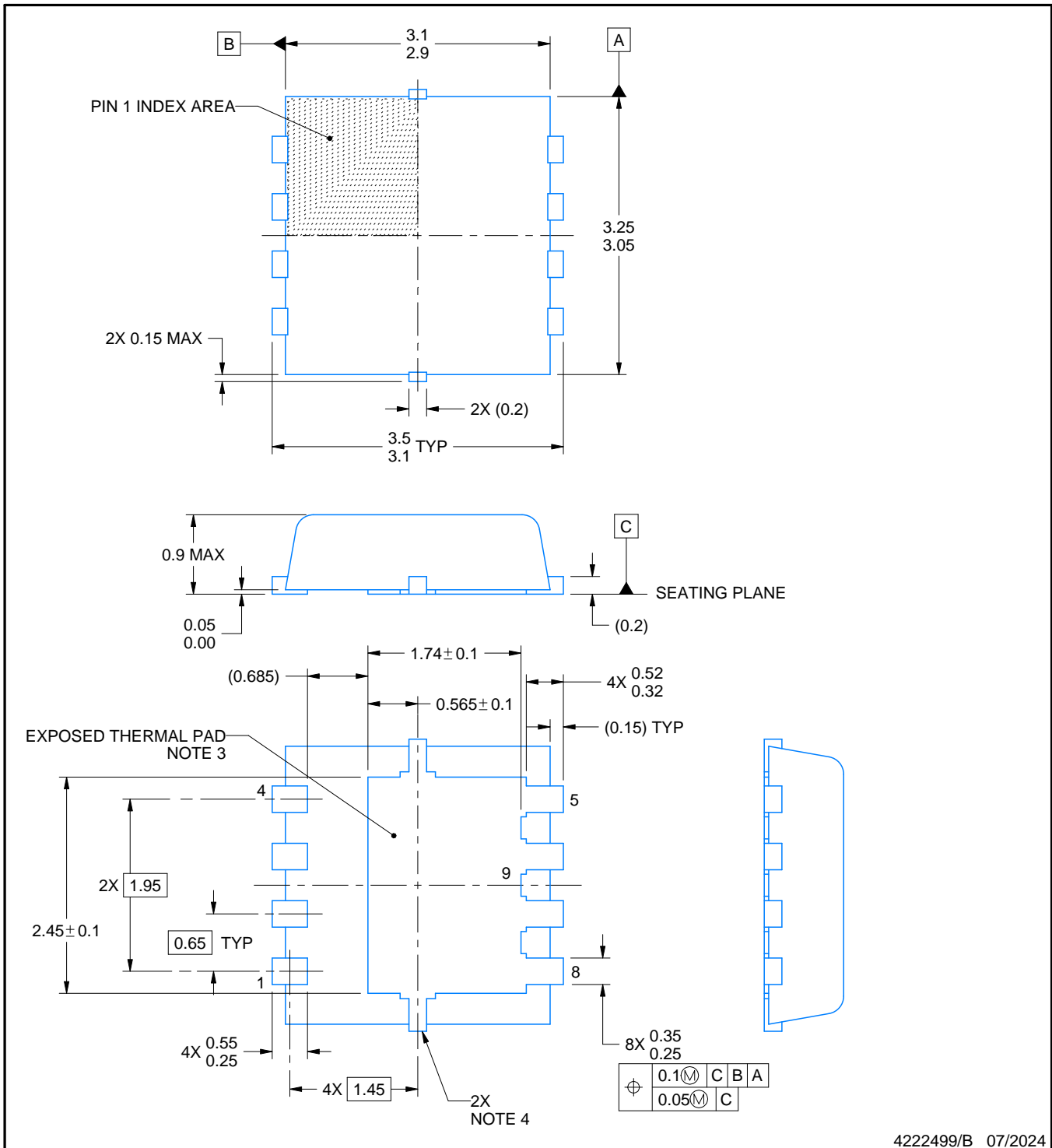

4222499/B 07/2024

NOTES:

1. All linear dimensions are in millimeters. Any dimensions in parenthesis are for reference only. Dimensioning and tolerancing per ASME Y14.5M.
2. This drawing is subject to change without notice.
3. The package thermal pad must be soldered to the printed circuit board for thermal and mechanical performance.
4. Metalized features are supplier options and may not be on the package.
5. All dimensions do not include mold flash or protrusions.

EXAMPLE BOARD LAYOUT

DNH0008A

VSONP - 0.9 mm max height

PLASTIC SMALL OUTLINE - NO LEAD

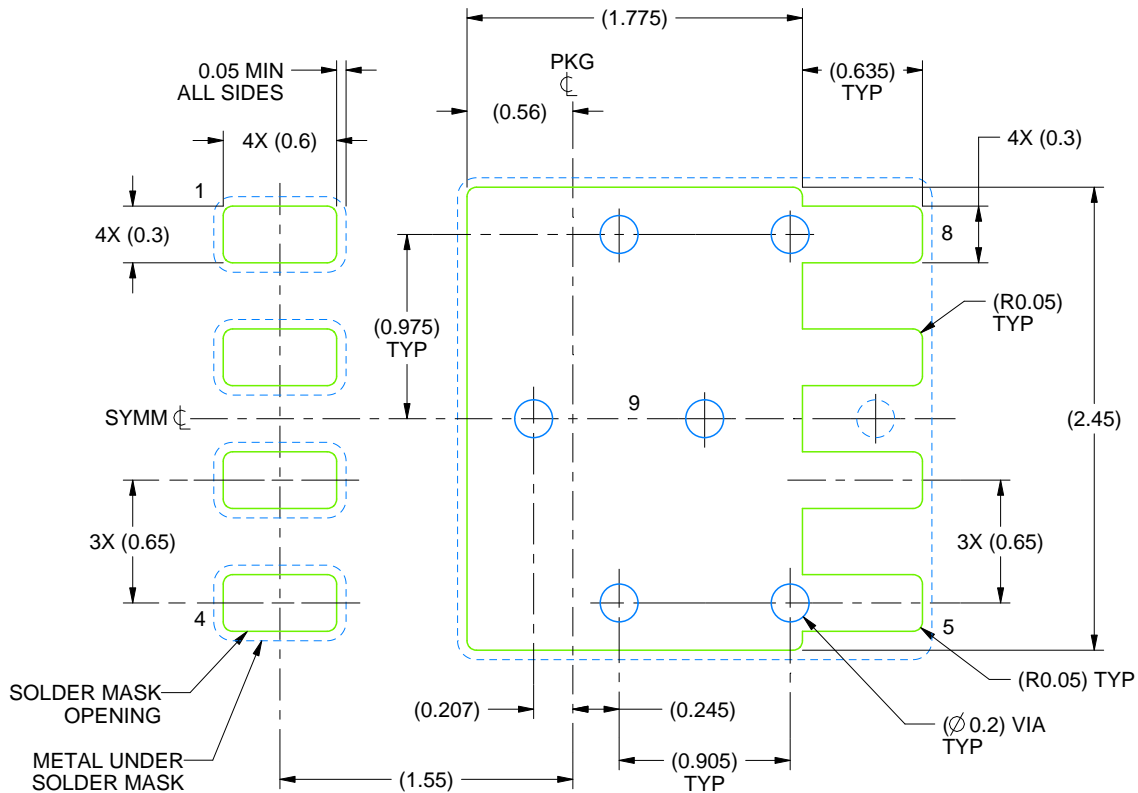

LAND PATTERN EXAMPLE
SOLDER MASK DEFINED
SCALE: 25X

4222499/B 07/2024

NOTES: (continued)

6. This package is designed to be soldered to a thermal pad on the board. For more information, see Texas Instruments literature number SLUA271 (www.ti.com/lit/sluea271).

7. Vias are optional depending on application, refer to device data sheet. If some or all are implemented, recommended via locations are shown.

EXAMPLE STENCIL DESIGN

DNH0008A

VSONP - 0.9 mm max height

PLASTIC SMALL OUTLINE - NO LEAD

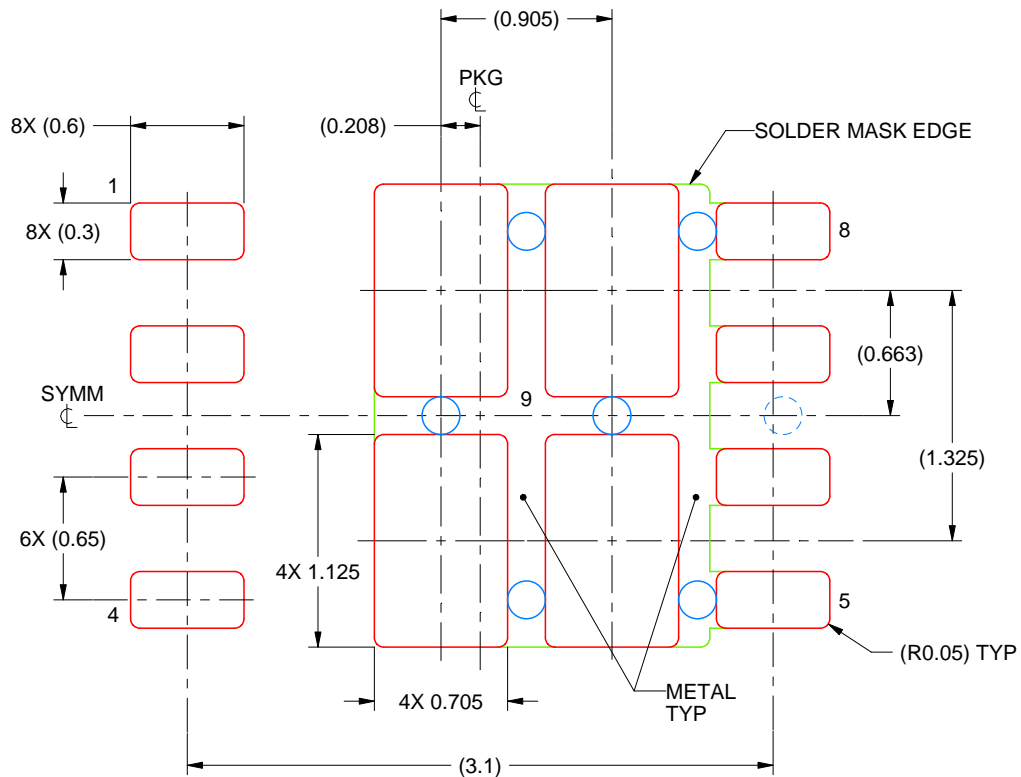

SOLDER PASTE EXAMPLE
BASED ON 0.125 mm THICK STENCIL

EXPOSED PAD 9:
76% PRINTED SOLDER COVERAGE BY AREA UNDER PACKAGE
SCALE: 25X

4222499/B 07/2024

NOTES: (continued)

8. Laser cutting apertures with trapezoidal walls and rounded corners may offer better paste release. IPC-7525 may have alternate design recommendations.

IMPORTANT NOTICE AND DISCLAIMER

TI PROVIDES TECHNICAL AND RELIABILITY DATA (INCLUDING DATA SHEETS), DESIGN RESOURCES (INCLUDING REFERENCE DESIGNS), APPLICATION OR OTHER DESIGN ADVICE, WEB TOOLS, SAFETY INFORMATION, AND OTHER RESOURCES "AS IS" AND WITH ALL FAULTS, AND DISCLAIMS ALL WARRANTIES, EXPRESS AND IMPLIED, INCLUDING WITHOUT LIMITATION ANY IMPLIED WARRANTIES OF MERCHANTABILITY, FITNESS FOR A PARTICULAR PURPOSE OR NON-INFRINGEMENT OF THIRD PARTY INTELLECTUAL PROPERTY RIGHTS.

These resources are intended for skilled developers designing with TI products. You are solely responsible for (1) selecting the appropriate TI products for your application, (2) designing, validating and testing your application, and (3) ensuring your application meets applicable standards, and any other safety, security, regulatory or other requirements.

These resources are subject to change without notice. TI grants you permission to use these resources only for development of an application that uses the TI products described in the resource. Other reproduction and display of these resources is prohibited. No license is granted to any other TI intellectual property right or to any third party intellectual property right. TI disclaims responsibility for, and you will fully indemnify TI and its representatives against, any claims, damages, costs, losses, and liabilities arising out of your use of these resources.

TI's products are provided subject to [TI's Terms of Sale](#) or other applicable terms available either on [ti.com](https://www.ti.com) or provided in conjunction with such TI products. TI's provision of these resources does not expand or otherwise alter TI's applicable warranties or warranty disclaimers for TI products.

TI objects to and rejects any additional or different terms you may have proposed.

Mailing Address: Texas Instruments, Post Office Box 655303, Dallas, Texas 75265
Copyright © 2024, Texas Instruments Incorporated