

# LM43601-Q1 3.5-V to 36-V, 1-A Synchronous Step-Down Voltage Converter

## 1 Features

- Qualified for Automotive Applications
- AEC-Q100 Qualified With the Following Results:
  - Device Temperature Grade 1:  $-40^{\circ}\text{C}$  to  $+125^{\circ}\text{C}$  Ambient Operating Temperature
- 33- $\mu\text{A}$  Quiescent Current in Regulation
- High Efficiency at Light Load (DCM and PFM)
- Tested to EN55022/CISPR 22 EMI standards
- Integrated Synchronous Rectification
- Adjustable Frequency Range: 200 kHz to 2.2 MHz (500 kHz default)
- Frequency Synchronization to External Clock
- Internal Compensation
- Stable With Almost Any Combination of Ceramic, Polymer, Tantalum, and Aluminum Capacitors
- Power-Good Flag
- Soft Start into Pre-Biased Load
- Internal Soft Start: 4.1 ms
- Extendable Soft-Start Time by External Capacitor
- Output Voltage Tracking Capability
- Precision Enable to Program System UVLO
- Output Short-Circuit Protection With Hiccup Mode
- Overtemperature Thermal Shutdown Protection
- Create a Custom Design Using the LM43601-Q1 With the [WEBENCH® Power Designer](#)

## 2 Applications

- Sub-AM Band Automotive
- Telecommunications Systems
- General Purpose Wide  $V_{\text{IN}}$  Regulation
- High Efficiency Point-Of-Load Regulation

### Simplified Schematic

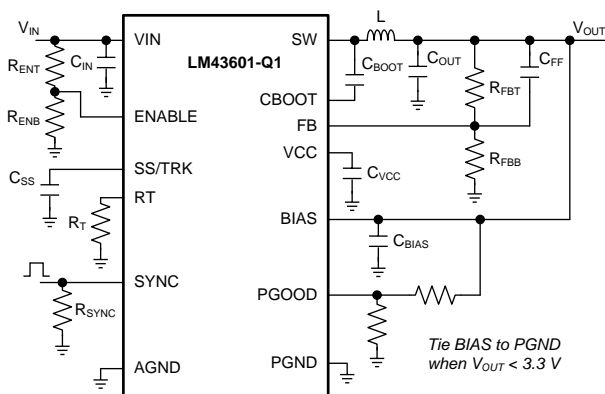

## 3 Description

The LM43601-Q1 regulator is an easy-to-use synchronous step-down DC-DC converter capable of driving up to 1 A of load current from an input voltage ranging from 3.5 V to 36 V (42 V transient). The LM43601-Q1 provides exceptional efficiency, output accuracy and dropout voltage in a very small solution size. An extended family is available in 0.5 A, 2 A, and 3 A load current options in pin-to-pin compatible packages. Peak current mode control is employed to achieve simple control loop compensation and cycle-by-cycle current limiting. Optional features such as programmable switching frequency, synchronization, power-good flag, precision enable, internal soft start, extendable soft start, and tracking provide a flexible and easy-to-use platform for a wide range of applications. Discontinuous conduction and automatic frequency modulation at light loads improve light load efficiency. The family requires few external components and pin arrangement allows simple, optimum PCB layout. Protection features include thermal shutdown,  $V_{\text{CC}}$  undervoltage lockout, cycle-by-cycle current limit, and output short circuit protection. The LM43601-Q1 device is available in the HTSSOP (PWP) 16-leaded package (6.6 mm  $\times$  5.1 mm  $\times$  1.2 mm) with 0.65-mm lead pitch. The device is pin-to-pin compatible with LM4360x and LM4600x families. The LM43601A-Q1 version is optimized for PFM operation and recommended for new designs.

### Device Information<sup>(1)</sup>

PART NUMBER	PACKAGE	BODY SIZE (NOM)
LM43601-Q1	HTSSOP (16)	6.60 mm $\times$ 5.10 mm
LM43601A-Q1		

(1) For all available packages, see the orderable addendum at the end of the data sheet.

### Radiated Emission Graph

$V_{\text{IN}} = 12 \text{ V}$ ,  $V_{\text{OUT}} = 3.3 \text{ V}$ ,  $F_{\text{S}} = 500 \text{ kHz}$ ,  $I_{\text{OUT}} = 1 \text{ A}$

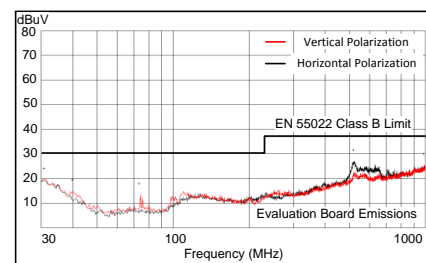

## Table of Contents

<b>1 Features</b> .....	<b>1</b>	7.3 Feature Description .....	<b>15</b>
<b>2 Applications</b> .....	<b>1</b>	7.4 Device Functional Modes .....	<b>23</b>
<b>3 Description</b> .....	<b>1</b>	<b>8 Applications and Implementation</b> .....	<b>24</b>
<b>4 Revision History</b> .....	<b>2</b>	8.1 Application Information .....	<b>24</b>
<b>5 Pin Configuration and Functions</b> .....	<b>3</b>	8.2 Typical Applications .....	<b>24</b>
<b>6 Specifications</b> .....	<b>4</b>	<b>9 Power Supply Recommendations</b> .....	<b>41</b>
6.1 Absolute Maximum Ratings .....	<b>4</b>	<b>10 Layout</b> .....	<b>41</b>
6.2 ESD Ratings .....	<b>4</b>	10.1 Layout Guidelines .....	<b>41</b>
6.3 Recommended Operating Conditions .....	<b>4</b>	10.2 Layout Example .....	<b>44</b>
6.4 Thermal Information .....	<b>5</b>	<b>11 Device and Documentation Support</b> .....	<b>45</b>
6.5 Electrical Characteristics .....	<b>5</b>	11.1 Device Support .....	<b>45</b>
6.6 Timing Requirements .....	<b>7</b>	11.2 Receiving Notification of Documentation Updates .....	<b>45</b>
6.7 Switching Characteristics .....	<b>7</b>	11.3 Community Resources .....	<b>45</b>
6.8 Typical Characteristics .....	<b>8</b>	11.4 Trademarks .....	<b>45</b>
<b>7 Detailed Description</b> .....	<b>14</b>	11.5 Electrostatic Discharge Caution .....	<b>45</b>
7.1 Overview .....	<b>14</b>	11.6 Glossary .....	<b>45</b>
7.2 Functional Block Diagram .....	<b>14</b>	<b>12 Mechanical, Packaging, and Orderable Information</b> .....	<b>45</b>

## 4 Revision History

<b>Changes from Revision A (August 2015) to Revision B</b>	<b>Page</b>
• Added LM43601A-Q1 information on page 1; add Webench links .....	<b>1</b>
• Added R <sub>PGOOD</sub> values for LM43601A-Q1 .....	<b>6</b>

<b>Changes from Original (July 2015) to Revision A</b>	<b>Page</b>
• Changed from Preview to Production Data .....	<b>1</b>

## 5 Pin Configuration and Functions

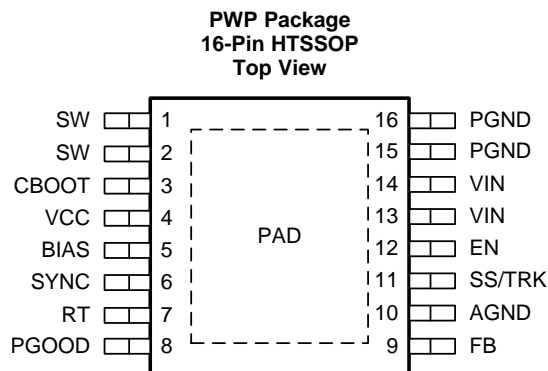

### Pin Functions

PIN			DESCRIPTION
NAME	NUMBER	I/O <sup>(1)</sup>	
SW	1, 2	P	Switching output of the regulator. Internally connected to both power MOSFETs. Connect to power inductor.
CBOOT	3	P	Boot-strap capacitor connection for high-side driver. Connect a high quality 470-nF capacitor from CBOOT to SW.
VCC	4	P	Internal bias supply output for bypassing. Connect bypass capacitor from this pin to AGND. Do not connect external load to this pin. Never short this pin to ground during operation.
BIAS	5	P	Optional internal LDO supply input. To improve efficiency, it is recommended to tie to $V_{OUT}$ when $3.3\text{ V} \leq V_{OUT} \leq 28\text{ V}$ , or tie to an external 3.3-V or 5-V rail if available. When used, place a bypass capacitor (1 to 10 $\mu\text{F}$ ) from this pin to ground. Tie to ground when not in use. Do not float.
SYNC	6	A	Clock input to synchronize switching action to an external clock. Use proper high speed termination to prevent ringing. Connect to ground if not used. Do not float.
RT	7	A	Connect a resistor $R_T$ from this pin to AGND to program switching frequency. Leave floating for 500 kHz default switching frequency.
PGOOD	8	A	Open drain output for power-good flag. Use a 10-k $\Omega$ to 100-k $\Omega$ pullup resistor to logic rail or other DC voltage no higher than 12 V.
FB	9	A	Feedback sense input pin. Connect to the midpoint of feedback divider to set $V_{OUT}$ . Do not short this pin to ground during operation.
AGND	10	G	Analog ground pin. Ground reference for internal references and logic. Connect to system ground.
SS/TRK	11	A	Soft-start control pin. Leave floating for internal soft-start slew rate. Connect to a capacitor to extend soft start time. Connect to external voltage ramp for tracking.
EN	12	A	Enable input to the LM43601-Q1: High = ON and low = OFF. Connect to VIN, or to VIN through resistor divider or to an external voltage or logic source. Do not float.
VIN	13, 14	P	Supply input pins to internal LDO and high side power FET. Connect to power supply and bypass capacitors $C_{IN}$ . Path from VIN pin to high frequency bypass $C_{IN}$ and PGND must be as short as possible.
PGND	15, 16	G	Power ground pins, connected internally to the low side power FET. Connect to system ground, PAD, AGND, ground pins of $C_{IN}$ and $C_{OUT}$ . Path to $C_{IN}$ must be as short as possible.
PAD	—	G	Low impedance connection to AGND. Connect to PGND on PCB. Major heat dissipation path of the die. Must be used for heat sinking to ground plane on PCB.

(1) P = Power, G = Ground, A = Analog

## 6 Specifications

### 6.1 Absolute Maximum Ratings

Over operating free-air temperature range (unless otherwise noted)<sup>(1)</sup>

PARAMETER		MIN	MAX	UNIT
Input voltages	VIN to PGND	−0.3	42	V
	EN to PGND	−0.3	V <sub>IN</sub> + 0.3	
	FB, RT, SS/TRK to AGND	−0.3	3.6	
	PGOOD to AGND	−0.3	15	
	SYNC to AGND	−0.3	5.5	
	BIAS to AGND	−0.3	30	
	AGND to PGND	−0.3	0.3	
Output voltages	SW to PGND	−0.3	V <sub>IN</sub> + 0.3	V
	SW to PGND less than 10-ns transients	−3.5	42	
	CBOOT to SW	−0.3	5.5	
	VCC to AGND	−0.3	3.6	
Storage temperature range, T <sub>stg</sub>		−65	150	°C

(1) Stresses beyond those listed under Absolute Maximum Ratings may cause permanent damage to the device. These are stress ratings only, and functional operation of the device at these or any other conditions beyond those indicated under [Recommended Operating Conditions](#) is not implied. Exposure to absolute-maximum-rated conditions for extended periods may affect device reliability.

### 6.2 ESD Ratings

		VALUE	UNIT
V <sub>(ESD)</sub>	Electrostatic discharge	Human-body model (HBM), per AEC Q100-002 <sup>(1)</sup>	±2000
		Charged-device model (CDM), per AEC Q100-011	±750
			V

(1) AEC Q100-002 indicates that HBM stressing shall be in accordance with the ANSI/ESDA/JEDEC JS-001 specification.

### 6.3 Recommended Operating Conditions

Over operating free-air temperature range (unless otherwise noted)<sup>(1)</sup>

PARAMETER		MIN	MAX	UNIT
Input voltages	VIN to PGND	3.5	36	V
	EN	−0.3	V <sub>IN</sub>	
	FB	−0.3	1.1	
	PGOOD	−0.3	12	
	BIAS input not used	−0.3	0.3	
	BIAS input used	3.3	V <sub>IN</sub> or 28 <sup>(2)</sup>	
	AGND to PGND	−0.1	0.1	
Output voltage	V <sub>OUT</sub>	1	28	V
Output current	I <sub>OUT</sub>	0	1	A
Operating junction temperature range, T <sub>J</sub>		−40	125	°C

(1) Operating Ratings indicate conditions for which the device is intended to be functional, but do not ensure specific performance limits. For ensured specifications, see [Electrical Characteristics](#).

(2) Whichever is lower.

## 6.4 Thermal Information

THERMAL METRIC <sup>(1)(2)</sup>		LM43601-Q1	
		PWP (HTSSOP)	
		16 PINS	
Symbol	Description	Value	Unit
$R_{\theta JA}$	Junction-to-ambient thermal resistance	39.9 <sup>(3)</sup>	°C/W
$R_{\theta JC(top)}$	Junction-to-case (top) thermal resistance	26.9	°C/W
$R_{\theta JB}$	Junction-to-board thermal resistance	21.7	°C/W
$\psi_{JT}$	Junction-to-top characterization parameter	0.8	°C/W
$\psi_{JB}$	Junction-to-board characterization parameter	21.5	°C/W
$R_{\theta JC(bot)}$	Junction-to-case (bottom) thermal resistance	2.3	°C/W

- (1) For more information about traditional and new thermal metrics, see the [Semiconductor and IC Package Thermal Metrics](#) application report.
- (2) The package thermal impedance is calculated in accordance with JESD 51-7 standard with a 4-layer board and 1 W power dissipation.
- (3)  $R_{\theta JA}$  is highly related to PCB layout and heat sinking. See [Figure 107](#) for measured  $R_{\theta JA}$  vs PCB area from a 2-layer board and a 4-layer board.

## 6.5 Electrical Characteristics

Limits apply over the recommended operating junction temperature ( $T_J$ ) range of  $-40^{\circ}\text{C}$  to  $+125^{\circ}\text{C}$ , unless otherwise stated. Minimum and Maximum limits are specified through test, design or statistical correlation. Typical values represent the most likely parametric norm at  $T_J = 25^{\circ}\text{C}$ , and are provided for reference purposes only. Unless otherwise stated, the following conditions apply:  $V_{IN} = 12\text{ V}$ ,  $V_{OUT} = 3.3\text{ V}$ ,  $F_S = 500\text{ kHz}$ .

PARAMETER		CONDITIONS	MIN	TYP	MAX	UNIT
<b>SUPPLY VOLTAGE (VIN PINS)</b>						
$V_{IN-MIN-ST}$	Minimum input voltage for start-up				3.8	V
$I_{SHDN}$	Shutdown quiescent current	$V_{EN} = 0\text{ V}$		1.1	3.1	$\mu\text{A}$
$I_{Q-NONSW}$	Operating quiescent current (non-switching) from $V_{IN}$	$V_{EN} = 3.3\text{ V}$ $V_{FB} = 1.5\text{ V}$ $V_{BIAS} = 3.4\text{ V external}$		6	11	$\mu\text{A}$
$I_{BIAS-NONSW}$	Operating quiescent current (non-switching) from external $V_{BIAS}$	$V_{EN} = 3.3\text{ V}$ $V_{FB} = 1.5\text{ V}$ $V_{BIAS} = 3.4\text{ V external}$		85	140	$\mu\text{A}$
$I_{Q-SW}$	Operating quiescent current (switching)	$V_{EN} = 3.3\text{ V}$ $I_{OUT} = 0\text{ A}$ $R_T = \text{open}$ $V_{BIAS} = V_{OUT} = 3.3\text{ V}$ $R_{FBT} = 1\text{ Meg}$		33		$\mu\text{A}$
<b>ENABLE (EN PIN)</b>						
$V_{EN-VCC-H}$	Voltage level to enable the internal LDO output $V_{CC}$	$V_{ENABLE}$ high level	1.2			V
$V_{EN-VCC-L}$	Voltage level to disable the internal LDO output $V_{CC}$	$V_{ENABLE}$ low level			0.4	V
$V_{EN-VOUT-H}$	Precision enable level for switching and regulator output: $V_{OUT}$	$V_{ENABLE}$ high level	2	2.1	2.42	V
$V_{EN-VOUT-HYS}$	Hysteresis voltage between $V_{OUT}$ precision enable and disable thresholds	$V_{ENABLE}$ hysteresis		-305		mV
$I_{LKG-EN}$	Enable input leakage current	$V_{EN} = 3.3\text{ V}$		0.8	1.75	$\mu\text{A}$
<b>INTERNAL LDO (VCC PIN AND BIAS PIN)</b>						
$V_{CC}$	Internal LDO output voltage $V_{CC}$	$V_{IN} \geq 3.8\text{ V}$		3.3		V
$V_{CC-UVLO}$	Undervoltage lockout (UVLO) thresholds for $V_{CC}$	$V_{CC}$ rising threshold		3.14		V
		Hysteresis voltage between rising and falling thresholds		-567		mV
$V_{BIAS-ON}$	Internal LDO input change over threshold to BIAS	$V_{BIAS}$ rising threshold		2.96	3.2	V
		Hysteresis voltage between rising and falling thresholds		-74		mV

## Electrical Characteristics (continued)

Limits apply over the recommended operating junction temperature ( $T_J$ ) range of  $-40^{\circ}\text{C}$  to  $+125^{\circ}\text{C}$ , unless otherwise stated. Minimum and Maximum limits are specified through test, design or statistical correlation. Typical values represent the most likely parametric norm at  $T_J = 25^{\circ}\text{C}$ , and are provided for reference purposes only. Unless otherwise stated, the following conditions apply:  $V_{IN} = 12\text{ V}$ ,  $V_{OUT} = 3.3\text{ V}$ ,  $F_S = 500\text{ kHz}$ .

PARAMETER		CONDITIONS	MIN	TYP	MAX	UNIT
<b>VOLTAGE REFERENCE (FB PIN)</b>						
$V_{FB}$	Feedback voltage	$T_J = 25^{\circ}\text{C}$	1.009	1.016	1.023	V
		$T_J = -40^{\circ}\text{C}$ to $125^{\circ}\text{C}$	0.999	1.016	1.039	
$I_{LKG-FB}$	Input leakage current at FB pin	FB = 1.016 V		0.2	65	nA
<b>THERMAL SHUTDOWN</b>						
$T_{SD}^{(1)}$	Thermal shutdown	Shutdown threshold		160		$^{\circ}\text{C}$
		Recovery threshold		150		
<b>CURRENT LIMIT AND HICCUP</b>						
$I_{HS-LIMIT}$	Peak inductor current limit		2.07	2.45	2.71	A
$I_{LS-LIMIT}$	Valley Inductor current limit		0.94	1.1	1.25	A
<b>SOFT START (SS/TRK PIN)</b>						
$I_{SSC}$	Soft-start charge current		1.17	2.2	2.85	$\mu\text{A}$
$R_{SSD}$	Soft-start discharge resistance	UVLO, TSD, OCP, or EN = 0 V		16		k $\Omega$
<b>POWER GOOD (PGOOD PIN)</b>						
$V_{PGOOD-HIGH}$	Power-good flag overvoltage tripping threshold	% of FB voltage		110%	113%	
$V_{PGOOD-LOW}$	Power-good flag undervoltage tripping threshold	% of FB voltage	83%	90%		
$V_{PGOOD-HYS}$	Power-good flag recovery hysteresis	% of FB voltage		6%		
$R_{PGOOD}$	PGOOD pin pulldown resistance when power bad	LM43601-Q1: $V_{EN} = 3.3\text{ V}$		40	125	$\Omega$
		LM43601-Q1: $V_{EN} = 0\text{ V}$		60	150	
		LM43601A-Q1: $V_{EN} = 3.3\text{ V}$		69	150	
		LM43601A-Q1: $V_{EN} = 0\text{ V}$		150	350	
<b>MOSFETS<sup>(2)</sup></b>						
$R_{DS-ON-HS}$	High-side MOSFET ON-resistance	$I_{OUT} = 1\text{ A}$ $V_{BIAS} = V_{OUT} = 3.3\text{ V}$		419		m $\Omega$
$R_{DS-ON-LS}$	Low-side MOSFET ON-resistance	$I_{OUT} = 1\text{ A}$ $V_{BIAS} = V_{OUT} = 3.3\text{ V}$		231		m $\Omega$

(1) Specified by design

(2) Measured at package pins

## 6.6 Timing Requirements

PARAMETER		MIN	TYP	MAX	UNIT
<b>CURRENT LIMIT AND HICCUP</b>					
N <sub>OC</sub>	Hiccup wait cycles when LS current limit tripped		32		Cycles
T <sub>OC</sub>	Hiccup retry delay time		5.5		ms
<b>SOFT START (SS/TRK PIN)</b>					
T <sub>SS</sub>	Internal soft-start time when SS pin open circuit		3.86		ms
<b>POWER GOOD (PGOOD PIN)</b>					
T <sub>PGOOD-RISE</sub>	Power-good flag rising transition deglitch delay		220		μs
T <sub>PGOOD-FALL</sub>	Power-good flag falling transition deglitch delay		220		μs

## 6.7 Switching Characteristics

Over operating free-air temperature range (unless otherwise noted)

PARAMETER		TEST CONDITIONS	MIN	TYP	MAX	UNIT
<b>SW (SW PIN)</b>						
T <sub>ON-MIN</sub> <sup>(1)</sup>	Minimum high side MOSFET ON-time			125	165	ns
T <sub>OFF-MIN</sub> <sup>(1)</sup>	Minimum high side MOSFET OFF-time			200	250	ns
<b>OSCILLATOR (SW PINS AND SYNC PIN)</b>						
F <sub>OSC-DEFAULT</sub>	Oscillator default frequency	RT pin open circuit	445	500	570	kHz
F <sub>ADJ</sub>	Minimum adjustable frequency	With 1% resistors at RT pin		200		kHz
	Maximum adjustable frequency			2200		kHz
	Frequency adjust accuracy			10%		
V <sub>SYNC-HIGH</sub>	Sync clock high level threshold		2			V
V <sub>SYNC-LOW</sub>	Sync clock low level threshold				0.4	V
D <sub>SYNC-MAX</sub>	Sync clock maximum duty cycle			90%		
D <sub>SYNC-MIN</sub>	Sync clock minimum duty cycle			10%		
T <sub>SYNC-MIN</sub>	Minimum sync clock ON- and OFF-time			80		ns

(1) Specified by design

### 6.8 Typical Characteristics

Unless otherwise specified,  $V_{IN} = 12\text{ V}$ ,  $V_{OUT} = 3.3\text{ V}$ ,  $F_S = 500\text{ kHz}$ ,  $L = 18\text{ }\mu\text{H}$ ,  $C_{OUT} = 100\text{ }\mu\text{F}$ ,  $C_{FF} = 33\text{ pF}$ . See [Application Performance Curves](#) for Bill of Materials (BOM) for other  $V_{OUT}$  and  $F_S$  combinations.

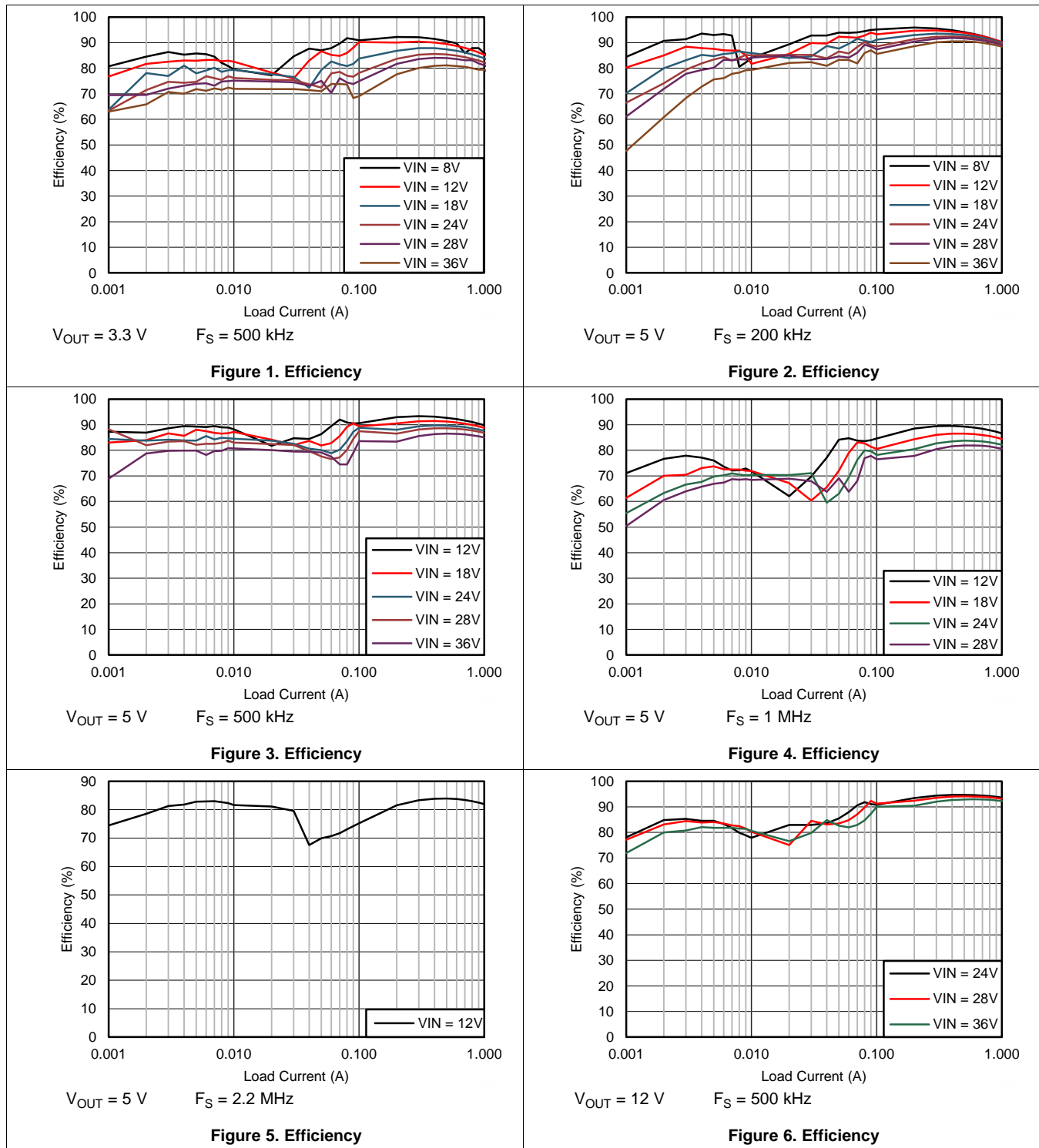



Typical Characteristics (continued)

Unless otherwise specified,  $V_{IN} = 12\text{ V}$ ,  $V_{OUT} = 3.3\text{ V}$ ,  $F_S = 500\text{ kHz}$ ,  $L = 18\text{ }\mu\text{H}$ ,  $C_{OUT} = 100\text{ }\mu\text{F}$ ,  $C_{FF} = 33\text{ pF}$ . See [Application Performance Curves](#) for Bill of Materials (BOM) for other  $V_{OUT}$  and  $F_S$  combinations.

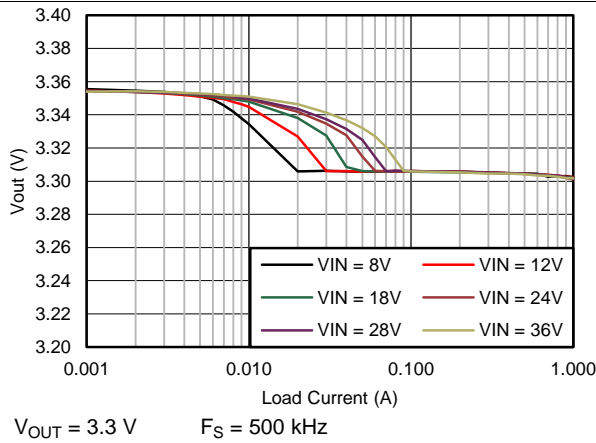

Figure 7.  $V_{OUT}$  Regulation

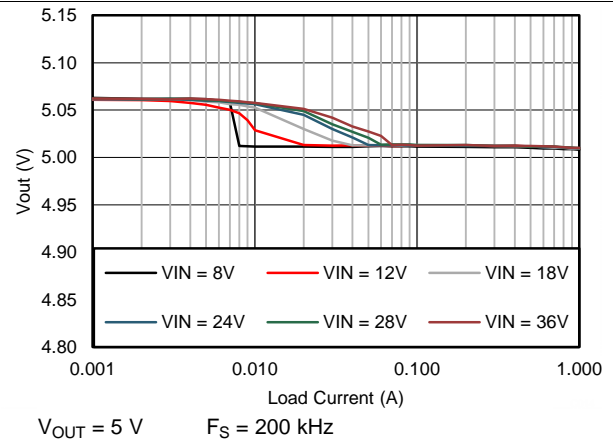

Figure 8.  $V_{OUT}$  Regulation

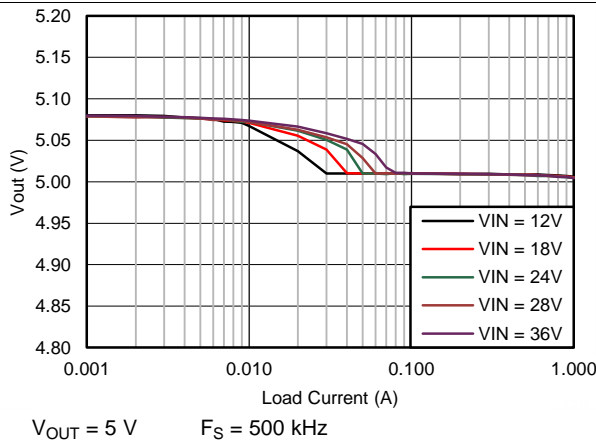

Figure 9.  $V_{OUT}$  Regulation

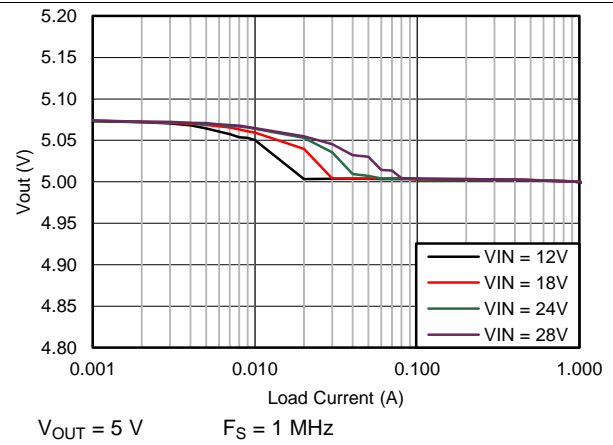

Figure 10.  $V_{OUT}$  Regulation

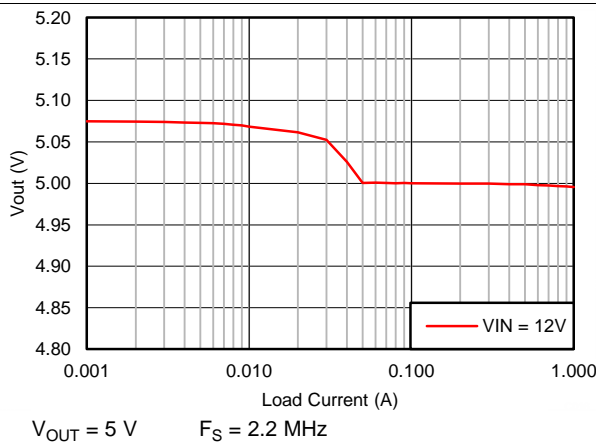

Figure 11.  $V_{OUT}$  Regulation

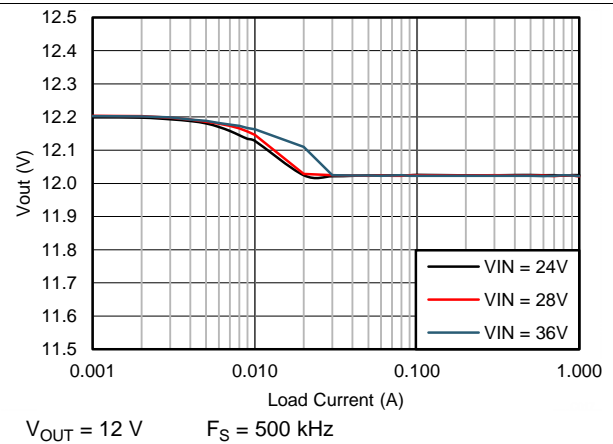

Figure 12.  $V_{OUT}$  Regulation

Typical Characteristics (continued)

Unless otherwise specified,  $V_{IN} = 12\text{ V}$ ,  $V_{OUT} = 3.3\text{ V}$ ,  $F_S = 500\text{ kHz}$ ,  $L = 18\text{ }\mu\text{H}$ ,  $C_{OUT} = 100\text{ }\mu\text{F}$ ,  $C_{FF} = 33\text{ pF}$ . See [Application Performance Curves](#) for Bill of Materials (BOM) for other  $V_{OUT}$  and  $F_S$  combinations.

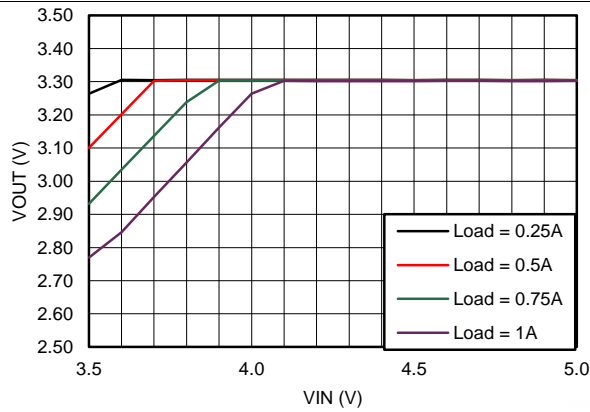

Figure 13. Dropout Curve

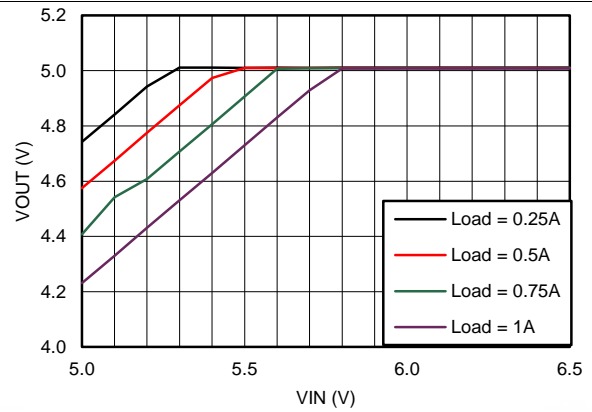

Figure 14. Dropout Curve

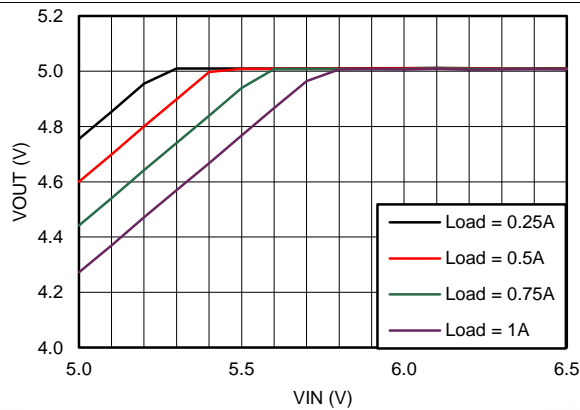

Figure 15. Dropout Curve

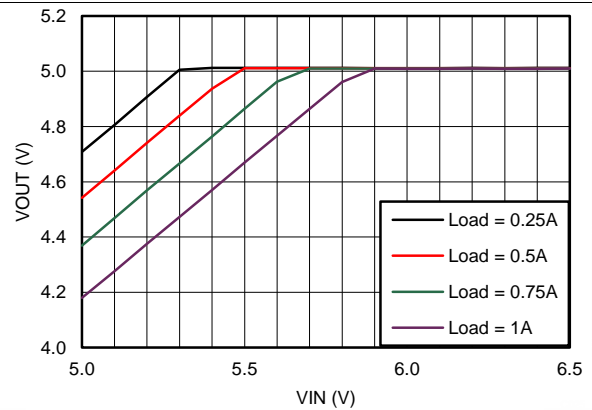

Figure 16. Dropout Curve

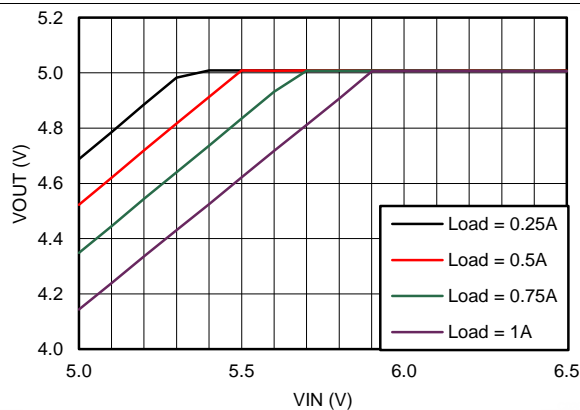

Figure 17. Dropout Curve

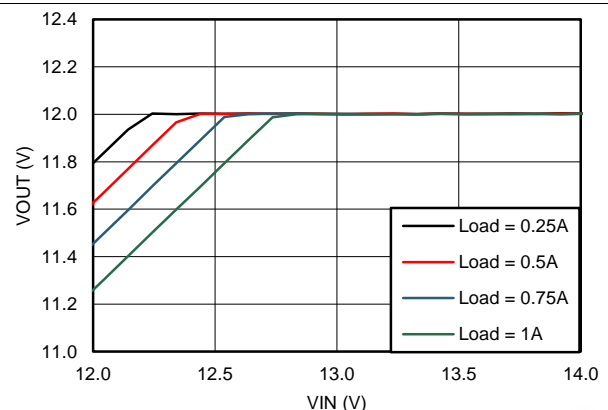

Figure 18. Dropout Curve

Typical Characteristics (continued)

Unless otherwise specified,  $V_{IN} = 12\text{ V}$ ,  $V_{OUT} = 3.3\text{ V}$ ,  $F_S = 500\text{ kHz}$ ,  $L = 18\text{ }\mu\text{H}$ ,  $C_{OUT} = 100\text{ }\mu\text{F}$ ,  $C_{FF} = 33\text{ pF}$ . See [Application Performance Curves](#) for Bill of Materials (BOM) for other  $V_{OUT}$  and  $F_S$  combinations.

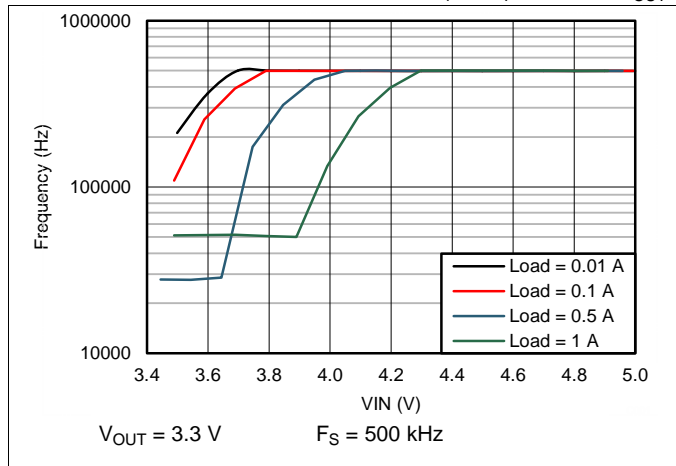

Figure 19. Switching Frequency vs  $V_{IN}$  in Dropout Operation

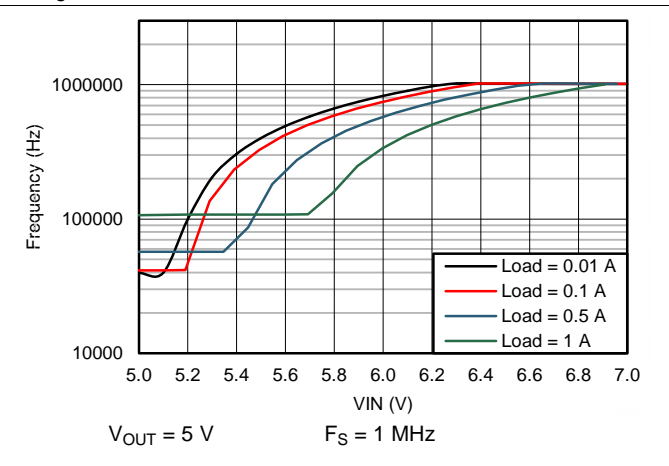

Figure 20. Switching Frequency vs  $V_{IN}$  in Dropout Operation

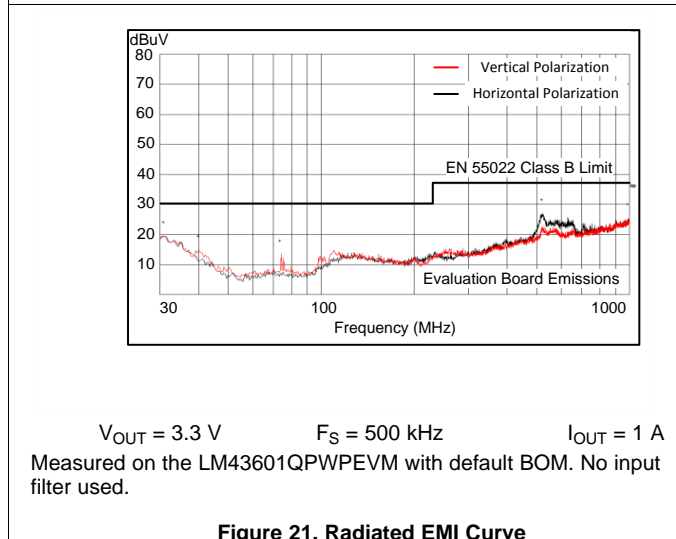

Figure 21. Radiated EMI Curve

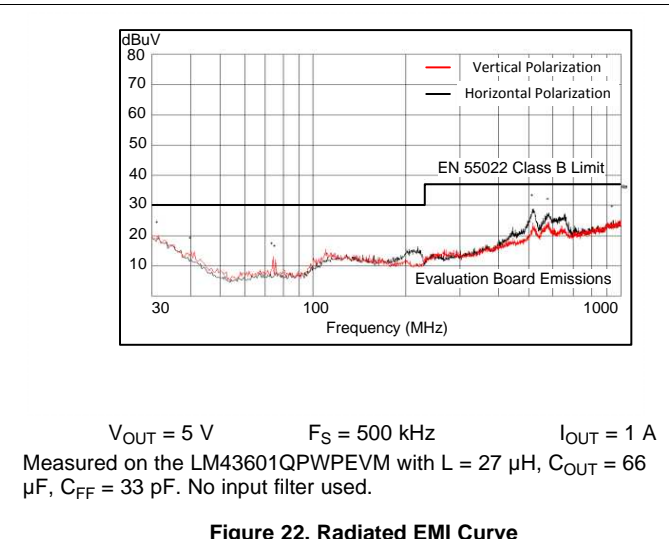

Figure 22. Radiated EMI Curve

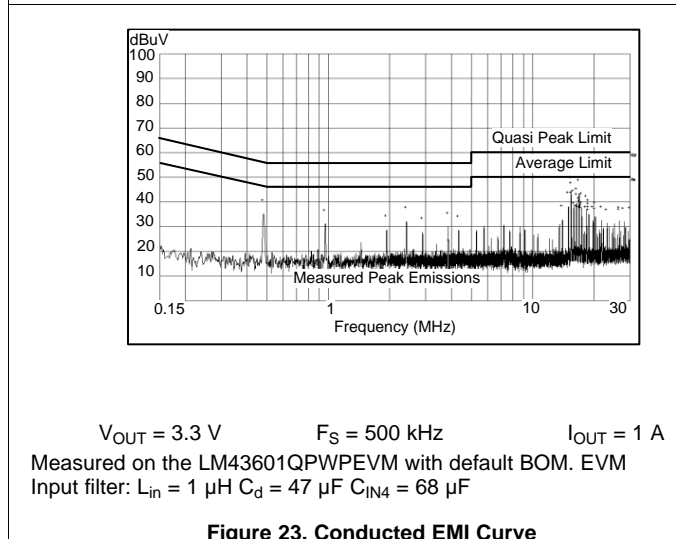

Figure 23. Conducted EMI Curve

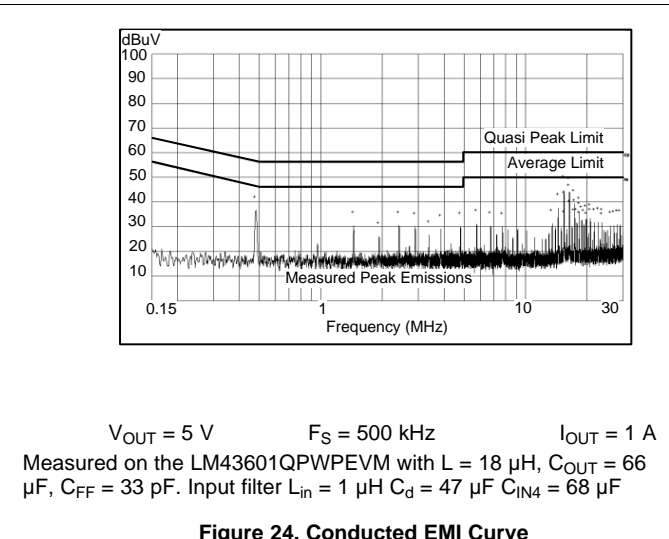

Figure 24. Conducted EMI Curve

### Typical Characteristics (continued)

Unless otherwise specified,  $V_{IN} = 12\text{ V}$ ,  $V_{OUT} = 3.3\text{ V}$ ,  $F_S = 500\text{ kHz}$ ,  $L = 18\text{ }\mu\text{H}$ ,  $C_{OUT} = 100\text{ }\mu\text{F}$ ,  $C_{FF} = 33\text{ pF}$ . See [Application Performance Curves](#) for Bill of Materials (BOM) for other  $V_{OUT}$  and  $F_S$  combinations.

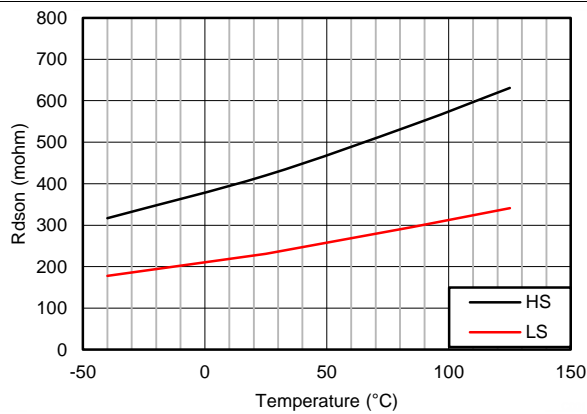

Figure 25. High-Side and Low-Side On-Resistance vs Junction Temperature



Figure 26. Shutdown Current vs Junction Temperature

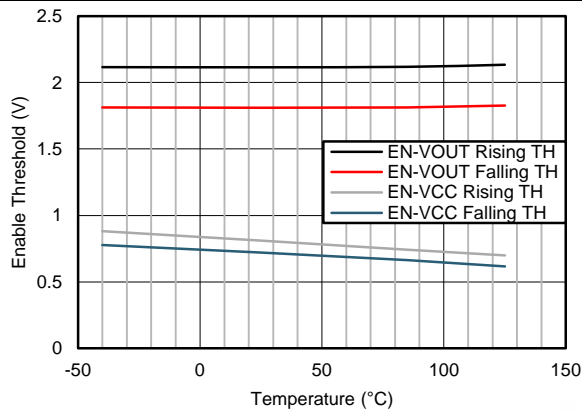

Figure 27. Enable Threshold vs Junction Temperature

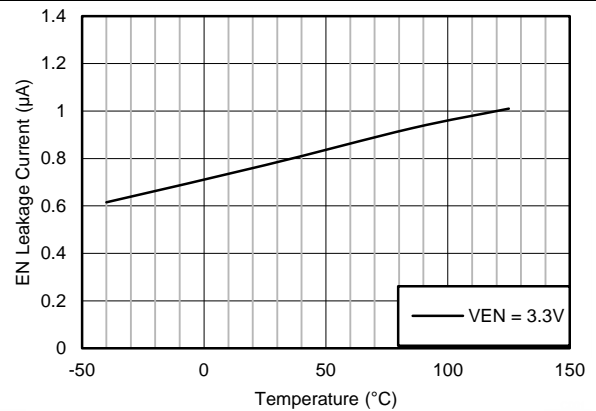

Figure 28. Enable Leakage Current vs Junction Temperature

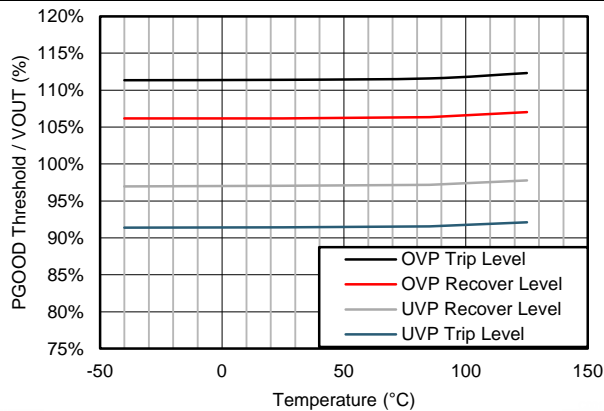

Figure 29. PGOOD Threshold vs Junction Temperature

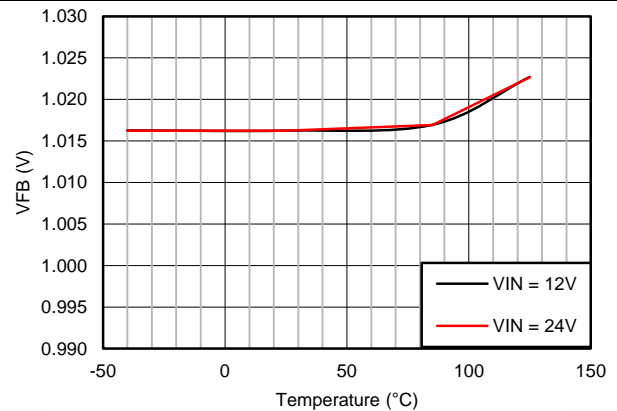
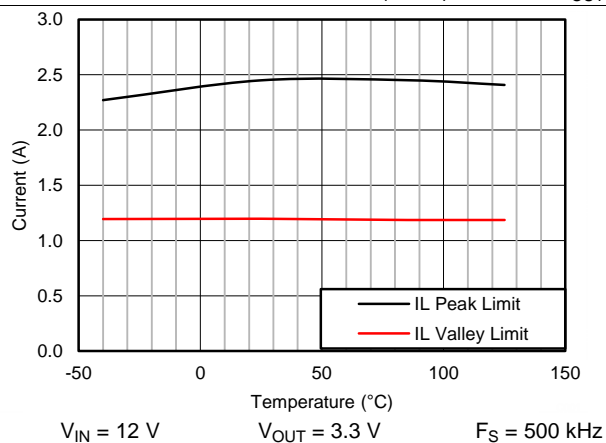

Figure 30. Feedback Voltage vs Junction Temperature

**Typical Characteristics (continued)**

Unless otherwise specified,  $V_{IN} = 12\text{ V}$ ,  $V_{OUT} = 3.3\text{ V}$ ,  $F_S = 500\text{ kHz}$ ,  $L = 18\text{ }\mu\text{H}$ ,  $C_{OUT} = 100\text{ }\mu\text{F}$ ,  $C_{FF} = 33\text{ pF}$ . See [Application Performance Curves](#) for Bill of Materials (BOM) for other  $V_{OUT}$  and  $F_S$  combinations.



**Figure 31. Peak and Valley Current Limits vs Junction Temperature**

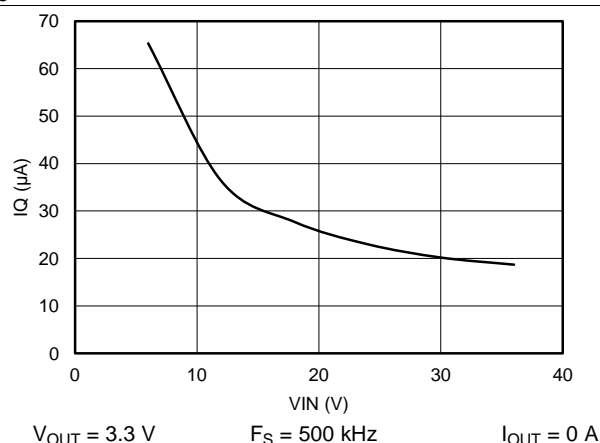

**Figure 32. Operating  $I_Q$  vs  $V_{IN}$  With BIAS Connected to  $V_{OUT}$**

## 7 Detailed Description

### 7.1 Overview

The LM43601-Q1 regulator is an easy-to-use synchronous step-down DC-DC converter that operates from 3.5 V to 36 V supply voltage. It is capable of delivering up to 1-A DC load current with exceptional efficiency and thermal performance in a very small solution size. An extended family is available in 0.5-A, 2-A, and 3-A load options in pin-to-pin compatible packages.

The LM43601-Q1 employs fixed frequency peak current mode control with discontinuous conduction mode (DCM) and pulse frequency modulation (PFM) mode at light load to achieve high efficiency across the load range. The device is internally compensated, which reduces design time, and requires fewer external components. The switching frequency is programmable from 200 kHz to 2.2 MHz by an external resistor,  $R_T$ . It defaults at 500 kHz without  $R_T$ . The LM43601-Q1 is also capable of synchronization to an external clock within the 200-kHz to 2.2-MHz frequency range. The wide switching frequency range allows the device to be optimized to fit small board space at higher frequency, or high efficient power conversion at lower frequency.

Optional features are included for more comprehensive system requirements, including power-good (PGOOD) flag, precision enable, synchronization to external clock, extendable soft-start time, and output voltage tracking. These features provide a flexible and easy to use platform for a wide range of applications. Protection features include over temperature shutdown,  $V_{CC}$  undervoltage lockout (UVLO), cycle-by-cycle current limit, and short-circuit protection with hiccup mode.

The family requires few external components and the pin arrangement was designed for simple, optimum PCB layout. The LM43601-Q1 device is available in the 16-pin HTSSOP / PWP package (6.6 mm × 5.1 mm × 1.2 mm) with 0.65-mm lead pitch.

### 7.2 Functional Block Diagram



## 7.3 Feature Description

### 7.3.1 Fixed Frequency Peak Current Mode Controlled Step-Down Regulator

The following operating description of the LM43601-Q1 refers to the [Functional Block Diagram](#) and to the waveforms in [Figure 33](#). The LM43601-Q1 is a step-down buck regulator with both high-side (HS) switch and low-side (LS) switch (synchronous rectifier) integrated. The LM43601-Q1 supplies a regulated output voltage by turning on the HS and LS NMOS switches with controlled ON time. During the HS switch ON-time, the SW pin voltage  $V_{SW}$  swings up to approximately  $V_{IN}$ , and the inductor current  $I_L$  increases with a linear slope  $(V_{IN} - V_{OUT}) / L$ . When the HS switch is turned off by the control logic, the LS switch is turned on after a anti-shoot-through dead time. Inductor current discharges through the LS switch with a slope of  $-V_{OUT} / L$ . The control parameter of Buck converters are defined as duty cycle  $D = t_{ON} / T_{SW}$ , where  $t_{ON}$  is the HS switch ON time and  $T_{SW}$  is the switching period. The regulator control loop maintains a constant output voltage by adjusting the duty cycle  $D$ . In an ideal Buck converter, where losses are ignored,  $D$  is proportional to the output voltage and inversely proportional to the input voltage:  $D = V_{OUT} / V_{IN}$ .

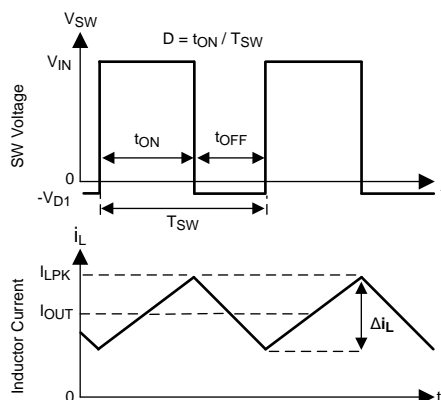

**Figure 33. SW Node and Inductor Current Waveforms in Continuous Conduction Mode (CCM)**

The LM43601-Q1 synchronous buck converter employs peak current mode control topology. A voltage feedback loop is used to get accurate DC voltage regulation by adjusting the peak current command based on voltage offset. The peak inductor current is sensed from the HS switch and compared to the peak current to control the ON-time of the HS switch. The voltage feedback loop is internally compensated, which allows for fewer external components, makes it easy to design, and provides stable operation with almost any combination of output capacitors. The regulator operates with fixed switching frequency in continuous conduction mode (CCM) and discontinuous conduction mode (DCM). At very light load, the LM43601-Q1 will operate in PFM to maintain high efficiency and the switching frequency will decrease with reduced load current.

### 7.3.2 Light Load Operation

DCM operation is employed in the LM43601-Q1 when the inductor current valley reaches zero. The LM43601-Q1 is in DCM when load current is less than half of the peak-to-peak inductor current ripple in CCM. In DCM, the LS switch is turned off when the inductor current reaches zero. Switching loss is reduced by turning off the LS FET at zero current and the conduction loss is lowered by not allowing negative current conduction. Power conversion efficiency is higher in DCM than CCM under the same conditions.

In DCM, the HS switch ON time will reduce with lower load current. When either the minimum HS switch ON-time ( $T_{ON-MIN}$ ) or the minimum peak inductor current ( $I_{PEAK-MIN}$ ) is reached, the switching frequency will decrease to maintain regulation. At this point, the LM43601-Q1 operates in PFM. In PFM, switching frequency is decreased by the control loop when load current reduces to maintain output voltage regulation. Switching loss is further reduced in PFM operation due to less frequent switching actions. [Figure 34](#) shows an example of switching frequency decreases with decreased load current.

Feature Description (continued)

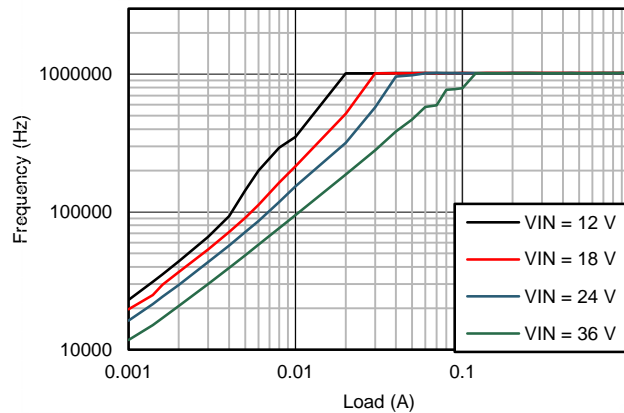

Figure 34. Switching Frequency Decreases With Lower Load Current in PFM Operation  
 $V_{OUT} = 5\text{ V}$   $F_S = 1\text{ MHz}$

In PFM operation, a small positive DC offset is required at the output voltage to activate the PFM detector. The lower the frequency in PFM, the more DC offset is needed at  $V_{OUT}$ . See *Typical Characteristics* for typical DC offset at very light load. If the DC offset on  $V_{OUT}$  is not acceptable for a given application, a static load at output is recommended to reduce or eliminate the offset. Lowering values of the feedback divider  $R_{FBT}$  and  $R_{FBB}$  can also serve as a static load. In conditions with low  $V_{IN}$  and/or high frequency, the LM43601-Q1 may not enter PFM mode if the output voltage cannot be charged up to provide the trigger to activate the PFM detector. Once the LM43601-Q1 is operating in PFM mode at higher  $V_{IN}$ , it will remain in PFM operation when  $V_{IN}$  is reduced.

7.3.3 Adjustable Output Voltage

The voltage regulation loop in the LM43601-Q1 regulates output voltage by maintaining the voltage on FB pin ( $V_{FB}$ ) to be the same as the internal REF voltage ( $V_{REF}$ ). A resistor divider pair is needed to program the ratio from output voltage  $V_{OUT}$  to  $V_{FB}$ . The resistor divider is connected from the  $V_{OUT}$  of the LM43601-Q1 to ground with the mid-point connecting to the FB pin.

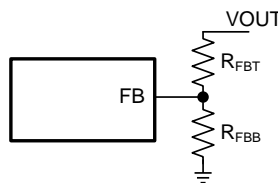

Figure 35. Output Voltage Setting

The voltage reference system produces a precise voltage reference over temperature. The internal REF voltage is 1.016 V typically. To program the output voltage of the LM43601-Q1 to be a certain value  $V_{OUT}$ ,  $R_{FBB}$  can be calculated with a selected  $R_{FBT}$  by

$$R_{FBB} = \frac{V_{FB}}{V_{OUT} - V_{FB}} R_{FBT} \tag{1}$$

The choice of the  $R_{FBT}$  depends on the application.  $R_{FBT}$  in the range from 10 kΩ to 100 kΩ is recommended for most applications. A lower  $R_{FBT}$  value can be used if static loading is desired to reduce  $V_{OUT}$  offset in PFM operation. Lower  $R_{FBT}$  will reduce efficiency at very light load. Less static current goes through a larger  $R_{FBT}$  and might be more desirable when light load efficiency is critical. But  $R_{FBT}$  larger than 1 MΩ is not recommended because it makes the feedback path more susceptible to noise. Larger  $R_{FBT}$  value requires more carefully designed feedback path on the PCB. The tolerance and temperature variation of the resistor dividers affect the output voltage regulation. It is recommended to use divider resistors with 1% tolerance or better and temperature coefficient of 100 ppm or lower.



## Feature Description (continued)

If the resistor divider is not connected properly, the output voltage cannot be regulated since the feedback loop is broken. If the FB pin is shorted to ground, the output voltage will be driven close to  $V_{IN}$ , since the regulator sees very low voltage on the FB pin and tries to regulate it up. The load connected to the output could be damaged under such a condition. Do not short FB pin to ground when the LM43601-Q1 is enabled. It is important to route the feedback trace away from the noisy area of the PCB. For more layout recommendations, see the [Layout](#) section.

### 7.3.4 ENABLE Pin

Voltage on the ENABLE pin ( $V_{EN}$ ) controls the ON or OFF functionality of the LM43601-Q1. Applying a voltage less than 0.4 V to the ENABLE input shuts down the operation of the LM43601-Q1. In shutdown mode the quiescent current drops to typically 1  $\mu$ A at  $V_{IN} = 12$  V.

The internal LDO output voltage  $V_{CC}$  is turned on when  $V_{EN}$  is higher than 1.2 V. The switching action and output regulation are enabled when  $V_{EN}$  is greater than 2.1 V (typical). The LM43601-Q1 supplies regulated output voltage when enabled and output current up to 1 A.

The ENABLE pin is an input and cannot be open circuit or floating. The simplest way to enable the operation of the LM43601-Q1 is to connect the ENABLE pin to VIN pins directly. This allows self-start-up when  $V_{IN}$  is within the operation range.

Many applications will benefit from the employment of an enable divider  $R_{ENT}$  and  $R_{ENB}$  in [Figure 36](#) to establish a precision system UVLO level for the stage. System UVLO can be used for supplies operating from utility power as well as battery power. It can be used for sequencing, ensuring reliable operation, or supply protection, such as a battery discharge voltage level. An external logic signal can also be used to drive EN input for system sequencing and protection.

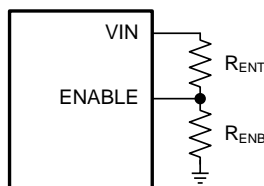

**Figure 36. System UVLO By Enable Dividers**

### 7.3.5 VCC, UVLO and BIAS

The LM43601-Q1 integrates an internal LDO to generate  $V_{CC}$  for control circuitry and MOSFET drivers. The nominal voltage for  $V_{CC}$  is 3.3 V. The VCC pin is the output of the LDO and must be properly bypassed. Place a high-quality ceramic capacitor with 2.2- $\mu$ F to 10- $\mu$ F capacitance and 6.3-V or higher rated voltage as close as possible to VCC and grounded to the exposed PAD and ground pins. The VCC output pin must not be loaded, left floating, or shorted to ground during operation. Shorting VCC to ground during operation may cause damage to the LM43601-Q1.

Undervoltage lockout (UVLO) prevents the LM43601-Q1 from operating until the  $V_{CC}$  voltage exceeds 3.14 V (typical). The  $V_{CC}$  UVLO threshold has 567 mV of hysteresis (typically) to prevent undesired shutting down due to temporary  $V_{IN}$  droops.

The internal LDO has two inputs: primary from VIN and secondary from BIAS input. The BIAS input powers the LDO when  $V_{BIAS}$  is higher than the change-over threshold. Power loss of an LDO is calculated by  $I_{LDO} \times (V_{IN-LDO} - V_{OUT-LDO})$ . The higher the difference between the input and output voltages of the LDO, the more power loss occur to supply the same output current. The BIAS input is designed to reduce the difference of the input and output voltages of the LDO to reduce power loss and improve LM43601-Q1 efficiency, especially at light load. TI recommends that the BIAS pin be tied to  $V_{OUT}$  when  $V_{OUT} \geq 3.3$ V. Ground the BIAS pin in applications with  $V_{OUT}$  less than 3.3 V. BIAS input can also come from an external voltage source, if available, to reduce power loss. When used, a 1- $\mu$ F to 10- $\mu$ F high-quality ceramic capacitor is recommended to bypass the BIAS pin to ground.

## Feature Description (continued)

### 7.3.6 Soft Start and Voltage Tracking (SS/TRK)

The LM43601-Q1 has a flexible and easy-to-use start-up rate control pin: SS/TRK. The soft-start feature is to prevent inrush current impacting the LM43601-Q1 and its supply when power is first applied. Soft start is achieved by slowly ramping up the target regulation voltage when the device is first enabled or powered up.

The simplest way to use the device is to leave the SS/TRK pin open circuit. The LM43601-Q1 employs the internal soft-start control ramp and start-up to the regulated output voltage in 4.1 ms typically.

In applications with a large amount of output capacitors, or higher  $V_{OUT}$ , or other special requirements, the soft-start time can be extended by connecting an external capacitor  $C_{SS}$  from SS/TRK pin to AGND. Extended soft-start time further reduces the supply current needed to charge up output capacitors and supply any output loading. An internal current source ( $I_{SSC} = 2.2 \mu A$ ) charges  $C_{SS}$  and generates a ramp from 0 V to  $V_{FB}$  to control the ramp-up rate of the output voltage. For a desired soft start time  $t_{SS}$ , the capacitance for  $C_{SS}$  can be found by

$$C_{SS} = I_{SSC} \times t_{SS} \quad (2)$$

The soft start capacitor  $C_{SS}$  is discharged by an internal FET when  $V_{OUT}$  is shut down by hiccup protection due to excessive load, temperature shutdown due to overheating or  $ENABLE = \text{logic low}$ . A large  $C_{SS}$  capacitor will take a long time to discharge when  $ENABLE$  is toggled low. If  $ENABLE$  is toggled high again before the  $C_{SS}$  is completely discharged, then the next resulting soft-start ramp follows the internal soft-start ramp. Only when the soft-start voltage reaches the leftover voltage on  $C_{SS}$ , does the output follow the ramp programmed by  $C_{SS}$ . This behavior looks as if there are two slopes at start-up. If this is not acceptable by a certain application, a R-C low pass filter can be added to  $ENABLE$  to slow down the shutting down of  $V_{CC}$ , which allows more time to discharge  $C_{SS}$ .

The LM43601-Q1 is capable of start-up into prebiased output conditions. When the inductor current reaches zero, the LS switch will be turned off to avoid negative current conduction. This operation mode is also called diode emulation mode. It is built-in by the DCM operation at light loads. With a prebiased output voltage, the LM43601-Q1 will wait until the soft-start ramp allows regulation above the prebiased voltage. It will then follow the soft-start ramp to the regulation level.

When an external voltage ramp is applied to the SS/TRK pin, the LM43601-Q1 FB voltage follows the external ramp if the ramp magnitude is lower than the internal soft-start ramp. A resistor divider pair can be used on the external control ramp to the SS/TRK pin to program the tracking rate of the output voltage. The final external ramp voltage applied at the SS/TRK pin should not fall below 1.2 V to avoid abnormal operation.

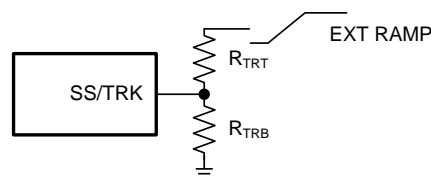

**Figure 37. Soft-Start Tracking External Ramp**

$V_{OUT}$  tracked to an external voltage ramp has the option of ramping up slower or faster than the internal voltage ramp.  $V_{FB}$  always follows the lower potential of the internal voltage ramp and the voltage on the SS/TRK pin. [Figure 38](#) shows the case when  $V_{OUT}$  ramps slower than the internal ramp, while [Figure 39](#) shows when  $V_{OUT}$  ramps faster than the internal ramp. Faster start-up time may result in inductor current tripping current protection during start-up. Use with special care.

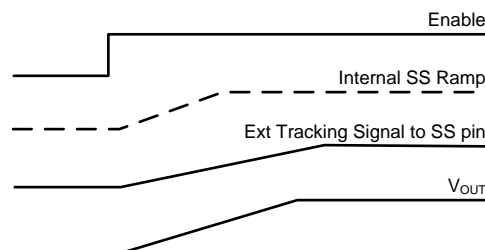

**Figure 38. Tracking With Longer Start-up Time Than the Internal Ramp**

Feature Description (continued)

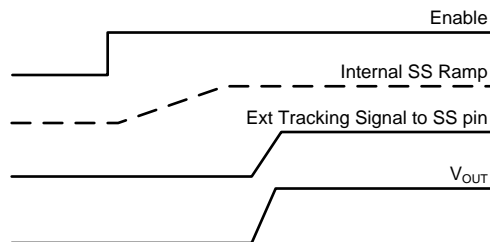

Figure 39. Tracking With Shorter Start-up Time Than the Internal Ramp

7.3.7 Switching Frequency (RT) and Synchronization (SYNC)

The switching frequency of the LM43601-Q1 can be programmed by the impedance  $R_T$  from the RT pin to ground. The frequency is inversely proportional to the  $R_T$  resistance. The RT pin can be left floating, and the LM43601-Q1 will operate at 500-kHz default switching frequency. The RT pin is not designed to be shorted to ground.

For a desired frequency, typical  $R_T$  resistance can be found by Equation 3.

$$R_T(\text{k}\Omega) = 40200 / \text{Freq (kHz)} - 0.6 \tag{3}$$

Figure 40 shows  $R_T$  resistance vs switching frequency  $F_S$  curve.

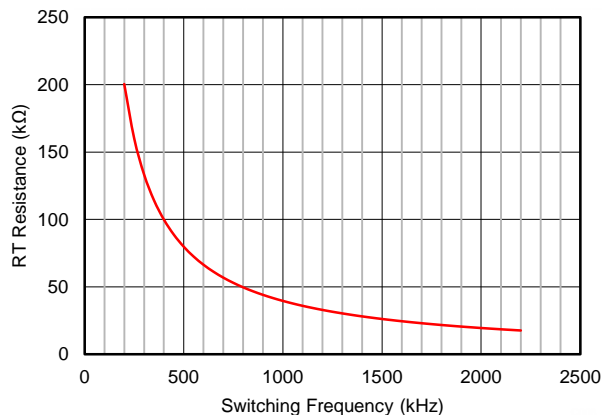

Figure 40.  $R_T$  Resistance vs Switching Frequency

Table 1 provides typical  $R_T$  values for a given  $F_S$ .

Table 1. Typical Frequency Setting  $R_T$  Resistance

$F_S$ (kHz)	$R_T$ (kΩ)
200	200
350	115
500	80.6
750	53.6
1000	39.2
1500	26.1
2000	19.6
2200	17.8

## Feature Description (continued)

The LM43601-Q1 switching action can also be synchronized to an external clock from 200 kHz to 2.2 MHz. Connect an external clock to the SYNC pin, with proper high speed termination, to avoid ringing. The SYNC pin should be grounded if not used.

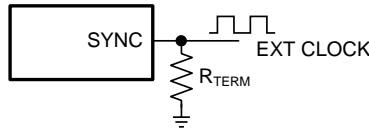

**Figure 41. Frequency Synchronization**

The recommendations for the external clock include high level no lower than 2 V, low level no higher than 0.4 V, duty cycle between 10% and 90%, and both positive and negative pulse width no shorter than 80 ns. When the external clock fails at logic high or low, the LM43601-Q1 switches at the frequency programmed by the  $R_T$  resistor after a time-out period. TI recommends connecting a resistor  $R_T$  to the RT pin so that the internal oscillator frequency is the same as the target clock frequency when the LM43601-Q1 is synchronized to an external clock. This allows the regulator to continue operating at approximately the same switching frequency if the external clock fails.

The choice of switching frequency is usually a compromise between conversion efficiency and the size of the circuit. Lower switching frequency implies reduced switching losses (including gate charge losses, switch transition losses, etc.) and usually results in higher overall efficiency. However, higher switching frequency allows use of smaller LC output filters and hence a more compact design. Lower inductance also helps transient response (higher large signal slew rate of inductor current), and reduces the DCR loss. The optimal switching frequency is usually a trade-off in a given application and thus needs to be determined on a case-by-case basis. It is related to the input voltage, output voltage, most frequent load current level(s), external component choices, and circuit size requirement. The choice of switching frequency may also be limited if an operating condition triggers  $T_{ON-MIN}$  or  $T_{OFF-MIN}$ .

### 7.3.8 Minimum ON-Time, Minimum OFF-Time and Frequency Foldback at Drop-Out Conditions

Minimum ON-time,  $T_{ON-MIN}$ , is the smallest duration of time that the HS switch can be on.  $T_{ON-MIN}$  is typically 125 ns in the LM43601-Q1. Minimum OFF-time,  $T_{OFF-MIN}$ , is the smallest duration that the HS switch can be off.  $T_{OFF-MIN}$  is typically 200 ns in the LM43601-Q1.

In CCM operation,  $T_{ON-MIN}$  and  $T_{OFF-MIN}$  limits the voltage conversion range given a selected switching frequency. The minimum duty cycle allowed is

$$D_{MIN} = T_{ON-MIN} \times F_S \quad (4)$$

And the maximum duty cycle allowed is

$$D_{MAX} = 1 - T_{OFF-MIN} \times F_S \quad (5)$$

Given fixed  $T_{ON-MIN}$  and  $T_{OFF-MIN}$ , the higher the switching frequency the narrower the range of the allowed duty cycle. In the LM43601-Q1, frequency foldback scheme is employed to extend the maximum duty cycle when  $T_{OFF-MIN}$  is reached. The switching frequency decreases once longer duty cycle is needed under low  $V_{IN}$  conditions. The switching frequency can be decreased to approximately 1/10 of the programmed frequency by  $R_T$  or the synchronization clock. Such wide range of frequency foldback allows the LM43601-Q1 output voltage to stay in regulation with a much lower supply voltage  $V_{IN}$ . This leads to a lower effective dropout voltage. See [Typical Characteristics](#) for more details.

Given an output voltage, the choice of the switching frequency affects the allowed input voltage range, solution size and efficiency. The maximum operating supply voltage can be found by

$$V_{IN-MAX} = V_{OUT} / (F_S \times T_{ON-MIN}) \quad (6)$$

At lower supply voltage, the switching frequency decreases once  $T_{OFF-MIN}$  is tripped. The minimum  $V_{IN}$  without frequency foldback can be approximated by

$$V_{IN-MIN} = V_{OUT} / (1 - F_S \times T_{OFF-MIN}) \quad (7)$$

Taking considerations of power losses in the system with heavy load operation,  $V_{IN-MIN}$  is higher than the result calculated in [Equation 7](#). With frequency foldback,  $V_{IN-MIN}$  is lowered by decreased  $F_S$ . [Figure 42](#) gives an example of how  $F_S$  decreases with decreasing supply voltage  $V_{IN}$  at dropout operation.

## Feature Description (continued)

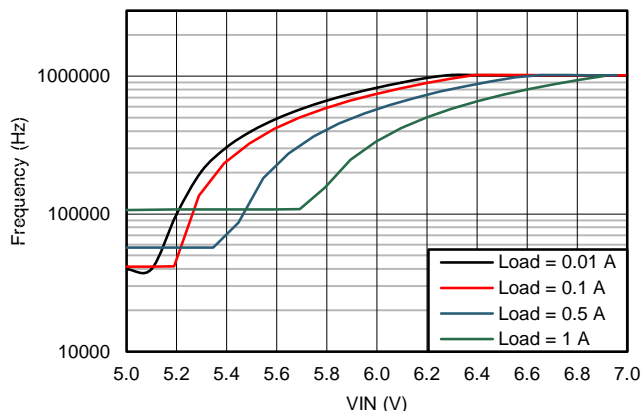

**Figure 42. Switching Frequency Decreases in Dropout Operation**  
 $V_{OUT} = 5\text{ V}$ ,  $F_S = 1\text{ MHz}$

### 7.3.9 Internal Compensation and $C_{FF}$

The LM43601-Q1 is internally compensated with  $R_C = 400\text{ k}\Omega$  and  $C_C = 50\text{ pF}$  as shown in [Functional Block Diagram](#). The internal compensation is designed such that the loop response is stable over the entire operating frequency and output voltage range. Depending on the output voltage, the compensation loop phase margin can be low with all ceramic capacitors. TI recommends an external feed-forward capacitor  $C_{FF}$  be placed in parallel with the top resistor divider  $R_{FBT}$  for optimum transient performance as shown in [Figure 43](#).

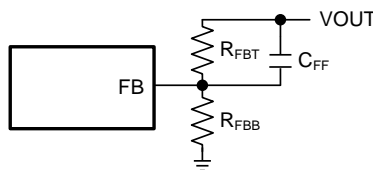

**Figure 43. Feed-Forward Capacitor for Loop Compensation**

The feed-forward capacitor  $C_{FF}$  in parallel with  $R_{FBT}$  places an additional zero before the crossover frequency of the control loop to boost phase margin. The zero frequency can be found by

$$f_{Z-CFF} = 1 / ( 2\pi \times R_{FBT} \times C_{FF} ). \quad (8)$$

An additional pole is also introduced with  $C_{FF}$  at the frequency of

$$f_{P-CFF} = 1 / ( 2\pi \times C_{FF} \times ( R_{FBT} // R_{FBB} ) ). \quad (9)$$

The  $C_{FF}$  should be selected such that the bandwidth of the control loop without the  $C_{FF}$  is centered between  $f_{Z-CFF}$  and  $f_{P-CFF}$ . The zero  $f_{Z-CFF}$  adds phase boost at the crossover frequency and improves transient response. The pole  $f_{P-CFF}$  helps maintaining proper gain margin at frequency beyond the crossover.

Designs with different combinations of output capacitors need different  $C_{FF}$ . Different types of capacitors have different equivalent series resistance (ESR). Ceramic capacitors have the smallest ESR and need the most  $C_{FF}$ . Electrolytic capacitors have much larger ESR and the ESR zero frequency

$$f_{Z-ESR} = 1 / ( 2\pi \times ESR \times C_{OUT} ) \quad (10)$$

would be low enough to boost the phase up around the crossover frequency. Designs using mostly electrolytic capacitors at the output may not need any  $C_{FF}$ .

## Feature Description (continued)

The  $C_{FF}$  creates a time constant with  $R_{FBT}$  that couples in the attenuated output voltage ripple to the FB node. If the  $C_{FF}$  value is too large, it can couple too much ripple to the FB and affect  $V_{OUT}$  regulation. It could also couple too much transient voltage deviation and falsely trip PGOOD thresholds. Therefore,  $C_{FF}$  should be calculated based on output capacitors used in the system. At cold temperatures, the value of  $C_{FF}$  might change based on the tolerance of the chosen component. This may reduce its impedance and ease noise coupling on the FB node. To avoid this, more capacitance can be added to the output or the value of  $C_{FF}$  can be reduced. Please refer to the [Detailed Design Procedure](#) for the calculation of  $C_{FF}$ .

### 7.3.10 Bootstrap Voltage (BOOT)

The driver of the HS switch requires a bias voltage higher than  $V_{IN}$  when the HS switch is ON. The capacitor connected between CBOOT and SW pins works as a charge pump to boost voltage on the CBOOT pin to  $(V_{SW} + V_{CC})$ . The boot diode is integrated on the LM43601-Q1 die to minimize the bill of material (BOM). A synchronous switch is also integrated in parallel with the boot diode to reduce voltage drop on CBOOT. A high-quality ceramic 0.47- $\mu$ F, 6.3-V or higher capacitor is recommended for  $C_{CBOOT}$ .

### 7.3.11 Power Good (PGOOD)

The LM43601-Q1 has a built-in power-good flag shown on PGOOD pin to indicate whether the output voltage is within its regulation level. The PGOOD signal can be used for start-up sequencing of multiple rails or fault protection. The PGOOD pin is an open-drain output that requires a pullup resistor to an appropriate DC voltage. Voltage detected by the PGOOD pin must never exceed 12 V. A resistor divider pair can be used to divide the voltage down from a higher potential. A typical range of pullup resistor value is 10 k $\Omega$  to 100 k $\Omega$ .

When the FB voltage is within the power-good band, +4% above and –7% below the internal reference  $V_{REF}$  typically, the PGOOD switch is turned off and the PGOOD voltage is pulled up to the voltage level defined by the pullup resistor or divider. When the FB voltage is outside of the tolerance band, +10 % above or –10 % below  $V_{REF}$  typically, the PGOOD switch is turned on and the PGOOD pin voltage is pulled low to indicate power bad. Both rising and falling edges of the power-good flag have a built-in 220- $\mu$ s (typical) deglitch delay.

### 7.3.12 Overcurrent and Short-Circuit Protection

The LM43601-Q1 is protected from overcurrent conditions by cycle-by-cycle current limiting on both peak and valley of the inductor current. Hiccup mode is activated to prevent over heating if a fault condition persists.

High-side MOSFET over-current protection is implemented by the nature of the peak current mode control. The HS switch current is sensed when the HS is turned on after a set blanking time. The HS switch current is compared to the output of the error amplifier (EA) minus slope compensation every switching cycle. See [Functional Block Diagram](#) for more details. The peak current of the HS switch is limited by the maximum EA output voltage minus the slope compensation at every switching cycle. The slope compensation magnitude at the peak current is proportional to the duty cycle.

When the LS switch is turned on, the current going through it is also sensed and monitored. The LS switch is not turned OFF at the end of a switching cycle if its current is above the LS current limit  $I_{LS-LIMIT}$ . The LS switch is kept ON so that inductor current keeps ramping down, until the inductor current ramps below  $I_{LS-LIMIT}$ . Then the LS switch is turned OFF and the HS switch is turned on after a dead time. If the current of the LS switch is higher than the LS current limit for 32 consecutive cycles and the power-good flag is low, hiccup current protection mode will be activated. In hiccup mode, the regulator is shut down and kept off for 5.5 ms typically before the LM43601-Q1 tries to start again. If overcurrent or short-circuit fault condition still exist, hiccup will repeat until the fault condition is removed. Hiccup mode reduces power dissipation under severe overcurrent conditions, prevents over heating and potential damage to the device.

Hiccup is only activated when power-good flag is low. Under non-severe overcurrent conditions when  $V_{OUT}$  has not fallen outside of the PGOOD tolerance band, the LM43601-Q1 reduces the switching frequency and keep the inductor current valley clamped at the LS current limit level. This operation mode allows slight over current operation during load transients without tripping hiccup. If the power-good flag becomes low, hiccup operation starts after LS current limit is tripped 32 consecutive cycles.

## Feature Description (continued)

### 7.3.13 Thermal Shutdown

Thermal shutdown is a built-in self protection to limit junction temperature and prevent damages due to over heating. Thermal shutdown turns off the device when the junction temperature exceeds 160°C typically to prevent further power dissipation and temperature rise. Junction temperature will reduce after thermal shutdown. The LM43601-Q1 attempts to restart when the junction temperature drops to 150°C.

## 7.4 Device Functional Modes

### 7.4.1 Shutdown Mode

The EN pin provides electrical ON and OFF control for the LM43601-Q1. When  $V_{EN}$  is below 0.4 V, the device is in shutdown mode. Both the internal LDO and the switching regulator are off. In shutdown mode the quiescent current drops to 1  $\mu$ A typically with  $V_{IN} = 12$  V. The LM43601-Q1 also employs under voltage lock out protection. If  $V_{CC}$  voltage is below the UVLO level, the output of the regulator is turned off.

### 7.4.2 Standby Mode

The internal LDO has a lower enable threshold than the regulator. When  $V_{EN}$  is above 1.2 V and below the precision enable falling threshold (1.8 V typically), the internal LDO regulates the  $V_{CC}$  voltage at 3.2 V. The precision enable circuitry is turned on once  $V_{CC}$  is above the UVLO threshold. The switching action and voltage regulation are not enabled unless  $V_{EN}$  rises above the precision enable threshold (2.1 V typically).

### 7.4.3 Active Mode

The LM43601-Q1 is in active mode when  $V_{EN}$  is above the precision enable threshold and  $V_{CC}$  is above its UVLO level. The simplest way to enable the LM43601-Q1 is to connect the EN pin to  $V_{IN}$ . This allows self start-up when the input voltage is in the operation range: 3.5 V to 36 V. See [ENABLE Pin](#) and [VCC, UVLO and BIAS](#) for details on setting these operating levels.

In Active Mode, depending on the load current, the LM43601-Q1 is in one of four modes:

1. Continuous conduction mode (CCM) with fixed switching frequency when load current is above half of the peak-to-peak inductor current ripple;
2. Discontinuous conduction mode (DCM) with fixed switching frequency when load current is lower than half of the peak-to-peak inductor current ripple in CCM operation;
3. Pulse frequency modulation (PFM) when switching frequency is decreased at very light load;
4. Foldback mode when switching frequency is decreased to maintain output regulation at lower supply voltage  $V_{IN}$ .

### 7.4.4 CCM Mode

CCM operation is employed in the LM43601-Q1 when the load current is higher than half of the peak-to-peak inductor current. In CCM operation, the frequency of operation is fixed unless the the minimum HS switch ON-time ( $T_{ON\_MIN}$ ), the minimum HS switch OFF-time ( $T_{OFF\_MIN}$ ) or LS current limit is exceeded. Output voltage ripple is at a minimum in this mode and the maximum output current of 1 A can be supplied by the LM43601-Q1

### 7.4.5 Light Load Operation

When the load current is lower than half of the peak-to-peak inductor current in CCM, the LM43601-Q1 operates in DCM, also known as Diode Emulation Mode (DEM). In DCM operation, the LS FET is turned off when the inductor current drops to 0 A to improve efficiency. Both switching losses and conduction losses are reduced in DCM, comparing to forced PWM operation at light load.

At even lighter current loads, PFM is activated to maintain high efficiency operation. When the HS switch ON-time reduces to  $T_{ON\_MIN}$  or peak inductor current reduces to its minimum  $I_{PEAK\_MIN}$ , the switching frequency is reduced to maintain proper regulation. Efficiency is greatly improved by reducing switching and gate drive losses.

## Device Functional Modes (continued)

### 7.4.6 Self-Bias Mode

For highest efficiency of operation, TI recommends that the BIAS pin be connected directly to  $V_{OUT}$  when  $V_{OUT} \geq 3.3$  V. In this self-bias mode of operation, the difference between the input and output voltages of the internal LDO are reduced and therefore the total efficiency is improved. These efficiency gains are more evident during light load operation. During this mode of operation, the LM43601-Q1 operates with a minimum quiescent current of 36  $\mu$ A (typical). See [VCC](#), [UVLO](#) and [BIAS](#) for more details.

## 8 Applications and Implementation

### NOTE

Information in the following applications sections is not part of the TI component specification, and TI does not warrant its accuracy or completeness. TI's customers are responsible for determining suitability of components for their purposes. Customers should validate and test their design implementation to confirm system functionality.

### 8.1 Application Information

The LM43601-Q1 is a step down DC-to-DC regulator. It is typically used to convert a higher DC voltage to a lower DC voltage with a maximum output current of 1 A. The following design procedure can be used to select components for the LM43601-Q1. Alternately, the WEBENCH<sup>®</sup> software may be used to generate complete designs. When generating a design, the WEBENCH<sup>®</sup> software utilizes iterative design procedure and accesses comprehensive databases of components. See [Custom Design With WEBENCH<sup>®</sup> Tools](#) for more details.

### 8.2 Typical Applications

The LM43601-Q1 only requires a few external components to convert from a wide range of supply voltage to output voltage. [Figure 44](#) shows a basic schematic when BIAS is connected to  $V_{OUT}$ . This is recommended for  $V_{OUT} \geq 3.3$  V. For  $V_{OUT} < 3.3$  V, connect BIAS to ground, as shown in [Figure 45](#).

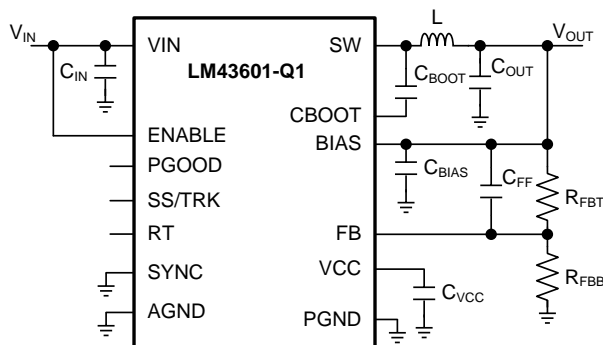

**Figure 44. LM43601-Q1 Basic Schematic for  $V_{OUT} \geq 3.3$  V, Tie BIAS to  $V_{OUT}$**

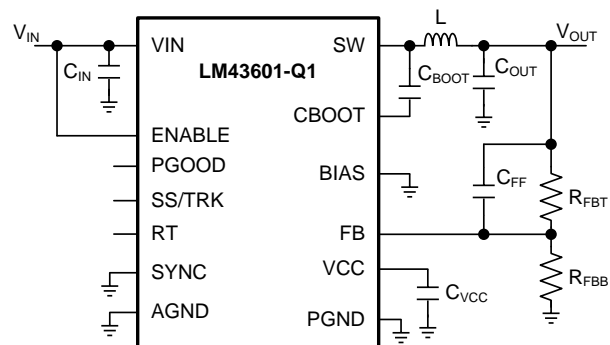

**Figure 45. LM43601-Q1 Basic Schematic for  $V_{OUT} < 3.3$  V, Tie BIAS to Ground**

The LM43601-Q1 also integrates a full list of optional features to aid system design requirements, such as precision enable,  $V_{CC}$  UVLO, programmable soft start, output voltage tracking, programmable switching frequency, clock synchronization and power-good indication. Each application can select the features for a more comprehensive design. A schematic with all features utilized is shown in [Figure 46](#).

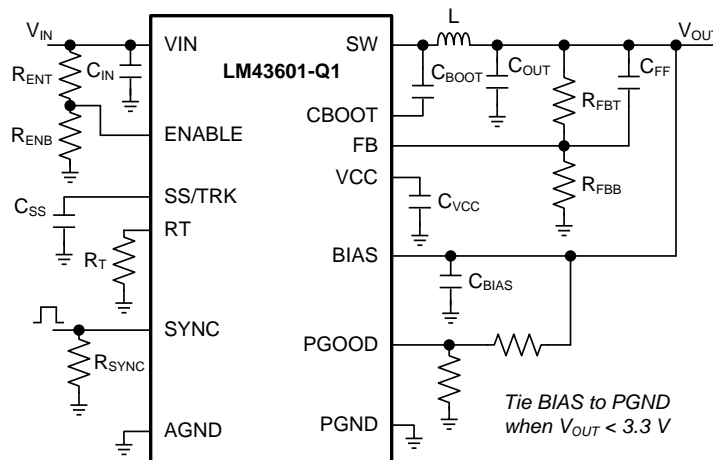

**Typical Applications (continued)**

**Figure 46. LM43601-Q1 Schematic with All Features**

The external components must be chosen for the application, but also the stability criteria of the device control loop. The LM43601-Q1 is optimized to work within a range of external components. The inductance and capacitance of the LC output filter must be considered in conjunction, creating a double pole, responsible for the corner frequency of the converter. [Table 2](#) can be used to simplify the output filter component selection.

**Table 2. L, C<sub>OUT</sub>, and C<sub>FF</sub> Typical Values**

F <sub>S</sub> (kHz)	L (μH)	C <sub>OUT</sub> (μF) <sup>(1)</sup>	C <sub>FF</sub> (pF) <sup>(2)(3)</sup>	R <sub>T</sub> (kΩ)	R <sub>FBB</sub> (kΩ) <sup>(2)(3)</sup>
<b>V<sub>OUT</sub> = 1 V</b>					
200	18	500	none	200	100
500	6.8	330	none	80.6 or open	100
1000	3.3	180	none	39.2	100
2200	1.5	100	none	17.8	100
<b>V<sub>OUT</sub> = 3.3 V</b>					
200	47	220	44	200	442
500	18	100	33	80.6 or open	442
1000	10	47	18	39.2	442
2200	4.7	27	12	17.8	442
<b>V<sub>OUT</sub> = 5 V</b>					
200	56	150	68	200	255
500	27	66	33	80.6 or open	255
1000	15	33	22	39.2	255
2200	6.8	22	18	17.8	255
<b>V<sub>OUT</sub> = 12 V</b>					
200	100	33	see note <sup>(4)</sup>	200	90.9
500	47	22	47	80.6 or open	90.9
1000	22	15	33	39.2	90.9

- (1) All the C<sub>OUT</sub> values are after derating. Add more when using ceramics
- (2) R<sub>FBT</sub> = 0 Ω for V<sub>OUT</sub> = 1 V. R<sub>FBT</sub> = 1 MΩ for all other V<sub>OUT</sub> settings.
- (3) For designs with R<sub>FBT</sub> other than 1 MΩ, adjust C<sub>FF</sub> such that (C<sub>FF</sub> × R<sub>FBT</sub>) is unchanged and adjust R<sub>FBB</sub> such that (R<sub>FBT</sub> / R<sub>FBB</sub>) is unchanged.
- (4) High ESR C<sub>OUT</sub> gives enough phase boost, and C<sub>FF</sub> not needed.

## Typical Applications (continued)

### 8.2.1 Design Requirements

A detailed design procedure is described based on a design example. For this design example, use the parameters listed in [Table 3](#) as the input parameters.

**Table 3. Design Example Parameters**

DESIGN PARAMETER	VALUE
Input voltage $V_{IN}$	12 V typical, range from 3.8 V to 36 V
Output voltage $V_{OUT}$	3.3 V
Input ripple voltage	400 mV
Output ripple voltage	30 mV
Output current rating	1 A
Operating frequency	500 kHz
Soft-start time	10 ms

### 8.2.2 Detailed Design Procedure

#### 8.2.2.1 Custom Design With WEBENCH® Tools

[Click here](#) to create a custom design using the LM43601-Q1 device with the WEBENCH® Power Designer.

1. Start by entering the input voltage ( $V_{IN}$ ), output voltage ( $V_{OUT}$ ), and output current ( $I_{OUT}$ ) requirements.
2. Optimize the design for key parameters such as efficiency, footprint, and cost using the optimizer dial.
3. Compare the generated design with other possible solutions from Texas Instruments.

The WEBENCH Power Designer provides a customized schematic along with a list of materials with real-time pricing and component availability.

In most cases, these actions are available:

- Run electrical simulations to see important waveforms and circuit performance
- Run thermal simulations to understand board thermal performance
- Export customized schematic and layout into popular CAD formats
- Print PDF reports for the design, and share the design with colleagues

Get more information about WEBENCH tools at [www.ti.com/WEBENCH](http://www.ti.com/WEBENCH).

#### 8.2.2.2 Output Voltage Set-Point

The output voltage of the LM43601-Q1 device is externally adjustable using a resistor divider network. The divider network is comprised of top feedback resistor  $R_{FBT}$  and bottom feedback resistor  $R_{FBB}$ . [Equation 11](#) is used to determine the output voltage of the converter:

$$R_{FBB} = \frac{V_{FB}}{V_{OUT} - V_{FB}} R_{FBT} \quad (11)$$

Choose the value of the  $R_{FBT}$  to be 1 M $\Omega$  to minimize quiescent current to improve light load efficiency in this application. With the desired output voltage set to be 3.3 V and the  $V_{FB} = 1.016$  V, the  $R_{FBB}$  value can then be calculated using [Equation 11](#). The formula yields a value of 444.83 k $\Omega$ . Choose the closest available value of 442 k $\Omega$  for the  $R_{FBB}$ . See [Adjustable Output Voltage](#) for more details.

#### 8.2.2.3 Switching Frequency

The default switching frequency of the LM43601-Q1 device is set at 500 kHz when RT pin is open circuit. The switching frequency is selected to be 500 kHz in this application for one less passive components. If other frequency is desired, use [Equation 12](#) to calculate the required value for  $R_T$ .

$$R_T(\text{k}\Omega) = 40200 / \text{Freq (kHz)} - 0.6 \quad (12)$$

For 500 kHz, the calculated  $R_T$  is 79.8 k $\Omega$  and standard value 80.6 k $\Omega$  can also be used to set the switching frequency at 500 kHz.

### 8.2.2.4 Input Capacitors

The LM43601-Q1 device requires high frequency input decoupling capacitor(s) and a bulk input capacitor, depending on the application. The typical recommended value for the high frequency decoupling capacitor is 4.7  $\mu\text{F}$  to 10  $\mu\text{F}$ . A high-quality ceramic type X5R or X7R with sufficiency voltage rating is recommended. The voltage rating must be greater than the maximum input voltage. To compensate the derating of ceramic capacitors, a voltage rating of twice the maximum input voltage is recommended. Additionally, some bulk capacitance can be required, especially if the LM43601-Q1 circuit is not located within approximately 5 cm from the input voltage source. This capacitor is used to provide damping to the voltage spiking due to the lead inductance of the cable or trace. The value for this capacitor is not critical but must be rated to handle the maximum input voltage including ripple. For this design, a 10  $\mu\text{F}$ , X7R dielectric capacitor rated for 100 V is used for the input decoupling capacitor. The equivalent series resistance (ESR) is approximately 3  $\text{m}\Omega$ , and the current rating is 3 A. Include a capacitor with a value of 0.1  $\mu\text{F}$  for high-frequency filtering and place it as close as possible to the device pins.

#### NOTE

DC Bias effect: High capacitance ceramic capacitors have a DC Bias effect, which will have a strong influence on the final effective capacitance. Therefore the right capacitor value has to be chosen carefully. Package size and voltage rating in combination with dielectric material are responsible for differences between the rated capacitor value and the effective capacitance.

### 8.2.2.5 Inductor Selection

The first criterion for selecting an output inductor is the inductance itself. In most buck converters, this value is based on the desired peak-to-peak ripple current,  $\Delta i_L$ , that flows in the inductor along with the DC load current. As with switching frequency, the selection of the inductor is a tradeoff between size and cost. Higher inductance gives lower ripple current and hence lower output voltage ripple with the same output capacitors. Lower inductance could result in smaller, less expensive component. An inductance that gives a ripple current of 20% to 40% of the 1 A at the typical supply voltage is a good starting point.  $\Delta i_L = (1/5 \text{ to } 2/5) \times I_{\text{OUT}}$ . The peak-to-peak inductor current ripple can be found by [Equation 13](#) and the range of inductance can be found by [Equation 14](#) with the typical input voltage used as  $V_{\text{IN}}$ .

$$\Delta i_L = \frac{(V_{\text{IN}} - V_{\text{OUT}}) \times D}{L \times F_S} \quad (13)$$

$$\frac{(V_{\text{IN}} - V_{\text{OUT}}) \times D}{0.4 \times F_S \times I_{\text{L-MAX}}} \leq L \leq \frac{(V_{\text{IN}} - V_{\text{OUT}}) \times D}{0.2 \times F_S \times I_{\text{L-MAX}}} \quad (14)$$

D is the duty cycle of the converter which in a buck converter it can be approximated as  $D = V_{\text{OUT}} / V_{\text{IN}}$ , assuming no loss power conversion. By calculating in terms of amperes, volts, and megahertz, the inductance value will come out in micro Henries. The inductor ripple current ratio is defined by:

$$r = \frac{\Delta i_L}{I_{\text{OUT}}} \quad (15)$$

The second criterion is the inductor saturation current rating. The inductor should be rated to handle the maximum load current plus the ripple current:

$$I_{\text{L-PEAK}} = I_{\text{LOAD-MAX}} + \Delta i_L \quad (16)$$

The LM43601-Q1 has both valley current limit and peak current limit. During an instantaneous short, the peak inductor current can be high due to a momentary increase in duty cycle. The inductor current rating should be higher than the HS current limit. It is advised to select an inductor with a larger core saturation margin and preferably a softer roll off of the inductance value over load current.

In general, choosing lower inductance in switching power supplies is preferred because it usually corresponds to faster transient response, smaller DCR, and reduced size for more compact designs. But too low of an inductance can generate too large of an inductor current ripple such that overcurrent protection at the full load could be falsely triggered. It also generates more conduction loss, because the RMS current is slightly higher relative that with lower current ripple at the same DC current. Larger inductor current ripple also implies larger output voltage ripple with the same output capacitors. With peak current mode control, it is not recommended to have too small of an inductor current ripple. Enough inductor current ripple improves signal-to-noise ratio on the current comparator and makes the control loop more immune to noise.

Once the inductance is determined, the type of inductor must be selected. Ferrite designs have very low core losses and are preferred at high switching frequencies, so design goals can concentrate on copper loss and preventing saturation. Ferrite core material saturates hard, which means that inductance collapses abruptly when the peak design current is exceeded. The 'hard' saturation results in an abrupt increase in inductor ripple current and consequent output voltage ripple. Do not allow the core to saturate!

For the design example, a standard 18- $\mu$ H inductor from Würth, Coiltronics, or Vishay can be used for the 3.3-V output with plenty of current rating margin.

### 8.2.2.6 Output Capacitor Selection

The device is designed to be used with a wide variety of LC filters. It is generally desired to use as little output capacitance as possible to keep cost and size down. The output capacitor (s),  $C_{OUT}$ , should be chosen with care since it directly affects the steady state output voltage ripple, loop stability and the voltage over/undershoot during load current transients.

The output voltage ripple is essentially composed of two parts. One is caused by the inductor current ripple going through the ESR of the output capacitors:

$$\Delta V_{OUT-ESR} = \Delta i_L \times ESR \quad (17)$$

The other is caused by the inductor current ripple charging and discharging the output capacitors:

$$\Delta V_{OUT-C} = \Delta i_L / (8 \times F_S \times C_{OUT}) \quad (18)$$

The two components in the voltage ripple are not in phase, so the actual peak-to-peak ripple is smaller than the sum of the two peaks.

Output capacitance is usually limited by transient performance specifications if the system requires tight voltage regulation in the presence of large current steps and fast slew rates. When a fast large load transient happens, output capacitors provide the required charge before the inductor current can slew to the appropriate level. The initial output voltage step is equal to the load current step multiplied by the ESR.  $V_{OUT}$  continues to droop until the control loop response increases or decreases the inductor current to supply the load. To maintain a small over- or under-shoot during a transient, small ESR and large capacitance are desired. But these also come with higher cost and size. Thus, the motivation is to seek a fast control loop response to reduce the output voltage deviation.

For a given input and output requirement, the following inequality gives an approximation for an absolute minimum output cap required:

$$C_{OUT} > \frac{1}{(F_S \times r \times \Delta V_{OUT} / I_{OUT})} \times \left[ \left( \frac{r^2}{12} \times (1 + D') \right) + (D' \times (1 + r)) \right] \quad (19)$$

Along with this for the same requirement, calculate the maximum ESR with [Equation 20](#):

$$ESR < \frac{D'}{F_S \times C_{OUT}} \times \left( \frac{1}{r} + 0.5 \right)$$

where

- $r$  = Ripple ratio of the inductor ripple current ( $\Delta i_L / I_{OUT}$ )
- $\Delta V_{OUT}$  = Target output voltage undershoot
- $D'$  =  $1 -$  Duty cycle
- $F_S$  = Switching Frequency
- $I_{OUT}$  = Load Current

(20)

A general guideline for  $C_{OUT}$  range is that  $C_{OUT}$  should be larger than the minimum required output capacitance calculated by [Equation 19](#), and smaller than 10 times the minimum required output capacitance or 1 mF. In applications with  $V_{OUT}$  less than 3.3 V, it is critical that low ESR output capacitors are selected. This will limit potential output voltage overshoots as the input voltage falls below the device normal operating range. To optimize the transient behavior a feed-forward capacitor could be added in parallel with the upper feedback resistor. For this design example, two 47- $\mu$ F, 10-V, X7R ceramic capacitors are used in parallel.

### 8.2.2.7 Feed-Forward Capacitor

The LM43601-Q1 is internally compensated and the internal R-C values are 400 k $\Omega$  and 50 pF, respectively. Depending on the  $V_{OUT}$  and frequency  $F_S$ , if the output capacitor  $C_{OUT}$  is dominated by low ESR (ceramic types) capacitors, it could result in low phase margin. To improve the phase boost an external feedforward capacitor  $C_{FF}$  can be added in parallel with  $R_{FBT}$ .  $C_{FF}$  is chosen such that phase margin is boosted at the crossover frequency without  $C_{FF}$ . A simple estimation for the crossover frequency without  $C_{FF}$  ( $f_x$ ) is shown in [Equation 21](#), assuming  $C_{OUT}$  has very small ESR.

$$f_x = \frac{2.73}{V_{OUT} \times C_{OUT}} \quad (21)$$

[Equation 22](#) was tested for  $C_{FF}$ :

$$C_{FF} = \frac{1}{2\pi f_x} \times \frac{1}{\sqrt{R_{FBT} \times (R_{FBT} / R_{FBB})}} \quad (22)$$

[Equation 22](#) indicates that the crossover frequency is geometrically centered on the zero and pole frequencies caused by the  $C_{FF}$  capacitor.

For designs with higher ESR,  $C_{FF}$  is not needed when  $C_{OUT}$  has very high ESR and  $C_{FF}$  calculated from [Equation 22](#) should be reduced with medium ESR. [Table 2](#) can be used as a quick starting point.

For the application in this design example, a 33-pF COG capacitor is selected.

### 8.2.2.8 Bootstrap Capacitors

Every LM43601-Q1 design requires a bootstrap capacitor,  $C_{CBOOT}$ . The recommended bootstrap capacitor is 0.47  $\mu$ F and rated at 6.3 V or higher. The bootstrap capacitor is located between the SW pin and the CBOOT pin. The bootstrap capacitor must be a high-quality ceramic type with X7R or X5R grade dielectric for temperature stability.

### 8.2.2.9 VCC Capacitor

The VCC pin is the output of an internal LDO for LM43601-Q1. The input for this LDO comes from either VIN or BIAS (see [Functional Block Diagram](#) for LM43601-Q1). To insure stability of the part, place a minimum of 2.2- $\mu$ F, 10-V capacitor from this pin to ground.

### 8.2.2.10 BIAS Capacitors

For an output voltage of 3.3 V and greater, the BIAS pin can be connected to the output in order to increase light load efficiency. This pin is an input for the VCC LDO. When BIAS is not connected, the input for the VCC LDO is internally connected into VIN. Since this is an LDO, the voltage differences between the input and output affects the efficiency of the LDO. If necessary, a capacitor with a value of 1  $\mu$ F can be added close to the BIAS pin as an input capacitor for the LDO.

### 8.2.2.11 Soft-Start Capacitors

The user can leave the SS/TRK pin floating and the LM43601-Q1 implements a soft-start time of 4.1 ms typically. In order to use an external soft-start capacitor, the capacitor must be sized such that the soft-start time is longer than 4.1 ms. Use [Equation 23](#) to calculate the soft-start capacitor value:

$$C_{SS} = I_{SS} \times t_{SS}$$

where

- $C_{SS}$  = soft-start capacitor value ( $\mu$ F)
- $I_{SS}$  = soft-start charging current ( $\mu$ A)

- $t_{SS}$  = desired soft start time (s) (23)

For the desired soft-start time of 10 ms and soft start charging current of 2.2  $\mu$ A, [Equation 23](#) yields a soft-start capacitor value of 0.022  $\mu$ F.

### 8.2.2.12 Undervoltage Lockout Setpoint

The undervoltage lockout (UVLO) is adjusted using the external voltage divider network of  $R_{ENT}$  and  $R_{ENB}$ .  $R_{ENT}$  is connected between VIN and the EN pins of the LM43601-Q1 device.  $R_{ENB}$  is connected between the EN pin and the GND pin. The UVLO has two thresholds, one for power up when the input voltage is rising and one for powerdown or brownouts when the input voltage is falling. [Equation 24](#) can be used to determine the VIN (UVLO) level.

$$V_{IN-UVLO-RISING} = V_{ENH} \times (R_{ENB} + R_{ENT}) / R_{ENB} \quad (24)$$

The EN rising threshold for LM43601-Q1 is set to be 2.1 V. Choose the value of  $R_{ENB}$  to be 1 M $\Omega$  to minimize input current going into the converter. If the desired VIN (UVLO) level is at 5 V, then the value of  $R_{ENT}$  can be calculated using [Equation 25](#):

$$R_{ENT} = (V_{IN-UVLO-RISING} / V_{ENH} \times 1) \times R_{ENB} \quad (25)$$

The above equation yields a value of 1.37 M $\Omega$ . The resulting falling UVLO threshold can be calculated as follows:

$$V_{IN-UVLO-FALLING} = 1.8 \times (R_{ENB} + R_{ENT}) / R_{ENB} \quad (26)$$

### 8.2.2.13 PGOOD

A typical pullup resistor value is 10 k $\Omega$  to 100 k $\Omega$  from the PGOOD pin to a voltage no higher than 12 V. If it is desired to pull up the PGOOD pin to a voltage higher than 12 V, a resistor can be added from the PGOOD pin to ground to divide the voltage seen by the PGOOD pin to a value no higher than 12 V.

### 8.2.3 Application Performance Curves

See Table 2 for bill of materials for each  $V_{OUT}$  and  $F_S$  combination. Unless otherwise stated, application performance curves were taken at  $T_A = 25^\circ\text{C}$ .

$V_{OUT} = 1\text{ V}$   $F_S = 500\text{ kHz}$

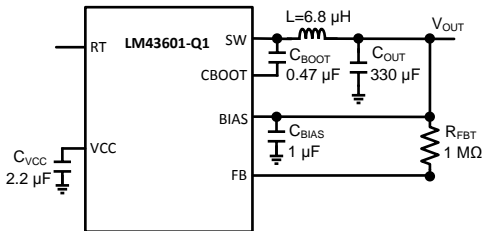

$V_{OUT} = 1\text{ V}$   $F_S = 500\text{ kHz}$   $V_{IN} = 12\text{ V}$

Figure 47. BOM for  $V_{OUT} = 1\text{ V}$   $F_S = 500\text{ kHz}$

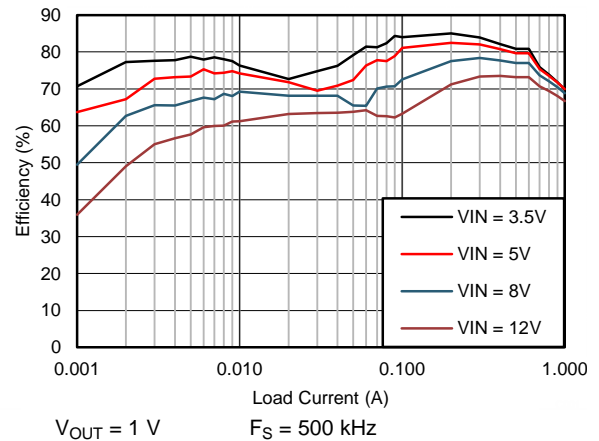
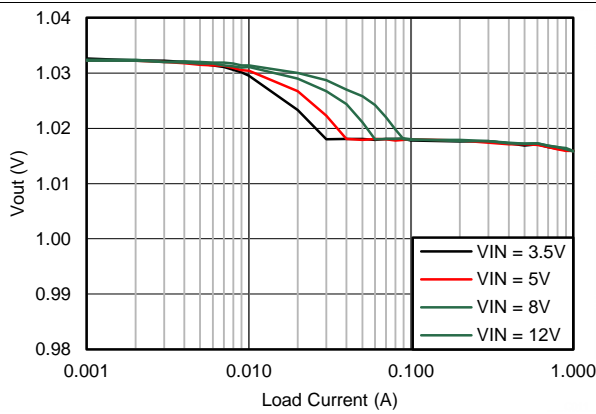
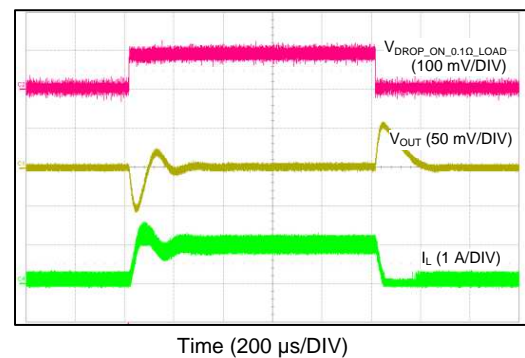

Figure 48. Efficiency



$V_{OUT} = 1\text{ V}$   $F_S = 500\text{ kHz}$

Figure 49. Output Voltage Regulation



$V_{OUT} = 1\text{ V}$   $F_S = 500\text{ kHz}$   $V_{IN} = 12\text{ V}$

Figure 50. Load Transient Between 0.05 A and 1 A

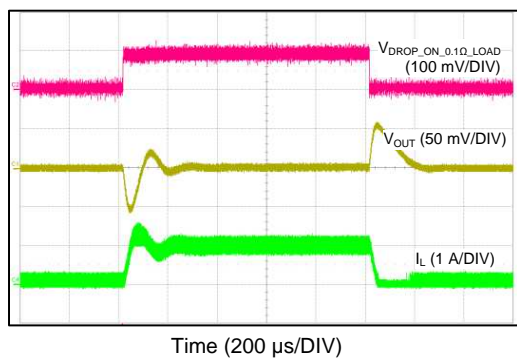

$V_{OUT} = 1\text{ V}$   $F_S = 500\text{ kHz}$   $V_{IN} = 12\text{ V}$

Figure 51. Load Transient Between 0.1 A and 1 A

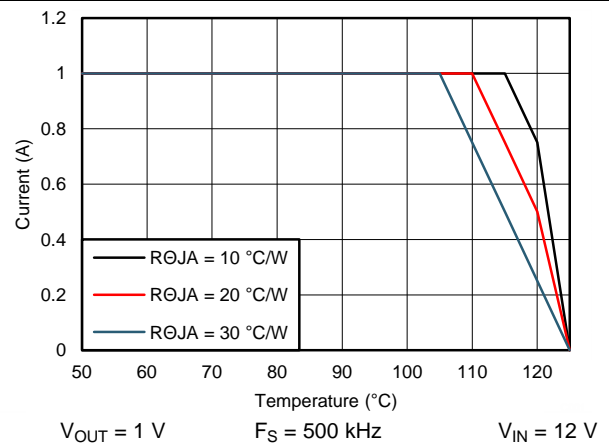

$V_{OUT} = 1\text{ V}$   $F_S = 500\text{ kHz}$   $V_{IN} = 12\text{ V}$

Figure 52. Derating Curve

# LM43601-Q1

SNVSA00B – JULY 2015 – REVISED NOVEMBER 2017

www.ti.com

See [Table 2](#) for bill of materials for each  $V_{OUT}$  and  $F_S$  combination. Unless otherwise stated, application performance curves were taken at  $T_A = 25^\circ\text{C}$ .

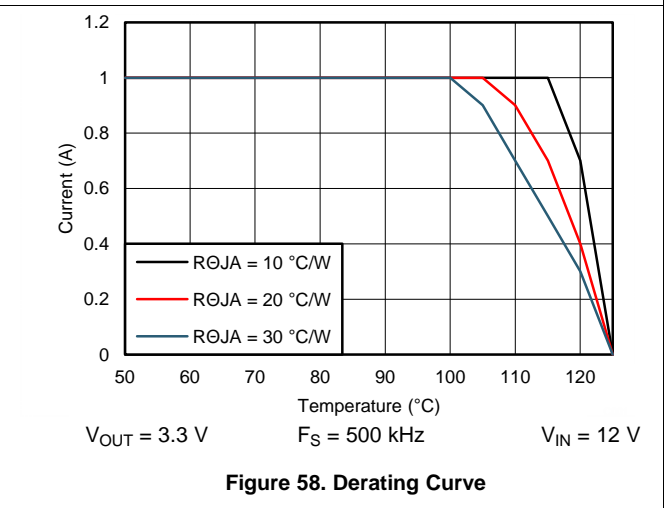
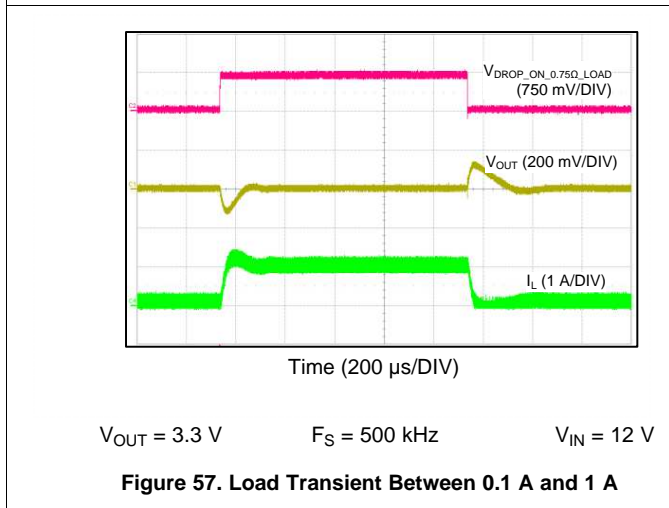
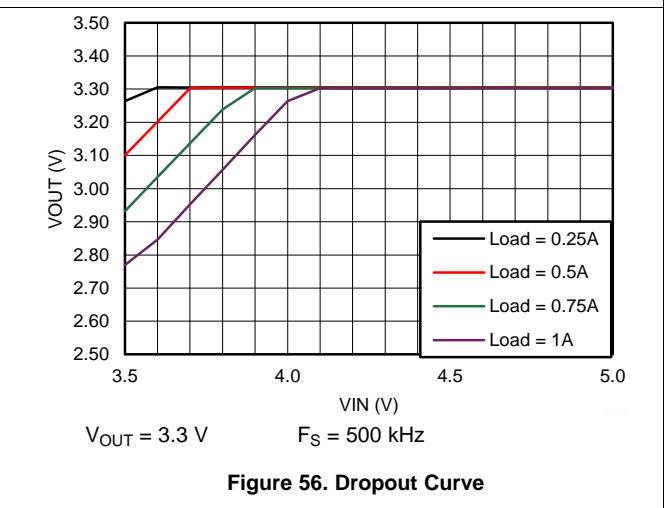
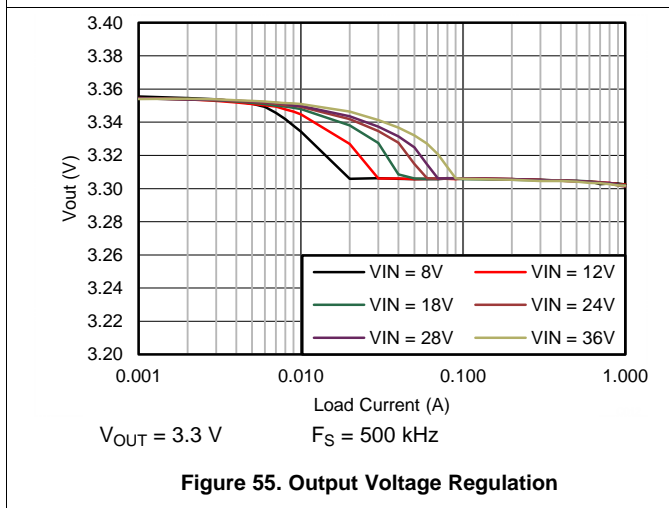
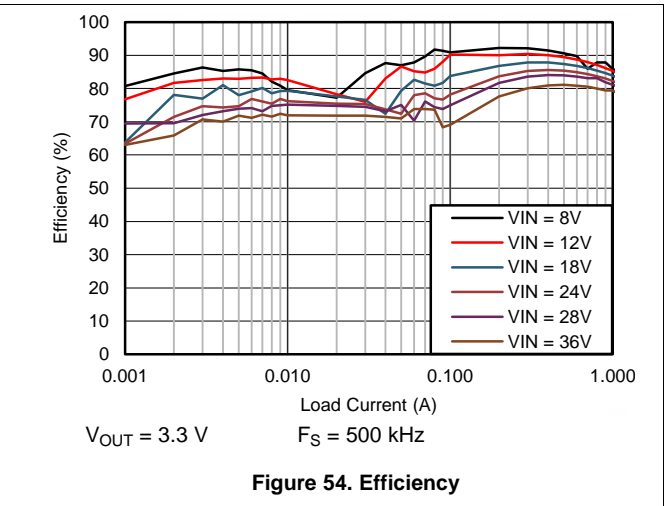
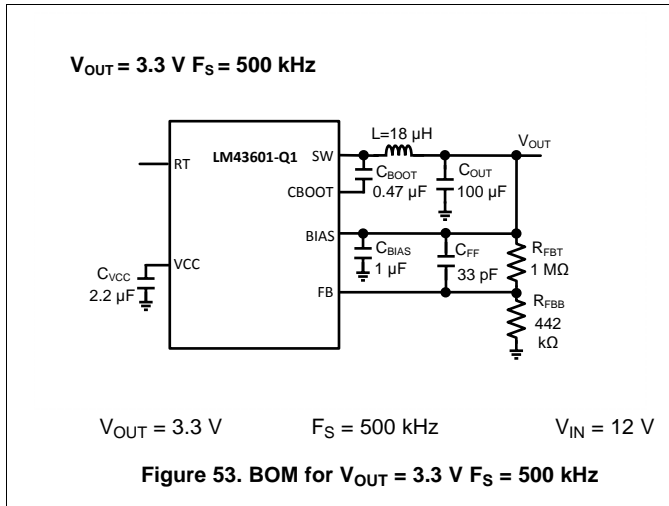



See Table 2 for bill of materials for each  $V_{OUT}$  and  $F_S$  combination. Unless otherwise stated, application performance curves were taken at  $T_A = 25^\circ\text{C}$ .

$V_{OUT} = 5\text{ V}$   $F_S = 500\text{ kHz}$

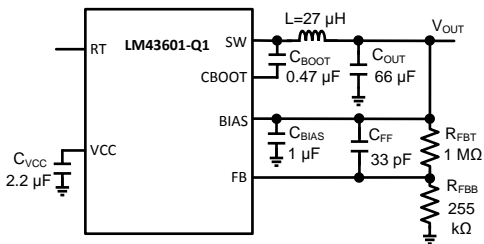

$V_{OUT} = 5\text{ V}$   $F_S = 500\text{ kHz}$   $V_{IN} = 12\text{ V}$

Figure 59. BOM for  $V_{OUT} = 5\text{ V}$   $F_S = 500\text{ kHz}$

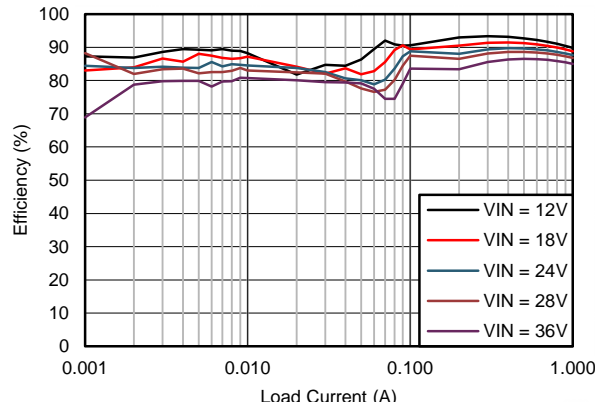

$V_{OUT} = 5\text{ V}$   $F_S = 500\text{ kHz}$

Figure 60. Efficiency

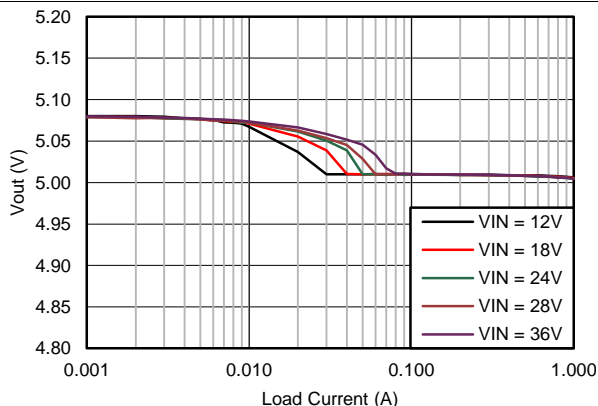

$V_{OUT} = 5\text{ V}$   $F_S = 500\text{ kHz}$

Figure 61. Output Voltage Regulation

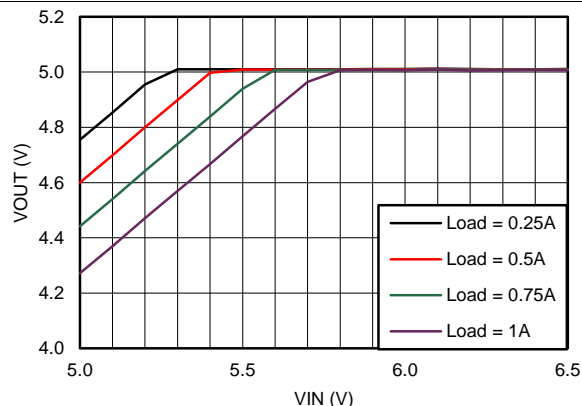

$V_{OUT} = 5\text{ V}$   $F_S = 500\text{ kHz}$

Figure 62. Dropout Curve

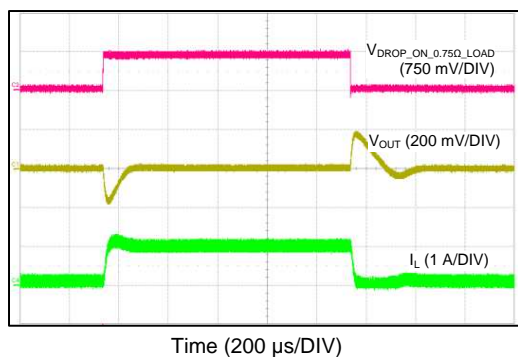

$V_{OUT} = 5\text{ V}$   $F_S = 500\text{ kHz}$   $V_{IN} = 12\text{ V}$

Figure 63. Load Transient Between 0.1 A and 1 A

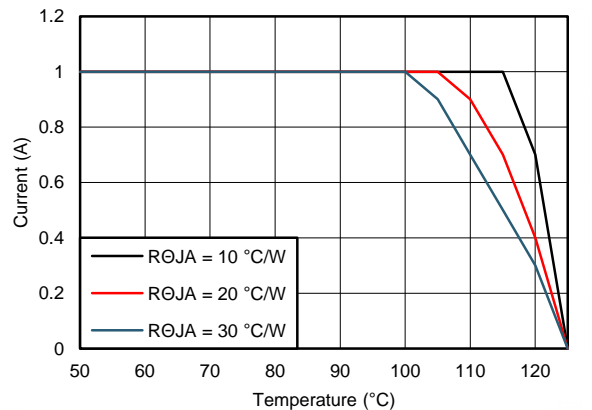

$V_{OUT} = 5\text{ V}$   $F_S = 500\text{ kHz}$   $V_{IN} = 12\text{ V}$

Figure 64. Derating Curve

LM43601-Q1

SNVSA00B – JULY 2015 – REVISED NOVEMBER 2017

www.ti.com

See Table 2 for bill of materials for each  $V_{OUT}$  and  $F_S$  combination. Unless otherwise stated, application performance curves were taken at  $T_A = 25^\circ\text{C}$ .

$V_{OUT} = 5\text{ V}$   $F_S = 200\text{ kHz}$

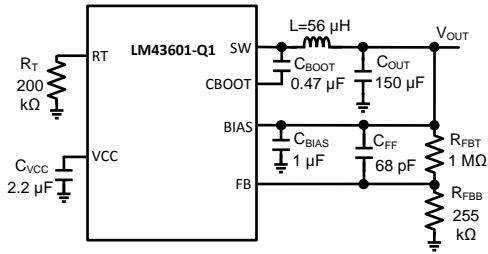

$V_{OUT} = 5\text{ V}$   $F_S = 200\text{ kHz}$   $V_{IN} = 12\text{ V}$

Figure 65. BOM for  $V_{OUT} = 5\text{ V}$   $F_S = 200\text{ kHz}$

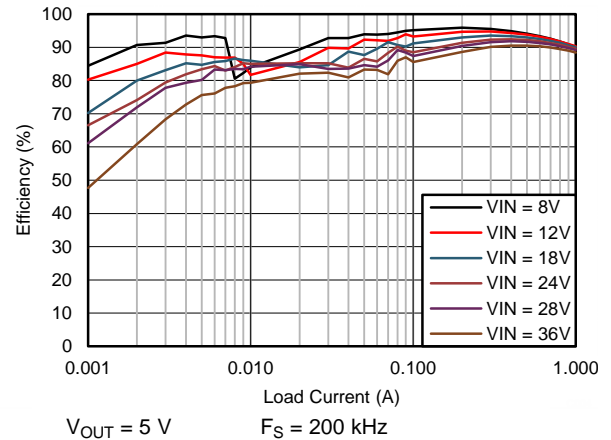

Figure 66. Efficiency

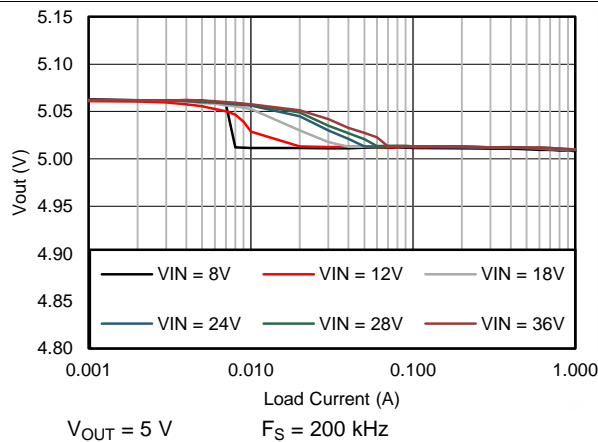

Figure 67. Output Voltage Regulation

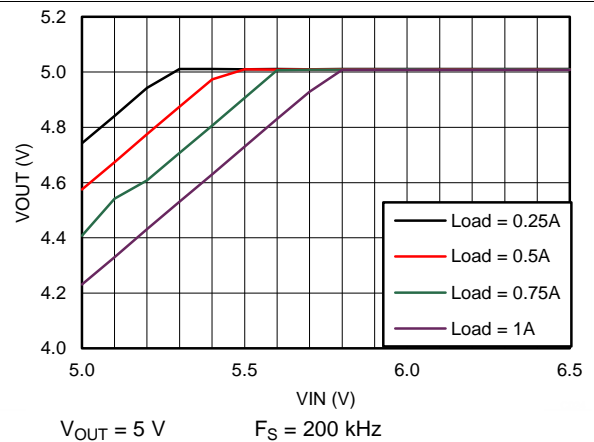
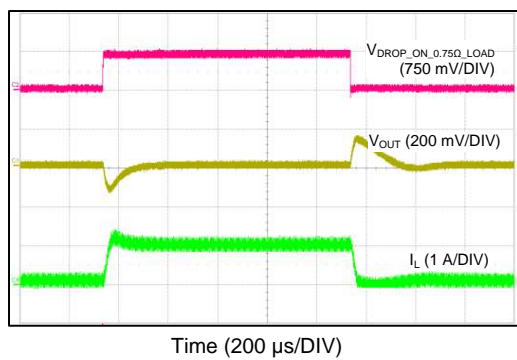

Figure 68. Dropout Curve



$V_{OUT} = 5\text{ V}$   $F_S = 200\text{ kHz}$   $V_{IN} = 12\text{ V}$

Figure 69. Load Transient Between 0.1 A and 1 A

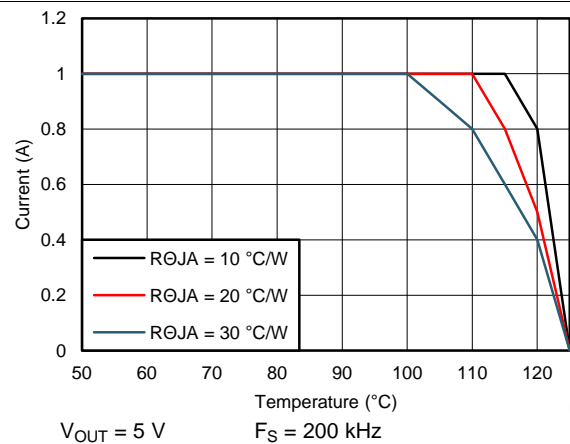
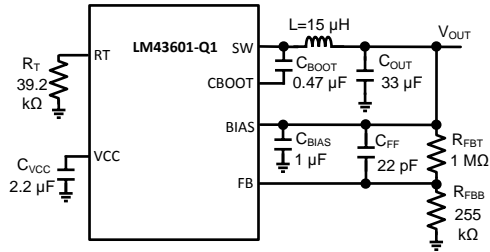

Figure 70. Derating Curve

See Table 2 for bill of materials for each  $V_{OUT}$  and  $F_S$  combination. Unless otherwise stated, application performance curves were taken at  $T_A = 25^\circ\text{C}$ .

$V_{OUT} = 5\text{ V}$   $F_S = 1\text{ MHz}$



$V_{OUT} = 5\text{ V}$   $F_S = 1\text{ MHz}$   $V_{IN} = 12\text{ V}$

Figure 71. BOM for  $V_{OUT} = 5\text{ V}$   $F_S = 1\text{ MHz}$

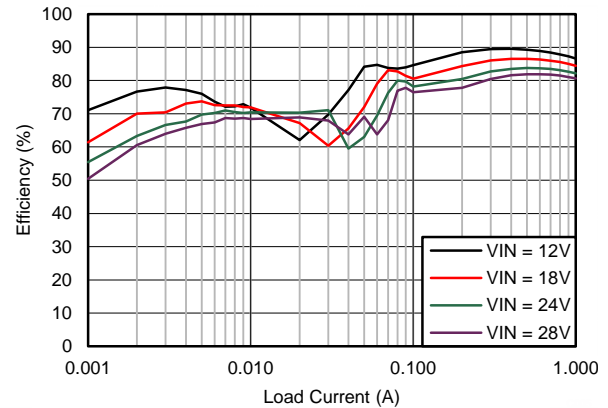

$V_{OUT} = 5\text{ V}$   $F_S = 1\text{ MHz}$   $V_{IN} = 12\text{ V}$

Figure 72. Efficiency

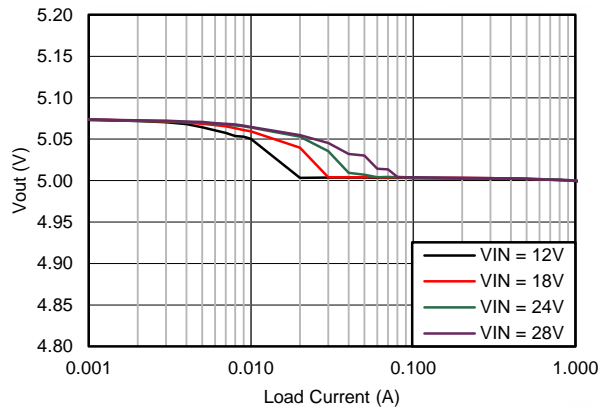

$V_{OUT} = 5\text{ V}$   $F_S = 1\text{ MHz}$

Figure 73. Output Voltage Regulation

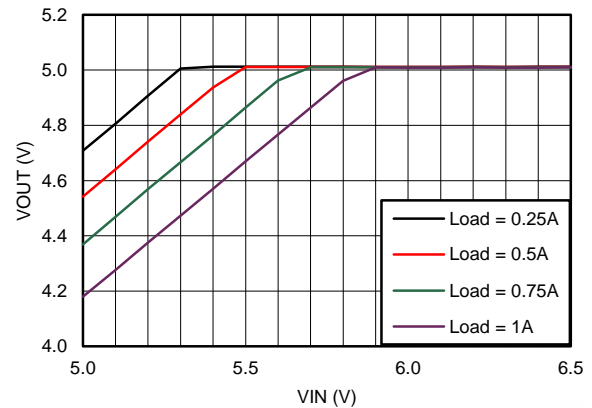

$V_{OUT} = 5\text{ V}$   $F_S = 1\text{ MHz}$

Figure 74. Dropout Curve

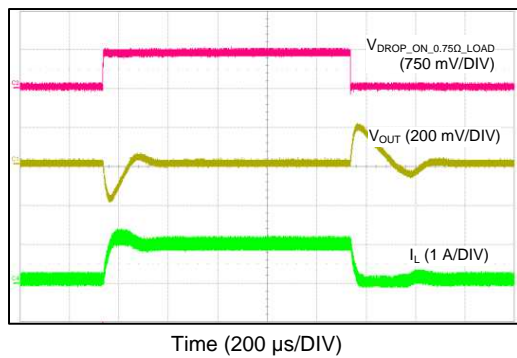

$V_{OUT} = 5\text{ V}$   $F_S = 1\text{ MHz}$   $V_{IN} = 12\text{ V}$

Figure 75. Load Transient Between 0.1 A and 1 A

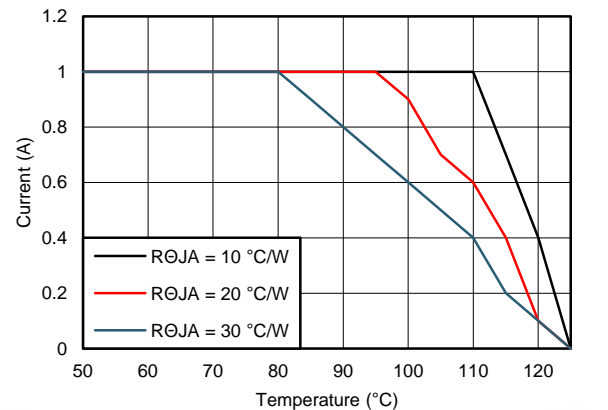

$V_{OUT} = 5\text{ V}$   $F_S = 1\text{ MHz}$   $V_{IN} = 12\text{ V}$

Figure 76. Derating Curve

# LM43601-Q1

SNVSA00B – JULY 2015 – REVISED NOVEMBER 2017

www.ti.com

See Table 2 for bill of materials for each  $V_{OUT}$  and  $F_S$  combination. Unless otherwise stated, application performance curves were taken at  $T_A = 25^\circ\text{C}$ .

$V_{OUT} = 5\text{ V}$   $F_S = 2.2\text{ MHz}$

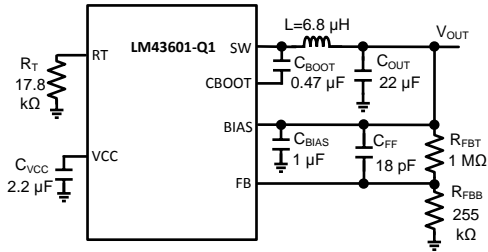

$V_{OUT} = 5\text{ V}$   $F_S = 1\text{ MHz}$   $V_{IN} = 12\text{ V}$

Figure 77. BOM for  $V_{OUT} = 5\text{ V}$   $F_S = 2.2\text{ MHz}$

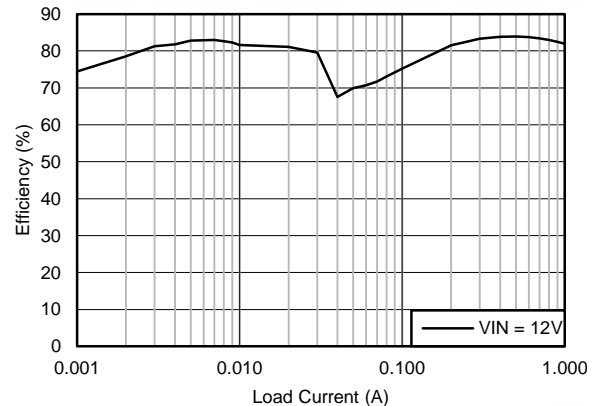

$V_{OUT} = 5\text{ V}$   $F_S = 2.2\text{ MHz}$   $V_{IN} = 12\text{ V}$

Figure 78. Efficiency

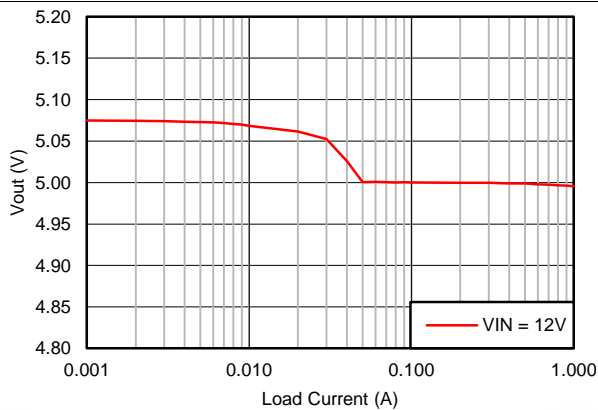

$V_{OUT} = 5\text{ V}$   $F_S = 2.2\text{ MHz}$

Figure 79. Output Voltage Regulation

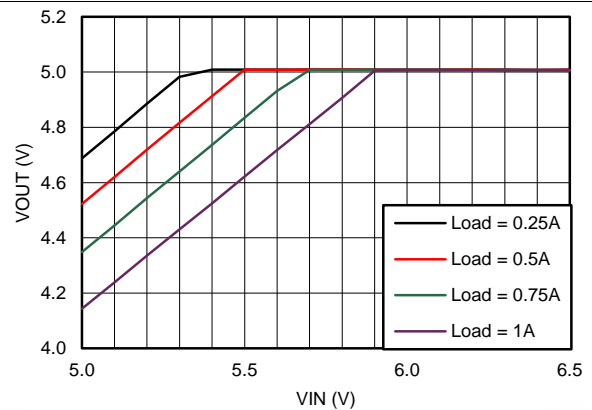

$V_{OUT} = 5\text{ V}$   $F_S = 2.2\text{ MHz}$

Figure 80. Dropout Curve

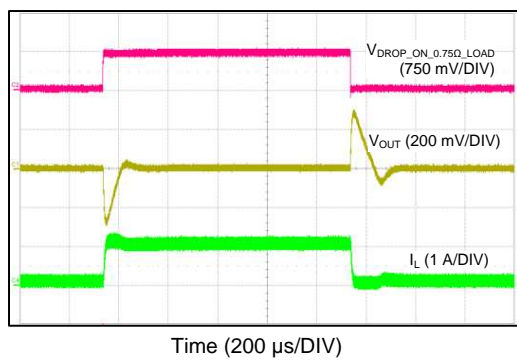

$V_{OUT} = 5\text{ V}$   $F_S = 2.2\text{ MHz}$   $V_{IN} = 12\text{ V}$

Figure 81. Load Transient Between 0.1 A and 1 A

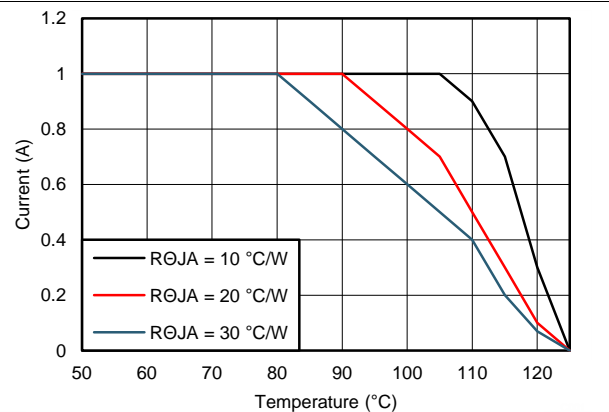

$V_{OUT} = 5\text{ V}$   $F_S = 2.2\text{ MHz}$   $V_{IN} = 12\text{ V}$

Figure 82. Derating Curve

See Table 2 for bill of materials for each  $V_{OUT}$  and  $F_S$  combination. Unless otherwise stated, application performance curves were taken at  $T_A = 25^\circ\text{C}$ .

$V_{OUT} = 12\text{ V}$   $F_S = 500\text{ kHz}$

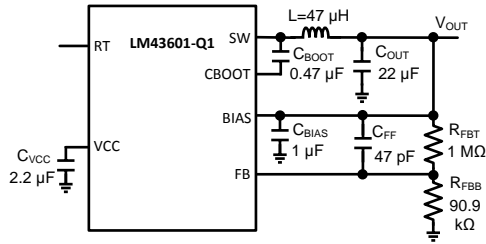

$V_{OUT} = 12\text{ V}$   $F_S = 500\text{ kHz}$   $V_{IN} = 24\text{ V}$

Figure 83. BOM for  $V_{OUT} = 12\text{ V}$   $F_S = 500\text{ kHz}$

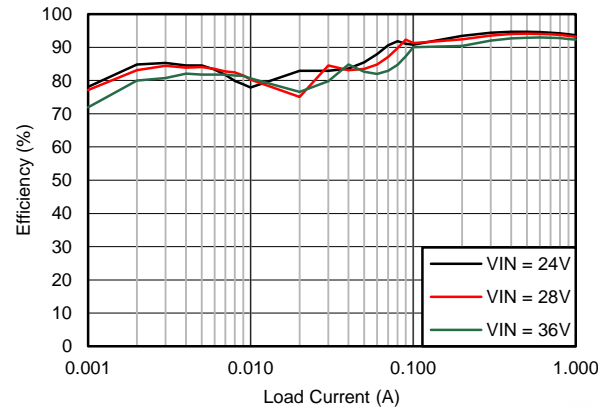

$V_{OUT} = 12\text{ V}$   $F_S = 500\text{ kHz}$

Figure 84. Efficiency

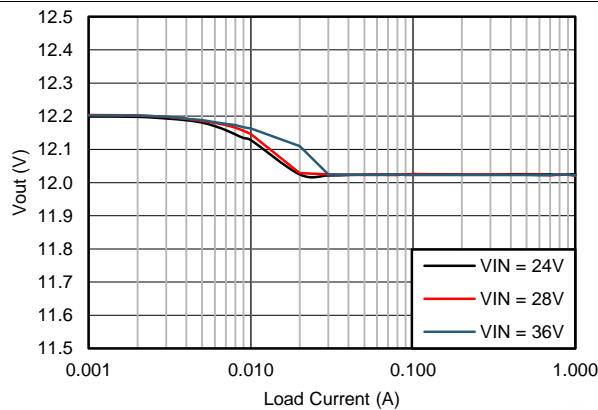

$V_{OUT} = 12\text{ V}$   $F_S = 500\text{ kHz}$

Figure 85. Output Voltage Regulation

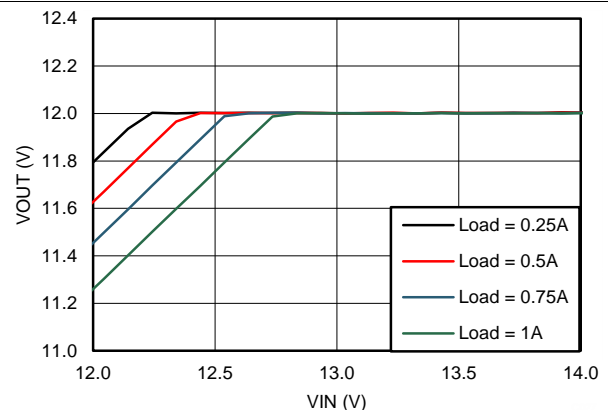

$V_{OUT} = 12\text{ V}$   $F_S = 500\text{ kHz}$

Figure 86. Dropout Curve

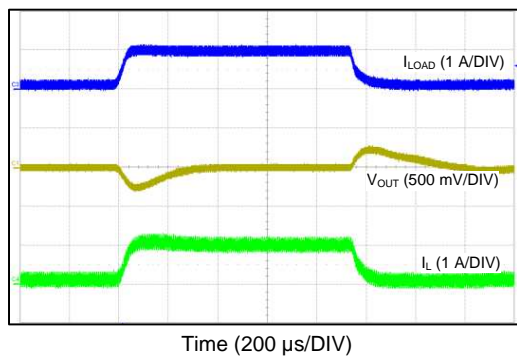

$V_{OUT} = 12\text{ V}$   $F_S = 500\text{ kHz}$   $V_{IN} = 24\text{ V}$

Figure 87. Load Transient Between 0.1 A and 1 A

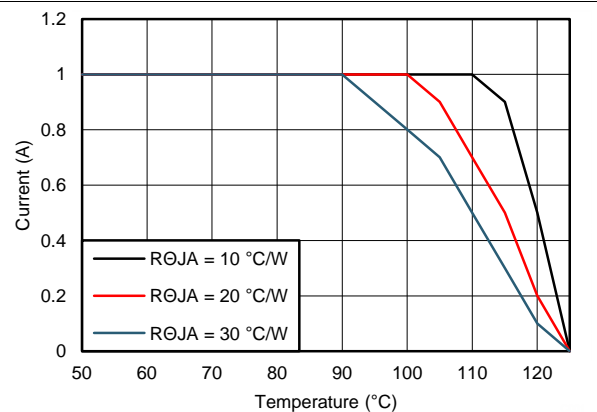

$V_{OUT} = 12\text{ V}$   $F_S = 500\text{ kHz}$   $V_{IN} = 24\text{ V}$

Figure 88. Derating Curve

See Table 2 for bill of materials for each  $V_{OUT}$  and  $F_S$  combination. Unless otherwise stated, application performance curves were taken at  $T_A = 25^\circ\text{C}$ .

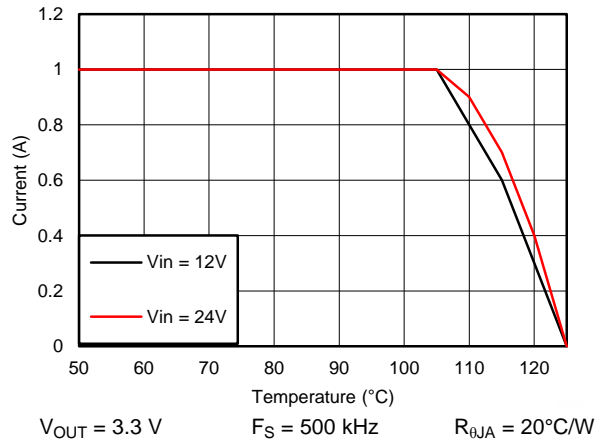

Figure 89. Derating Curve with  $R_{\theta JA} = 20^\circ\text{C/W}$

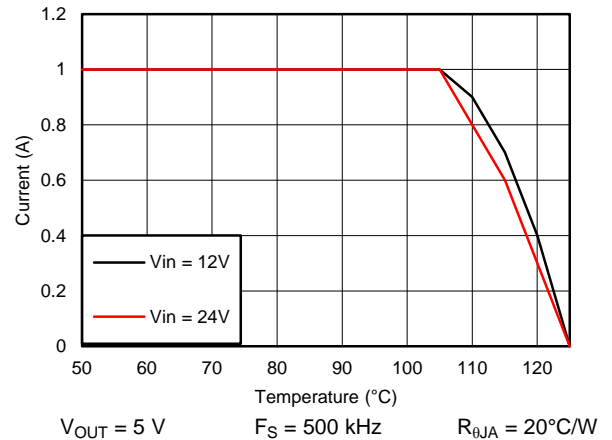

Figure 90. Derating Curve with  $R_{\theta JA} = 20^\circ\text{C/W}$

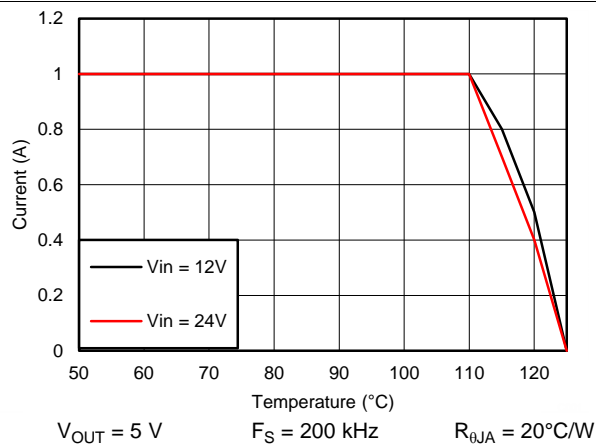

Figure 91. Derating Curve with  $R_{\theta JA} = 20^\circ\text{C/W}$

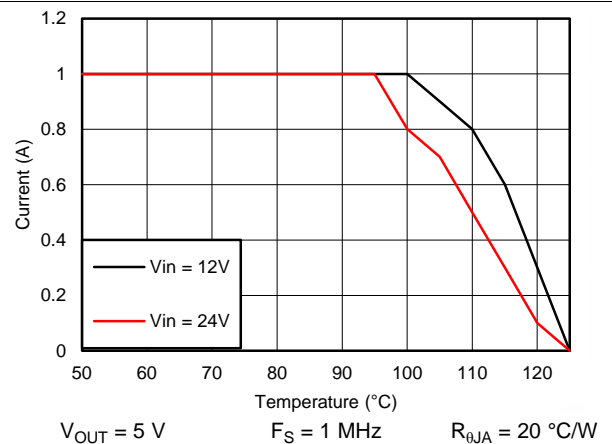

Figure 92. Derating Curve with  $R_{\theta JA} = 20^\circ\text{C/W}$

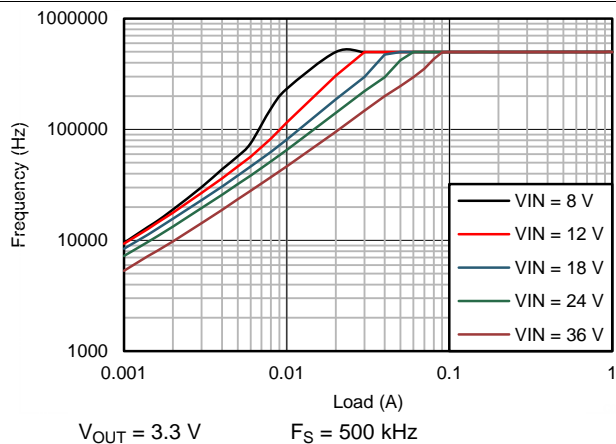

Figure 93. Switching Frequency vs  $I_{OUT}$  in PFM Operation

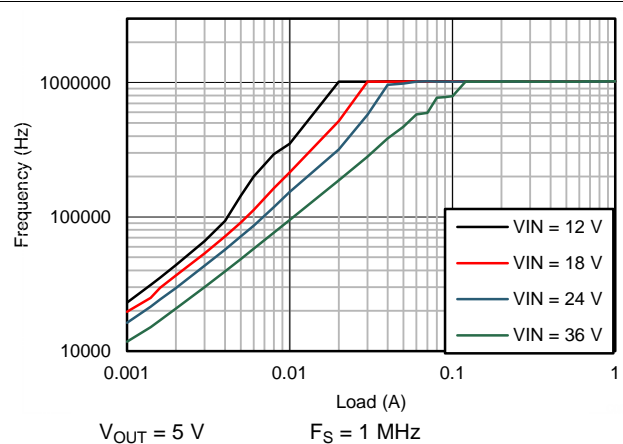
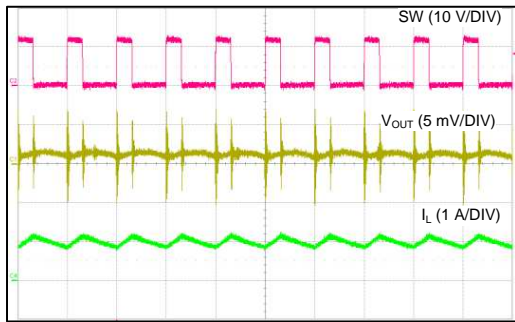

Figure 94. Switching Frequency vs  $I_{OUT}$  in PFM Operation

See Table 2 for bill of materials for each  $V_{OUT}$  and  $F_S$  combination. Unless otherwise stated, application performance curves were taken at  $T_A = 25^\circ\text{C}$ .



$V_{OUT} = 3.3\text{ V}$        $F_S = 500\text{ kHz}$        $I_{OUT} = 1\text{ A}$

Figure 95. Switching Waveform in CCM Operation



$V_{OUT} = 3.3\text{ V}$        $F_S = 500\text{ kHz}$        $I_{OUT} = 40\text{ mA}$

Figure 96. Switching Waveform in DCM Operation

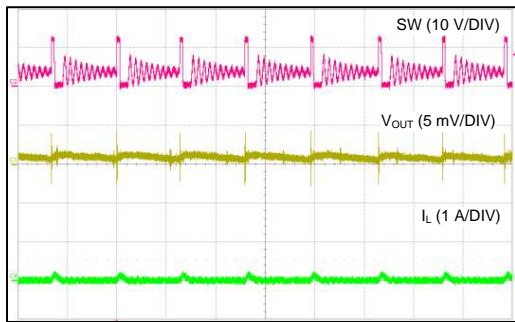

$V_{OUT} = 3.3\text{ V}$        $F_S = 500\text{ kHz}$        $I_{OUT} = 10\text{ mA}$

Figure 97. Switching Waveform in PFM Operation

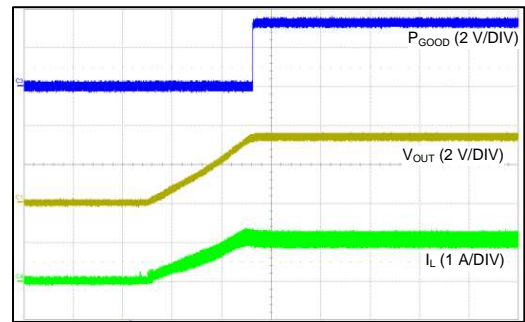

$V_{IN} = 12\text{ V}$        $V_{OUT} = 3.3\text{ V}$        $R_{LOAD} = 3.3\ \Omega$

Figure 98. Start-up Into Full Load with Internal Soft-Start Rate

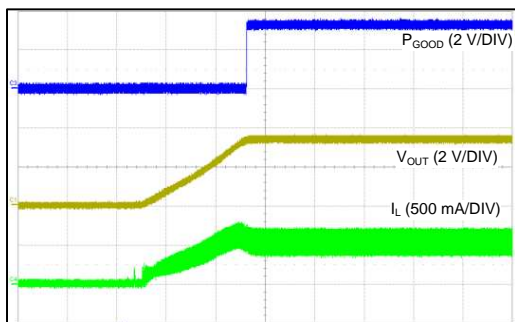

$V_{IN} = 12\text{ V}$        $V_{OUT} = 3.3\text{ V}$        $R_{LOAD} = 6.6\ \Omega$

Figure 99. Start-up Into Half Load with Internal Soft-Start Rate

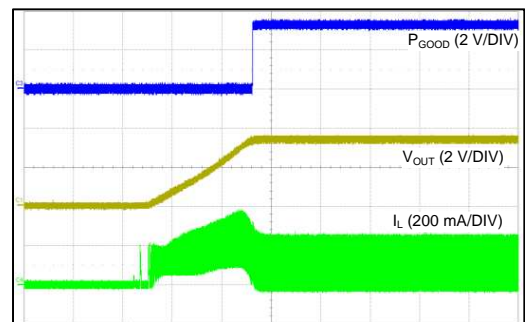

$V_{IN} = 12\text{ V}$        $V_{OUT} = 3.3\text{ V}$        $R_{LOAD} = 33\ \Omega$

Figure 100. Start-up Into 100 mA with Internal Soft-Start Rate

See Table 2 for bill of materials for each  $V_{OUT}$  and  $F_S$  combination. Unless otherwise stated, application performance curves were taken at  $T_A = 25^\circ\text{C}$ .

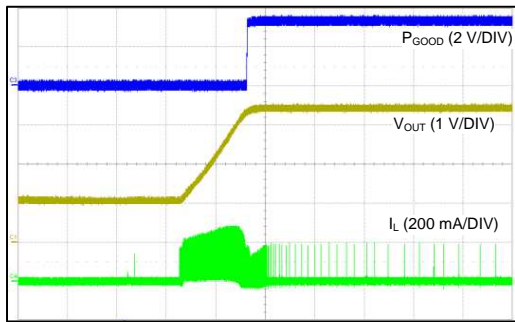

Time (2 ms/DIV)

$V_{IN} = 12\text{V}$       $V_{OUT} = 3.3\text{V}$       $R_{LOAD} = \text{Open}$

Figure 101. Start-up Into 1.0 V Pre-biased Voltage

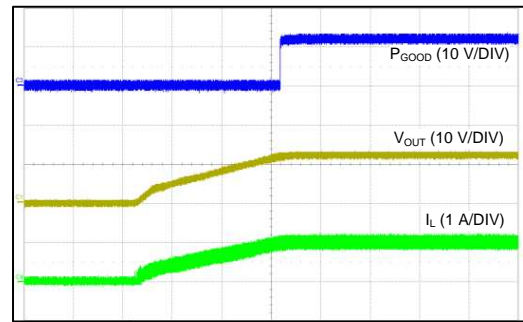

Time (5 ms/DIV)

$V_{IN} = 24\text{V}$       $V_{OUT} = 12\text{V}$       $R_{LOAD} = 12\ \Omega$

Figure 102. Start-up with External Capacitor  $C_{SS} = 33\text{ nF}$

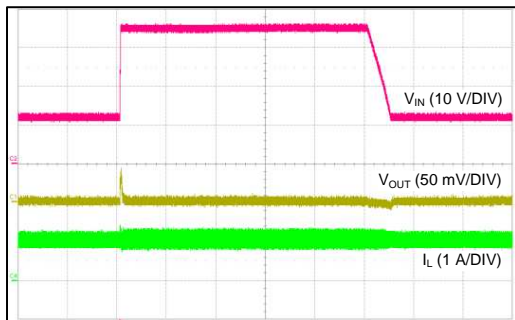

Time (2 ms/DIV)

$V_{OUT} = 3.3\text{V}$       $F_S = 500\text{ kHz}$       $I_{OUT} = 1\text{ A}$

Figure 103. Line Transient:  $V_{IN}$  Transitions Between 12 V and 36 V

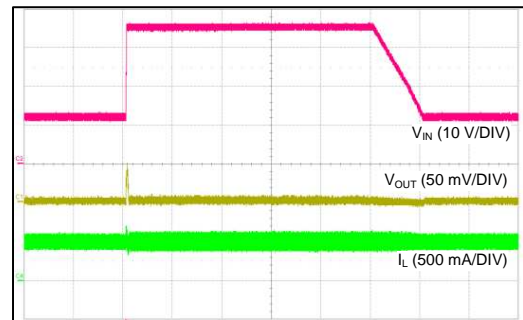

Time (2 ms/DIV)

$V_{OUT} = 3.3\text{V}$       $F_S = 500\text{ kHz}$       $I_{OUT} = 0.5\text{ A}$

Figure 104. Line Transient:  $V_{IN}$  Transitions Between 12 V and 36 V

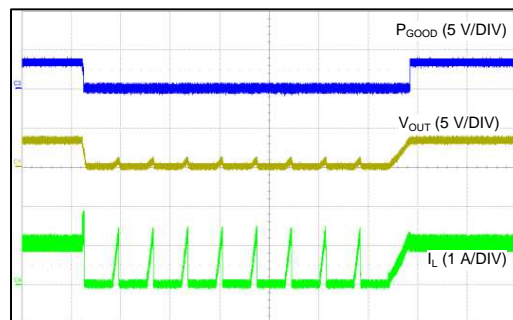

Time (10 ms/DIV)

$V_{OUT} = 3.3\text{V}$       $F_S = 500\text{ kHz}$       $V_{IN} = 12\text{V}$

Figure 105. Short-Circuit Protection and Recover



## 9 Power Supply Recommendations

The LM43601-Q1 is designed to operate from an input voltage supply range between 3.5 V and 36 V. This input supply must be able to withstand the maximum input current and maintain a voltage above 3.5 V. The resistance of the input supply rail should be low enough that an input current transient does not cause a high enough drop at the LM43601-Q1 supply voltage that can cause a false UVLO fault triggering and system reset.

If the input supply is located more than a few inches from the LM43601-Q1 additional bulk capacitance may be required in addition to the ceramic bypass capacitors. The amount of bulk capacitance is not critical, but a 47- $\mu$ F or 100- $\mu$ F electrolytic capacitor is a typical choice.

## 10 Layout

The performance of any switching converter depends as much upon the layout of the PCB as the component selection. The following guidelines will help users design a PCB with the best power conversion performance, thermal performance, and minimized generation of unwanted EMI.

### 10.1 Layout Guidelines

1. Place ceramic high frequency bypass  $C_{IN}$  as close as possible to the LM43601-Q1  $V_{IN}$  and PGND pins. Grounding for both the input and output capacitors should consist of localized top side planes that connect to the PGND pins and PAD.
2. Place bypass capacitors for VCC and BIAS close to the pins and ground the bypass capacitors to device ground.
3. Minimize trace length to the FB pin. Both feedback resistors,  $R_{FBT}$  and  $R_{FBB}$  must be located close to the FB pin. Place  $C_{FF}$  directly in parallel with  $R_{FBT}$ . If  $V_{OUT}$  accuracy at the load is important, make sure  $V_{OUT}$  sense is made at the load. Route  $V_{OUT}$  sense path away from noisy nodes and preferably through a layer on the other side of a shielding layer.
4. Use ground plane in one of the middle layers as noise shielding and heat dissipation path.
5. Have a single point ground connection to the plane. The ground connections for the feedback, soft-start, and enable components should be routed to the ground plane. This prevents any switched or load currents from flowing in the analog ground traces. If not properly handled, poor grounding can result in degraded load regulation or erratic output voltage ripple behavior.
6. Make  $V_{IN}$ ,  $V_{OUT}$  and ground bus connections as wide as possible. This reduces any voltage drops on the input or output paths of the converter and maximizes efficiency.
7. Provide adequate device heat-sinking. Use an array of heat-sinking vias to connect the exposed pad to the ground plane on the bottom PCB layer. If the PCB has multiple copper layers, these thermal vias can also be connected to inner layer heat-spreading ground planes. Ensure enough copper area is used for heat-sinking to keep the junction temperature below 125°C.

#### 10.1.1 Compact Layout for EMI Reduction

Radiated EMI is generated by the high  $di/dt$  components in pulsing currents in switching converters. The larger area covered by the path of a pulsing current, the more electromagnetic emission is generated. The key to minimize radiated EMI is to identify the pulsing current path and minimize the area of the path. In Buck converters, the pulsing current path is from the  $V_{IN}$  side of the input capacitors to HS switch, to the LS switch, and then return to the ground of the input capacitors, as shown in [Figure 106](#).

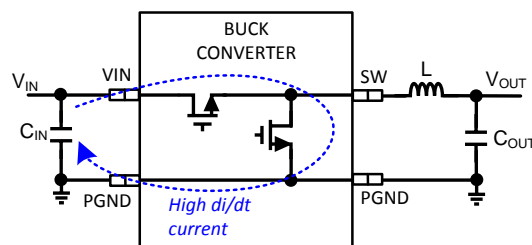

**Figure 106. Buck Converter High  $di/dt$  Path**

## Layout Guidelines (continued)

High frequency ceramic bypass capacitors at the input side provide primary path for the high di/dt components of the pulsing current. Placing ceramic bypass capacitor(s) as close as possible to the VIN and PGND pins is the key to EMI reduction.

The SW pin connecting to the inductor should be as short as possible, and just wide enough to carry the load current without excessive heating. Short, thick traces or copper pours (shapes) should be used for high current conduction path to minimize parasitic resistance. The output capacitors should be placed close to the V<sub>OUT</sub> end of the inductor and closely grounded to PGND pin and exposed PAD.

The bypass capacitors on VCC and BIAS pins should be placed as close as possible to the pins respectively and closely grounded to PGND and the exposed PAD.

### 10.1.2 Ground Plane and Thermal Considerations

It is recommended to use one of the middle layers as a solid ground plane. Ground plane provides shielding for sensitive circuits and traces. It also provides a quiet reference potential for the control circuitry. The AGND and PGND pins should be connected to the ground plane using vias right next to the bypass capacitors. PGND pins are connected to the source of the internal LS switch. They should be connected directly to the grounds of the input and output capacitors. The PGND net contains noise at the switching frequency and may bounce due to load variations. The PGND trace, as well as PVIN and SW traces, should be constrained to one side of the ground plane. The other side of the ground plane contains much less noise and should be used for sensitive routes.

It is recommended to provide adequate device heat sinking by utilizing the PAD of the IC as the primary thermal path. Use a minimum 4 by 4 array of 10 mil thermal vias to connect the PAD to the system ground plane for heat sinking. The vias should be evenly distributed under the PAD. Use as much copper as possible for system ground plane on the top and bottom layers for the best heat dissipation. It is recommended to use a four-layer board with the copper thickness, for the four layers, starting from the top one, 2 oz / 1 oz / 1 oz / 2 oz. Four layer boards with enough copper thickness and proper layout provides low current conduction impedance, proper shielding and lower thermal resistance.

The thermal characteristics of the LM43601-Q1 are specified using the parameter R<sub>θJA</sub>, which characterize the junction temperature of the silicon to the ambient temperature in a specific system. Although the value of R<sub>θJA</sub> is dependant on many variables, it still can be used to approximate the operating junction temperature of the device. To obtain an estimate of the device junction temperature, one may use the following relationship:

$$T_J = P_D \times R_{\theta JA} + T_A$$

where

- T<sub>J</sub> = junction temperature in °C
- P<sub>D</sub> = V<sub>IN</sub> × I<sub>IN</sub> × (1 – Efficiency) – 1.1 × I<sub>OUT</sub> × DCR
- DCR = inductor DC parasitic resistance in Ω
- R<sub>θJA</sub> = junction-to-ambient thermal resistance of the device in °C/W
- T<sub>A</sub> = ambient temperature in °C.

(27)

The maximum operating junction temperature of the LM43601-Q1 is 125°C. R<sub>θJA</sub> is highly related to PCB size and layout, as well as environmental factors such as heat sinking and air flow. [Figure 107](#) shows measured results of R<sub>θJA</sub> with different copper area on a 2-layer board and a 4-layer board.

Layout Guidelines (continued)

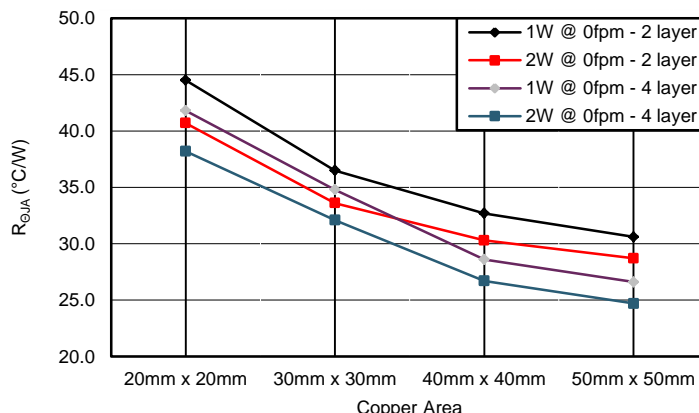

Figure 107. Measured  $R_{\theta JA}$  vs PCB Copper Area on a 2-layer Board and a 4-layer Board

10.1.3 Feedback Resistors

To reduce noise sensitivity of the output voltage feedback path, it is important to place the resistor divider and  $C_{FF}$  close to the FB pin, rather than close to the load. The FB pin is the input to the error amplifier, so it is a high impedance node and very sensitive to noise. Placing the resistor divider and  $C_{FF}$  closer to the FB pin reduces the trace length of FB signal and reduces noise coupling. The output node is a low impedance node, so the trace from  $V_{OUT}$  to the resistor divider can be long if short path is not available.

If voltage accuracy at the load is important, make sure voltage sense is made at the load. Doing so will correct for voltage drops along the traces and provide the best output accuracy. The voltage sense trace from the load to the feedback resistor divider should be routed away from the SW node path, the inductor and  $V_{IN}$  path to avoid contaminating the feedback signal with switch noise, while also minimizing the trace length. This is most important when high value resistors are used to set the output voltage. It is recommended to route the voltage sense trace on a different layer than the inductor, SW node and  $V_{IN}$  path, such that there is a ground plane in between the feedback trace and inductor / SW node /  $V_{IN}$  polygon. This provides further shielding for the voltage feedback path from switching noises.

## 10.2 Layout Example

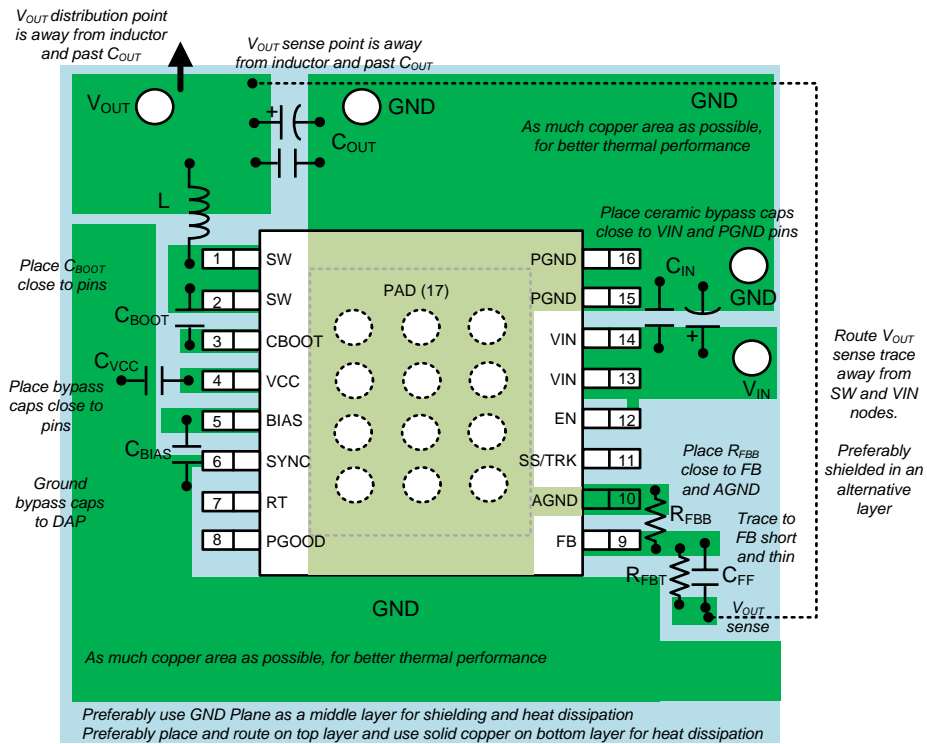

Figure 108. LM43601-Q1 PCB Layout Example

## 11 Device and Documentation Support

### 11.1 Device Support

#### 11.1.1 Custom Design With WEBENCH® Tools

[Click here](#) to create a custom design using the LM43601-Q1 device with the WEBENCH® Power Designer.

1. Start by entering the input voltage ( $V_{IN}$ ), output voltage ( $V_{OUT}$ ), and output current ( $I_{OUT}$ ) requirements.
2. Optimize the design for key parameters such as efficiency, footprint, and cost using the optimizer dial.
3. Compare the generated design with other possible solutions from Texas Instruments.

The WEBENCH Power Designer provides a customized schematic along with a list of materials with real-time pricing and component availability.

In most cases, these actions are available:

- Run electrical simulations to see important waveforms and circuit performance
- Run thermal simulations to understand board thermal performance
- Export customized schematic and layout into popular CAD formats
- Print PDF reports for the design, and share the design with colleagues

Get more information about WEBENCH tools at [www.ti.com/WEBENCH](http://www.ti.com/WEBENCH).

#### 11.2 Receiving Notification of Documentation Updates

To receive notification of documentation updates, navigate to the device product folder on ti.com. In the upper right corner, click on *Alert me* to register and receive a weekly digest of any product information that has changed. For change details, review the revision history included in any revised document.

#### 11.3 Community Resources

The following links connect to TI community resources. Linked contents are provided "AS IS" by the respective contributors. They do not constitute TI specifications and do not necessarily reflect TI's views; see TI's [Terms of Use](#).

**TI E2E™ Online Community** *TI's Engineer-to-Engineer (E2E) Community*. Created to foster collaboration among engineers. At [e2e.ti.com](http://e2e.ti.com), you can ask questions, share knowledge, explore ideas and help solve problems with fellow engineers.

**Design Support** *TI's Design Support* Quickly find helpful E2E forums along with design support tools and contact information for technical support.

#### 11.4 Trademarks

E2E is a trademark of Texas Instruments.

WEBENCH is a registered trademark of Texas Instruments.

All other trademarks are the property of their respective owners.

#### 11.5 Electrostatic Discharge Caution



These devices have limited built-in ESD protection. The leads should be shorted together or the device placed in conductive foam during storage or handling to prevent electrostatic damage to the MOS gates.

#### 11.6 Glossary

[SLYZ022](#) — *TI Glossary*.

This glossary lists and explains terms, acronyms, and definitions.

## 12 Mechanical, Packaging, and Orderable Information

The following pages include mechanical packaging and orderable information. This information is the most current data available for the designated devices. This data is subject to change without notice and revision of this document. For browser-based versions of this data sheet, refer to the left-hand navigation.

**PACKAGING INFORMATION**

Orderable Device	Status (1)	Package Type	Package Drawing	Pins	Package Qty	Eco Plan (2)	Lead finish/ Ball material (6)	MSL Peak Temp (3)	Op Temp (°C)	Device Marking (4/5)	Samples
LM43601AQPWPRQ1	ACTIVE	HTSSOP	PWP	16	2000	RoHS & Green	NIPDAU	Level-3-260C-168 HR	-40 to 125	43601AQ	<b>Samples</b>
LM43601AQPWPTQ1	ACTIVE	HTSSOP	PWP	16	250	RoHS & Green	NIPDAU	Level-3-260C-168 HR	-40 to 125	43601AQ	<b>Samples</b>
LM43601QPWPRQ1	NRND	HTSSOP	PWP	16	2000	RoHS & Green	NIPDAU	Level-3-260C-168 HR	-40 to 125	43601Q1	
LM43601QPWPTQ1	NRND	HTSSOP	PWP	16	250	RoHS & Green	NIPDAU	Level-3-260C-168 HR	-40 to 125	43601Q1	

(1) The marketing status values are defined as follows:

**ACTIVE:** Product device recommended for new designs.

**LIFEBUY:** TI has announced that the device will be discontinued, and a lifetime-buy period is in effect.

**NRND:** Not recommended for new designs. Device is in production to support existing customers, but TI does not recommend using this part in a new design.

**PREVIEW:** Device has been announced but is not in production. Samples may or may not be available.

**OBSOLETE:** TI has discontinued the production of the device.

(2) **RoHS:** TI defines "RoHS" to mean semiconductor products that are compliant with the current EU RoHS requirements for all 10 RoHS substances, including the requirement that RoHS substance do not exceed 0.1% by weight in homogeneous materials. Where designed to be soldered at high temperatures, "RoHS" products are suitable for use in specified lead-free processes. TI may reference these types of products as "Pb-Free".

**RoHS Exempt:** TI defines "RoHS Exempt" to mean products that contain lead but are compliant with EU RoHS pursuant to a specific EU RoHS exemption.

**Green:** TI defines "Green" to mean the content of Chlorine (Cl) and Bromine (Br) based flame retardants meet JS709B low halogen requirements of <=1000ppm threshold. Antimony trioxide based flame retardants must also meet the <=1000ppm threshold requirement.

(3) MSL, Peak Temp. - The Moisture Sensitivity Level rating according to the JEDEC industry standard classifications, and peak solder temperature.

(4) There may be additional marking, which relates to the logo, the lot trace code information, or the environmental category on the device.

(5) Multiple Device Markings will be inside parentheses. Only one Device Marking contained in parentheses and separated by a "~" will appear on a device. If a line is indented then it is a continuation of the previous line and the two combined represent the entire Device Marking for that device.

(6) Lead finish/Ball material - Orderable Devices may have multiple material finish options. Finish options are separated by a vertical ruled line. Lead finish/Ball material values may wrap to two lines if the finish value exceeds the maximum column width.

**Important Information and Disclaimer:**The information provided on this page represents TI's knowledge and belief as of the date that it is provided. TI bases its knowledge and belief on information provided by third parties, and makes no representation or warranty as to the accuracy of such information. Efforts are underway to better integrate information from third parties. TI has taken and continues to take reasonable steps to provide representative and accurate information but may not have conducted destructive testing or chemical analysis on incoming materials and chemicals. TI and TI suppliers consider certain information to be proprietary, and thus CAS numbers and other limited information may not be available for release.

In no event shall TI's liability arising out of such information exceed the total purchase price of the TI part(s) at issue in this document sold by TI to Customer on an annual basis.

**OTHER QUALIFIED VERSIONS OF LM43601-Q1 :**

- Catalog: [LM43601](#)

**NOTE: Qualified Version Definitions:**

- Catalog - TI's standard catalog product

**TAPE AND REEL INFORMATION**

**QUADRANT ASSIGNMENTS FOR PIN 1 ORIENTATION IN TAPE**

\*All dimensions are nominal

Device	Package Type	Package Drawing	Pins	SPQ	Reel Diameter (mm)	Reel Width W1 (mm)	A0 (mm)	B0 (mm)	K0 (mm)	P1 (mm)	W (mm)	Pin1 Quadrant
LM43601AQPWPRQ1	HTSSOP	PWP	16	2000	330.0	12.4	6.9	5.6	1.6	8.0	12.0	Q1
LM43601QPWPRQ1	HTSSOP	PWP	16	2000	330.0	12.4	6.9	5.6	1.6	8.0	12.0	Q1



**TAPE AND REEL BOX DIMENSIONS**

\*All dimensions are nominal

Device	Package Type	Package Drawing	Pins	SPQ	Length (mm)	Width (mm)	Height (mm)
LM43601AQPWRQ1	HTSSOP	PWP	16	2000	350.0	350.0	43.0
LM43601QPWRQ1	HTSSOP	PWP	16	2000	350.0	350.0	43.0

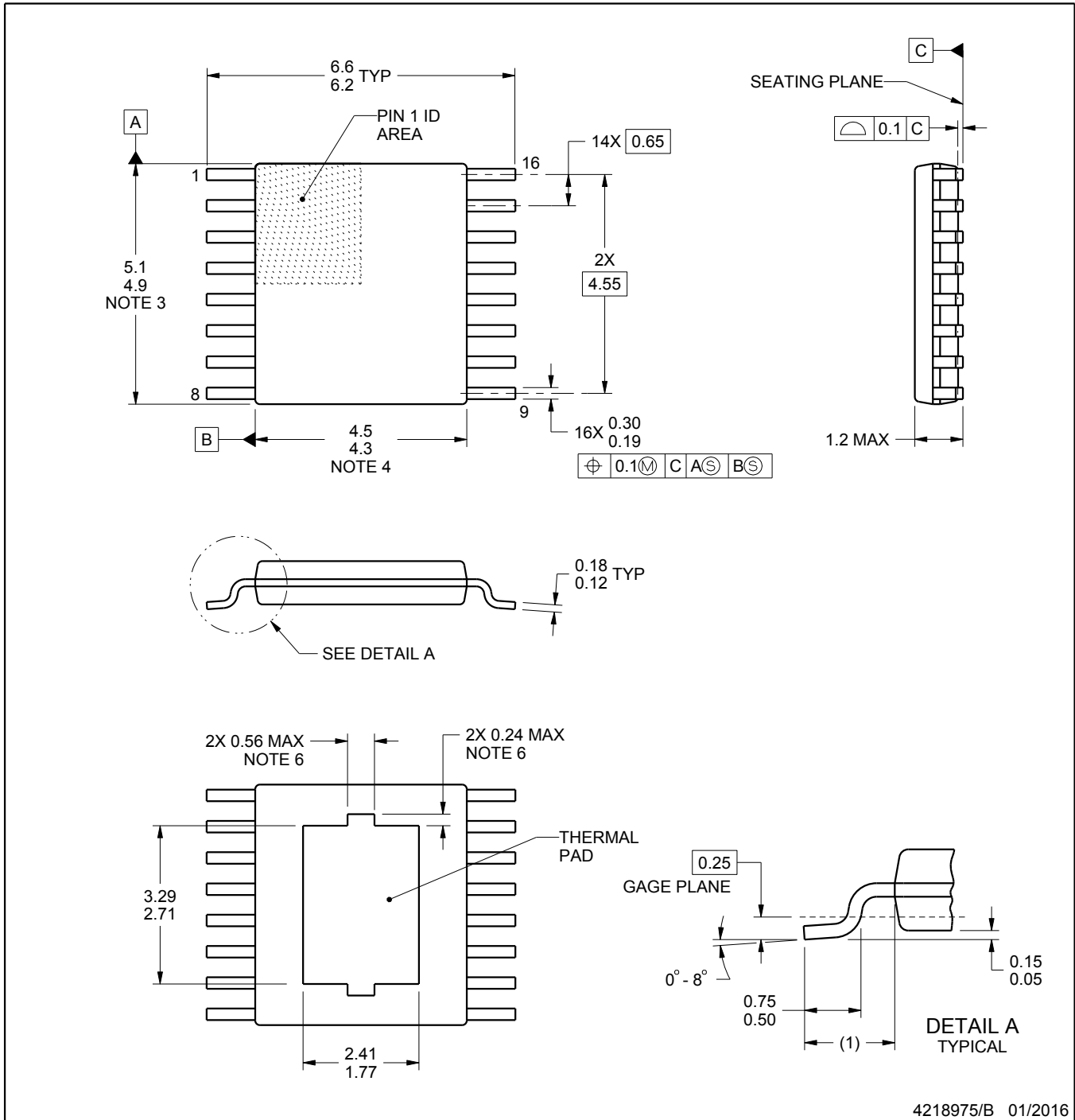

4218975/B 01/2016

PowerPAD is a trademark of Texas Instruments.

NOTES:

1. All linear dimensions are in millimeters. Any dimensions in parenthesis are for reference only. Dimensioning and tolerancing per ASME Y14.5M.
2. This drawing is subject to change without notice.
3. This dimension does not include mold flash, protrusions, or gate burrs. Mold flash, protrusions, or gate burrs shall not exceed 0.15 mm per side.
4. This dimension does not include interlead flash. Interlead flash shall not exceed 0.25 mm per side.
5. Reference JEDEC registration MO-153.
6. Features may not present.

# EXAMPLE BOARD LAYOUT

PWP0016G

PowerPAD™ TSSOP - 1.2 mm max height

PLASTIC SMALL OUTLINE

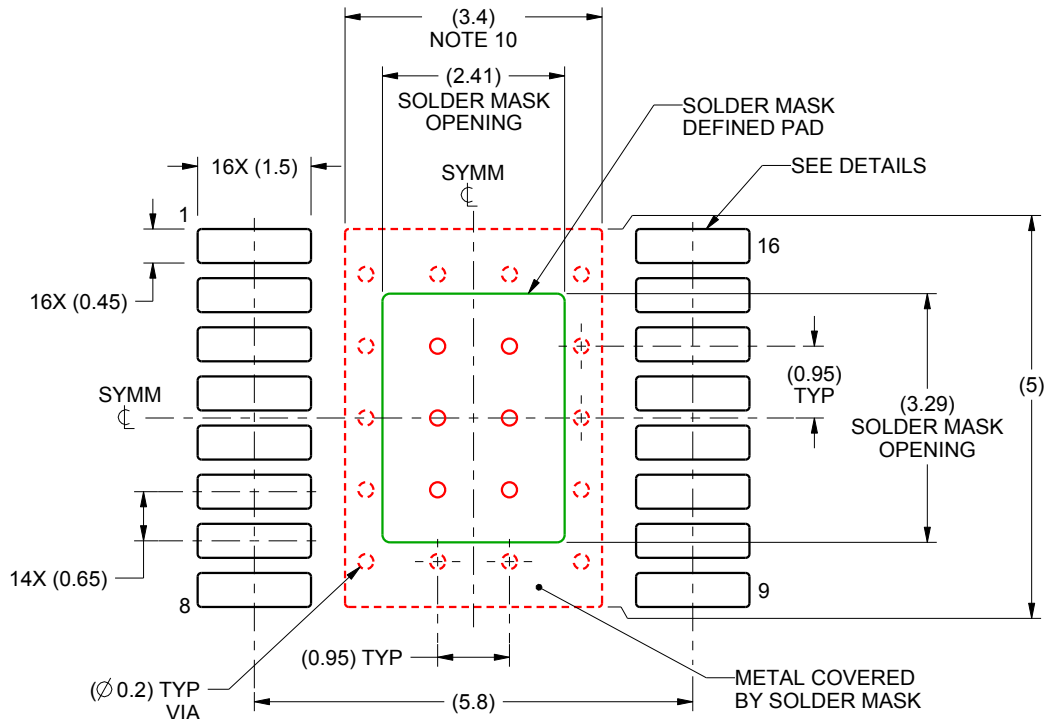

LAND PATTERN EXAMPLE  
SCALE:10X

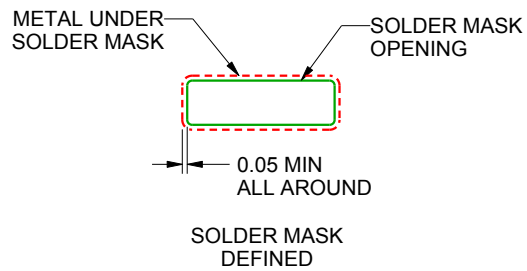
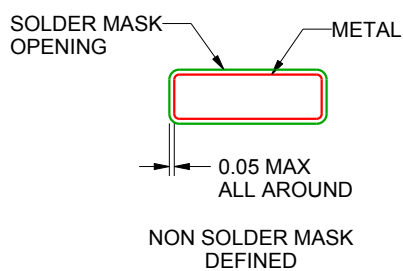

SOLDER MASK DETAILS  
PADS 1-16

4218975/B 01/2016

NOTES: (continued)

- 7. Publication IPC-7351 may have alternate designs.
- 8. Solder mask tolerances between and around signal pads can vary based on board fabrication site.
- 9. This package is designed to be soldered to a thermal pad on the board. For more information, see Texas Instruments literature numbers SLMA002 ([www.ti.com/lit/slma002](http://www.ti.com/lit/slma002)) and SLMA004 ([www.ti.com/lit/slma004](http://www.ti.com/lit/slma004)).
- 10. Size of metal pad may vary due to creepage requirement.

# EXAMPLE STENCIL DESIGN

PWP0016G

PowerPAD™ TSSOP - 1.2 mm max height

PLASTIC SMALL OUTLINE

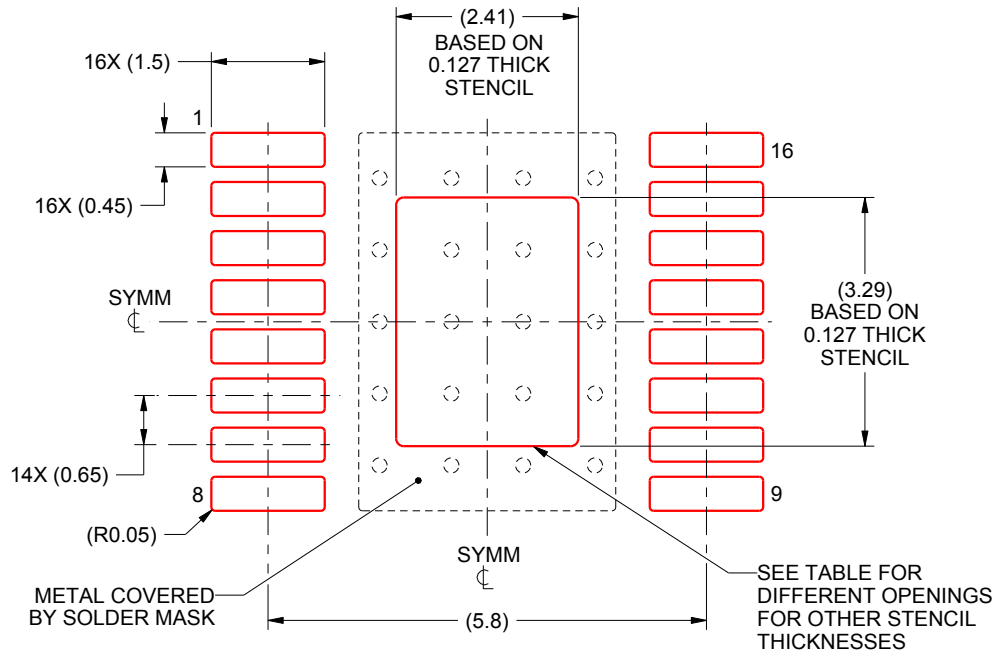

SOLDER PASTE EXAMPLE  
EXPOSED PAD  
100% PRINTED SOLDER COVERAGE BY AREA  
SCALE:10X

STENCIL THICKNESS	SOLDER STENCIL OPENING
0.1	2.69 X 3.68
0.127	2.41 X 3.29 (SHOWN)
0.152	2.20 X 3.00
0.178	2.04 X 2.78

4218975/B 01/2016

NOTES: (continued)

11. Laser cutting apertures with trapezoidal walls and rounded corners may offer better paste release. IPC-7525 may have alternate design recommendations.
12. Board assembly site may have different recommendations for stencil design.

## IMPORTANT NOTICE AND DISCLAIMER

TI PROVIDES TECHNICAL AND RELIABILITY DATA (INCLUDING DATA SHEETS), DESIGN RESOURCES (INCLUDING REFERENCE DESIGNS), APPLICATION OR OTHER DESIGN ADVICE, WEB TOOLS, SAFETY INFORMATION, AND OTHER RESOURCES "AS IS" AND WITH ALL FAULTS, AND DISCLAIMS ALL WARRANTIES, EXPRESS AND IMPLIED, INCLUDING WITHOUT LIMITATION ANY IMPLIED WARRANTIES OF MERCHANTABILITY, FITNESS FOR A PARTICULAR PURPOSE OR NON-INFRINGEMENT OF THIRD PARTY INTELLECTUAL PROPERTY RIGHTS.

These resources are intended for skilled developers designing with TI products. You are solely responsible for (1) selecting the appropriate TI products for your application, (2) designing, validating and testing your application, and (3) ensuring your application meets applicable standards, and any other safety, security, regulatory or other requirements.

These resources are subject to change without notice. TI grants you permission to use these resources only for development of an application that uses the TI products described in the resource. Other reproduction and display of these resources is prohibited. No license is granted to any other TI intellectual property right or to any third party intellectual property right. TI disclaims responsibility for, and you will fully indemnify TI and its representatives against, any claims, damages, costs, losses, and liabilities arising out of your use of these resources.

TI's products are provided subject to [TI's Terms of Sale](#) or other applicable terms available either on [ti.com](https://www.ti.com) or provided in conjunction with such TI products. TI's provision of these resources does not expand or otherwise alter TI's applicable warranties or warranty disclaimers for TI products.

TI objects to and rejects any additional or different terms you may have proposed.

Mailing Address: Texas Instruments, Post Office Box 655303, Dallas, Texas 75265  
Copyright © 2023, Texas Instruments Incorporated