

OPAx828 Low-Offset, Low-Drift, Low-Noise, 45-MHz, 36-V, JFET-Input Operational Amplifiers

1 Features

- Low input voltage noise density: 4 nV/ $\sqrt{\text{Hz}}$ at 1 kHz
- Input voltage noise: 0.1 Hz to 10 Hz: 60 nV_{RMS}
- Low input bias current:
 - 0.1 pA (DGN)
 - 1 pA (D)
- Input offset voltage:
 - 25 μV (DGN)
 - 50 μV (D)
- Input offset drift:
 - 0.2 $\mu\text{V}/^\circ\text{C}$ (DGN)
 - 0.45 $\mu\text{V}/^\circ\text{C}$ (D)
- MUX-friendly inputs
- Gain bandwidth: 45 MHz
- Slew rate: 150 V/ μs
- 14-bit settling time: 120 ns
- Overload power limiter
- Wide supply voltage range: $\pm 4\text{ V}$ to $\pm 18\text{ V}$
- Packages:
 - D Package: 8-pin SOIC
 - DGN Package: 8-pin HVSSOP

2 Applications

- [Data acquisition \(DAQ\)](#)
- [Optical module](#)
- [Lab and field instrumentation](#)
- [Mixed module \(AI,AO,DI,DO\)](#)
- [Ultrasound scanner](#)

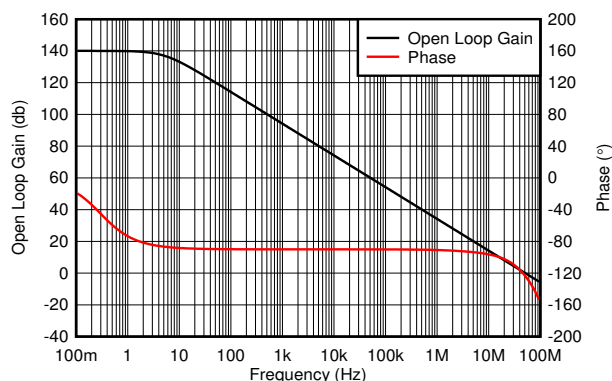

Open-Loop Gain and Phase vs Frequency

3 Description

The OPA828 and OPA2828 (OPAx828) JFET input operational amplifiers are the next generation [OPA627](#) and [OPA827](#), combining high speed with high dc precision and ac performance. These op amps supply low offset voltage, low drift over temperature, low bias current, and low noise with only 60-nV_{RMS} 0.1-Hz to 10-Hz noise. The OPAx828 operate over a wide supply-voltage range of $\pm 4\text{ V}$ to $\pm 18\text{ V}$ and a supply current of 5.5 mA/channel, typical.

AC characteristics, including a 45-MHz gain bandwidth product (GBW), a slew rate of 150 V/ μs , and precision dc characteristics, make the OPAx828 family an excellent choice for a variety of systems. These include high-speed and high-resolution data-acquisition systems, such as 16-bit to 18-bit mixed signal systems, transimpedance (I/V-conversion) amplifiers, filters, precision $\pm 10\text{-V}$ front ends, and high-impedance sensor-interface applications.

The OPAx828 are available in an 8-pin SOIC package and a thermally enhanced, 8-pin HVSSOP PowerPAD™ integrated circuit package.

Device Information

PART NUMBER	CHANNELS	PACKAGE ⁽¹⁾
OPA828	Single	D (SOIC, 8)
		DGN (HVSSOP, 8)
OPA2828	Dual	DGN (HVSSOP, 8)

- (1) For all available packages, see the orderable addendum at the end of the data sheet.

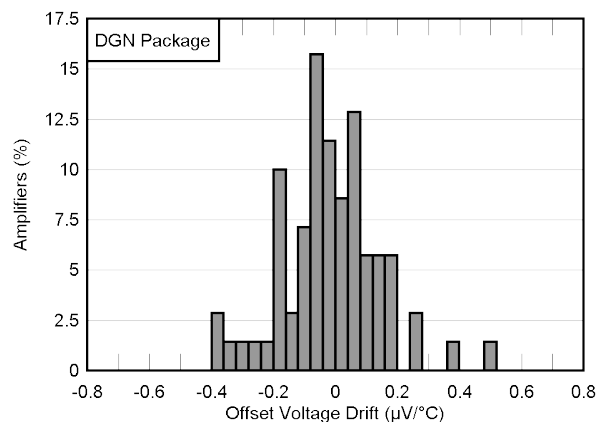

Offset Voltage Drift



Table of Contents

1 Features	1	7.4 Device Functional Modes.....	26
2 Applications	1	8 Application and Implementation	27
3 Description	1	8.1 Application Information.....	27
4 Revision History	2	8.2 Typical Applications.....	27
5 Pin Configuration and Functions	3	8.3 Power Supply Recommendations.....	29
6 Specifications	4	8.4 Layout.....	30
6.1 Absolute Maximum Ratings.....	4	9 Device and Documentation Support	34
6.2 ESD Ratings.....	4	9.1 Device Support.....	34
6.3 Recommended Operating Conditions.....	4	9.2 Documentation Support.....	34
6.4 Thermal Information.....	4	9.3 Receiving Notification of Documentation Updates.....	34
6.5 Electrical Characteristics.....	5	9.4 Support Resources.....	34
6.6 Typical Characteristics.....	7	9.5 Trademarks.....	34
7 Detailed Description	16	9.6 Electrostatic Discharge Caution.....	34
7.1 Overview.....	16	9.7 Glossary.....	34
7.2 Functional Block Diagram.....	16	10 Mechanical, Packaging, and Orderable Information	34
7.3 Feature Description.....	17		

4 Revision History

NOTE: Page numbers for previous revisions may differ from page numbers in the current version.

Changes from Revision C (December 2018) to Revision D (December 2022) Page

- Changed OPA828 and OPA2828 in DGN package from preview to production data and added associated content..... 1

Changes from Revision B (December 2018) to Revision C (October 2022) Page

- Added OPA828 and OPA2828 in DGN (HVSSOP, 8) preview package and associated content to data sheet. 1
- Added T_A symbol to Ambient Temperature row in *Recommended Operating Conditions* 4
- Added table note to *Recommended Operating Conditions* 4
- Deleted V_S from *Electrical Characteristics*, same data listed under *Recommended Operating Conditions* 5
- Deleted T_A from *Electrical Characteristics*, same data listed under *Recommended Operating Conditions* 5
- Changed section title from *Capacitive Load and Stability* to *Noise Performance* 21
- Added missing Equation 2..... 21
- Added *PowerPAD Design Considerations (DGN Package Only)* section..... 32

Changes from Revision A (November 2018) to Revision B (December 2018) Page

- First release of production-data data sheet..... 1

5 Pin Configuration and Functions

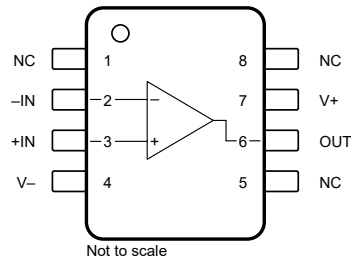

Figure 5-1. OPA828 D Package, 8-Pin SOIC and DGN Package, 8-Pin HVSSOP (Top View)

Table 5-1. Pin Functions: OPA828

NAME	NO.	TYPE	DESCRIPTION
-IN	2	Input	Negative (inverting) input
+IN	3	Input	Positive (noninverting) input
NC	1, 5, 8	—	No internal connection (can be left floating or grounded)
OUT	6	Output	Output
V+	7	—	Positive (highest) power supply
V-	4	—	Negative (lowest) power supply
Thermal Pad ⁽¹⁾	—	—	Exposed thermally conductive pad on the underside of the package. Solder the thermal pad to a heat-spreading power or ground plane. Although electrically isolated (> 10 MΩ) from the die, tie the thermal pad to V- or ground to minimize leakage to the input pins

(1) DGN package only.

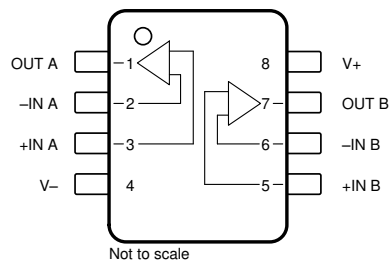

Figure 5-2. OPA2828 DGN Package, 8-Pin HVSSOP (Top View)

Table 5-2. Pin Functions: OPA2828

NAME	NO.	TYPE	DESCRIPTION
-IN A	2	Input	Negative (inverting) input A
+IN A	3	Input	Positive (noninverting) input A
-IN B	6	Input	Negative (inverting) input B
+IN B	5	Input	Positive (noninverting) input B
OUT A	1	Output	Output A
OUT B	7	Output	Output B
V+	8	—	Positive (highest) power supply
V-	4	—	Negative (lowest) power supply
Thermal Pad ⁽¹⁾	—	—	Exposed thermally conductive pad on the underside of the package. Solder the thermal pad to a heat-spreading power or ground plane. Although electrically isolated (> 10 MΩ) from the die, tie the thermal pad to V- or ground to minimize leakage to the input pins

6 Specifications

6.1 Absolute Maximum Ratings

over operating free-air temperature range (unless otherwise noted)⁽¹⁾

			MIN	MAX	UNIT	
V _S	Supply voltage, (V+) – (V–)	Single-supply		40	V	
		Dual-supply		±20		
	Signal input pins	Voltage	Common-mode ⁽³⁾	(V–) – 0.5	(V+) + 0.5	V
			Differential ⁽²⁾		(V+) – (V–)	
		Current ⁽³⁾			±10	mA
	Output short current ⁽⁴⁾		Continuous			
	Thermal pad voltage (DGN package)		(V–) – 1	(V–) + 30	V	
T _J	Junction temperature ⁽⁵⁾		–55	150	°C	
T _{stg}	Storage temperature		–65	150		

- (1) Stresses beyond those listed under *Absolute Maximum Ratings* may cause permanent damage to the device. These are stress ratings only, which do not imply functional operation of the device at these or any other conditions beyond those indicated under *Recommended Operating Ratings*. Exposure to absolute-maximum-rated conditions for extended periods may affect device reliability.
- (2) Input terminals are not clamped to each other with anti-parallel diodes. The JFET input stage allows large differential voltage values up to the supply voltage of the device.
- (3) Input terminals are diode-clamped to the power-supply rails. Current-limit input signals that can swing more than 0.5 V beyond the supply rails to 10 mA or less.
- (4) Short circuit to ground, one amplifier per package.
- (5) For information on device ambient and junction temperatures, see [Section 8.4.1.1](#) and [Section 7.3.11](#).

6.2 ESD Ratings

			VALUE	UNIT
V _(ESD)	Electrostatic discharge	Human body model (HBM), per ANSI/ESDA/JEDEC JS-001, all pins ⁽¹⁾	±2000	V
		Charged device model (CDM), per JEDEC specification JESD22-C101, all pins ⁽²⁾	±500	

- (1) JEDEC document JEP155 states that 500-V HBM allows safe manufacturing with a standard ESD control process.
- (2) JEDEC document JEP157 states that 250-V CDM allows safe manufacturing with a standard ESD control process.

6.3 Recommended Operating Conditions

over operating free-air temperature range (unless otherwise noted)

			MIN	NOM	MAX	UNIT
V _S	Supply voltage, (V+) – (V–)	Single supply	8		36	V
		Dual supply	±4		±18	
	Thermal pad voltage (DGN package)		(V–)		(V+) + 18	V
T _A	Ambient temperature ⁽¹⁾		–40		125	°C

- (1) For information on device ambient and junction temperatures, see [Section 8.4.1.1](#) and [Section 7.3.11](#).

6.4 Thermal Information

THERMAL METRIC ⁽¹⁾		OPA828		OPA2828	UNIT
		D (SOIC)	DGN (HVSSOP)	DGN (HVSSOP)	
		8 PINS	8 PINS	8 PINS	
R _{θJA}	Junction-to-ambient thermal resistance	121.5	56.7	49.9	°C/W
R _{θJC(top)}	Junction-to-case (top) thermal resistance	64.3	74.9	61.6	°C/W
R _{θJB}	Junction-to-board thermal resistance	65	29.2	21.8	°C/W
ψ _{JT}	Junction-to-top characterization parameter	18	3.7	1.7	°C/W
ψ _{JB}	Junction-to-board characterization parameter	64.3	29.1	21.7	°C/W

- (1) For information about traditional and new thermal metrics, see the [Semiconductor and IC Package Thermal Metrics](#) application report.

6.5 Electrical Characteristics

at $T_A = 25^\circ\text{C}$, $(V+) = 15\text{ V}$, $(V-) = -15\text{ V}$, $V_{CM} = V_O = \text{midsupply}$, $C_L = 20\text{ pF}$, and $R_L = 2\text{ k}\Omega$ connected to midsupply (unless otherwise noted)

PARAMETER		TEST CONDITIONS		MIN	TYP	MAX	UNIT
OFFSET VOLTAGE							
V_{OS}	Input offset voltage	D package	$T_A = 0^\circ\text{C to } 85^\circ\text{C}$		± 50	± 300	μV
			$T_A = -40^\circ\text{C to } +125^\circ\text{C}$			± 350	
						± 400	
		DGN package	$T_A = 0^\circ\text{C to } 85^\circ\text{C}$		± 25	± 125	
			$T_A = -40^\circ\text{C to } 125^\circ\text{C}$			± 175	
dV_{OS}/dT	Input offset voltage drift	$T_A = 0^\circ\text{C to } +85^\circ\text{C}$			± 0.3	± 1.3	$\mu\text{V}/^\circ\text{C}$
		$T_A = -40^\circ\text{C to } +125^\circ\text{C}$	D package		± 0.45	± 1.5	
PSRR	Power-supply rejection ratio	$8\text{ V} \leq V_S \leq 36\text{ V}$	DGN package		1.4	± 5.6	$\mu\text{V}/\text{V}$
			$T_A = 0^\circ\text{C to } 85^\circ\text{C}$			± 7	
			$T_A = -40^\circ\text{C to } +125^\circ\text{C}$			± 10	
INPUT BIAS CURRENT							
I_B	Input bias current	D package			± 1	± 8	pA
		DGN package			± 0.2	± 5	
		$T_A = 0^\circ\text{C to } 85^\circ\text{C}$				± 400	nA
		$T_A = -40^\circ\text{C to } +125^\circ\text{C}$				± 3	
I_{OS}	Input offset current	D package			± 1	± 8	pA
		DGN package			± 0.2	± 5	
		$T_A = 0^\circ\text{C to } 85^\circ\text{C}$				± 500	nA
		$T_A = -40^\circ\text{C to } +125^\circ\text{C}$				± 1.5	
NOISE							
E_N	Input voltage noise	$f = 0.1\text{ Hz to } 10\text{ Hz, peak-to-peak}$			0.34		μV_{PP}
		$f = 0.1\text{ Hz to } 10\text{ Hz, RMS}$			0.06		μV_{RMS}
e_N	Input voltage noise density	$f = 10\text{ Hz}$			7.5		$\text{nV}/\sqrt{\text{Hz}}$
		$f = 100\text{ Hz}$			4.8		
		$f = 1\text{ kHz}$			4		
i_N	Input current noise density	$f = 1\text{ kHz}$			1.2		$\text{fA}/\sqrt{\text{Hz}}$
INPUT VOLTAGE							
V_{CM}	Common-mode voltage			$(V-) + 2.5$		$(V+) - 3.5$	V
CMRR	Common-mode rejection ratio	$(V-) + 2.5\text{ V} < V_{CM} < (V+) - 3.5\text{ V}$	D package		108	115	dB
			DGN package		103	108	dB
		$(V-) + 2.5\text{ V} < V_{CM} < (V+) - 3.5\text{ V}$, $T_A = 0^\circ\text{C to } 85^\circ\text{C}$	D package		105		dB
			DGN package		102		dB
		$(V-) + 2.5\text{ V} < V_{CM} < (V+) - 3.5\text{ V}$, $T_A = -40^\circ\text{C to } +125^\circ\text{C}$	D package		103		dB
			DGN package		100		dB
INPUT IMPEDANCE							
Z_{ID}	Differential				$10^{12} \parallel 6$		$\Omega \parallel \text{pF}$
Z_{ICM}	Common-mode				$10^{12} \parallel 9$		$\Omega \parallel \text{pF}$

6.5 Electrical Characteristics (continued)

at $T_A = 25^\circ\text{C}$, $(V+) = 15\text{ V}$, $(V-) = -15\text{ V}$, $V_{CM} = V_O = \text{midsupply}$, $C_L = 20\text{ pF}$, and $R_L = 2\text{ k}\Omega$ connected to midsupply (unless otherwise noted)

PARAMETER		TEST CONDITIONS		MIN	TYP	MAX	UNIT	
OPEN-LOOP GAIN								
A_{OL}	Open-loop voltage gain	$(V-) + 1.6\text{ V} < V_O < (V+) - 1.6\text{ V}$, $R_L = 600\ \Omega$		120	130		dB	
		$(V-) + 1.5\text{ V} < V_O < (V+) - 1.5\text{ V}$, $R_L = 10\text{ k}\Omega$		120	130			
		$T_A = 0^\circ\text{C to } 85^\circ\text{C}$	$(V-) + 1.6\text{ V} < V_O < (V+) - 1.6\text{ V}$, $R_L = 600\ \Omega$		117			
			$(V-) + 1.5\text{ V} < V_O < (V+) - 1.5\text{ V}$, $R_L = 10\text{ k}\Omega$		118			
		$T_A = -40^\circ\text{C to } +125^\circ\text{C}$	$(V-) + 1.6\text{ V} < V_O < (V+) - 1.6\text{ V}$, $R_L = 600\ \Omega$		114			
$(V-) + 1.5\text{ V} < V_O < (V+) - 1.5\text{ V}$, $R_L = 10\text{ k}\Omega$			114					
FREQUENCY RESPONSE								
	Unity gain frequency	$V_O = 10\text{ mV}_{PP}$, $C_L = 30\text{ pF}$			45		MHz	
	Phase margin	$V_O = 10\text{ mV}_{PP}$, $C_L = 30\text{ pF}$			57		Degrees	
GBW	Gain-bandwidth product	$V_O = 10\text{ mV}_{PP}$, $C_L = 30\text{ pF}$			45		MHz	
SR	Slew rate	$V_O = 10\text{-V step}$	$G = +1$		150		V/ μs	
			$G = -1$		150			
t_s	Settling time (input to output)	$V_O = 10\text{-V step}$, $C_L = 30\text{ pF}$, $G = -1$	To $\pm 0.0244\%$ (12-bit accuracy)		110		ns	
			To $\pm 0.0061\%$ (14-bit accuracy)		120			
	Overshoot	$V_O = 100\text{-mV step}$, $G = +1$, $C_L = 30\text{ pF}$			8%			
	Overload recovery time	$G = -10$			55		ns	
THD+N	Total harmonic distortion + noise	$V_O = 3.5\text{ V}_{RMS}$, $G = +1$, $f = 1\text{ kHz}$	$R_L = 10\text{ k}\Omega$		0.000028		%	
					-130		dB	
			$R_L = 600\ \Omega$		0.000028		%	
					-130		dB	
HD2	Second-order harmonic distortion	$V_O = 5\text{ V}_{PP}$, $G = +1$	$f = 100\text{ kHz}$		119		dBc	
			$f = 500\text{ kHz}$		90			
HD3	Third-order harmonic distortion	$V_O = 5\text{ V}_{PP}$, $G = +1$	$f = 100\text{ kHz}$		125		dBc	
			$f = 500\text{ kHz}$		105			
IMD	Second-order intermodulation distortion	SMPTE/DIN two-tone, 4:1 (60 Hz and 7 kHz), $G = 1$, $V_O = 3\text{ V}_{RMS}$, $R_L = 2\text{ k}\Omega$, 9-kHz measurement bandwidth			132		dB	
	Third-order intermodulation distortion	CCIF twin-tone (19 kHz and 20 kHz), $G = 1$, $V_O = 3\text{ V}_{RMS}$, $R_L = 2\text{ k}\Omega$, 90-kHz measurement bandwidth			137		dB	
OUTPUT								
	Output voltage swing	$R_L = 10\text{ k}\Omega$			0.9	1.2	V	
		$R_L = 600\ \Omega$			1.2			
I_O	Output current	For linear operation, $A_{OL} \geq 120\text{ dB}$			± 30		mA	
I_{SC}	Short-circuit current				± 50		mA	
C_L	Capacitive load drive			See Typical Characteristics Curves			pF	
Z_O	Open-loop output impedance	$f = 1\text{ MHz}$, $I_O = 0\text{ mA}$			13.5		Ω	
POWER SUPPLY								
I_Q	Quiescent current (per amplifier)	$I_O = 0\text{ A}$			5.5	6.2	mA	
			$T_A = 0^\circ\text{C to } 85^\circ\text{C}$			7.1		
			$T_A = -40^\circ\text{C to } +125^\circ\text{C}$			7.9		

6.6 Typical Characteristics

At $T_A = 25^\circ\text{C}$, $R_L = 2\text{ k}\Omega$ connected to midsupply, and $V_{CM} = V_{OUT} = \text{midsupply}$, and $V_S = \pm 18\text{ V}$ (unless otherwise noted)

Table 6-1. Table of Graphs

DESCRIPTION	FIGURE
Input Voltage Noise Density vs Frequency	Figure 6-1
. Integrated Input Voltage Noise vs Bandwidth	Figure 6-2
Total Harmonic Distortion + Noise Ratio vs Frequency	Figure 6-3
Total Harmonic Distortion + Noise Ratio vs Output Amplitude	Figure 6-4
. 0.1-Hz To 10-Hz Noise	Figure 6-5
Offset Voltage Production Distribution	Figure 6-6, Figure 6-7
Offset Voltage Drift Production Distribution	Figure 6-8, Figure 6-9
Offset Voltage vs Common-Mode Voltage	Figure 6-10
Offset Voltage vs Power Supply Voltage	Figure 6-11
Offset Voltage vs Output Voltage	Figure 6-12
. Offset Voltage vs Temperature	Figure 6-13
Input Bias and Input Offset Current vs Common-Mode Voltage	Figure 6-14
Input Bias and Input Offset Current vs Temperature	Figure 6-15
Quiescent Current vs Output Voltage	Figure 6-16
Quiescent Current vs Temperature	Figure 6-17
Output Voltage Swing vs Output Sourcing Current	Figure 6-18
Output Voltage Swing vs Output Sinking Current	Figure 6-19
Power-Supply Rejection Ratio vs Frequency	Figure 6-20
Common-Mode Rejection Ratio vs Frequency	Figure 6-21
Power-Supply Rejection Ratio vs Temperature	Figure 6-22
Common-Mode Rejection Ratio vs Temperature	Figure 6-23
Open-Loop Gain and Phase vs Frequency	Figure 6-24
Closed-Loop Gain vs Frequency	Figure 6-25
Open-Loop Gain vs Temperature	Figure 6-26
Open-Loop Output Impedance vs Frequency	Figure 6-27
Small-Signal Overshoot vs Capacitive Load, Gain = +1	Figure 6-28
Small-Signal Overshoot vs Capacitive Load, Gain = -1	Figure 6-29
No Phase Reversal	Figure 6-30
Positive Overload Recovery	Figure 6-31
Negative Overload Recovery	Figure 6-32
. Small-Signal Step Response	Figure 6-33
Large-Signal Step Response	Figure 6-34
12-bit, 14-bit Settling Time	Figure 6-35, Figure 6-36
Short-Circuit Current vs Temperature	Figure 6-37
Slew Rate vs Temperature	Figure 6-38
Slew Rate vs Output Step Size	Figure 6-39
Maximum Output Voltage vs Frequency	Figure 6-40
Intermodulation Distortion	Figure 6-41
Electromagnetic Interference Rejection	Figure 6-42
Harmonic Distortion vs Frequency	Figure 6-43
Channel Separation	Figure 6-44

6.6 Typical Characteristics (continued)

At $T_A = 25^\circ\text{C}$, $R_L = 2\text{ k}\Omega$ connected to midsupply, and $V_{CM} = V_{OUT} = \text{midsupply}$, and $V_S = \pm 18\text{ V}$ (unless otherwise noted)

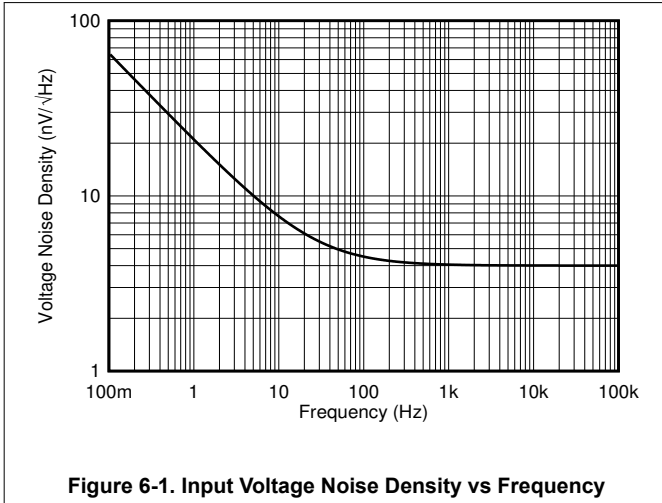

Figure 6-1. Input Voltage Noise Density vs Frequency

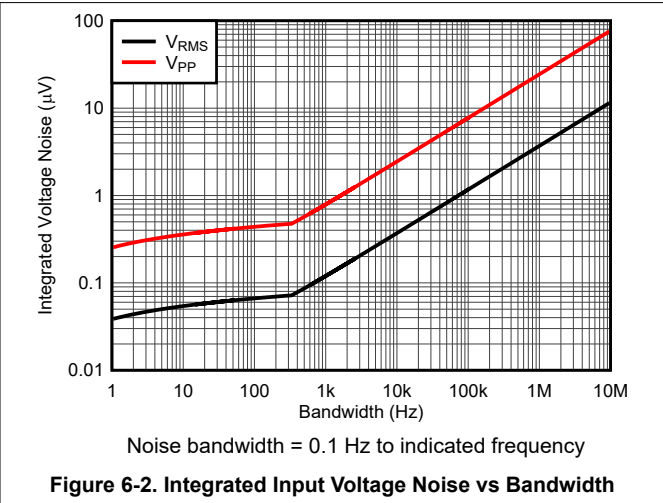

Figure 6-2. Integrated Input Voltage Noise vs Bandwidth

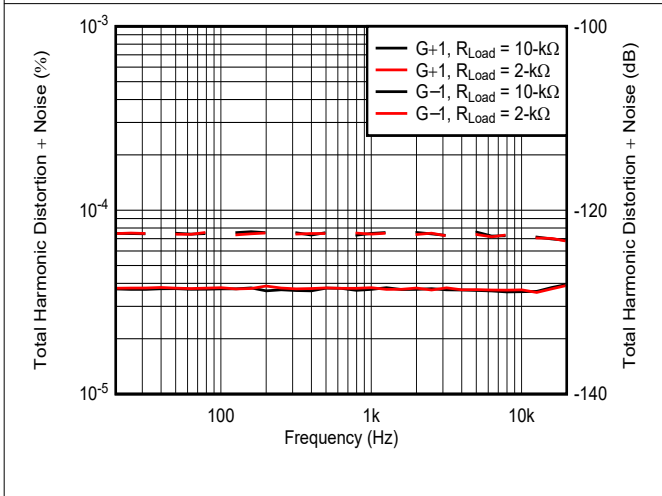

Figure 6-3. Total Harmonic Distortion + Noise Ratio vs Frequency

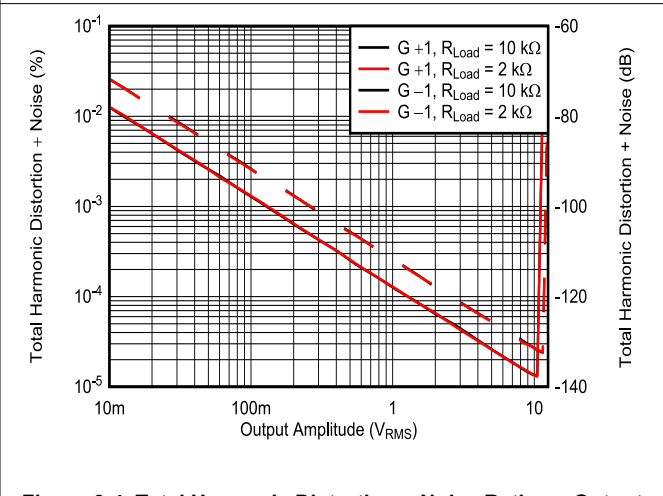

Figure 6-4. Total Harmonic Distortion + Noise Ratio vs Output Amplitude

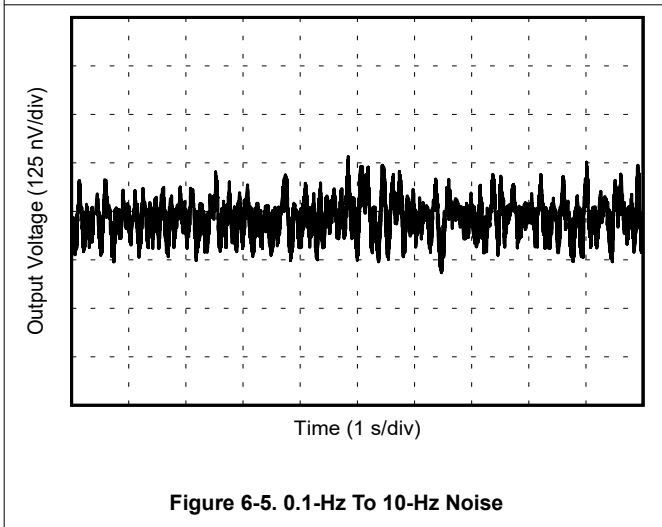

Figure 6-5. 0.1-Hz To 10-Hz Noise

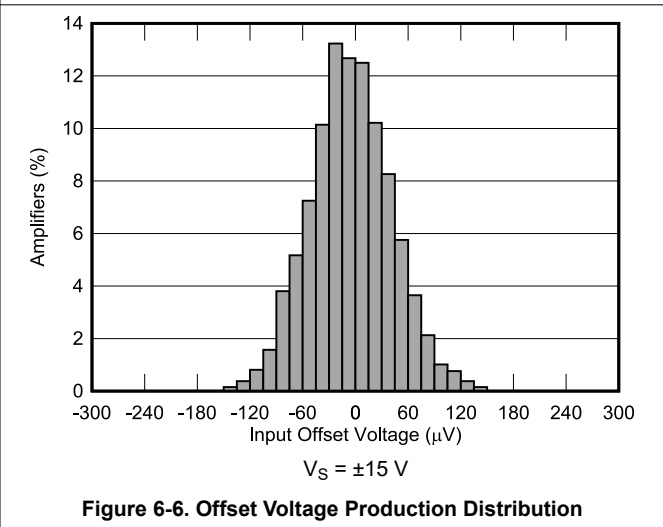

Figure 6-6. Offset Voltage Production Distribution

6.6 Typical Characteristics (continued)

At $T_A = 25^\circ\text{C}$, $R_L = 2\text{ k}\Omega$ connected to midsupply, and $V_{CM} = V_{OUT} = \text{midsupply}$, and $V_S = \pm 18\text{ V}$ (unless otherwise noted)

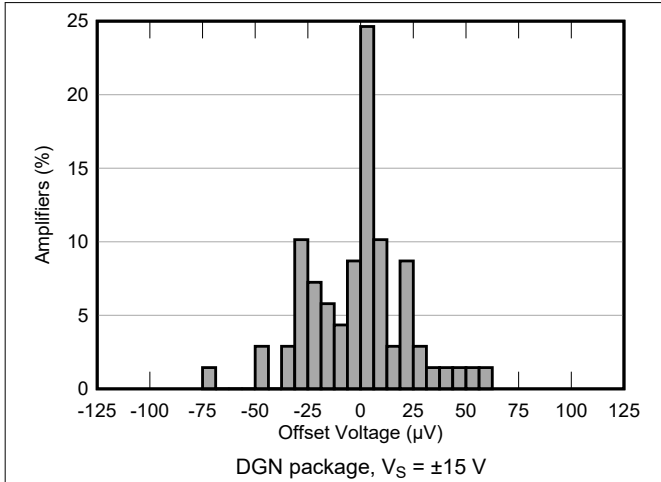

Figure 6-7. Offset Voltage Production Distribution

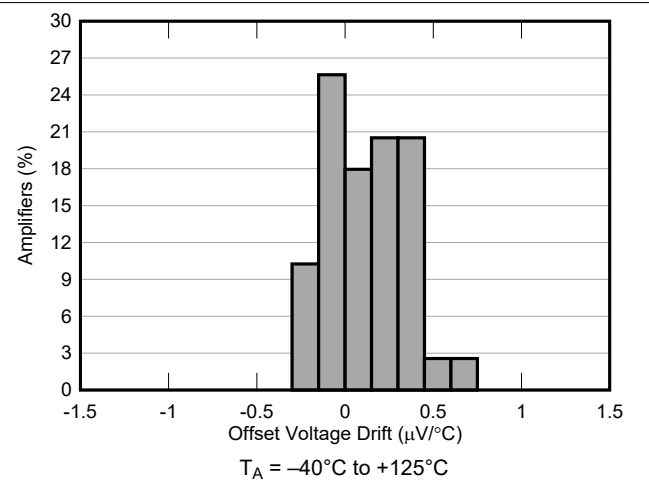

Figure 6-8. Offset Voltage Drift Production Distribution

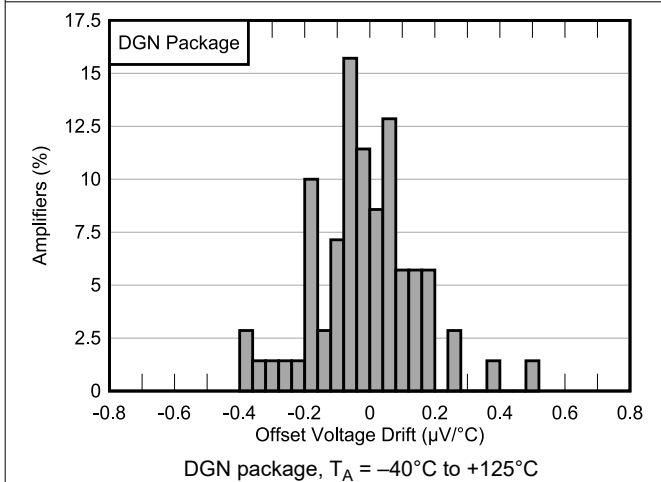

Figure 6-9. Offset Voltage Drift Production Distribution

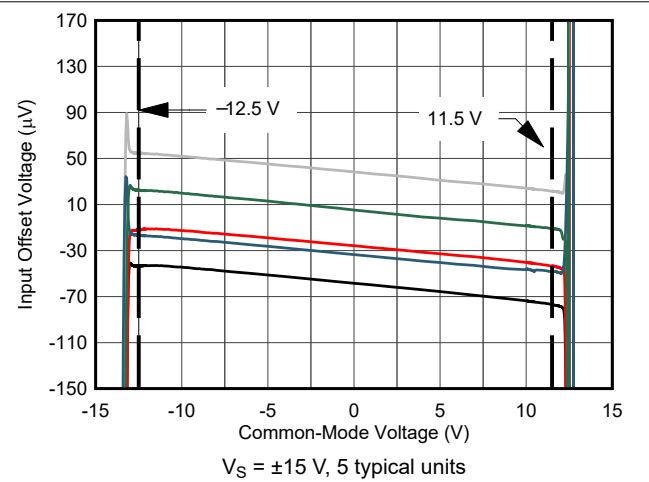

Figure 6-10. Offset Voltage vs Common-Mode Voltage

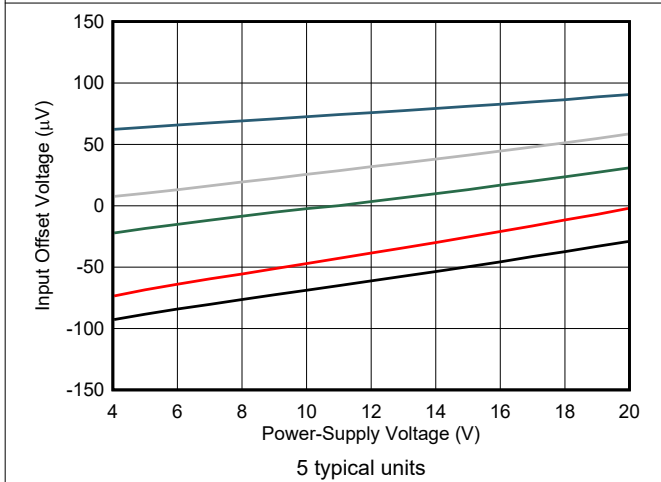

Figure 6-11. Offset Voltage vs Power Supply Voltage

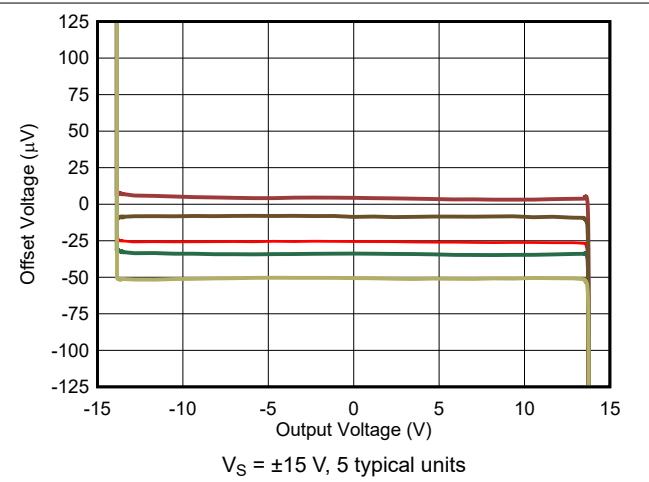
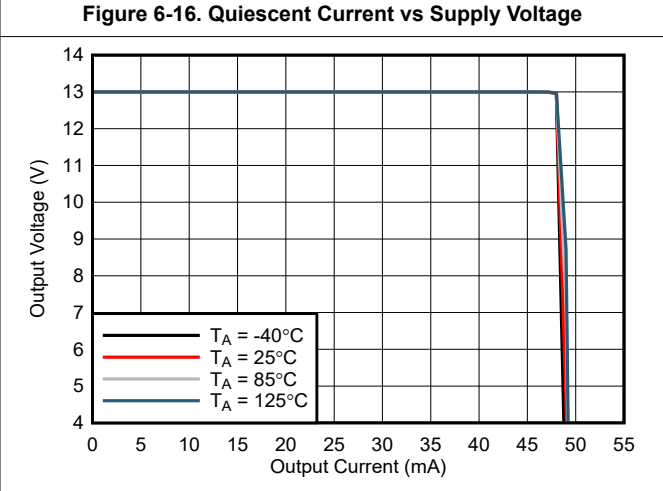
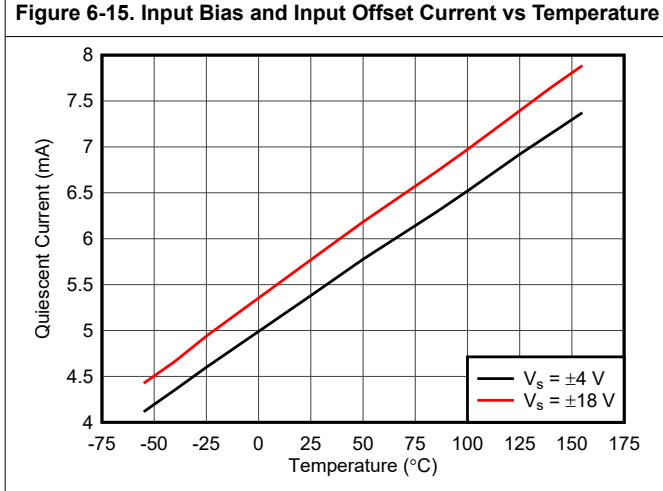
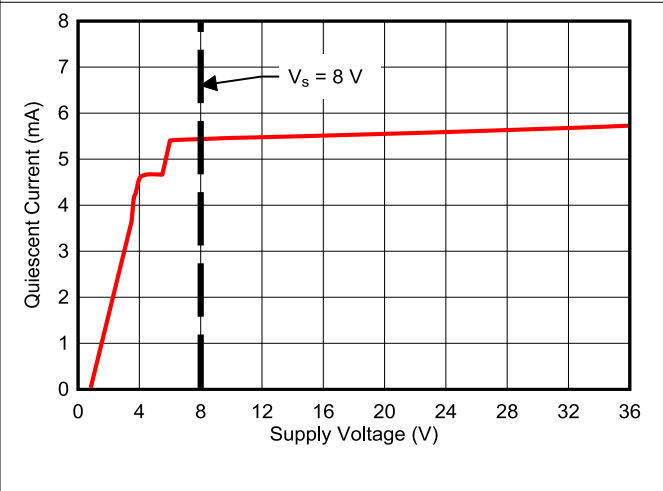
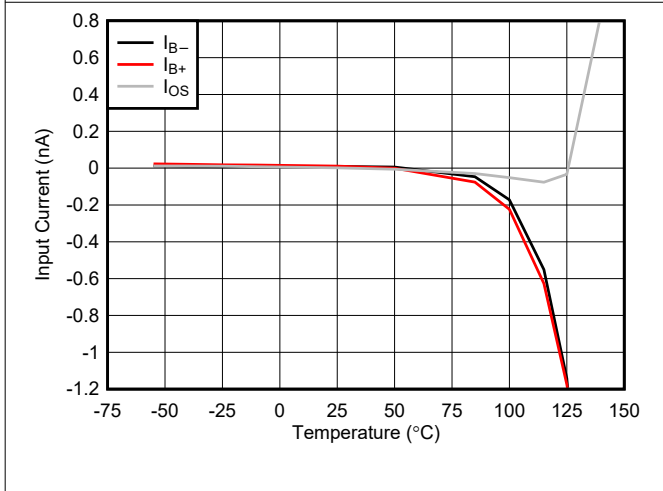
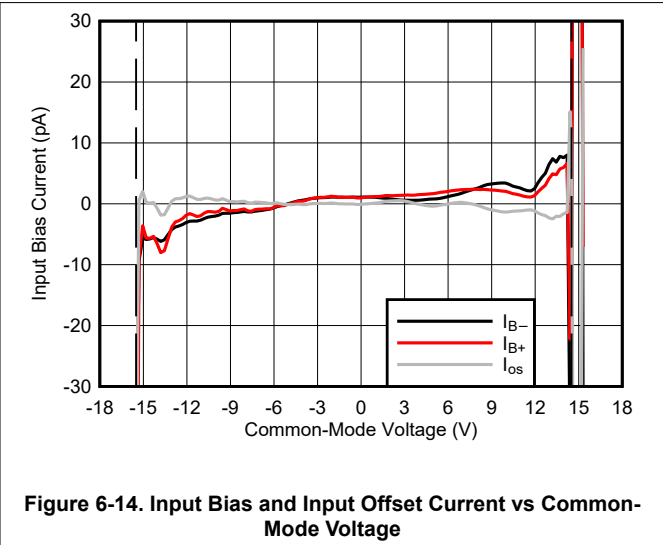
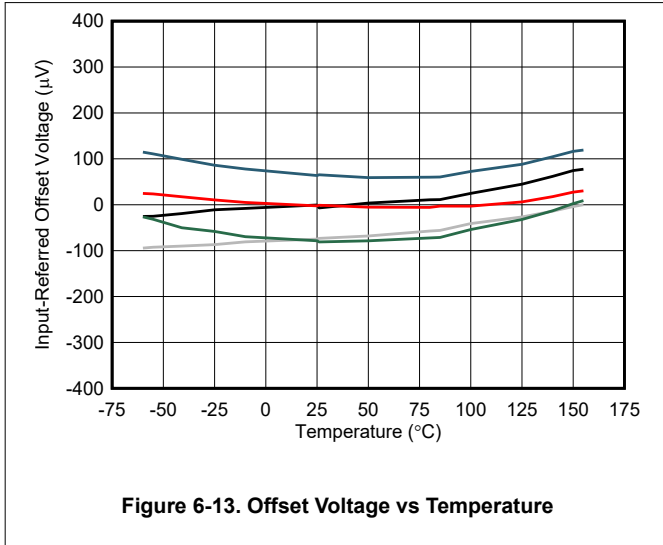

Figure 6-12. Offset Voltage vs Output Voltage

6.6 Typical Characteristics (continued)

At $T_A = 25^\circ\text{C}$, $R_L = 2\text{ k}\Omega$ connected to midsupply, and $V_{CM} = V_{OUT} = \text{midsupply}$, and $V_S = \pm 18\text{ V}$ (unless otherwise noted)



6.6 Typical Characteristics (continued)

At $T_A = 25^\circ\text{C}$, $R_L = 2\text{ k}\Omega$ connected to midsupply, and $V_{CM} = V_{OUT} = \text{midsupply}$, and $V_S = \pm 18\text{ V}$ (unless otherwise noted)

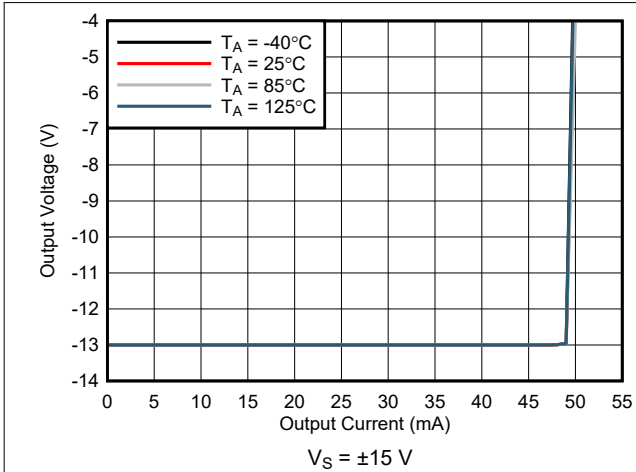

Figure 6-19. Output Voltage Swing vs Output Sinking Current

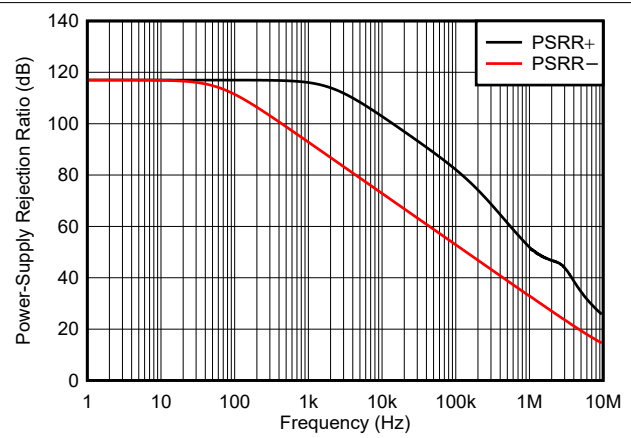

Figure 6-20. Power-Supply Rejection Ratio vs Frequency

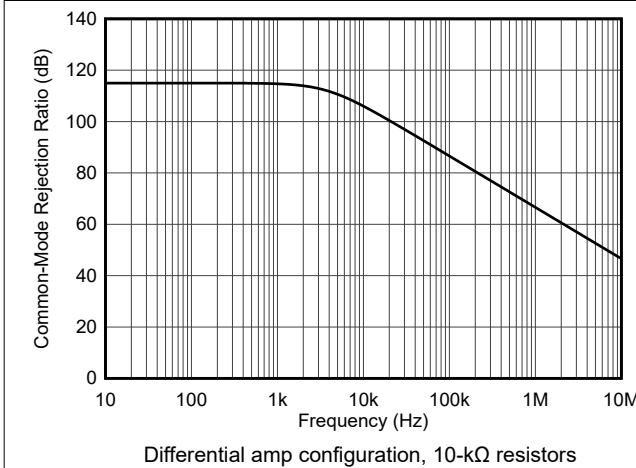

Figure 6-21. Common-Mode Rejection Ratio vs Frequency

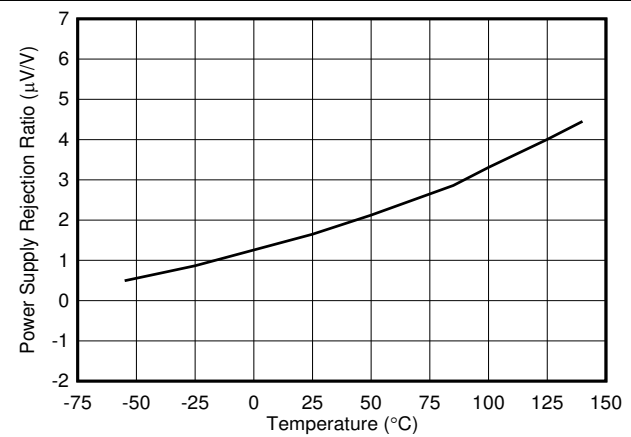

Figure 6-22. Power-Supply Rejection Ratio vs Temperature

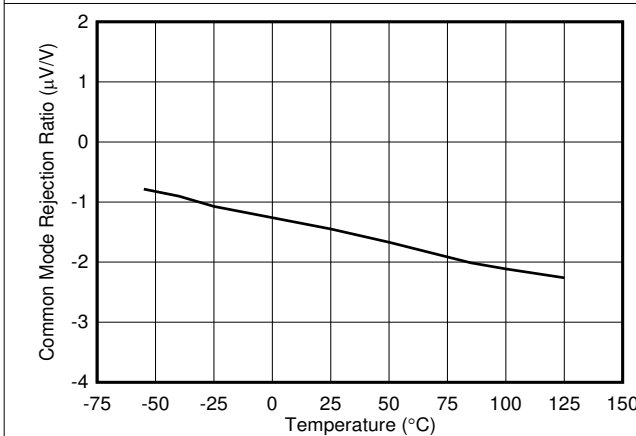

Figure 6-23. Common-Mode Rejection Ratio vs Temperature

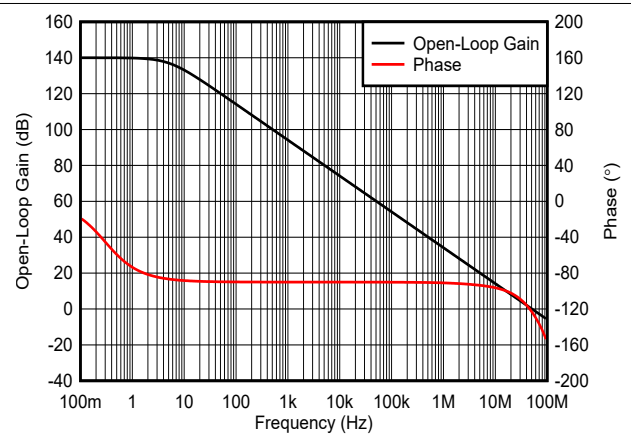

Figure 6-24. Open-Loop Gain and Phase vs Frequency

6.6 Typical Characteristics (continued)

At $T_A = 25^\circ\text{C}$, $R_L = 2\text{ k}\Omega$ connected to midsupply, and $V_{CM} = V_{OUT} = \text{midsupply}$, and $V_S = \pm 18\text{ V}$ (unless otherwise noted)

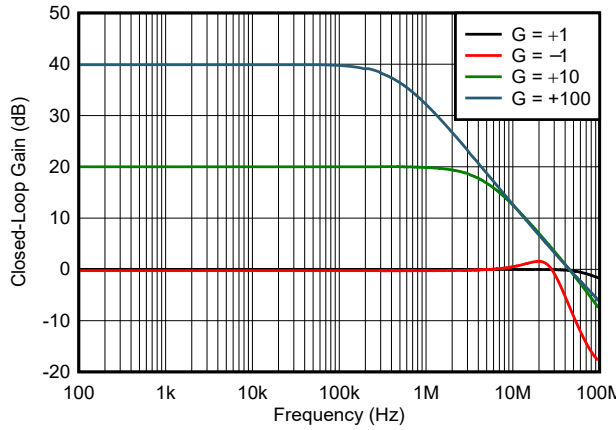

Figure 6-25. Closed-Loop Gain vs Frequency

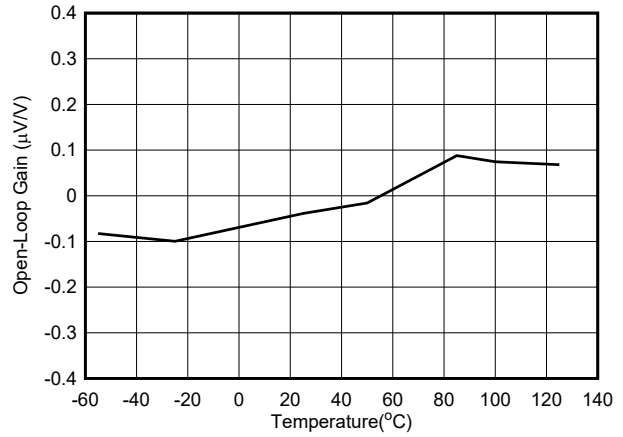

Figure 6-26. Open-Loop Gain vs Temperature

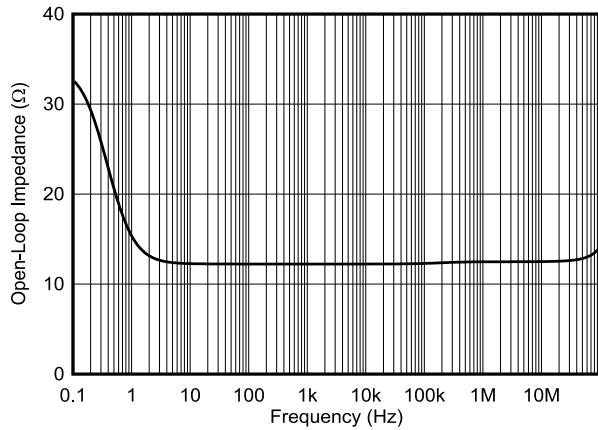

Figure 6-27. Open-Loop Output Impedance vs Frequency

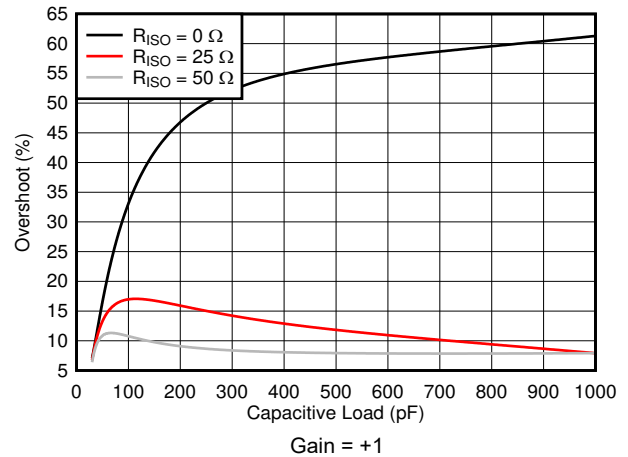

Figure 6-28. Small-Signal Overshoot vs Capacitive Load

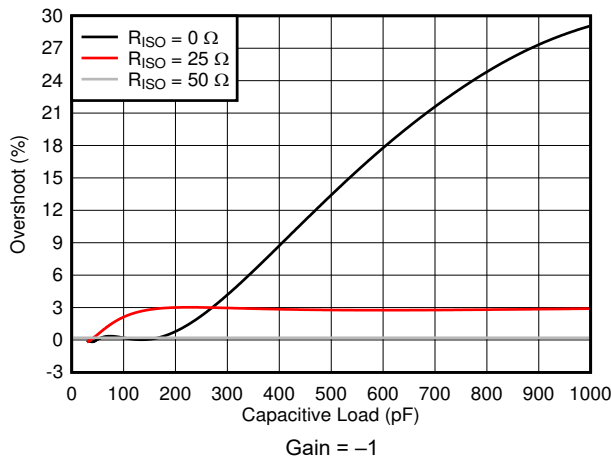

Figure 6-29. Small-Signal Overshoot vs Capacitive Load

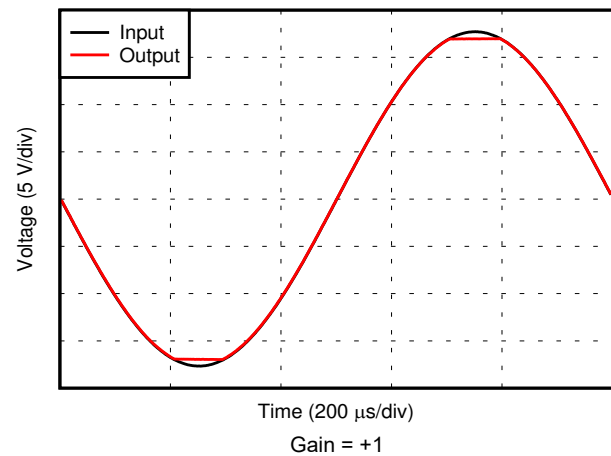
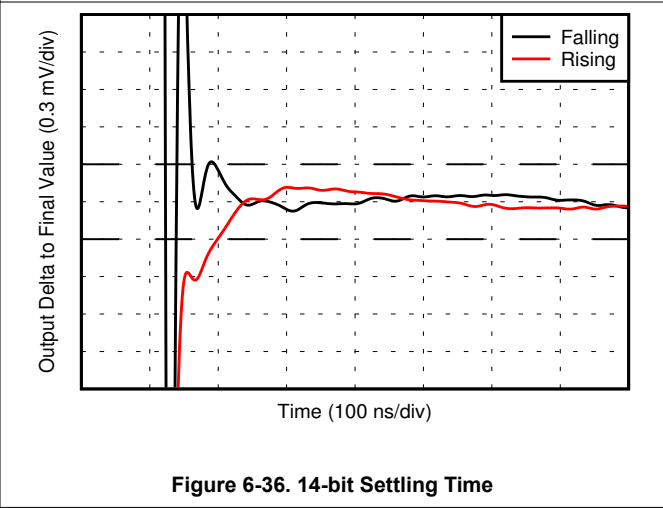
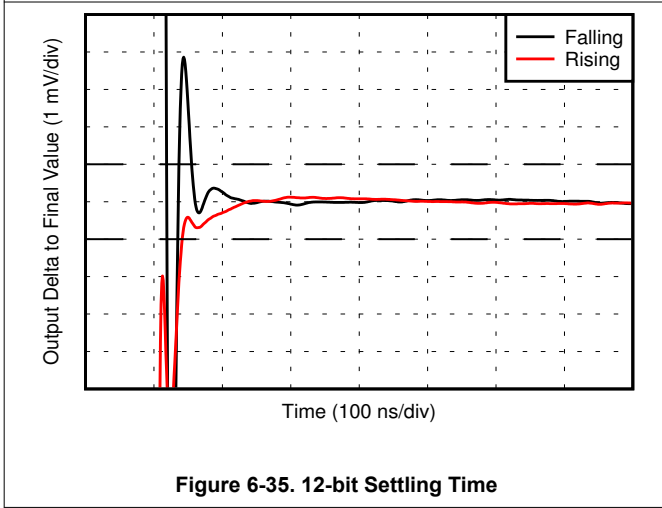
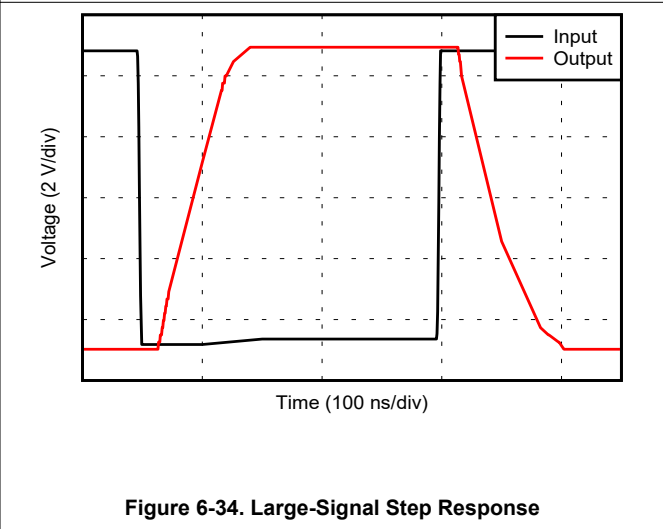
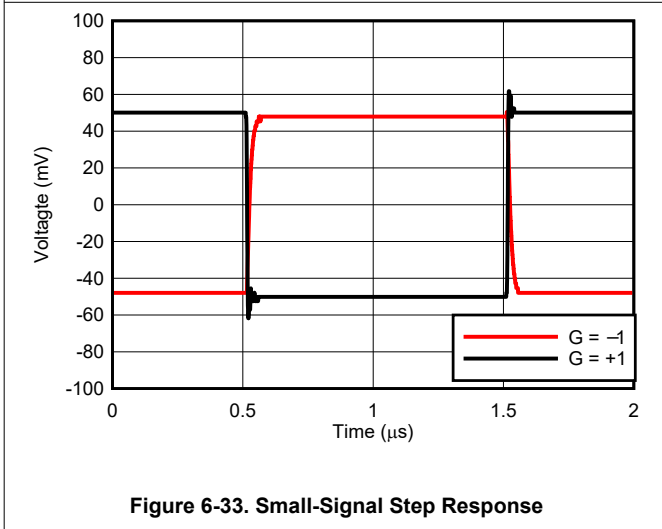
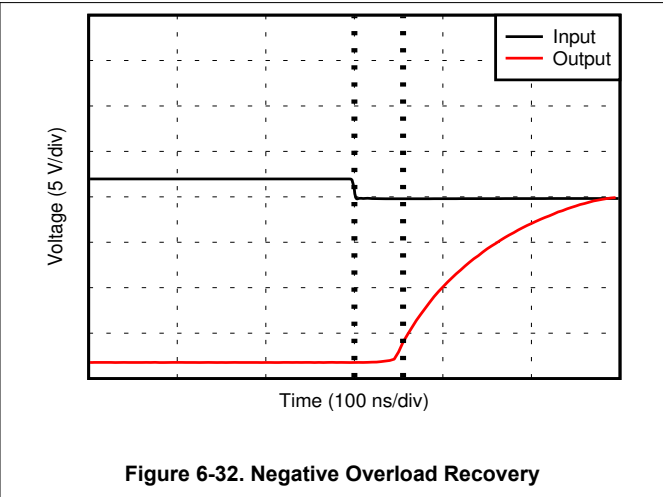
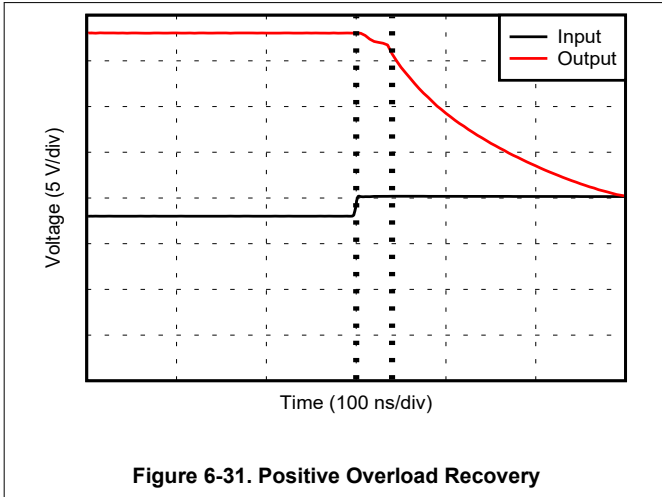

Figure 6-30. No Phase Reversal

6.6 Typical Characteristics (continued)

At $T_A = 25^\circ\text{C}$, $R_L = 2\text{ k}\Omega$ connected to midsupply, and $V_{CM} = V_{OUT} = \text{midsupply}$, and $V_S = \pm 18\text{ V}$ (unless otherwise noted)



6.6 Typical Characteristics (continued)

At $T_A = 25^\circ\text{C}$, $R_L = 2\text{ k}\Omega$ connected to midsupply, and $V_{CM} = V_{OUT} = \text{midsupply}$, and $V_S = \pm 18\text{ V}$ (unless otherwise noted)

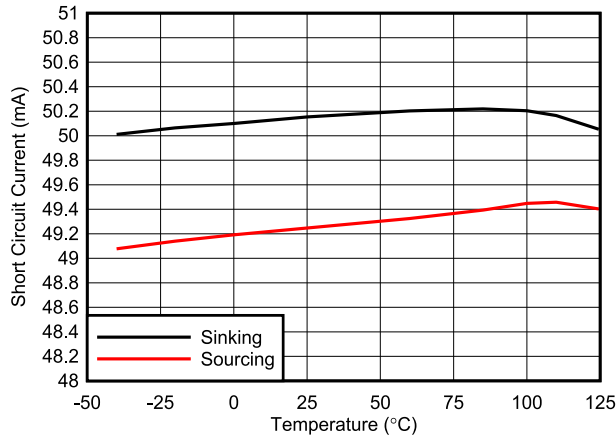

Figure 6-37. Short-Circuit Current vs Temperature

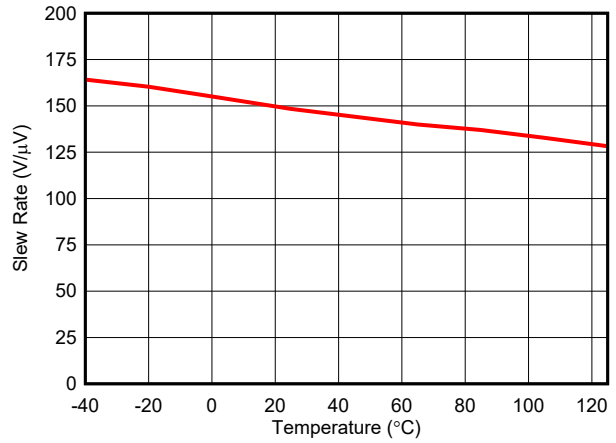

Figure 6-38. Slew Rate vs Temperature

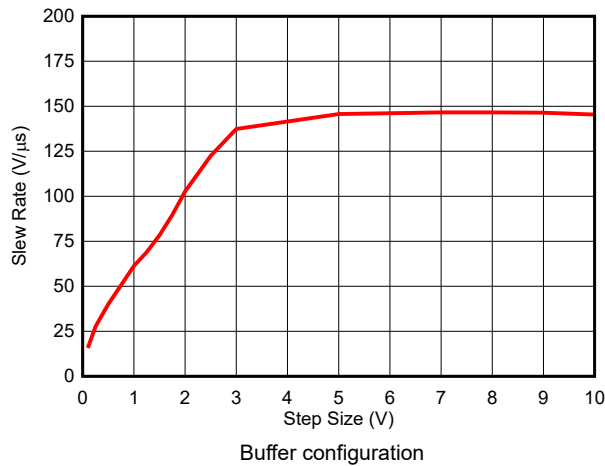

Figure 6-39. Slew Rate vs Output Step Size

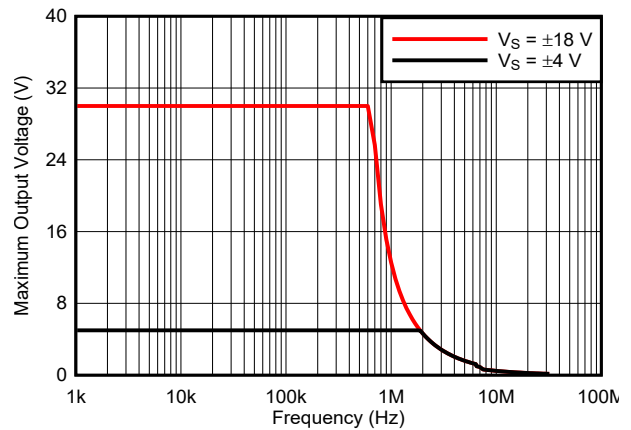

Figure 6-40. Maximum Output Voltage vs Frequency

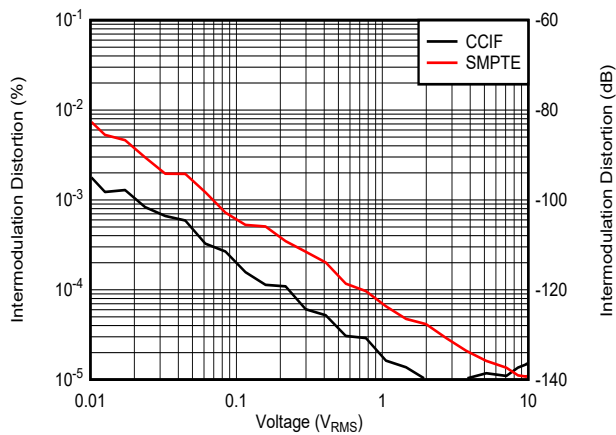

Figure 6-41. Intermodulation Distortion

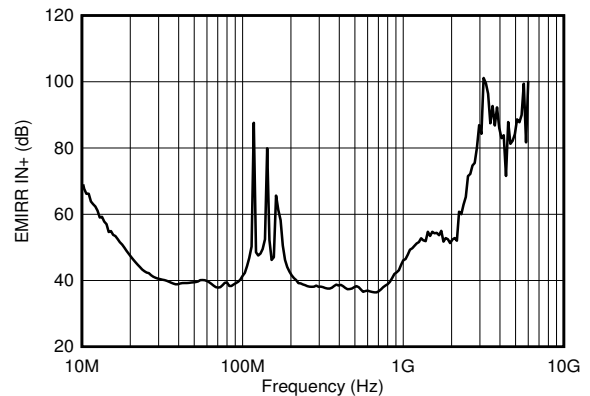
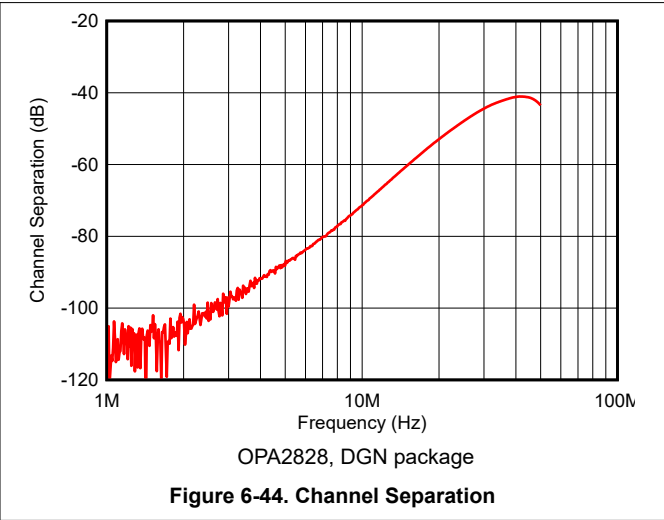
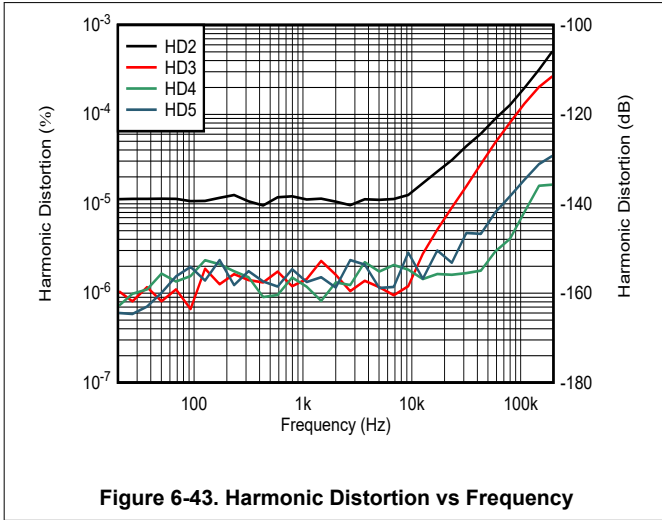

Figure 6-42. Electromagnetic Interference Rejection

6.6 Typical Characteristics (continued)

At $T_A = 25^\circ\text{C}$, $R_L = 2\text{ k}\Omega$ connected to midsupply, and $V_{CM} = V_{OUT} = \text{midsupply}$, and $V_S = \pm 18\text{ V}$ (unless otherwise noted)



7 Detailed Description

7.1 Overview

The OPAx828 are low-noise, high-speed JFET input amplifiers that provide the highest levels of precision and accuracy. Each device is laser trimmed in production to provide the lowest input-referred offset voltage. Likewise, the input-referred offset voltage drift is trimmed and specified over the junction temperature range of -40°C to $+125^{\circ}\text{C}$. Each device also has the quiescent current laser trimmed to minimize part-to-part variations for dynamic parameters such as input-referred noise voltage, gain-bandwidth product, slew rate, and settling time. The combination of low-noise, dc precision, and dynamic performance of the OPAx828 is unsurpassed in the industry with the OPAx828 taking full advantage of the latest and most advanced high-voltage, SiGe-complementary, JFET-bipolar process technology.

7.2 Functional Block Diagram

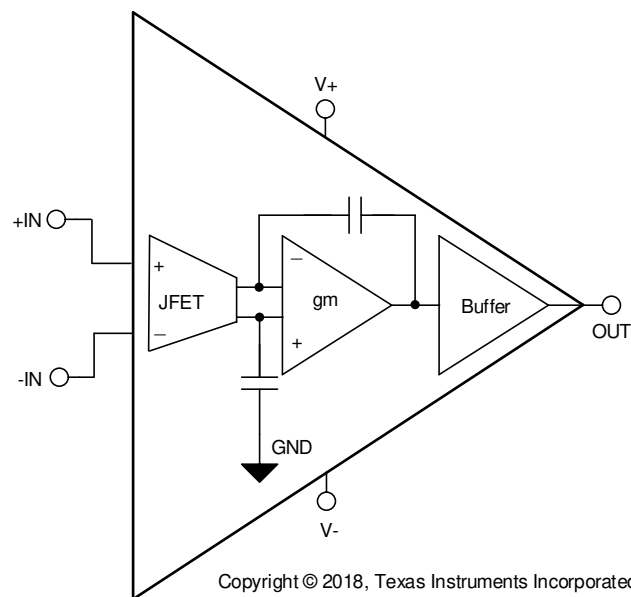

7.3 Feature Description

7.3.1 Phase-Reversal Protection

Many operational amplifiers exhibit a phase reversal when the input drives beyond the specified input common-mode range. This condition is most often encountered in noninverting circuits when the input drives beyond the specified common-mode voltage range, which can cause the output to reverse into the opposite rail. The OPAx828 have an internal phase-reversal protection circuitry. The input architecture of the OPAx828 prevents phase reversal with input common-mode voltages that exceed the specified maximum and minimum values. The OPAx828 output limits to the appropriate rail. [Figure 7-1](#) shows this performance. When input voltages can exceed the minimum or maximum specified limits, make sure to limit the maximum input current through internal ESD protection diodes.

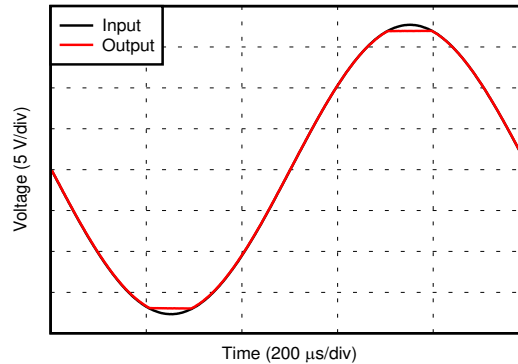
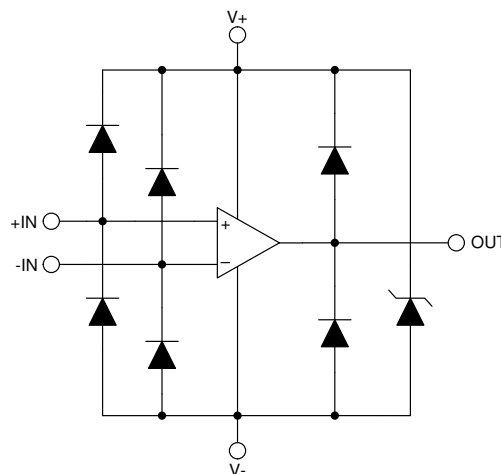

Figure 7-1. No Phase Reversal

7.3.2 Electrical Overstress

The OPAx828 are internally protected against electrostatic discharge (ESD) events that can occur during manufacturing, handling, or printed-circuit-board (PCB) assembly. The internal ESD protection diodes are not intended to protect the OPAx828 during normal operation when the devices are operating under power. The ESD protection circuitry involves several current-steering diodes connected from the input and output pins and routed back to the internal power-supply lines, where the diodes meet at the power-supply ESD cell, an absorption device, internal to the operational amplifiers. This protection circuitry is intended to remain inactive during normal circuit operation. In cases where the inputs or output can be driven above the positive power supply or below the negative power supply, make sure to limit the current through the internal diodes to 10 mA or less. In harsh electrical environments, external protection circuitry can be required depending on the application requirements and environmental conditions.



Copyright © 2018, Texas Instruments Incorporated

Figure 7-2. Equivalent Internal ESD Circuitry

Figure 7-3 illustrates one example of protecting the OPAx828 inputs against an input overvoltage condition. In this example, the noninverting inputs to the OPAx828 are protected with the addition of an external resistor. If the input voltage, V_{IN} , exceeds either power supply voltage, the input ESD diodes become forward biased at approximately 0.5 V. Limit the current through the forward-biased internal ESD diodes under such conditions; see Section 6.1. Figure 7-3 illustrates a specific example where the addition of the input resistor provides the necessary current limiting and allows for input voltages at V_{IN} up to ± 25.5 V. Assuming a symmetrical, dual power-supply configuration, the maximum input voltage for this circuit configuration can be determined from the following equation:

$$\pm |V_{IN}| = |V_S| + 0.5V + 10mA \times R_{IN} \quad (1)$$

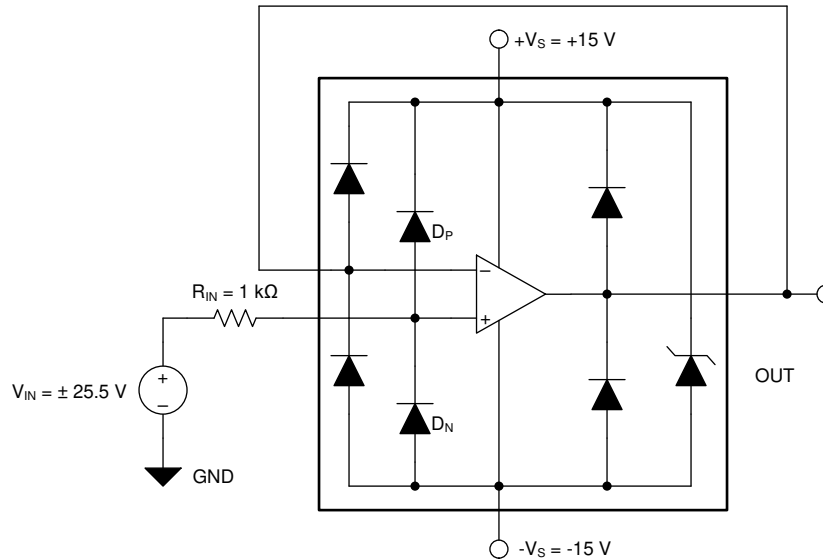

Copyright © 2018, Texas Instruments Incorporated

Figure 7-3. Limiting the Input Current

Adding a series input protection resistor adds an additional source of noise to the circuit. Resistance values less than 250 Ω contribute less than 10% of additional noise. A resistance value of 1 k Ω increases the noise by approximately by 40%. The OPAx828 have an equivalent input noise resistance of approximately 1 k Ω .

7.3.3 MUX Friendly Inputs

Multiplexing is a frequently-used technique to perform data acquisition in multichannel systems with minimal signal-chain requirements. In this context, the role of the multiplexer (MUX) in an acquisition system is to switch between channels and send each signal as fast as possible to a single data converter, maximizing system throughput and minimizing delay. To provide accurate processing, a precision amplifier is placed downstream from the multiplexer to precisely drive the analog-to-digital converter (ADC). [Figure 7-4](#) illustrates this concept.

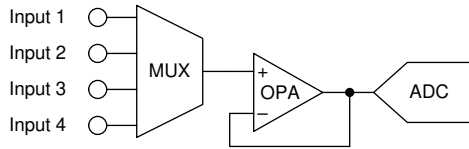

Copyright © 2018, Texas Instruments Incorporated

Figure 7-4. Typical Multiplexed System Block Diagram

In a typical multiplexed application, large transient voltages can often be presented to the input of the op amp driving the ADC. Large input differential voltages are commonly seen during slewing or open-loop operation, which is especially common when switching from one MUX input to another. Traditional precision amplifiers often consist of a differential transistor pair that is protected from large differential transient input voltages with antiparallel diodes between the inputs of the amplifier. These antiparallel diodes are effective at limiting the voltage differential between the inputs to one or two forward diode voltage drops, which protects the precision input devices from damage. However, the antiparallel diodes do have considerable drawbacks such as large inrush currents when turned on. If passive filtering or high source impedance is present, large inrush current can disturb settling time, limiting the throughput of the system and degrading signal-chain precision. The OPAx828 do not need antiparallel diodes to protect the input JFET transistors and are free from large inrush currents, even with differential input voltages as large as ± 18 V. These concepts are illustrated in [Figure 7-5](#).

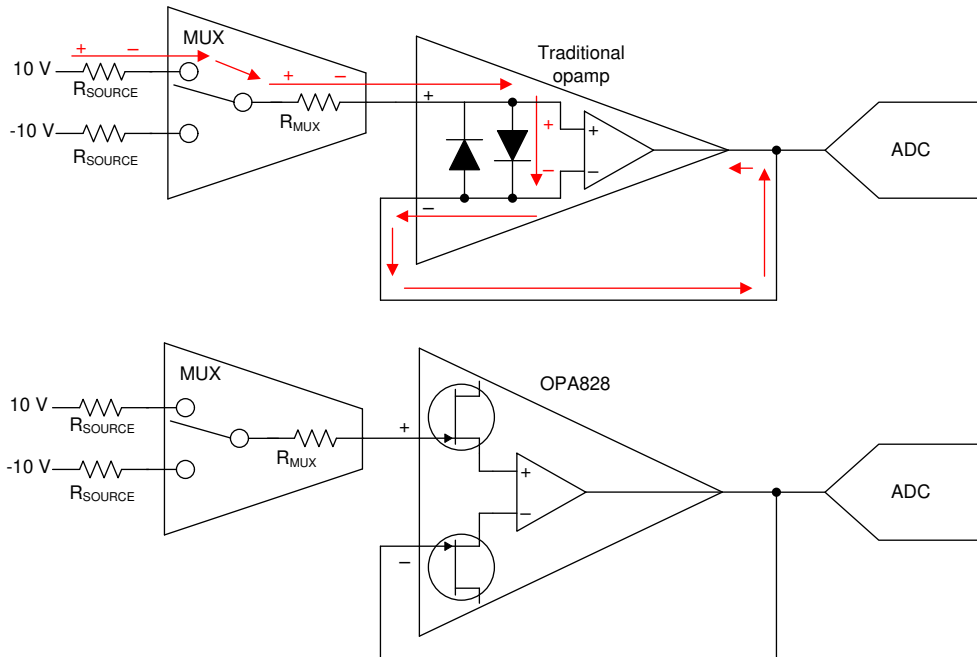

Copyright © 2018, Texas Instruments Incorporated

Figure 7-5. Typical Multiplexed System Block Diagram

7.3.4 Overload Power Limiter

Many applications have tight limits on op-amp power consumption; therefore, amplifier power consumption must remain constant, even during fault conditions such as a large voltage across the inputs or the output hitting the rail. In particular, high slew-rate amplifiers such as the OPAx828 temporarily increase the supply current when the amplifier is slewing. In slew-booster amplifiers, the presence of a large input signal can present a specific problem because the large input signal applies a large voltage across the amplifier inputs. This large voltage across the inputs activates the slew-boost and can lead to a significant increase in current consumption. At high supply voltages, the large current consumption can lead to significant amplifier self-heating.

The OPAx828 offer a high slew rate of 150 V/us in combination with a low supply current of 5.5 mA. Like many other amplifiers, these characteristics are achieved by a *slew-boosting* method, which temporarily increases the amplifier current consumption when the amplifier is slewing. Such a slewing condition is detected by measuring the voltage across the input pins. In a quiescent condition, this voltage is very small (equal to the amplifier offset). Alternatively, if an input voltage is changed rapidly, a large voltage is applied across the inputs and the amplifier output must slew. On the OPAx828, the supply current increase is gradual and proportional to the applied input voltage, providing a *well-behaved* large step response and excellent THD. The high slew rate makes sure the output resettles in less than about 300 ns; therefore, the increased power consumption is absorbed by the decoupling capacitors, and does not additionally load the power supplies.

In the OPAx828, such an increase in current consumption is avoided by an additional protection circuit that continuously monitors both the amplifier inputs and output. If a large input voltage is detected, the protection circuit checks for the presence of a rapid change in voltage at the output. If the output voltage is not changing (for example, because the output is at supply rails), the protection circuit disables the slew-boost circuit after a delay of approximately 300 ns. After the overload condition is removed, the amplifier rapidly recovers to a normal operating condition. This operation is shown in Figure 7-6, where the amplifiers supply current is measured with decoupling capacitors removed. After 300 ns, the power consumption of the amplifier returns to quiescent levels. At the same time, the amplifier still has an excellent overload recovery time of < 55 ns.

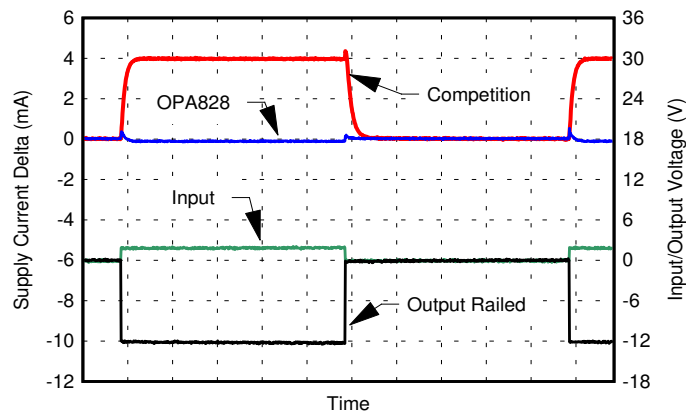

Figure 7-6. Supply Current Change With Overloaded Output

7.3.5 Noise Performance

Figure 7-7 shows the total circuit noise for varying source impedances with the operational amplifier in a unity-gain configuration (with no feedback resistor network and therefore no additional noise contributions). The OPA828 and OPA211 are shown with total circuit noise calculated. The op amp contributes both a voltage noise component and a current noise component. The voltage noise is commonly modeled as a time-varying component of the offset voltage. The current noise is modeled as the time-varying component of the input bias current and reacts with the source resistance to create a voltage component of noise. Therefore, the lowest noise op amp for a given application depends on the source impedance. For low source impedance, current noise is negligible, and voltage noise generally dominates. The OPAx828 devices have both low voltage noise and extremely low current noise because of the FET input of the op amps. As a result, the current noise contribution of the OPAx828 is negligible for any practical source impedance, which makes the OPAx828 an excellent choice for applications with high source impedance.

Equation 2 provides a simple calculation for total noise, E_O , of a unity gain buffer op amp circuit:

$$E_O = \sqrt{e_N^2 + (i_N \times R_S)^2 + 4kTR_S} \tag{2}$$

where

- e_N = voltage noise
- i_N = current noise
- R_S = source impedance
- k = Boltzmann's constant = 1.38×10^{-23} J/K
- T = temperature in kelvins (K)

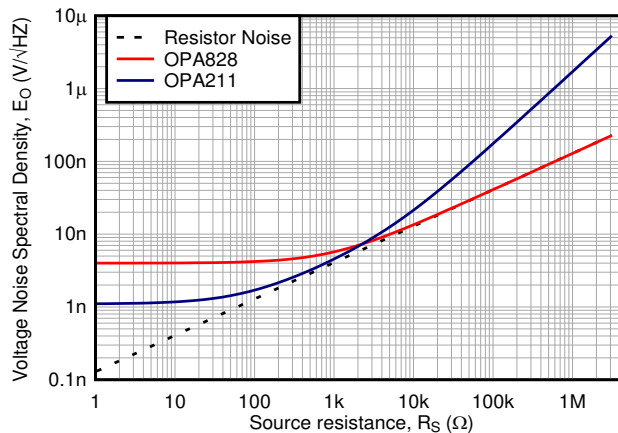

Figure 7-7. Noise Performance of the OPA828 and OPA211 in Unity-Gain Buffer Configuration

7.3.5.1 Low Noise

The OPAx828 are fabricated on a state-of-the-art SiGe precision, high-speed, high-voltage, BiFET wafer process. Patented wafer processing techniques are used to reduce the noise associated with the JFET gate regions. Figure 7-8 shows OPAx828 the noise spectral density.

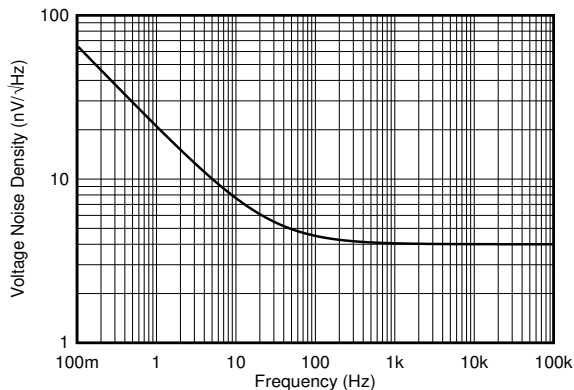

Figure 7-8. Noise Spectral Density vs Frequency

7.3.6 Capacitive Load and Stability

The dynamic characteristics of the OPAx828 are optimized for common operating conditions. The combination of low closed-loop gain and high capacitive loads decreases the phase margin of the amplifiers and can lead to gain peaking or oscillations. As a result, heavier capacitive loads must be isolated from the output. The simplest way to achieve this isolation is to add a small resistor (for example, R_{OUT} equal to 50 Ω) in series with the output. The Figure 7-9 graph show small-signal overshoot versus capacitive load. See [Feedback Plots Define Op Amp AC Performance](#) for details of analysis techniques and application circuits.

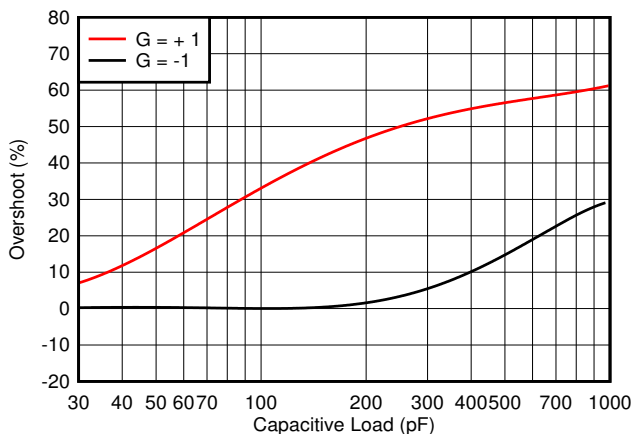

Figure 7-9. Small-Signal Overshoot vs Capacitive Load

7.3.7 Settling Time

Settling time is a measure of an amplifier output to settle to within some percentage (error band) of the input amplitude and is used to describe an amplifier response to a step input. An amplifier settling time is comprised of both a large signal response and small signal response. The large signal response is characterized by the rise and fall times, whereas the small signal response is characterized by overshoot and ringing. [Figure 7-10](#) illustrates the concepts and terminology associated with an amplifier settling time. Specifically, the settling time is defined as the time the output takes to settle to within a specified error band from the time the input signal was applied.

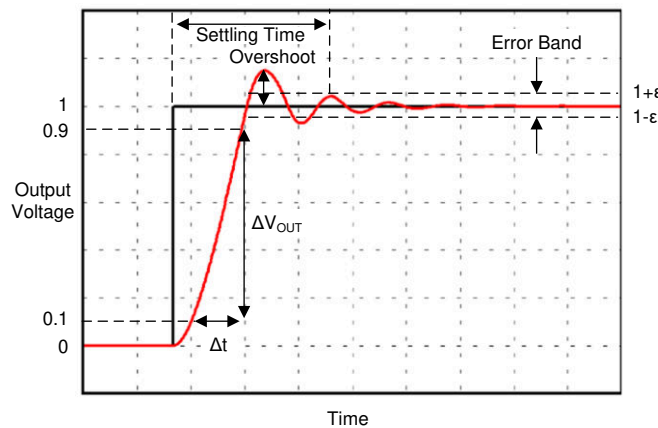

Figure 7-10. Settling Time

The OPAx828 minimize settling time for high-resolution systems in two ways. First, by incorporating an internal slew-boost circuit that minimizes rise and fall times, Second, by having wide bandwidth with excellent phase margin with low ringing, enabling small signal settling in minimal time. The OPAx828 are trimmed in laser production that minimizes part-to-part variation in the device slew rate, bandwidth, and phase margin, thus mainlining excellent unit-to-unit variations across all manufacturing lots.

7.3.8 Slew Rate

The parameter of an amplifier that best describes the large-signal dynamic behavior is the slew rate. Slew rate is a measure of the maximum rate of change of the output voltage with respect to time, and is generally expressed in units of volts-per-microsecond, (V/μs). Typically, the slew rate is measured as the time for the output to swing from 10% of the final value to 90% of the final value. The slew rate for the signal illustrated in [Figure 7-10](#) is given by [Equation 3](#).

$$Slew\ Rate = \frac{\Delta V_{OUT}}{\Delta t} = \frac{(V_{OUT_{90}} - V_{OUT_{10}})}{(t_{90} - t_{10})} \quad (3)$$

The slew rate of an amplifier is limited by the internal architecture of the amplifier, the amplifier quiescent power and internal capacitances. The OPAx828 maximize the slew rate by incorporating a slew-boost circuit. The proprietary slew boost circuit used in the OPAx828 results in a very high slew rate while maintaining low quiescent power levels. The internal slew boost circuit measures the input differential voltage present between the +IN and –IN input pins. If this input differential voltage is sufficiently large enough, the internal slew-boost circuit increases the internal biasing currents of the amplifier, thereby increasing the ability of the output to slew faster. To provide optimal dynamic performance, place power-supply bypass capacitors close to the OPAx828.

If the inputs of the amplifier have a large static or dc differential voltage present, the OPAx828 recognize that condition; not as an indicator of the need to slew faster, but rather as an overload condition. In this case, the OPAx828 internal biasing currents do not increase, and the quiescent current remains unchanged from normal operation.

7.3.9 Full-Power Bandwidth

The full-power bandwidth of an amplifier describes the frequency at which the largest sinusoidal signal the amplifier can provide at the output before slew rate induced distortion becomes a dominant source of error. Figure 7-11 illustrates this concept.

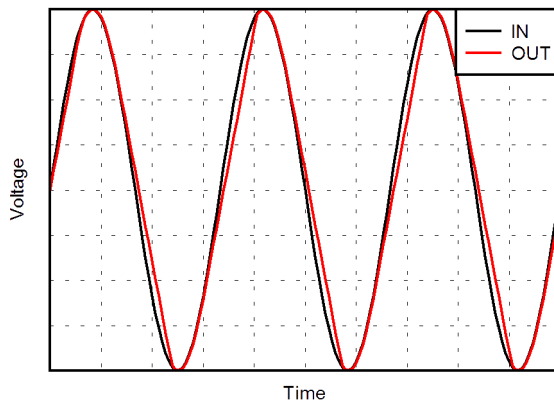

Figure 7-11. Slew Rate Induced Distortion

If the inputs of the amplifier are driven too far apart (such as when a multiplexer connected to the inverting input changes channels), a slew boost circuit is enabled to help settling time, but can distort the signal. If low distortion is needed, avoid driving the inputs too far apart from each other. The OPAx828 have a full power bandwidth of 1.2 MHz with 10-V_{PEAK} output voltage. Figure 7-12 illustrates the maximum output voltage as a function of frequency.

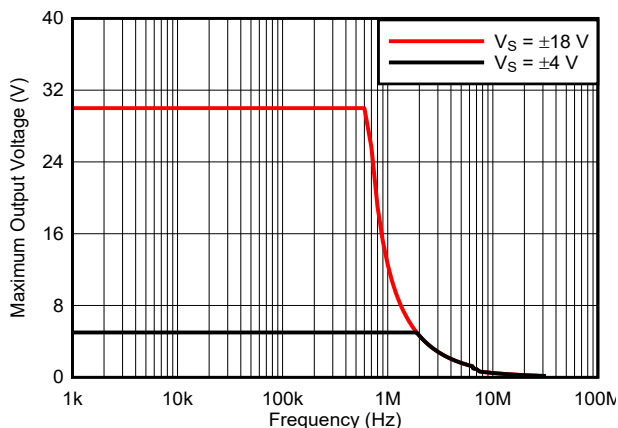

Figure 7-12. Maximum Output Voltage vs Frequency

7.3.10 Small-Signal Response

The parameters of an amplifier that best describe the small signal dynamic behavior are the gain-bandwidth product (GBP), unity gain frequency (UGF), and phase margin (PM). The GBP is a useful parameter to determine the bandwidth of an application in closed-loop configurations. Equation 4 can be used to approximate the closed loop bandwidth for the OPAx828. Typically, the GBP is a specified parameter with the amplifier configured in a noninverting gain of 100 (40 dB). The GBP of an amplifier is generally assumed to be constant over frequency but in some higher speed amplifiers, constant over frequency is not the case. The OPAx828 have a constant GBP all the way to the UGF; thus, the OPAx828 open-loop gain has a constant -20 dB/decade slope (-6 dB/octave). The UGF is defined as the frequency at which the gain of the amplifier crosses 1 V/V (0 dB). Figure 7-13 illustrates the concept of GBP and UGF. The OPAx828 have both a GBP and UGF of 45 MHz.

$$\text{Bandwidth} = \frac{\text{GBP}}{A_{CL}} = \frac{45\text{MHz}}{A_{CL}} \quad (4)$$

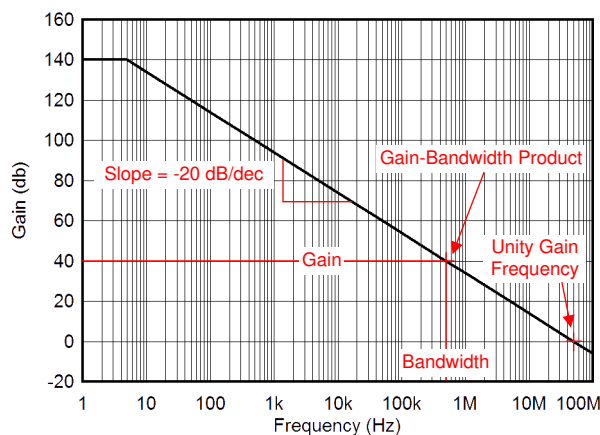

Figure 7-13. Gain-Bandwidth Product and Unity Gain Frequency

7.3.11 Thermal Shutdown

The OPAx828 are protected from thermal overloads by an internal thermal shutdown feature. The shutdown design provides thermal protection when operated in demanding, high-temperature industrial environments. The devices accurately measure the die junction temperature at the hottest spot on the die. As the junction temperature reaches the thermal shutdown temperature, the devices are disabled by placing the output into a high-impedance state. This state prevents further power dissipation and allows the OPAx828 to begin cooling. After the junction temperature reduces by the thermal hysteresis amount, the OPAx828 resume normal operation. If the output condition that caused the OPAx828 to heat up is still present, the devices can enter thermal shutdown again. The OPAx828 quiescent current during shutdown reduces to approximately 20 μ A. Identify and correct the cause of any thermal shutdown to resume normal device operation. Thermal shutdown occurs when the OPAx828 junction temperature exceeds approximately 165°C . When in thermal shutdown, the OPAx828 return to normal operation when the junction temperature cools to approximately 145°C .

7.3.12 Low Offset Voltage Drift

Each OPAX828 is laser trimmed in production. Input offset voltage is trimmed at two temperatures, providing low input offset voltage drift across the full temperature range.

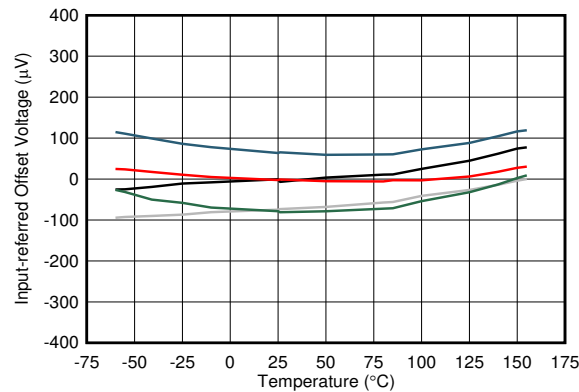

Figure 7-14. Input Offset Voltage vs Temperature

7.3.13 Overload Recovery

Overload recovery is defined as the time required for the op amp output to recover from a saturated state to a linear state. The output devices of the op amp enter the saturation region when the output voltage exceeds the rated operating voltage that results from the high input voltage or the high gain. After the device enters the saturation region, the charge carriers in the output devices must have time to return back to the normal state. After the charge carriers return back to the equilibrium state, the device begins to slew at the normal slew rate. As a result, the propagation delay (in case of an overload condition) is the sum of the overload recovery time and the slew time. The overload recovery time for the OPAX828 is approximately 55 ns.

7.4 Device Functional Modes

The OPAX828 are operational when the applied power supply voltage is between ± 4 V and ± 18 V. When operating the OPAX828 devices, self-heating occurs. Device self-heating is a function of the power-supply voltage and power delivered to the load. Under heavy loading conditions and elevated ambient temperatures, the OPAX828 can enter thermal shutdown. Thermal shutdown occurs when the OPAX828 junction temperature exceeds approximately 165°C . When in thermal shutdown, the OPAX828 return to normal operation when the junction temperature cools to approximately 145°C .

8 Application and Implementation

Note

Information in the following applications sections is not part of the TI component specification, and TI does not warrant its accuracy or completeness. TI's customers are responsible for determining suitability of components for their purposes, as well as validating and testing their design implementation to confirm system functionality.

8.1 Application Information

The OPAx828 combine low offset and offset drift with low noise across a wide bandwidth, making these devices an excellent choice for a variety of test equipment and data-acquisition systems.

8.2 Typical Applications

8.2.1 SAR ADC Driver

The high dc precision and ac performance of the OPAx828 along with the 45-MHz bandwidth enable the devices to quickly and accurately drive a 16-bit successive approximate register (SAR) analog-to-digital converter (ADC).

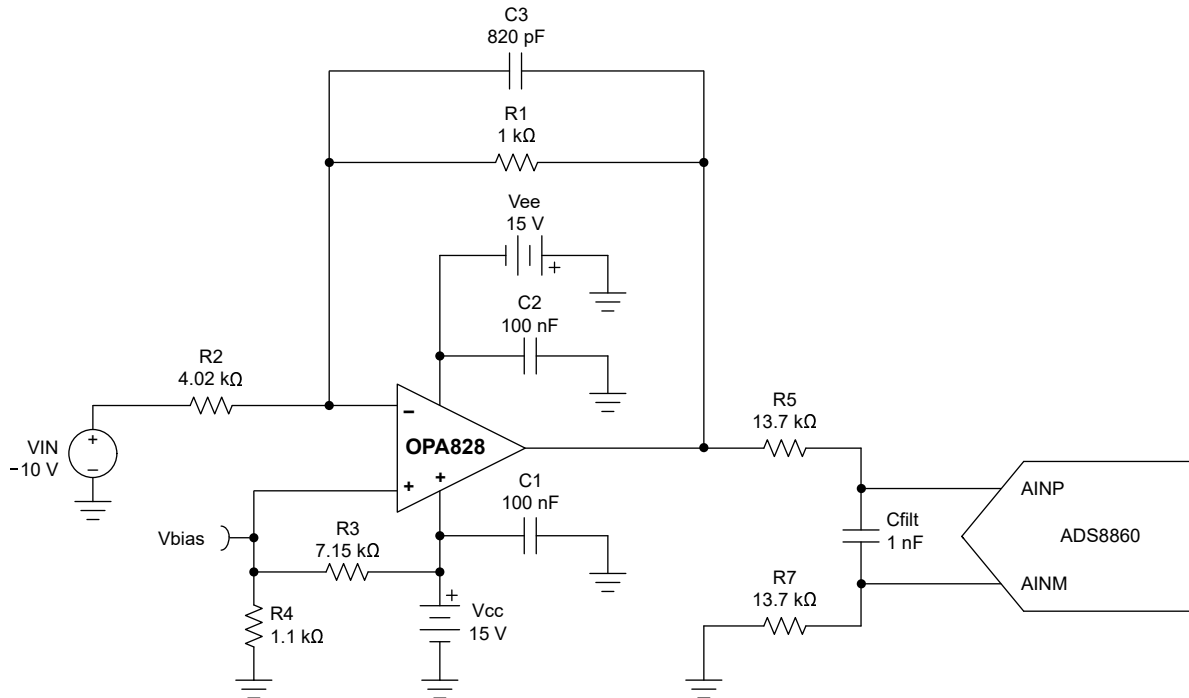

Figure 8-1. OPA828 Configured as a SAR Driver

8.2.1.1 Design Requirements

The design requirements for this example include:

- Power the OPA828 from ± 15 -V power supplies
- Amplifier output must settle to 16-bit accuracy in less than 290 ns
- Gain = $-1/4$
- Amplifier output is biased to 2 V
- Amplifier input = ± 10 V, output = 0 V to 5 V

8.2.1.2 Detailed Design Procedure

Figure 8-1 shows the OPA828 configured to enable a wide input voltage range of ± 10 V to be attenuated to 0 V to 5 V. The output range of the amplifier is selected based on the full-scale input range of the ADS8860, a 16-bit, 1-MSPS SAR ADC. Supply rails of ± 15 V are used so the amplifier can achieve linear swing across the full input range. This design allows the amplifier output to settle to 16-bits within the 290-ns acquisition time of the selected ADC.

The *Analog Engineer's Calculator* is used to select the resistors and capacitors required to set the signal attenuation as well as the charge bucket between the amplifier and ADC. The input and feedback resistors are chosen to provide a gain of $-1/4$ (for example, a $4 \times$ attenuation in an inverting configuration). V_{BIAS} is fixed at 2 V to enable the output to swing from 0 V to 5 V. Figure 8-2 shows the simulated settling time of this circuit. To function properly, the output of the amplifier must settle to within $\pm 1/2$ LSB before the end of the ADC acquisition cycle. In this example, using the ADS8860, the output of the amplifier must settle to within ± 38.15 μ V. V_{error} is the difference between the expected output and the actual output of the amplifier.

An 820-pF capacitor is added to the feedback to create a low-pass filter with a cutoff frequency of 194 kHz. This filter reduces the noise seen by the ADC and improves the accuracy of the system. The dc transfer function of this circuit is shown in Figure 8-3 and the ac response is shown in Figure 8-4.

For more details and training on configuring an amplifier for an ADC drive, selecting the resistors and capacitor for the charge bucket, and other signal chain topics, visit [TI Precision Labs](#).

8.2.1.3 Application Curves

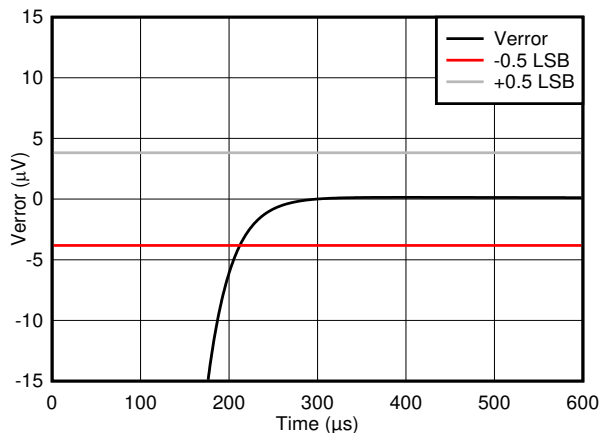

Figure 8-2. OPA828 Output Settling Time

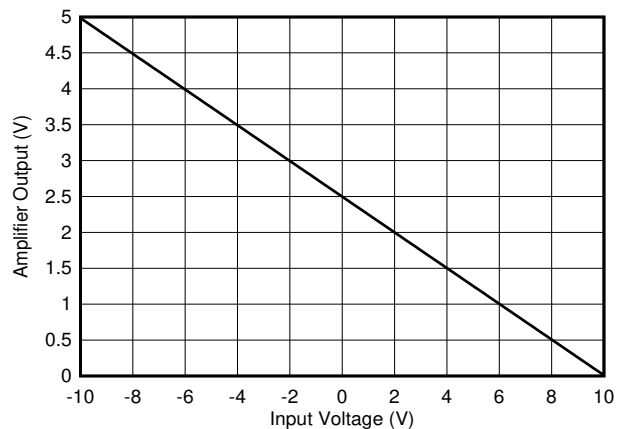

Figure 8-3. OPA828 DC Transfer Function

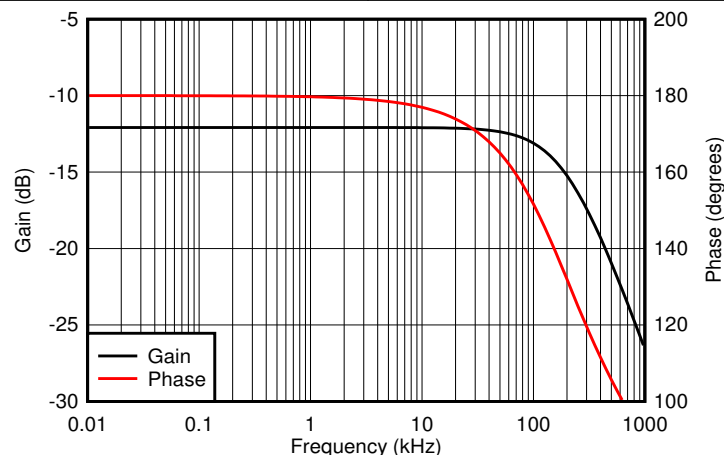
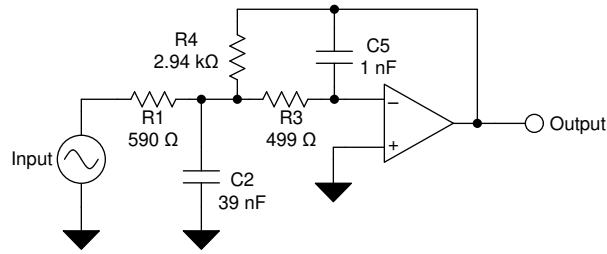

Figure 8-4. OPA828 AC Response

8.2.2 Low-Pass Filter



Copyright © 2016, Texas Instruments Incorporated

Figure 8-5. Typical OPA828 Application Schematic

8.2.2.1 Design Requirements

Use the following parameters for this design example:

- Gain = 5 V/V (inverting gain)
- Low-pass cutoff frequency = 25 kHz
- Second-order Chebyshev filter response with 3-dB gain peaking in the pass band

8.2.2.2 Detailed Design Procedure

Figure 8-5 shows the infinite-gain multiple-feedback circuit for a low-pass network function. Equation 5 calculates the voltage transfer function.

$$\frac{\text{Output}}{\text{Input}}(s) = \frac{-1/R_1 R_3 C_2 C_5}{s^2 + (s/C_2)(1/R_1 + 1/R_3 + 1/R_4) + 1/R_3 R_4 C_2 C_5} \quad (5)$$

This circuit produces a signal inversion. For this circuit, Equation 6 calculates the gain at dc and the low-pass cutoff frequency:

$$\text{Gain} = \frac{R_4}{R_1} \quad (6)$$

$$f_c = \frac{1}{2\pi} \sqrt{1/R_3 R_4 C_2 C_5}$$

8.2.2.3 Application Curve

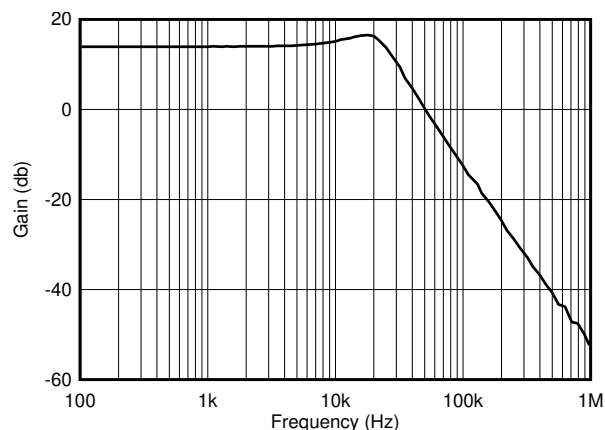

Figure 8-6. Low-Pass Filter Transfer Function

8.3 Power Supply Recommendations

The OPAx828 are specified to operate from 8 V to 36 V (± 4 V to ± 18 V); many specifications apply from -40°C to $+125^\circ\text{C}$. Parameters that can exhibit significant variance with regard to operating voltage or temperature are presented in the typical characteristic curves.

Place 0.1- μ F bypass capacitors close to the power-supply pins to reduce errors coupling in from noisy or high-impedance power supplies. For more detailed information on bypass capacitor placement, see the *Layout* section.

8.4 Layout

8.4.1 Layout Guidelines

For best operational performance of the device, use good printed circuit board (PCB) layout practices, including the following guidelines:

- Noise can propagate into analog circuitry through the power pins of the circuit as a whole and op amp in particular. Use bypass capacitors to reduce the coupled noise by providing low-impedance power sources local to the analog circuitry.
- Connect low-ESR, 0.1- μ F ceramic bypass capacitors between each supply pin and ground, placed as close as possible to the device. A single bypass capacitor from V+ to ground is applicable for single-supply applications.
- Separate grounding for analog and digital portions of circuitry is one of the simplest and most-effective methods of noise suppression. One or more layers on multilayer PCBs are usually devoted to ground planes. A ground plane helps distribute heat and reduces EMI noise pickup. Make sure to physically separate digital and analog grounds paying attention to the flow of the ground current.
- To reduce parasitic coupling, run the input traces as far away from the supply or output traces as possible. If these traces cannot be kept separate, crossing the sensitive trace perpendicular is much better as opposed to in parallel with the noisy trace.
- Place the external components as close as possible to the device.
- Keep the length of input traces as short as possible. Always remember that the input traces are the most sensitive part of the circuit.
- Consider a driven, low-impedance guard ring around the critical traces. A guard ring can significantly reduce leakage currents from nearby traces that are at different potentials.
- Clean the PCB following board assembly for best performance.
- Any precision integrated circuit can experience performance shifts due to moisture ingress into the plastic package. Following any aqueous PCB cleaning process, bake the PCB assembly to remove moisture introduced into the device packaging during the cleaning process. A low-temperature, post-cleaning bake at 85°C for 30 minutes is sufficient for most circumstances.

8.4.1.1 Thermal Considerations

Through normal operation, the OPAx828 self-heat. Self-heating is a natural increase in the die junction temperature that occurs in every amplifier. This self-heating is a result of several factors, including quiescent power consumption, package thermal resistance, PCB layout, and device operating conditions.

To make sure that the amplifier operates without entering thermal shutdown, use [Equation 7](#) to calculate the approximate junction (die) temperature:

$$T_j = P_D * \Theta_{JA} + T_A \tag{7}$$

As an example, [Equation 8](#) calculates the approximate junction temperature for the OPA828 (D package) while unloaded with an ambient temperature of 25°C.

$$T_j = (36V * 5.5mA) * 121.5^\circ C / W + 25^\circ C$$

$$T_j = 49^\circ C \tag{8}$$

For high-voltage, high-precision amplifiers, such as the OPAx828, the junction temperature can easily be tens of degrees higher than the ambient temperature in a quiescent (unloaded) condition. As shown by [Equation 7](#) and [Equation 8](#), the junction temperature depends on the thermal properties of the package, as expressed by the junction-to-ambient thermal resistance ($R_{\Theta JA}$). If the device then begins to drive a heavy load, the junction temperature can rise and trip the thermal-shutdown circuit. For such loading cases, the DGN package includes a thermal pad that significantly reduces $R_{\Theta JA}$. Proper PCB layout is essential to realize this improved thermal behavior. [Figure 8-7](#) and [Figure 8-8](#) show the maximum output voltage of the OPAx828 without entering thermal shutdown versus ambient temperature in both a loaded and unloaded condition for the different package versions.

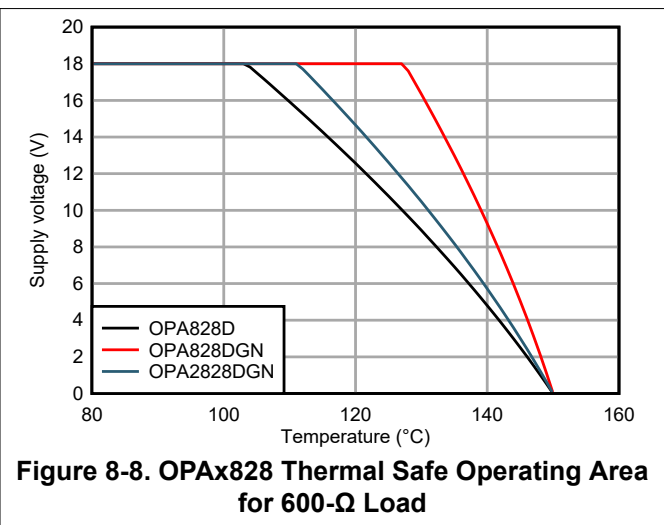
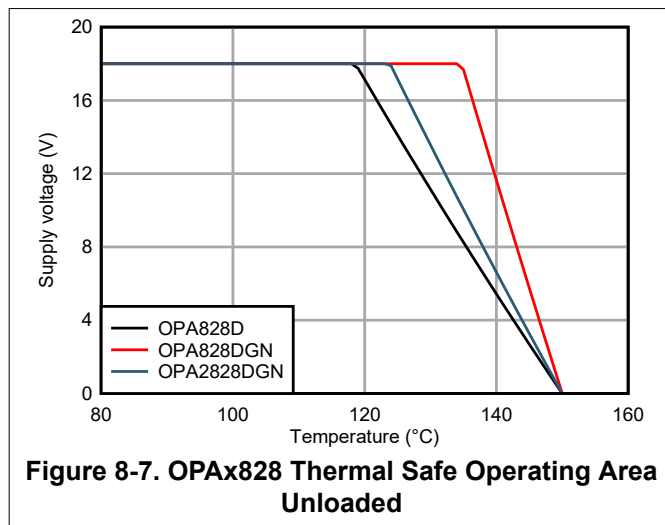

8.4.1.2 PowerPAD™ Design Considerations (DGN package only)

The OPAx828 are available in a thermally-enhanced, PowerPAD integrated circuit package. Figure 8-9(a) and (b) illustrate how the PowerPAD packages are constructed using a downset leadframe upon which the die is mounted. Figure 8-9(c) shows how this arrangement results in the leadframe being exposed as a thermal pad on the underside of the package. This thermal pad has direct thermal contact with the die. Therefore, excellent thermal performance is achieved by providing a good thermal path away from the thermal pad.

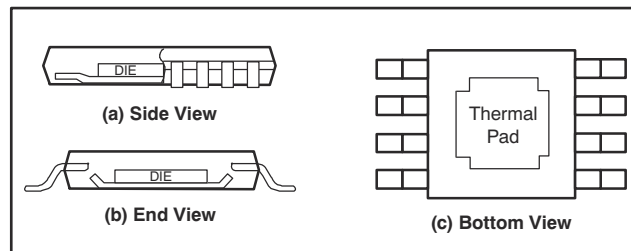

Figure 8-9. Views of the Thermally-Enhanced Package

The PowerPAD integrated circuit package allows for both assembly and thermal management in one manufacturing operation. During the surface-mount solder operation (when the leads are being soldered), the thermal pad must be soldered to a copper area underneath the package. Through the use of thermal paths within this copper area, heat is conducted away from the package into either a ground plane or other heat-dissipating device. Soldering the thermal pad to the printed circuit board (PCB) is always required, even with applications that have low power dissipation. This soldering provides the necessary thermal and mechanical connection between the leadframe die pad and the PCB. Although the die is electrically isolated ($>10\text{ M}\Omega$) from the exposed thermal pad, tie the pad to V^- or a system ground plane to minimize potential leakage to the input pins. See Figure 8-11 for additional details.

8.4.2 Layout Example

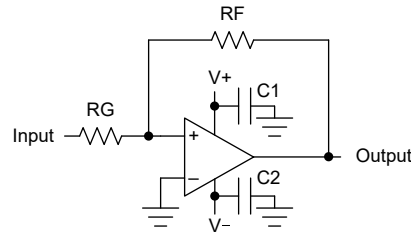

Figure 8-10. OPA828 Schematic Representation

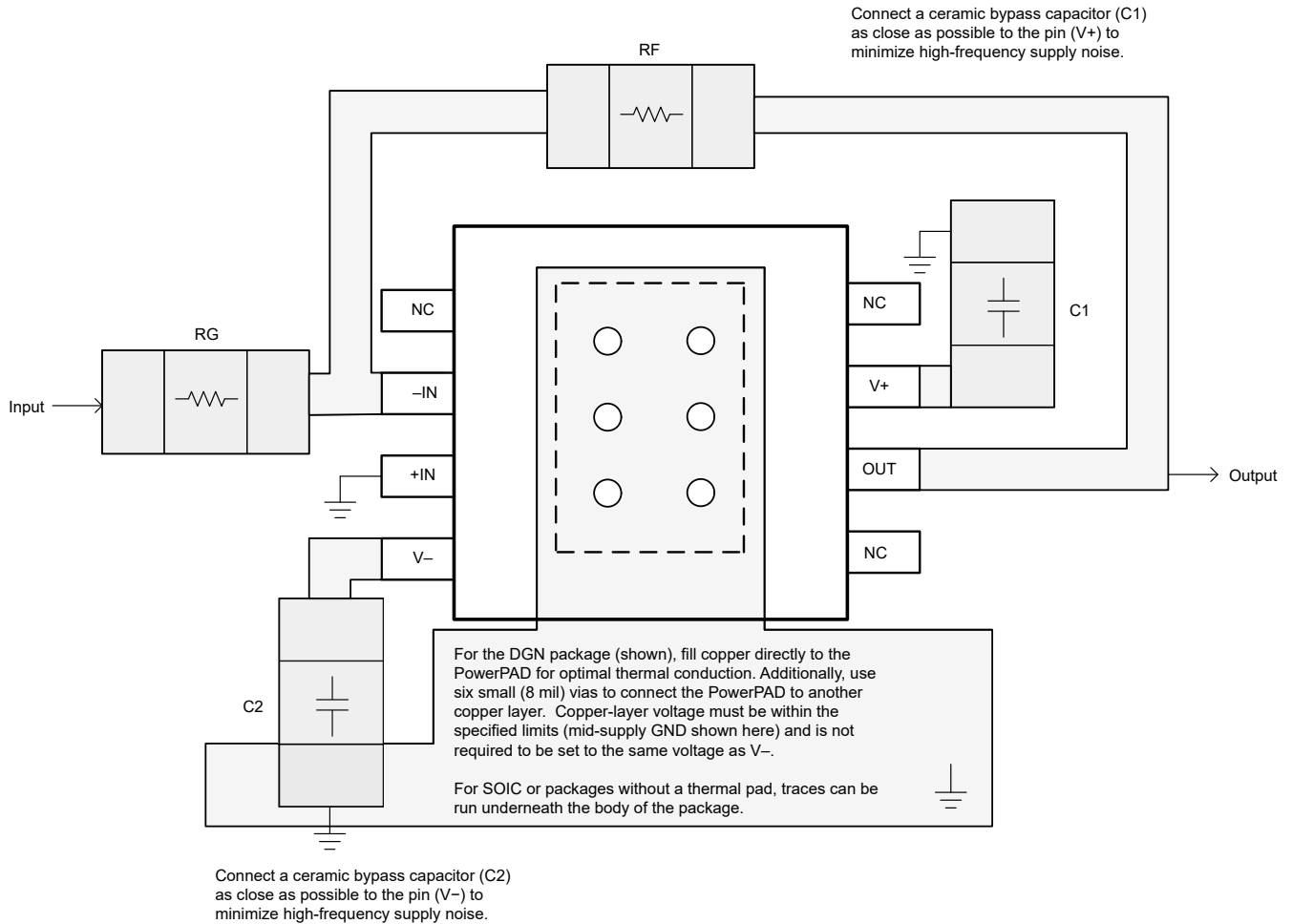

Figure 8-11. OPA828 Layout Example

9 Device and Documentation Support

9.1 Device Support

9.1.1 Development Support

9.1.1.1 PSpice® for TI

PSpice® for TI is a design and simulation environment that helps evaluate performance of analog circuits. Create subsystem designs and prototype solutions before committing to layout and fabrication, reducing development cost and time to market.

9.1.1.2 Filter Design Tool

The [filter design tool](#) is a simple, powerful, and easy-to-use active filter design program. The filter design tool allows the user to create optimized filter designs using a selection of TI operational amplifiers and passive components from TI's vendor partners.

Available as a web-based tool from the [Design tools and simulation](#) web page, the [filter design tool](#) allows the user to design, optimize, and simulate complete multistage active filter solutions within minutes.

9.2 Documentation Support

9.2.1 Related Documentation

For related documentation see the following:

- Texas Instruments, [Compensate Transimpedance Amplifiers Intuitively application report](#)

9.3 Receiving Notification of Documentation Updates

To receive notification of documentation updates, navigate to the device product folder on [ti.com](#). Click on [Subscribe to updates](#) to register and receive a weekly digest of any product information that has changed. For change details, review the revision history included in any revised document.

9.4 Support Resources

[TI E2E™ support forums](#) are an engineer's go-to source for fast, verified answers and design help — straight from the experts. Search existing answers or ask your own question to get the quick design help you need.

Linked content is provided "AS IS" by the respective contributors. They do not constitute TI specifications and do not necessarily reflect TI's views; see TI's [Terms of Use](#).

9.5 Trademarks

PowerPAD™ and TI E2E™ are trademarks of Texas Instruments.

PSpice® is a registered trademark of Cadence Design Systems, Inc.

All trademarks are the property of their respective owners.

9.6 Electrostatic Discharge Caution



This integrated circuit can be damaged by ESD. Texas Instruments recommends that all integrated circuits be handled with appropriate precautions. Failure to observe proper handling and installation procedures can cause damage.

ESD damage can range from subtle performance degradation to complete device failure. Precision integrated circuits may be more susceptible to damage because very small parametric changes could cause the device not to meet its published specifications.

9.7 Glossary

[TI Glossary](#) This glossary lists and explains terms, acronyms, and definitions.

10 Mechanical, Packaging, and Orderable Information

The following pages include mechanical, packaging, and orderable information. This information is the most current data available for the designated devices. This data is subject to change without notice and revision of this document. For browser-based versions of this data sheet, refer to the left-hand navigation.

PACKAGING INFORMATION

Orderable Device	Status (1)	Package Type	Package Drawing	Pins	Package Qty	Eco Plan (2)	Lead finish/ Ball material (6)	MSL Peak Temp (3)	Op Temp (°C)	Device Marking (4/5)	Samples
OPA2828IDGNR	ACTIVE	HVSSOP	DGN	8	2500	RoHS & Green	NIPDAU	Level-2-260C-1 YEAR	-40 to 125	2QGJ	Samples
OPA2828IDGNT	ACTIVE	HVSSOP	DGN	8	250	RoHS & Green	NIPDAU	Level-2-260C-1 YEAR	-40 to 125	2QGJ	Samples
OPA828ID	ACTIVE	SOIC	D	8	75	RoHS & Green	NIPDAU	Level-2-260C-1 YEAR	-40 to 125	OPA828	Samples
OPA828IDGNR	ACTIVE	HVSSOP	DGN	8	2500	RoHS & Green	NIPDAU	Level-2-260C-1 YEAR	-40 to 125	2RAJ	Samples
OPA828IDGNT	ACTIVE	HVSSOP	DGN	8	250	RoHS & Green	NIPDAU	Level-2-260C-1 YEAR	-40 to 125	2RAJ	Samples
OPA828IDR	ACTIVE	SOIC	D	8	2500	RoHS & Green	NIPDAU	Level-2-260C-1 YEAR	-40 to 125	OPA828	Samples

(1) The marketing status values are defined as follows:

ACTIVE: Product device recommended for new designs.

LIFEBUY: TI has announced that the device will be discontinued, and a lifetime-buy period is in effect.

NRND: Not recommended for new designs. Device is in production to support existing customers, but TI does not recommend using this part in a new design.

PREVIEW: Device has been announced but is not in production. Samples may or may not be available.

OBSELETE: TI has discontinued the production of the device.

(2) **RoHS:** TI defines "RoHS" to mean semiconductor products that are compliant with the current EU RoHS requirements for all 10 RoHS substances, including the requirement that RoHS substance do not exceed 0.1% by weight in homogeneous materials. Where designed to be soldered at high temperatures, "RoHS" products are suitable for use in specified lead-free processes. TI may reference these types of products as "Pb-Free".

RoHS Exempt: TI defines "RoHS Exempt" to mean products that contain lead but are compliant with EU RoHS pursuant to a specific EU RoHS exemption.

Green: TI defines "Green" to mean the content of Chlorine (Cl) and Bromine (Br) based flame retardants meet JS709B low halogen requirements of <=1000ppm threshold. Antimony trioxide based flame retardants must also meet the <=1000ppm threshold requirement.

(3) MSL, Peak Temp. - The Moisture Sensitivity Level rating according to the JEDEC industry standard classifications, and peak solder temperature.

(4) There may be additional marking, which relates to the logo, the lot trace code information, or the environmental category on the device.

(5) Multiple Device Markings will be inside parentheses. Only one Device Marking contained in parentheses and separated by a "-" will appear on a device. If a line is indented then it is a continuation of the previous line and the two combined represent the entire Device Marking for that device.

(6) Lead finish/Ball material - Orderable Devices may have multiple material finish options. Finish options are separated by a vertical ruled line. Lead finish/Ball material values may wrap to two lines if the finish value exceeds the maximum column width.

Important Information and Disclaimer: The information provided on this page represents TI's knowledge and belief as of the date that it is provided. TI bases its knowledge and belief on information provided by third parties, and makes no representation or warranty as to the accuracy of such information. Efforts are underway to better integrate information from third parties. TI has taken and continues to take reasonable steps to provide representative and accurate information but may not have conducted destructive testing or chemical analysis on incoming materials and chemicals. TI and TI suppliers consider certain information to be proprietary, and thus CAS numbers and other limited information may not be available for release.

In no event shall TI's liability arising out of such information exceed the total purchase price of the TI part(s) at issue in this document sold by TI to Customer on an annual basis.

TAPE AND REEL INFORMATION

QUADRANT ASSIGNMENTS FOR PIN 1 ORIENTATION IN TAPE

*All dimensions are nominal

Device	Package Type	Package Drawing	Pins	SPQ	Reel Diameter (mm)	Reel Width W1 (mm)	A0 (mm)	B0 (mm)	K0 (mm)	P1 (mm)	W (mm)	Pin1 Quadrant
OPA2828IDGNR	HVSSOP	DGN	8	2500	330.0	12.4	5.3	3.4	1.4	8.0	12.0	Q1
OPA2828IDGNT	HVSSOP	DGN	8	250	180.0	12.4	5.3	3.4	1.4	8.0	12.0	Q1
OPA828IDGNR	HVSSOP	DGN	8	2500	330.0	12.4	5.3	3.4	1.4	8.0	12.0	Q1
OPA828IDGNT	HVSSOP	DGN	8	250	180.0	12.4	5.3	3.4	1.4	8.0	12.0	Q1
OPA828IDR	SOIC	D	8	2500	330.0	12.4	6.4	5.2	2.1	8.0	12.0	Q1

TAPE AND REEL BOX DIMENSIONS

*All dimensions are nominal

Device	Package Type	Package Drawing	Pins	SPQ	Length (mm)	Width (mm)	Height (mm)
OPA2828IDGNR	HVSSOP	DGN	8	2500	356.0	356.0	35.0
OPA2828IDGNT	HVSSOP	DGN	8	250	210.0	185.0	35.0
OPA828IDGNR	HVSSOP	DGN	8	2500	356.0	356.0	35.0
OPA828IDGNT	HVSSOP	DGN	8	250	210.0	185.0	35.0
OPA828IDR	SOIC	D	8	2500	356.0	356.0	35.0

TUBE

*All dimensions are nominal

Device	Package Name	Package Type	Pins	SPQ	L (mm)	W (mm)	T (μm)	B (mm)
OPA828ID	D	SOIC	8	75	506.6	8	3940	4.32

GENERIC PACKAGE VIEW

DGN 8

PowerPAD™ HVSSOP - 1.1 mm max height

3 x 3, 0.65 mm pitch

SMALL OUTLINE PACKAGE

This image is a representation of the package family, actual package may vary.
Refer to the product data sheet for package details.



4225482/B



4229130/B 05/2024

NOTES:

PowerPAD is a trademark of Texas Instruments.

1. All linear dimensions are in millimeters. Any dimensions in parenthesis are for reference only. Dimensioning and tolerancing per ASME Y14.5M.
2. This drawing is subject to change without notice.
3. This dimension does not include mold flash, protrusions, or gate burrs. Mold flash, protrusions, or gate burrs shall not exceed 0.15 mm per side.
4. This dimension does not include interlead flash. Interlead flash shall not exceed 0.25 mm per side.
5. Reference JEDEC registration MO-187.
6. Features may differ or may not be present.

EXAMPLE BOARD LAYOUT

DGN0008H

PowerPAD™ VSSOP - 1.1 mm max height

SMALL OUTLINE PACKAGE

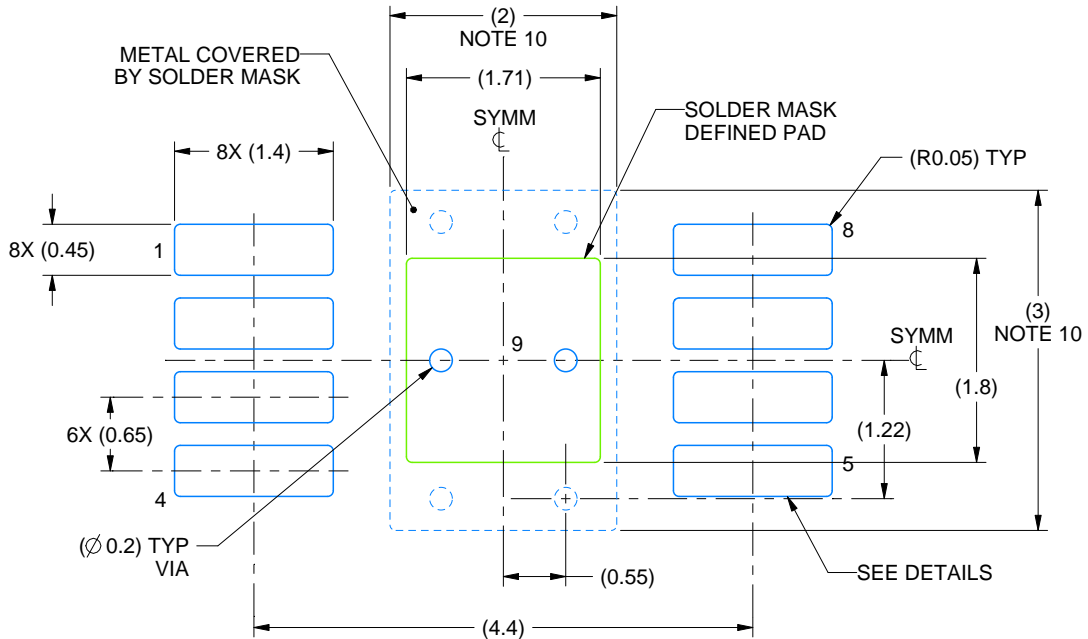

LAND PATTERN EXAMPLE
EXPOSED METAL SHOWN
SCALE: 15X

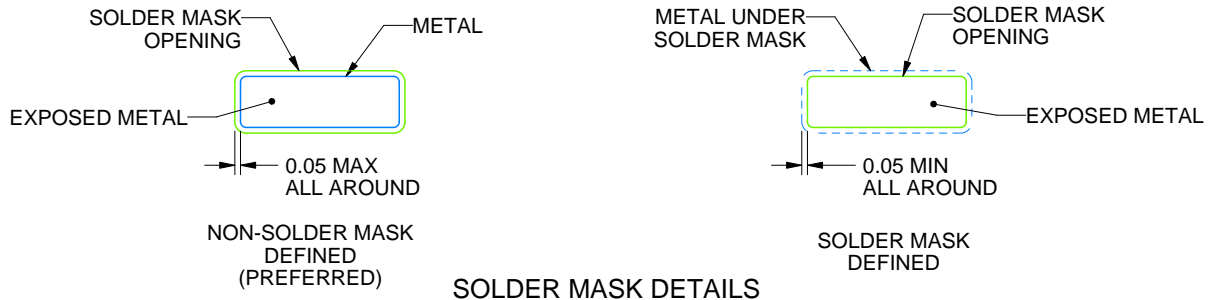

SOLDER MASK DETAILS

4229130/B 05/2024

NOTES: (continued)

7. Publication IPC-7351 may have alternate designs.
8. Solder mask tolerances between and around signal pads can vary based on board fabrication site.
9. Vias are optional depending on application, refer to device data sheet. If any vias are implemented, refer to their locations shown on this view. It is recommended that vias under paste be filled, plugged or tented.
10. Size of metal pad may vary due to creepage requirement.

EXAMPLE STENCIL DESIGN

DGN0008H

PowerPAD™ VSSOP - 1.1 mm max height

SMALL OUTLINE PACKAGE



SOLDER PASTE EXAMPLE
EXPOSED PAD 9:
100% PRINTED SOLDER COVERAGE BY AREA
SCALE: 15X

STENCIL THICKNESS	SOLDER STENCIL OPENING
0.1	1.91 X 2.01
0.125	1.71 X 1.80 (SHOWN)
0.15	1.56 X 1.64
0.175	1.45 X 1.52

4229130/B 05/2024

NOTES: (continued)

11. Laser cutting apertures with trapezoidal walls and rounded corners may offer better paste release. IPC-7525 may have alternate design recommendations.
12. Board assembly site may have different recommendations for stencil design.



D0008A

PACKAGE OUTLINE

SOIC - 1.75 mm max height

SMALL OUTLINE INTEGRATED CIRCUIT



4214825/C 02/2019

NOTES:

1. Linear dimensions are in inches [millimeters]. Dimensions in parenthesis are for reference only. Controlling dimensions are in inches. Dimensioning and tolerancing per ASME Y14.5M.
2. This drawing is subject to change without notice.
3. This dimension does not include mold flash, protrusions, or gate burrs. Mold flash, protrusions, or gate burrs shall not exceed .006 [0.15] per side.
4. This dimension does not include interlead flash.
5. Reference JEDEC registration MS-012, variation AA.

EXAMPLE BOARD LAYOUT

D0008A

SOIC - 1.75 mm max height

SMALL OUTLINE INTEGRATED CIRCUIT



LAND PATTERN EXAMPLE
 EXPOSED METAL SHOWN
 SCALE:8X



SOLDER MASK DETAILS

4214825/C 02/2019

NOTES: (continued)

- 6. Publication IPC-7351 may have alternate designs.
- 7. Solder mask tolerances between and around signal pads can vary based on board fabrication site.

EXAMPLE STENCIL DESIGN

D0008A

SOIC - 1.75 mm max height

SMALL OUTLINE INTEGRATED CIRCUIT



SOLDER PASTE EXAMPLE
BASED ON .005 INCH [0.125 MM] THICK STENCIL
SCALE:8X

4214825/C 02/2019

NOTES: (continued)

8. Laser cutting apertures with trapezoidal walls and rounded corners may offer better paste release. IPC-7525 may have alternate design recommendations.
9. Board assembly site may have different recommendations for stencil design.

IMPORTANT NOTICE AND DISCLAIMER

TI PROVIDES TECHNICAL AND RELIABILITY DATA (INCLUDING DATA SHEETS), DESIGN RESOURCES (INCLUDING REFERENCE DESIGNS), APPLICATION OR OTHER DESIGN ADVICE, WEB TOOLS, SAFETY INFORMATION, AND OTHER RESOURCES "AS IS" AND WITH ALL FAULTS, AND DISCLAIMS ALL WARRANTIES, EXPRESS AND IMPLIED, INCLUDING WITHOUT LIMITATION ANY IMPLIED WARRANTIES OF MERCHANTABILITY, FITNESS FOR A PARTICULAR PURPOSE OR NON-INFRINGEMENT OF THIRD PARTY INTELLECTUAL PROPERTY RIGHTS.

These resources are intended for skilled developers designing with TI products. You are solely responsible for (1) selecting the appropriate TI products for your application, (2) designing, validating and testing your application, and (3) ensuring your application meets applicable standards, and any other safety, security, regulatory or other requirements.

These resources are subject to change without notice. TI grants you permission to use these resources only for development of an application that uses the TI products described in the resource. Other reproduction and display of these resources is prohibited. No license is granted to any other TI intellectual property right or to any third party intellectual property right. TI disclaims responsibility for, and you will fully indemnify TI and its representatives against, any claims, damages, costs, losses, and liabilities arising out of your use of these resources.

TI's products are provided subject to [TI's Terms of Sale](#) or other applicable terms available either on [ti.com](https://www.ti.com) or provided in conjunction with such TI products. TI's provision of these resources does not expand or otherwise alter TI's applicable warranties or warranty disclaimers for TI products.

TI objects to and rejects any additional or different terms you may have proposed.

Mailing Address: Texas Instruments, Post Office Box 655303, Dallas, Texas 75265
Copyright © 2024, Texas Instruments Incorporated