

# SN54LVC574A, SN74LVC574A OCTAL EDGE-TRIGGERED D-TYPE FLIP-FLOPS WITH 3-STATE OUTPUTS

SCAS301R – JANUARY 1993 – REVISED MARCH 2005

- Operate From 1.65 V to 3.6 V
- Inputs Accept Voltages to 5.5 V
- Specified From  $-40^{\circ}\text{C}$  to  $85^{\circ}\text{C}$ ,  $-40^{\circ}\text{C}$  to  $125^{\circ}\text{C}$ , and  $-55^{\circ}\text{C}$  to  $125^{\circ}\text{C}$
- Max  $t_{pd}$  of 7 ns at 3.3 V
- Typical  $V_{OLP}$  (Output Ground Bounce)  $<0.8\text{ V}$  at  $V_{CC} = 3.3\text{ V}$ ,  $T_A = 25^{\circ}\text{C}$
- Typical  $V_{OHV}$  (Output  $V_{OH}$  Undershoot)  $>2\text{ V}$  at  $V_{CC} = 3.3\text{ V}$ ,  $T_A = 25^{\circ}\text{C}$
- Support Mixed-Mode Signal Operation on All Ports (5-V Input/Output Voltage With 3.3-V  $V_{CC}$ )
- $I_{off}$  Supports Partial-Power-Down Mode Operation
- Latch-Up Performance Exceeds 250 mA Per JESD 17
- ESD Protection Exceeds JESD 22
  - 2000-V Human-Body Model (A114-A)
  - 200-V Machine Model (A115-A)
  - 1000-V Charged-Device Model (C101)

SN54LVC574A . . . J OR W PACKAGE  
SN74LVC574A . . . DB, DGV, DW, N, NS,  
OR PW PACKAGE  
(TOP VIEW)

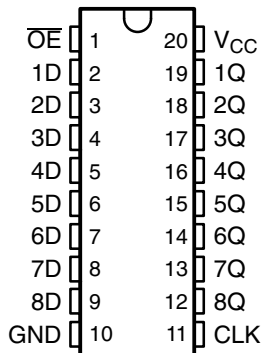

SN74LVC574A . . . RGY PACKAGE  
(TOP VIEW)

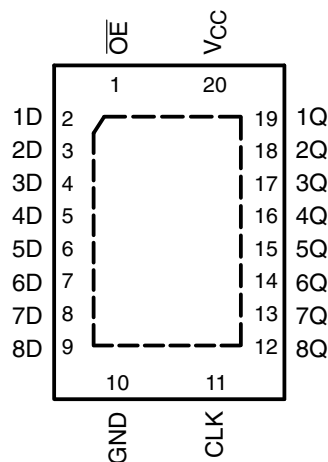

SN54LVC574A . . . FK PACKAGE  
(TOP VIEW)

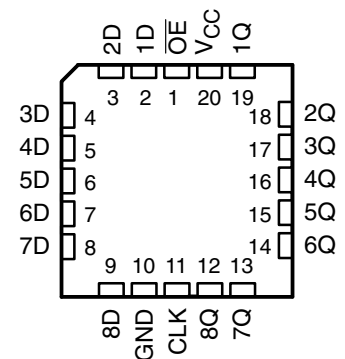

## description/ordering information

The SN54LVC574A octal edge-triggered D-type flip-flop is designed for 2.7-V to 3.6-V  $V_{CC}$  operation, and the SN74LVC574A octal edge-triggered D-type flip-flop is designed for 1.65-V to 3.6-V  $V_{CC}$  operation.

These devices feature 3-state outputs designed specifically for driving highly capacitive or relatively low-impedance loads. They are particularly suitable for implementing buffer registers, I/O ports, bidirectional bus drivers, and working registers.

On the positive transition of the clock (CLK) input, the Q outputs are set to the logic levels at the data (D) inputs.

A buffered output-enable ( $\overline{OE}$ ) input can be used to place the eight outputs in either a normal logic state (high or low logic levels) or the high-impedance state. In the high-impedance state, the outputs neither load nor drive the bus lines significantly. The high-impedance state and increased drive provide the capability to drive bus lines without interface or pullup components.

$\overline{OE}$  does not affect the internal operations of the flip-flops. Old data can be retained or new data can be entered while the outputs are in the high-impedance state.

These devices are fully specified for partial-power-down applications using  $I_{off}$ . The  $I_{off}$  circuitry disables the outputs, preventing damaging current backflow through the device when it is powered down.



Please be aware that an important notice concerning availability, standard warranty, and use in critical applications of Texas Instruments semiconductor products and disclaimers thereto appears at the end of this data sheet.

PRODUCTION DATA information is current as of publication date. Products conform to specifications per the terms of Texas Instruments standard warranty. Production processing does not necessarily include testing of all parameters.

 **TEXAS  
INSTRUMENTS**

POST OFFICE BOX 655303 • DALLAS, TEXAS 75265

Copyright © 2005, Texas Instruments Incorporated  
On products compliant to MIL-PRF-38535, all parameters are tested unless otherwise noted. On all other products, production processing does not necessarily include testing of all parameters.

# SN54LVC574A, SN74LVC574A OCTAL EDGE-TRIGGERED D-TYPE FLIP-FLOPS WITH 3-STATE OUTPUTS

SCAS301R – JANUARY 1993 – REVISED MARCH 2005

## description/ordering information (continued)

To ensure the high-impedance state during power up or power down,  $\overline{OE}$  should be tied to  $V_{CC}$  through a pullup resistor; the minimum value of the resistor is determined by the current-sinking capability of the driver.

Inputs can be driven from either 3.3-V or 5-V devices. This feature allows the use of these devices as translators in a mixed 3.3-V/5-V system environment.

### ORDERING INFORMATION

$T_A$	PACKAGE†		ORDERABLE PART NUMBER	TOP-SIDE MARKING
-40°C to 85°C	QFN – RGY	Reel of 1000	SN74LVC574ARGYR	LC574A
	VFBGA – GQN	Reel of 1000	SN74LVC574AGQNR	LC574A
	VFBGA – ZQN (Pb-free)		SN74LVC574AZQNR	
-40°C to 125°C	PDIP – N	Tube of 20	SN74LVC574AN	SN74LVC574AN
	SOIC – DW	Tube of 25	SN74LVC574ADW	LVC574A
		Reel of 2000	SN74LVC574ADWR	
	SOP – NS	Reel of 2000	SN74LVC574ANSR	LVC574A
	SSOP – DB	Reel of 2000	SN74LVC574ADBR	LC574A
	TSSOP – PW	Tube of 70	SN74LVC574APW	LC574A
		Reel of 2000	SN74LVC574APWR	
Reel of 250		SN74LVC574APWT		
TVSOP – DGV	Reel of 2000	SN74LVC574ADGVR	LC574A	
-55°C to 125°C	CDIP – J	Tube of 20	SNJ54LVC574AJ	SNJ54LVC574AJ
	CFP – W	Tube of 85	SNJ54LVC574AW	SNJ54LVC574AW
	LCCC – FK	Tube of 55	SNJ54LVC574AFK	SNJ54LVC574AFK

† Package drawings, standard packing quantities, thermal data, symbolization, and PCB design guidelines are available at [www.ti.com/sc/package](http://www.ti.com/sc/package).

#### GQN OR ZQN PACKAGE (TOP VIEW)



#### terminal assignments

	1	2	3	4
A	1D	$\overline{OE}$	$V_{CC}$	1Q
B	3D	3Q	2D	2Q
C	5D	4D	5Q	4Q
D	7D	7Q	6D	6Q
E	GND	8D	CLK	8Q

#### FUNCTION TABLE (each flip-flop)

INPUTS			OUTPUT Q
$\overline{OE}$	CLK	D	
L	↑	H	H
L	↑	L	L
L	L	X	$Q_0$
H	X	X	Z

# SN54LVC574A, SN74LVC574A OCTAL EDGE-TRIGGERED D-TYPE FLIP-FLOPS WITH 3-STATE OUTPUTS

SCAS301R – JANUARY 1993 – REVISED MARCH 2005

## logic diagram (positive logic)



Pin numbers shown are for the DB, DGV, DW, FK, J, N, NS, PW, RGY, and W packages.

## absolute maximum ratings over operating free-air temperature range (unless otherwise noted)<sup>†</sup>

Supply voltage range, $V_{CC}$ .....	-0.5 V to 6.5 V
Input voltage range, $V_I$ (see Note 1) .....	-0.5 V to 6.5 V
Voltage range applied to any output in the high-impedance or power-off state, $V_O$ (see Note 1) .....	-0.5 V to 6.5 V
Voltage range applied to any output in the high or low state, $V_O$ (see Notes 1 and 2) .....	-0.5 V to $V_{CC} + 0.5$ V
Input clamp current, $I_{IK}$ ( $V_I < 0$ ) .....	-50 mA
Output clamp current, $I_{OK}$ ( $V_O < 0$ ) .....	-50 mA
Continuous output current, $I_O$ .....	$\pm 50$ mA
Continuous current through $V_{CC}$ or GND .....	$\pm 100$ mA
Package thermal impedance, $\theta_{JA}$ (see Note 3): DB package .....	70°C/W
(see Note 3): DGV package .....	92°C/W
(see Note 3): DW package .....	58°C/W
(see Note 3): GQN/ZQN package .....	78°C/W
(see Note 3): N package .....	69°C/W
(see Note 3): NS package .....	60°C/W
(see Note 3): PW package .....	83°C/W
(see Note 4): RGY package .....	37°C/W
Storage temperature range, $T_{stg}$ .....	-65°C to 150°C
Power dissipation, $P_{tot}$ ( $T_A = -40^\circ\text{C}$ to $125^\circ\text{C}$ ) (see Notes 5 and 6) .....	500 mW

<sup>†</sup> Stresses beyond those listed under "absolute maximum ratings" may cause permanent damage to the device. These are stress ratings only, and functional operation of the device at these or any other conditions beyond those indicated under "recommended operating conditions" is not implied. Exposure to absolute-maximum-rated conditions for extended periods may affect device reliability.

- NOTES:
1. The input negative-voltage and output voltage ratings may be exceeded if the input and output current ratings are observed.
  2. The value of  $V_{CC}$  is provided in the recommended operating conditions table.
  3. The package thermal impedance is calculated in accordance with JESD 51-7.
  4. The package thermal impedance is calculated in accordance with JESD 51-5.
  5. For the DW package: above 70°C the value of  $P_{tot}$  derates linearly with 8 mW/K.
  6. For the DB, DGV, N, NS, and PW packages: above 60°C the value of  $P_{tot}$  derates linearly with 5.5 mW/K.

# SN54LVC574A, SN74LVC574A OCTAL EDGE-TRIGGERED D-TYPE FLIP-FLOPS WITH 3-STATE OUTPUTS

SCAS301R – JANUARY 1993 – REVISED MARCH 2005

## recommended operating conditions (see Note 7)

		SN54LVC574A		UNIT
		-55 TO 125°C		
		MIN	MAX	
V <sub>CC</sub>	Supply voltage	Operating		V
		Data retention only		
V <sub>IH</sub>	High-level input voltage	V <sub>CC</sub> = 2.7 V to 3.6 V		V
V <sub>IL</sub>	Low-level input voltage	V <sub>CC</sub> = 2.7 V to 3.6 V		V
V <sub>I</sub>	Input voltage	0	5.5	V
V <sub>O</sub>	Output voltage	High or low state		V
		3-state		
I <sub>OH</sub>	High-level output current	V <sub>CC</sub> = 2.7 V		mA
		V <sub>CC</sub> = 3 V		
I <sub>OL</sub>	Low-level output current	V <sub>CC</sub> = 2.7 V		mA
		V <sub>CC</sub> = 3 V		
Δt/Δv	Input transition rise or fall rate	6		ns/V

NOTE 7: All unused inputs of the device must be held at V<sub>CC</sub> or GND to ensure proper device operation. Refer to the TI application report, *Implications of Slow or Floating CMOS Inputs*, literature number SCBA004.

## recommended operating conditions (see Note 7)

		SN74LVC574A						UNIT
		T <sub>A</sub> = 25°C		-40 TO 85°C		-40 TO 125°C		
		MIN	MAX	MIN	MAX	MIN	MAX	
V <sub>CC</sub>	Supply voltage	Operating		1.65		3.6		V
		Data retention only		1.5		1.5		
V <sub>IH</sub>	High-level input voltage	V <sub>CC</sub> = 1.65 V to 1.95 V		0.65 × V <sub>CC</sub>		0.65 × V <sub>CC</sub>		V
		V <sub>CC</sub> = 2.3 V to 2.7 V		1.7		1.7		
		V <sub>CC</sub> = 2.7 V to 3.6 V		2		2		
V <sub>IL</sub>	Low-level input voltage	V <sub>CC</sub> = 1.65 V to 1.95 V		0.35 × V <sub>CC</sub>		0.35 × V <sub>CC</sub>		V
		V <sub>CC</sub> = 2.3 V to 2.7 V		0.7		0.7		
		V <sub>CC</sub> = 2.7 V to 3.6 V		0.8		0.8		
V <sub>I</sub>	Input voltage	0	5.5	0	5.5	0	5.5	V
V <sub>O</sub>	Output voltage	High or low state		0		V <sub>CC</sub>		V
		3-state		0		5.5		
I <sub>OH</sub>	High-level output current	V <sub>CC</sub> = 1.65 V		-4		-4		mA
		V <sub>CC</sub> = 2.3 V		-8		-8		
		V <sub>CC</sub> = 2.7 V		-12		-12		
		V <sub>CC</sub> = 3 V		-24		-24		
I <sub>OL</sub>	Low-level output current	V <sub>CC</sub> = 1.65 V		4		4		mA
		V <sub>CC</sub> = 2.3 V		8		8		
		V <sub>CC</sub> = 2.7 V		12		12		
		V <sub>CC</sub> = 3 V		24		24		
Δt/Δv	Input transition rise or fall rate	6		6		6		ns/V

NOTE 7: All unused inputs of the device must be held at V<sub>CC</sub> or GND to ensure proper device operation. Refer to the TI application report, *Implications of Slow or Floating CMOS Inputs*, literature number SCBA004.



# SN54LVC574A, SN74LVC574A OCTAL EDGE-TRIGGERED D-TYPE FLIP-FLOPS WITH 3-STATE OUTPUTS

SCAS301R – JANUARY 1993 – REVISED MARCH 2005

**electrical characteristics over recommended operating free-air temperature range (unless otherwise noted)**

PARAMETER	TEST CONDITIONS	V <sub>CC</sub>	SN54LVC574A			UNIT
			-55 TO 125°C			
			MIN	TYP†	MAX	
V <sub>OH</sub>	I <sub>OH</sub> = -100 μA	2.7 V to 3.6 V	V <sub>CC</sub> - 0.2			V
	I <sub>OH</sub> = -12 mA	2.7 V	2.2			
		3 V	2.4			
	I <sub>OH</sub> = -24 mA	3 V	2.2			
V <sub>OL</sub>	I <sub>OL</sub> = 100 μA	2.7 V to 3.6 V	0.2			V
	I <sub>OL</sub> = 12 mA	2.7 V	0.4			
	I <sub>OL</sub> = 24 mA	3 V	0.55			
I <sub>I</sub>	V <sub>I</sub> = 5.5 V or GND	3.6 V	±5			μA
I <sub>OZ</sub>	V <sub>O</sub> = 0 to 5.5 V	3.6 V	±15			μA
I <sub>CC</sub>	V <sub>I</sub> = V <sub>CC</sub> or GND	3.6 V	10			μA
	3.6 V ≤ V <sub>I</sub> ≤ 5.5 V‡		10			
ΔI <sub>CC</sub>	One input at V <sub>CC</sub> - 0.6 V, Other inputs at V <sub>CC</sub> or GND	2.7 V to 3.6 V	500			μA
C <sub>i</sub>	V <sub>I</sub> = V <sub>CC</sub> or GND	3.3 V	4			pF
C <sub>o</sub>	V <sub>O</sub> = V <sub>CC</sub> or GND	3.3 V	5.5			pF

† T<sub>A</sub> = 25°C

‡ This applies in the disabled state only.

# SN54LVC574A, SN74LVC574A OCTAL EDGE-TRIGGERED D-TYPE FLIP-FLOPS WITH 3-STATE OUTPUTS

SCAS301R – JANUARY 1993 – REVISED MARCH 2005

electrical characteristics over recommended operating free-air temperature range (unless otherwise noted)

PARAMETER	TEST CONDITIONS	V <sub>CC</sub>	SN74LVC574A						UNIT	
			T <sub>A</sub> = 25°C			-40 TO 85°C		-40 TO 125°C		
			MIN	TYP	MAX	MIN	MAX	MIN		MAX
V <sub>OH</sub>	I <sub>OH</sub> = -100 μA	1.65 V to 3.6 V	V <sub>CC</sub> - 0.2			V <sub>CC</sub> - 0.2		V <sub>CC</sub> - 0.2		V
	I <sub>OH</sub> = -4 mA	1.65 V	1.29			1.2		1.2		
	I <sub>OH</sub> = -8 mA	2.3 V	1.9			1.7		1.7		
	I <sub>OH</sub> = -12 mA	2.7 V	2.2			2.2		2.2		
	I <sub>OH</sub> = -24 mA	3 V	2.4			2.4		2.4		
V <sub>OL</sub>	I <sub>OL</sub> = 100 μA	1.65 V to 3.6 V				0.1		0.2		V
	I <sub>OL</sub> = 4 mA	1.65 V				0.24		0.45		
	I <sub>OL</sub> = 8 mA	2.3 V				0.3		0.7		
	I <sub>OL</sub> = 12 mA	2.7 V				0.4		0.4		
	I <sub>OL</sub> = 24 mA	3 V				0.55		0.55		
I <sub>I</sub>	V <sub>I</sub> = 5.5 V or GND	3.6 V				±1		±5		μA
I <sub>off</sub>	V <sub>I</sub> or V <sub>O</sub> = 5.5 V	0				±4		±10		μA
I <sub>OZ</sub>	V <sub>I</sub> = 0 to 5.5 V	3.6 V				±1		±10		μA
I <sub>CC</sub>	V <sub>I</sub> = V <sub>CC</sub> or GND	3.6 V				1.5		10		μA
	3.6 V ≤ V <sub>I</sub> ≤ 5.5 V†		I <sub>O</sub> = 0			1.5		10		
ΔI <sub>CC</sub>	One input at V <sub>CC</sub> - 0.6 V, Other inputs at V <sub>CC</sub> or GND	2.7 V to 3.6 V				500		500		μA
C <sub>i</sub>	V <sub>I</sub> = V <sub>CC</sub> or GND	3.3 V				4				pF
C <sub>o</sub>	V <sub>O</sub> = V <sub>CC</sub> or GND	3.3 V				5.5				pF

† This applies in the disabled state only.

timing requirements over recommended operating free-air temperature range (unless otherwise noted) (see Figure 1)

		V <sub>CC</sub>	SN54LVC574A		UNIT
			-55 TO 125°C		
			MIN	MAX	
f <sub>clock</sub>	Clock frequency	2.7 V	150		MHz
		3.3 V ± 0.3 V	150		
t <sub>w</sub>	Pulse duration, CLK high or low	2.7 V	3.3		ns
		3.3 V ± 0.3 V	3.3		
t <sub>su</sub>	Setup time, data before CLK↑	2.7 V	2		ns
		3.3 V ± 0.3 V	2		
t <sub>h</sub>	Hold time, data after CLK↑	2.7 V	2		ns
		3.3 V ± 0.3 V	2		



# SN54LVC574A, SN74LVC574A OCTAL EDGE-TRIGGERED D-TYPE FLIP-FLOPS WITH 3-STATE OUTPUTS

SCAS301R – JANUARY 1993 – REVISED MARCH 2005

switching characteristics over recommended operating free-air temperature range (unless otherwise noted) (see Figure 1)

PARAMETER	FROM (INPUT)	TO (OUTPUT)	V <sub>CC</sub>	SN54LVC574A		UNIT
				-55 TO 125°C		
				MIN	MAX	
f <sub>max</sub>			2.7 V	150		MHz
			3.3 V ± 0.3 V	150		
t <sub>pd</sub>	CLK	Q	2.7 V	8		ns
			3.3 V ± 0.3 V	1	7	
t <sub>en</sub>	OE	Q	2.7 V	9		ns
			3.3 V ± 0.3 V	1	7.5	
t <sub>dis</sub>	OE	Q	2.7 V	7		ns
			3.3 V ± 0.3 V	0.5	6.4	

timing requirements over recommended operating free-air temperature range (unless otherwise noted) (see Figure 1)

	V <sub>CC</sub>	SN74LVC574A						UNIT	
		T <sub>A</sub> = 25°C			-40 TO 85°C		-40 TO 125°C		
		MIN	TYP	MAX	MIN	MAX	MIN		MAX
f <sub>clock</sub> Clock frequency	1.8 V ± 0.15 V			55		55		40	MHz
	2.5 V ± 0.2 V			95		95		80	
	2.7 V			150		150		150	
	3.3 V ± 0.3 V			150		150		150	
t <sub>w</sub> Pulse duration, CLK high or low	1.8 V ± 0.15 V		9		9		9	ns	
	2.5 V ± 0.2 V		4		4		4		
	2.7 V		3.3		3.3		3.3		
	3.3 V ± 0.3 V		3.3		3.3		3.3		
t <sub>su</sub> Setup time, data before CLK↑	1.8 V ± 0.15 V		6		6		6	ns	
	2.5 V ± 0.2 V		4		4		4		
	2.7 V		2		2		2		
	3.3 V ± 0.3 V		2		2		2		
t <sub>h</sub> Hold time, data after CLK↑	1.8 V ± 0.15 V		4		4		4	ns	
	2.5 V ± 0.2 V		2		2		2		
	2.7 V		1.5		1.5		1.5		
	3.3 V ± 0.3 V		1.5		1.5		1.5		

# SN54LVC574A, SN74LVC574A OCTAL EDGE-TRIGGERED D-TYPE FLIP-FLOPS WITH 3-STATE OUTPUTS

SCAS301R – JANUARY 1993 – REVISED MARCH 2005

switching characteristics over recommended operating free-air temperature range (unless otherwise noted) (see Figure 1)

PARAMETER	FROM (INPUT)	TO (OUTPUT)	V <sub>CC</sub>	SN74LVC574A						UNIT	
				T <sub>A</sub> = 25°C			-40 TO 85°C		-40 TO 125°C		
				MIN	TYP	MAX	MIN	MAX	MIN		MAX
f <sub>max</sub>			1.8 V ± 0.15 V	55			55		40		MHz
			2.5 V ± 0.2 V	95			95		80		
			2.7 V	150			150		150		
			3.3 V ± 0.3 V	150			150		150		
t <sub>pd</sub>	CLK	Q	1.8 V ± 0.15 V	1.0	7.1	21.5	1	21.6	1.0	21.6	ns
			2.5 V ± 0.2 V	1.0	4.9	10.0	1	10.5	1.0	10.5	
			2.7 V	1.0	5.0	7.8	1	8	1.0	8.0	
			3.3 V ± 0.3 V	2.2	4.6	6.8	2.2	7	2.2	7.0	
t <sub>en</sub>	OE	Q	1.8 V ± 0.15 V	1.0	6.6	19.0	1	19.5	1.0	19.5	ns
			2.5 V ± 0.2 V	1.0	4.8	10.0	1	10.5	1.0	10.5	
			2.7 V	1.0	5.5	8.3	1	8.5	1.0	8.5	
			3.3 V ± 0.3 V	1.5	4.4	7.3	1.5	7.5	1.5	7.5	
t <sub>dis</sub>	OE	Q	1.8 V ± 0.15 V	1.0	5.4	18.3	1	18.8	1.0	18.8	ns
			2.5 V ± 0.2 V	1.0	3.0	7.3	1	7.8	1.0	7.8	
			2.7 V	1.0	4.0	6.8	1	7	1.0	7.3	
			3.3 V ± 0.3 V	1.7	3.9	6.2	1.7	6.4	1.7	6.6	
t <sub>sk(o)</sub>			3.3 V ± 0.3 V				1		1	ns	

## operating characteristics, T<sub>A</sub> = 25°C

PARAMETER		TEST CONDITIONS	V <sub>CC</sub>	TYP	UNIT	
C <sub>pd</sub>	Power dissipation capacitance per flip-flop	Outputs enabled	f = 10 MHz	1.8 V	25	pF
				2.5 V	29	
				3.3 V	30	
				1.8 V	9	
				2.5 V	9	
				3.3 V	11	
	Outputs disabled					





# SN54LVC574A, SN74LVC574A OCTAL EDGE-TRIGGERED D-TYPE FLIP-FLOPS WITH 3-STATE OUTPUTS

SCAS301R – JANUARY 1993 – REVISED MARCH 2005

## PARAMETER MEASUREMENT INFORMATION

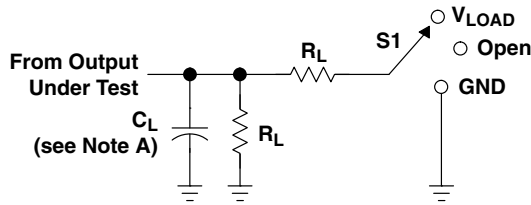

LOAD CIRCUIT

TEST	S1
$t_{PLH}/t_{PHL}$	Open
$t_{PLZ}/t_{PZL}$	$V_{LOAD}$
$t_{PHZ}/t_{PZH}$	GND

$V_{CC}$	INPUTS		$V_M$	$V_{LOAD}$	$C_L$	$R_L$	$V_{\Delta}$
	$V_I$	$t_r/t_f$					
$1.8\text{ V} \pm 0.15\text{ V}$	$V_{CC}$	$\leq 2\text{ ns}$	$V_{CC}/2$	$2 \times V_{CC}$	30 pF	1 k $\Omega$	0.15 V
$2.5\text{ V} \pm 0.2\text{ V}$	$V_{CC}$	$\leq 2\text{ ns}$	$V_{CC}/2$	$2 \times V_{CC}$	30 pF	500 $\Omega$	0.15 V
2.7 V	2.7 V	$\leq 2.5\text{ ns}$	1.5 V	6 V	50 pF	500 $\Omega$	0.3 V
$3.3\text{ V} \pm 0.3\text{ V}$	2.7 V	$\leq 2.5\text{ ns}$	1.5 V	6 V	50 pF	500 $\Omega$	0.3 V

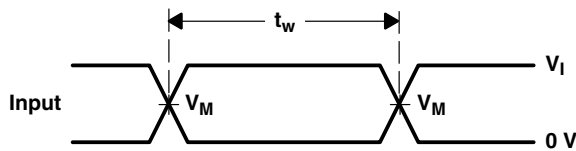

VOLTAGE WAVEFORMS  
PULSE DURATION

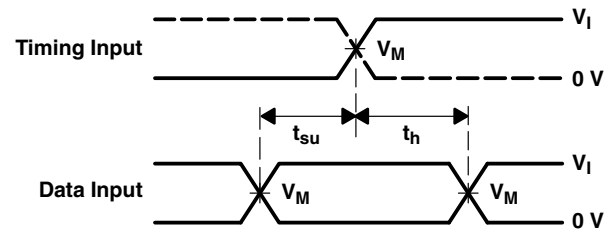

VOLTAGE WAVEFORMS  
SETUP AND HOLD TIMES



VOLTAGE WAVEFORMS  
PROPAGATION DELAY TIMES  
INVERTING AND NONINVERTING OUTPUTS



VOLTAGE WAVEFORMS  
ENABLE AND DISABLE TIMES  
LOW- AND HIGH-LEVEL ENABLING

- NOTES:
- $C_L$  includes probe and jig capacitance.
  - Waveform 1 is for an output with internal conditions such that the output is low, except when disabled by the output control. Waveform 2 is for an output with internal conditions such that the output is high, except when disabled by the output control.
  - All input pulses are supplied by generators having the following characteristics:  $PRR \leq 10\text{ MHz}$ ,  $Z_O = 50\ \Omega$ .
  - The outputs are measured one at a time, with one transition per measurement.
  - $t_{PLZ}$  and  $t_{PHZ}$  are the same as  $t_{dis}$ .
  - $t_{PZL}$  and  $t_{PZH}$  are the same as  $t_{en}$ .
  - $t_{PLH}$  and  $t_{PHL}$  are the same as  $t_{pd}$ .
  - All parameters and waveforms are not applicable to all devices.

Figure 1. Load Circuit and Voltage Waveforms

THERMAL INFORMATION

This package incorporates an exposed thermal pad that is designed to be attached directly to an external heatsink. The thermal pad must be soldered directly to the printed circuit board (PCB), the PCB can be used as a heatsink. In addition, through the use of thermal vias, the thermal pad can be attached directly to a ground plane or special heatsink structure designed into the PCB. This design optimizes the heat transfer from the integrated circuit (IC).

For information on the Quad Flatpack No-Lead (QFN) package and its advantages, refer to Application Report, Quad Flatpack No-Lead Logic Packages, Texas Instruments Literature No. SCBA017. This document is available at [www.ti.com](http://www.ti.com).

The exposed thermal pad dimensions for this package are shown in the following illustration.



Bottom View

NOTE: All linear dimensions are in millimeters

Exposed Thermal Pad Dimensions

**PACKAGING INFORMATION**

Orderable Device	Status (1)	Package Type	Package Drawing	Pins	Package Qty	Eco Plan (2)	Lead finish/ Ball material (6)	MSL Peak Temp (3)	Op Temp (°C)	Device Marking (4/5)	Samples
5962-9757601QRA	ACTIVE	CDIP	J	20	20	Non-RoHS & Green	SNPB	N / A for Pkg Type	-55 to 125	5962-9757601QR A SNJ54LVC574AJ	<a href="#">Samples</a>
5962-9757601QSA	ACTIVE	CFP	W	20	25	Non-RoHS & Green	SNPB	N / A for Pkg Type	-55 to 125	5962-9757601QS A SNJ54LVC574AW	<a href="#">Samples</a>
SN74LVC574ADBR	ACTIVE	SSOP	DB	20	2000	RoHS & Green	NIPDAU	Level-1-260C-UNLIM	-40 to 125	LC574A	<a href="#">Samples</a>
SN74LVC574ADGVR	ACTIVE	TVSOP	DGV	20	2000	RoHS & Green	NIPDAU	Level-1-260C-UNLIM	-40 to 125	LC574A	<a href="#">Samples</a>
SN74LVC574ADGVRE4	ACTIVE	TVSOP	DGV	20	2000	RoHS & Green	NIPDAU	Level-1-260C-UNLIM	-40 to 125	LC574A	<a href="#">Samples</a>
SN74LVC574ADW	ACTIVE	SOIC	DW	20	25	RoHS & Green	NIPDAU	Level-1-260C-UNLIM	-40 to 125	LVC574A	<a href="#">Samples</a>
SN74LVC574ADWE4	ACTIVE	SOIC	DW	20	25	RoHS & Green	NIPDAU	Level-1-260C-UNLIM	-40 to 125	LVC574A	<a href="#">Samples</a>
SN74LVC574ADWR	ACTIVE	SOIC	DW	20	2000	RoHS & Green	NIPDAU	Level-1-260C-UNLIM	-40 to 125	LVC574A	<a href="#">Samples</a>
SN74LVC574AN	ACTIVE	PDIP	N	20	20	RoHS & Green	NIPDAU	N / A for Pkg Type	-40 to 125	SN74LVC574AN	<a href="#">Samples</a>
SN74LVC574ANSR	ACTIVE	SO	NS	20	2000	RoHS & Green	NIPDAU	Level-1-260C-UNLIM	-40 to 125	LVC574A	<a href="#">Samples</a>
SN74LVC574APW	ACTIVE	TSSOP	PW	20	70	RoHS & Green	NIPDAU	Level-1-260C-UNLIM	-55 to 125	LC574A	<a href="#">Samples</a>
SN74LVC574APWG4	ACTIVE	TSSOP	PW	20	70	RoHS & Green	NIPDAU	Level-1-260C-UNLIM	-40 to 125	LC574A	<a href="#">Samples</a>
SN74LVC574APWR	ACTIVE	TSSOP	PW	20	2000	RoHS & Green	NIPDAU   SN	Level-1-260C-UNLIM	-40 to 125	LC574A	<a href="#">Samples</a>
SN74LVC574APWRG4	ACTIVE	TSSOP	PW	20	2000	RoHS & Green	NIPDAU	Level-1-260C-UNLIM	-40 to 125	LC574A	<a href="#">Samples</a>
SN74LVC574APWT	ACTIVE	TSSOP	PW	20	250	RoHS & Green	NIPDAU	Level-1-260C-UNLIM	-40 to 125	LC574A	<a href="#">Samples</a>
SN74LVC574ARGYR	ACTIVE	VQFN	RGY	20	3000	RoHS & Green	NIPDAU	Level-2-260C-1 YEAR	-40 to 125	LC574A	<a href="#">Samples</a>
SNJ54LVC574AJ	ACTIVE	CDIP	J	20	20	Non-RoHS & Green	SNPB	N / A for Pkg Type	-55 to 125	5962-9757601QR A SNJ54LVC574AJ	<a href="#">Samples</a>
SNJ54LVC574AW	ACTIVE	CFP	W	20	25	Non-RoHS & Green	SNPB	N / A for Pkg Type	-55 to 125	5962-9757601QS A	<a href="#">Samples</a>

Orderable Device	Status (1)	Package Type	Package Drawing	Pins	Package Qty	Eco Plan (2)	Lead finish/ Ball material (6)	MSL Peak Temp (3)	Op Temp (°C)	Device Marking (4/5)	Samples
										SNJ54LVC574AW	

(1) The marketing status values are defined as follows:

**ACTIVE:** Product device recommended for new designs.

**LIFEBUY:** TI has announced that the device will be discontinued, and a lifetime-buy period is in effect.

**NRND:** Not recommended for new designs. Device is in production to support existing customers, but TI does not recommend using this part in a new design.

**PREVIEW:** Device has been announced but is not in production. Samples may or may not be available.

**OBSOLETE:** TI has discontinued the production of the device.

(2) **RoHS:** TI defines "RoHS" to mean semiconductor products that are compliant with the current EU RoHS requirements for all 10 RoHS substances, including the requirement that RoHS substance do not exceed 0.1% by weight in homogeneous materials. Where designed to be soldered at high temperatures, "RoHS" products are suitable for use in specified lead-free processes. TI may reference these types of products as "Pb-Free".

**RoHS Exempt:** TI defines "RoHS Exempt" to mean products that contain lead but are compliant with EU RoHS pursuant to a specific EU RoHS exemption.

**Green:** TI defines "Green" to mean the content of Chlorine (Cl) and Bromine (Br) based flame retardants meet JS709B low halogen requirements of <=1000ppm threshold. Antimony trioxide based flame retardants must also meet the <=1000ppm threshold requirement.

(3) MSL, Peak Temp. - The Moisture Sensitivity Level rating according to the JEDEC industry standard classifications, and peak solder temperature.

(4) There may be additional marking, which relates to the logo, the lot trace code information, or the environmental category on the device.

(5) Multiple Device Markings will be inside parentheses. Only one Device Marking contained in parentheses and separated by a "~" will appear on a device. If a line is indented then it is a continuation of the previous line and the two combined represent the entire Device Marking for that device.

(6) Lead finish/Ball material - Orderable Devices may have multiple material finish options. Finish options are separated by a vertical ruled line. Lead finish/Ball material values may wrap to two lines if the finish value exceeds the maximum column width.

**Important Information and Disclaimer:**The information provided on this page represents TI's knowledge and belief as of the date that it is provided. TI bases its knowledge and belief on information provided by third parties, and makes no representation or warranty as to the accuracy of such information. Efforts are underway to better integrate information from third parties. TI has taken and continues to take reasonable steps to provide representative and accurate information but may not have conducted destructive testing or chemical analysis on incoming materials and chemicals. TI and TI suppliers consider certain information to be proprietary, and thus CAS numbers and other limited information may not be available for release.

In no event shall TI's liability arising out of such information exceed the total purchase price of the TI part(s) at issue in this document sold by TI to Customer on an annual basis.

**OTHER QUALIFIED VERSIONS OF SN54LVC574A, SN74LVC574A :**

- Catalog : [SN74LVC574A](#)

- Automotive : [SN74LVC574A-Q1](#), [SN74LVC574A-Q1](#)
- Enhanced Product : [SN74LVC574A-EP](#), [SN74LVC574A-EP](#)
- Military : [SN54LVC574A](#)

NOTE: Qualified Version Definitions:

- Catalog - TI's standard catalog product
- Automotive - Q100 devices qualified for high-reliability automotive applications targeting zero defects
- Enhanced Product - Supports Defense, Aerospace and Medical Applications
- Military - QML certified for Military and Defense Applications

**TAPE AND REEL INFORMATION**

**QUADRANT ASSIGNMENTS FOR PIN 1 ORIENTATION IN TAPE**

\*All dimensions are nominal

Device	Package Type	Package Drawing	Pins	SPQ	Reel Diameter (mm)	Reel Width W1 (mm)	A0 (mm)	B0 (mm)	K0 (mm)	P1 (mm)	W (mm)	Pin1 Quadrant
SN74LVC574ADBR	SSOP	DB	20	2000	330.0	16.4	8.2	7.5	2.5	12.0	16.0	Q1
SN74LVC574ADGVR	TVSOP	DGV	20	2000	330.0	12.4	6.9	5.6	1.6	8.0	12.0	Q1
SN74LVC574ADWR	SOIC	DW	20	2000	330.0	24.4	10.8	13.3	2.7	12.0	24.0	Q1
SN74LVC574ANSR	SO	NS	20	2000	330.0	24.4	8.4	13.0	2.5	12.0	24.0	Q1
SN74LVC574APWR	TSSOP	PW	20	2000	330.0	16.4	6.95	7.0	1.4	8.0	16.0	Q1
SN74LVC574APWRG4	TSSOP	PW	20	2000	330.0	16.4	6.95	7.1	1.6	8.0	16.0	Q1
SN74LVC574APWT	TSSOP	PW	20	250	330.0	16.4	6.95	7.0	1.4	8.0	16.0	Q1
SN74LVC574ARGYR	VQFN	RGY	20	3000	330.0	12.4	3.8	4.8	1.6	8.0	12.0	Q1

**TAPE AND REEL BOX DIMENSIONS**

\*All dimensions are nominal

Device	Package Type	Package Drawing	Pins	SPQ	Length (mm)	Width (mm)	Height (mm)
SN74LVC574ADBR	SSOP	DB	20	2000	356.0	356.0	35.0
SN74LVC574ADGVR	TVSOP	DGV	20	2000	356.0	356.0	35.0
SN74LVC574ADWR	SOIC	DW	20	2000	367.0	367.0	45.0
SN74LVC574ANSR	SO	NS	20	2000	367.0	367.0	45.0
SN74LVC574APWR	TSSOP	PW	20	2000	356.0	356.0	35.0
SN74LVC574APWRG4	TSSOP	PW	20	2000	356.0	356.0	35.0
SN74LVC574APWT	TSSOP	PW	20	250	356.0	356.0	35.0
SN74LVC574ARGYR	VQFN	RGY	20	3000	356.0	356.0	35.0

**TUBE**

\*All dimensions are nominal

Device	Package Name	Package Type	Pins	SPQ	L (mm)	W (mm)	T (μm)	B (mm)
5962-9757601QSA	W	CFP	20	25	506.98	26.16	6220	NA
SN74LVC574ADW	DW	SOIC	20	25	507	12.83	5080	6.6
SN74LVC574ADWE4	DW	SOIC	20	25	507	12.83	5080	6.6
SN74LVC574AN	N	PDIP	20	20	506	13.97	11230	4.32
SN74LVC574APW	PW	TSSOP	20	70	530	10.2	3600	3.5
SN74LVC574APWG4	PW	TSSOP	20	70	530	10.2	3600	3.5
SNJ54LVC574AW	W	CFP	20	25	506.98	26.16	6220	NA



J (R-GDIP-T\*\*)

14 LEADS SHOWN

CERAMIC DUAL IN-LINE PACKAGE



DIM \ PINS **	14	16	18	20
A	0.300 (7,62) BSC	0.300 (7,62) BSC	0.300 (7,62) BSC	0.300 (7,62) BSC
B MAX	0.785 (19,94)	.840 (21,34)	0.960 (24,38)	1.060 (26,92)
B MIN	—	—	—	—
C MAX	0.300 (7,62)	0.300 (7,62)	0.310 (7,87)	0.300 (7,62)
C MIN	0.245 (6,22)	0.245 (6,22)	0.220 (5,59)	0.245 (6,22)



4040083/F 03/03

- NOTES:
- All linear dimensions are in inches (millimeters).
  - This drawing is subject to change without notice.
  - This package is hermetically sealed with a ceramic lid using glass frit.
  - Index point is provided on cap for terminal identification only on press ceramic glass frit seal only.
  - Falls within MIL STD 1835 GDIP1-T14, GDIP1-T16, GDIP1-T18 and GDIP1-T20.

DGV (R-PDSO-G\*\*)

PLASTIC SMALL-OUTLINE

24 PINS SHOWN



4073251/E 08/00

- NOTES: A. All linear dimensions are in millimeters.  
 B. This drawing is subject to change without notice.  
 C. Body dimensions do not include mold flash or protrusion, not to exceed 0,15 per side.  
 D. Falls within JEDEC: 24/48 Pins – MO-153  
 14/16/20/56 Pins – MO-194

## GENERIC PACKAGE VIEW

**RGY 20**

**VQFN - 1 mm max height**

3.5 x 4.5, 0.5 mm pitch

PLASTIC QUAD FGLATPACK - NO LEAD

This image is a representation of the package family, actual package may vary.  
Refer to the product data sheet for package details.



4225264/A



4225320/A 09/2019

NOTES:

1. All linear dimensions are in millimeters. Any dimensions in parenthesis are for reference only. Dimensioning and tolerancing per ASME Y14.5M.
2. This drawing is subject to change without notice.
3. The package thermal pad must be soldered to the printed circuit board for thermal and mechanical performance.

# EXAMPLE BOARD LAYOUT

RGY0020A

VQFN - 1 mm max height

PLASTIC QUAD FLATPACK - NO LEAD



LAND PATTERN EXAMPLE  
EXPOSED METAL SHOWN  
SCALE:18X



SOLDER MASK DETAILS

4225320/A 09/2019

NOTES: (continued)

- This package is designed to be soldered to a thermal pad on the board. For more information, see Texas Instruments literature number SLUA271 ([www.ti.com/lit/slua271](http://www.ti.com/lit/slua271)).
- Vias are optional depending on application, refer to device data sheet. If any vias are implemented, refer to their locations shown on this view. It is recommended that vias under paste be filled, plugged or tented.

# EXAMPLE STENCIL DESIGN

RGY0020A

VQFN - 1 mm max height

PLASTIC QUAD FLATPACK - NO LEAD



**SOLDER PASTE EXAMPLE**  
 BASED ON 0.125 mm THICK STENCIL

EXPOSED PAD 21  
 78% PRINTED SOLDER COVERAGE BY AREA UNDER PACKAGE  
 SCALE:20X

4225320/A 09/2019

NOTES: (continued)

6. Laser cutting apertures with trapezoidal walls and rounded corners may offer better paste release. IPC-7525 may have alternate design recommendations.

N (R-PDIP-T\*\*)

PLASTIC DUAL-IN-LINE PACKAGE

16 PINS SHOWN



- NOTES:
- A. All linear dimensions are in inches (millimeters).
  - B. This drawing is subject to change without notice.
  - Falls within JEDEC MS-001, except 18 and 20 pin minimum body length (Dim A).
  - The 20 pin end lead shoulder width is a vendor option, either half or full width.

# DW0020A



# PACKAGE OUTLINE

## SOIC - 2.65 mm max height

SOIC



4220724/A 05/2016

**NOTES:**

1. All linear dimensions are in millimeters. Dimensions in parenthesis are for reference only. Dimensioning and tolerancing per ASME Y14.5M.
2. This drawing is subject to change without notice.
3. This dimension does not include mold flash, protrusions, or gate burrs. Mold flash, protrusions, or gate burrs shall not exceed 0.15 mm per side.
4. This dimension does not include interlead flash. Interlead flash shall not exceed 0.43 mm per side.
5. Reference JEDEC registration MS-013.



# EXAMPLE BOARD LAYOUT

DW0020A

SOIC - 2.65 mm max height

SOIC



LAND PATTERN EXAMPLE  
SCALE:6X



SOLDER MASK DETAILS

4220724/A 05/2016

NOTES: (continued)

- 6. Publication IPC-7351 may have alternate designs.
- 7. Solder mask tolerances between and around signal pads can vary based on board fabrication site.

# EXAMPLE STENCIL DESIGN

DW0020A

SOIC - 2.65 mm max height

SOIC



SOLDER PASTE EXAMPLE  
BASED ON 0.125 mm THICK STENCIL  
SCALE:6X

4220724/A 05/2016

NOTES: (continued)

8. Laser cutting apertures with trapezoidal walls and rounded corners may offer better paste release. IPC-7525 may have alternate design recommendations.
9. Board assembly site may have different recommendations for stencil design.

W (R-GDFP-F20)

CERAMIC DUAL FLATPACK



- NOTES:
- A. All linear dimensions are in inches (millimeters).
  - B. This drawing is subject to change without notice.
  - C. This package can be hermetically sealed with a ceramic lid using glass frit.
  - D. Index point is provided on cap for terminal identification only.
  - E. Falls within Mil-Std 1835 GDFP2-F20

PW0020A



# PACKAGE OUTLINE

## TSSOP - 1.2 mm max height

SMALL OUTLINE PACKAGE



4220206/A 02/2017

NOTES:

1. All linear dimensions are in millimeters. Any dimensions in parenthesis are for reference only. Dimensioning and tolerancing per ASME Y14.5M.
2. This drawing is subject to change without notice.
3. This dimension does not include mold flash, protrusions, or gate burrs. Mold flash, protrusions, or gate burrs shall not exceed 0.15 mm per side.
4. This dimension does not include interlead flash. Interlead flash shall not exceed 0.25 mm per side.
5. Reference JEDEC registration MO-153.

# EXAMPLE BOARD LAYOUT

PW0020A

TSSOP - 1.2 mm max height

SMALL OUTLINE PACKAGE



LAND PATTERN EXAMPLE  
EXPOSED METAL SHOWN  
SCALE: 10X



SOLDER MASK DETAILS

4220206/A 02/2017

NOTES: (continued)

- 6. Publication IPC-7351 may have alternate designs.
- 7. Solder mask tolerances between and around signal pads can vary based on board fabrication site.

# EXAMPLE STENCIL DESIGN

PW0020A

TSSOP - 1.2 mm max height

SMALL OUTLINE PACKAGE



SOLDER PASTE EXAMPLE  
BASED ON 0.125 mm THICK STENCIL  
SCALE: 10X

4220206/A 02/2017

NOTES: (continued)

8. Laser cutting apertures with trapezoidal walls and rounded corners may offer better paste release. IPC-7525 may have alternate design recommendations.
9. Board assembly site may have different recommendations for stencil design.

PW (R-PDSO-G20)

PLASTIC SMALL OUTLINE



- NOTES:
- A. All linear dimensions are in millimeters.
  - B. This drawing is subject to change without notice.
  - C. Publication IPC-7351 is recommended for alternate design.
  - D. Laser cutting apertures with trapezoidal walls and also rounding corners will offer better paste release. Customers should contact their board assembly site for stencil design recommendations. Refer to IPC-7525 for other stencil recommendations.
  - E. Customers should contact their board fabrication site for solder mask tolerances between and around signal pads.

# DB0020A

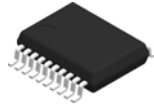

# PACKAGE OUTLINE

## SSOP - 2 mm max height

SMALL OUTLINE PACKAGE



4214851/B 08/2019

**NOTES:**

1. All linear dimensions are in millimeters. Any dimensions in parenthesis are for reference only. Dimensioning and tolerancing per ASME Y14.5M.
2. This drawing is subject to change without notice.
3. This dimension does not include mold flash, protrusions, or gate burrs. Mold flash, protrusions, or gate burrs shall not exceed 0.15 mm per side.
4. This dimension does not include interlead flash. Interlead flash shall not exceed 0.25 mm per side.
5. Reference JEDEC registration MO-150.



# EXAMPLE BOARD LAYOUT

DB0020A

SSOP - 2 mm max height

SMALL OUTLINE PACKAGE



LAND PATTERN EXAMPLE  
EXPOSED METAL SHOWN  
SCALE: 10X

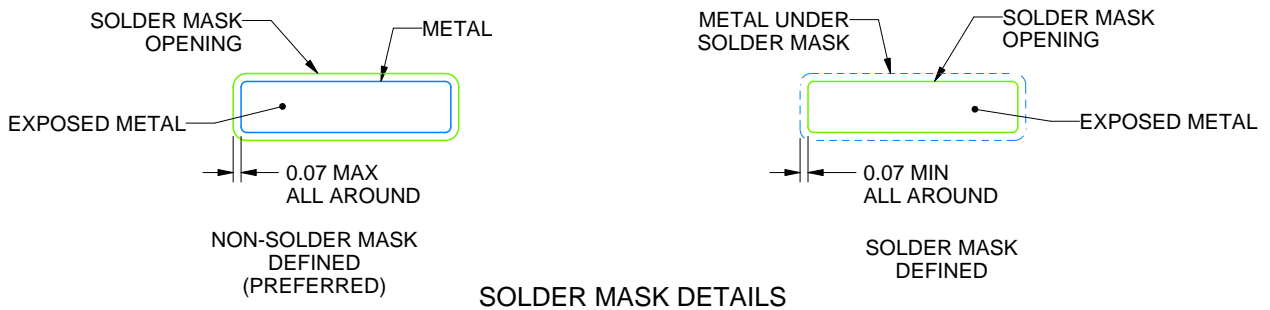

4214851/B 08/2019

NOTES: (continued)

- 6. Publication IPC-7351 may have alternate designs.
- 7. Solder mask tolerances between and around signal pads can vary based on board fabrication site.

# EXAMPLE STENCIL DESIGN

DB0020A

SSOP - 2 mm max height

SMALL OUTLINE PACKAGE



SOLDER PASTE EXAMPLE  
BASED ON 0.125 mm THICK STENCIL  
SCALE: 10X

4214851/B 08/2019

NOTES: (continued)

8. Laser cutting apertures with trapezoidal walls and rounded corners may offer better paste release. IPC-7525 may have alternate design recommendations.
9. Board assembly site may have different recommendations for stencil design.

# MECHANICAL DATA

NS (R-PDSO-G\*\*)

PLASTIC SMALL-OUTLINE PACKAGE

14-PINS SHOWN



- NOTES:
- A. All linear dimensions are in millimeters.
  - B. This drawing is subject to change without notice.
  - C. Body dimensions do not include mold flash or protrusion, not to exceed 0,15.

## IMPORTANT NOTICE AND DISCLAIMER

TI PROVIDES TECHNICAL AND RELIABILITY DATA (INCLUDING DATA SHEETS), DESIGN RESOURCES (INCLUDING REFERENCE DESIGNS), APPLICATION OR OTHER DESIGN ADVICE, WEB TOOLS, SAFETY INFORMATION, AND OTHER RESOURCES "AS IS" AND WITH ALL FAULTS, AND DISCLAIMS ALL WARRANTIES, EXPRESS AND IMPLIED, INCLUDING WITHOUT LIMITATION ANY IMPLIED WARRANTIES OF MERCHANTABILITY, FITNESS FOR A PARTICULAR PURPOSE OR NON-INFRINGEMENT OF THIRD PARTY INTELLECTUAL PROPERTY RIGHTS.

These resources are intended for skilled developers designing with TI products. You are solely responsible for (1) selecting the appropriate TI products for your application, (2) designing, validating and testing your application, and (3) ensuring your application meets applicable standards, and any other safety, security, regulatory or other requirements.

These resources are subject to change without notice. TI grants you permission to use these resources only for development of an application that uses the TI products described in the resource. Other reproduction and display of these resources is prohibited. No license is granted to any other TI intellectual property right or to any third party intellectual property right. TI disclaims responsibility for, and you will fully indemnify TI and its representatives against, any claims, damages, costs, losses, and liabilities arising out of your use of these resources.

TI's products are provided subject to [TI's Terms of Sale](#) or other applicable terms available either on [ti.com](https://www.ti.com) or provided in conjunction with such TI products. TI's provision of these resources does not expand or otherwise alter TI's applicable warranties or warranty disclaimers for TI products.

TI objects to and rejects any additional or different terms you may have proposed.

Mailing Address: Texas Instruments, Post Office Box 655303, Dallas, Texas 75265  
Copyright © 2024, Texas Instruments Incorporated