

SN55LVCP22 QML Class Q 2x2 1-Gbps LVDS Crosspoint Switch

1 Features

- QML class Q, SMD [5962-11242](#)
- High-speed (up to 1000 Mbps)
- Low-jitter fully differential data path
- 50 ps (typ), of peak-to-peak jitter with PRBS = $2^{23}-1$ pattern
- Less than 227 mW (typ), 313 mW (max) total power dissipation
- Output (channel-to-channel) skew is 80 ps (typ)
- Configurable as 2:1 mux, 1:2 demux, repeater or 1:2 signal splitter
- Inputs accept LVDS, LVPECL, and CML signals
- Fast switch time of 1.7 ns (typ)
- Fast propagation delay of 0.65 ns (typ)
- Inter-operates with TIA/EIA-644-A LVDS standard
- Supports defense, aerospace, and medical applications:
 - Controlled baseline
 - One assembly/test site and one fabrication site
 - Extended product life cycle and extended product-change notification
 - Product traceability

2 Applications

- [Global positioning system receiver](#)
- [Defense radio](#)
- [Sonar](#)
- [Seeker front end](#)
- [Radar](#)

3 Description

The SN55LVCP22 is a 2x2 crosspoint switch providing greater than 1000 Mbps operation for each path. The dual channels incorporate wide common-mode (0 V to 4 V) receivers, allowing for the receipt of LVDS, LVPECL, and CML signals. The dual outputs are LVDS drivers to provide low-power, low-EMI, high-speed operation. The SN55LVCP22 provides a single device supporting 2:2 buffering (repeating), 1:2 splitting, 2:1 multiplexing, 2x2 switching, and LVPECL/CML to LVDS level translation on each channel. The flexible operation of the SN55LVCP22 provides a single device to support the redundant serial bus transmission needs (working and protection switching cards) of fault-tolerant switch systems found in optical networking, wireless infrastructure, and data communications systems.

The SN55LVCP22 uses a fully differential data path to ensure low-noise generation, fast switching times, low pulse width distortion, and low jitter. Output channel-to-channel skew is 80 ps (typ) to ensure accurate alignment of outputs in all applications.

Device Information

PART NUMBER	GRADE	PACKAGE ⁽¹⁾	BODY SIZE (NOM)
5962-112420 1QFA	QMLQ	CFP (16)	6.73 mm x 10.3 mm

(1) For all available packages, see the orderable addendum at the end of the data sheet.

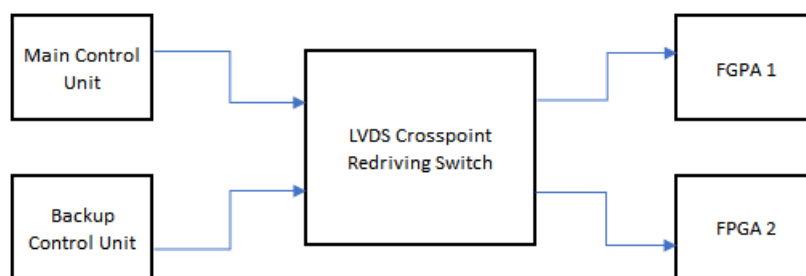

Simplified Application



Table of Contents

1 Features	1	8.2 Functional Block Diagram.....	14
2 Applications	1	8.3 Feature Description.....	14
3 Description	1	8.4 Device Functional Modes.....	14
4 Revision History	2	9 Application and Implementation	16
5 Pin Configuration and Functions	3	9.1 Application Information.....	16
6 Specifications	4	9.2 Typical Application.....	16
6.1 Absolute Maximum Ratings.....	4	10 Power Supply Recommendations	19
6.2 Handling Ratings.....	4	11 Layout	20
6.3 Recommended Operating Conditions.....	4	11.1 Layout Guidelines.....	20
6.4 Thermal Information.....	4	11.2 Layout Example.....	20
6.5 Electrical Characteristics.....	4	12 Device and Documentation Support	21
6.6 Switching Characteristics.....	6	12.1 Trademarks.....	21
6.7 Typical Characteristics.....	7	12.2 Electrostatic Discharge Caution.....	21
7 Parameter Measurement Information	10	12.3 Glossary.....	21
8 Detailed Description	14	13 Mechanical, Packaging, and Orderable Information	21
8.1 Overview.....	14		

4 Revision History

NOTE: Page numbers for previous revisions may differ from page numbers in the current version.

DATE	REVISION	NOTES
September 2020	*	Initial Release

5 Pin Configuration and Functions

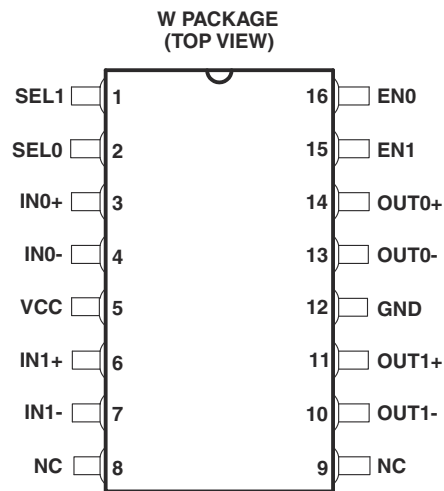

NC - No internal connection

Pin Functions

TERMINAL		I/O	DESCRIPTION
NAME	NO.		
SEL1	1	Input	Switch Selection Control 1
SEL0	2	Input	Switch Selection Control 2
IN0+	3	Input	LVDS Receiver Positive Input 0
IN0-	4	Input	LVDS Receiver Negative Input 0
VCC	5	Power	3.3V Supply Voltage
IN1+	6	Input	LVDS Receiver Positive Input 1
IN1-	7	Input	LVDS Receiver Negative Input 1
NC	8	N/A	No Internal Connection
NC	9	N/A	No Internal Connection
OUT1-	10	Output	LVDS Driver Negative Output 1
OUT1+	11	Output	LVDS Driver Positive Output 1
GND	12	Ground	Ground
OUT0-	13	Output	LVDS Driver Negative Output 0
OUT0+	14	Output	LVDS Driver Positive Output 0
EN1	15	Input	Output Enable for Driver 1
EN0	16	Input	Output Enable for Driver 0

6 Specifications

6.1 Absolute Maximum Ratings

over operating free-air temperature range unless otherwise noted⁽¹⁾

	UNIT
Supply voltage ⁽²⁾ , V_{CC}	-0.5 V to 4 V
CMOS/TTL input voltage (EN0, EN1, SEL0, SEL1)	-0.5 V to 4 V
LVDS receiver input voltage (IN+, IN-)	-0.7 V to 4.3 V
LVDS driver output voltage (OUT+, OUT-)	-0.5 V to 4 V
LVDS output short circuit current	Continuous
Maximum Junction temperature	150°C

- (1) Stresses beyond those listed under *absolute maximum ratings* may cause permanent damage to the device. These are stress ratings only, and functional operation of the device at these or any other conditions beyond those indicated under *recommended operating conditions* is not implied. Exposure to absolute-maximum-rated conditions for extended periods may affect device reliability.
- (2) All voltage values, except differential I/O bus voltages, are with respect to network ground terminals.

6.2 Handling Ratings

		MIN	MAX	UNIT	
T_{stg}	Storage temperature range	-65	125	°C	
$V_{(ESD)}$	Electrostatic discharge	Human body model (HBM), per ANSI/ESDA/JEDEC JS-001, all pins ⁽¹⁾	-5000	5000	V
		Charged device model (CDM), per JEDEC specification JESD22-C101, all pins ⁽²⁾	-500	500	

- (1) JEDEC document JEP155 states that 500-V HBM allows safe manufacturing with a standard ESD control process.
- (2) JEDEC document JEP157 states that 250-V CDM allows safe manufacturing with a standard ESD control process.

6.3 Recommended Operating Conditions

	MIN	NOM	MAX	UNIT
Supply voltage, V_{CC}	3	3.3	3.6	V
Receiver input voltage	0		4	V
Operating case (top) temperature, T_C ⁽¹⁾	-55		125	°C
Magnitude of differential input voltage, $ V_{ID} $	0.1		3	V

- (1) Maximum case temperature operation is allowed as long as the device maximum junction temperature is not exceeded.

6.4 Thermal Information

THERMAL METRIC ⁽¹⁾		SN55LVCP22A-SP	
		W (CFP)	UNIT
		16 PINS	
$R_{\theta JA}$	Junction-to-ambient thermal resistance	118.1	°C/W
$R_{\theta JC(top)}$	Junction-to-case (top) thermal resistance	51.2	°C/W
$R_{\theta JB}$	Junction-to-board thermal resistance	107.2	°C/W
Ψ_{JT}	Junction-to-top characterization parameter	28.4	°C/W
Ψ_{JB}	Junction-to-board characterization parameter	95.1	°C/W

- (1) For more information about traditional and new thermal metrics, see the [Semiconductor and IC Package Thermal Metrics](#) application report.

6.5 Electrical Characteristics

over recommended operating conditions unless otherwise noted

PARAMETER		TEST CONDITIONS			MIN	TYP ⁽¹⁾	MAX	UNIT
CMOS/TTL DC SPECIFICATIONS (EN0, EN1, SEL0, SEL1)								
V_{IH}	High-level input voltage				2	1.5	V_{CC}	V

over recommended operating conditions unless otherwise noted

PARAMETER		TEST CONDITIONS	MIN	TYP ⁽¹⁾	MAX	UNIT
V _{IL}	Low-level input voltage		GND	1.5	0.8	V
I _{IH}	High-level input current	V _{IN} = 3.6 V or 2.0 V, V _{CC} = 3.6 V	-25	±3	25	μA
I _{IL}	Low-level input current	V _{IN} = 0.0 V or 0.8 V, V _{CC} = 3.6 V	-15	±1	15	μA
V _{CL}	Input clamp voltage	I _{CL} = -18 mA		-0.8	-1.5	V

LVDS OUTPUT SPECIFICATIONS (OUT0, OUT1)

V _{OD}	Differential output voltage	R _L = 75 Ω, See Figure 7-3	255	390	475	mV
		R _L = 75 Ω, V _{CC} = 3.3 V, T _A = 25°C, See Figure 7-3	320	390	430	
Δ V _{OD}	Change in differential output voltage magnitude between logic states	V _{ID} = ±100 mV, See Figure 7-3	-25		25	mV
V _{OS}	Steady-state offset voltage	See Figure 7-4	1	1.2	1.45	V
ΔV _{OS}	Change in steady-state offset voltage between logic states	See Figure 7-4	-25		25	mV
V _{OC(PP)}	Peak-to-peak common-mode output voltage	See Figure 7-4		50		mV
I _{OZ}	High-impedance output current	V _{OUT} = GND or V _{CC}	-15		15	μA
I _{OFF}	Power-off leakage current	V _{CC} = 0 V, 1.5 V; V _{OUT} = 3.6 V or GND	-15		15	μA
I _{OS}	Output short-circuit current	V _{OUT+} or V _{OUT-} = 0 V			-8	mA
I _{OSB}	Both outputs short-circuit current	V _{OUT+} and V _{OUT-} = 0 V	-8		8	mA
C _O	Differential output capacitance	V _I = 0.4 sin(4E6πt) + 0.5 V		3		pF

LVDS RECEIVER DC SPECIFICATIONS (IN0, IN1)

V _{TH}	Positive-going differential input voltage threshold	See Figure 7-2 and Table 7-1			100	mV
V _{TL}	Negative-going differential input voltage threshold	See Figure 7-2 and Table 7-1	-100			mV
V _{ID(HYS)}	Differential input voltage hysteresis			20	150	mV
V _{CMR}	Common-mode voltage range	V _{ID} = 100 mV, V _{CC} = 3.0 V to 3.6 V	0.05		3.95	V
I _{IN}	Input current	V _{IN} = 4 V, V _{CC} = 3.6 V or 0.0	-18	±1	18	μA
		V _{IN} = 0 V, V _{CC} = 3.6V or 0.0	-18	±1	18	
C _{IN}	Differential input capacitance	V _I = 0.4 sin (4E6πt) + 0.5 V		3		pF

SUPPLY CURRENT

I _{CCQ}	Quiescent supply current	R _L = 75 Ω, EN0=EN1=High		60	87	mA
I _{CCD}	Total supply current	R _L = 75 Ω, C _L = 5 pF, 500 MHz (1000 Mbps), EN0=EN1=High		63	87	mA
I _{CCZ}	3-state supply current	EN0 = EN1 = Low		25	35	mA

(1) All typical values are at 25°C and with a 3.3-V supply.

6.6 Switching Characteristics

over recommended operating conditions unless otherwise noted

parameter		TEST CONDITIONS	MIN	TYP	MAX	UNIT
t_{SET}	Input to SEL setup time	See Figure 7-7		0.8	2.2	ns
t_{HOLD}	Input to SEL hold time	See Figure 7-7		1.0	2.2	ns
t_{SWITCH}	SEL to switched output	See Figure 7-7		1.7	2.6	ns
t_{PHZ}	Disable time, high-level-to-high-impedance	See Figure 7-6		2	8	ns
t_{PLZ}	Disable time, low-level-to-high-impedance	See Figure 7-6		2	8	ns
t_{PZH}	Enable time, high-impedance -to-high-level output	See Figure 7-6		2	8	ns
t_{PZL}	Enable time, high-impedance-to-low-level output	See Figure 7-6		2	8	ns
t_{LHT}	Differential output signal rise time (20%-80%) ⁽¹⁾	$C_L = 5$ pF, See Figure 7-5		280	620	ps
t_{HLT}	Differential output signal fall time (20%-80%) ⁽¹⁾	$C_L = 5$ pF, See Figure 7-5		280	620	ps
t_{JIT}	Added peak-to-peak jitter ⁽³⁾	$V_{ID} = 200$ mV, 50% duty cycle, $V_{CM} = 1.2$ V, 50 MHz, $C_L = 5$ pF		13.7	22.2	ps
		$V_{ID} = 200$ mV, 50% duty cycle, $V_{CM} = 1.2$ V, 240 MHz, $C_L = 5$ pF		13.4	24.5	
		$V_{ID} = 200$ mV, 50% duty cycle, $V_{CM} = 1.2$ V, 500 MHz, $C_L = 5$ pF		14.4	35.7	
		$V_{ID} = 200$ mV, PRBS = 2 ¹⁵ -1 data pattern, $V_{CM} = 1.2$ V, 240 Mbps, $C_L = 5$ pF		68.3	204	ps
		$V_{ID} = 200$ mV, PRBS = 2 ¹⁵ -1 data pattern, $V_{CM} = 1.2$ V, 1000 Mbps, $C_L = 5$ pF		73.2	282	
t_{Jrms}	Added random jitter (rms) ⁽³⁾	$V_{ID} = 200$ mV, 50% duty cycle, $V_{CM} = 1.2$ V, 50 MHz, $C_L = 5$ pF		0.97	1.5	ps _{RMS}
		$V_{ID} = 200$ mV, 50% duty cycle, $V_{CM} = 1.2$ V, 240 MHz, $C_L = 5$ pF		0.85	1.53	
		$V_{ID} = 200$ mV, 50% duty cycle, $V_{CM} = 1.2$ V, 500 MHz, $C_L = 5$ pF		0.86	1.79	
t_{PLHD}	Propagation delay time, low-to-high-level output ⁽¹⁾		200	650	2350	ps
t_{PHLD}	Propagation delay time, high-to-low-level output ⁽¹⁾		200	650	2350	ps
t_{skew} ⁽⁵⁾	Pulse skew ($ t_{PLHD} - t_{PHLD} $) ⁽²⁾	$C_L = 5$ pF, See Figure 7-5		45	160	ps
t_{CCS}	Output channel-to-channel skew, splitter mode	$C_L = 5$ pF, See Figure 7-5		80		ps
f_{MAX} ⁽⁵⁾	Maximum operating frequency ⁽⁴⁾		1			GHz

(1) Input: $V_{IC} = 1.2$ V, $V_{ID} = 200$ mV, 50% duty cycle, 1 MHz, $t_r/t_f = 500$ ps

(2) t_{skew} is the magnitude of the time difference between the t_{PLHD} and t_{PHLD} of any output of a single device.

(3) Not production tested.

(4) Signal generator conditions: 50% duty cycle, t_r or $t_f \leq 100$ ps (10% to 90%), transmitter output criteria: duty cycle = 45% to 55% $V_{OD} \geq 300$ mV.

(5) t_{skew} and f_{MAX} parameters are guaranteed by characterization, but not production tested.

6.7 Typical Characteristics

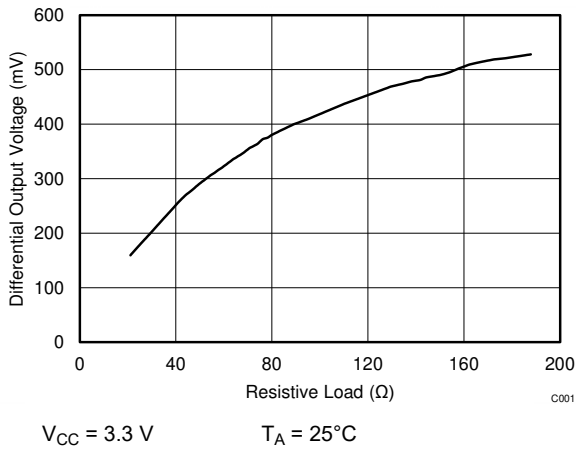

Figure 6-1. Differential Output Voltage vs Resistive Load

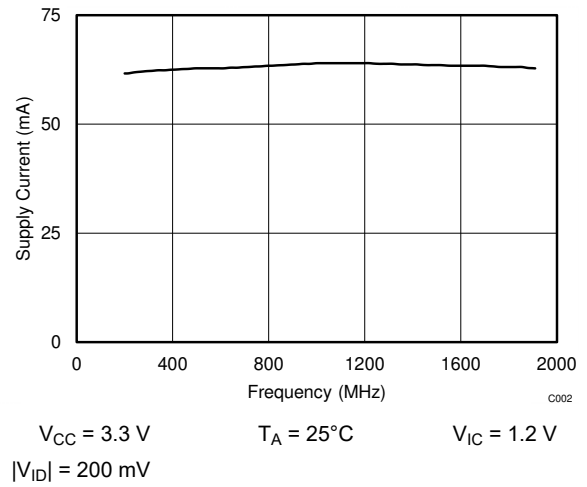

Figure 6-2. Supply Current vs Frequency

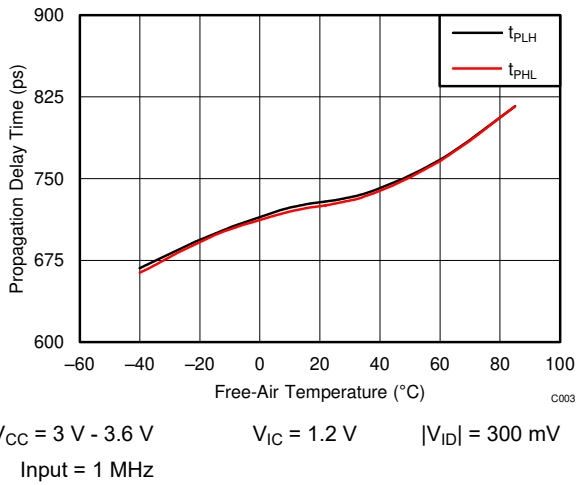

Figure 6-3. Propagation Delay Time vs Free-Air Temperature

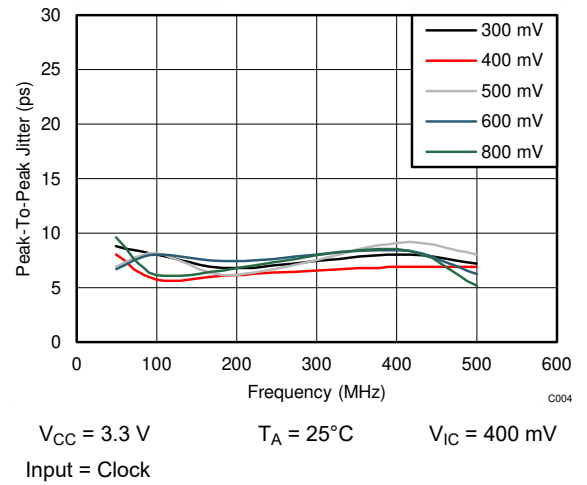
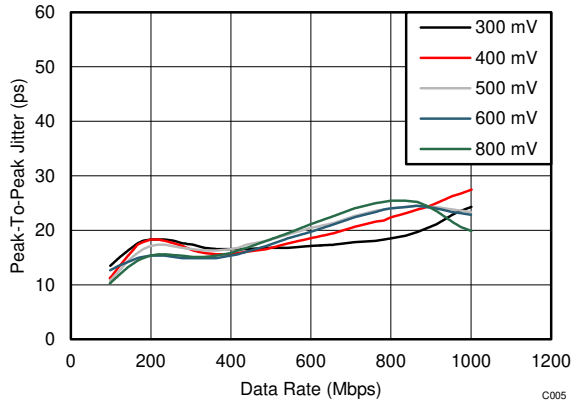
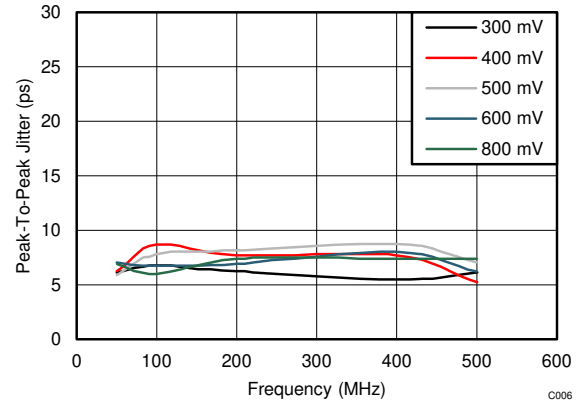

Figure 6-4. Peak-To-Peak Jitter vs Frequency



$V_{CC} = 3.3\text{ V}$ $T_A = 25^\circ\text{C}$ $V_{IC} = 400\text{ mV}$
Input = PRBS $2^{23} - 1$

Figure 6-5. Peak-To-Peak Jitter vs Data Rate



$V_{CC} = 3.3\text{ V}$ $T_A = 25^\circ\text{C}$ $V_{IC} = 1.2\text{ V}$
Input = Clock

Figure 6-6. Peak-To-Peak Jitter vs Frequency

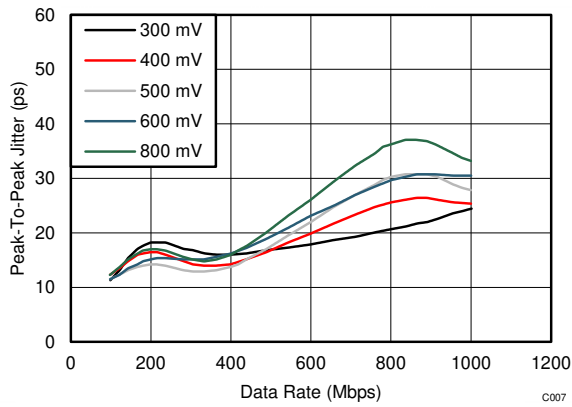

$V_{CC} = 3.3\text{ V}$ $T_A = 25^\circ\text{C}$ $V_{IC} = 1.2\text{ V}$
Input = PRBS $2^{23} - 1$

Figure 6-7. Peak-To-Peak Jitter vs Data Rate

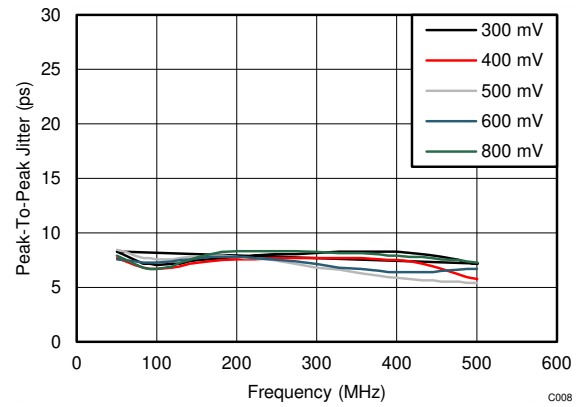

$V_{CC} = 3.3\text{ V}$ $T_A = 25^\circ\text{C}$ $V_{IC} = 1.6\text{ V}$
Input = Clock

Figure 6-8. Peak-To-Peak Jitter vs Frequency

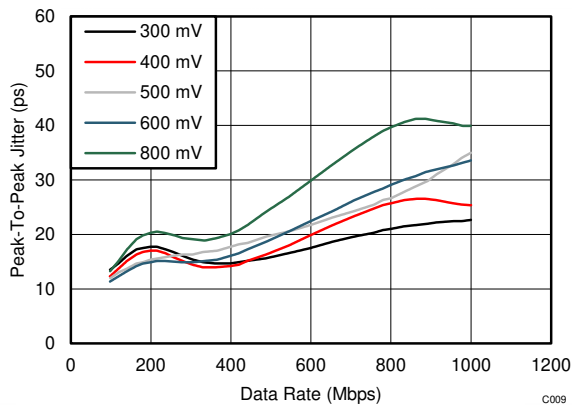

$V_{CC} = 3.3\text{ V}$ $T_A = 25^\circ\text{C}$ $V_{IC} = 1.6\text{ V}$
Input = PRBS $2^{23} - 1$

Figure 6-9. Peak-To-Peak Jitter vs Data Rate

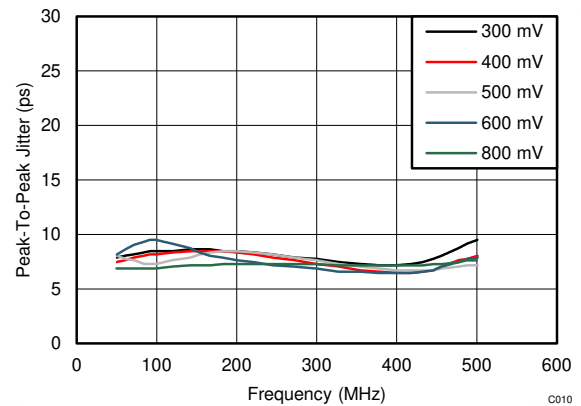

$V_{CC} = 3.3\text{ V}$ $T_A = 25^\circ\text{C}$ $V_{IC} = 3.3\text{ V}$
Input = Clock

Figure 6-10. Peak-To-Peak Jitter vs Frequency

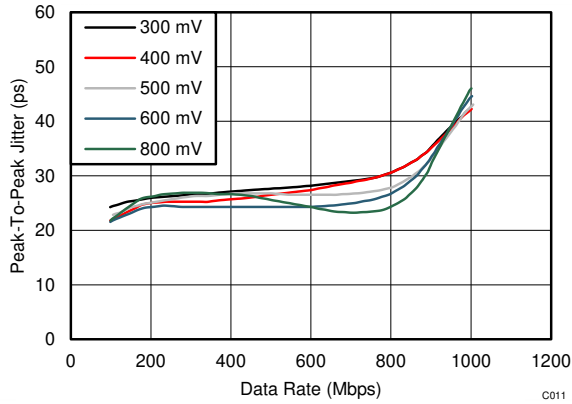

$V_{CC} = 3.3\text{ V}$ $T_A = 25^\circ\text{C}$ $V_{IC} = 3.3\text{ V}$
Input = PRBS $2^{23} - 1$

Figure 6-11. Peak-To-Peak Jitter vs Data Rate

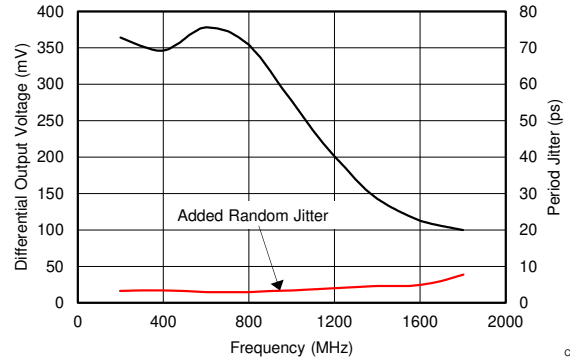

$V_{CC} = 3.3\text{ V}$ $T_A = 25^\circ\text{C}$ $V_{IC} = 1.2\text{ V}$
 $|V_{ID}| = 200\text{ mV}$

Figure 6-12. Differential Output Voltage vs Frequency

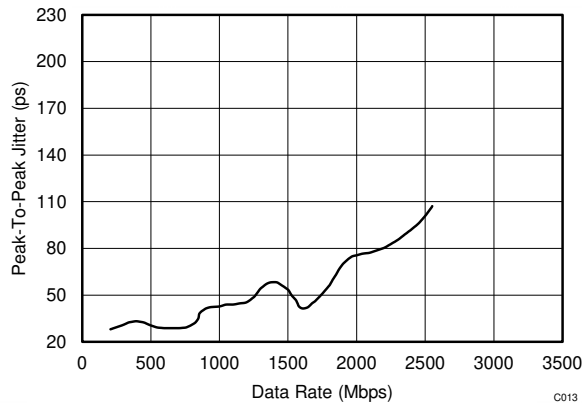

$V_{CC} = 3.3\text{ V}$ $T_A = 25^\circ\text{C}$ $V_{IC} = 1.2\text{ V}$
 $|V_{ID}| = 200\text{ mV}$ Input = PRBS $2^{23} - 1$

Figure 6-13. Peak-To-Peak Jitter vs Data Rate

7 Parameter Measurement Information

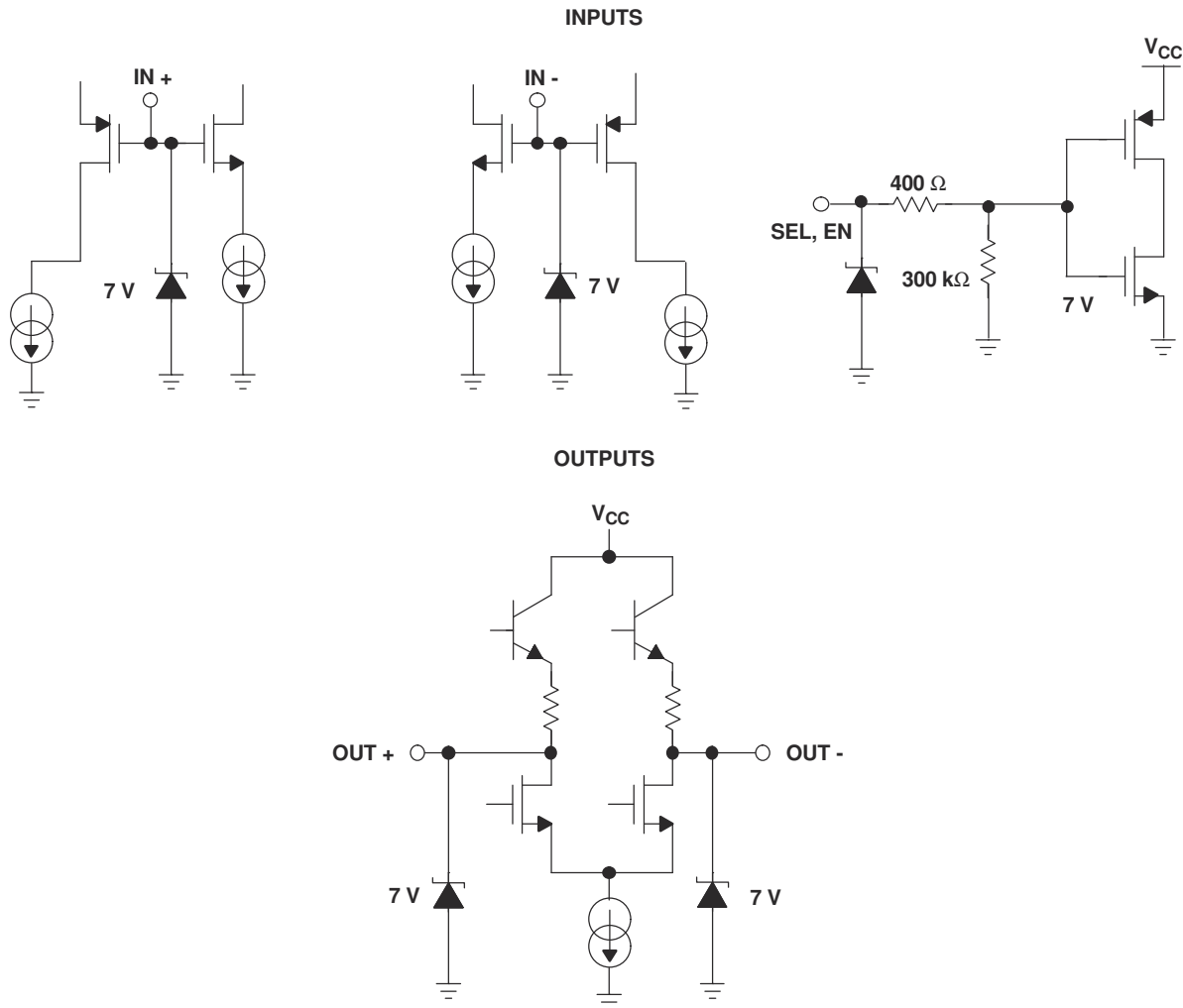

Figure 7-1. Equivalent Input and Output Schematic Diagrams

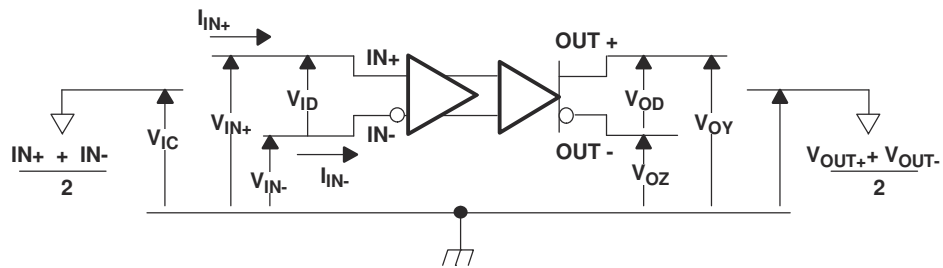

Figure 7-2. Voltage And Current Definitions

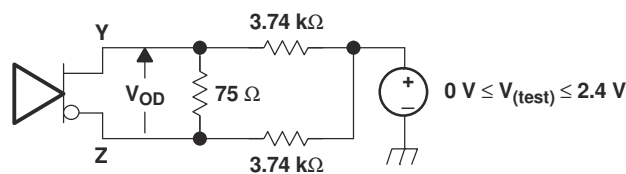
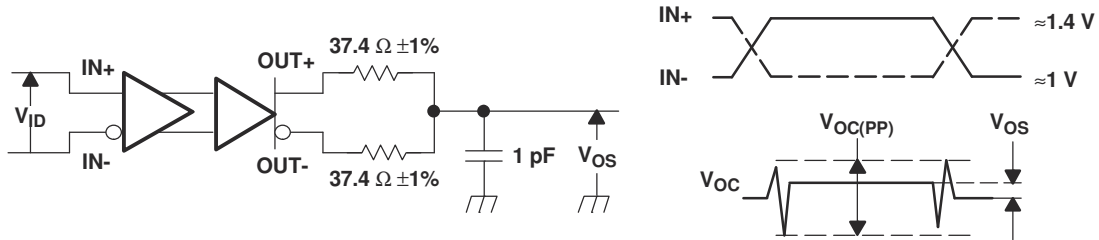
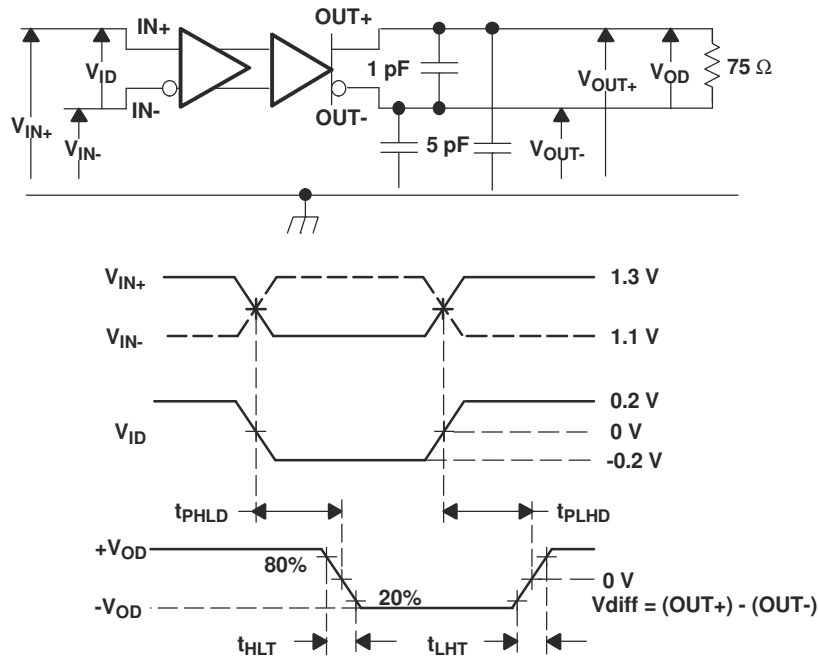

Figure 7-3. Differential Output Voltage (V_{OD}) Test Circuit



All input pulses are supplied by a generator having the following characteristics: t_r or $t_f \leq 1$ ns, pulse-repetition rate (PRR) = 0.5 Mpps, pulse width = 500 ± 10 ns; $R_L = 100 \Omega$; C_L includes instrumentation and fixture capacitance within 0,06 mm of the D.U.T.; the measurement of $V_{OC(PP)}$ is made on test equipment with a -3 dB bandwidth of at least 300 MHz.

Figure 7-4. Test Circuit And Definitions For The Driver Common-Mode Output Voltage



All input pulses are supplied by a generator having the following characteristics: t_r or $t_f \leq .25$ ns, pulse-repetition rate (PRR) = 0.5 Mpps, pulse width = 500 ± 10 ns. C_L includes instrumentation and fixture capacitance within 0,06 mm of the D.U.T.

Figure 7-5. Timing Test Circuit And Waveforms

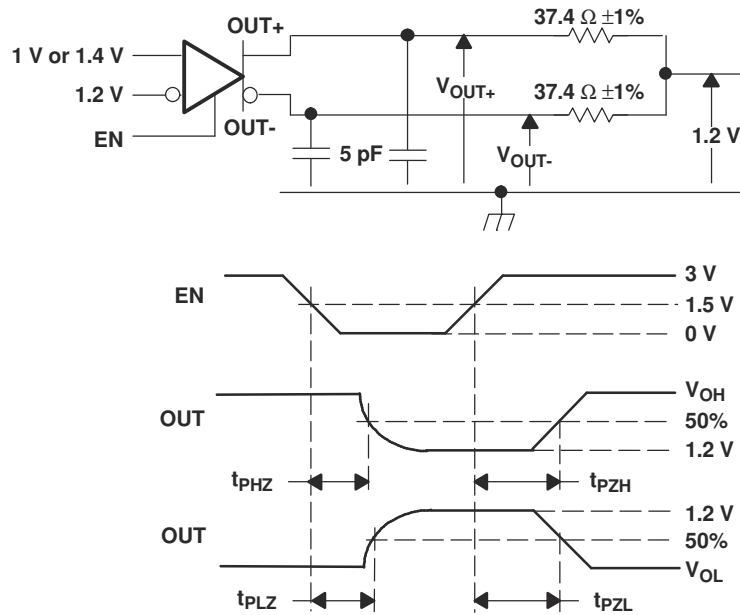

All input pulses are supplied by a generator having the following characteristics: t_r or $t_f \leq 1$ ns, pulse-repetition rate (PRR) = 0.5 Mpps, pulse width = 500 ± 10 ns. C_L includes instrumentation and fixture capacitance within 0,06 mm of the D.U.T.

Figure 7-6. Enable And Disable Time Circuit And Definitions

Table 7-1. Receiver Input Voltage Threshold Test

APPLIED VOLTAGES		RESULTING DIFFERENTIAL INPUT VOLTAGE	RESULTING COMMON-MODE INPUT VOLTAGE	OUTPUT ⁽¹⁾
V_{IA}	V_{IB}	V_{ID}	V_{IC}	
1.25 V	1.15 V	100 mV	1.2 V	H
1.15 V	1.25 V	-100 mV	1.2 V	L
4.0 V	3.9 V	100 mV	3.95 V	H
3.9 V	4.0 V	-100 mV	3.95 V	L
0.1 V	0.0 V	100 mV	0.05 V	H
0.0 V	0.1 V	-100 mV	0.05 V	L
1.7 V	0.7 V	1000 mV	1.2 V	H
0.7 V	1.7 V	-1000 mV	1.2 V	L
4.0 V	3.0 V	1000 mV	3.5 V	H
3.0 V	4.0 V	-1000 mV	3.5 V	L
1.0 V	0.0 V	1000 mV	0.5 V	H
0.0 V	1.0 V	-1000 mV	0.5 V	L

(1) H = high level, L = low level

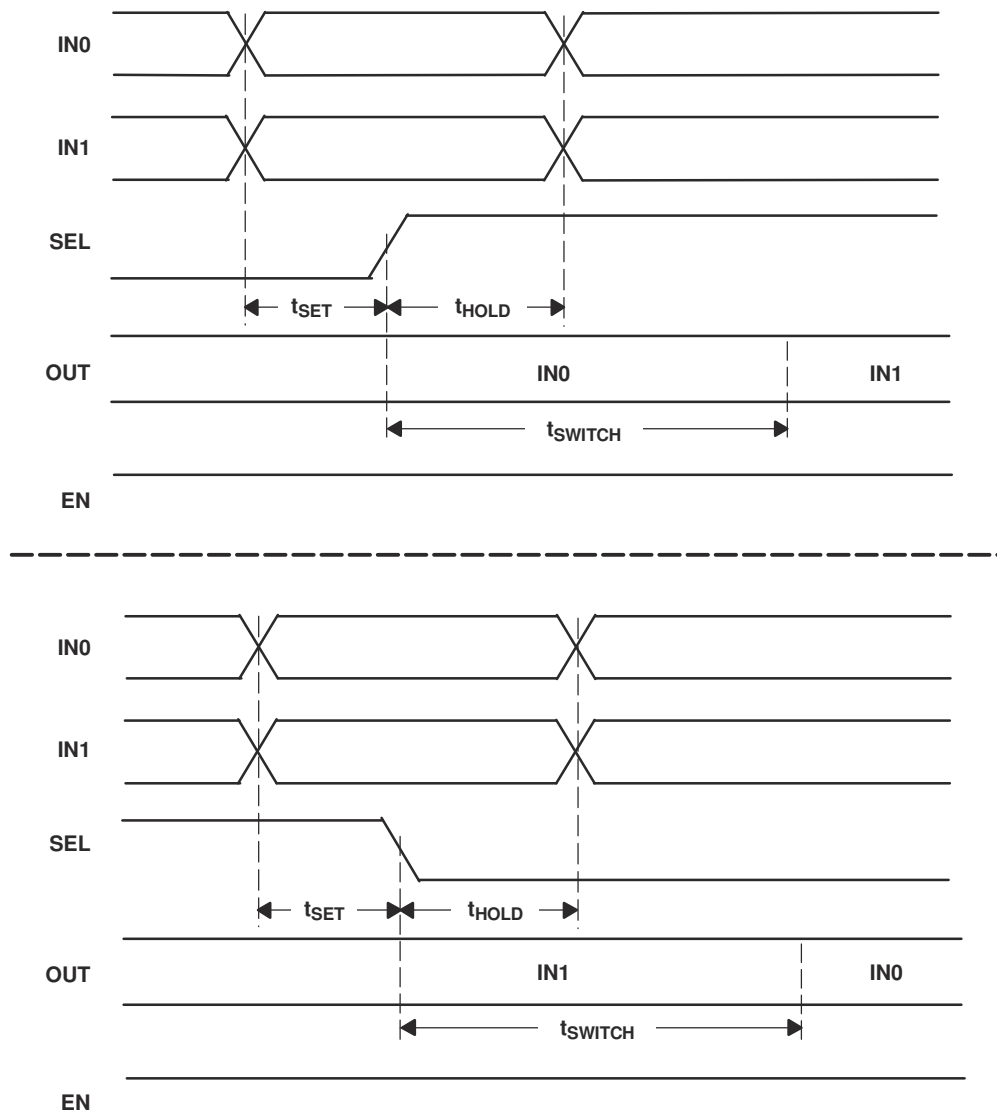

t_{SET} and t_{HOLD} times specify that data must be in a stable state before and after mux control switches.

Figure 7-7. Input To Select For Both Rising And Falling Edge Setup And Hold Times

8 Detailed Description

8.1 Overview

The SN55LVCP22 is a high-speed 1-Gbps 2x2 LVDS redriving cross-point switch that can be used in mux or demux or splitter configurations. The SN55LVCP22 provides multiple signal switching options that allow system implementation flexibility as described in [Table 8-1](#). The SN55LVCP22 incorporates wide common-mode (0 V to 4 V) receivers, allowing for the receipt of LVDS, LVPECL, and CML signals and low-power LVDS drivers to provide high-speed operations. The SN55LVCP22 uses a fully differential data path to ensure low-noise generation, fast switching times, low pulse width distortion, and low jitter.

8.2 Functional Block Diagram

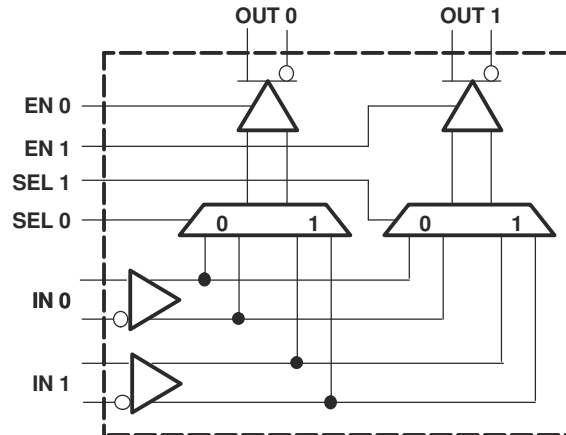

8.3 Feature Description

8.3.1 Input Select Pins

SEL0 pin selects which differential input lane will be routed to Lane 0 driver differential output OUT0 and SEL1 pin selects which differential input lane will be routed to Lane 1 driver differential output OUT1

8.3.2 Output Enable Pins

EN0 pin is an active high enable for OUT0 driver differential output and EN1 pin is an active high enable for OUT1 driver differential output.

8.4 Device Functional Modes

Table 8-1. Function Table

SEL0	SEL1	EN0	EN1	OUT0	OUT1	FUNCTION	SIGNAL FLOW
0	0	1	1	IN0	IN0	1:2 Splitter Input IN0	
1	1	1	1	IN1	IN1	1:2 Splitter Input IN1	

Table 8-1. Function Table (continued)

SEL0	SEL1	EN0	EN1	OUT0	OUT1	FUNCTION	SIGNAL FLOW
0	1	1	1	IN0	IN1	2-lane Repeater	<p>Dual Repeater</p> 
1	0	1	1	IN1	IN0	Cross-switch	<p>2 X 2 Crosspoint</p> 
0	X	1	0	IN0	High-Z	2:1 Mux Output OUT0	<p>2:1 Mux</p> 
1				IN1			
X	0	0	1	High-Z	IN0	2:1 Mux Output OUT1	<p>2:1 Mux</p> 
	1				IN1		

9 Application and Implementation

9.1 Application Information

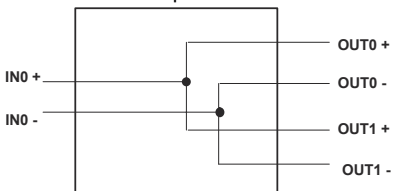
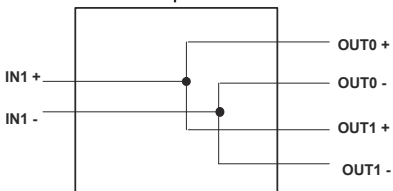
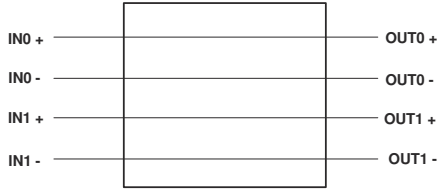
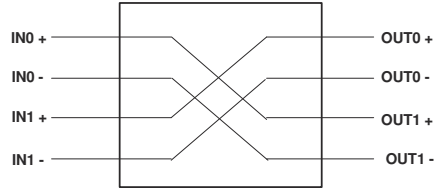
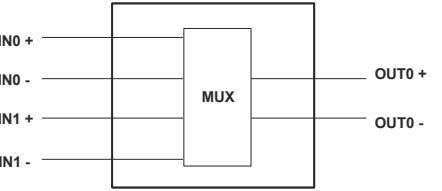
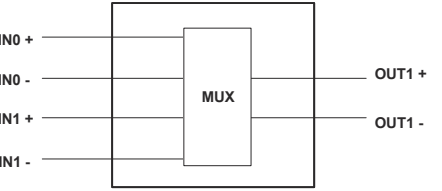
The SN55LVCP22 can support different kind of signaling at the receiver with proper termination network. The output drivers will output LVDS differential signals.

9.2 Typical Application

9.2.1 Low-Voltage Positive Emitter-Coupled Logic (LVPECL)

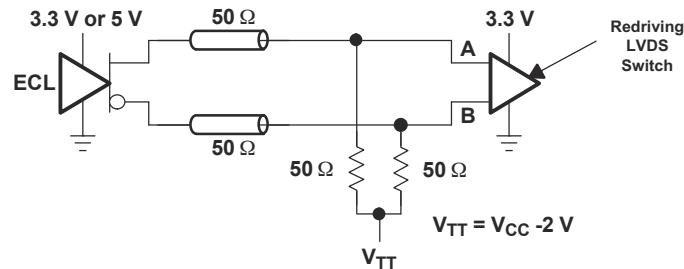

Figure 9-1. Low-Voltage Positive Emitter-Coupled Logic (LVPECL)

9.2.1.1 Design Requirements

Table 9-1. Design Parameters

DESIGN PARAMETER	EXAMPLE VALUE
Single-ended termination	50 Ω
V_{TT} termination voltage	$V_{CC} - 2V$

9.2.1.2 Detailed Design Procedure

Use two 50 Ω termination resistors (as close to the input pins as possible) with termination voltage of V_{TT} as described in Figure 9-1 to receive LVPECL input signals.

9.2.2 Current-Mode Logic (CML)

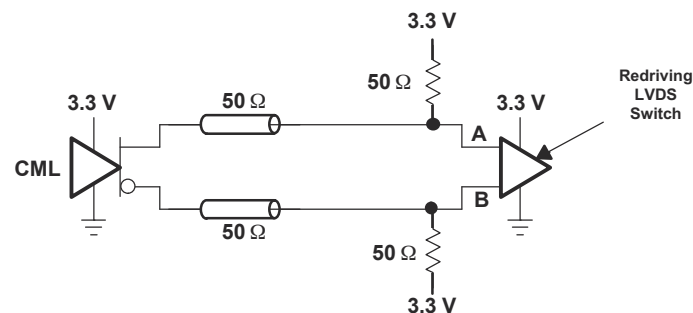

Figure 9-2. Current-Mode Logic (CML)

9.2.2.1 Design Requirements

Table 9-2. Design Parameters

DESIGN PARAMETER	EXAMPLE VALUE
Single-ended termination	50 Ω
Termination Voltage	$V_{CC} = 3.3V$

9.2.2.2 Detailed Design Procedure

Use two 50 Ω termination resistors (as close to the input pin as possible) with termination voltage of V_{CC} as described in Figure 9-2 to receive CML input signals.

9.2.3 Single-Ended (LVPECL)

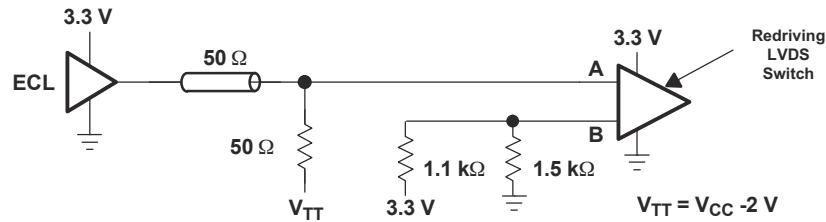

Figure 9-3. Single-Ended (LVPECL)

9.2.3.1 Design Requirements

Table 9-3. Design Parameters

DESIGN PARAMETER	EXAMPLE VALUE
Single-ended termination for input used	50 Ω
V_{TT} termination voltage	$V_{CC} - 2 V$
Unused input pull-up termination to V_{CC}	1.1 kΩ
Unused input pull-down termination to Gound	1.5 kΩ

9.2.3.2 Detailed Design Procedure

Use a 50 Ω termination resistor (as close to the input pin as possible) with termination voltage of V_{TT} as described in Figure 9-3 to receive Single-ended LVPECL input signals. Terminate Unused input pin with 1.1 kΩ pull-up to V_{CC} and 1.5 kΩ pull-down to ground.

9.2.4 Low-Voltage Differential Signaling (LVDS)

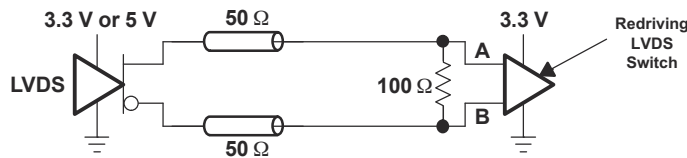

Figure 9-4. Low-Voltage Differential Signaling (LVDS)

9.2.4.1 Design Requirements

Table 9-4. Design Parameters

DESIGN PARAMETER	EXAMPLE VALUE
Differential Termination	100 Ω

9.2.4.2 Detailed Design Procedure

Use a 100 Ω differential termination resistor (as close to the input pins as possible) as described in Figure 9-4 to receive LVDS input signals.

9.2.5 Application Curves

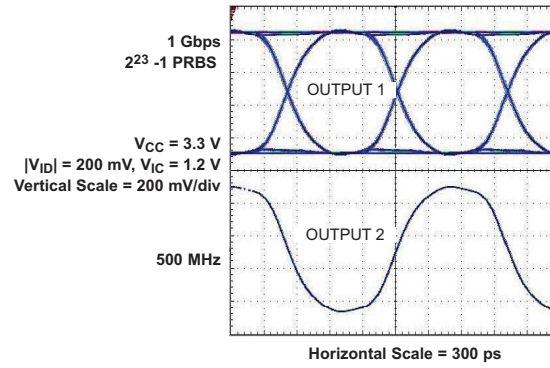

Figure 9-5. LVDS Output

10 Power Supply Recommendations

There is no power supply sequence required for SN55LVCP22. It is recommended that at least a 0.1 μ F decoupling capacitor is placed at the device VCC near the pin.

11 Layout

11.1 Layout Guidelines

High performance layout practices are paramount for board layout for high speed signals to ensure good signal integrity. Even minor imperfection can cause impedance mismatch resulting reflection. Special care is warranted for traces, connections to device, and connectors.

11.2 Layout Example

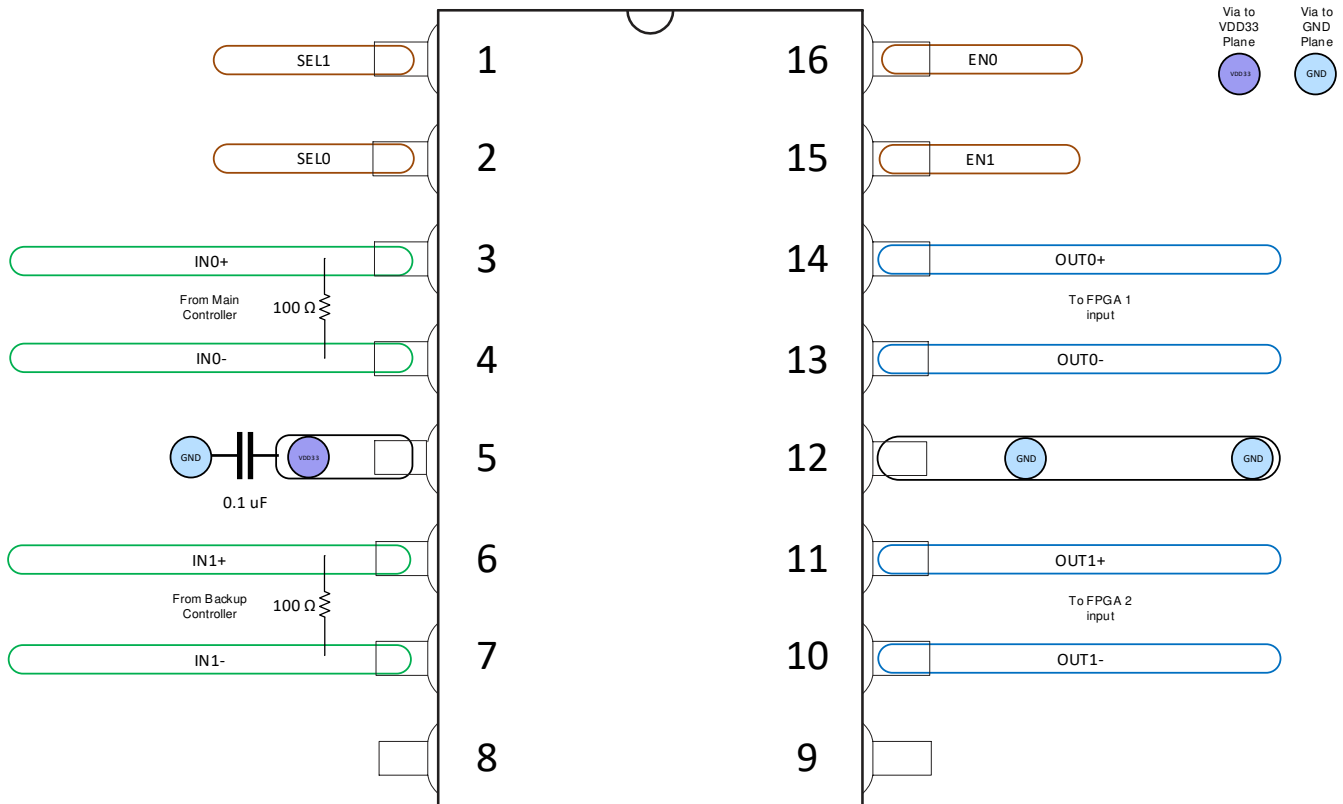

Figure 11-1. Layout Example with LVDS input signals

12 Device and Documentation Support

12.1 Trademarks

All other trademarks are the property of their respective owners.

12.2 Electrostatic Discharge Caution



This integrated circuit can be damaged by ESD. Texas Instruments recommends that all integrated circuits be handled with appropriate precautions. Failure to observe proper handling and installation procedures can cause damage.

ESD damage can range from subtle performance degradation to complete device failure. Precision integrated circuits may be more susceptible to damage because very small parametric changes could cause the device not to meet its published specifications.

12.3 Glossary

TI Glossary This glossary lists and explains terms, acronyms, and definitions.

13 Mechanical, Packaging, and Orderable Information

The following pages include mechanical, packaging, and orderable information. This information is the most current data available for the designated devices. This data is subject to change without notice and revision of this document. For browser-based versions of this data sheet, refer to the left-hand navigation.

PACKAGING INFORMATION

Orderable Device	Status (1)	Package Type	Package Drawing	Pins	Package Qty	Eco Plan (2)	Lead finish/ Ball material (6)	MSL Peak Temp (3)	Op Temp (°C)	Device Marking (4/5)	Samples
5962-1124201QFA	ACTIVE	CFP	W	16	25	Non-RoHS & Green	SNPB	N / A for Pkg Type	-55 to 125	5962-1124201QF A LVCP22W-SP	

(1) The marketing status values are defined as follows:

ACTIVE: Product device recommended for new designs.

LIFEBUY: TI has announced that the device will be discontinued, and a lifetime-buy period is in effect.

NRND: Not recommended for new designs. Device is in production to support existing customers, but TI does not recommend using this part in a new design.

PREVIEW: Device has been announced but is not in production. Samples may or may not be available.

OBSOLETE: TI has discontinued the production of the device.

(2) **RoHS:** TI defines "RoHS" to mean semiconductor products that are compliant with the current EU RoHS requirements for all 10 RoHS substances, including the requirement that RoHS substance do not exceed 0.1% by weight in homogeneous materials. Where designed to be soldered at high temperatures, "RoHS" products are suitable for use in specified lead-free processes. TI may reference these types of products as "Pb-Free".

RoHS Exempt: TI defines "RoHS Exempt" to mean products that contain lead but are compliant with EU RoHS pursuant to a specific EU RoHS exemption.

Green: TI defines "Green" to mean the content of Chlorine (Cl) and Bromine (Br) based flame retardants meet JS709B low halogen requirements of <=1000ppm threshold. Antimony trioxide based flame retardants must also meet the <=1000ppm threshold requirement.

(3) MSL, Peak Temp. - The Moisture Sensitivity Level rating according to the JEDEC industry standard classifications, and peak solder temperature.

(4) There may be additional marking, which relates to the logo, the lot trace code information, or the environmental category on the device.

(5) Multiple Device Markings will be inside parentheses. Only one Device Marking contained in parentheses and separated by a "~" will appear on a device. If a line is indented then it is a continuation of the previous line and the two combined represent the entire Device Marking for that device.

(6) Lead finish/Ball material - Orderable Devices may have multiple material finish options. Finish options are separated by a vertical ruled line. Lead finish/Ball material values may wrap to two lines if the finish value exceeds the maximum column width.

Important Information and Disclaimer:The information provided on this page represents TI's knowledge and belief as of the date that it is provided. TI bases its knowledge and belief on information provided by third parties, and makes no representation or warranty as to the accuracy of such information. Efforts are underway to better integrate information from third parties. TI has taken and continues to take reasonable steps to provide representative and accurate information but may not have conducted destructive testing or chemical analysis on incoming materials and chemicals. TI and TI suppliers consider certain information to be proprietary, and thus CAS numbers and other limited information may not be available for release.

In no event shall TI's liability arising out of such information exceed the total purchase price of the TI part(s) at issue in this document sold by TI to Customer on an annual basis.

OTHER QUALIFIED VERSIONS OF SN55LVCP22 :

- Space : [SN55LVCP22-SP](#)

NOTE: Qualified Version Definitions:

- Space - Radiation tolerant, ceramic packaging and qualified for use in Space-based application

W (R-GDFP-F16)

CERAMIC DUAL FLATPACK



- NOTES:
- A. All linear dimensions are in inches (millimeters).
 - B. This drawing is subject to change without notice.
 - C. This package can be hermetically sealed with a ceramic lid using glass frit.
 - D. Index point is provided on cap for terminal identification only.
 - E. Falls within MIL STD 1835 GDFP2-F16

IMPORTANT NOTICE AND DISCLAIMER

TI PROVIDES TECHNICAL AND RELIABILITY DATA (INCLUDING DATA SHEETS), DESIGN RESOURCES (INCLUDING REFERENCE DESIGNS), APPLICATION OR OTHER DESIGN ADVICE, WEB TOOLS, SAFETY INFORMATION, AND OTHER RESOURCES "AS IS" AND WITH ALL FAULTS, AND DISCLAIMS ALL WARRANTIES, EXPRESS AND IMPLIED, INCLUDING WITHOUT LIMITATION ANY IMPLIED WARRANTIES OF MERCHANTABILITY, FITNESS FOR A PARTICULAR PURPOSE OR NON-INFRINGEMENT OF THIRD PARTY INTELLECTUAL PROPERTY RIGHTS.

These resources are intended for skilled developers designing with TI products. You are solely responsible for (1) selecting the appropriate TI products for your application, (2) designing, validating and testing your application, and (3) ensuring your application meets applicable standards, and any other safety, security, regulatory or other requirements.

These resources are subject to change without notice. TI grants you permission to use these resources only for development of an application that uses the TI products described in the resource. Other reproduction and display of these resources is prohibited. No license is granted to any other TI intellectual property right or to any third party intellectual property right. TI disclaims responsibility for, and you will fully indemnify TI and its representatives against, any claims, damages, costs, losses, and liabilities arising out of your use of these resources.

TI's products are provided subject to [TI's Terms of Sale](#) or other applicable terms available either on [ti.com](https://www.ti.com) or provided in conjunction with such TI products. TI's provision of these resources does not expand or otherwise alter TI's applicable warranties or warranty disclaimers for TI products.

TI objects to and rejects any additional or different terms you may have proposed.

Mailing Address: Texas Instruments, Post Office Box 655303, Dallas, Texas 75265
Copyright © 2023, Texas Instruments Incorporated