

# SN74AHC1G09 Single 2-Input Positive-AND Gate With Open-Drain Output

## 1 Features

- Operating range from 2V to 5.5V
- Low power consumption, 10 $\mu$ A maximum  $I_{CC}$
- Maximum  $t_{pd}$  of 6ns at 5V
- $\pm 8$ mA output drive at 5V
- Latch-up performance exceeds 250mA per JESD 17

## 2 Applications

- [Combining power good signals](#)
- [Enable digital signals](#)

## 3 Description

The SN74AHC1G09 is a single 2-input positive-AND gate with an open drain output configuration. The device performs the Boolean logic  $Y = A \times B$  in positive logic.

### Package Information

PART NUMBER	PACKAGE <sup>(1)</sup>	PACKAGE SIZE <sup>(2)</sup>	BODY SIZE <sup>(3)</sup>
SN74AHC1G09	DBV (SOT-23, 5)	2.9 mm $\times$ 2.8 mm	2.9 mm $\times$ 1.6 mm
	DCK (SC70, 5)	2 mm $\times$ 2.1 mm	2 mm $\times$ 1.25 mm

- (1) For all available packages, see the orderable addendum at the end of the data sheet.
- (2) The package size (length  $\times$  width) is a nominal value and includes pins, where applicable.
- (3) The body size (length  $\times$  width) is a nominal value and does not include pins.

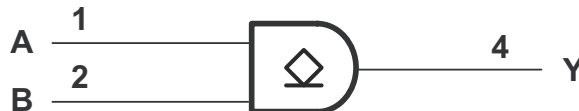

Logic Diagram



## Table of Contents

<b>1 Features</b> .....	1	7.3 Feature Description.....	8
<b>2 Applications</b> .....	1	7.4 Device Functional Modes.....	8
<b>3 Description</b> .....	1	<b>8 Application and Implementation</b> .....	9
<b>4 Pin Configuration and Functions</b> .....	3	8.1 Application Information.....	9
<b>5 Specifications</b> .....	4	8.2 Typical Application.....	9
5.1 Absolute Maximum Ratings.....	4	8.3 Power Supply Recommendations.....	10
5.2 ESD Ratings.....	4	8.4 Layout.....	10
5.3 Recommended Operating Conditions.....	4	<b>9 Device and Documentation Support</b> .....	11
5.4 Thermal Information.....	5	9.1 Documentation Support.....	11
5.5 Electrical Characteristics.....	5	9.2 Receiving Notification of Documentation Updates....	11
5.6 Switching Characteristics, $V_{CC} = 3.3\text{ V} \pm 0.3\text{ V}$ .....	5	9.3 Support Resources.....	11
5.7 Switching Characteristics, $V_{CC} = 5\text{ V} \pm 0.5\text{ V}$ .....	6	9.4 Trademarks.....	11
5.8 Operating Characteristics.....	6	9.5 Electrostatic Discharge Caution.....	11
5.9 Typical Characteristics.....	6	9.6 Glossary.....	11
<b>6 Parameter Measurement Information</b> .....	7	<b>10 Revision History</b> .....	11
<b>7 Detailed Description</b> .....	8	<b>11 Mechanical, Packaging, and Orderable Information</b> .....	11
7.1 Overview.....	8		
7.2 Functional Block Diagram.....	8		

## 4 Pin Configuration and Functions

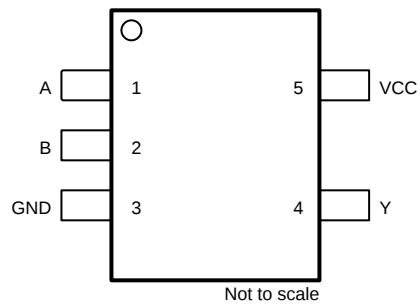

**Figure 4-1. DBV or DCK Package, 5-Pin SOT-23 or SC70 (Top View)**

**Table 4-1. Pin Functions**

PIN		TYPE <sup>(1)</sup>	DESCRIPTION
NAME	NO.		
A	1	I	Input
B	2	I	Input
GND	3	—	Ground
V <sub>CC</sub>	5	—	Power pin
Y	4	O	Output

(1) I = input, O = output

## 5 Specifications

### 5.1 Absolute Maximum Ratings

over operating free-air temperature range (unless otherwise noted) <sup>(1)</sup>

		MIN	MAX	UNIT	
V <sub>CC</sub>	Supply voltage	-0.5	7	V	
V <sub>I</sub>	Input voltage <sup>(2)</sup>	-0.5	7	V	
V <sub>O</sub>	Output voltage <sup>(2)</sup>	-0.5	V <sub>CC</sub> + 0.7	V	
I <sub>IK</sub>	Input clamp current	(V <sub>I</sub> < 0)	-20	mA	
I <sub>OK</sub>	Output clamp current	(V <sub>O</sub> < 0 or V <sub>O</sub> > V <sub>CC</sub> )	-20	mA	
I <sub>O</sub>	Continuous output current	(V <sub>O</sub> = 0 to V <sub>CC</sub> )	-25	+25	mA
	Continuous current through V <sub>CC</sub> or GND	-50	+50	mA	
T <sub>J</sub>	Maximum junction temperature		150	°C	
T <sub>stg</sub>	Storage temperature	-65	150	°C	

- (1) Stresses beyond those listed under *Absolute Maximum Ratings* may cause permanent damage to the device. These are stress ratings only, which do not imply functional operation of the device at these or any other conditions beyond those indicated under *Recommended Operating Condition*. Exposure to absolute-maximum-rated conditions for extended periods may affect device reliability.
- (2) The input and output voltage ratings may be exceeded if the input and output current ratings are observed.

### 5.2 ESD Ratings

		VALUE	UNIT
V <sub>(ESD)</sub>	Electrostatic discharge	Human-body model (HBM), per ANSI/ESDA/JEDEC JS-001 <sup>(1)</sup>	±2500
		Charged-device model (CDM), per ANSI/ESDA/JEDEC JS-002 <sup>(2)</sup>	±1000

- (1) JEDEC document JEP155 states that 500-V HBM allows safe manufacturing with a standard ESD control process.
- (2) JEDEC document JEP157 states that 250-V CDM allows safe manufacturing with a standard ESD control process.

### 5.3 Recommended Operating Conditions

over operating free-air temperature range (unless otherwise noted) <sup>(1)</sup>

		MIN	MAX	UNIT
V <sub>CC</sub>	Supply voltage	2	5.5	V
V <sub>IH</sub>	High-level input voltage	V <sub>CC</sub> = 2 V	1.5	V
		V <sub>CC</sub> = 3 V	2.1	
		V <sub>CC</sub> = 5.5 V	3.85	
V <sub>IL</sub>	Low-level input voltage	V <sub>CC</sub> = 2 V	0.5	V
		V <sub>CC</sub> = 3 V	0.9	
		V <sub>CC</sub> = 5.5 V	1.65	
V <sub>I</sub>	Input voltage	0	5.5	V
V <sub>O</sub>	Output voltage	0	5.5	V
I <sub>OL</sub>	Low-level output current	V <sub>CC</sub> = 2 V	50	μA
		V <sub>CC</sub> = 3.3 V ± 0.3 V	4	mA
		V <sub>CC</sub> = 5 V ± 0.5 V	8	
Δt/Δv	Input transition rise or fall rate	V <sub>CC</sub> = 3.3 V ± 0.3 V	100	ns/V
		V <sub>CC</sub> = 5 V ± 0.5 V	20	
T <sub>A</sub>	Operating free-air temperature	-55	125	°C

- (1) All unused inputs of the device must be held at V<sub>CC</sub> or GND for proper device operation. See *Implications of Slow or Floating CMOS Inputs*, SCBA004.

## 5.4 Thermal Information

THERMAL METRIC <sup>(1)</sup>	SN74AHC1G09		UNIT
	DBV (SOT-23)	DCK (SC70)	
	5 PINS	5 PINS	
R <sub>θJA</sub> Junction-to-ambient thermal resistance	278	289.2	°C/W

(1) For more information about traditional and new thermal metrics, see the [Semiconductor and IC Package Thermal Metrics](#) application report.

## 5.5 Electrical Characteristics

over operating free-air temperature range (unless otherwise noted)

PARAMETER	TEST CONDITIONS	V <sub>CC</sub>	T <sub>A</sub>	MIN	TYP	MAX	UNIT	
V <sub>OL</sub>	I <sub>OL</sub> = 50 μA	2 V				0.1	V	
		3 V				0.1		
		4.5 V				0.1		
	I <sub>OL</sub> = 4 mA	3 V	T <sub>A</sub> = 25°C					0.36
			T <sub>A</sub> = –40°C to +85°C					0.44
			T <sub>A</sub> = –55°C to +125°C					0.55
I <sub>OL</sub> = 8 mA	4.5 V	T <sub>A</sub> = 25°C				0.36		
		T <sub>A</sub> = –40°C to +85°C				0.44		
		T <sub>A</sub> = –55°C to +125°C				0.55		
I <sub>I</sub>	V <sub>I</sub> = 5.5 V or GND	0 V to 5.5 V	T <sub>A</sub> = 25°C				±0.1	μA
			T <sub>A</sub> = –40°C to +85°C				±1	
			T <sub>A</sub> = –55°C to +125°C				±2	
I <sub>CC</sub>	V <sub>I</sub> = V <sub>CC</sub> or GND, I <sub>O</sub> = 0	5.5 V	T <sub>A</sub> = 25°C				1	μA
			T <sub>A</sub> = –40°C to +85°C				10	
			T <sub>A</sub> = –55°C to +125°C				20	
C <sub>i</sub>	V <sub>I</sub> = V <sub>CC</sub> or GND	5 V	T <sub>A</sub> = 25°C		4	10	pF	
			T <sub>A</sub> = –55°C to +125°C					10

## 5.6 Switching Characteristics, V<sub>CC</sub> = 3.3 V ± 0.3 V

over recommended operating free-air temperature range (unless otherwise noted) (see [Figure 6-1](#))

PARAMETER	FROM (INPUT)	TO (OUTPUT)	OUTPUT CAPACITANCE	T <sub>A</sub>	MIN	TYP	MAX	UNIT
t <sub>PD</sub>	A or B	Y	C <sub>L</sub> = 15 pF	T <sub>A</sub> = 25°C		3.6	7	ns
				T <sub>A</sub> = –40°C to +85°C		1	8	
				T <sub>A</sub> = –55°C to +125°C		1	8.5	
	A or B	Y	C <sub>L</sub> = 50 pF	T <sub>A</sub> = 25°C		6.5	11	ns
				T <sub>A</sub> = –40°C to +85°C		1.5	12	
				T <sub>A</sub> = –55°C to +125°C		1.5	12.5	

### 5.7 Switching Characteristics, $V_{CC} = 5\text{ V} \pm 0.5\text{ V}$

over recommended operating free-air temperature range,  $V_{CC} = 5\text{ V} \pm 0.5\text{ V}$  (unless otherwise noted) (see [Figure 6-1](#))

PARAMETER	FROM (INPUT)	TO (OUTPUT)	OUTPUT CAPACITANCE	$T_A$	MIN	TYP	MAX	UNIT
$t_{PD}$	A or B	Y	$C_L = 15\text{ pF}$	$T_A = 25^\circ\text{C}$		2.5	5	ns
				$T_A = -40^\circ\text{C to } +85^\circ\text{C}$		1	6	
				$T_A = -55^\circ\text{C to } +125^\circ\text{C}$		1	6.5	
	A or B	Y	$C_L = 50\text{ pF}$	$T_A = 25^\circ\text{C}$		4.6	7.5	ns
				$T_A = -40^\circ\text{C to } +85^\circ\text{C}$		1.5	8	
				$T_A = -55^\circ\text{C to } +125^\circ\text{C}$		1.5	8.5	

### 5.8 Operating Characteristics

$V_{CC} = 5\text{ V}$ ,  $T_A = 25^\circ\text{C}$

PARAMETER	TEST CONDITIONS	TYP	UNIT
$C_{pd}$ Power dissipation capacitance	No load, $f = 1\text{ MHz}$	5	pF

### 5.9 Typical Characteristics

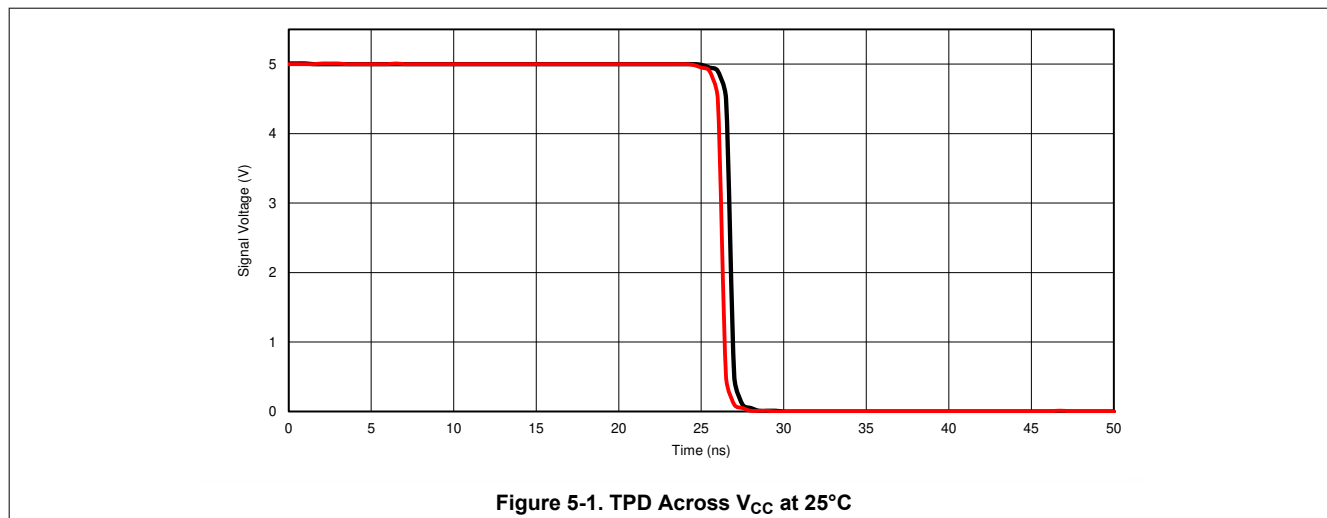

## 6 Parameter Measurement Information

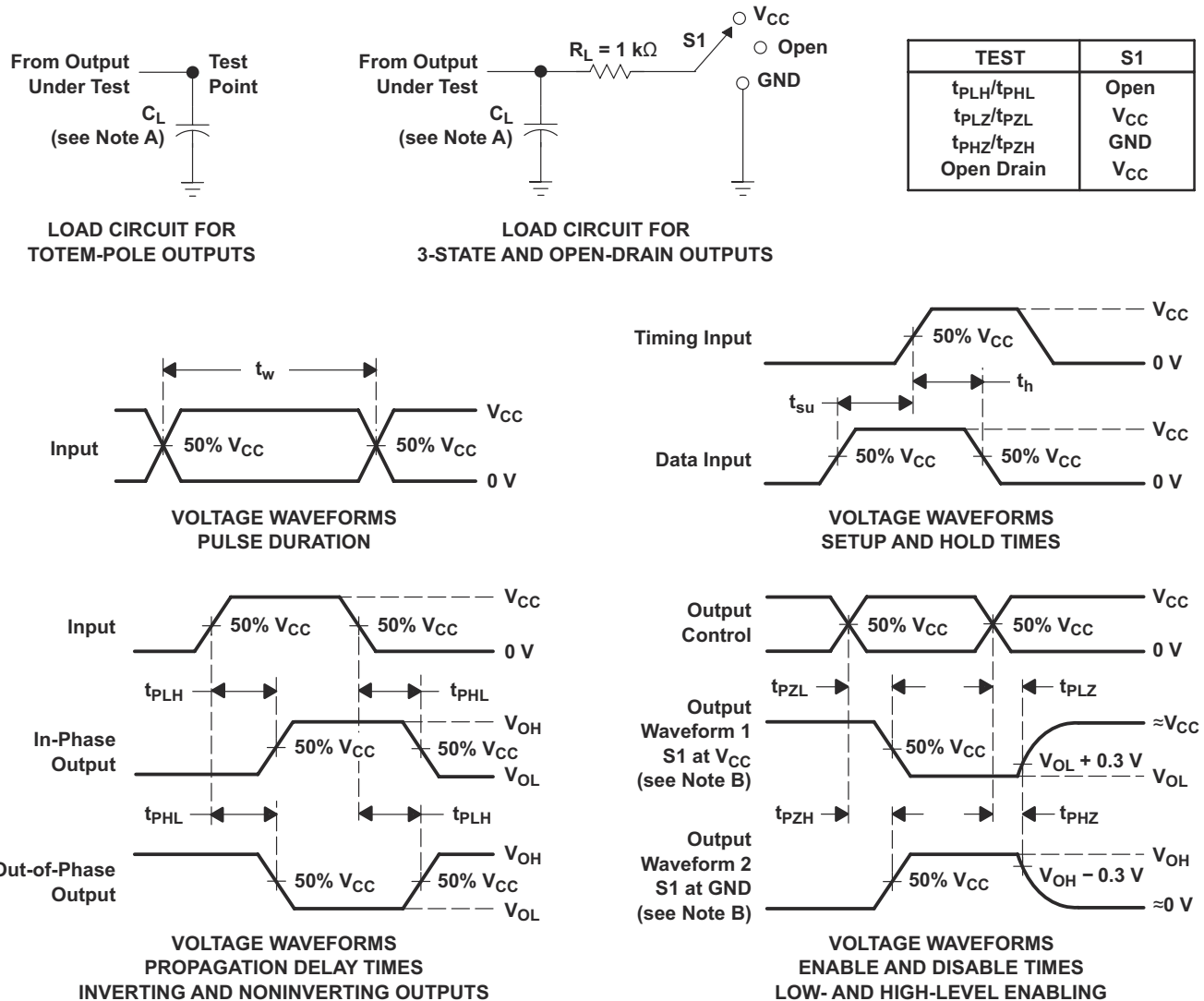

- A.  $C_L$  includes probe and jig capacitance.
- B. Waveform 1 is for an output with internal conditions such that the output is low except when disabled by the output control. Waveform 2 is for an output with internal conditions such that the output is high except when disabled by the output control.
- C. All input pulses are supplied by generators having the following characteristics:  $PRR \leq 1\text{ MHz}$ ,  $Z_O = 50\ \Omega$ ,  $t_r \leq 3\text{ ns}$ ,  $t_f \leq 3\text{ ns}$ .
- D. The outputs are measured one at a time with one input transition per measurement.
- E. All parameters and waveforms are not applicable to all devices.
- F. Since this device has open-drain outputs,  $t_{PLZ}$  and  $t_{PZL}$  are the same as  $t_{PD}$ .
- G.  $t_{PZL}$  is measured at  $V_{CC}/2$ .
- H.  $t_{PLZ}$  is measured at  $V_{OL} + 0.3\text{ V}$ .

Figure 6-1. Load Circuit and Voltage Waveforms

## 7 Detailed Description

### 7.1 Overview

The SN74AHC1G09 device contains one open-drain positive-AND gate with a maximum sink current of 8 mA. A wide operating range of 2 V to 5.5 V enables this device to be used in many different systems, and a low  $t_{pd}$  qualifies this device to be used in high-speed applications.

### 7.2 Functional Block Diagram

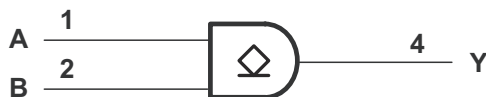

### 7.3 Feature Description

The wide operating voltage range of 2 V to 5 V allows the SN74AHC1G09 to be used in systems with many different voltage rails. In addition, the voltage tolerance on the output allows the device to be used for inverting up-translation or down-translation. The device is also equipped with Schmitt-trigger inputs, which increase the ability of the device to reject noise.

### 7.4 Device Functional Modes

[Table 7-1](#) lists the functional modes of the SN74AHC1G09.

**Table 7-1. Function Table**

INPUTS		OUTPUT
A	B	Y
H	H	H(Z)
L	X	L
X	L	L



## 8 Application and Implementation

### Note

Information in the following applications sections is not part of the TI component specification, and TI does not warrant its accuracy or completeness. TI's customers are responsible for determining suitability of components for their purposes, as well as validating and testing their design implementation to confirm system functionality.

### 8.1 Application Information

The SN74AHC1G09 is used in the following example in a basic power sequencing configuration. Power sequencing is often used in applications that require a processor or other delicate device with specific voltage timing requirements to protect the device from malfunctioning.

### 8.2 Typical Application

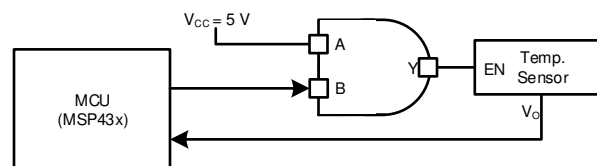

**Figure 8-1. Typical Application Diagram**

#### 8.2.1 Design Requirements

This device uses CMOS technology. Take care to avoid bus contention because it can drive currents that would exceed maximum limits. The high drive will also create fast edges into light loads, so routing and load conditions should be considered to prevent ringing.

#### 8.2.2 Detailed Design Procedure

- Recommended Input Conditions:
  - Rise time and fall time specifications. See  $(\Delta t/\Delta V)$  in [Recommended Operating Conditions](#).
  - Specified high and low levels. See  $(V_{IH}$  and  $V_{IL})$  in [Recommended Operating Conditions](#).
  - Inputs are overvoltage-tolerant, allowing them to go as high as  $(V_I$  maximum) in [Recommended Operating Conditions](#) at any valid  $V_{CC}$ .
- Absolute Maximum Conditions:
  - Load currents should not exceed  $(I_O$  maximum) per output and should not exceed (continuous current through  $V_{CC}$  or GND) total current for the part. These limits are located in [Absolute Maximum Ratings](#).
  - Outputs should not be pulled above  $V_{CC}$ .

## 8.2.3 Application Curves

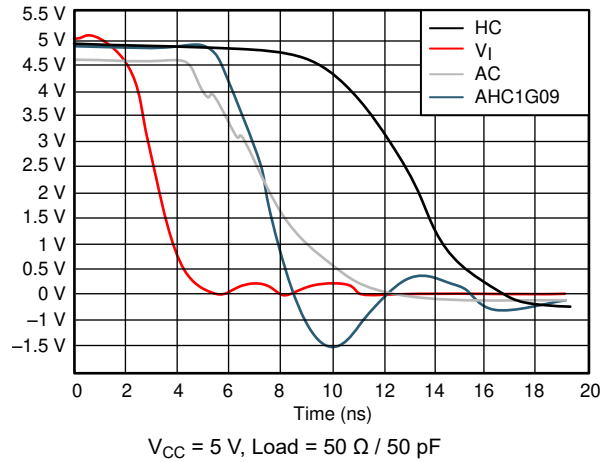

**Figure 8-2.  $I_{CC}$  vs Input Voltage**

## 8.3 Power Supply Recommendations

The power supply can be any voltage between the minimum and maximum supply voltage rating located in [Recommended Operating Conditions](#).

Each  $V_{CC}$  pin should have a good bypass capacitor to prevent power disturbance. For devices with a single supply, a 0.1- $\mu\text{F}$  capacitor is recommended; if there are multiple  $V_{CC}$  pins, then a 0.01- $\mu\text{F}$  or 0.022- $\mu\text{F}$  capacitor is recommended for each power pin. It is acceptable to parallel multiple bypass capacitors to reject different frequencies of noise. 0.1- $\mu\text{F}$  and 1- $\mu\text{F}$  capacitors are commonly used in parallel. The bypass capacitor should be installed as close to the power pin as possible for best results.

## 8.4 Layout

### 8.4.1 Layout Guidelines

When using multiple bit logic devices, inputs must never float. In many cases, functions or parts of functions of digital logic devices are unused (for example, when only two inputs of a triple-input AND gate are used, or only 3 of the 4 buffer gates are used). Such input pins must not be left unconnected because the undefined voltages at the outside connections result in undefined operational states.

The following are the rules that must be observed under all circumstances:

- All unused inputs of digital logic devices must be connected to a high or low bias to prevent them from floating.
- The logic level that should be applied to any particular unused input depends on the function of the device. Generally the unused inputs will be tied to GND or  $V_{CC}$ , whichever makes more sense or is more convenient.

### 8.4.2 Layout Example

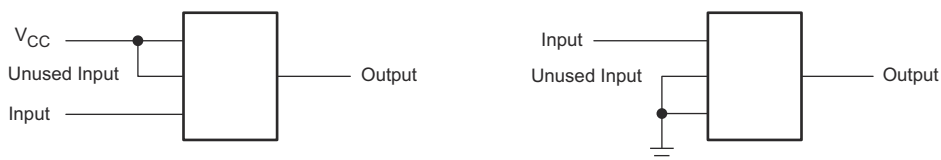

**Figure 8-3. Layout Diagram**

## 9 Device and Documentation Support

### 9.1 Documentation Support

#### 9.1.1 Related Documentation

For related documentation, see the following:

- Texas Instruments, [Introduction to Logic application report](#)
- Texas Instruments, [Implications of Slow or Floating CMOS Inputs application note](#)

### 9.2 Receiving Notification of Documentation Updates

To receive notification of documentation updates, navigate to the device product folder on [ti.com](http://ti.com). Click on *Notifications* to register and receive a weekly digest of any product information that has changed. For change details, review the revision history included in any revised document.

### 9.3 Support Resources

[TI E2E™ support forums](#) are an engineer's go-to source for fast, verified answers and design help — straight from the experts. Search existing answers or ask your own question to get the quick design help you need.

Linked content is provided "AS IS" by the respective contributors. They do not constitute TI specifications and do not necessarily reflect TI's views; see TI's [Terms of Use](#).

### 9.4 Trademarks

TI E2E™ is a trademark of Texas Instruments.  
All trademarks are the property of their respective owners.

### 9.5 Electrostatic Discharge Caution



This integrated circuit can be damaged by ESD. Texas Instruments recommends that all integrated circuits be handled with appropriate precautions. Failure to observe proper handling and installation procedures can cause damage.

ESD damage can range from subtle performance degradation to complete device failure. Precision integrated circuits may be more susceptible to damage because very small parametric changes could cause the device not to meet its published specifications.

### 9.6 Glossary

[TI Glossary](#) This glossary lists and explains terms, acronyms, and definitions.

## 10 Revision History

NOTE: Page numbers for previous revisions may differ from page numbers in the current version.

### Changes from Revision E (October 2023) to Revision F (February 2024) Page

- Updated RθJA values: DBV = 206 to 278, all values in °C/W..... **5**



### Changes from Revision D (September 2016) to Revision E (October 2023) Page

- Updated the numbering format for tables, figures, and cross-references throughout the document..... **1**
- Updated RθJA values: DCK = 252 to 289.2, all values in °C/W ..... **5**

## 11 Mechanical, Packaging, and Orderable Information

The following pages include mechanical, packaging, and orderable information. This information is the most current data available for the designated devices. This data is subject to change without notice and revision of this document. For browser based versions of this data sheet, refer to the left hand navigation.

**PACKAGING INFORMATION**

Orderable Device	Status (1)	Package Type	Package Drawing	Pins	Package Qty	Eco Plan (2)	Lead finish/ Ball material (6)	MSL Peak Temp (3)	Op Temp (°C)	Device Marking (4/5)	Samples
SN74AHC1G09DBVR	ACTIVE	SOT-23	DBV	5	3000	RoHS & Green	SN	Level-1-260C-UNLIM	-55 to 125	(38QH, 3BWF, A093, A09G, A09J)	
SN74AHC1G09DCKR	ACTIVE	SC70	DCK	5	3000	RoHS & Green	SN	Level-1-260C-UNLIM	-55 to 125	(1R8, AJ3, AJG, AJ J)	

(1) The marketing status values are defined as follows:

**ACTIVE:** Product device recommended for new designs.

**LIFEBUY:** TI has announced that the device will be discontinued, and a lifetime-buy period is in effect.

**NRND:** Not recommended for new designs. Device is in production to support existing customers, but TI does not recommend using this part in a new design.

**PREVIEW:** Device has been announced but is not in production. Samples may or may not be available.

**OBSOLETE:** TI has discontinued the production of the device.

(2) **RoHS:** TI defines "RoHS" to mean semiconductor products that are compliant with the current EU RoHS requirements for all 10 RoHS substances, including the requirement that RoHS substance do not exceed 0.1% by weight in homogeneous materials. Where designed to be soldered at high temperatures, "RoHS" products are suitable for use in specified lead-free processes. TI may reference these types of products as "Pb-Free".

**RoHS Exempt:** TI defines "RoHS Exempt" to mean products that contain lead but are compliant with EU RoHS pursuant to a specific EU RoHS exemption.

**Green:** TI defines "Green" to mean the content of Chlorine (Cl) and Bromine (Br) based flame retardants meet JS709B low halogen requirements of <=1000ppm threshold. Antimony trioxide based flame retardants must also meet the <=1000ppm threshold requirement.

(3) MSL, Peak Temp. - The Moisture Sensitivity Level rating according to the JEDEC industry standard classifications, and peak solder temperature.

(4) There may be additional marking, which relates to the logo, the lot trace code information, or the environmental category on the device.

(5) Multiple Device Markings will be inside parentheses. Only one Device Marking contained in parentheses and separated by a "~" will appear on a device. If a line is indented then it is a continuation of the previous line and the two combined represent the entire Device Marking for that device.

(6) Lead finish/Ball material - Orderable Devices may have multiple material finish options. Finish options are separated by a vertical ruled line. Lead finish/Ball material values may wrap to two lines if the finish value exceeds the maximum column width.

**Important Information and Disclaimer:**The information provided on this page represents TI's knowledge and belief as of the date that it is provided. TI bases its knowledge and belief on information provided by third parties, and makes no representation or warranty as to the accuracy of such information. Efforts are underway to better integrate information from third parties. TI has taken and continues to take reasonable steps to provide representative and accurate information but may not have conducted destructive testing or chemical analysis on incoming materials and chemicals. TI and TI suppliers consider certain information to be proprietary, and thus CAS numbers and other limited information may not be available for release.

In no event shall TI's liability arising out of such information exceed the total purchase price of the TI part(s) at issue in this document sold by TI to Customer on an annual basis.

**OTHER QUALIFIED VERSIONS OF SN74AHC1G09 :**

- Automotive : [SN74AHC1G09-Q1](#)

## NOTE: Qualified Version Definitions:

- Automotive - Q100 devices qualified for high-reliability automotive applications targeting zero defects

**TAPE AND REEL INFORMATION**

**QUADRANT ASSIGNMENTS FOR PIN 1 ORIENTATION IN TAPE**

\*All dimensions are nominal

Device	Package Type	Package Drawing	Pins	SPQ	Reel Diameter (mm)	Reel Width W1 (mm)	A0 (mm)	B0 (mm)	K0 (mm)	P1 (mm)	W (mm)	Pin1 Quadrant
SN74AHC1G09DBVR	SOT-23	DBV	5	3000	180.0	8.4	3.2	3.2	1.4	4.0	8.0	Q3
SN74AHC1G09DCKR	SC70	DCK	5	3000	180.0	8.4	2.3	2.5	1.2	4.0	8.0	Q3

## TAPE AND REEL BOX DIMENSIONS



\*All dimensions are nominal

Device	Package Type	Package Drawing	Pins	SPQ	Length (mm)	Width (mm)	Height (mm)
SN74AHC1G09DBVR	SOT-23	DBV	5	3000	210.0	185.0	35.0
SN74AHC1G09DCKR	SC70	DCK	5	3000	210.0	185.0	35.0





# EXAMPLE BOARD LAYOUT

DBV0005A

SOT-23 - 1.45 mm max height

SMALL OUTLINE TRANSISTOR



LAND PATTERN EXAMPLE  
EXPOSED METAL SHOWN  
SCALE:15X



SOLDER MASK DETAILS

4214839/K 08/2024

NOTES: (continued)

- 6. Publication IPC-7351 may have alternate designs.
- 7. Solder mask tolerances between and around signal pads can vary based on board fabrication site.

# EXAMPLE STENCIL DESIGN

DBV0005A

SOT-23 - 1.45 mm max height

SMALL OUTLINE TRANSISTOR



SOLDER PASTE EXAMPLE  
BASED ON 0.125 mm THICK STENCIL  
SCALE:15X

4214839/K 08/2024

NOTES: (continued)

8. Laser cutting apertures with trapezoidal walls and rounded corners may offer better paste release. IPC-7525 may have alternate design recommendations.
9. Board assembly site may have different recommendations for stencil design.

# DCK0005A



## PACKAGE OUTLINE

SOT - 1.1 max height

SMALL OUTLINE TRANSISTOR

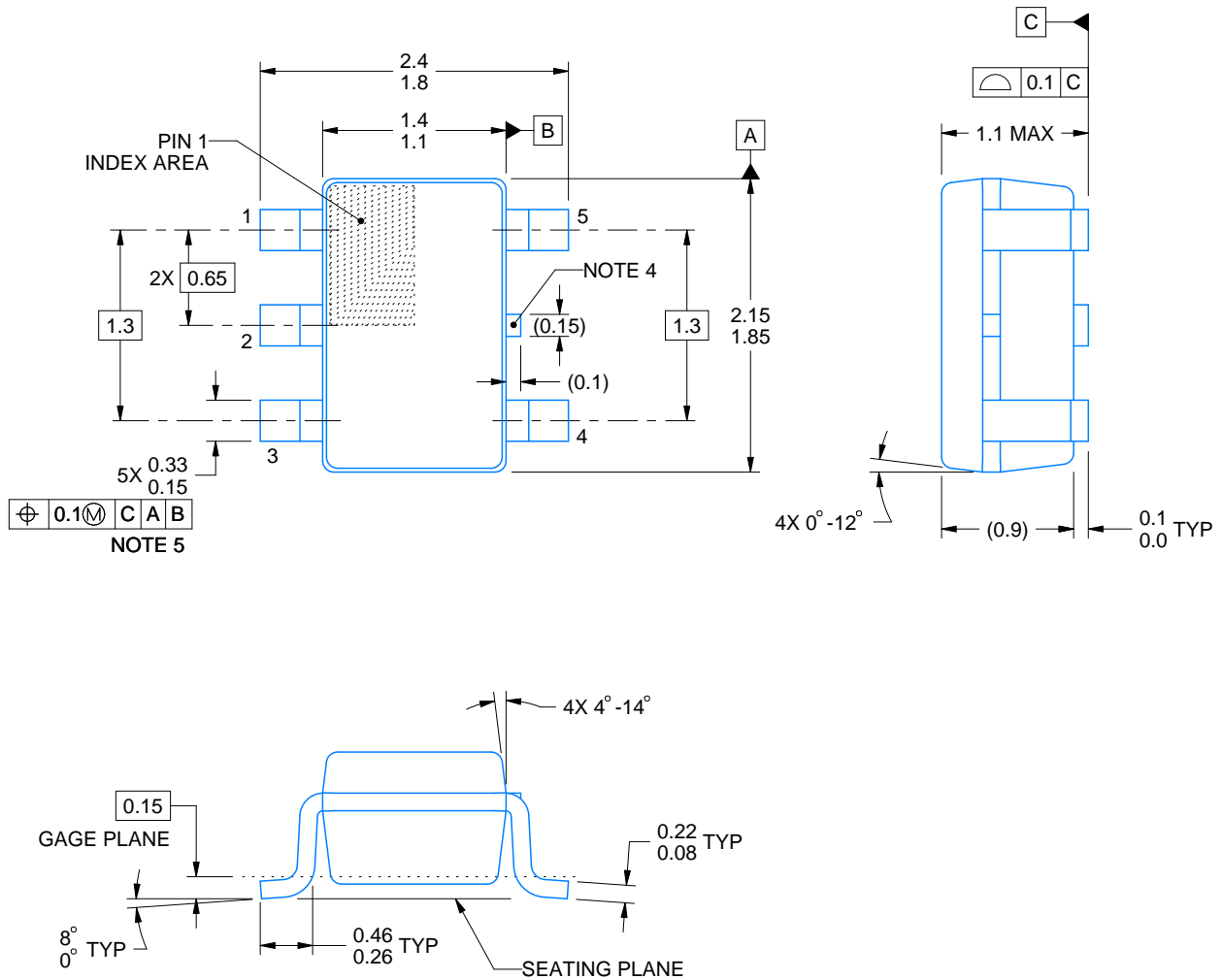

4214834/F 08/2024

### NOTES:

1. All linear dimensions are in millimeters. Any dimensions in parenthesis are for reference only. Dimensioning and tolerancing per ASME Y14.5M.
2. This drawing is subject to change without notice.
3. Reference JEDEC MO-203.
4. Support pin may differ or may not be present.
5. Lead width does not comply with JEDEC.
6. Body dimensions do not include mold flash, protrusions, or gate burrs. Mold flash, protrusions, or gate burrs shall not exceed 0.25mm per side

# EXAMPLE BOARD LAYOUT

DCK0005A

SOT - 1.1 max height

SMALL OUTLINE TRANSISTOR



LAND PATTERN EXAMPLE  
EXPOSED METAL SHOWN  
SCALE:18X



SOLDER MASK DETAILS

4214834/F 08/2024

NOTES: (continued)

- 7. Publication IPC-7351 may have alternate designs.
- 8. Solder mask tolerances between and around signal pads can vary based on board fabrication site.

# EXAMPLE STENCIL DESIGN

DCK0005A

SOT - 1.1 max height

SMALL OUTLINE TRANSISTOR



SOLDER PASTE EXAMPLE  
BASED ON 0.125 THICK STENCIL  
SCALE: 18X

4214834/F 08/2024

NOTES: (continued)

9. Laser cutting apertures with trapezoidal walls and rounded corners may offer better paste release. IPC-7525 may have alternate design recommendations.
10. Board assembly site may have different recommendations for stencil design.

## IMPORTANT NOTICE AND DISCLAIMER

TI PROVIDES TECHNICAL AND RELIABILITY DATA (INCLUDING DATA SHEETS), DESIGN RESOURCES (INCLUDING REFERENCE DESIGNS), APPLICATION OR OTHER DESIGN ADVICE, WEB TOOLS, SAFETY INFORMATION, AND OTHER RESOURCES "AS IS" AND WITH ALL FAULTS, AND DISCLAIMS ALL WARRANTIES, EXPRESS AND IMPLIED, INCLUDING WITHOUT LIMITATION ANY IMPLIED WARRANTIES OF MERCHANTABILITY, FITNESS FOR A PARTICULAR PURPOSE OR NON-INFRINGEMENT OF THIRD PARTY INTELLECTUAL PROPERTY RIGHTS.

These resources are intended for skilled developers designing with TI products. You are solely responsible for (1) selecting the appropriate TI products for your application, (2) designing, validating and testing your application, and (3) ensuring your application meets applicable standards, and any other safety, security, regulatory or other requirements.

These resources are subject to change without notice. TI grants you permission to use these resources only for development of an application that uses the TI products described in the resource. Other reproduction and display of these resources is prohibited. No license is granted to any other TI intellectual property right or to any third party intellectual property right. TI disclaims responsibility for, and you will fully indemnify TI and its representatives against, any claims, damages, costs, losses, and liabilities arising out of your use of these resources.

TI's products are provided subject to [TI's Terms of Sale](#) or other applicable terms available either on [ti.com](https://www.ti.com) or provided in conjunction with such TI products. TI's provision of these resources does not expand or otherwise alter TI's applicable warranties or warranty disclaimers for TI products.

TI objects to and rejects any additional or different terms you may have proposed.

Mailing Address: Texas Instruments, Post Office Box 655303, Dallas, Texas 75265  
Copyright © 2024, Texas Instruments Incorporated