

# SN74LV3T98-EP Enhanced Product Configurable Multiple-Function Gate

## 1 Features

- Wide operating range of 1.8 V to 5.5 V
- Single-supply voltage translator (refer to *LVxT Enhanced Input Voltage*):
  - Up translation:
    - 1.2 V to 1.8 V
    - 1.5 V to 2.5 V
    - 1.8 V to 3.3 V
    - 3.3 V to 5.0 V
  - Down translation:
    - 5.0 V, 3.3 V, 2.5 V to 1.8 V
    - 5.0 V, 3.3 V to 2.5 V
    - 5.0 V to 3.3 V
- 5.5-V tolerant input pins
- Supports standard pinouts
- Up to 150 Mbps with 5-V or 3.3-V  $V_{CC}$
- Latch-up performance exceeds 250 mA per JESD 17
- Supports defense, aerospace, and medical applications:
  - Controlled baseline
  - One assembly and test site
  - One fabrication site
  - Extended product life cycle
  - Product traceability

## 2 Applications

- [Enable or disable a digital signal](#)
- [Controlling an indicator LED](#)
- [Translation between communication modules and system controllers](#)

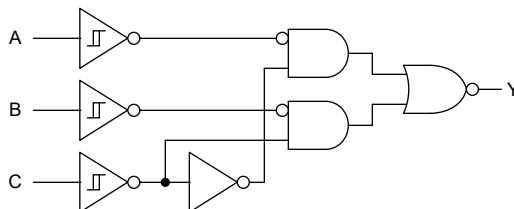

**Simplified Logic Diagram**

## 3 Description

The SN74LV3T98-EP device features configurable multiple functions with extended voltage operation to allow for level translation.. The output state is determined by eight patterns of 3-bit input. The user can choose the logic functions MUX, AND, OR, NAND, NOR, inverter, and noninverter. The output level is referenced to the supply voltage ( $V_{CC}$ ) and supports 1.2-V, 1.8-V, 2.5-V, 3.3-V, and 5-V CMOS levels.

The input is designed with a lower threshold circuit to support up translation for lower voltage CMOS inputs (for example 1.2 V input to 1.8 V output or 1.8 V input to 3.3 V output). Additionally, the 5-V tolerant input pins enable down translation (for example 3.3 V to 2.5 V output).

### Package Information

PART NUMBER	PACKAGE <sup>(1)</sup>	PACKAGE SIZE <sup>(2)</sup>	BODY SIZE (NOM) <sup>(3)</sup>
SN74LV3T98-EP	PW (TSSOP, 14)	5.00 mm × 6.40 mm	5.00 mm × 4.40 mm

- (1) For more information, see [Section 11](#).
- (2) The package size (length × width) is a nominal value and includes pins, where applicable
- (3) The body size (length × width) is a nominal value and does not include pins.



## Table of Contents

<b>1 Features</b> .....	1	7.3 Feature Description.....	11
<b>2 Applications</b> .....	1	7.4 Device Functional Modes.....	13
<b>3 Description</b> .....	1	<b>8 Application and Implementation</b> .....	15
<b>4 Pin Configuration and Functions</b> .....	3	8.1 Application Information.....	15
<b>5 Specifications</b> .....	4	8.2 Typical Application.....	15
5.1 Absolute Maximum Ratings.....	4	8.3 Power Supply Recommendations.....	17
5.2 ESD Ratings.....	4	8.4 Layout.....	17
5.3 Recommended Operating Conditions.....	4	<b>9 Device and Documentation Support</b> .....	19
5.4 Thermal Information.....	4	9.1 Documentation Support.....	19
5.5 Electrical Characteristics.....	5	9.2 Receiving Notification of Documentation Updates....	19
5.6 Switching Characteristics.....	6	9.3 Support Resources.....	19
5.7 Noise Characteristics.....	6	9.4 Trademarks.....	19
5.8 Typical Characteristics.....	7	9.5 Electrostatic Discharge Caution.....	19
<b>6 Parameter Measurement Information</b> .....	10	9.6 Glossary.....	19
<b>7 Detailed Description</b> .....	11	<b>10 Revision History</b> .....	19
7.1 Overview.....	11	<b>11 Mechanical, Packaging, and Orderable Information</b> .....	19
7.2 Functional Block Diagram.....	11		

## 4 Pin Configuration and Functions

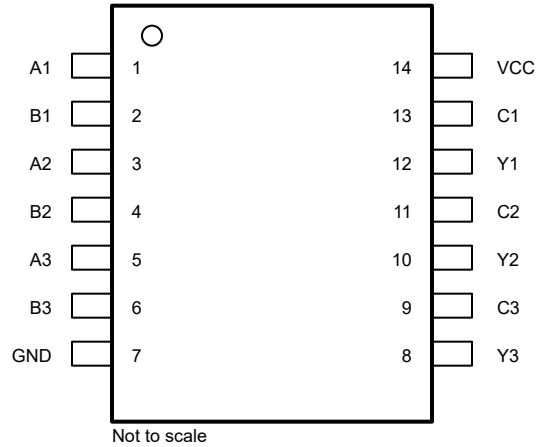

**Figure 4-1. PW Package, 14-Pin TSSOP (Top View)**

**Table 4-1. Pin Functions**

PIN		TYPE <sup>(1)</sup>	DESCRIPTION
NAME	NO.		
A1	1	I	Channel 1, Input A
B1	2	I	Channel 1, Input B
A2	3	I	Channel 2, Input A
B2	4	I	Channel 2, Input B
A3	5	I	Channel 3, Input A
B3	6	I	Channel 3, Input B
GND	7	G	Ground
Y3	8	O	Channel 3, Output Y
C3	9	I	Channel 3, Input C
Y2	10	O	Channel 3, Output Y
C2	11	I	Channel 2, Input C
Y1	12	O	Channel 1, Output Y
C1	13	I	Channel 1, Input C
V <sub>CC</sub>	14	P	Positive Supply

(1) I = Input, O = Output, I/O = Input or Output, G = Ground, P = Power.

## 5 Specifications

### 5.1 Absolute Maximum Ratings

over operating free-air temperature range (unless otherwise noted)<sup>(1)</sup>

		MIN	MAX	UNIT	
V <sub>CC</sub>	Supply voltage range	-0.5	7	V	
V <sub>I</sub>	Input voltage range <sup>(2)</sup>	-0.5	7	V	
V <sub>O</sub>	Voltage range applied to any output in the high-impedance or power-off state <sup>(2)</sup>	-0.5	7	V	
V <sub>O</sub>	Output voltage range <sup>(2)</sup>	-0.5	V <sub>CC</sub> + 0.5	V	
I <sub>IK</sub>	Input clamp current	V <sub>I</sub> < -0.5 V		-20	mA
I <sub>OK</sub>	Output clamp current	V <sub>O</sub> < -0.5 V or V <sub>O</sub> > V <sub>CC</sub> + 0.5 V		±20	mA
I <sub>O</sub>	Continuous output current	V <sub>O</sub> = 0 to V <sub>CC</sub>		±25	mA
	Continuous output current through V <sub>CC</sub> or GND			±50	mA
T <sub>stg</sub>	Storage temperature	-65	150	°C	

- (1) Operation outside the *Absolute Maximum Ratings* may cause permanent device damage. Absolute maximum ratings do not imply functional operation of the device at these or any other conditions beyond those listed under *Recommended Operating Conditions*. If briefly operating outside the *Recommended Operating Conditions* but within the *Absolute Maximum Ratings*, the device may not sustain damage, but it may not be fully functional. Operating the device in this manner may affect device reliability, functionality, performance, and shorten the device lifetime.
- (2) The input and output voltage ratings may be exceeded if the input and output current ratings are observed.

### 5.2 ESD Ratings

			VALUE	UNIT
V <sub>(ESD)</sub>	Electrostatic discharge	Human-body model (HBM), per ANSI/ESDA/JEDEC JS-001 <sup>(1)</sup>	±2000	V
		Charged-device model (CDM), per ANSI/ESDA/JEDEC JS-002 <sup>(2)</sup>	±1000	

- (1) JEDEC document JEP155 states that 500-V HBM allows safe manufacturing with a standard ESD control process.
- (2) JEDEC document JEP157 states that 250-V CDM allows safe manufacturing with a standard ESD control process.

### 5.3 Recommended Operating Conditions

over operating free-air temperature range (unless otherwise noted)

		MIN	MAX	UNIT	
V <sub>CC</sub>	Supply voltage	1.6	5.5	V	
V <sub>I</sub>	Input voltage	0	5.5	V	
V <sub>O</sub>	Output voltage	0	V <sub>CC</sub>	V	
I <sub>O</sub>	Output current	V <sub>CC</sub> = 1.6 V to 2 V		±3	mA
		V <sub>CC</sub> = 2.25 V to 2.75 V		±7	
		V <sub>CC</sub> = 3.3 V to 5.0 V		±15	
Δt/Δv	Input transition rise or fall rate	V <sub>CC</sub> = 1.6 V to 5.0 V		20	ns/V
T <sub>A</sub>	Operating free-air temperature	-55	125	°C	

### 5.4 Thermal Information

THERMAL METRIC <sup>(1)</sup>		SN74LV3T98-EP		UNIT
		PW (TSSOP)		
		14 PINS		
R <sub>θJA</sub>	Junction-to-ambient thermal resistance	147.7		°C/W
R <sub>θJC(top)</sub>	Junction-to-case (top) thermal resistance	77.4		°C/W
R <sub>θJB</sub>	Junction-to-board thermal resistance	90.9		°C/W
Ψ <sub>JT</sub>	Junction-to-top characterization parameter	27.2		°C/W

## 5.4 Thermal Information (continued)

THERMAL METRIC <sup>(1)</sup>		SN74LV3T98-EP	
		PW (TSSOP)	
		14 PINS	
Y <sub>JB</sub>	Junction-to-board characterization parameter	90.2	°C/W
R <sub>θJC(bot)</sub>	Junction-to-case (bottom) thermal resistance	N/A	°C/W

(1) For more information about traditional and new thermal metrics, see the [Semiconductor and IC Package Thermal Metrics](#) application report.

## 5.5 Electrical Characteristics

over operating free-air temperature range (unless otherwise noted)

PARAMETER	TEST CONDITIONS	V <sub>CC</sub>	T <sub>A</sub> = 25°C			-55°C to 125°C			UNIT
			MIN	TYP	MAX	MIN	TYP	MAX	
V <sub>T+</sub>	Positive-going input threshold voltage	1.65 V to 2 V	0.6		1.2	0.5		1.27	V
		2.25 V to 2.75 V	0.73		1.39	0.64		1.44	
		3 V to 3.6 V	0.88		1.59	0.80		1.63	
		4.5 V to 5.5 V	1.15		2.03	1.1		2.07	
V <sub>T-</sub>	Negative-going input threshold voltage	1.65 V to 2 V	0.225		0.685	0.185		0.755	V
		2.25 V to 2.75 V	0.295		0.775	0.265		0.805	
		3 V to 3.6 V	0.385		0.875	0.345		0.895	
		4.5 V to 5.5 V	0.535		1.075	0.495		1.085	
ΔV <sub>T</sub>	Hysteresis (V <sub>T+</sub> - V <sub>T-</sub> )	1.65 V to 2 V	0.35		0.68	0.28		0.8	V
		2.25 V to 2.75 V	0.4		0.77	0.33		0.87	
		3 V to 3.6 V	0.44		0.88	0.38		0.91	
		4.5 V to 5.5 V	0.53		1.2	0.51		1.4	
V <sub>OH</sub>	I <sub>OH</sub> = -50 μA	1.65 V to 5.5 V	V <sub>CC</sub> -0.1		V <sub>CC</sub> -0.1			V	
	I <sub>OH</sub> = -2 mA	1.65 V to 2 V	1.28	1.7 <sup>(1)</sup>	1.21				
	I <sub>OH</sub> = -3 mA	2.25 V to 2.75 V	2	2.4 <sup>(1)</sup>	1.93				
	I <sub>OH</sub> = -5.5 mA	3 V to 3.6 V	2.6	3.08 <sup>(1)</sup>	2.49				
	I <sub>OH</sub> = -8 mA	4.5 V to 5.5 V	4.1	4.65 <sup>(1)</sup>	3.95				
V <sub>OL</sub>	I <sub>OL</sub> = 50 μA	1.65 V to 5.5 V			0.1			V	
	I <sub>OL</sub> = 2 mA	1.65 V to 2 V			0.1 <sup>(1)</sup>	0.2	0.25		
	I <sub>OL</sub> = 3 mA	2.25 V to 2.75 V			0.1 <sup>(1)</sup>	0.15	0.2		
	I <sub>OL</sub> = 5.5 mA	3 V to 3.6 V			0.2 <sup>(1)</sup>	0.2	0.25		
	I <sub>OL</sub> = 8 mA	4.5 V to 5.5 V			0.3 <sup>(1)</sup>	0.3	0.35		
I <sub>I</sub>	V <sub>I</sub> = 0 V or V <sub>CC</sub>	0 V to 5.5 V				±0.1	±1	μA	
I <sub>CC</sub>	V <sub>I</sub> = 0 V or V <sub>CC</sub> , I <sub>O</sub> = 0; open on loading	1.65 V to 5.5 V				2	20	μA	
ΔI <sub>CC</sub>	One input at 0.3 V or 3.4 V, other inputs at 0 or V <sub>CC</sub> , I <sub>O</sub> = 0	5.5 V				1.35	1.5	mA	
	One input at 0.3 V or 1.1 V, other inputs at 0 or V <sub>CC</sub> , I <sub>O</sub> = 0	1.8 V				10	20	μA	
C <sub>I</sub>	V <sub>I</sub> = V <sub>CC</sub> or GND	5 V				4	10	pF	
C <sub>O</sub>	V <sub>O</sub> = V <sub>CC</sub> or GND	5 V				3		pF	

over operating free-air temperature range (unless otherwise noted)

PARAMETER	TEST CONDITIONS	V <sub>CC</sub>	T <sub>A</sub> = 25°C			-55°C to 125°C			UNIT
			MIN	TYP	MAX	MIN	TYP	MAX	
C <sub>PD</sub>	No load, F = 1MHz	5 V	14						pF

(1) Typical value at nearest nominal voltage (1.8 V, 2.5 V, 3.3 V, and 5 V)

## 5.6 Switching Characteristics

over operating free-air temperature range; typical ratings measured at T<sub>A</sub> = 25°C (unless otherwise noted).

PARAMETER	FROM (INPUT)	TO (OUTPUT)	LOAD CAPACITANCE	V <sub>CC</sub>	MIN	TYP	MAX	UNIT
t <sub>PHL</sub>	A, B or C	Y	C <sub>L</sub> = 15pF	1.8 V		16.0	37.9	nS
t <sub>PLH</sub>	A, B or C	Y	C <sub>L</sub> = 15pF	1.8 V		14.0	34.5	nS
t <sub>PHL</sub>	A, B or C	Y	C <sub>L</sub> = 50pF	1.8 V		19.4	43.4	nS
t <sub>PLH</sub>	A, B or C	Y	C <sub>L</sub> = 50pF	1.8 V		16.7	38.7	nS
t <sub>PHL</sub>	A, B or C	Y	C <sub>L</sub> = 15pF	2.5 V		9.4	21.8	nS
t <sub>PLH</sub>	A, B or C	Y	C <sub>L</sub> = 15pF	2.5 V		8.3	19.9	nS
t <sub>PHL</sub>	A, B or C	Y	C <sub>L</sub> = 50pF	2.5 V		12.0	25.7	nS
t <sub>PLH</sub>	A, B or C	Y	C <sub>L</sub> = 50pF	2.5 V		10.3	22.8	nS
t <sub>PHL</sub>	A, B or C	Y	C <sub>L</sub> = 15pF	3.3 V		7.0	15.5	nS
t <sub>PLH</sub>	A, B or C	Y	C <sub>L</sub> = 15pF	3.3 V		6.4	14.1	nS
t <sub>PHL</sub>	A, B or C	Y	C <sub>L</sub> = 50pF	3.3 V		9.2	18.6	nS
t <sub>PLH</sub>	A, B or C	Y	C <sub>L</sub> = 50pF	3.3 V		7.9	16.6	nS
t <sub>PHL</sub>	A, B or C	Y	C <sub>L</sub> = 15pF	5 V		5.2	10.4	nS
t <sub>PLH</sub>	A, B or C	Y	C <sub>L</sub> = 15pF	5 V		4.9	9.7	nS
t <sub>PHL</sub>	A, B or C	Y	C <sub>L</sub> = 50pF	5 V		6.7	12.7	nS
t <sub>PLH</sub>	A, B or C	Y	C <sub>L</sub> = 50pF	5 V		6.2	11.5	nS

## 5.7 Noise Characteristics

V<sub>CC</sub> = 5 V, C<sub>L</sub> = 50 pF, T<sub>A</sub> = 25°C

PARAMETER	DESCRIPTION	MIN	TYP	MAX	UNIT
V <sub>OL(P)</sub>	Quiet output, maximum dynamic V <sub>OL</sub>		1	1.2	V
V <sub>OL(V)</sub>	Quiet output, minimum dynamic V <sub>OL</sub>	-0.8	-0.3		V
V <sub>OH(V)</sub>	Quiet output, minimum dynamic V <sub>OH</sub>	4.4	5		V
V <sub>IH(D)</sub>	High-level dynamic input voltage	2.1			V
V <sub>IL(D)</sub>	Low-level dynamic input voltage			0.5	V

## 5.8 Typical Characteristics

T<sub>A</sub> = 25°C (unless otherwise noted)



**Figure 5-1. Supply Current Across Input Voltage 1.8-V and 2.5-V Supply**

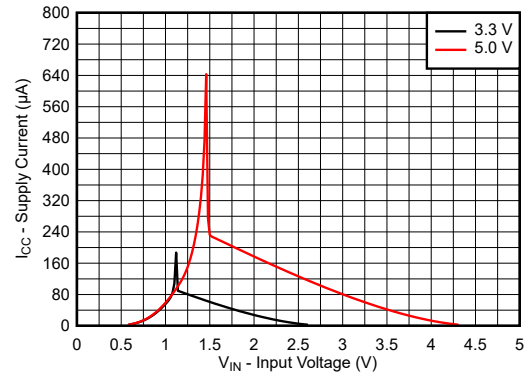

**Figure 5-2. Supply Current Across Input Voltage 3.3-V and 5.0-V Supply**

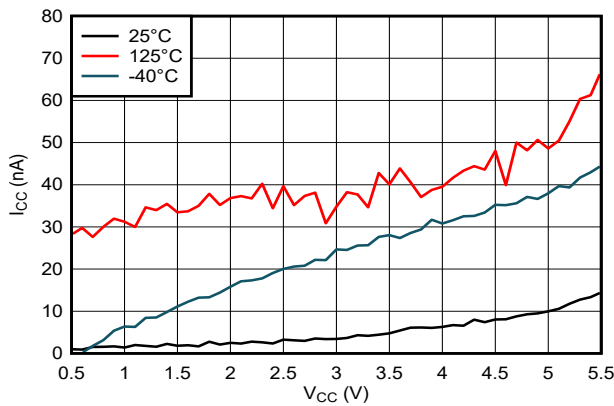

**Figure 5-3. Supply Current Across Supply Voltage**

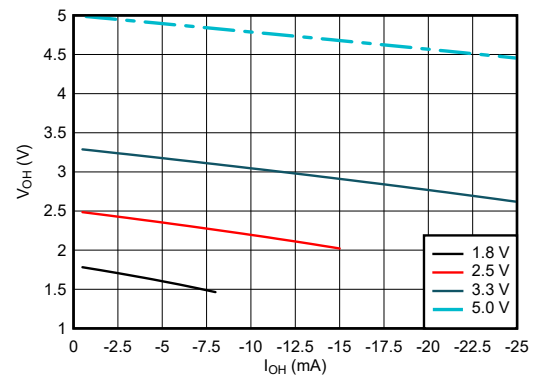

**Figure 5-4. Output Voltage vs Current in HIGH State**

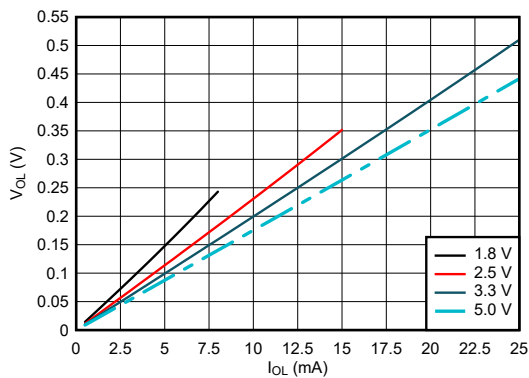

**Figure 5-5. Output Voltage vs Current in LOW State**

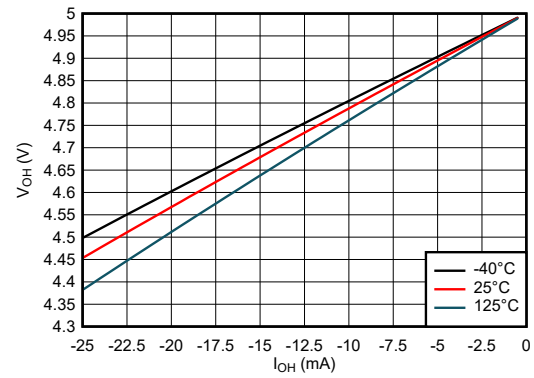

**Figure 5-6. Output Voltage vs Current in HIGH State; 5-V Supply**

## 5.8 Typical Characteristics (continued)

$T_A = 25^\circ\text{C}$  (unless otherwise noted)



Figure 5-7. Output Voltage vs Current in LOW State; 5-V Supply



Figure 5-8. Output Voltage vs Current in HIGH State; 3.3-V Supply



Figure 5-9. Output Voltage vs Current in LOW State; 3.3-V Supply



Figure 5-10. Output Voltage vs Current in HIGH State; 2.5-V Supply



Figure 5-11. Output Voltage vs Current in LOW State; 2.5-V Supply



Figure 5-12. Output Voltage vs Current in HIGH State; 1.8-V Supply



## 5.8 Typical Characteristics (continued)

$T_A = 25^\circ\text{C}$  (unless otherwise noted)

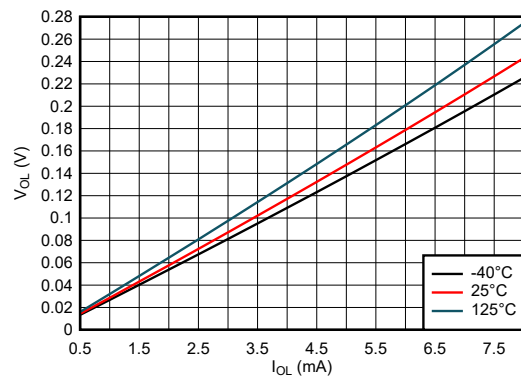

Figure 5-13. Output Voltage vs Current in LOW State; 1.8-V Supply

## 6 Parameter Measurement Information

Phase relationships between waveforms were chosen arbitrarily. All input pulses are supplied by generators having the following characteristics:  $PRR \leq 1$  MHz,  $Z_O = 50 \Omega$ ,  $t_t < 2.5$  ns.

For clock inputs,  $f_{max}$  is measured when the input duty cycle is 50%.

The outputs are measured one at a time with one input transition per measurement.



(1)  $C_L$  includes probe and test-fixture capacitance.

**Figure 6-1. Load Circuit for Push-Pull Outputs**



(1) The greater between  $t_{PLH}$  and  $t_{PHL}$  is the same as  $t_{pd}$ .

**Figure 6-2. Voltage Waveforms Propagation Delays**



(1) The greater between  $t_r$  and  $t_f$  is the same as  $t_t$ .

**Figure 6-3. Voltage Waveforms, Input and Output Transition Times**

## 7 Detailed Description

### 7.1 Overview

The SN74LV3T98-EP contains a single buffer with extended voltage operation to allow for level translation. The buffer performs the Boolean function  $Y = A$  in positive logic. The output level is referenced to the supply voltage ( $V_{CC}$ ) and supports 1.8-V, 2.5-V, 3.3-V, and 5-V CMOS levels.

### 7.2 Functional Block Diagram

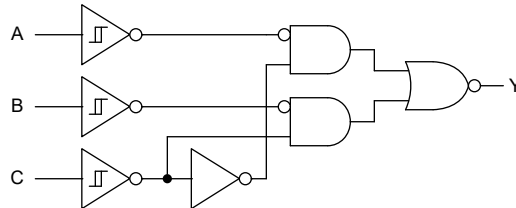

### 7.3 Feature Description

#### 7.3.1 Balanced CMOS Push-Pull Outputs

This device includes balanced CMOS push-pull outputs. The term *balanced* indicates that the device can sink and source similar currents. The drive capability of this device may create fast edges into light loads so routing and load conditions should be considered to prevent ringing. Additionally, the outputs of this device are capable of driving larger currents than the device can sustain without being damaged. It is important for the output power of the device to be limited to avoid damage due to overcurrent. The electrical and thermal limits defined in the *Absolute Maximum Ratings* must be followed at all times.

Unused push-pull CMOS outputs should be left disconnected.

#### 7.3.2 Clamp Diode Structure

As [Figure 7-1](#) shows, the outputs to this device have both positive and negative clamping diodes, and the inputs to this device have negative clamping diodes only.

**CAUTION**

Voltages beyond the values specified in the *Absolute Maximum Ratings* table can cause damage to the device. The input and output voltage ratings may be exceeded if the input and output clamp-current ratings are observed.

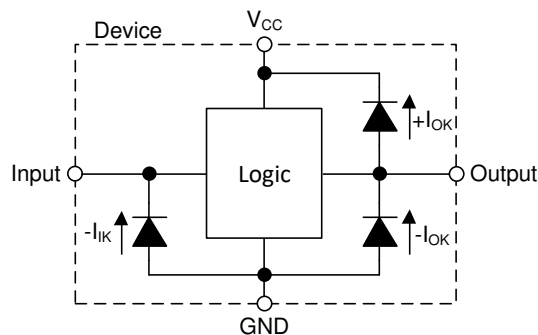

**Figure 7-1. Electrical Placement of Clamping Diodes for Each Input and Output**

### 7.3.3 SCxT Enhanced Input Voltage

The SN74LV3T98-EP belongs to TI's SCxT family of logic devices with integrated voltage level translation. This family of devices was designed with reduced input voltage thresholds to support up-translation, and inputs tolerant of signals with up to 5.5 V levels to support down-translation. The output voltage will always be referenced to the supply voltage ( $V_{CC}$ ), as described in the *Electrical Characteristics* table. For proper functionality, input signals must remain at or below the specified  $V_{IH(MIN)}$  level for a HIGH input state, and at or below the specified  $V_{IL(MAX)}$  for a LOW input state. Figure 7-2 shows the typical  $V_{IH}$  and  $V_{IL}$  levels for the SCxT family of devices, as well as the voltage levels for standard CMOS devices for comparison.

The inputs are high impedance and are typically modeled as a resistor in parallel with the input capacitance given in the *Electrical Characteristics*. The worst case resistance is calculated with the maximum input voltage, given in the *Absolute Maximum Ratings*, and the maximum input leakage current, given in the *Electrical Characteristics*, using Ohm's law ( $R = V \div I$ ).

The inputs require the input signals to transition between valid logic states quickly, as defined by the input transition time or rate in the *Recommended Operating Conditions* table. Failing to meet this specification will result in excessive power consumption and can cause oscillations. More details can be found in the *Implications of Slow or Floating CMOS Inputs* application report.

Do not leave inputs floating at any time during operation. Unused inputs must be terminated at  $V_{CC}$  or GND. If a system will not be actively driving an input at all times, a pull-up or pull-down resistor can be added to provide a valid input voltage during these times. The resistor value will depend on multiple factors; however, a 10-k $\Omega$  resistor is recommended and will typically meet all requirements.

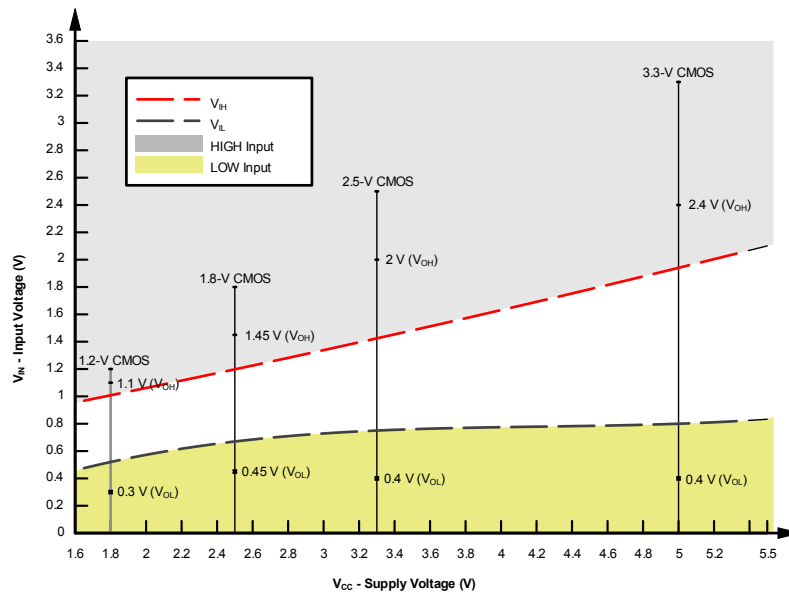

Figure 7-2. SCxT Input Voltage Levels

#### 7.3.3.1 Down Translation

Signals can be translated down using the SN74LV3T98-EP. The voltage applied at the  $V_{CC}$  will determine the output voltage and the input thresholds as described in the *Recommended Operating Conditions* and *Electrical Characteristics* tables.

When connected to a high-impedance input, the output voltage will be approximately  $V_{CC}$  in the HIGH state, and 0 V in the LOW state. Ensure that the input signals in the HIGH state are between  $V_{IH(MIN)}$  and 5.5 V, and input signals in the LOW state are lower than  $V_{IL(MAX)}$  as shown in Figure 7-2.

For example, standard CMOS inputs for devices operating at 5.0 V, 3.3 V or 2.5 V can be down-translated to match 1.8 V CMOS signals when operating from 1.8-V  $V_{CC}$ . See Figure 7-3.

Down Translation Combinations are as follows:

- 1.8-V  $V_{CC}$  – Inputs from 2.5 V, 3.3 V, and 5.0 V
- 2.5-V  $V_{CC}$  – Inputs from 3.3 V and 5.0 V
- 3.3-V  $V_{CC}$  – Inputs from 5.0 V

### 7.3.3.2 Up Translation

Input signals can be up translated using the SN74LV3T98-EP. The voltage applied at  $V_{CC}$  will determine the output voltage and the input thresholds as described in the *Recommended Operating Conditions* and *Electrical Characteristics* tables. When connected to a high-impedance input, the output voltage will be approximately  $V_{CC}$  in the HIGH state, and 0 V in the LOW state.

The inputs have reduced thresholds that allow for input HIGH state levels which are much lower than standard values. For example, standard CMOS inputs for a device operating at a 5-V supply will have a  $V_{IH(MIN)}$  of 3.5 V. For the SN74LV3T98-EP,  $V_{IH(MIN)}$  with a 5-V supply is only 2 V, which would allow for up-translation from a typical 2.5-V to 5-V signals.

Ensure that the input signals in the HIGH state are above  $V_{IH(MIN)}$  and input signals in the LOW state are lower than  $V_{IL(MAX)}$  as shown in [Figure 7-3](#).

Up Translation Combinations are as follows:

- 1.8-V  $V_{CC}$  – Inputs from 1.2 V
- 2.5-V  $V_{CC}$  – Inputs from 1.8 V
- 3.3-V  $V_{CC}$  – Inputs from 1.8 V and 2.5 V
- 5.0-V  $V_{CC}$  – Inputs from 2.5 V and 3.3 V

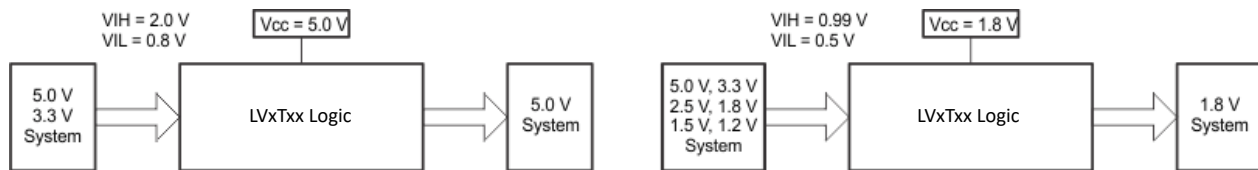

**Figure 7-3. SCxT Up and Down Translation Example**

## 7.4 Device Functional Modes

[Table 7-1](#) is the function table for the SN74LV3T98-EP.

**Table 7-1. Function Table**

INPUTS <sup>(1)</sup>			OUTPUTS
A	B	C	Y
L	L	L	H
L	L	H	H
L	H	L	L
L	H	H	H
H	L	L	H
H	L	H	L
H	H	L	L
H	H	H	L

(1) H = high voltage level, L = low voltage level

### 7.4.1 Logic Configurations

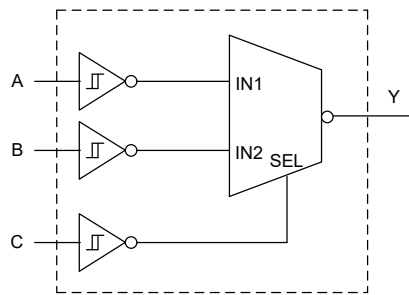
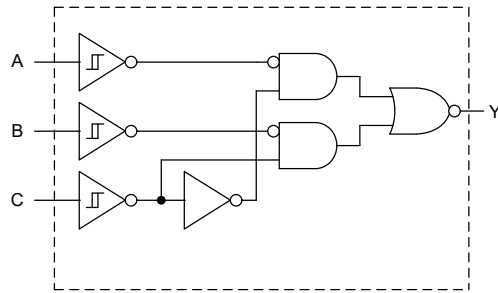

2 to 1 Data Selector with inverted output  
 $Y = \bar{A}$  when C is H  
 $Y = B$  when C is L

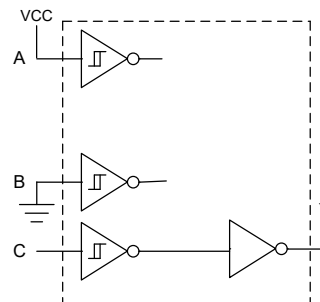

Inverter

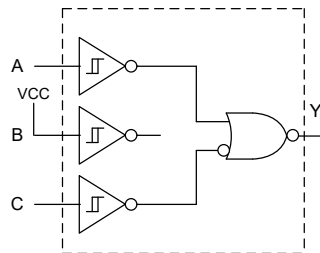

2 - Input NOR Gate  
 with one inverted input

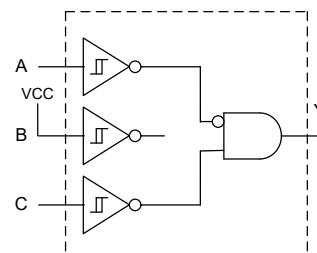

2 - Input AND Gate  
 with one inverted input

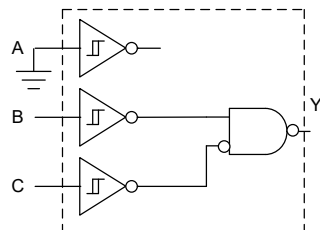

2 - Input NAND Gate  
 with one inverted input

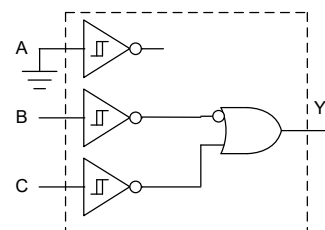

2 - Input OR Gate  
 with one inverted input

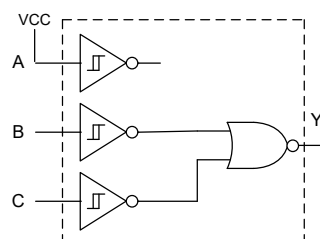

2 - Input NOR Gate

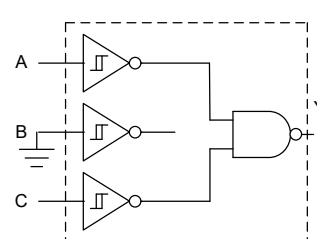

2 - Input NAND Gate

## 8 Application and Implementation

### Note

Information in the following applications sections is not part of the TI component specification, and TI does not warrant its accuracy or completeness. TI's customers are responsible for determining suitability of components for their purposes, as well as validating and testing their design implementation to confirm system functionality.

### 8.1 Application Information

The SN74LV3T98-EP device offers flexible configuration for many design applications. This example describes basic power sequencing using the AND gate configuration. Power sequencing is often used in applications that require a processor or other delicate device with specific voltage timing requirements to protect the device from malfunctioning.

### 8.2 Typical Application

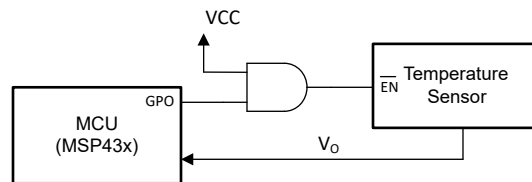

**Figure 8-1. Typical Application Schematic**

#### 8.2.1 Design Requirements

##### 8.2.1.1 Power Considerations

Ensure the desired supply voltage is within the range specified in the *Recommended Operating Conditions*. The supply voltage sets the device's electrical characteristics as described in the *Electrical Characteristics* section.

The positive voltage supply must be capable of sourcing current equal to the total current to be sourced by all outputs of the SN74LV3T98-EP plus the maximum static supply current,  $I_{CC}$ , listed in the *Electrical Characteristics*, and any transient current required for switching. The logic device can only source as much current that is provided by the positive supply source. Be sure to not exceed the maximum total current through  $V_{CC}$  listed in the *Absolute Maximum Ratings*.

The ground must be capable of sinking current equal to the total current to be sunk by all outputs of the SN74LV3T98-EP plus the maximum supply current,  $I_{CC}$ , listed in the *Electrical Characteristics*, and any transient current required for switching. The logic device can only sink as much current that can be sunk into its ground connection. Be sure to not exceed the maximum total current through GND listed in the *Absolute Maximum Ratings*.

The SN74LV3T98-EP can drive a load with a total capacitance less than or equal to 50 pF while still meeting all of the data sheet specifications. Larger capacitive loads can be applied; however, it is not recommended to exceed 50 pF.

The SN74LV3T98-EP can drive a load with total resistance described by  $R_L \geq V_O / I_O$ , with the output voltage and current defined in the *Electrical Characteristics* table with  $V_{OH}$  and  $V_{OL}$ . When outputting in the HIGH state, the output voltage in the equation is defined as the difference between the measured output voltage and the supply voltage at the  $V_{CC}$  pin.

Total power consumption can be calculated using the information provided in [CMOS Power Consumption and Cpd Calculation](#).

Thermal increase can be calculated using the information provided in [Thermal Characteristics of Standard Linear and Logic \(SLL\) Packages and Devices](#).

#### CAUTION

The maximum junction temperature,  $T_{J(max)}$  listed in the *Absolute Maximum Ratings*, is an additional limitation to prevent damage to the device. Do not violate any values listed in the *Absolute Maximum Ratings*. These limits are provided to prevent damage to the device.

#### 8.2.1.2 Input Considerations

Input signals must cross  $V_{t-(min)}$  to be considered a logic LOW, and  $V_{t+(max)}$  to be considered a logic HIGH. Do not exceed the maximum input voltage range found in the *Absolute Maximum Ratings*.

Unused inputs must be terminated to either  $V_{CC}$  or ground. The unused inputs can be directly terminated if the input is completely unused, or they can be connected with a pull-up or pull-down resistor if the input will be used sometimes, but not always. A pull-up resistor is used for a default state of HIGH, and a pull-down resistor is used for a default state of LOW. The drive current of the controller, leakage current into the SN74LV3T98-EP (as specified in the *Electrical Characteristics*), and the desired input transition rate limits the resistor size. A 10-k $\Omega$  resistor value is often used due to these factors.

The SN74LV3T98-EP has no input signal transition rate requirements because it has Schmitt-trigger inputs.

Another benefit to having Schmitt-trigger inputs is the ability to reject noise. Noise with a large enough amplitude can still cause issues. To know how much noise is too much, please refer to the  $\Delta V_{T(min)}$  in the *Electrical Characteristics*. This hysteresis value will provide the peak-to-peak limit.

Unlike what happens with standard CMOS inputs, Schmitt-trigger inputs can be held at any valid value without causing huge increases in power consumption. The typical additional current caused by holding an input at a value other than  $V_{CC}$  or ground is plotted in the *Typical Characteristics*.

Refer to the *Feature Description* section for additional information regarding the inputs for this device.

#### 8.2.1.3 Output Considerations

The positive supply voltage is used to produce the output HIGH voltage. Drawing current from the output will decrease the output voltage as specified by the  $V_{OH}$  specification in the *Electrical Characteristics*. The ground voltage is used to produce the output LOW voltage. Sinking current into the output will increase the output voltage as specified by the  $V_{OL}$  specification in the *Electrical Characteristics*.

Push-pull outputs that could be in opposite states, even for a very short time period, should never be connected directly together. This can cause excessive current and damage to the device.

Two channels within the same device with the same input signals can be connected in parallel for additional output drive strength.

Unused outputs can be left floating. Do not connect outputs directly to  $V_{CC}$  or ground.

Refer to the *Feature Description* section for additional information regarding the outputs for this device.



## 8.2.2 Detailed Design Procedure

1. Add a decoupling capacitor from  $V_{CC}$  to GND. The capacitor needs to be placed physically close to the device and electrically close to both the  $V_{CC}$  and GND pins. An example layout is shown in the *Layout* section.
2. Ensure the capacitive load at the output is  $\leq 50$  pF. This is not a hard limit; it will, however, optimize performance. This can be accomplished by providing short, appropriately sized traces from the SN74LV3T98-EP to one or more of the receiving devices.
3. Ensure the resistive load at the output is larger than  $(V_{CC} / I_{O(max)}) \Omega$ . Doing so will not violate the maximum output current from the Absolute Maximum Ratings. Most CMOS inputs have a resistive load measured in  $M\Omega$ ; much larger than the minimum calculated previously.
4. Thermal issues are rarely a concern for logic gates; the power consumption and thermal increase, however, can be calculated using the steps provided in the application report, [CMOS Power Consumption and Cpd Calculation](#).

## 8.2.3 Application Curves

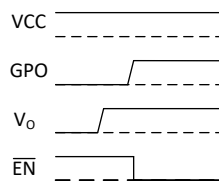

Figure 8-2. Typical Application Timing Diagram

## 8.3 Power Supply Recommendations

The power supply can be any voltage between the minimum and maximum supply voltage rating located in the *Recommended Operating Conditions*. Each  $V_{CC}$  terminal should have a good bypass capacitor to prevent power disturbance. A 0.1- $\mu$ F capacitor is recommended for this device. It is acceptable to parallel multiple bypass capacitors to reject different frequencies of noise. The 0.1- $\mu$ F and 1- $\mu$ F capacitors are commonly used in parallel. The bypass capacitor should be installed as close to the power terminal as possible for best results, as shown in the following layout example.

## 8.4 Layout

### 8.4.1 Layout Guidelines

When using multiple-input and multiple-channel logic devices, inputs must never be left floating. In many cases, functions or parts of functions of digital logic devices are unused; for example, when only two inputs of a triple-input AND gate are used or only 3 of the 4 buffer gates are used. Such unused input pins must not be left unconnected because the undefined voltages at the outside connections result in undefined operational states. All unused inputs of digital logic devices must be connected to a logic high or logic low voltage, as defined by the input voltage specifications, to prevent them from floating. The logic level that must be applied to any particular unused input depends on the function of the device. Generally, the inputs are tied to GND or  $V_{CC}$ , whichever makes more sense for the logic function or is more convenient.

### 8.4.2 Layout Example

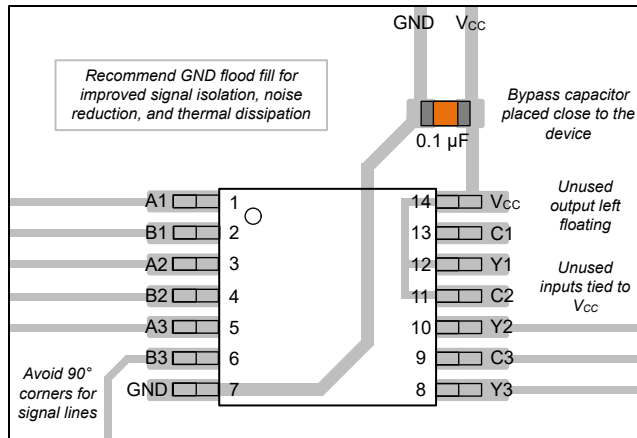

**Figure 8-3. Example Layout for the SN74LV3T98-EP**

## 9 Device and Documentation Support

### 9.1 Documentation Support

#### 9.1.1 Related Documentation

For related documentation, see the following:

- Texas Instruments, [Implications of Slow or Floating CMOS Inputs application report](#)

### 9.2 Receiving Notification of Documentation Updates

To receive notification of documentation updates, navigate to the device product folder on [ti.com](#). Click on *Notifications* to register and receive a weekly digest of any product information that has changed. For change details, review the revision history included in any revised document.

### 9.3 Support Resources

[TI E2E™ support forums](#) are an engineer's go-to source for fast, verified answers and design help — straight from the experts. Search existing answers or ask your own question to get the quick design help you need.

Linked content is provided "AS IS" by the respective contributors. They do not constitute TI specifications and do not necessarily reflect TI's views; see TI's [Terms of Use](#).

### 9.4 Trademarks

TI E2E™ is a trademark of Texas Instruments.

All trademarks are the property of their respective owners.

### 9.5 Electrostatic Discharge Caution



This integrated circuit can be damaged by ESD. Texas Instruments recommends that all integrated circuits be handled with appropriate precautions. Failure to observe proper handling and installation procedures can cause damage.

ESD damage can range from subtle performance degradation to complete device failure. Precision integrated circuits may be more susceptible to damage because very small parametric changes could cause the device not to meet its published specifications.

### 9.6 Glossary

[TI Glossary](#) This glossary lists and explains terms, acronyms, and definitions.

## 10 Revision History

DATE	REVISION	NOTES
November 2023	*	Initial Release

## 11 Mechanical, Packaging, and Orderable Information

The following pages include mechanical, packaging, and orderable information. This information is the most current data available for the designated devices. This data is subject to change without notice and revision of this document. For browser-based versions of this data sheet, refer to the left-hand navigation.

**PACKAGING INFORMATION**

Orderable Device	Status (1)	Package Type	Package Drawing	Pins	Package Qty	Eco Plan (2)	Lead finish/ Ball material (6)	MSL Peak Temp (3)	Op Temp (°C)	Device Marking (4/5)	Samples
SN74LV3T98PWREP	ACTIVE	TSSOP	PW	14	3000	RoHS & Green	NIPDAU	Level-1-260C-UNLIM	-55 to 125	LV398EP	Samples
V62/24603-01XE	ACTIVE	TSSOP	PW	14	3000	RoHS & Green	NIPDAU	Level-1-260C-UNLIM		LV398EP	Samples

(1) The marketing status values are defined as follows:

**ACTIVE:** Product device recommended for new designs.

**LIFEBUY:** TI has announced that the device will be discontinued, and a lifetime-buy period is in effect.

**NRND:** Not recommended for new designs. Device is in production to support existing customers, but TI does not recommend using this part in a new design.

**PREVIEW:** Device has been announced but is not in production. Samples may or may not be available.

**OBSOLETE:** TI has discontinued the production of the device.

(2) **RoHS:** TI defines "RoHS" to mean semiconductor products that are compliant with the current EU RoHS requirements for all 10 RoHS substances, including the requirement that RoHS substance do not exceed 0.1% by weight in homogeneous materials. Where designed to be soldered at high temperatures, "RoHS" products are suitable for use in specified lead-free processes. TI may reference these types of products as "Pb-Free".

**RoHS Exempt:** TI defines "RoHS Exempt" to mean products that contain lead but are compliant with EU RoHS pursuant to a specific EU RoHS exemption.

**Green:** TI defines "Green" to mean the content of Chlorine (Cl) and Bromine (Br) based flame retardants meet JS709B low halogen requirements of <=1000ppm threshold. Antimony trioxide based flame retardants must also meet the <=1000ppm threshold requirement.

(3) MSL, Peak Temp. - The Moisture Sensitivity Level rating according to the JEDEC industry standard classifications, and peak solder temperature.

(4) There may be additional marking, which relates to the logo, the lot trace code information, or the environmental category on the device.

(5) Multiple Device Markings will be inside parentheses. Only one Device Marking contained in parentheses and separated by a "~" will appear on a device. If a line is indented then it is a continuation of the previous line and the two combined represent the entire Device Marking for that device.

(6) Lead finish/Ball material - Orderable Devices may have multiple material finish options. Finish options are separated by a vertical ruled line. Lead finish/Ball material values may wrap to two lines if the finish value exceeds the maximum column width.

**Important Information and Disclaimer:**The information provided on this page represents TI's knowledge and belief as of the date that it is provided. TI bases its knowledge and belief on information provided by third parties, and makes no representation or warranty as to the accuracy of such information. Efforts are underway to better integrate information from third parties. TI has taken and continues to take reasonable steps to provide representative and accurate information but may not have conducted destructive testing or chemical analysis on incoming materials and chemicals. TI and TI suppliers consider certain information to be proprietary, and thus CAS numbers and other limited information may not be available for release.

In no event shall TI's liability arising out of such information exceed the total purchase price of the TI part(s) at issue in this document sold by TI to Customer on an annual basis.



**TAPE AND REEL INFORMATION**

**QUADRANT ASSIGNMENTS FOR PIN 1 ORIENTATION IN TAPE**

\*All dimensions are nominal

Device	Package Type	Package Drawing	Pins	SPQ	Reel Diameter (mm)	Reel Width W1 (mm)	A0 (mm)	B0 (mm)	K0 (mm)	P1 (mm)	W (mm)	Pin1 Quadrant
SN74LV3T98PWREP	TSSOP	PW	14	3000	330.0	12.4	6.9	5.6	1.6	8.0	12.0	Q1

**TAPE AND REEL BOX DIMENSIONS**

\*All dimensions are nominal

Device	Package Type	Package Drawing	Pins	SPQ	Length (mm)	Width (mm)	Height (mm)
SN74LV3T98PWREP	TSSOP	PW	14	3000	356.0	356.0	35.0

PW0014A



**PACKAGE OUTLINE**  
**TSSOP - 1.2 mm max height**

SMALL OUTLINE PACKAGE



4220202/B 12/2023

NOTES:

1. All linear dimensions are in millimeters. Any dimensions in parenthesis are for reference only. Dimensioning and tolerancing per ASME Y14.5M.
2. This drawing is subject to change without notice.
3. This dimension does not include mold flash, protrusions, or gate burrs. Mold flash, protrusions, or gate burrs shall not exceed 0.15 mm per side.
4. This dimension does not include interlead flash. Interlead flash shall not exceed 0.25 mm per side.
5. Reference JEDEC registration MO-153.



# EXAMPLE BOARD LAYOUT

PW0014A

TSSOP - 1.2 mm max height

SMALL OUTLINE PACKAGE



LAND PATTERN EXAMPLE  
EXPOSED METAL SHOWN  
SCALE: 10X



4220202/B 12/2023

NOTES: (continued)

- 6. Publication IPC-7351 may have alternate designs.
- 7. Solder mask tolerances between and around signal pads can vary based on board fabrication site.

# EXAMPLE STENCIL DESIGN

PW0014A

TSSOP - 1.2 mm max height

SMALL OUTLINE PACKAGE



SOLDER PASTE EXAMPLE  
BASED ON 0.125 mm THICK STENCIL  
SCALE: 10X

4220202/B 12/2023

NOTES: (continued)

8. Laser cutting apertures with trapezoidal walls and rounded corners may offer better paste release. IPC-7525 may have alternate design recommendations.
9. Board assembly site may have different recommendations for stencil design.

## IMPORTANT NOTICE AND DISCLAIMER

TI PROVIDES TECHNICAL AND RELIABILITY DATA (INCLUDING DATA SHEETS), DESIGN RESOURCES (INCLUDING REFERENCE DESIGNS), APPLICATION OR OTHER DESIGN ADVICE, WEB TOOLS, SAFETY INFORMATION, AND OTHER RESOURCES "AS IS" AND WITH ALL FAULTS, AND DISCLAIMS ALL WARRANTIES, EXPRESS AND IMPLIED, INCLUDING WITHOUT LIMITATION ANY IMPLIED WARRANTIES OF MERCHANTABILITY, FITNESS FOR A PARTICULAR PURPOSE OR NON-INFRINGEMENT OF THIRD PARTY INTELLECTUAL PROPERTY RIGHTS.

These resources are intended for skilled developers designing with TI products. You are solely responsible for (1) selecting the appropriate TI products for your application, (2) designing, validating and testing your application, and (3) ensuring your application meets applicable standards, and any other safety, security, regulatory or other requirements.

These resources are subject to change without notice. TI grants you permission to use these resources only for development of an application that uses the TI products described in the resource. Other reproduction and display of these resources is prohibited. No license is granted to any other TI intellectual property right or to any third party intellectual property right. TI disclaims responsibility for, and you will fully indemnify TI and its representatives against, any claims, damages, costs, losses, and liabilities arising out of your use of these resources.

TI's products are provided subject to [TI's Terms of Sale](#) or other applicable terms available either on [ti.com](https://www.ti.com) or provided in conjunction with such TI products. TI's provision of these resources does not expand or otherwise alter TI's applicable warranties or warranty disclaimers for TI products.

TI objects to and rejects any additional or different terms you may have proposed.

Mailing Address: Texas Instruments, Post Office Box 655303, Dallas, Texas 75265  
Copyright © 2024, Texas Instruments Incorporated