

TLV2432, TLV2432A, TLV2434, TLV2434A Advanced LinCMOS™ RAIL-TO-RAIL OUTPUT WIDE-INPUT-VOLTAGE OPERATIONAL AMPLIFIERS

SLOS168F – NOVEMBER 1996 – REVISED MARCH 2001

- Output Swing Includes Both Supply Rails
- Extended Common-Mode Input Voltage Range . . . 0 V to 4.5 V (Min) with 5-V Single Supply
- No Phase Inversion
- Low Noise . . . 18 nV/√Hz Typ at f = 1 kHz
- Low Input Offset Voltage
950 μV Max at T_A = 25°C (TLV243xA)
- Low Input Bias Current . . . 1 pA Typ
- Very Low Supply Current . . . 125 μA Per Channel Max
- 600-Ω Output Drive
- Macromodel Included
- Available in Q-Temp Automotive HighRel Automotive Applications Configuration Control / Print Support Qualification to Automotive Standards

description

The TLV243x and TLV243xA are low-voltage operational amplifier from Texas Instruments. The common-mode input voltage range for each device is extended over the typical CMOS amplifiers making them suitable for a wide range of applications. In addition, these devices do not phase invert when the common-mode input is driven to the supply rails. This satisfies most design requirements without paying a premium for rail-to-rail input performance. They also exhibit rail-to-rail output performance for increased dynamic range in single- or split-supply applications. This family is fully characterized at 3-V and 5-V supplies and is optimized for low-voltage operation. The TLV243x only requires 100 μA (typ) of supply current per channel, making it ideal for battery-powered applications. The TLV243x also has increased output drive over previous rail-to-rail operational amplifiers and can drive 600-Ω loads for telecom applications.

The other members in the TLV243x family are the high-power, TLV244x, and micro-power, TLV2422, versions.

The TLV243x, exhibiting high input impedance and low noise, is excellent for small-signal conditioning for high-impedance sources, such as piezoelectric transducers. Because of the micropower dissipation levels and low-voltage operation, these devices work well in hand-held monitoring and remote-sensing applications. In addition, the rail-to-rail output feature with single- or split-supplies makes this family a great choice when interfacing with analog-to-digital converters (ADCs). For precision applications, the TLV243xA is available and has a maximum input offset voltage of 950 μV.

If the design requires single operational amplifiers, see the TI TLV2211/21/31. This is a family of rail-to-rail output operational amplifiers in the SOT-23 package. Their small size and low power consumption, make them ideal for high density, battery-powered equipment.

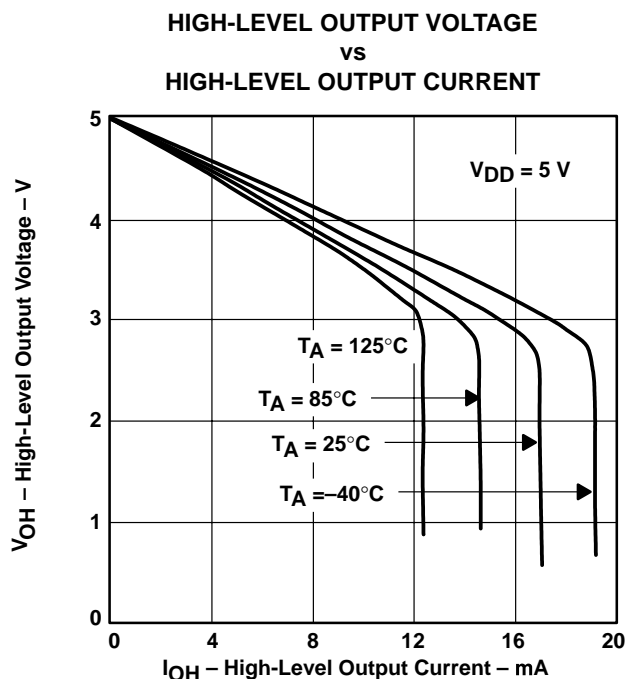

Figure 1



Please be aware that an important notice concerning availability, standard warranty, and use in critical applications of Texas Instruments semiconductor products and disclaimers thereto appears at the end of this data sheet.

Advanced LinCMOS is a trademark of Texas Instruments.

PRODUCTION DATA information is current as of publication date. Products conform to specifications per the terms of Texas Instruments standard warranty. Production processing does not necessarily include testing of all parameters.

 **TEXAS
INSTRUMENTS**

POST OFFICE BOX 655303 • DALLAS, TEXAS 75265

Copyright © 2001, Texas Instruments Incorporated
On products compliant to MIL-PRF-38535, all parameters are tested unless otherwise noted. On all other products, production processing does not necessarily include testing of all parameters.

TLV2432, TLV2432A, TLV2434, TLV2434A

Advanced LinCMOS™ RAIL-TO-RAIL OUTPUT

WIDE-INPUT-VOLTAGE OPERATIONAL AMPLIFIERS

SLOS168F – NOVEMBER 1996 – REVISED MARCH 2001

TLV2432 and TLV2432A AVAILABLE OPTIONS

T _A	V _{IO} max AT 25°C	PACKAGED DEVICES				
		SMALL OUTLINE (D)	CHIP CARRIER (FK)	CERAMIC DIP (JG)	TSSOP (PW)	CERAMIC FLAT PACK (U)
0°C to 70°C	2.5 mV	TLV2432CD	—	—	TLV2432CPW	—
–40°C to 85°C	950 μV 2.5 mV	TLV2432AID TLV2432ID	— —	— —	TLV2432AIPW —	— —
–40°C to 125°C	950 μV 2.5 mV	TLV2432AQD TLV2432QD	— —	— —	— —	— —
–55°C to 125°C	950 μV 2.5 mV	— —	TLV2432AMFK TLV2432MFK	TLV2432AMJG TLV2432MJG	— —	TLV2432AMU TLV2432MU

The D packages are available taped and reeled. Add R suffix to device type (e.g., TLV2432CDR). The PW package is available only left-end taped and reeled.

TLV2434 AVAILABLE OPTIONS

T _A	V _{IO} max AT 25°C	PACKAGED DEVICES	
		SMALL OUTLINE (D)	TSSOP (PW)
0°C to 70°C	2.5 mV	TLV2434CD	TLV2434CPW
–40°C to 125°C	950 μV 2.5 mV	TLV2434AID TLV2434ID	TLV2434AIPW TLV2434IPW

The D packages are available taped and reeled. Add R suffix to device type (e.g., TLV2434CDR). The PW package is available only left-end taped and reeled.

**TLV2432
D OR JG PACKAGE
(TOP VIEW)**

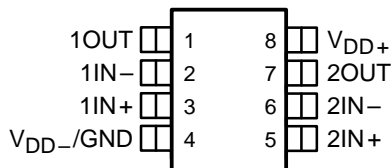

**TLV2432
PW PACKAGE
(TOP VIEW)**

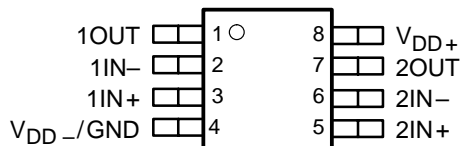

**TLV2432
FK PACKAGE
(TOP VIEW)**

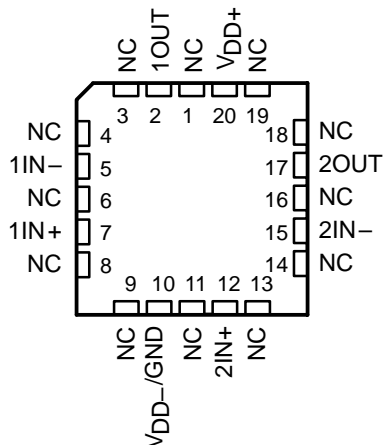

**TLV2432
U PACKAGE
(TOP VIEW)**

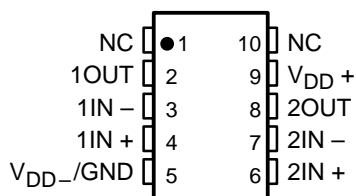

**TLV2434
D OR PW PACKAGE
(TOP VIEW)**

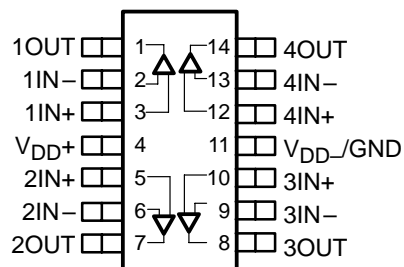

NC – No internal connection



TLV2432, TLV2432A, TLV2434, TLV2434A
 Advanced LINCOS™ RAIL-TO-RAIL OUTPUT
 WIDE-INPUT-VOLTAGE OPERATIONAL AMPLIFIERS
 SLOS168F – NOVEMBER 1996 – REVISED MARCH 2001

equivalent schematic (each amplifier)

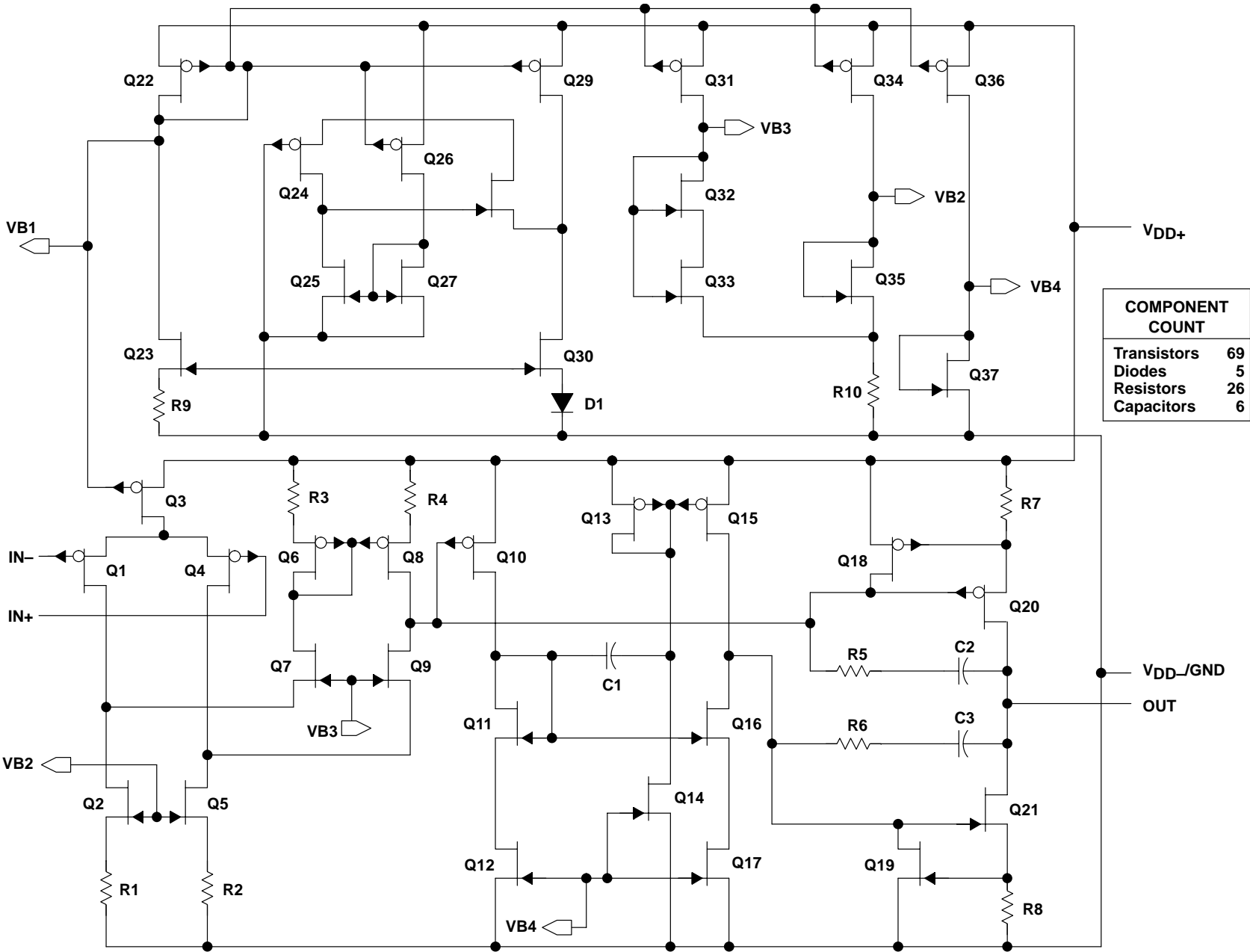

COMPONENT COUNT	
Transistors	69
Diodes	5
Resistors	26
Capacitors	6

TLV2432, TLV2432A, TLV2434, TLV2434A
Advanced LinCMOS™ RAIL-TO-RAIL OUTPUT
WIDE-INPUT-VOLTAGE OPERATIONAL AMPLIFIERS

SLOS168F – NOVEMBER 1996 – REVISED MARCH 2001

absolute maximum ratings over operating free-air temperature range (unless otherwise noted)†

Supply voltage, V_{DD} (see Note 1)	12 V
Differential input voltage, V_{ID} (see Note 2)	$\pm V_{DD}$
Input voltage, V_I (any input, see Note 1): C and I suffix	-0.3 V to V_{DD}
Input current, I_I (each input)	± 5 mA
Output current, I_O	± 50 mA
Total current into V_{DD+}	± 50 mA
Total current out of V_{DD-}	± 50 mA
Duration of short-circuit current at (or below) 25°C (see Note 3)	unlimited
Continuous total dissipation	See Dissipation Rating Table
Operating free-air temperature range, T_A : C suffix	0°C to 70°C
I suffix (dual)	-40°C to 85°C
I suffix (quad)	-40°C to 125°C
Q suffix	-40°C to 125°C
M suffix	-55°C to 125°C
Storage temperature range, T_{stg}	-65°C to 150°C
Lead temperature 1,6 mm (1/16 inch) from case for 10 seconds	260°C

† Stresses beyond those listed under “absolute maximum ratings” may cause permanent damage to the device. These are stress ratings only, and functional operation of the device at these or any other conditions beyond those indicated under “recommended operating conditions” is not implied. Exposure to absolute-maximum-rated conditions for extended periods may affect device reliability.

- NOTES: 1. All voltage values, except differential voltages, are with respect to the midpoint between V_{DD+} and V_{DD-} .
 2. Differential voltages are at $IN+$ with respect to $IN-$. Excessive current flows if input is brought below $V_{DD-} - 0.3$ V.
 3. The output may be shorted to either supply. Temperature and/or supply voltages must be limited to ensure that the maximum dissipation rating is not exceeded.

DISSIPATION RATING TABLE

PACKAGE	$T_A \leq 25^\circ\text{C}$ POWER RATING	DERATING FACTOR ABOVE $T_A = 25^\circ\text{C}$	$T_A = 70^\circ\text{C}$ POWER RATING	$T_A = 85^\circ\text{C}$ POWER RATING	$T_A = 125^\circ\text{C}$ POWER RATING
D (8)	725 mW	5.8 mW/°C	464 mW	377 mW	145 mW
D (14)	1022 mW	7.6 mW/°C	900 mW	777 mW	450 mW
FK	1375 mW	11.0 mW/°C	880 mW	715 mW	275 mW
JG	1050 mW	8.4 mW/°C	672 mW	546 mW	210 mW
PW (8)	525 mW	4.2 mW/°C	336 mW	273 mW	105 mW
PW (14)	720 mW	5.6 mW/°C	634 mW	547 mW	317 mW
U	675 mW	5.4 mW/°C	432 mW	350 mW	135 mW

recommended operating conditions

	C SUFFIX		I SUFFIX		Q SUFFIX		M SUFFIX		UNIT
	MIN	MAX	MIN	MAX	MIN	MAX	MIN	MAX	
Supply voltage, V_{DD}	2.7	10	2.7	10	2.7	10	2.7	10	V
Input voltage range, V_I	V_{DD-}	$V_{DD+} - 0.8$	V_{DD-}	$V_{DD+} - 0.8$	V_{DD-}	$V_{DD+} - 0.8$	V_{DD-}	$V_{DD+} - 0.8$	V
Common-mode input voltage, V_{IC}	V_{DD-}	$V_{DD+} - 1.3$	V_{DD-}	$V_{DD+} - 1.3$	V_{DD-}	$V_{DD+} - 1.3$	V_{DD-}	$V_{DD+} - 1.3$	V
Operating free-air temperature, T_A	0	70	-40	125	-40	125	-55	125	°C



TLV2432, TLV2432A, TLV2434, TLV2434A
Advanced LinCMOS™ RAIL-TO-RAIL OUTPUT
WIDE-INPUT-VOLTAGE OPERATIONAL AMPLIFIERS

SLOS168F – NOVEMBER 1996 – REVISED MARCH 2001

electrical characteristics at specified free-air temperature, $V_{DD} = 3\text{ V}$ (unless otherwise noted)

PARAMETER	TEST CONDITIONS		T_A^\dagger	TLV243x			UNIT
				MIN	TYP	MAX	
V_{IO} Input offset voltage	$V_{IC} = 0,$ $V_O = 0,$ $V_{DD} \pm \pm 1.5\text{ V},$ $R_S = 50\ \Omega$	TLV243xC, TLV243xI	25°C	300	2000	μV	
			Full range	2500			
		TLV243xAI	25°C	300	950		
			Full range	1500			
$\alpha_{V_{IO}}$ Temperature coefficient of input offset voltage	$V_{IC} = 0,$ $V_O = 0,$ $V_{DD} \pm \pm 1.5\text{ V},$ $R_S = 50\ \Omega$		25°C to 70°C	2		$\mu\text{V}/^\circ\text{C}$	
Input offset voltage long-term drift (see Note 4)			25°C	0.003		$\mu\text{V}/\text{mo}$	
I_{IO} Input offset current			25°C	0.5	60	pA	
			Full range	150			
I_{IB} Input bias current	25°C	1	60	pA			
	Full range	150					
V_{ICR} Common-mode input voltage range	$ V_{IO} \leq 5\text{ mV},$ $R_S = 50\ \Omega$		25°C	0 to 2.5	-0.25 to 2.75	V	
			Full range	0 to 2.2			
V_{OH} High-level output voltage	$I_{OH} = -100\ \mu\text{A}$		25°C	2.98		V	
			25°C	2.5			
			Full range	2.25			
V_{OL} Low-level output voltage	$V_{IC} = 1.5\text{ V},$ $I_{OL} = 100\ \mu\text{A}$		25°C	0.02		V	
			25°C	0.83			
	$V_{IC} = 1.5\text{ V},$ $I_{OL} = 3\text{ mA}$	Full range	1				
A_{VD} Large-signal differential voltage amplification	$V_{IC} = 2.5\text{ V},$ $V_O = 1\text{ V to }2\text{ V}$	$R_L = 2\text{ k}\Omega^\ddagger$	25°C	1.5	2.5	V/mV	
			Full range	1			
		$R_L = 1\text{ M}\Omega^\ddagger$	25°C	750			
$r_{i(d)}$ Differential input resistance			25°C	1000		$\text{G}\Omega$	
$r_{i(c)}$ Common-mode input resistance			25°C	1000		$\text{G}\Omega$	
$c_{i(c)}$ Common-mode input capacitance	$f = 10\text{ kHz}$		25°C	8		pF	
z_o Closed-loop output impedance	$f = 100\text{ kHz},$ $A_V = 10$		25°C	130		Ω	
CMRR Common-mode rejection ratio	$V_{IC} = 0\text{ to }2.5\text{ V},$ $V_O = 1.5\text{ V},$ $R_S = 50\ \Omega$		25°C	70	83	dB	
			Full range	70			
k_{SVR} Supply-voltage rejection ratio ($\Delta V_{DD}/\Delta V_{IO}$)	$V_{DD} = 2.7\text{ V to }8\text{ V},$ $V_{IC} = V_{DD}/2,$ No load		25°C	80	95	dB	
			Full range	80			
I_{DD} Supply current (per channel)	$V_O = 1.5\text{ V},$ No load		25°C	98	125	μA	
			Full range	125			

† Full range for the C suffix is 0°C to 70°C. Full range for the dual I suffix is -40°C to 85°C. Full range for the quad I suffix is -40°C to 125°C.

‡ Referenced to 2.5 V

NOTE 4: Typical values are based on the input offset voltage shift observed through 500 hours of operating life test at $T_A = 150^\circ\text{C}$ extrapolated to $T_A = 25^\circ\text{C}$ using the Arrhenius equation and assuming an activation energy of 0.96 eV.

TLV2432, TLV2432A, TLV2434, TLV2434A
Advanced LinCMOS™ RAIL-TO-RAIL OUTPUT
WIDE-INPUT-VOLTAGE OPERATIONAL AMPLIFIERS

SLOS168F – NOVEMBER 1996 – REVISED MARCH 2001

operating characteristics at specified free-air temperature, $V_{DD} = 3\text{ V}$

PARAMETER	TEST CONDITIONS	T_A †	TLV243x			UNIT
			MIN	TYP	MAX	
SR Slew rate at unity gain	$V_O = 1\text{ V to }2\text{ V}$, $C_L = 100\text{ pF}‡$	$R_L = 2\text{ k}\Omega‡$	25°C	0.15	0.25	V/ μs
			Full range	0.1		
V_n Equivalent input noise voltage	$f = 10\text{ Hz}$		25°C	120		nV/ $\sqrt{\text{Hz}}$
	$f = 1\text{ kHz}$		25°C	22		
$V_{N(PP)}$ Peak-to-peak equivalent input noise voltage	$f = 0.1\text{ Hz to }1\text{ Hz}$		25°C	2.7		μV
	$f = 0.1\text{ Hz to }10\text{ Hz}$		25°C	4		
I_n Equivalent input noise current			25°C	0.6		fA/ $\sqrt{\text{Hz}}$
THD + N Total harmonic distortion plus noise	$V_O = 0.5\text{ V to }2.5\text{ V}$, $f = 1\text{ kHz}$, $R_L = 2\text{ k}\Omega‡$	$A_V = 1$	25°C	0.065%		
		$A_V = 10$		0.5%		
Gain-bandwidth product	$f = 10\text{ kHz}$, $C_L = 100\text{ pF}‡$	$R_L = 2\text{ k}\Omega‡$	25°C	0.5		MHz
BOM Maximum output-swing bandwidth	$V_{O(PP)} = 1\text{ V}$, $R_L = 2\text{ k}\Omega‡$	$A_V = 1$, $C_L = 100\text{ pF}‡$	25°C	220		kHz
t_s Settling time	$A_V = -1$, Step = 0.5 V to 2.5 V, $R_L = 2\text{ k}\Omega‡$, $C_L = 100\text{ pF}‡$	To 0.1%	25°C	6.4		μs
		To 0.01%		14.1		
ϕ_m Phase margin at unity gain	$R_L = 2\text{ k}\Omega‡$	$C_L = 100\text{ pF}‡$	25°C	62°		
Gain margin			25°C	11		

† Full range for the C suffix is 0°C to 70°C. Full range for the dual I suffix is –40°C to 85°C. Full range for the quad I suffix is –40°C to 125°C.

‡ Referenced to 2.5 V



TLV2432, TLV2432A, TLV2434, TLV2434A
Advanced LinCMOS™ RAIL-TO-RAIL OUTPUT
WIDE-INPUT-VOLTAGE OPERATIONAL AMPLIFIERS

SLOS168F – NOVEMBER 1996 – REVISED MARCH 2001

electrical characteristics at specified free-air temperature, $V_{DD} = 3\text{ V}$ (unless otherwise noted)

PARAMETER	TEST CONDITIONS		T_A †	TLV243xQ, TLV243xM			UNIT
				MIN	TYP	MAX	
V_{IO} Input offset voltage	$V_{IC} = 0,$ $V_O = 0,$ $V_{DD} \pm \pm 1.5\text{ V},$ $R_S = 50\ \Omega$	TLV243xQ, TLV243xM	25°C	300	2000	μV	
			Full range	2500			
		TLV243xAQ, TLV243xAM	25°C	300	950		
			Full range	2000			
$\alpha_{V_{IO}}$ Temperature coefficient of input offset voltage	$V_{IC} = 0,$ $V_O = 0,$ $V_{DD} \pm \pm 1.5\text{ V},$ $R_S = 50\ \Omega$		25°C to 70°C	2		$\mu\text{V}/^\circ\text{C}$	
Input offset voltage long-term drift (see Note 4)			25°C	0.003		$\mu\text{V}/\text{mo}$	
I_{IO} Input offset current			25°C	0.5	60	pA	
			Full range	150			
I_{IB} Input bias current			25°C	1	60	pA	
			Full range	300			
V_{ICR} Common-mode input voltage range	$ V_{IO} \leq 5\text{ mV},$ $R_S = 50\ \Omega$		25°C	0 to 2.5	-0.25 to 2.75	V	
			Full range	0 to 2.2			
V_{OH} High-level output voltage	$I_{OH} = -100\ \mu\text{A}$		25°C	2.98		V	
			25°C	2.5			
			Full range	2.25			
V_{OL} Low-level output voltage	$V_{IC} = 1.5\text{ V},$ $I_{OL} = 100\ \mu\text{A}$		25°C	0.02		V	
			25°C	0.83			
	$V_{IC} = 1.5\text{ V},$ $I_{OL} = 3\text{ mA}$	Full range	1				
A_{VD} Large-signal differential voltage amplification	$V_{IC} = 2.5\text{ V},$ $V_O = 1\text{ V to }2\text{ V}$	$R_L = 2\text{ k}\Omega^\ddagger$	25°C	1.5	2.5	V/mV	
			Full range	0.5			
		$R_L = 1\text{ M}\Omega^\ddagger$	25°C	750			
$r_{i(d)}$ Differential input resistance			25°C	1000		$\text{G}\Omega$	
$r_{i(c)}$ Common-mode input resistance			25°C	1000		$\text{G}\Omega$	
$c_{i(c)}$ Common-mode input capacitance	$f = 10\text{ kHz}$		25°C	8		pF	
z_o Closed-loop output impedance	$f = 100\text{ kHz},$ $A_V = 10$		25°C	130		Ω	
CMRR Common-mode rejection ratio	$V_{IC} = 0\text{ to }2.5\text{ V},$ $V_O = 1.5\text{ V},$ $R_S = 50\ \Omega$		25°C	70	83	dB	
			Full range	70			
k_{SVR} Supply-voltage rejection ratio ($\Delta V_{DD}/\Delta V_{IO}$)	$V_{DD} = 2.7\text{ V to }8\text{ V},$ $V_{IC} = V_{DD}/2,$ No load		25°C	80	95	dB	
			Full range	80			
I_{DD} Supply current	$V_O = 1.5\text{ V},$ No load		25°C	195	250	μA	
			Full range	260			

† Full range is -40°C to 125°C for Q level part, -55°C to 125°C for M level part.

‡ Referenced to 2.5 V

NOTE 4: Typical values are based on the input offset voltage shift observed through 500 hours of operating life test at $T_A = 150^\circ\text{C}$ extrapolated to $T_A = 25^\circ\text{C}$ using the Arrhenius equation and assuming an activation energy of 0.96 eV.

TLV2432, TLV2432A, TLV2434, TLV2434A
Advanced LinCMOS™ RAIL-TO-RAIL OUTPUT
WIDE-INPUT-VOLTAGE OPERATIONAL AMPLIFIERS

SLOS168F – NOVEMBER 1996 – REVISED MARCH 2001

operating characteristics at specified free-air temperature, $V_{DD} = 3\text{ V}$

PARAMETER	TEST CONDITIONS	T_A †	TLV243xQ, TLV243xM, TLV243xAQ, TLV243xAM			UNIT
			MIN	TYP	MAX	
SR Slew rate at unity gain	$V_O = 1\text{ V to }2\text{ V},$ $C_L = 100\text{ pF}‡$ $R_L = 2\text{ k}\Omega‡$	25°C	0.15	0.25		V/ μs
		Full range	0.1			
V_n Equivalent input noise voltage	$f = 10\text{ Hz}$	25°C	120		nV/ $\sqrt{\text{Hz}}$	
	$f = 1\text{ kHz}$	25°C	22			
$V_{N(PP)}$ Peak-to-peak equivalent input noise voltage	$f = 0.1\text{ Hz to }1\text{ Hz}$	25°C	2.7		μV	
	$f = 0.1\text{ Hz to }10\text{ Hz}$	25°C	4			
I_n Equivalent input noise current		25°C	0.6		fA/ $\sqrt{\text{Hz}}$	
THD + N Total harmonic distortion plus noise	$V_O = 0.5\text{ V to }2.5\text{ V},$ $f = 1\text{ kHz},$ $R_L = 2\text{ k}\Omega‡$	25°C	$A_V = 1$	0.065%		
			$A_V = 10$	0.5%		
Gain-bandwidth product	$f = 10\text{ kHz},$ $C_L = 100\text{ pF}‡$ $R_L = 2\text{ k}\Omega‡$	25°C	0.5		MHz	
BOM Maximum output-swing bandwidth	$V_{O(PP)} = 1\text{ V},$ $R_L = 2\text{ k}\Omega‡$ $A_V = 1,$ $C_L = 100\text{ pF}‡$	25°C	220		kHz	
t_s Settling time	$A_V = -1,$ Step = 0.5 V to 2.5 V, $R_L = 2\text{ k}\Omega‡$ $C_L = 100\text{ pF}‡$	25°C	To 0.1%	6.4		μs
			To 0.01%	14.1		
ϕ_m Phase margin at unity gain	$R_L = 2\text{ k}\Omega‡$ $C_L = 100\text{ pF}‡$	25°C	62°			
Gain margin		25°C	11		dB	

† Full range is -40°C to 125°C for Q level part, -55°C to 125°C for M level part.

‡ Referenced to 2.5 V



TLV2432, TLV2432A, TLV2434, TLV2434A
Advanced LinCMOS™ RAIL-TO-RAIL OUTPUT
WIDE-INPUT-VOLTAGE OPERATIONAL AMPLIFIERS

SLOS168F – NOVEMBER 1996 – REVISED MARCH 2001

electrical characteristics at specified free-air temperature, $V_{DD} = 5\text{ V}$ (unless otherwise noted)

PARAMETER	TEST CONDITIONS		T_A^\dagger	TLV243x			UNIT
				MIN	TYP	MAX	
V_{IO} Input offset voltage	$V_{IC} = 0,$ $V_O = 0,$ $V_{DD} \pm \pm 2.5\text{ V},$ $R_S = 50\ \Omega$	TLV243x	25°C	300	2000	μV	
			Full range	2500			
		TLV243xA	25°C	300	950		
			Full range	1500			
$\alpha_{V_{IO}}$ Temperature coefficient of input offset voltage	$V_{IC} = 0,$ $V_O = 0,$ $V_{DD} \pm \pm 2.5\text{ V},$ $R_S = 50\ \Omega$		25°C to 70°C	2		$\mu\text{V}/^\circ\text{C}$	
Input offset voltage long-term drift (see Note 4)			25°C	0.003		$\mu\text{V}/\text{mo}$	
I_{IO} Input offset current			25°C	0.5	60	pA	
			Full range	150			
I_{IB} Input bias current			25°C	1	60	pA	
			Full range	150			
V_{ICR} Common-mode input voltage range	$ V_{IO} \leq 5\text{ mV},$ $R_S = 50\ \Omega$		25°C	0 to 4.5	-0.25 to 4.75	V	
			Full range	0 to 4.2			
V_{OH} High-level output voltage	$I_{OH} = -100\ \mu\text{A}$		25°C	4.97		V	
			25°C	$I_{OH} = -5\text{ mA}$	4		4.35
					Full range		4
V_{OL} Low-level output voltage	$V_{IC} = 2.5\text{ V},$ $I_{OL} = 100\ \mu\text{A}$		25°C	0.01		V	
			25°C	0.8			
	$V_{IC} = 2.5\text{ V},$ $I_{OL} = 5\text{ mA}$	Full range	1.25				
A_{VD} Large-signal differential voltage amplification	$V_{IC} = 2.5\text{ V},$ $V_O = 1\text{ V to }4\text{ V}$	$R_L = 2\text{ k}\Omega^\ddagger$	25°C	2.5	3.8	V/mV	
			Full range	1.5			
		$R_L = 1\text{ M}\Omega^\ddagger$	25°C	950			
$r_{i(d)}$ Differential input resistance			25°C	1000		$\text{G}\Omega$	
$r_{i(c)}$ Common-mode input resistance			25°C	1000		$\text{G}\Omega$	
$c_{i(c)}$ Common-mode input capacitance	$f = 10\text{ kHz}$		25°C	8		pF	
z_o Closed-loop output impedance	$f = 100\text{ kHz},$ $A_V = 10$		25°C	130		Ω	
CMRR Common-mode rejection ratio	$V_{IC} = 0\text{ to }4.5\text{ V},$ $V_O = 2.5\text{ V},$ $R_S = 50\ \Omega$		25°C	70	90	dB	
			Full range	70			
k_{SVR} Supply-voltage rejection ratio ($\Delta V_{DD}/\Delta V_{IO}$)	$V_{DD} = 4.4\text{ V to }8\text{ V},$ $V_{IC} = V_{DD}/2,$ No load		25°C	80	95	dB	
			Full range	80			
I_{DD} Supply current (per channel)	$V_O = 2.5\text{ V},$ No load		25°C	100	125	μA	
			Full range	125			

† Full range for the C suffix is 0°C to 70°C. Full range for the dual I suffix is -40°C to 85°C. Full range for the quad I suffix is -40°C to 125°C.

‡ Referenced to 2.5 V

NOTE 4: Typical values are based on the input offset voltage shift observed through 500 hours of operating life test at $T_A = 150^\circ\text{C}$ extrapolated to $T_A = 25^\circ\text{C}$ using the Arrhenius equation and assuming an activation energy of 0.96 eV.

TLV2432, TLV2432A, TLV2434, TLV2434A
Advanced LinCMOS™ RAIL-TO-RAIL OUTPUT
WIDE-INPUT-VOLTAGE OPERATIONAL AMPLIFIERS

SLOS168F – NOVEMBER 1996 – REVISED MARCH 2001

operating characteristics at specified free-air temperature, $V_{DD} = 5\text{ V}$

PARAMETER	TEST CONDITIONS	T_A †	TLV243x			UNIT
			MIN	TYP	MAX	
SR Slew rate at unity gain	$V_O = 1.5\text{ V to }3.5\text{ V}, R_L = 2\text{ k}\Omega\ddagger, C_L = 100\text{ pF}\ddagger$	25°C	0.15	0.25		V/ μs
		Full range	0.1			
V_n Equivalent input noise voltage	$f = 10\text{ Hz}$	25°C	100		nV/ $\sqrt{\text{Hz}}$	
	$f = 1\text{ kHz}$	25°C	18			
$V_{N(PP)}$ Peak-to-peak equivalent input noise voltage	$f = 0.1\text{ Hz to }1\text{ Hz}$	25°C	1.9		μV	
	$f = 0.1\text{ Hz to }10\text{ Hz}$	25°C	2.8			
I_n Equivalent input noise current		25°C	0.6		fA/ $\sqrt{\text{Hz}}$	
THD + N Total harmonic distortion plus noise	$V_O = 1.5\text{ V to }3.5\text{ V}, f = 1\text{ kHz}, R_L = 2\text{ k}\Omega\ddagger$	25°C	$A_V = 1$	0.045%		
			$A_V = 10$	0.4%		
Gain-bandwidth product	$f = 10\text{ kHz}, R_L = 2\text{ k}\Omega\ddagger, C_L = 100\text{ pF}\ddagger$	25°C	0.55		MHz	
BOM Maximum output-swing bandwidth	$V_{O(PP)} = 2\text{ V}, R_L = 2\text{ k}\Omega\ddagger, A_V = 1, C_L = 100\text{ pF}\ddagger$	25°C	100		kHz	
t_s Settling time	$A_V = -1, \text{ Step} = 1.5\text{ V to }3.5\text{ V}, R_L = 2\text{ k}\Omega\ddagger, C_L = 100\text{ pF}\ddagger$	25°C	$T_o = 0.1\%$	6.4		μs
			$T_o = 0.01\%$	13.1		
ϕ_m Phase margin at unity gain	$R_L = 2\text{ k}\Omega\ddagger, C_L = 100\text{ pF}\ddagger$	25°C	66°			
Gain margin		25°C	11		dB	

† Full range for the C suffix is 0°C to 70°C. Full range for the dual I suffix is –40°C to 85°C. Full range for the quad I suffix is –40°C to 125°C.

‡ Referenced to 2.5 V



TLV2432, TLV2432A, TLV2434, TLV2434A
Advanced LinCMOS™ RAIL-TO-RAIL OUTPUT
WIDE-INPUT-VOLTAGE OPERATIONAL AMPLIFIERS

SLOS168F – NOVEMBER 1996 – REVISED MARCH 2001

electrical characteristics at specified free-air temperature, $V_{DD} = 5\text{ V}$ (unless otherwise noted)

PARAMETER	TEST CONDITIONS		T_A †	TLV243xQ, TLV243xM			UNIT
				MIN	TYP	MAX	
V_{IO} Input offset voltage	$V_{IC} = 0,$ $V_O = 0,$ $V_{DD} \pm = \pm 2.5\text{ V},$ $R_S = 50\ \Omega$	TLV2453x	25°C	300	2000	μV	
			Full range	2500			
		TLV2453xA	25°C	300	950		
			Full range	2000			
$\alpha_{V_{IO}}$ Temperature coefficient of input offset voltage			25°C to 70°C	2		$\mu\text{V}/^\circ\text{C}$	
Input offset voltage long-term drift (see Note 4)			25°C	0.003		$\mu\text{V}/\text{mo}$	
I_{IO} Input offset current	$V_{IC} = 0,$ $V_O = 0,$ $V_{DD} \pm = \pm 2.5\text{ V},$ $R_S = 50\ \Omega$		25°C	0.5	60	pA	
			Full range	150			
I_{IB} Input bias current			25°C	1	60	pA	
			Full range	300			
V_{ICR} Common-mode input voltage range	$ V_{IO} \leq 5\text{ mV},$ $R_S = 50\ \Omega$		25°C	0 to 4.5	-0.25 to 4.75	V	
			Full range	0 to 4.2			
V_{OH} High-level output voltage	$I_{OH} = -100\ \mu\text{A}$		25°C	4.97		V	
			25°C	4	4.35		
			Full range	4			
V_{OL} Low-level output voltage	$V_{IC} = 2.5\text{ V},$ $I_{OL} = 100\ \mu\text{A}$		25°C	0.01		V	
			25°C	0.8			
	$V_{IC} = 2.5\text{ V},$ $I_{OL} = 5\text{ mA}$		Full range	1.25			
A_{VD} Large-signal differential voltage amplification	$V_{IC} = 2.5\text{ V},$ $V_O = 1\text{ V to }4\text{ V}$	$R_L = 2\text{ k}\Omega^\ddagger$	25°C	2.5	3.8	V/mV	
			Full range	0.5			
		$R_L = 1\text{ M}\Omega^\ddagger$	25°C	950			
$r_{i(d)}$ Differential input resistance			25°C	1000		$\text{G}\Omega$	
$r_{i(c)}$ Common-mode input resistance			25°C	1000		$\text{G}\Omega$	
$c_{i(c)}$ Common-mode input capacitance	$f = 10\text{ kHz}$		25°C	8		pF	
z_o Closed-loop output impedance	$f = 100\text{ kHz},$ $A_V = 10$		25°C	130		Ω	
CMRR Common-mode rejection ratio	$V_{IC} = 0\text{ to }4.5\text{ V},$ $V_O = 2.5\text{ V},$ $R_S = 50\ \Omega$		25°C	70	90	dB	
			Full range	70			
k_{SVR} Supply-voltage rejection ratio ($\Delta V_{DD}/\Delta V_{IO}$)	$V_{DD} = 4.4\text{ V to }8\text{ V},$ $V_{IC} = V_{DD}/2,$ No load		25°C	80	95	dB	
			Full range	80			
I_{DD} Supply current	$V_O = 2.5\text{ V},$ No load		25°C	200	250	μA	
			Full range	270			

† Full range is -40°C to 125°C for Q level part, -55°C to 125°C for M level part.

‡ Referenced to 2.5 V

NOTE 4: Typical values are based on the input offset voltage shift observed through 500 hours of operating life test at $T_A = 150^\circ\text{C}$ extrapolated to $T_A = 25^\circ\text{C}$ using the Arrhenius equation and assuming an activation energy of 0.96 eV.

TLV2432, TLV2432A, TLV2434, TLV2434A
Advanced LinCMOS™ RAIL-TO-RAIL OUTPUT
WIDE-INPUT-VOLTAGE OPERATIONAL AMPLIFIERS

SLOS168F – NOVEMBER 1996 – REVISED MARCH 2001

operating characteristics at specified free-air temperature, $V_{DD} = 5\text{ V}$

PARAMETER	TEST CONDITIONS	T_A †	TLV243xQ, TLV243xM, TLV243xAQ, TLV243xAM			UNIT
			MIN	TYP	MAX	
SR Slew rate at unity gain	$V_O = 1.5\text{ V to }3.5\text{ V}, R_L = 2\text{ k}\Omega\ddagger, C_L = 100\text{ pF}\ddagger$	25°C	0.15	0.25		V/ μs
		Full range	0.1			
V_n Equivalent input noise voltage	$f = 10\text{ Hz}$	25°C	100		nV/ $\sqrt{\text{Hz}}$	
	$f = 1\text{ kHz}$	25°C	18			
$V_{N(PP)}$ Peak-to-peak equivalent input noise voltage	$f = 0.1\text{ Hz to }1\text{ Hz}$	25°C	1.9		μV	
	$f = 0.1\text{ Hz to }10\text{ Hz}$	25°C	2.8			
I_n Equivalent input noise current		25°C	0.6		fA/ $\sqrt{\text{Hz}}$	
THD + N Total harmonic distortion plus noise	$V_O = 1.5\text{ V to }3.5\text{ V}, f = 1\text{ kHz}, R_L = 2\text{ k}\Omega\ddagger$	$A_V = 1$	0.045%			
		$A_V = 10$	0.4%			
Gain-bandwidth product	$f = 10\text{ kHz}, C_L = 100\text{ pF}\ddagger, R_L = 2\text{ k}\Omega\ddagger$	25°C	0.55		MHz	
BOM Maximum output-swing bandwidth	$V_{O(PP)} = 2\text{ V}, R_L = 2\text{ k}\Omega\ddagger, A_V = 1, C_L = 100\text{ pF}\ddagger$	25°C	100		kHz	
t_s Settling time	$A_V = -1, \text{ Step} = 1.5\text{ V to }3.5\text{ V}, R_L = 2\text{ k}\Omega\ddagger, C_L = 100\text{ pF}\ddagger$	To 0.1%	6.4		μs	
		To 0.01%	13.1			
ϕ_m Phase margin at unity gain	$R_L = 2\text{ k}\Omega\ddagger, C_L = 100\text{ pF}\ddagger$	25°C	66°			
Gain margin		25°C	11		dB	

† Full range is -40°C to 125°C for Q level part, -55°C to 125°C for M level part.

‡ Referenced to 2.5 V



TLV2432, TLV2432A, TLV2434, TLV2434A
Advanced LinCMOS™ RAIL-TO-RAIL OUTPUT
WIDE-INPUT-VOLTAGE OPERATIONAL AMPLIFIERS

SLOS168F – NOVEMBER 1996 – REVISED MARCH 2001

TYPICAL CHARACTERISTICS

Table of Graphs

			FIGURE
V_{IO}	Input offset voltage	Distribution vs Common-mode input voltage	2,3 4,5
α_{VIO}	Temperature coefficient	Distribution	6,7
I_{IB}/I_{IO}	Input bias and input offset currents	vs Free-air temperature	8
V_{OH}	High-level output voltage	vs High-level output current	9,11
V_{OL}	Low-level output voltage	vs Low-level output current	10,12
$V_{O(PP)}$	Maximum peak-to-peak output voltage	vs Frequency	13
I_{OS}	Short-circuit output current	vs Supply voltage vs Free-air temperature	14 15
V_{ID}	Differential input voltage	vs Output voltage	16,17
	Differential gain	vs Load resistance	18
A_{VD}	Large-signal differential voltage amplification	vs Frequency	19,20
A_{VD}	Differential voltage amplification	vs Free-air temperature	21,22
z_o	Output impedance	vs Frequency	23,24
$CMRR$	Common-mode rejection ratio	vs Frequency vs Free-air temperature	25 26
k_{SVR}	Supply-voltage rejection ratio	vs Frequency vs Free-air temperature	27,28 29
I_{DD}	Supply current	vs Supply voltage	30
SR	Slew rate	vs Load capacitance vs Free-air temperature	31 32
V_O	Inverting large-signal pulse response		33,34
V_O	Voltage-follower large-signal pulse response		35,36
V_O	Inverting small-signal pulse response		37,38
V_O	Voltage-follower small-signal pulse response		39,40
V_n	Equivalent input noise voltage	vs Frequency	41, 42
	Noise voltage (referred to input)	Over a 10-second period	43
$THD + N$	Total harmonic distortion plus noise	vs Frequency	44,45
	Gain-bandwidth product	vs Free-air temperature vs Supply voltage	46 47
ϕ_m	Phase margin	vs Frequency vs Load capacitance	19,20 48
	Gain margin	vs Load capacitance	49
B_1	Unity-gain bandwidth	vs Load capacitance	50

TLV2432, TLV2432A, TLV2434, TLV2434A
Advanced LinCMOS™ RAIL-TO-RAIL OUTPUT
WIDE-INPUT-VOLTAGE OPERATIONAL AMPLIFIERS

SLOS168F – NOVEMBER 1996 – REVISED MARCH 2001

TYPICAL CHARACTERISTICS

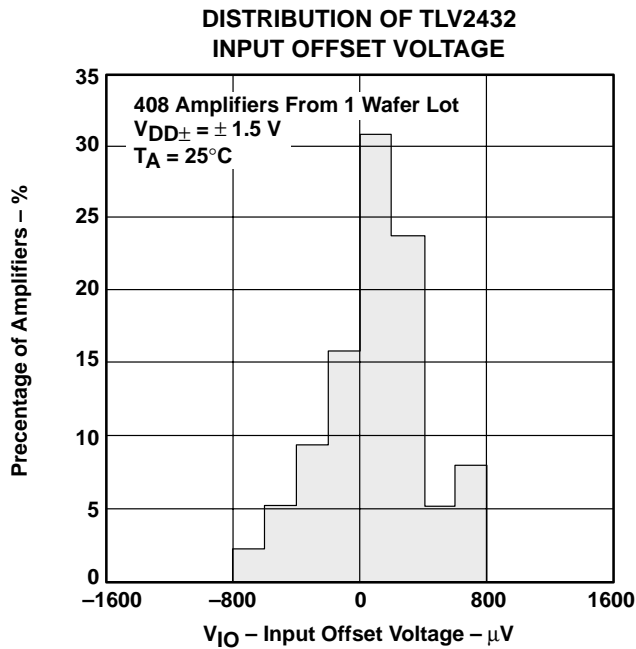

Figure 2

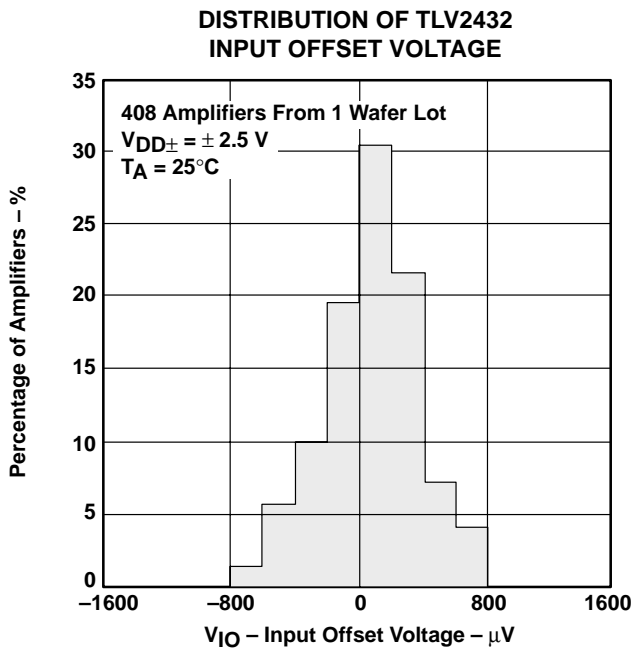

Figure 3

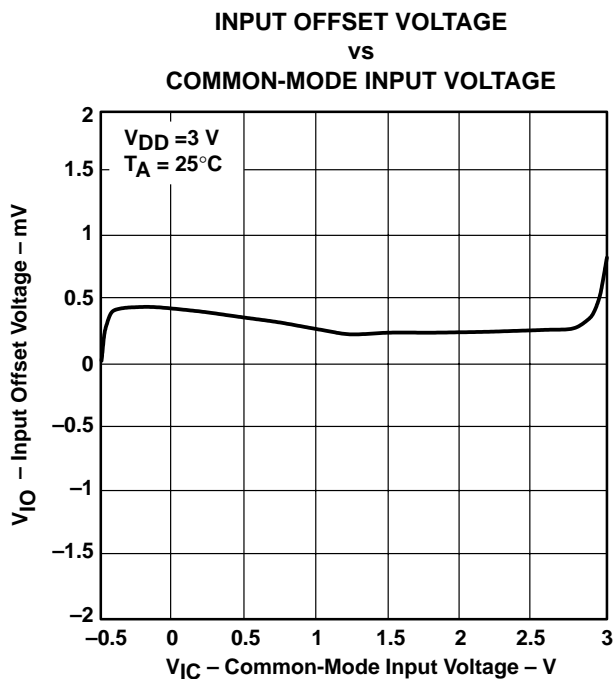

Figure 4

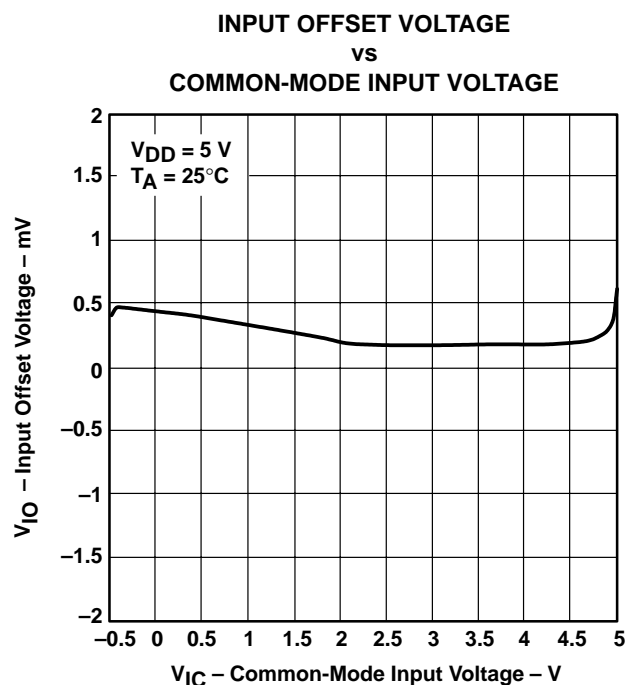

Figure 5



TYPICAL CHARACTERISTICS

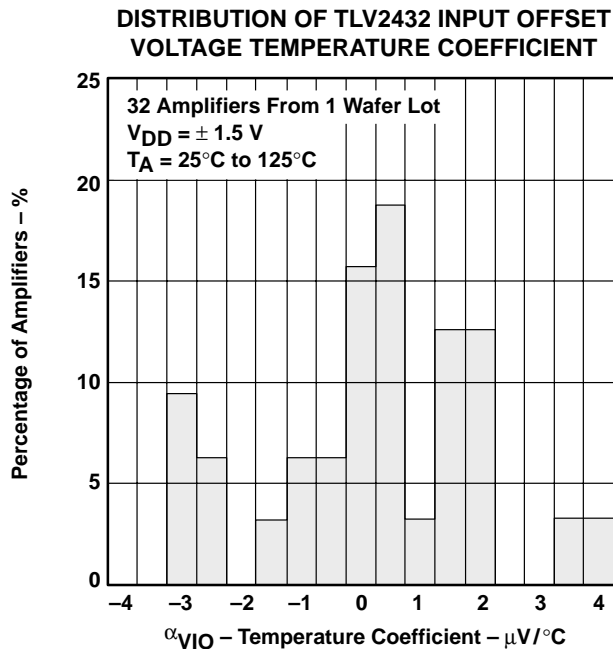

Figure 6

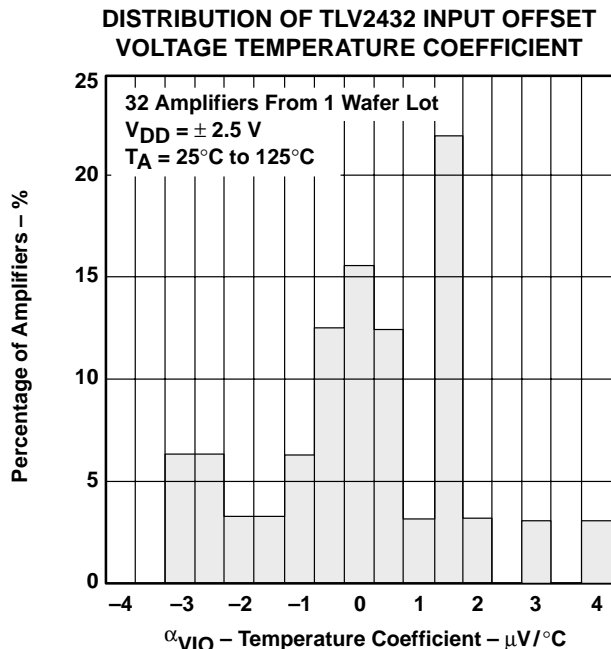

Figure 7



Figure 8

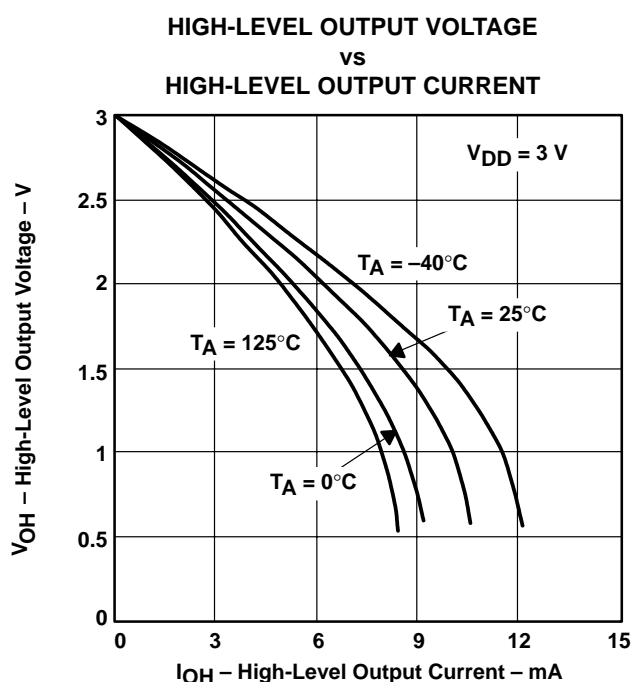

Figure 9

TLV2432, TLV2432A, TLV2434, TLV2434A
Advanced LinCMOS™ RAIL-TO-RAIL OUTPUT
WIDE-INPUT-VOLTAGE OPERATIONAL AMPLIFIERS

SLOS168F – NOVEMBER 1996 – REVISED MARCH 2001

TYPICAL CHARACTERISTICS

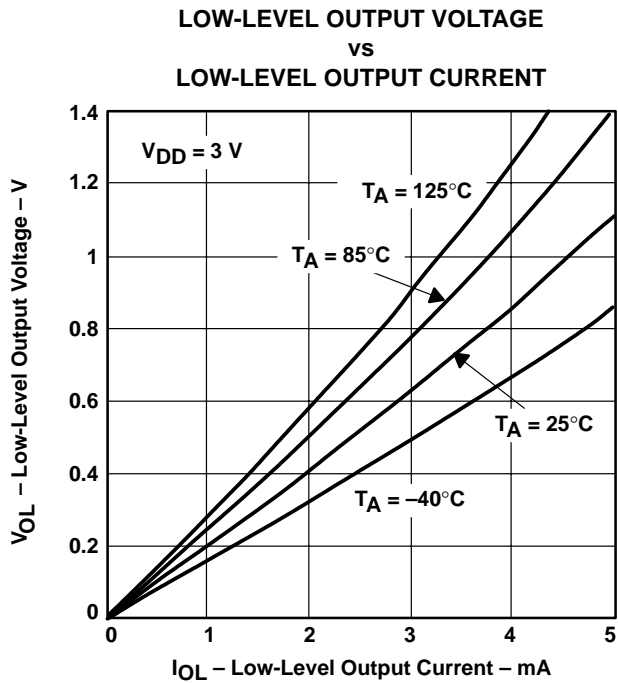

Figure 10

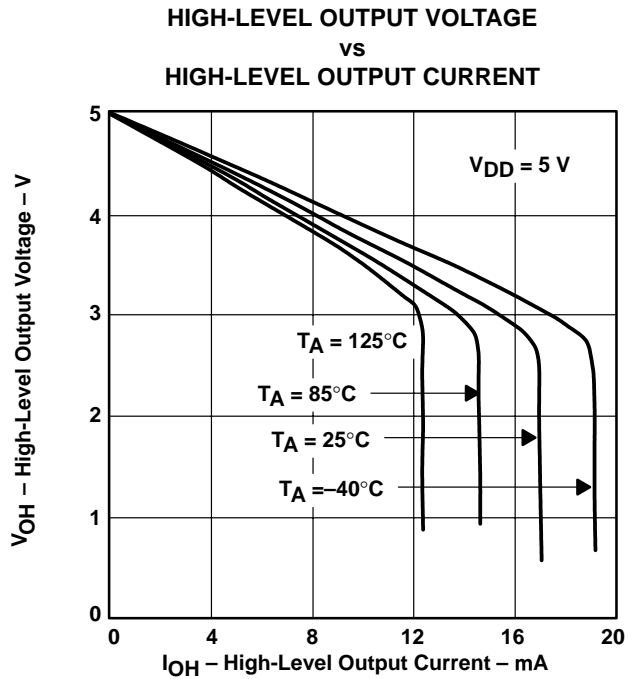

Figure 11

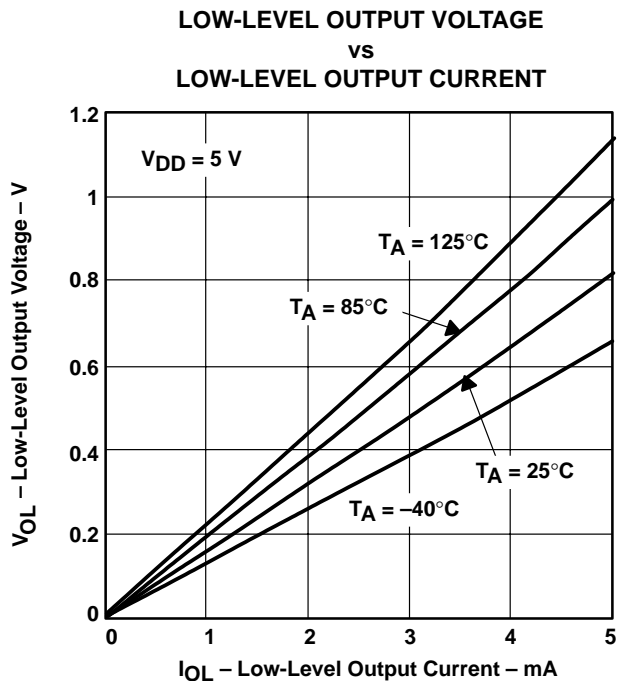

Figure 12

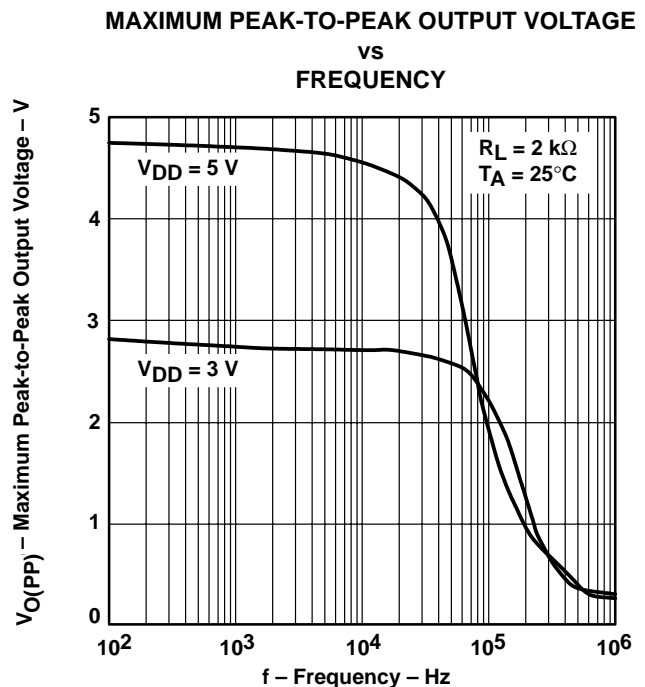

Figure 13



TYPICAL CHARACTERISTICS

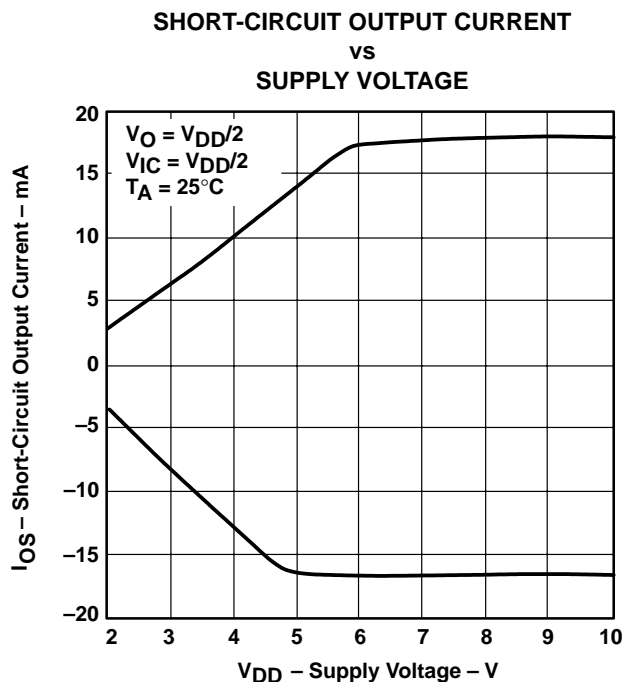

Figure 14

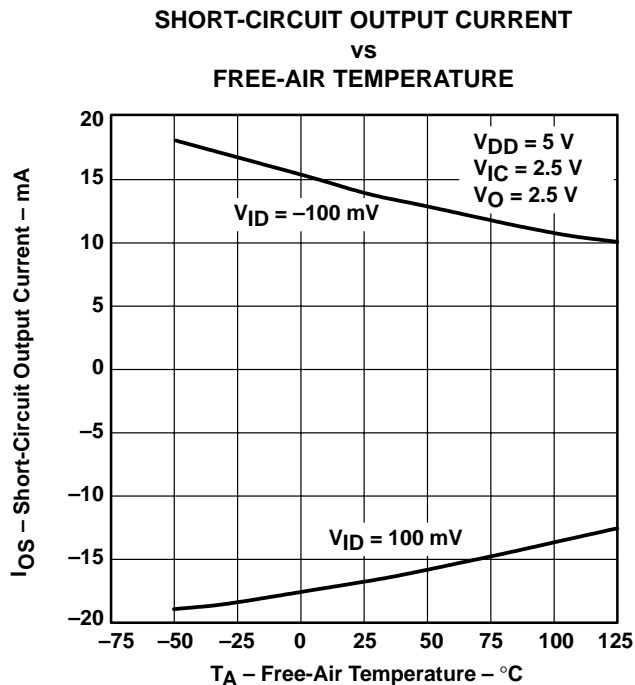

Figure 15

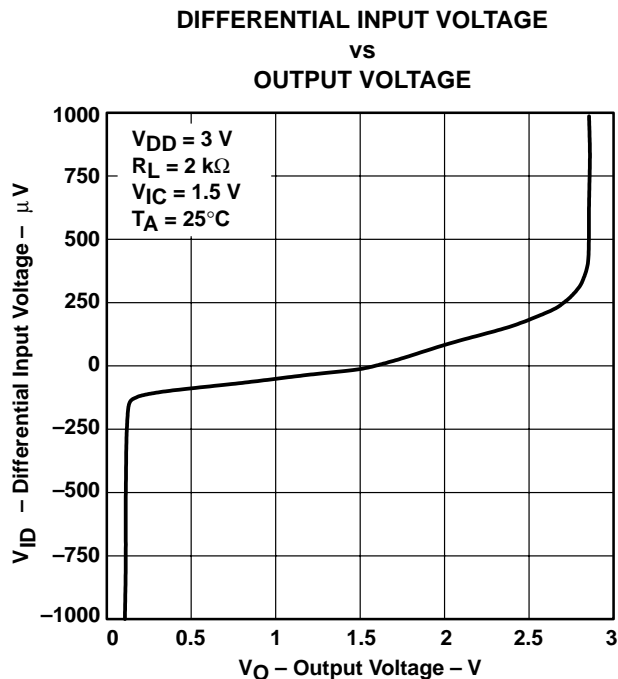

Figure 16

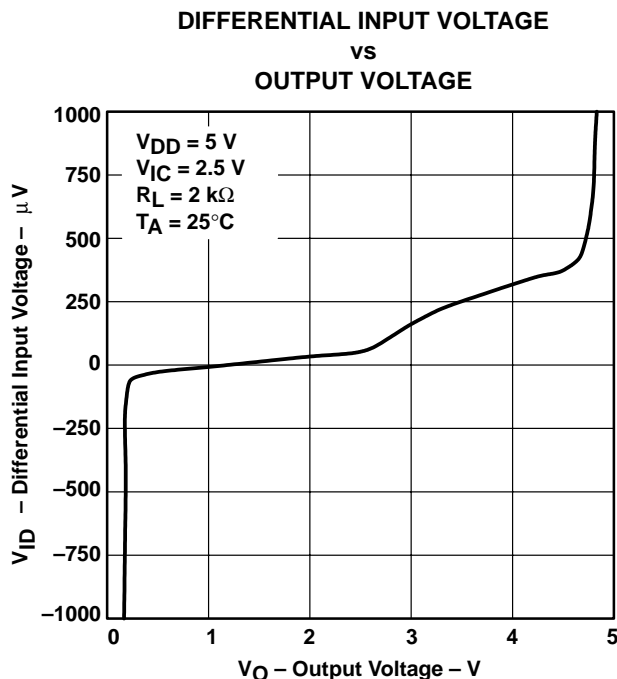

Figure 17

TYPICAL CHARACTERISTICS

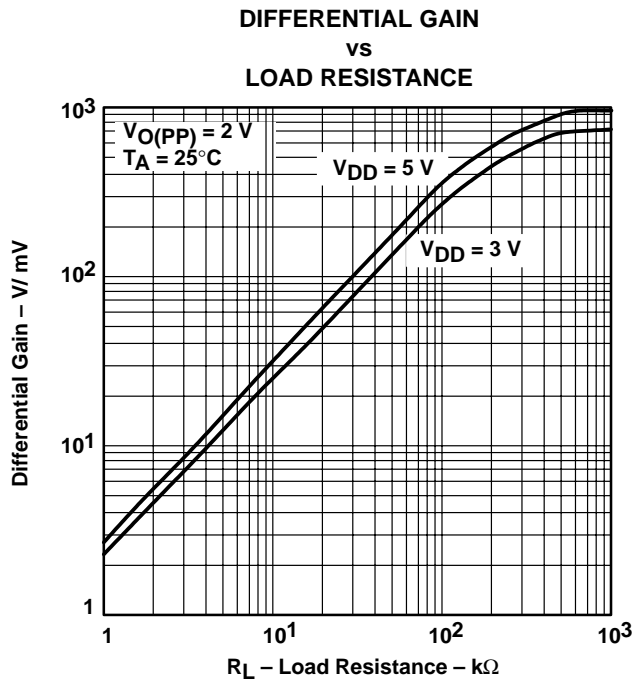

Figure 18

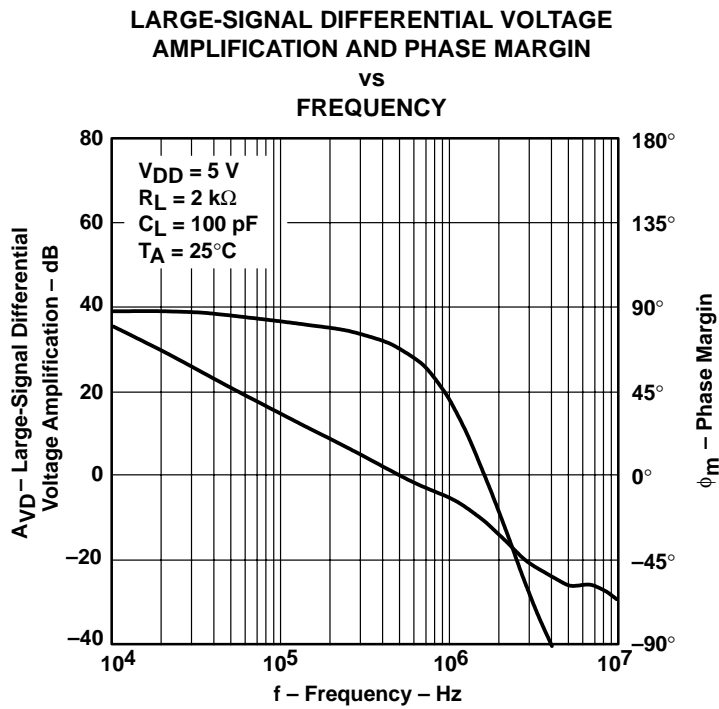

Figure 19

TYPICAL CHARACTERISTICS

LARGE-SIGNAL DIFFERENTIAL VOLTAGE
 AMPLIFICATION AND PHASE MARGIN

vs
 FREQUENCY

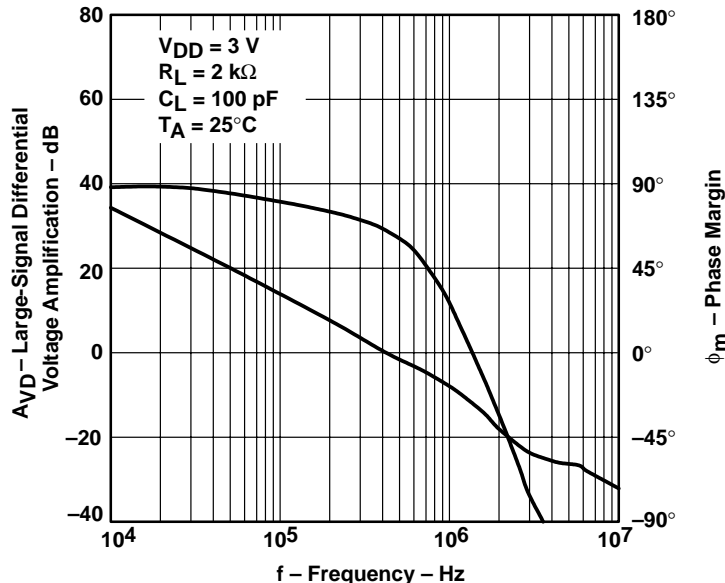

Figure 20

DIFFERENTIAL VOLTAGE AMPLIFICATION
 vs
 FREE-AIR TEMPERATURE

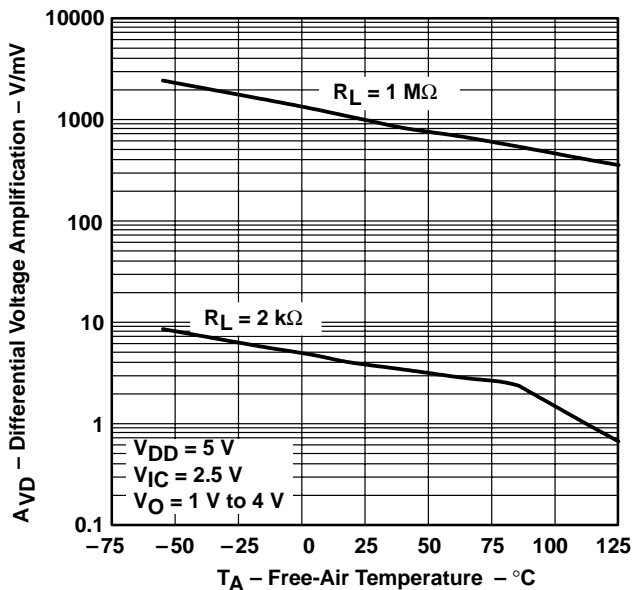

Figure 21

DIFFERENTIAL VOLTAGE AMPLIFICATION
 vs
 FREE-AIR TEMPERATURE

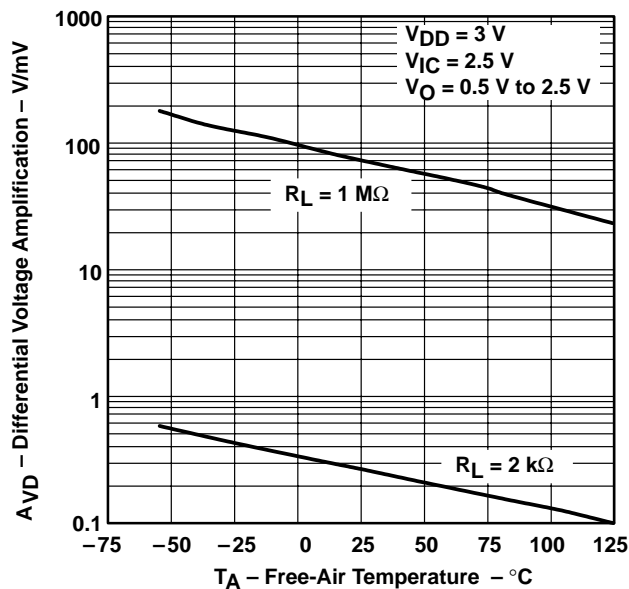

Figure 22

TLV2432, TLV2432A, TLV2434, TLV2434A
Advanced LinCMOS™ RAIL-TO-RAIL OUTPUT
WIDE-INPUT-VOLTAGE OPERATIONAL AMPLIFIERS

SLOS168F – NOVEMBER 1996 – REVISED MARCH 2001

TYPICAL CHARACTERISTICS

**OUTPUT IMPEDANCE
VS
FREQUENCY**

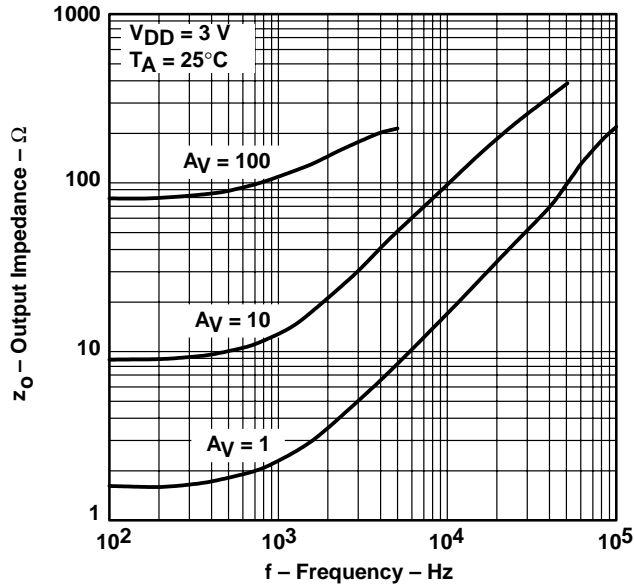

Figure 23

**OUTPUT IMPEDANCE
VS
FREQUENCY**

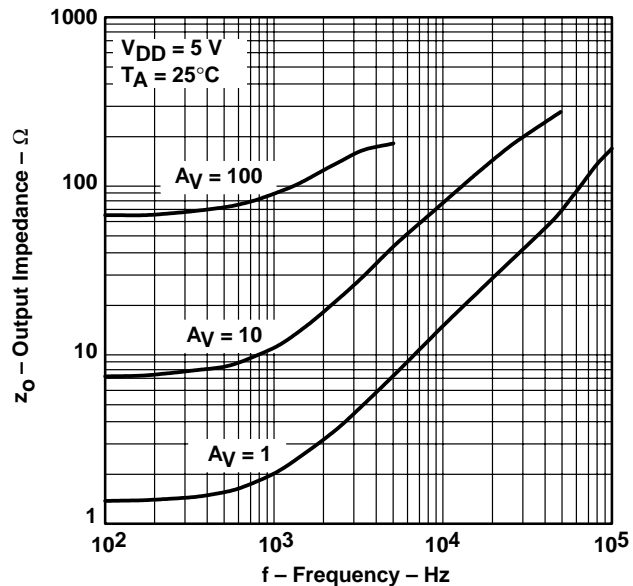

Figure 24

**COMMON-MODE REJECTION RATIO
VS
FREQUENCY**

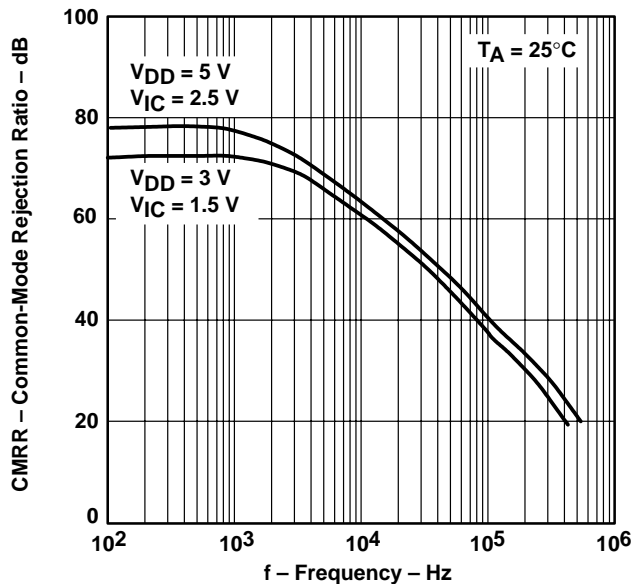

Figure 25

**COMMON-MODE REJECTION RATIO
VS
FREE-AIR TEMPERATURE**

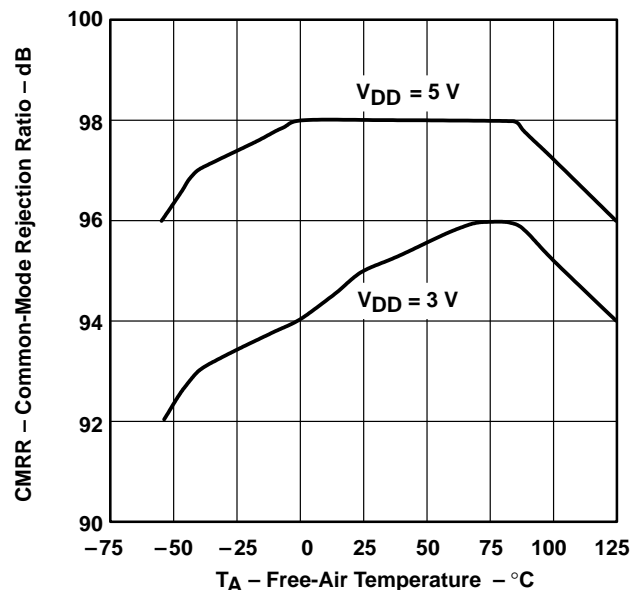

Figure 26



TYPICAL CHARACTERISTICS

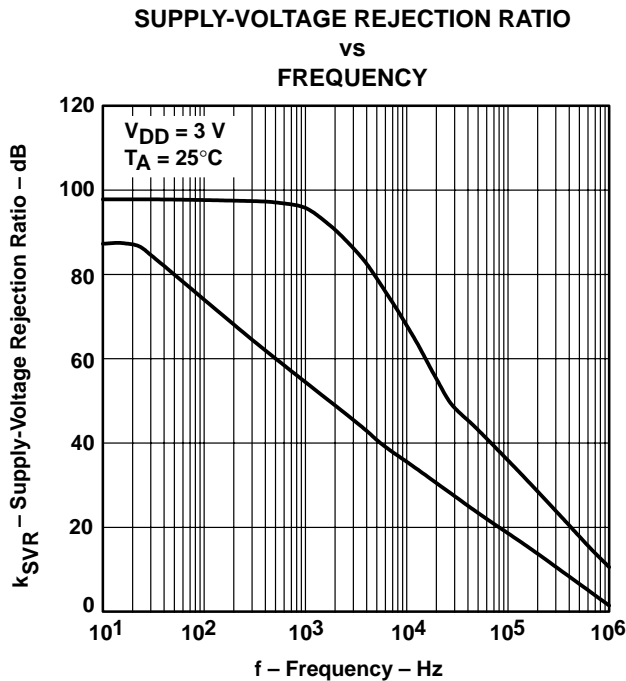

Figure 27

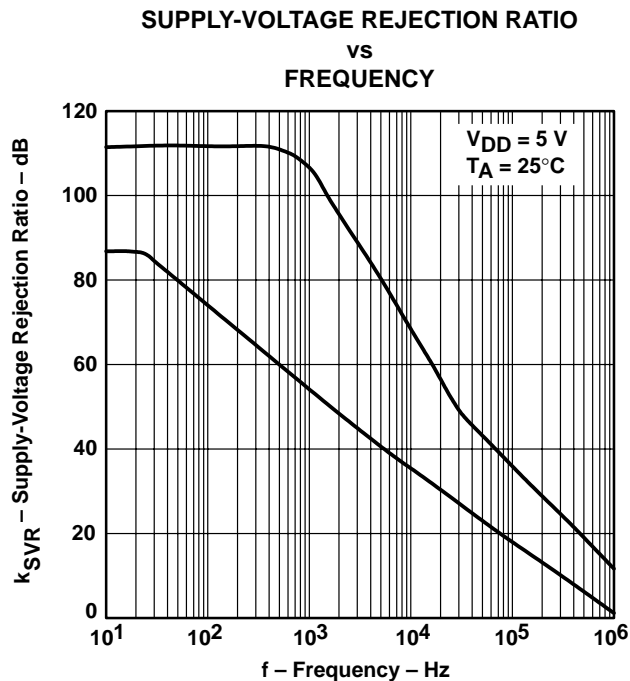

Figure 28

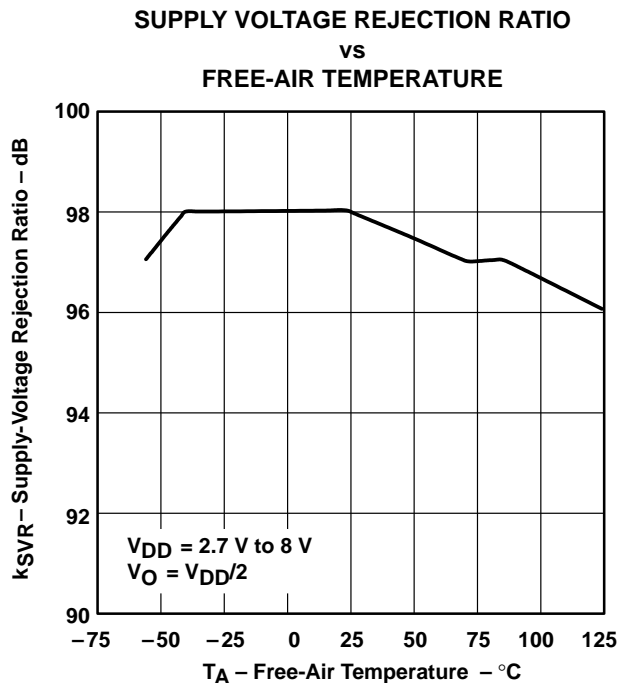

Figure 29

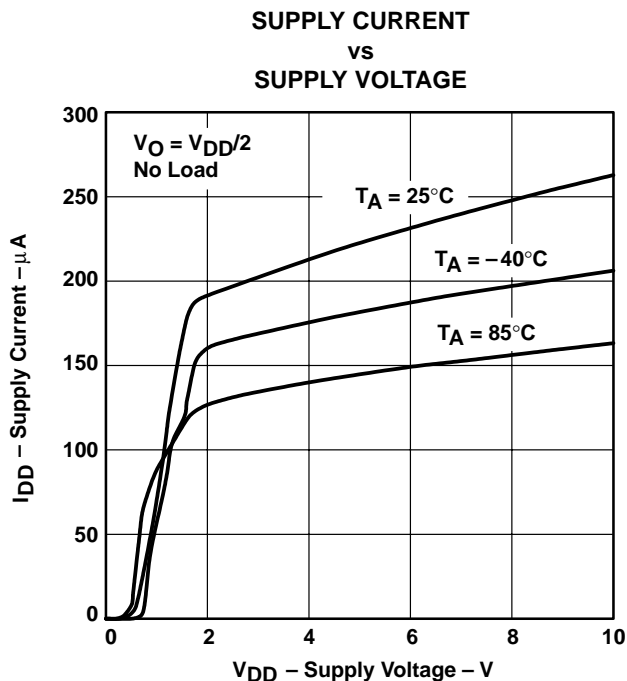

Figure 30

TYPICAL CHARACTERISTICS

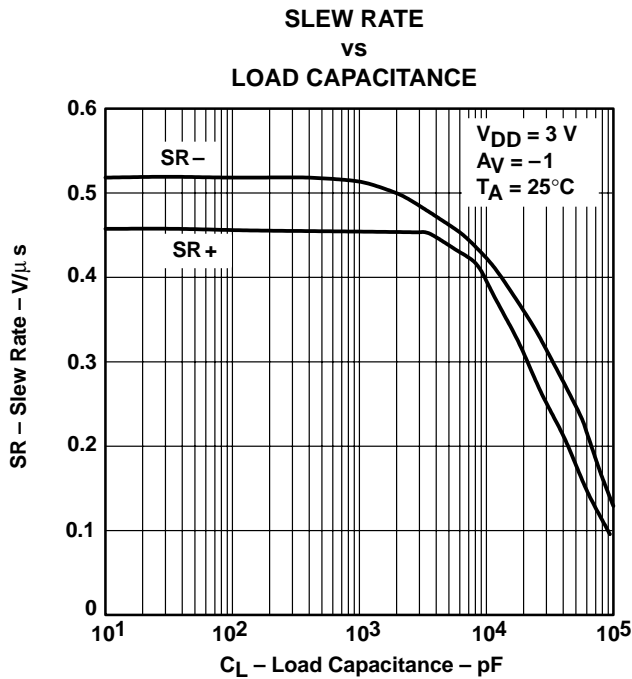

Figure 31

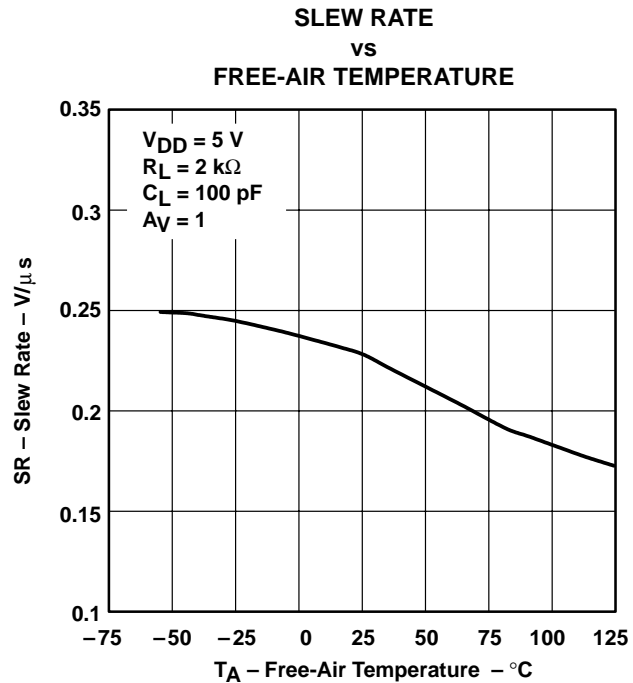

Figure 32

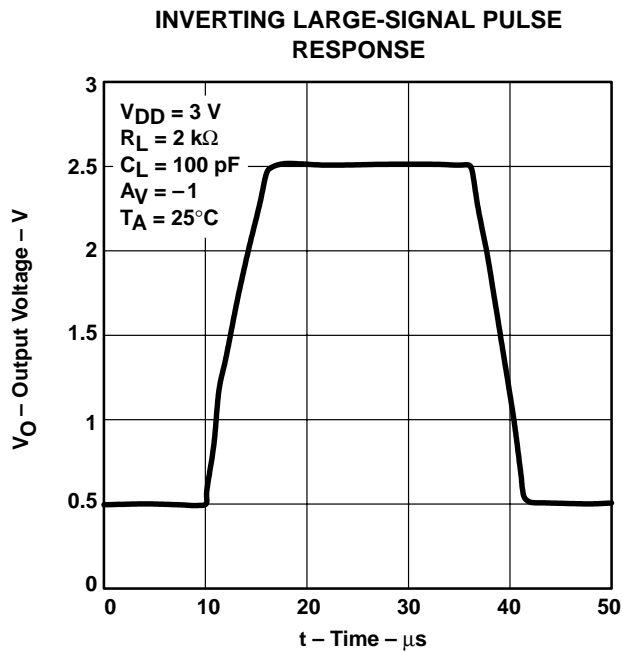

Figure 33

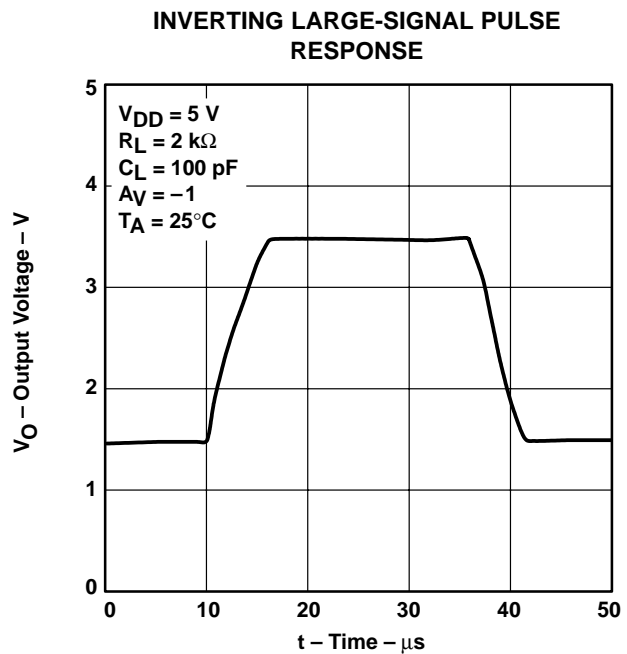

Figure 34

TYPICAL CHARACTERISTICS

VOLTAGE-FOLLOWER LARGE-SIGNAL
 PULSE RESPONSE

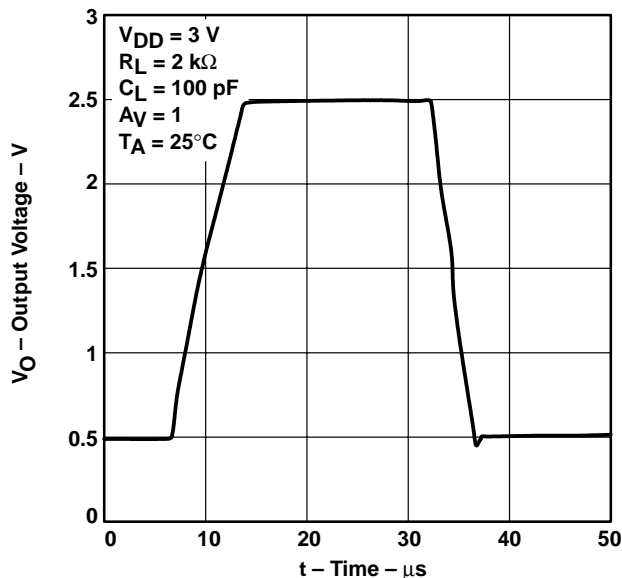

Figure 35

VOLTAGE-FOLLOWER LARGE-SIGNAL
 PULSE RESPONSE

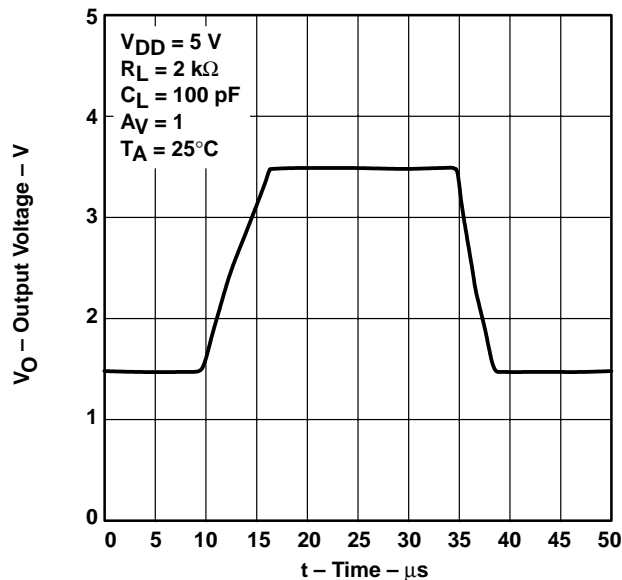

Figure 36

INVERTING SMALL-SIGNAL PULSE
 RESPONSE

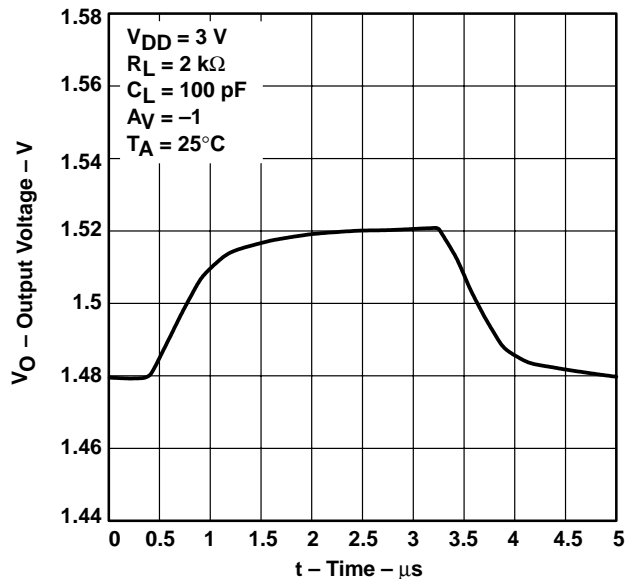

Figure 37

INVERTING SMALL-SIGNAL PULSE
 RESPONSE

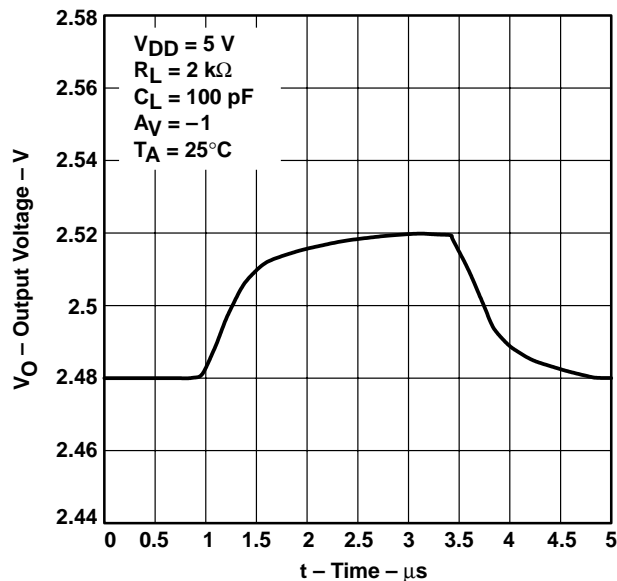

Figure 38

TLV2432, TLV2432A, TLV2434, TLV2434A
Advanced LinCMOS™ RAIL-TO-RAIL OUTPUT
WIDE-INPUT-VOLTAGE OPERATIONAL AMPLIFIERS

SLOS168F – NOVEMBER 1996 – REVISED MARCH 2001

TYPICAL CHARACTERISTICS

VOLTAGE-FOLLOWER SMALL-SIGNAL PULSE RESPONSE

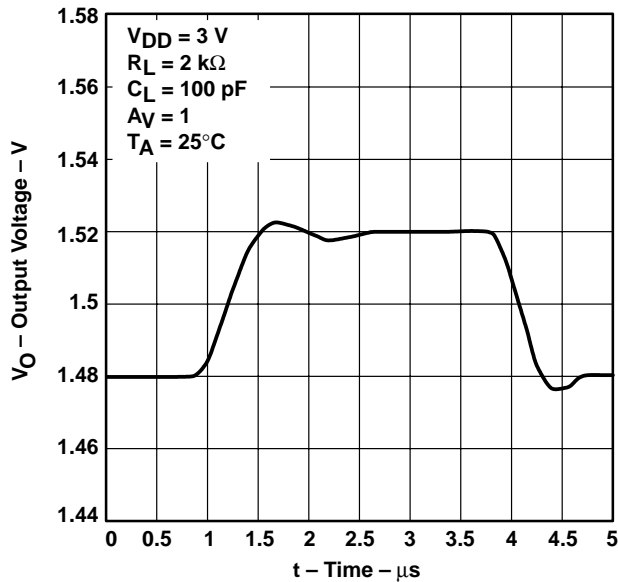

Figure 39

VOLTAGE-FOLLOWER SMALL-SIGNAL PULSE RESPONSE

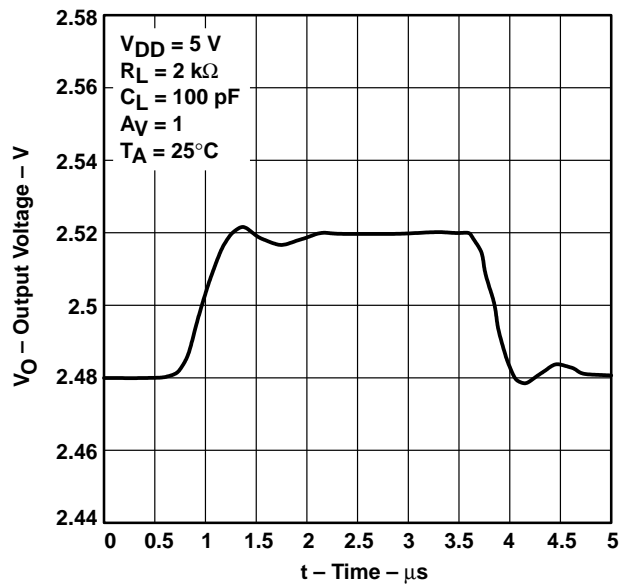

Figure 40

EQUIVALENT INPUT NOISE VOLTAGE VS FREQUENCY

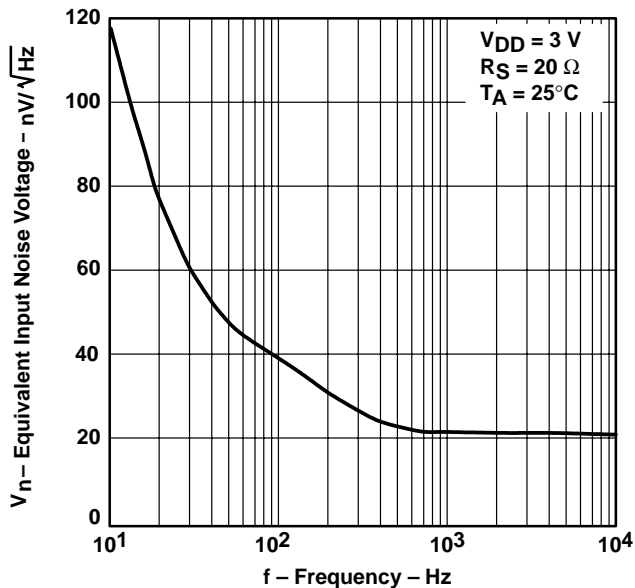

Figure 41

EQUIVALENT INPUT NOISE VOLTAGE VS FREQUENCY

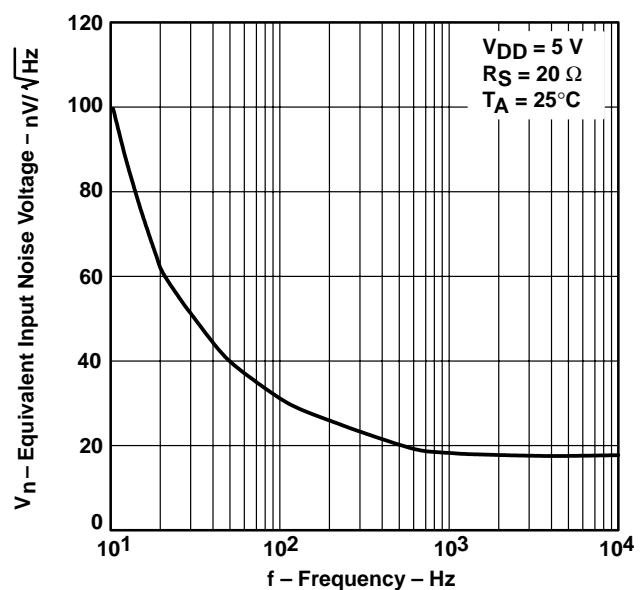

Figure 42



TYPICAL CHARACTERISTICS

NOISE VOLTAGE OVER A 10-SECOND PERIOD

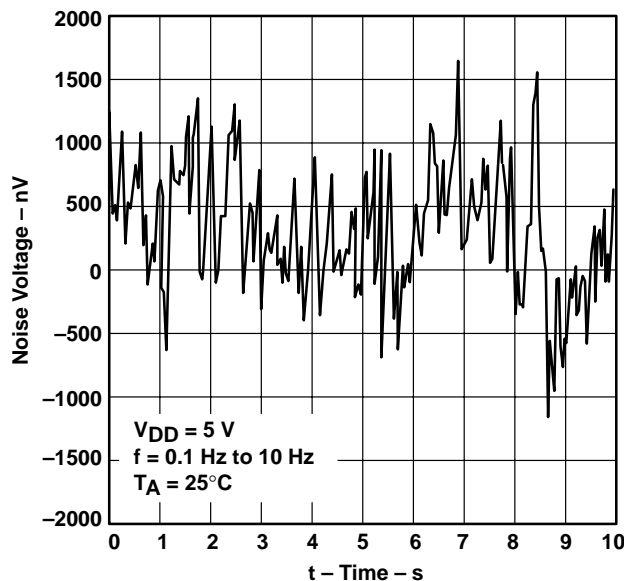

Figure 43

TOTAL HARMONIC DISTORTION PLUS NOISE
 VS
 FREQUENCY

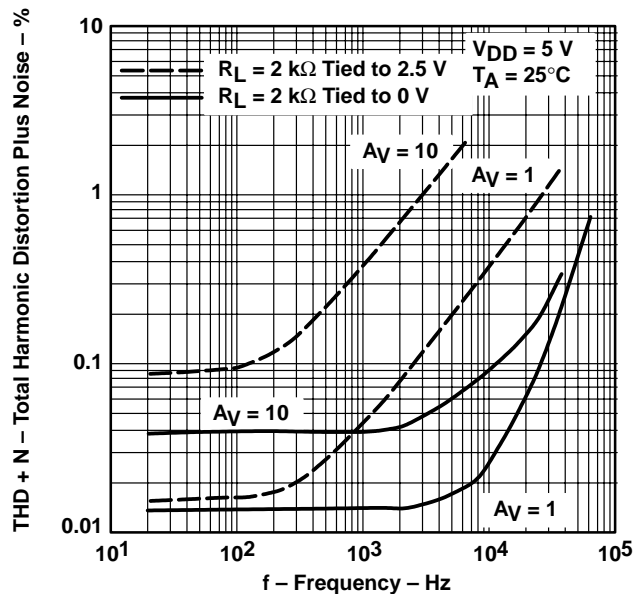

Figure 44

TOTAL HARMONIC DISTORTION PLUS NOISE
 VS
 FREQUENCY

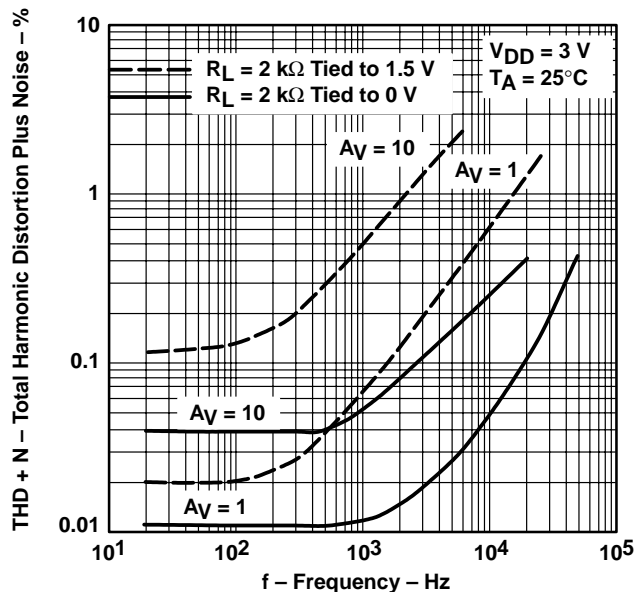

Figure 45

TLV2432, TLV2432A, TLV2434, TLV2434A
Advanced LinCMOS™ RAIL-TO-RAIL OUTPUT
WIDE-INPUT-VOLTAGE OPERATIONAL AMPLIFIERS

SLOS168F – NOVEMBER 1996 – REVISED MARCH 2001

TYPICAL CHARACTERISTICS

GAIN-BANDWIDTH PRODUCT
vs
FREE-AIR TEMPERATURE

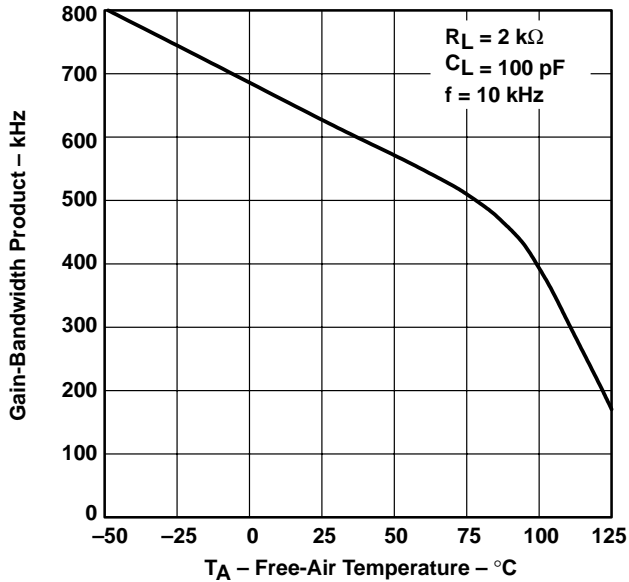

Figure 46

GAIN-BANDWIDTH PRODUCT
vs
SUPPLY VOLTAGE

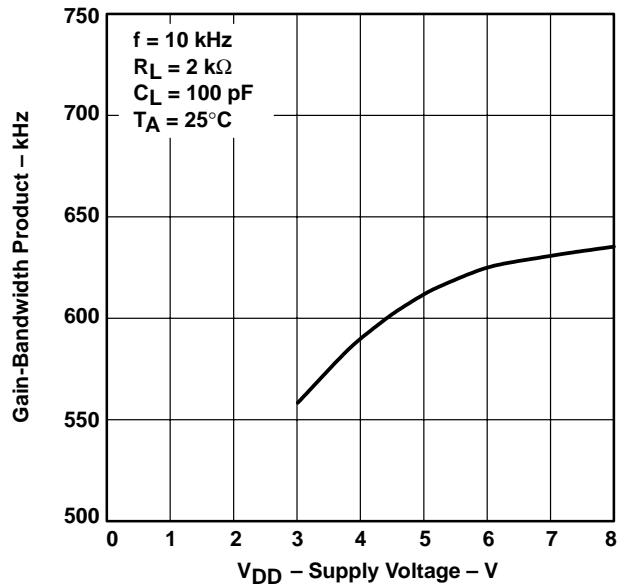

Figure 47

PHASE MARGIN
vs
LOAD CAPACITANCE

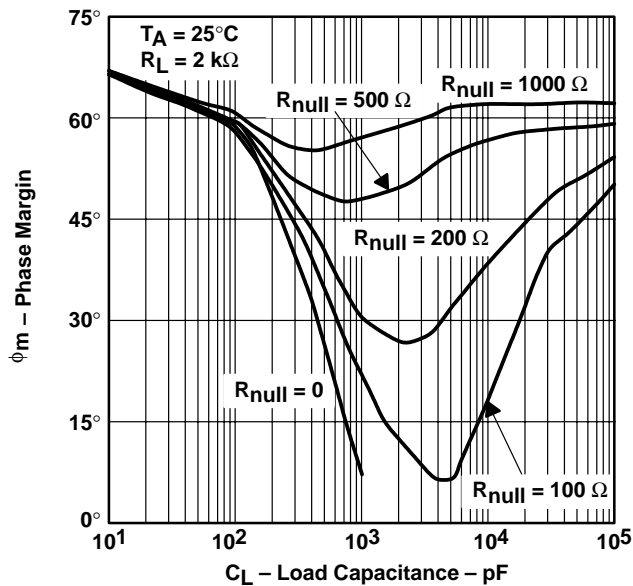

Figure 48

GAIN MARGIN
vs
LOAD CAPACITANCE

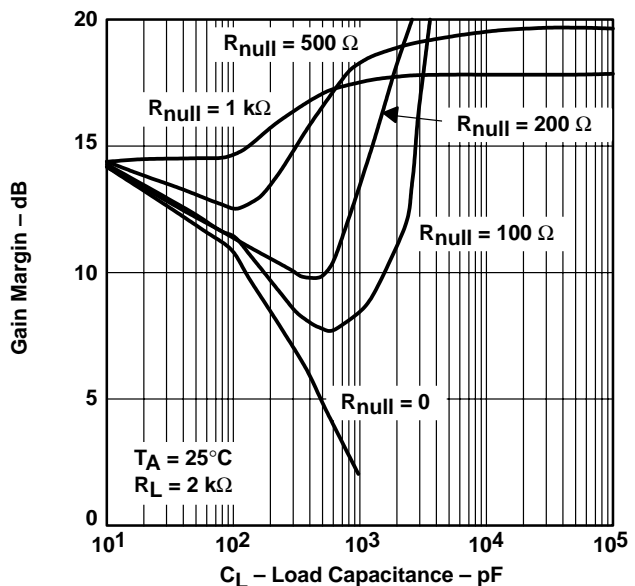

Figure 49



TYPICAL CHARACTERISTICS

UNITY-GAIN BANDWIDTH
vs
LOAD CAPACITANCE

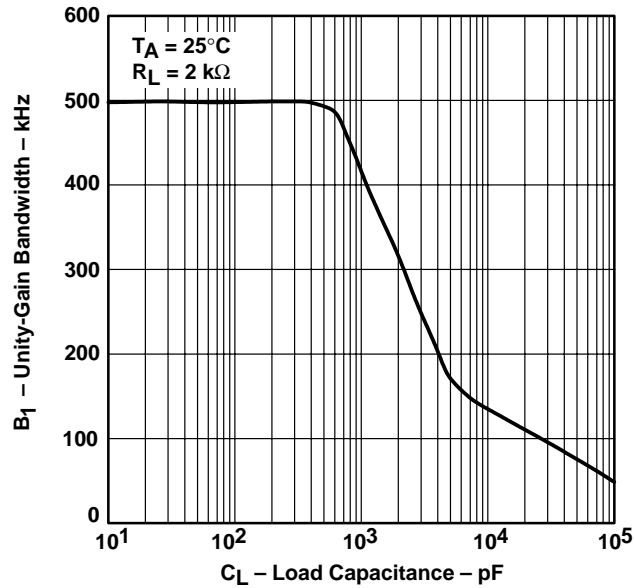

Figure 50

TLV2432, TLV2432A, TLV2434, TLV2434A Advanced LinCMOS™ RAIL-TO-RAIL OUTPUT WIDE-INPUT-VOLTAGE OPERATIONAL AMPLIFIERS

SLOS168F – NOVEMBER 1996 – REVISED MARCH 2001

APPLICATION INFORMATION

macromodel information

Macromodel information provided was derived using Microsim *Parts*™, the model generation software used with Microsim *PSpice*™. The Boyle macromodel (see Note 5) and subcircuit in Figure 51 are generated using the TLV243x typical electrical and operating characteristics at $T_A = 25^\circ\text{C}$. Using this information, output simulations of the following key parameters can be generated to a tolerance of 20% (in most cases):

- Maximum positive output voltage swing
- Maximum negative output voltage swing
- Slew rate
- Quiescent power dissipation
- Input bias current
- Open-loop voltage amplification
- Unity-gain frequency
- Common-mode rejection ratio
- Phase margin
- DC output resistance
- AC output resistance
- Short-circuit output current limit

NOTE 4: G. R. Boyle, B. M. Cohn, D. O. Pederson, and J. E. Solomon, "Macromodeling of Integrated Circuit Operational Amplifiers", *IEEE Journal of Solid-State Circuits*, SC-9, 353 (1974).

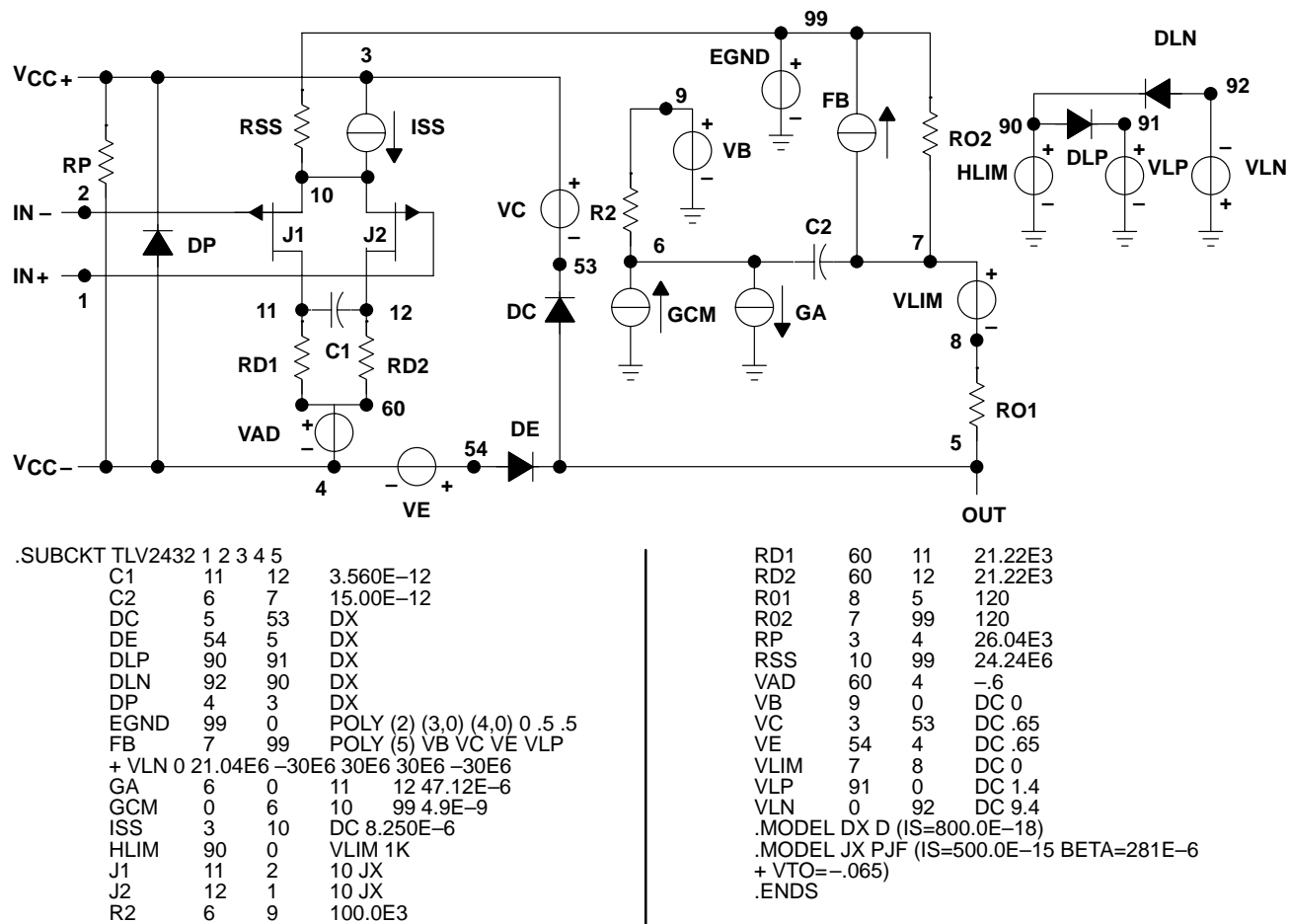

Figure 51. Boyle Macromodel and Subcircuit

PSpice and Parts are trademarks of MicroSim Corporation.



POST OFFICE BOX 655303 • DALLAS, TEXAS 75265

PACKAGING INFORMATION

Orderable Device	Status (1)	Package Type	Package Drawing	Pins	Package Qty	Eco Plan (2)	Lead finish/ Ball material (6)	MSL Peak Temp (3)	Op Temp (°C)	Device Marking (4/5)	Samples
TLV2432AID	OBSOLETE	SOIC	D	8		TBD	Call TI	Call TI	-40 to 85	2432AI	
TLV2432AIDR	ACTIVE	SOIC	D	8	2500	RoHS & Green	NIPDAU	Level-1-260C-UNLIM	-40 to 85	2432AI	Samples
TLV2432AIPW	OBSOLETE	TSSOP	PW	8		TBD	Call TI	Call TI	-40 to 85	TV2432	
TLV2432AIPWR	ACTIVE	TSSOP	PW	8	2000	RoHS & Green	NIPDAU	Level-1-260C-UNLIM	-40 to 85	2432AI	Samples
TLV2432AQD	ACTIVE	SOIC	D	8	75	RoHS & Green	NIPDAU	Level-1-260C-UNLIM	-40 to 125	V2432A	Samples
TLV2432AQDG4	ACTIVE	SOIC	D	8	75	RoHS & Green	NIPDAU	Level-1-260C-UNLIM	-40 to 125	V2432A	Samples
TLV2432AQDRG4	ACTIVE	SOIC	D	8	2500	RoHS & Green	NIPDAU	Level-1-260C-UNLIM	-40 to 125	V2432A	Samples
TLV2432CD	OBSOLETE	SOIC	D	8		TBD	Call TI	Call TI	0 to 70	2432C	
TLV2432CDR	ACTIVE	SOIC	D	8	2500	RoHS & Green	NIPDAU	Level-1-260C-UNLIM	0 to 70	2432C	Samples
TLV2432ID	OBSOLETE	SOIC	D	8		TBD	Call TI	Call TI	-40 to 85	2432I	
TLV2432IDR	ACTIVE	SOIC	D	8	2500	RoHS & Green	NIPDAU	Level-1-260C-UNLIM	-40 to 85	2432I	Samples
TLV2432QD	ACTIVE	SOIC	D	8	75	RoHS & Green	NIPDAU	Level-1-260C-UNLIM	-40 to 125	V2432Q	Samples
TLV2434AID	OBSOLETE	SOIC	D	14		TBD	Call TI	Call TI	-40 to 85	2434AI	
TLV2434AIDR	ACTIVE	SOIC	D	14	2500	RoHS & Green	NIPDAU	Level-1-260C-UNLIM	-40 to 85	2434AI	Samples
TLV2434AIPWR	ACTIVE	TSSOP	PW	14	2000	RoHS & Green	NIPDAU	Level-1-260C-UNLIM	-40 to 85	2434AI	Samples
TLV2434CD	OBSOLETE	SOIC	D	14		TBD	Call TI	Call TI	0 to 70	2434C	
TLV2434CDR	ACTIVE	SOIC	D	14	2500	RoHS & Green	NIPDAU	Level-1-260C-UNLIM	0 to 70	2434C	Samples
TLV2434CPW	OBSOLETE	TSSOP	PW	14		TBD	Call TI	Call TI	0 to 70	2434C	
TLV2434CPWR	ACTIVE	TSSOP	PW	14	2000	RoHS & Green	NIPDAU	Level-1-260C-UNLIM	0 to 70	2434C	Samples
TLV2434ID	OBSOLETE	SOIC	D	14		TBD	Call TI	Call TI	-40 to 85	2434I	
TLV2434IDR	ACTIVE	SOIC	D	14	2500	RoHS & Green	NIPDAU	Level-1-260C-UNLIM	-40 to 85	2434I	Samples
TLV2434IPW	OBSOLETE	TSSOP	PW	14		TBD	Call TI	Call TI	-40 to 85	2434I	
TLV2434IPWR	ACTIVE	TSSOP	PW	14	2000	RoHS & Green	NIPDAU	Level-1-260C-UNLIM	-40 to 85	2434I	Samples

(1) The marketing status values are defined as follows:

ACTIVE: Product device recommended for new designs.

LIFEBUY: TI has announced that the device will be discontinued, and a lifetime-buy period is in effect.

NRND: Not recommended for new designs. Device is in production to support existing customers, but TI does not recommend using this part in a new design.

PREVIEW: Device has been announced but is not in production. Samples may or may not be available.

OBSOLETE: TI has discontinued the production of the device.

(2) **RoHS:** TI defines "RoHS" to mean semiconductor products that are compliant with the current EU RoHS requirements for all 10 RoHS substances, including the requirement that RoHS substance do not exceed 0.1% by weight in homogeneous materials. Where designed to be soldered at high temperatures, "RoHS" products are suitable for use in specified lead-free processes. TI may reference these types of products as "Pb-Free".

RoHS Exempt: TI defines "RoHS Exempt" to mean products that contain lead but are compliant with EU RoHS pursuant to a specific EU RoHS exemption.

Green: TI defines "Green" to mean the content of Chlorine (Cl) and Bromine (Br) based flame retardants meet JS709B low halogen requirements of ≤ 1000 ppm threshold. Antimony trioxide based flame retardants must also meet the ≤ 1000 ppm threshold requirement.

(3) MSL, Peak Temp. - The Moisture Sensitivity Level rating according to the JEDEC industry standard classifications, and peak solder temperature.

(4) There may be additional marking, which relates to the logo, the lot trace code information, or the environmental category on the device.

(5) Multiple Device Markings will be inside parentheses. Only one Device Marking contained in parentheses and separated by a "~" will appear on a device. If a line is indented then it is a continuation of the previous line and the two combined represent the entire Device Marking for that device.

(6) Lead finish/Ball material - Orderable Devices may have multiple material finish options. Finish options are separated by a vertical ruled line. Lead finish/Ball material values may wrap to two lines if the finish value exceeds the maximum column width.

Important Information and Disclaimer:The information provided on this page represents TI's knowledge and belief as of the date that it is provided. TI bases its knowledge and belief on information provided by third parties, and makes no representation or warranty as to the accuracy of such information. Efforts are underway to better integrate information from third parties. TI has taken and continues to take reasonable steps to provide representative and accurate information but may not have conducted destructive testing or chemical analysis on incoming materials and chemicals. TI and TI suppliers consider certain information to be proprietary, and thus CAS numbers and other limited information may not be available for release.

In no event shall TI's liability arising out of such information exceed the total purchase price of the TI part(s) at issue in this document sold by TI to Customer on an annual basis.

OTHER QUALIFIED VERSIONS OF TLV2432, TLV2432A, TLV2434A :

- Automotive : [TLV2432-Q1](#), [TLV2432A-Q1](#), [TLV2434A-Q1](#)

NOTE: Qualified Version Definitions:

- Automotive - Q100 devices qualified for high-reliability automotive applications targeting zero defects

TAPE AND REEL INFORMATION

QUADRANT ASSIGNMENTS FOR PIN 1 ORIENTATION IN TAPE

*All dimensions are nominal

Device	Package Type	Package Drawing	Pins	SPQ	Reel Diameter (mm)	Reel Width W1 (mm)	A0 (mm)	B0 (mm)	K0 (mm)	P1 (mm)	W (mm)	Pin1 Quadrant
TLV2432AIDR	SOIC	D	8	2500	330.0	12.4	6.4	5.2	2.1	8.0	12.0	Q1
TLV2432AIDR	SOIC	D	8	2500	330.0	12.4	6.4	5.2	2.1	8.0	12.0	Q1
TLV2432AIPWR	TSSOP	PW	8	2000	330.0	12.4	7.0	3.6	1.6	8.0	12.0	Q1
TLV2432AIPWR	TSSOP	PW	8	2000	330.0	12.4	7.0	3.6	1.6	8.0	12.0	Q1
TLV2432CDR	SOIC	D	8	2500	330.0	12.4	6.4	5.2	2.1	8.0	12.0	Q1
TLV2432CDR	SOIC	D	8	2500	330.0	12.4	6.4	5.2	2.1	8.0	12.0	Q1
TLV2432IDR	SOIC	D	8	2500	330.0	12.4	6.4	5.2	2.1	8.0	12.0	Q1
TLV2432IDR	SOIC	D	8	2500	330.0	12.4	6.4	5.2	2.1	8.0	12.0	Q1
TLV2434AIDR	SOIC	D	14	2500	330.0	16.4	6.5	9.0	2.1	8.0	16.0	Q1
TLV2434AIDR	SOIC	D	14	2500	330.0	16.4	6.5	9.0	2.1	8.0	16.0	Q1
TLV2434AIPWR	TSSOP	PW	14	2000	330.0	12.4	6.9	5.6	1.6	8.0	12.0	Q1
TLV2434AIPWR	TSSOP	PW	14	2000	330.0	12.4	6.9	5.6	1.6	8.0	12.0	Q1
TLV2434CDR	SOIC	D	14	2500	330.0	16.4	6.5	9.0	2.1	8.0	16.0	Q1
TLV2434CPWR	TSSOP	PW	14	2000	330.0	12.4	6.9	5.6	1.6	8.0	12.0	Q1
TLV2434CPWR	TSSOP	PW	14	2000	330.0	12.4	6.9	5.6	1.6	8.0	12.0	Q1
TLV2434IDR	SOIC	D	14	2500	330.0	16.4	6.5	9.0	2.1	8.0	16.0	Q1

Device	Package Type	Package Drawing	Pins	SPQ	Reel Diameter (mm)	Reel Width W1 (mm)	A0 (mm)	B0 (mm)	K0 (mm)	P1 (mm)	W (mm)	Pin1 Quadrant
TLV2434IDR	SOIC	D	14	2500	330.0	16.4	6.5	9.0	2.1	8.0	16.0	Q1
TLV2434IPWR	TSSOP	PW	14	2000	330.0	12.4	6.9	5.6	1.6	8.0	12.0	Q1
TLV2434IPWR	TSSOP	PW	14	2000	330.0	12.4	6.9	5.6	1.6	8.0	12.0	Q1

TAPE AND REEL BOX DIMENSIONS

*All dimensions are nominal

Device	Package Type	Package Drawing	Pins	SPQ	Length (mm)	Width (mm)	Height (mm)
TLV2432AIDR	SOIC	D	8	2500	356.0	356.0	35.0
TLV2432AIDR	SOIC	D	8	2500	340.5	338.1	20.6
TLV2432AIPWR	TSSOP	PW	8	2000	356.0	356.0	35.0
TLV2432AIPWR	TSSOP	PW	8	2000	356.0	356.0	35.0
TLV2432CDR	SOIC	D	8	2500	340.5	338.1	20.6
TLV2432CDR	SOIC	D	8	2500	356.0	356.0	35.0
TLV2432IDR	SOIC	D	8	2500	356.0	356.0	35.0
TLV2432IDR	SOIC	D	8	2500	340.5	338.1	20.6
TLV2434AIDR	SOIC	D	14	2500	350.0	350.0	43.0
TLV2434AIDR	SOIC	D	14	2500	353.0	353.0	32.0
TLV2434AIPWR	TSSOP	PW	14	2000	356.0	356.0	35.0
TLV2434AIPWR	TSSOP	PW	14	2000	356.0	356.0	35.0
TLV2434CDR	SOIC	D	14	2500	353.0	353.0	32.0
TLV2434CPWR	TSSOP	PW	14	2000	356.0	356.0	35.0
TLV2434CPWR	TSSOP	PW	14	2000	356.0	356.0	35.0
TLV2434IDR	SOIC	D	14	2500	350.0	350.0	43.0
TLV2434IDR	SOIC	D	14	2500	356.0	356.0	35.0
TLV2434IPWR	TSSOP	PW	14	2000	356.0	356.0	35.0

Device	Package Type	Package Drawing	Pins	SPQ	Length (mm)	Width (mm)	Height (mm)
TLV2434IPWR	TSSOP	PW	14	2000	356.0	356.0	35.0

TUBE

*All dimensions are nominal

Device	Package Name	Package Type	Pins	SPQ	L (mm)	W (mm)	T (μm)	B (mm)
TLV2432AQD	D	SOIC	8	75	507	8	3940	4.32
TLV2432AQDG4	D	SOIC	8	75	507	8	3940	4.32
TLV2432QD	D	SOIC	8	75	507	8	3940	4.32

D (R-PDSO-G14)

PLASTIC SMALL OUTLINE



- NOTES:
- A. All linear dimensions are in inches (millimeters).
 - B. This drawing is subject to change without notice.
 - Body length does not include mold flash, protrusions, or gate burrs. Mold flash, protrusions, or gate burrs shall not exceed 0.006 (0,15) each side.
 - Body width does not include interlead flash. Interlead flash shall not exceed 0.017 (0,43) each side.
 - E. Reference JEDEC MS-012 variation AB.

D (R-PDSO-G14)

PLASTIC SMALL OUTLINE



- NOTES:
- A. All linear dimensions are in millimeters.
 - B. This drawing is subject to change without notice.
 - C. Publication IPC-7351 is recommended for alternate designs.
 - D. Laser cutting apertures with trapezoidal walls and also rounding corners will offer better paste release. Customers should contact their board assembly site for stencil design recommendations. Refer to IPC-7525 for other stencil recommendations.
 - E. Customers should contact their board fabrication site for solder mask tolerances between and around signal pads.

PW (R-PDSO-G14)

PLASTIC SMALL OUTLINE

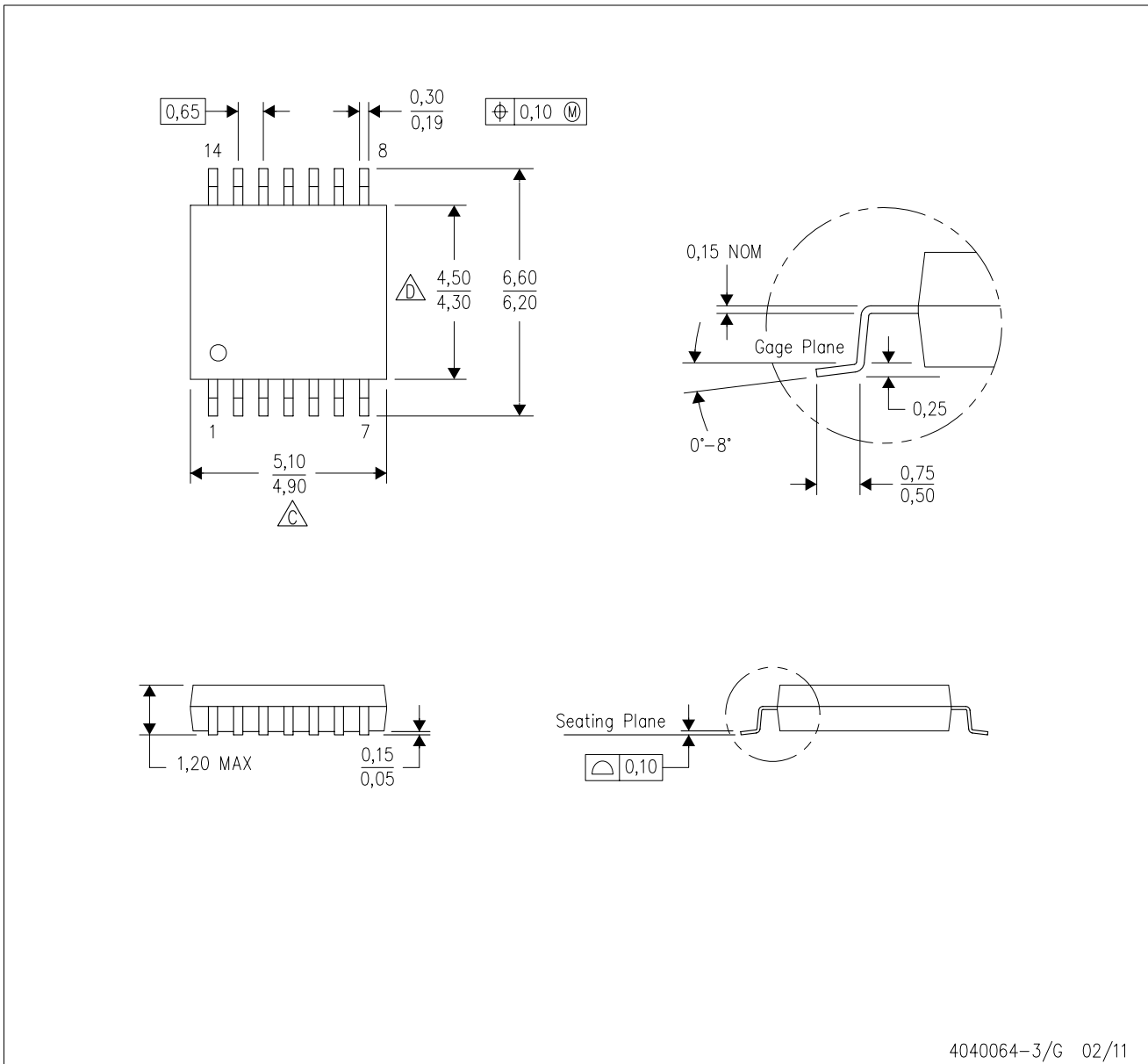

4040064-3/G 02/11

- NOTES:
- A. All linear dimensions are in millimeters. Dimensioning and tolerancing per ASME Y14.5M-1994.
 - B. This drawing is subject to change without notice.
 - C. Body length does not include mold flash, protrusions, or gate burrs. Mold flash, protrusions, or gate burrs shall not exceed 0,15 each side.
 - D. Body width does not include interlead flash. Interlead flash shall not exceed 0,25 each side.
 - E. Falls within JEDEC MO-153



D0008A

PACKAGE OUTLINE

SOIC - 1.75 mm max height

SMALL OUTLINE INTEGRATED CIRCUIT



4214825/C 02/2019

NOTES:

1. Linear dimensions are in inches [millimeters]. Dimensions in parenthesis are for reference only. Controlling dimensions are in inches. Dimensioning and tolerancing per ASME Y14.5M.
2. This drawing is subject to change without notice.
3. This dimension does not include mold flash, protrusions, or gate burrs. Mold flash, protrusions, or gate burrs shall not exceed $.006$ [0.15] per side.
4. This dimension does not include interlead flash.
5. Reference JEDEC registration MS-012, variation AA.

EXAMPLE BOARD LAYOUT

D0008A

SOIC - 1.75 mm max height

SMALL OUTLINE INTEGRATED CIRCUIT



LAND PATTERN EXAMPLE
EXPOSED METAL SHOWN
SCALE:8X



SOLDER MASK DETAILS

4214825/C 02/2019

NOTES: (continued)

- 6. Publication IPC-7351 may have alternate designs.
- 7. Solder mask tolerances between and around signal pads can vary based on board fabrication site.

EXAMPLE STENCIL DESIGN

D0008A

SOIC - 1.75 mm max height

SMALL OUTLINE INTEGRATED CIRCUIT



SOLDER PASTE EXAMPLE
BASED ON .005 INCH [0.125 MM] THICK STENCIL
SCALE:8X

4214825/C 02/2019

NOTES: (continued)

8. Laser cutting apertures with trapezoidal walls and rounded corners may offer better paste release. IPC-7525 may have alternate design recommendations.
9. Board assembly site may have different recommendations for stencil design.

PW0008A



PACKAGE OUTLINE
TSSOP - 1.2 mm max height

SMALL OUTLINE PACKAGE



4221848/A 02/2015

NOTES:

1. All linear dimensions are in millimeters. Any dimensions in parenthesis are for reference only. Dimensioning and tolerancing per ASME Y14.5M.
2. This drawing is subject to change without notice.
3. This dimension does not include mold flash, protrusions, or gate burrs. Mold flash, protrusions, or gate burrs shall not exceed 0.15 mm per side.
4. This dimension does not include interlead flash. Interlead flash shall not exceed 0.25 mm per side.
5. Reference JEDEC registration MO-153, variation AA.

EXAMPLE BOARD LAYOUT

PW0008A

TSSOP - 1.2 mm max height

SMALL OUTLINE PACKAGE



LAND PATTERN EXAMPLE
SCALE:10X



SOLDER MASK DETAILS
NOT TO SCALE

4221848/A 02/2015

NOTES: (continued)

- 6. Publication IPC-7351 may have alternate designs.
- 7. Solder mask tolerances between and around signal pads can vary based on board fabrication site.

EXAMPLE STENCIL DESIGN

PW0008A

TSSOP - 1.2 mm max height

SMALL OUTLINE PACKAGE



SOLDER PASTE EXAMPLE
BASED ON 0.125 mm THICK STENCIL
SCALE:10X

4221848/A 02/2015

NOTES: (continued)

8. Laser cutting apertures with trapezoidal walls and rounded corners may offer better paste release. IPC-7525 may have alternate design recommendations.
9. Board assembly site may have different recommendations for stencil design.

IMPORTANT NOTICE AND DISCLAIMER

TI PROVIDES TECHNICAL AND RELIABILITY DATA (INCLUDING DATA SHEETS), DESIGN RESOURCES (INCLUDING REFERENCE DESIGNS), APPLICATION OR OTHER DESIGN ADVICE, WEB TOOLS, SAFETY INFORMATION, AND OTHER RESOURCES "AS IS" AND WITH ALL FAULTS, AND DISCLAIMS ALL WARRANTIES, EXPRESS AND IMPLIED, INCLUDING WITHOUT LIMITATION ANY IMPLIED WARRANTIES OF MERCHANTABILITY, FITNESS FOR A PARTICULAR PURPOSE OR NON-INFRINGEMENT OF THIRD PARTY INTELLECTUAL PROPERTY RIGHTS.

These resources are intended for skilled developers designing with TI products. You are solely responsible for (1) selecting the appropriate TI products for your application, (2) designing, validating and testing your application, and (3) ensuring your application meets applicable standards, and any other safety, security, regulatory or other requirements.

These resources are subject to change without notice. TI grants you permission to use these resources only for development of an application that uses the TI products described in the resource. Other reproduction and display of these resources is prohibited. No license is granted to any other TI intellectual property right or to any third party intellectual property right. TI disclaims responsibility for, and you will fully indemnify TI and its representatives against, any claims, damages, costs, losses, and liabilities arising out of your use of these resources.

TI's products are provided subject to [TI's Terms of Sale](#) or other applicable terms available either on [ti.com](https://www.ti.com) or provided in conjunction with such TI products. TI's provision of these resources does not expand or otherwise alter TI's applicable warranties or warranty disclaimers for TI products.

TI objects to and rejects any additional or different terms you may have proposed.

Mailing Address: Texas Instruments, Post Office Box 655303, Dallas, Texas 75265
Copyright © 2024, Texas Instruments Incorporated