

# TLV3801, TLV3802, TLV3811(C) 225-ps High-Speed Comparators with LVDS Outputs

## 1 Features

- Low propagation delay: 225 ps
- Low overdrive dispersion: 5 ps
- Quiescent current: 17 mA
- High toggle frequency: 3 GHz /6 Gbps
- Narrow pulse width detection capability: 240 ps
- LVDS output
- Split input and output ground reference
- Single supply voltage: 2.7 V to 5.25 V
- Low input offset voltage:  $\pm 0.5$  mV
- Internal 2 mV hysteresis: TLV380x
- Internal 1.1 mV hysteresis: TLV3811
- Internal 0 mV hysteresis: TLV3811C
- Packages: TLV3801 (8-Pin WSON), TLV3811(C) (6-Pin DSBGA), TLV3802 (12-Pin WSON)

## 2 Applications

- [Distance sensing in LIDAR](#)
- [Time-of-Flight sensors](#)
- [High speed trigger function in oscilloscope and logic analyzer](#)
- [High speed differential line receiver](#)
- [Drone vision](#)

## 3 Description

The TLV380x/TLV3811(C) are 225-ps high speed comparators with a wide power supply range and a very high toggle frequency of 3 GHz. Along with an operating supply voltage range of 2.7 V to 5.25 V for single supply and 2.7 V to 5.25 V for split supply, all of these features come in industry-standard small packages, making these devices an excellent choice for LIDAR, differential line receiver applications, and test and measurement systems.

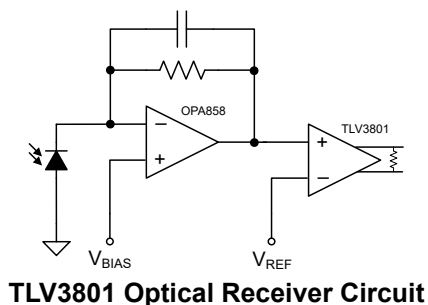

**TLV3801 Optical Receiver Circuit**

The TLV380x/TLV3811(C) have a very strong input overdrive performance of 5 ps, and narrow pulse width capabilities of just 240 ps. This combination of low variation in propagation delay due to input overdrive and the ability to detect narrow pulses make these devices excellent choices for Time-of-Flight (ToF) applications such as in factory automation and drone vision.

The Low-Voltage-Differential-Signal (LVDS) output of the TLV380x/TLV3811(C) helps increase data throughput and optimizes power consumption. Likewise, the complementary outputs help to reduce EMI by suppressing common mode noise on each output. The LVDS output is designed to drive and interface directly with other devices that accept a standard LVDS input, such as most FPGAs and CPUs downstream in an application.

The TLV3801 and TLV3802 are in an 8-pin WSON and 12-pin WSON package, respectively, while the TLV3811(C) is in a tiny 6-pin DSBGA package, which makes them desirable for space sensitive applications such as an optical sensor module.

### Device Information

PART NUMBER	PACKAGE (1)	BODY SIZE (NOM)
TLV3801	WSON (8)	2.00 mm × 2.00 mm
TLV3811(C)	DSBGA (6)	1.218 mm × 0.818 mm
TLV3802	WSON (12)	3.00 mm × 2.00 mm

1. For all orderable packages, see the orderable addendum at the end of the data sheet.

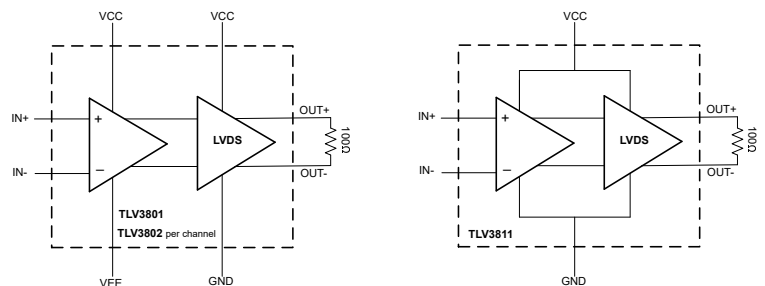

**Functional Block Diagram**



## Table of Contents

<b>1 Features</b> .....	1	7.3 Feature Description.....	14
<b>2 Applications</b> .....	1	7.4 Device Functional Modes.....	14
<b>3 Description</b> .....	1	<b>8 Application and Implementation</b> .....	16
<b>4 Revision History</b> .....	2	8.1 Application Information.....	16
<b>5 Pin Configuration and Functions</b> .....	3	8.2 Typical Application.....	16
<b>6 Specifications</b> .....	5	8.3 Power Supply Recommendations.....	21
6.1 Absolute Maximum Ratings.....	5	8.4 Layout.....	22
6.2 ESD Ratings.....	5	<b>9 Device and Documentation Support</b> .....	23
6.3 Thermal Information.....	5	9.1 Device Support.....	23
6.4 Recommended Operating Conditions.....	5	9.2 Receiving Notification of Documentation Updates....	23
6.5 Electrical Characteristics.....	7	9.3 Support Resources.....	23
6.6 Timing Diagrams .....	9	9.4 Trademarks.....	23
6.7 Typical Characteristics.....	10	9.5 Electrostatic Discharge Caution.....	23
<b>7 Detailed Description</b> .....	14	9.6 Glossary.....	23
7.1 Overview.....	14	<b>10 Mechanical, Packaging, and Orderable Information</b> .....	23
7.2 Functional Block Diagram.....	14		

## 4 Revision History

NOTE: Page numbers for previous revisions may differ from page numbers in the current version.

### Changes from Revision B (March 2023) to Revision C (November 2023) Page

- Change preview to RTM release of TLV3802..... 1

### Changes from Revision A (October 2022) to Revision B (March 2023) Page

- Added TLV3811(C) and TLV3802 (Preliminary) throughout the data sheet..... 1

### Changes from Revision \* (December 2021) to Revision A (October 2022) Page

- Change preview to RTM for TLV3811..... 1

## 5 Pin Configuration and Functions

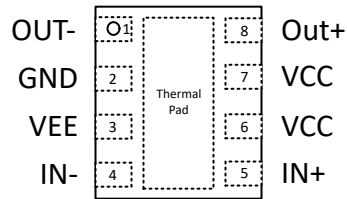

**Figure 5-1. WSON Package  
8-Pin DSG  
Top View**

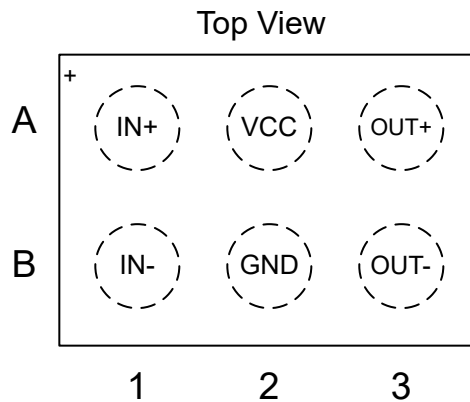

**Figure 5-2. DSBGA Package  
6-Pin YBG  
Top View**

**Table 5-1. Pin Functions**

NAME	PIN		I/O	DESCRIPTION
	TLV3801	TLV3811(C)		
IN+	5	A1	I	Non-inverting input
IN-	4	B1	I	Inverting input
OUT+	8	A3	O	Non-inverting output
OUT-	1	B3	O	Inverting output
V <sub>EE</sub>	3	-	I	Negative power supply (If using single supply, connect to GND)
V <sub>CC</sub>	6, 7	A2	I	Positive power supply
GND	2	B2	I	Ground

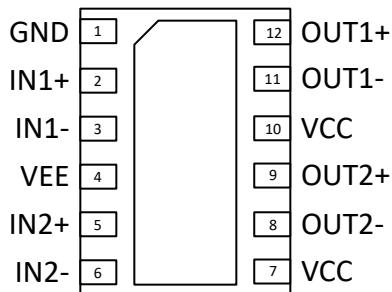

**Figure 5-3. WSON Package  
12-Pin DSS  
Top View**

**Table 5-2. Pin Functions**

PIN		I/O	DESCRIPTION
NAME	TLV3802		
GND	1	I	Ground
IN1+	2	I	Channel 1 Non-inverting input
IN1-	3	I	Channel 1 Inverting input
VEE	4	I	Negative power supply (If using single supply, connect to GND)
IN2+	5	I	Channel 2 Non-inverting input
IN2-	6	I	Channel 2 Inverting input
VCC	7	I	Positive power supply
OUT2-	8	O	Channel 2 Inverting output
OUT2+	9	O	Channel 2 Non-inverting output
VCC	10	I	Positive power supply
OUT1-	11	O	Channel 1 Inverting output
OUT1+	12	O	Channel 1 Non-inverting output
Thermal Pad	–	–	Connect directly to VEE

## 6 Specifications

### 6.1 Absolute Maximum Ratings

over operating free-air temperature range (unless otherwise noted)<sup>(1)</sup>

	MIN	MAX	UNIT
Supply voltage: ( $V_{CC} - V_{EE}$ ) and ( $V_{CC} - GND$ ) <sup>(2)</sup>	-0.3	5.5	V
Input pins (IN+, IN-) from $V_{EE}$ (WSON) <sup>(3)</sup>	$V_{EE} - 0.3$	$V_{CC} + 0.3$	V
Input pins (IN+, IN-) from GND (DSBGA) <sup>(4)</sup>	GND - 0.3	$V_{CC} + 0.3$	V
Current into input pins (IN+, IN-)	-10	10	mA
Output (OUT+, OUT-)	GND	$V_{CC}$	V
Current into output pins (OUT+, OUT-)		10	mA
Junction temperature, $T_J$		150	°C
Storage temperature, $T_{stg}$	-65	150	°C

- (1) Operation outside the Absolute Maximum Ratings may cause permanent device damage. Absolute Maximum Ratings do not imply functional operation of the device at these or any other conditions beyond those listed under Recommended Operating Conditions. If used outside the Recommended Operating Conditions but within the Absolute Maximum Ratings, the device may not be fully functional, and this may affect device reliability, functionality, performance, and shorten the device lifetime.
- (2)  $V_{EE}$  less than or equal to GND
- (3) Input terminals are diode-clamped to  $V_{EE}$  and  $V_{CC}$
- (4) Input terminals are diode-clamped to GND and  $V_{CC}$

### 6.2 ESD Ratings

			VALUE	UNIT
$V_{(ESD)}$	Electrostatic discharge	Human-body model (HBM), per ANSI/ESDA/JEDEC JS-001 <sup>(1)</sup>	±2000	V
		Charged-device model (CDM), per ANSI/ESDA/JEDEC JS-002 <sup>(2)</sup>	±1000	

- (1) JEDEC document JEP155 states that 500 V HBM allows safe manufacturing with a standard ESD control process.
- (2) JEDEC document JEP157 states that 250 V CDM allows safe manufacturing with a standard ESD control process.

### 6.3 Thermal Information

THERMAL METRIC <sup>(1)</sup>		TLV3801	TLV3811(C)	TLV3802	UNIT
		DSG (WSON)	YBG (DSBGA)	DSS (WSON)	
		8 PINS	6 PINS	12 PINS	
$R_{qJA}$	Junction-to-ambient thermal resistance	69.4	132.1	63.2	°C/W
$R_{qJC(top)}$	Junction-to-case (top) thermal resistance	95.7	1.4	61.9	°C/W
$R_{qJB}$	Junction-to-board thermal resistance	36.2	41	30.7	°C/W
$\gamma_{JT}$	Junction-to-top characterization parameter	3.5	0.3	2.4	°C/W
$\gamma_{JB}$	Junction-to-board characterization parameter	36.0	41	30.7	°C/W
$R_{qJC(bot)}$	Junction-to-case (bottom) thermal resistance	9.4	n/a	8.7	°C/W

- (1) For more information about traditional and new thermal metrics, see the [Semiconductor and IC Package Thermal Metrics](#) report.

### 6.4 Recommended Operating Conditions

over operating free-air temperature range (unless otherwise noted)

	MIN	MAX	UNIT
Single supply operation: $V_{CC} - V_{EE}$ with $V_{EE} = GND$	2.7	5.25	V
Split supply operation: $V_{CC} - V_{EE}$ with $V_{EE} < GND$ (WSON)	2.7	5.25	V
Split supply operation: $V_{CC} - GND$ with $V_{EE} < GND$ (WSON)	2.4	5.25	V
Input voltage range (WSON)	$V_{EE} + 1.5$	$V_{CC} + 0.1$	V
Input voltage range (DSBGA)	GND + 1.5	$V_{CC} + 0.1$	V
Differential Input voltage range	-1.5	+1.5	V

## 6.4 Recommended Operating Conditions (continued)

over operating free-air temperature range (unless otherwise noted)

	MIN	MAX	UNIT
Ambient temperature, $T_A$	-40	125	°C

## 6.5 Electrical Characteristics

For  $V_{CC} = 3.3\text{ V}$ ,  $V_{EE} = \text{GND} = 0$ ,  $V_{CM} = 2.5\text{ V}$  at  $T_A = 25^\circ\text{C}$  (Unless otherwise noted)

PARAMETER		TEST CONDITIONS	MIN	TYP	MAX	UNIT
<b>DC Input Characteristics</b>						
$V_{OS}$	Input offset voltage	$T_A = -40^\circ\text{C}$ to $+125^\circ\text{C}$	-5 <sup>(1)</sup>	±0.5	+5 <sup>(1)</sup>	mV
$V_{HYS}$	Input hysteresis voltage	TLV3801, TLV3802		2		mV
$V_{HYS}$ (DSBGA)	Input hysteresis voltage	TLV3811		1.1		mV
	Input hysteresis voltage	TLV3811C		0		mV
$V_{CM\text{-Range}}$	Common-mode voltage range	Single Supply: $V_{EE} = \text{GND}$ $V_{CC} - V_{EE} = 2.7\text{ V}$ to $5.25\text{ V}$ $T_A = -40^\circ\text{C}$ to $+125^\circ\text{C}$	$V_{EE} + 1.5$		$V_{CC}$	V
$V_{CM\text{-Range}}$ (WSON)	Common-mode voltage range	Split Supply: $V_{EE} < \text{GND}$ $V_{CC} - V_{EE} = 2.7\text{ V}$ to $5.25\text{ V}$ and $V_{CC} - \text{GND} = 2.4\text{ V}$ to $5.25\text{ V}$ $T_A = -40^\circ\text{C}$ to $+125^\circ\text{C}$	$V_{EE} + 1.5$		$V_{CC}$	V
CMRR (WSON)	Common mode rejection ratio	$V_{CM} = V_{EE} + 1.5\text{V}$ to $V_{CC}$		80		dB
CMRR (DSBGA)	Common mode rejection ratio	$V_{CM} = \text{GND} + 1.5\text{V}$ to $V_{CC}$		80		dB
PSRR	Power supply rejection ratio	Single Supply: $V_{EE} = \text{GND}$ $V_{CC} - V_{EE} = 2.7\text{ V}$ to $5.25\text{ V}$		80		dB
PSRR (WSON)	Power supply rejection ratio	Split Supply: $V_{EE} < \text{GND}$ $V_{CC} - V_{EE} = 2.7\text{ V}$ to $5.25\text{ V}$ and $V_{CC} - \text{GND} = 2.4\text{ V}$ to $5.25\text{ V}$		80		dB
$I_B$	Input bias current	$T_A = -40^\circ\text{C}$ to $+125^\circ\text{C}$	-10	2	10	µA
$I_{OS}$	Input offset current	$T_A = -40^\circ\text{C}$ to $+125^\circ\text{C}$	-4	±0.1	4	µA
$C_{IC}$	Input capacitance, common mode			1		pF
<b>DC Output Characteristics</b>						
$V_{OCM}$	Output common mode voltage	$V_{CC} - \text{GND} \geq 2.6\text{ V}$ $T_A = -40^\circ\text{C}$ to $+125^\circ\text{C}$	1.125	1.25	1.375	V
	Output common mode voltage	$V_{CC} - \text{GND} < 2.6\text{ V}$ $T_A = -40^\circ\text{C}$ to $+125^\circ\text{C}$	0.92	1.2	1.29	V
$\Delta V_{OCM}$	Output common mode voltage mismatch	$T_A = -40^\circ\text{C}$ to $+125^\circ\text{C}$	-30		30	mV
$V_{OCM\_PP}$	Peak-to-Peak output common mode voltage			50		mVpp
$V_{OD}$	Differential output voltage (WSON)	$T_A = -40^\circ\text{C}$ to $+125^\circ\text{C}$	250	350	450	mV
$V_{OD}$	Differential output voltage (DSBGA)	$T_A = -40^\circ\text{C}$ to $+125^\circ\text{C}$	240	350	450	mV
$\Delta V_{OD}$	Differential output voltage mismatch	$T_A = -40^\circ\text{C}$ to $+125^\circ\text{C}$	-30		30	mV
<b>Power Supply</b>						
$I_Q$ (TLV3801)	Quiescent current per comparator	$T_A = -40^\circ\text{C}$ to $+125^\circ\text{C}$		20	26.6	mA
$I_Q$ (TLV3811(C))	Quiescent current per comparator	$T_A = -40^\circ\text{C}$ to $+125^\circ\text{C}$		17	23	mA

## 6.5 Electrical Characteristics (continued)

 For  $V_{CC} = 3.3\text{ V}$ ,  $V_{EE} = \text{GND} = 0$ ,  $V_{CM} = 2.5\text{ V}$  at  $T_A = 25^\circ\text{C}$  (Unless otherwise noted)

PARAMETER		TEST CONDITIONS	MIN	TYP	MAX	UNIT
$I_Q$ (TLV3802)	Quiescent current per comparator	$T_A = -40^\circ\text{C}$ to $+125^\circ\text{C}$		19	23.5	mA
<b>AC Characteristics</b>						
$t_{PD}$	Propagation delay	$V_{OVERDRIVE} = 50\text{ mV}$ , $V_{UNDERDRIVE} = 50\text{ mV}$ , 50 MHz Squarewave		225		ps
Tempco of $t_{PD}$	Temperature Coefficient of propagation delay			$\pm 0.2$		ps/ $^\circ\text{C}$
$t_{PD\_SKEW}$	Propagation delay skew	$V_{OVERDRIVE} = 50\text{ mV}$ , $V_{UNDERDRIVE} = 50\text{ mV}$ , 50 MHz Squarewave		$\pm 2.5$		ps
$\Delta t_{PD}$ (TLV3802 only)	Channel-to-channel propagation delay skew	$V_{OVERDRIVE} = V_{UNDERDRIVE} = 50\text{ mV}$ , 50 MHz Squarewave		6		ps
$t_{CM\_DISPERSION}$	Common mode dispersion	$V_{CM}$ varied from $V_{CM}(\text{min})$ to $V_{CM}(\text{max})$		2		ps
$t_{OD\_DISPERSION}$	Overdrive dispersion	Overdrive varied from 20 mV to 100 mV		5		ps
$t_{OD\_DISPERSION}$	Overdrive dispersion	Overdrive varied from 10 mV to 1 V		15		ps
$t_{UD\_DISPERSION}$	Underdrive dispersion	Underdrive varied from 20 mV to 100 mV		7		ps
$t_{UD\_DISPERSION}$	Underdrive dispersion	Underdrive varied from 10 mV to 1 V		10		ps
$t_R$	Rise time	20% to 80%		135		ps
$t_F$	Fall time	80% to 20%		135		ps
$f_{TOGGLE}$	Input toggle frequency	$V_{IN} = 200\text{ mV}_{PP}$ Sine Wave, $V_{OD} = 550\text{ mV}$		2.3		GHz
$f_{TOGGLE}$	Input toggle frequency	$V_{IN} = 200\text{ mV}_{PP}$ Sine Wave, 50% Output swing		3		GHz
TR	Toggle Rate	$V_{IN} = 200\text{ mV}_{PP}$ Sine Wave, $V_{OD} = 550\text{ mV}$		4.6		Gbps
TR	Toggle Rate	$V_{IN} = 200\text{ mV}_{PP}$ Sine Wave, 50% Output swing		6		Gbps
PulseWidth	Minimum allowed input pulse width	$V_{OVERDRIVE} = V_{UNDERDRIVE} = 50\text{ mV}$ $PW_{OUT} = 90\%$ of $PW_{IN}$		240		ps

(1) Ensured by characterization



## 6.6 Timing Diagrams

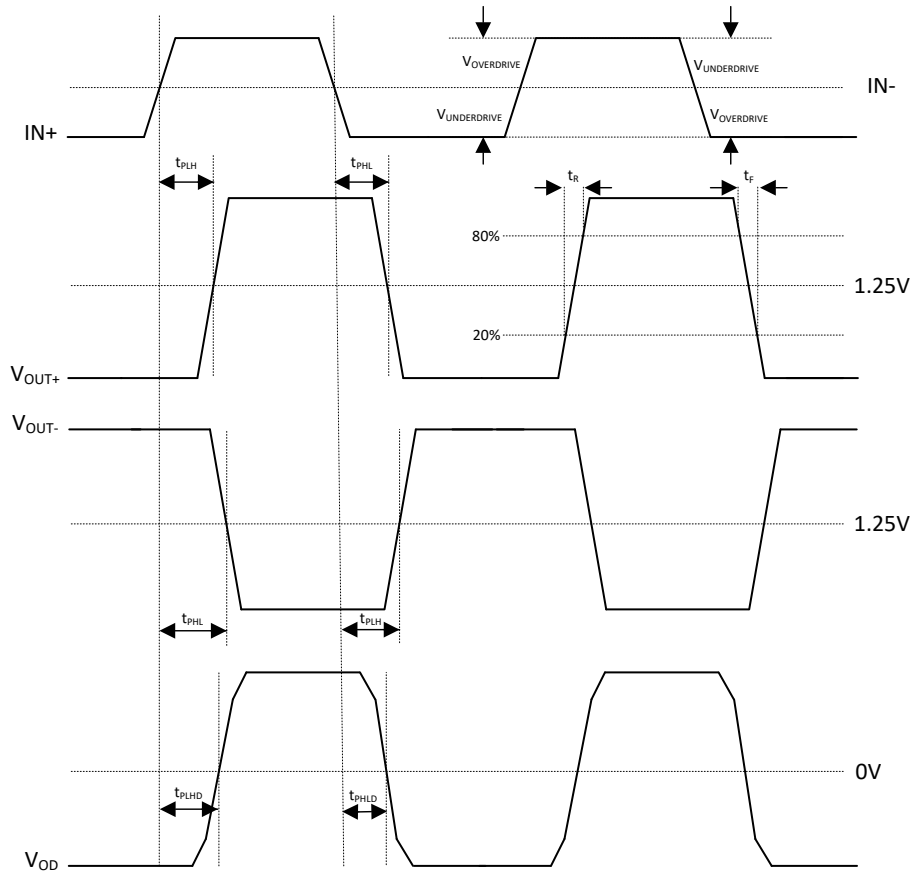

**Figure 6-1. General Timing Diagram**

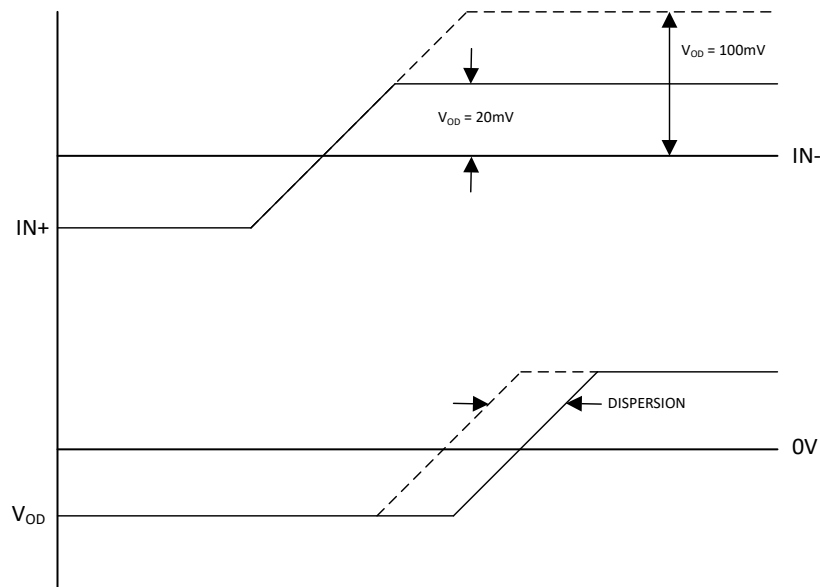

**Figure 6-2. Overdrive Dispersion**

## 6.7 Typical Characteristics

At  $T_A = 25^\circ\text{C}$ ,  $V_{CC} - V_{EE} = 3.3\text{ V}$  to  $5\text{ V}$  while  $V_{EE} = \text{GND} = 0$ ,  $V_{CM} = 2.5\text{ V}$ , and input overdrive/underdrive =  $50\text{ mV}$ , unless otherwise noted.

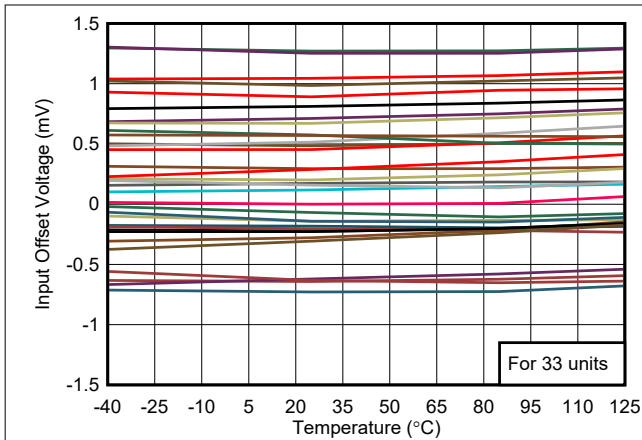

**Figure 6-3. Offset vs. Temperature**

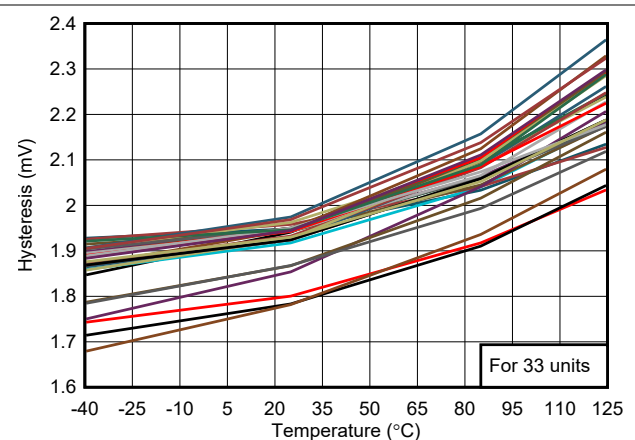

**Figure 6-4. TLV3801 Hysteresis vs. Temperature**

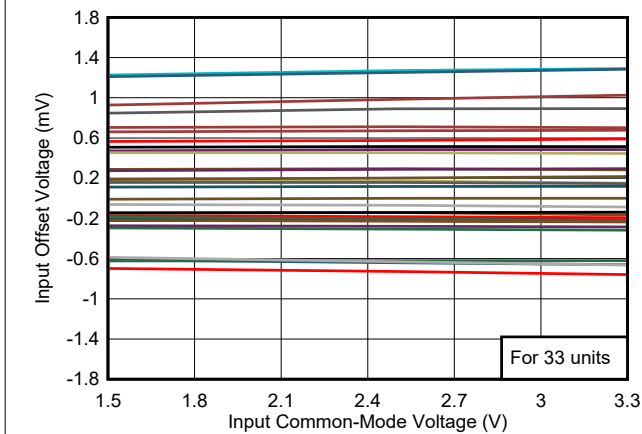

**Figure 6-5. Offset vs. Common-Mode, 3.3 V**

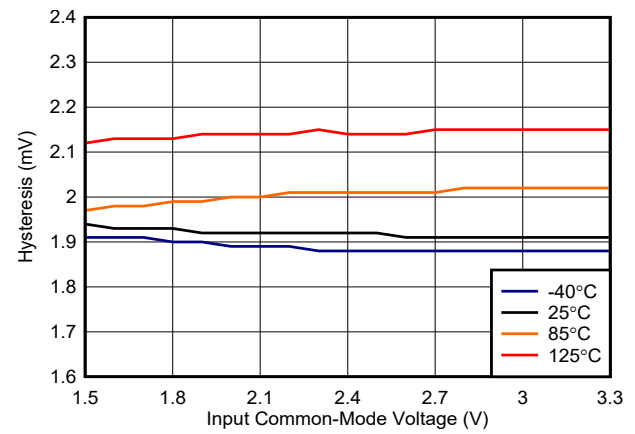

**Figure 6-6. TLV3801 Hysteresis vs. Common-Mode, 3.3 V**

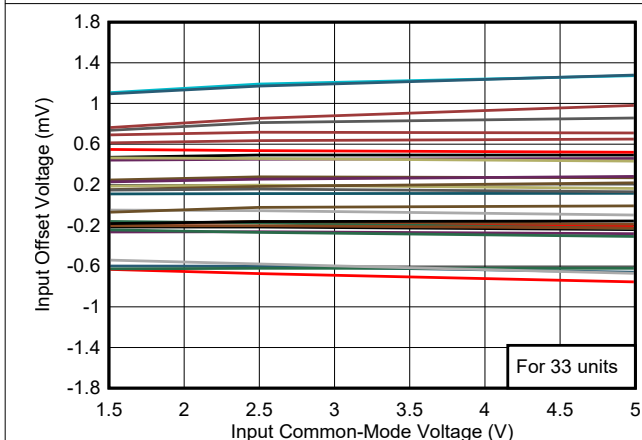

**Figure 6-7. Offset vs. Common-Mode, 5 V**

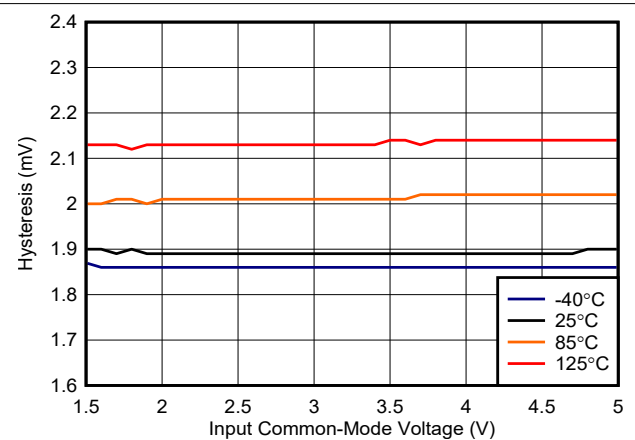

**Figure 6-8. TLV3801 Hysteresis vs. Common-Mode, 5 V**

### 6.7 Typical Characteristics (continued)

At  $T_A = 25^\circ\text{C}$ ,  $V_{CC} - V_{EE} = 3.3\text{ V}$  to  $5\text{ V}$  while  $V_{EE} = \text{GND} = 0$ ,  $V_{CM} = 2.5\text{ V}$ , and input overdrive/underdrive =  $50\text{ mV}$ , unless otherwise noted.

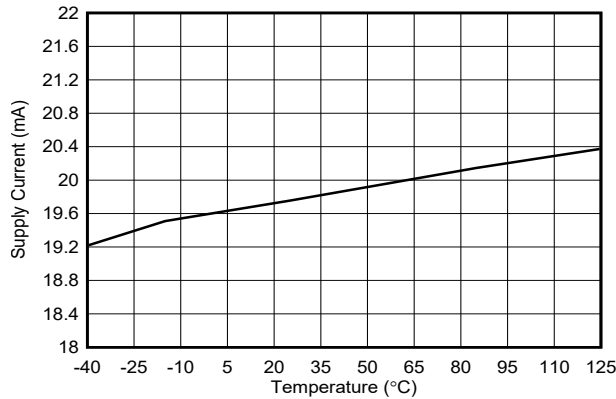

**Figure 6-9. TLV3801 Supply Current vs. Temperature**

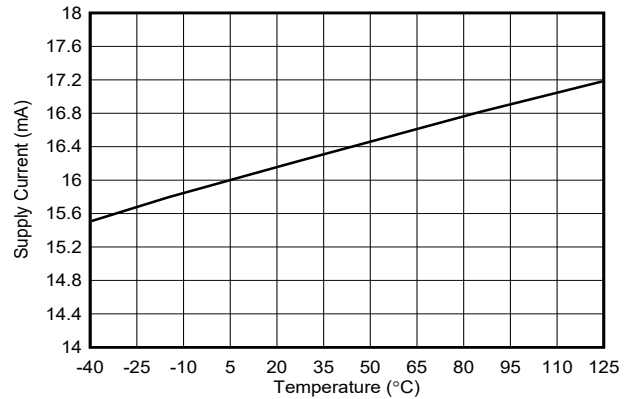

**Figure 6-10. TLV3811(C) Supply Current vs. Temperature**

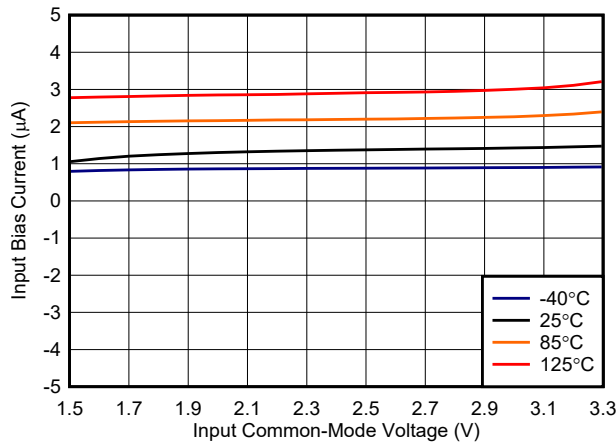

**Figure 6-11. Bias Current vs. Common-Mode, 3.3 V**

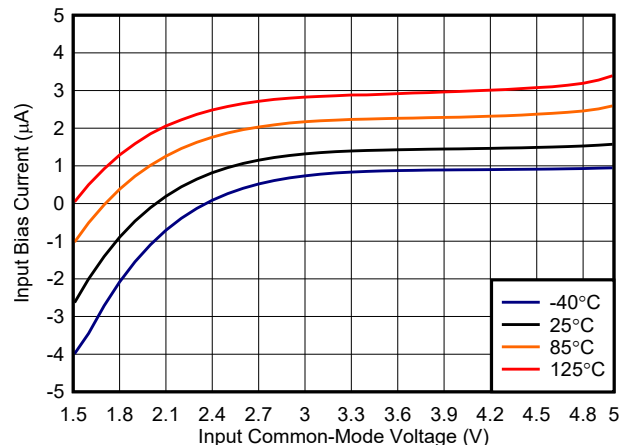

**Figure 6-12. Bias Current vs. Common-Mode, 5 V**

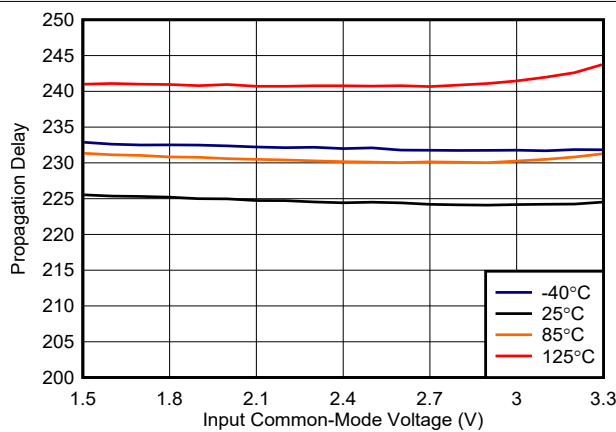

**Figure 6-13. Propagation Delay vs. Common-Mode, 3.3 V**

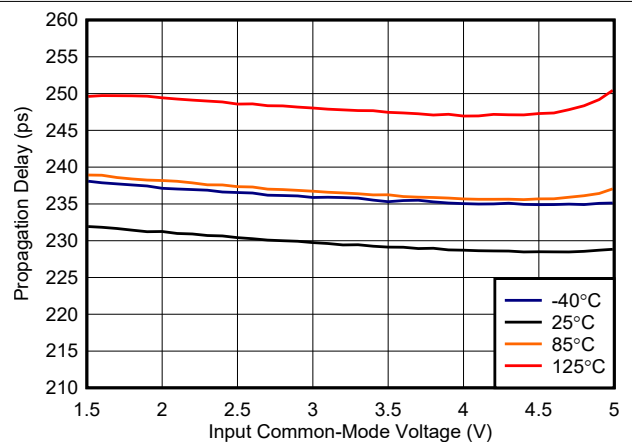

**Figure 6-14. Propagation Delay vs. Common-Mode, 5 V**

### 6.7 Typical Characteristics (continued)

At  $T_A = 25^\circ\text{C}$ ,  $V_{CC} - V_{EE} = 3.3\text{ V}$  to  $5\text{ V}$  while  $V_{EE} = \text{GND} = 0$ ,  $V_{CM} = 2.5\text{ V}$ , and input overdrive/underdrive =  $50\text{ mV}$ , unless otherwise noted.

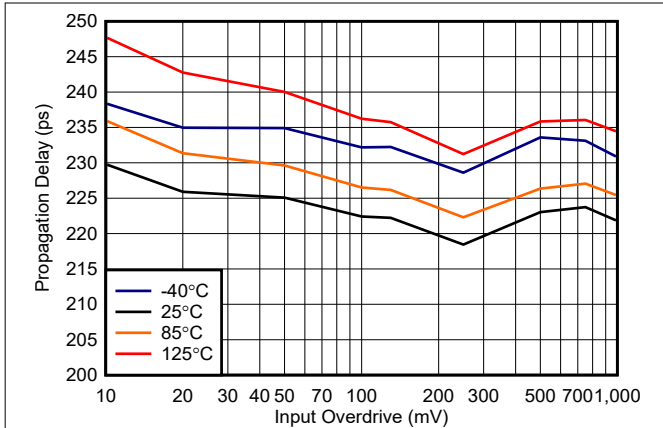

Figure 6-15. Propagation Delay vs. Overdrive, 3.3 V

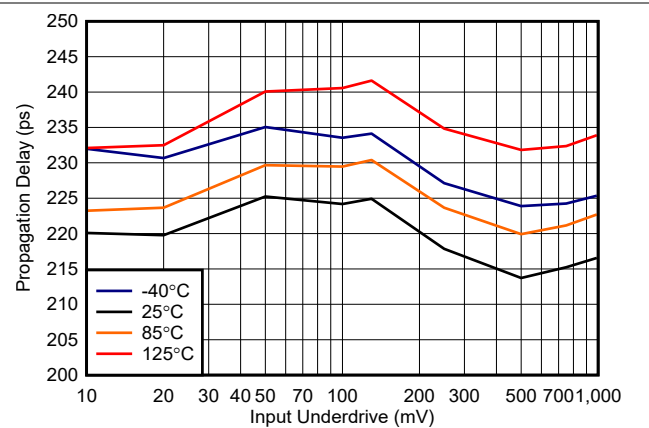

Figure 6-16. Propagation Delay vs. Underdrive, 3.3 V

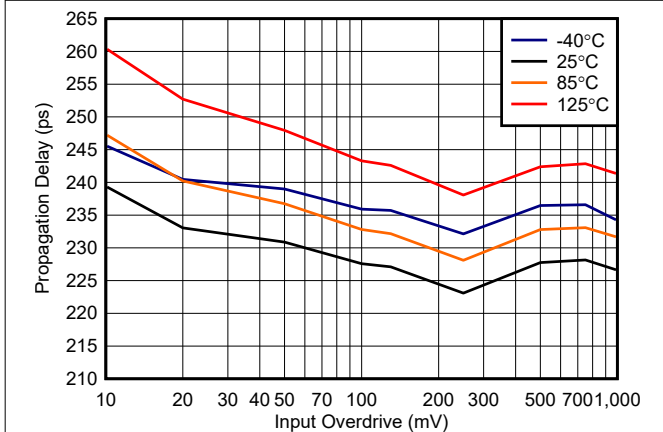

Figure 6-17. Propagation Delay vs. Overdrive, 5 V

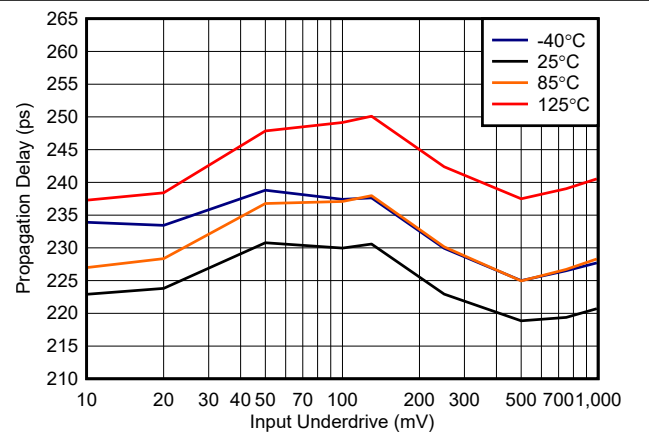

Figure 6-18. Propagation Delay vs. Underdrive, 5 V

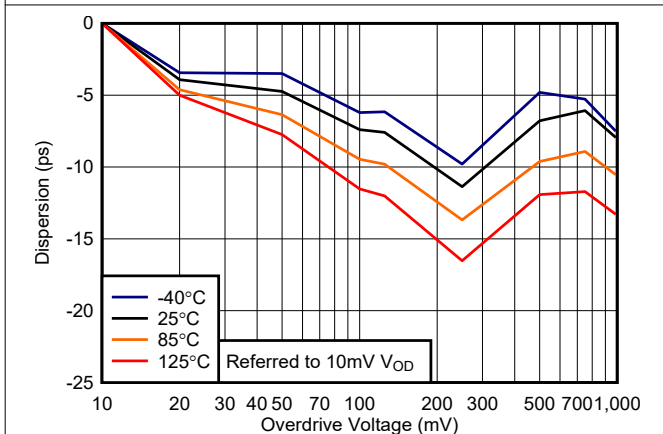

Figure 6-19. Dispersion vs. Overdrive, 3.3 V

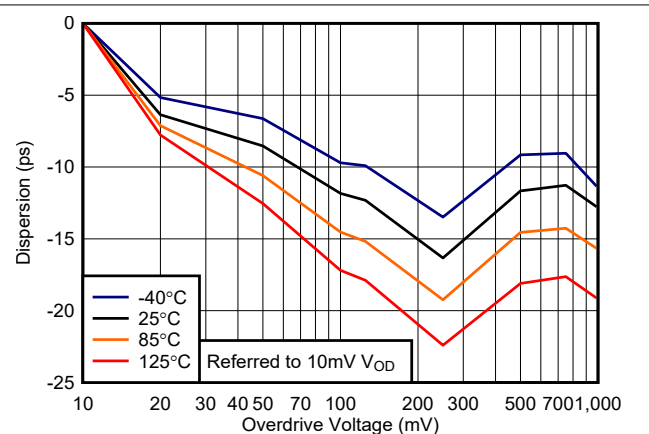
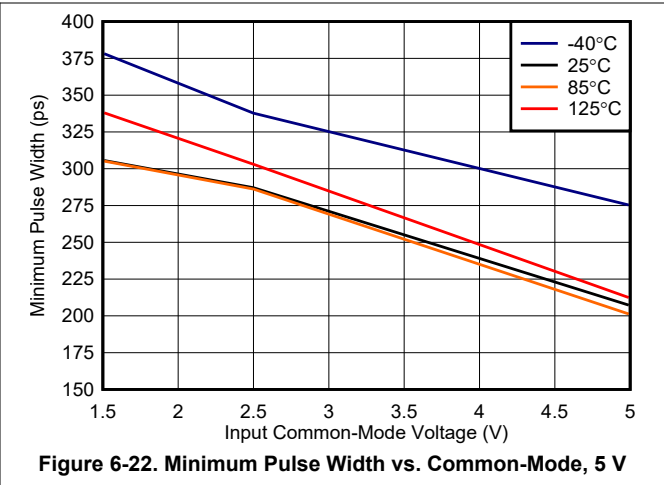
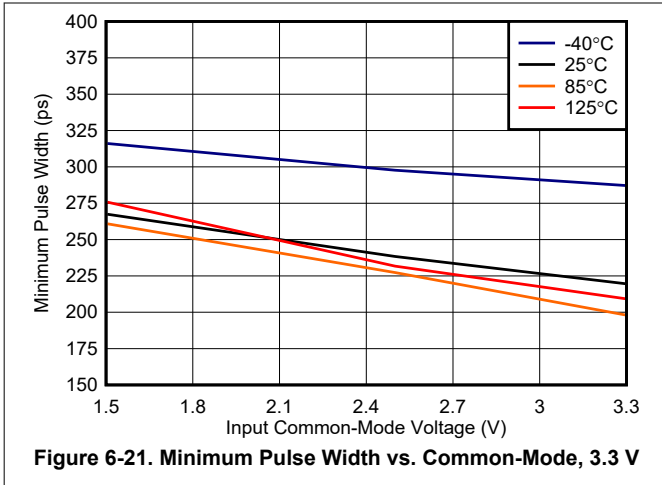

Figure 6-20. Dispersion vs. Overdrive, 5 V

### 6.7 Typical Characteristics (continued)

At  $T_A = 25^\circ\text{C}$ ,  $V_{CC} - V_{EE} = 3.3\text{ V}$  to  $5\text{ V}$  while  $V_{EE} = \text{GND} = 0$ ,  $V_{CM} = 2.5\text{ V}$ , and input overdrive/underdrive =  $50\text{ mV}$ , unless otherwise noted.



## 7 Detailed Description

### 7.1 Overview

The TLV380x/TLV3811(C) are high-speed comparators with LVDS output. The fast response time of these comparators make them well suited for applications that require narrow pulse width detection or high toggle frequencies. The TLV3801 is available in the 8-pin WSON package and the TLV3802 is available in the 12-pin WSON package while the TLV3811(C) is available in the 6-pin DSBGA package.

### 7.2 Functional Block Diagram

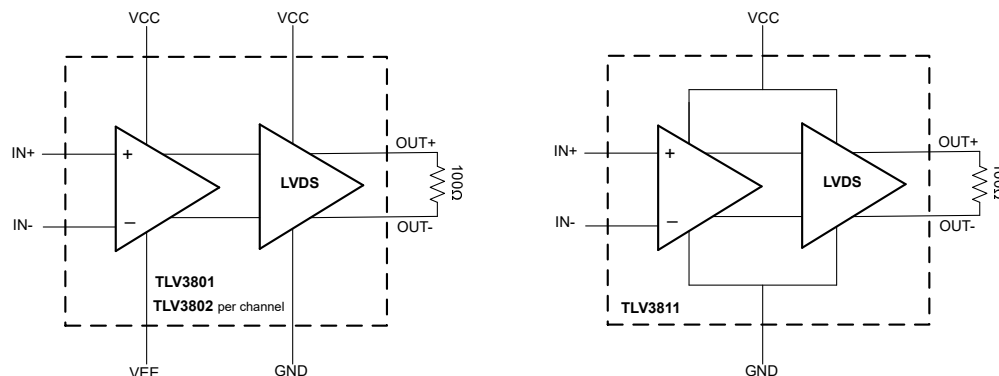

### 7.3 Feature Description

The TLV380x/TLV3811(C) are high-speed comparators with a typical propagation delay of 225 ps and LVDS output. The minimum pulse width detection capability is 240 ps and the typical toggle frequency is 3 GHz (6 Gbps). These comparators are well suited for distance sensing for LIDAR and time-of-flight applications as well as for high-speed test and measurement systems. The TLV380x has two separate power rails for the input and the output; this allows the input to be referenced from either single or split supply (VCC and VEE) while the output is referenced from ground (VCC and GND). On the other hand, the TLV3811(C) has one power rail for both inputs and outputs and can only be operated at a single supply.

### 7.4 Device Functional Modes

The TLV380x has a single functional mode and is operational on the condition that both the input supply voltage (VCC - VEE) is greater than or equal to 2.7 V and the output supply voltage (VCC - GND) is greater than or equal to 2.4 V.

The TLV3811(C) has a single functional mode and is operational when the power supply voltage (VCC - GND) is greater than or equal to 2.7 V.

#### 7.4.1 Inputs

The TLV380x/TLV3811(C) feature an input stage, capable of operating between 1.5 V above VEE (GND for TLV3811(C)) and 0.1 V above VCC, with an internal ESD protection circuit that includes two pairs of front-to-back diodes between IN+ and IN- as well as two 50 Ω resistors, as shown in [Figure 7-1](#). This prevents damage to the input stage by limiting the differential input voltage to be no more than twice the diode's forward-voltage drop  $2 \times V_F$  ( $2 \times 0.7$  V).

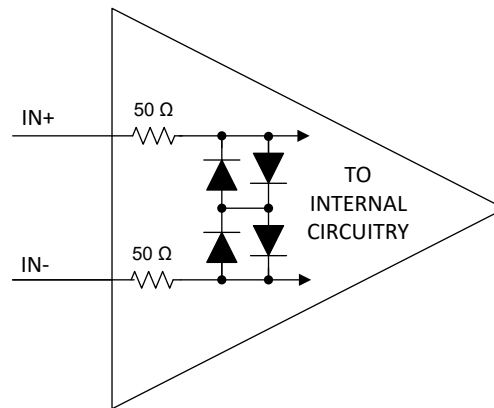

**Figure 7-1. Input Stage Circuitry**

When the differential input voltage exceeds  $2 \times V_F$ , the input bias current increases at the input pins IN+ and IN-, as shown in [Equation 1](#).

$$\text{Input Current} = [(V_{IN+} - V_{IN-}) - 2 \times V_F] / (2 \times 50) \quad (1)$$

To avoid damaging the inputs when exceeding the recommended input voltage range, an external resistor should be used to limit the current. The current should be limited to less than 10 mA.

#### 7.4.2 LVDS Output

The TLV380x/TLV3811(C) outputs are LVDS compliant. When the input of the downstream device is terminated with a 100  $\Omega$  resistor, the comparators provide a  $\pm 350$  mV differential swing at an output common-mode voltage of 1.25 V above GND. Fully differential outputs enable fast digital toggling and reduce EMI compared to single-ended output standards.

## 8 Application and Implementation

---

### Note

Information in the following applications sections is not part of the TI component specification, and TI does not warrant its accuracy or completeness. TI's customers are responsible for determining suitability of components for their purposes, as well as validating and testing their design implementation to confirm system functionality.

---

### 8.1 Application Information

#### 8.1.1 Capacitive Loads

Under reasonable capacitive loads, the device maintains specified propagation delay. However, excessive capacitive loading under high switching frequencies may increase supply current, propagation delay, or induce decreased slew rate.

#### 8.1.2 Hysteresis

A comparator's high, open-loop gain creates a small band of input differential voltage where the comparator may produce "chatter" which causes the output to toggle back and forth between a "logic high" and a "logic low". This can cause design challenges for inputs with slow rise and fall times or systems with excessive noise. These challenges can be prevented by adding hysteresis to the comparator. However, hysteresis must be added strategically when input signals are small since it can cause signals to go undetected. As a result, TLV3811C is optimized for detecting small, fast-switching inputs and has 0 mV of internal hysteresis. On the other hand, for detecting larger input signals in the presence of noise, the TLV3811 has 1.1 mV of internal hysteresis and TLV3801 and TLV3802 have 2 mV.

Since the TLV380x/TLV3811(C) only have a minimal amount of internal hysteresis, external hysteresis can be applied in the form of a positive feedback loop that adjusts the trip point of the comparator depending on its current output state. See the [Non-Inverting Comparator With Hysteresis](#) section for more details.

### 8.2 Typical Application

#### 8.2.1 Optical Receiver

The TLV380x/TLV3811(C) can be used in conjunction with a high performance amplifier such as the OPA858 to create an optical receiver as shown in the [Figure 8-1](#). The photodiode operates in photoconductive mode: exposure to light will cause a reverse current through the photodiode. A bias voltage is applied to the op amp's non-inverting input to prevent saturation at the negative power supply. The OPA858 takes the current conducting through the diode and translates it into a voltage for a high speed comparator to detect. The TLV380x/TLV3811(C) will then output the proper LVDS signal according to the threshold set ( $V_{REF}$ ).



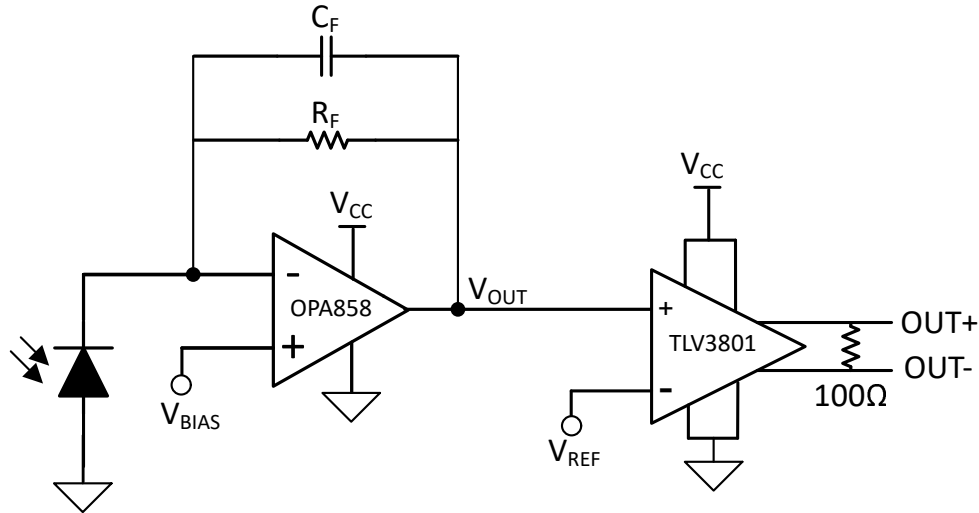

**Figure 8-1. Optical Receiver**

### 8.2.1.1 Design Requirements

**Table 8-1. Design Parameters**

PARAMETER	VALUE
$V_{CC}$	+5 V
$V_{EE}$	0 V
$V_{OUT, SWING}$	100 mV
$I_{DIODE}$	100 $\mu$ A
$f_p$	159 MHz

### 8.2.1.2 Detailed Design Procedure

Set  $V_{BIAS}$  to be in the recommended common-mode voltage range of the OPA858. This is also the minimum output voltage of the op amp  $V_{OUT, MIN}$  as the op amp will attempt to settle at the voltage applied to the non-inverting input.

The maximum output voltage of the op amp  $V_{OUT, MAX}$  can be calculated from the desired output voltage swing  $V_{OUT, SWING}$  and  $V_{OUT, MIN}$ , as shown in [Equation 2](#).

$$V_{OUT, MAX} = V_{OUT, SWING} + V_{OUT, MIN} \quad (2)$$

The gain resistor  $R_F$  is determined by the desired  $V_{OUT, MAX}$  and  $V_{OUT, MIN}$  and the maximum current  $I_{DIODE}$  through the diode, as shown in [Equation 2](#).

$$R_F = (V_{OUT, MAX} - V_{OUT, MIN}) / I_{DIODE} \quad (3)$$

The feedback capacitor, in combination with the gain resistor, forms a pole in the frequency response of the amplifier. The feedback capacitor can be determined by the gain resistor and the desired pole frequency  $f_p$ , as shown in [Equation 2](#).

$$C_F = 1 / (2 \times \pi \times R_F \times f_p) \quad (4)$$

Set  $V_{REF}$  to be the switching threshold voltage between  $V_{OUT, MAX}$  and  $V_{OUT, MIN}$ .

Select values for  $V_{BIAS}$  and  $V_{REF}$ . Plug in given values for  $V_{OUT, MAX}$ ,  $I_{DIODE}$ , and  $f_p$ . For the given example,  $V_{BIAS} = 1.5$  V,  $V_{REF} = 1.55$  V, and  $R_F$ ,  $C_F$  is solved as 1 k $\Omega$  and 1 pF, respectively.

For more information, please refer to the op amp tutorials for stability analysis on the transimpedance amplifier [Spice Stability Analysis](#) and [Op Amp Stability](#). See application note SBOA268A [Transimpedance Amplifier Circuit](#) for more detailed procedures.

### 8.2.1.3 Application Performance Plots

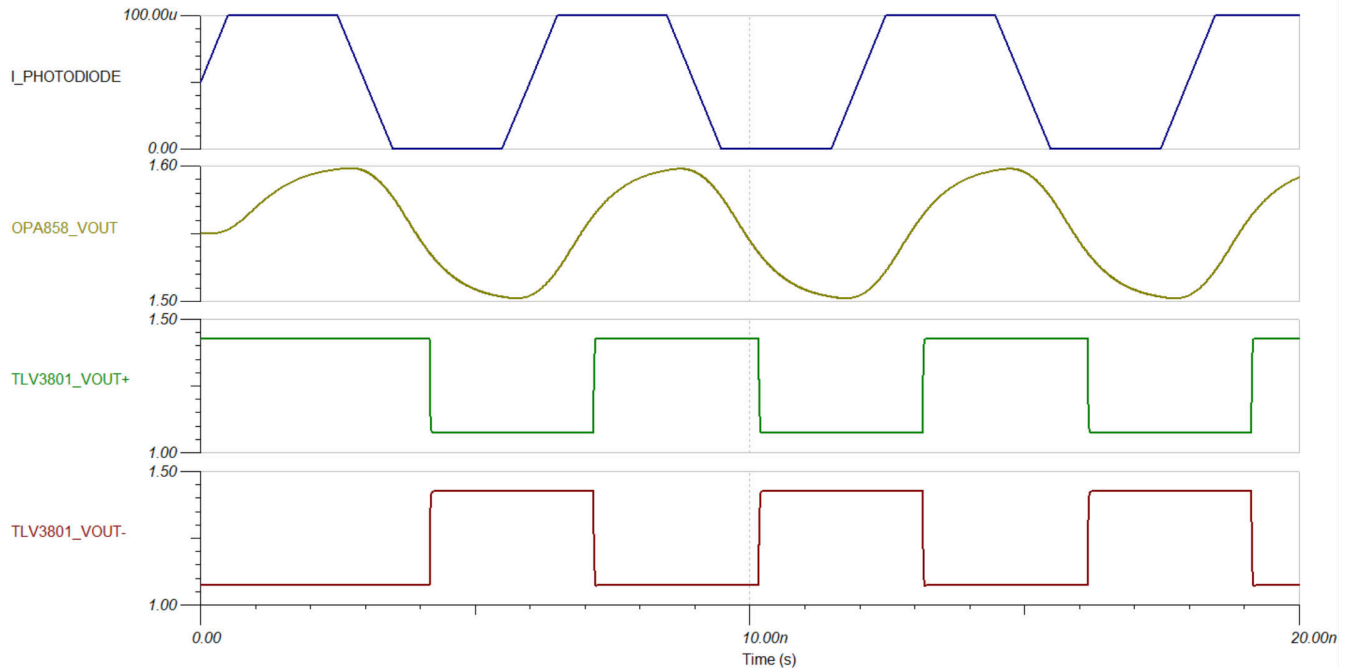

Figure 8-2. Optical Receiver Output Waveforms

### 8.2.2 Non-Inverting Comparator With Hysteresis

A way to implement external hysteresis is to add two resistors to the circuit: one in series between the reference voltage and the inverting pin, and another from the inverting pin to one of the differential output pins.

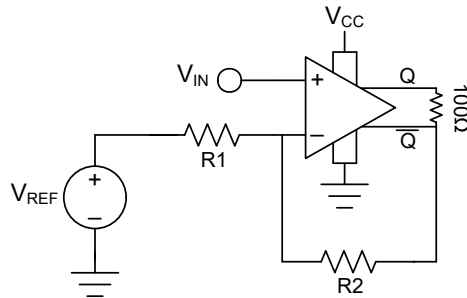

Figure 8-3. Non-Inverting Comparator with Hysteresis Circuit

#### 8.2.2.1 Design Requirements

Table 8-2. Design Parameters

PARAMETER	VALUE
$V_{HYS}$	50 mV
$V_{REF}$	2.5 V
$V_{T1}$	2.34 V
$V_{T2}$	2.29 V

**Table 8-2. Design Parameters (continued)**

PARAMETER	VALUE
Q	1.375 V
$\bar{Q}$	1.025 V

### 8.2.2.2 Detailed Design Procedure

First, create an equation for  $V_T$  that covers both output voltages when the output is high or low.

$$V_{T1} = \frac{V_{REF}R_2 + QR_1}{R_1 + R_2} \quad (5)$$

$$V_{T2} = \frac{V_{REF}R_2 + \bar{Q}R_1}{R_1 + R_2} \quad (6)$$

The hysteresis voltage in this network is equal to the difference in the two threshold voltage equations.

$$V_{HYS} = V_{T1} - V_{T2} \quad (7)$$

$$V_{HYS} = \frac{V_{REF}R_2 + QR_1}{R_1 + R_2} - \frac{V_{REF}R_2 + \bar{Q}R_1}{R_1 + R_2} \quad (8)$$

$$V_{HYS} = \frac{(Q - \bar{Q})R_1}{R_1 + R_2} \quad (9)$$

$$V_{HYS} = \frac{V_{OD}R_1}{R_1 + R_2} \quad (10)$$

Note that these equations do not take into account the effects of the internal hysteresis and offset voltage of the comparator. Design parameters will need to be adjusted accordingly.

Select a value for  $R_2$ . Plug in given values for  $V_{REF}$ ,  $V_{T1}$ ,  $V_{T2}$ ,  $Q$ , and  $\bar{Q}$ , and solve for  $R_1$ . For the given example,  $R_2 = 50 \text{ k}\Omega$ , and  $R_1$  is solved as  $= 8.3 \text{ k}\Omega$ .

### 8.2.2.3 Application Performance Plots

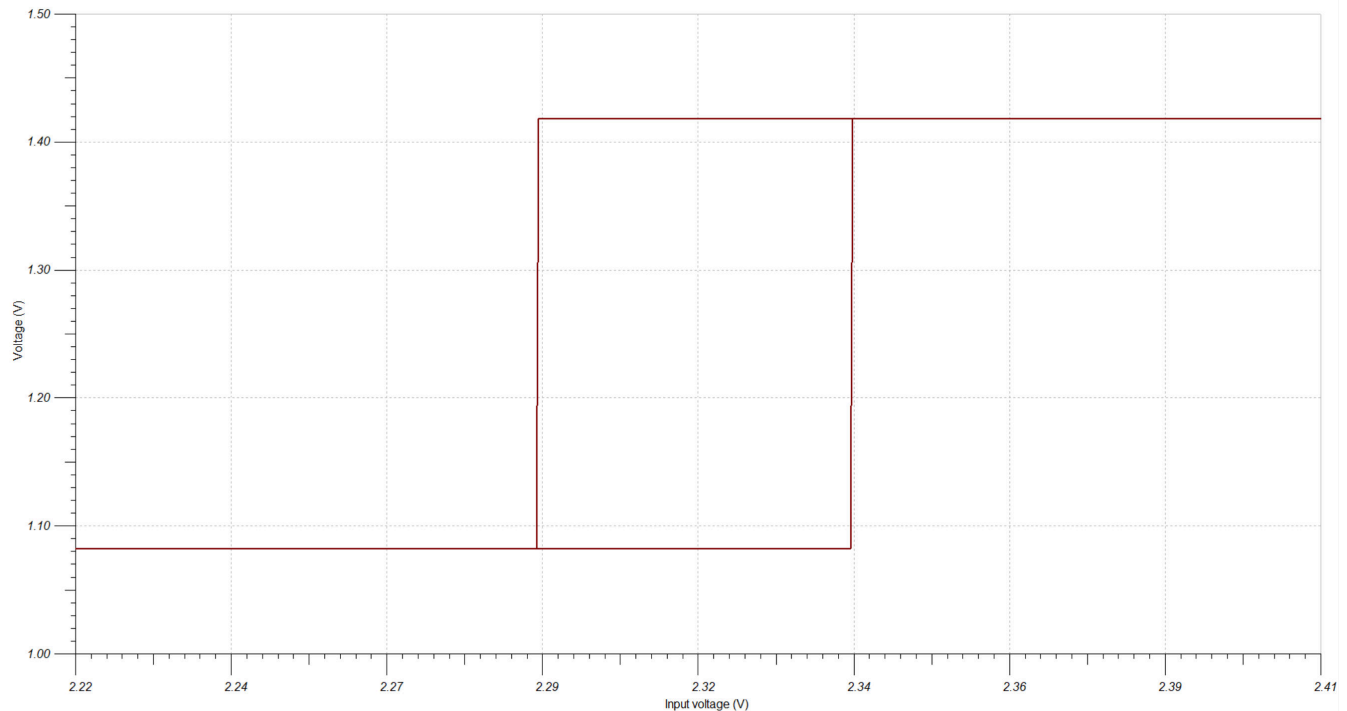

Figure 8-4. Hysteresis Curve for LVDS Comparator

### 8.2.3 Logic Clock Source to LVDS Transceiver

The Figure 8-5 shows a logic clock source being terminated and driven with the TLV3802/TLV3811(C) across a CAT6 Cable to receive an equivalent LVDS clock signal at the receiver end.

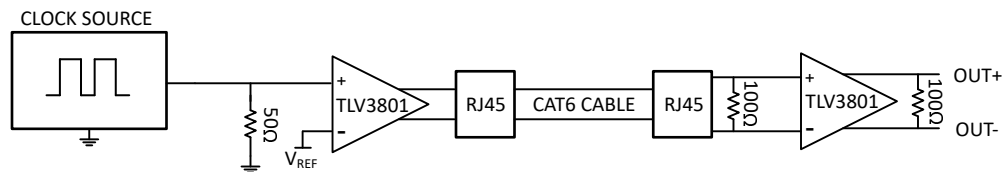
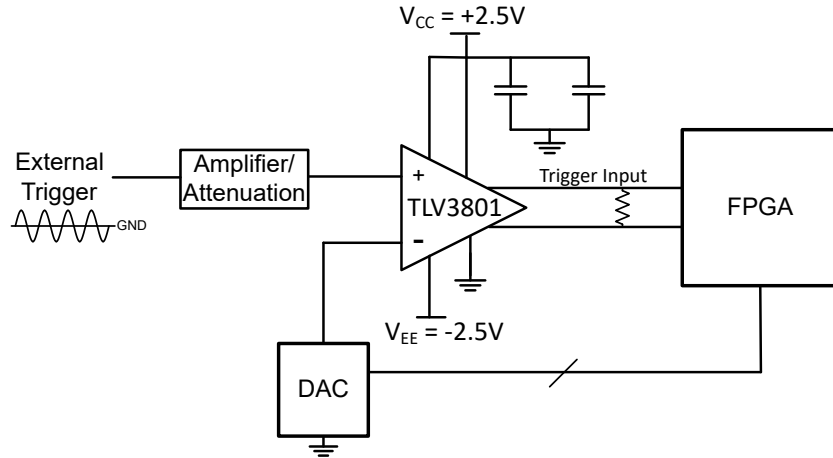

Figure 8-5. LVDS Clock Transceiver

### 8.2.4 External Trigger Function for Oscilloscopes

Figure 8-6 is a typical configuration for creating an external trigger on oscilloscopes. The user adjusts the trigger level, and a DAC converts this trigger level to a voltage the TLV380x/TLV3811(C) can use as a reference. The input voltage from an oscilloscope channel is then compared to the trigger reference voltage, and the TLV380x/TLV3811(C) sends an LVDS signal to a downstream FPGA to begin a capture. It is common to see bipolar inputs in test and measurement systems such as oscilloscopes; therefore, the TLV380x can be configured in split supply so that the inputs are in the allowable input voltage range.



**Figure 8-6. External Trigger Function**

### 8.3 Power Supply Recommendations

The TLV380x has two separate power rails: VCC - VEE for the input stage and VCC - GND for the output stage. This allows for both single and split supply capabilities for the input stage with a separate ground reference for the LVDS output stage. Split supply operation allows users to apply both positive and negative (bipolar) voltages to the input pins.

When operating from a single supply, the supply voltage range for both the input and output stage is 2.7 V to 5.25 V. When operating from split supply rails, the supply voltage range for the input stage (VCC - VEE) is 2.7 V to 5.25 V, and the supply voltage range for the output stage (VCC - GND) is 2.4 V to 5.25 V. The output logic level is independent of the VCC and VEE levels. The TLV3811(C) is specified for operation from 2.4 V to 5.25 V and can only be operated from a single supply with both inputs and outputs referenced to GND.

Regardless of single supply or split supply operation, proper decoupling capacitors are required. It is recommended to use a scheme of multiple, low-ESR ceramic capacitors from the supply pins to the ground plane for optimum performance. A good combination would be 100 pF, 10 nF, and 1 uF with the lowest value capacitor closest to the comparator.

## 8.4 Layout

### 8.4.1 Layout Guidelines

Comparators are very sensitive to input noise. For best results, adhere to the following layout guidelines.

1. Use a printed-circuit-board (PCB) with a good, unbroken, low-inductance ground plane. Proper grounding (use of a ground plane) helps maintain specified device performance.
2. To minimize supply noise for single and split supply, place decoupling capacitor arrays as close as possible to  $V_{CC}$ .
3. On the inputs and the output, keep lead lengths as short as possible to avoid unwanted parasitic feedback around the comparator. Keep inputs away from the output.
4. Solder the device directly to the PCB rather than using a socket.
5. For slow-moving input signals, take care to prevent parasitic feedback. A small capacitor (1000 pF or less) placed between the inputs can help eliminate oscillations in the transition region. This capacitor causes some degradation to propagation delay when impedance is low. The topside ground plane runs between the output and inputs.
6. Use a 100  $\Omega$  termination resistor across the device's LVDS output.
7. Use higher performance substrate materials such as Rogers.

### 8.4.2 Layout Example

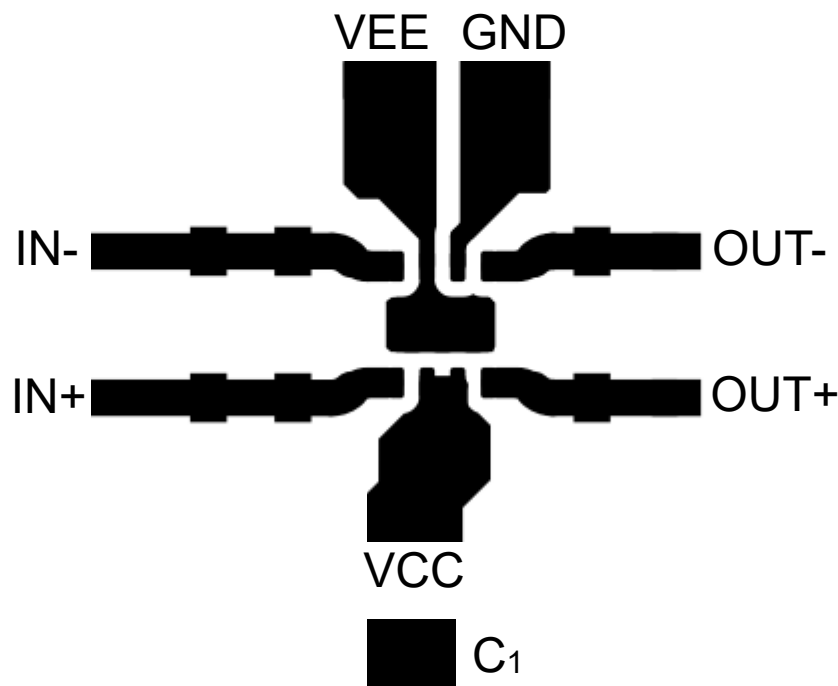

Figure 8-7. TLV3801EVM Layout Example

## 9 Device and Documentation Support

### 9.1 Device Support

#### 9.1.1 Development Support

[LIDAR Pulsed Time of Flight Reference Design](#)

### 9.2 Receiving Notification of Documentation Updates

To receive notification of documentation updates, navigate to the device product folder on [ti.com](#). Click on *Notifications* to register and receive a weekly digest of any product information that has changed. For change details, review the revision history included in any revised document.

### 9.3 Support Resources

[TI E2E™ support forums](#) are an engineer's go-to source for fast, verified answers and design help — straight from the experts. Search existing answers or ask your own question to get the quick design help you need.

Linked content is provided "AS IS" by the respective contributors. They do not constitute TI specifications and do not necessarily reflect TI's views; see TI's [Terms of Use](#).

### 9.4 Trademarks

TI E2E™ is a trademark of Texas Instruments.  
All trademarks are the property of their respective owners.

### 9.5 Electrostatic Discharge Caution



This integrated circuit can be damaged by ESD. Texas Instruments recommends that all integrated circuits be handled with appropriate precautions. Failure to observe proper handling and installation procedures can cause damage.

ESD damage can range from subtle performance degradation to complete device failure. Precision integrated circuits may be more susceptible to damage because very small parametric changes could cause the device not to meet its published specifications.

### 9.6 Glossary

[TI Glossary](#) This glossary lists and explains terms, acronyms, and definitions.

## 10 Mechanical, Packaging, and Orderable Information

The following pages include mechanical, packaging, and orderable information. This information is the most current data available for the designated devices. This data is subject to change without notice and revision of this document. For browser-based versions of this data sheet, refer to the left-hand navigation.

**PACKAGING INFORMATION**

Orderable Device	Status (1)	Package Type	Package Drawing	Pins	Package Qty	Eco Plan (2)	Lead finish/ Ball material (6)	MSL Peak Temp (3)	Op Temp (°C)	Device Marking (4/5)	Samples
TLV3801DSGR	ACTIVE	WSON	DSG	8	3000	RoHS & Green	SN	Level-2-260C-1 YEAR	-40 to 125	3801	<a href="#">Samples</a>
TLV3801DSGT	ACTIVE	WSON	DSG	8	250	RoHS & Green	SN	Level-2-260C-1 YEAR	-40 to 125	3801	<a href="#">Samples</a>
TLV3802DSSR	ACTIVE	WSON	DSS	12	3000	RoHS & Green	SN	Level-2-260C-1 YEAR	-40 to 125	3802	<a href="#">Samples</a>
TLV3811CYBGR	ACTIVE	DSBGA	YBG	6	3000	RoHS & Green	SNAGCU	Level-1-260C-UNLIM	-40 to 125	02	<a href="#">Samples</a>
TLV3811CYBGT	ACTIVE	DSBGA	YBG	6	250	RoHS & Green	SNAGCU	Level-1-260C-UNLIM	-40 to 125	02	<a href="#">Samples</a>
TLV3811YBGR	ACTIVE	DSBGA	YBG	6	3000	RoHS & Green	SNAGCU	Level-1-260C-UNLIM	-40 to 125	LQ	<a href="#">Samples</a>
TLV3811YBGT	ACTIVE	DSBGA	YBG	6	250	RoHS & Green	SNAGCU	Level-1-260C-UNLIM	-40 to 125	LQ	<a href="#">Samples</a>

(1) The marketing status values are defined as follows:

**ACTIVE:** Product device recommended for new designs.

**LIFEBUY:** TI has announced that the device will be discontinued, and a lifetime-buy period is in effect.

**NRND:** Not recommended for new designs. Device is in production to support existing customers, but TI does not recommend using this part in a new design.

**PREVIEW:** Device has been announced but is not in production. Samples may or may not be available.

**OBSOLETE:** TI has discontinued the production of the device.

(2) **RoHS:** TI defines "RoHS" to mean semiconductor products that are compliant with the current EU RoHS requirements for all 10 RoHS substances, including the requirement that RoHS substance do not exceed 0.1% by weight in homogeneous materials. Where designed to be soldered at high temperatures, "RoHS" products are suitable for use in specified lead-free processes. TI may reference these types of products as "Pb-Free".

**RoHS Exempt:** TI defines "RoHS Exempt" to mean products that contain lead but are compliant with EU RoHS pursuant to a specific EU RoHS exemption.

**Green:** TI defines "Green" to mean the content of Chlorine (Cl) and Bromine (Br) based flame retardants meet JS709B low halogen requirements of <=1000ppm threshold. Antimony trioxide based flame retardants must also meet the <=1000ppm threshold requirement.

(3) MSL, Peak Temp. - The Moisture Sensitivity Level rating according to the JEDEC industry standard classifications, and peak solder temperature.

(4) There may be additional marking, which relates to the logo, the lot trace code information, or the environmental category on the device.

(5) Multiple Device Markings will be inside parentheses. Only one Device Marking contained in parentheses and separated by a "~" will appear on a device. If a line is indented then it is a continuation of the previous line and the two combined represent the entire Device Marking for that device.



(6) Lead finish/Ball material - Orderable Devices may have multiple material finish options. Finish options are separated by a vertical ruled line. Lead finish/Ball material values may wrap to two lines if the finish value exceeds the maximum column width.

**Important Information and Disclaimer:**The information provided on this page represents TI's knowledge and belief as of the date that it is provided. TI bases its knowledge and belief on information provided by third parties, and makes no representation or warranty as to the accuracy of such information. Efforts are underway to better integrate information from third parties. TI has taken and continues to take reasonable steps to provide representative and accurate information but may not have conducted destructive testing or chemical analysis on incoming materials and chemicals. TI and TI suppliers consider certain information to be proprietary, and thus CAS numbers and other limited information may not be available for release.

In no event shall TI's liability arising out of such information exceed the total purchase price of the TI part(s) at issue in this document sold by TI to Customer on an annual basis.

**OTHER QUALIFIED VERSIONS OF TLV3801, TLV3802 :**

- Automotive : [TLV3801-Q1](#), [TLV3802-Q1](#)

NOTE: Qualified Version Definitions:

- Automotive - Q100 devices qualified for high-reliability automotive applications targeting zero defects

**TAPE AND REEL INFORMATION**

**QUADRANT ASSIGNMENTS FOR PIN 1 ORIENTATION IN TAPE**

\*All dimensions are nominal

Device	Package Type	Package Drawing	Pins	SPQ	Reel Diameter (mm)	Reel Width W1 (mm)	A0 (mm)	B0 (mm)	K0 (mm)	P1 (mm)	W (mm)	Pin1 Quadrant
TLV3801DSGR	WSO	DSG	8	3000	180.0	8.4	2.2	2.2	1.2	4.0	8.0	Q2
TLV3801DSGT	WSO	DSG	8	250	179.0	8.4	2.2	2.2	1.2	4.0	8.0	Q2
TLV3802DSSR	WSO	DSS	12	3000	180.0	8.4	2.3	3.2	1.0	4.0	8.0	Q1
TLV3811CYBGR	DSBGA	YBG	6	3000	180.0	8.4	0.87	1.27	0.6	2.0	8.0	Q2
TLV3811CYBGT	DSBGA	YBG	6	250	180.0	8.4	0.87	1.27	0.6	2.0	8.0	Q2
TLV3811YBGT	DSBGA	YBG	6	250	180.0	8.4	0.87	1.27	0.6	2.0	8.0	Q2

**TAPE AND REEL BOX DIMENSIONS**

\*All dimensions are nominal

Device	Package Type	Package Drawing	Pins	SPQ	Length (mm)	Width (mm)	Height (mm)
TLV3801DSGR	WSON	DSG	8	3000	213.0	191.0	35.0
TLV3801DSGT	WSON	DSG	8	250	213.0	191.0	35.0
TLV3802DSSR	WSON	DSS	12	3000	213.0	191.0	35.0
TLV3811CYBGR	DSBGA	YBG	6	3000	182.0	182.0	20.0
TLV3811CYBGT	DSBGA	YBG	6	250	182.0	182.0	20.0
TLV3811YBGT	DSBGA	YBG	6	250	182.0	182.0	20.0

## GENERIC PACKAGE VIEW

**DSG 8**

**WSON - 0.8 mm max height**

2 x 2, 0.5 mm pitch

PLASTIC SMALL OUTLINE - NO LEAD

This image is a representation of the package family, actual package may vary.  
Refer to the product data sheet for package details.

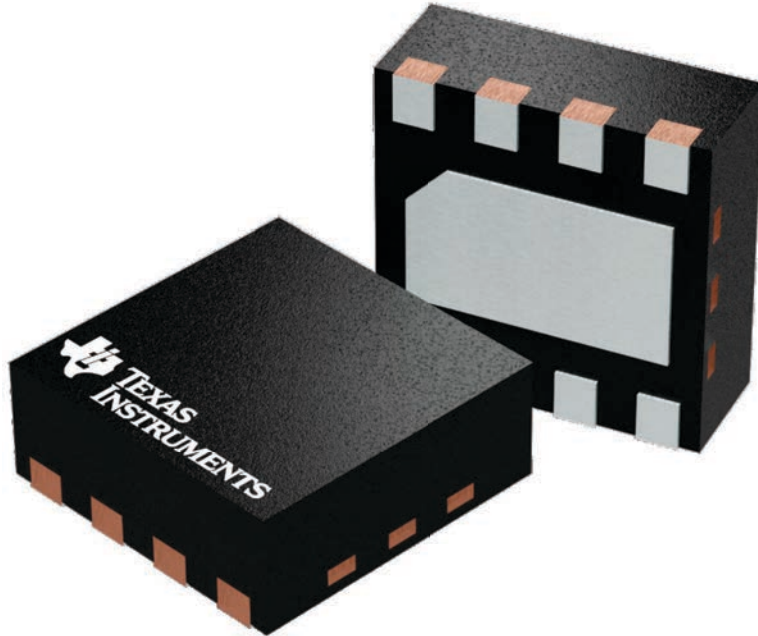

4224783/A

# DSG0008B

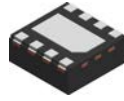

# PACKAGE OUTLINE

## WSON - 0.8 mm max height

PLASTIC SMALL OUTLINE - NO LEAD

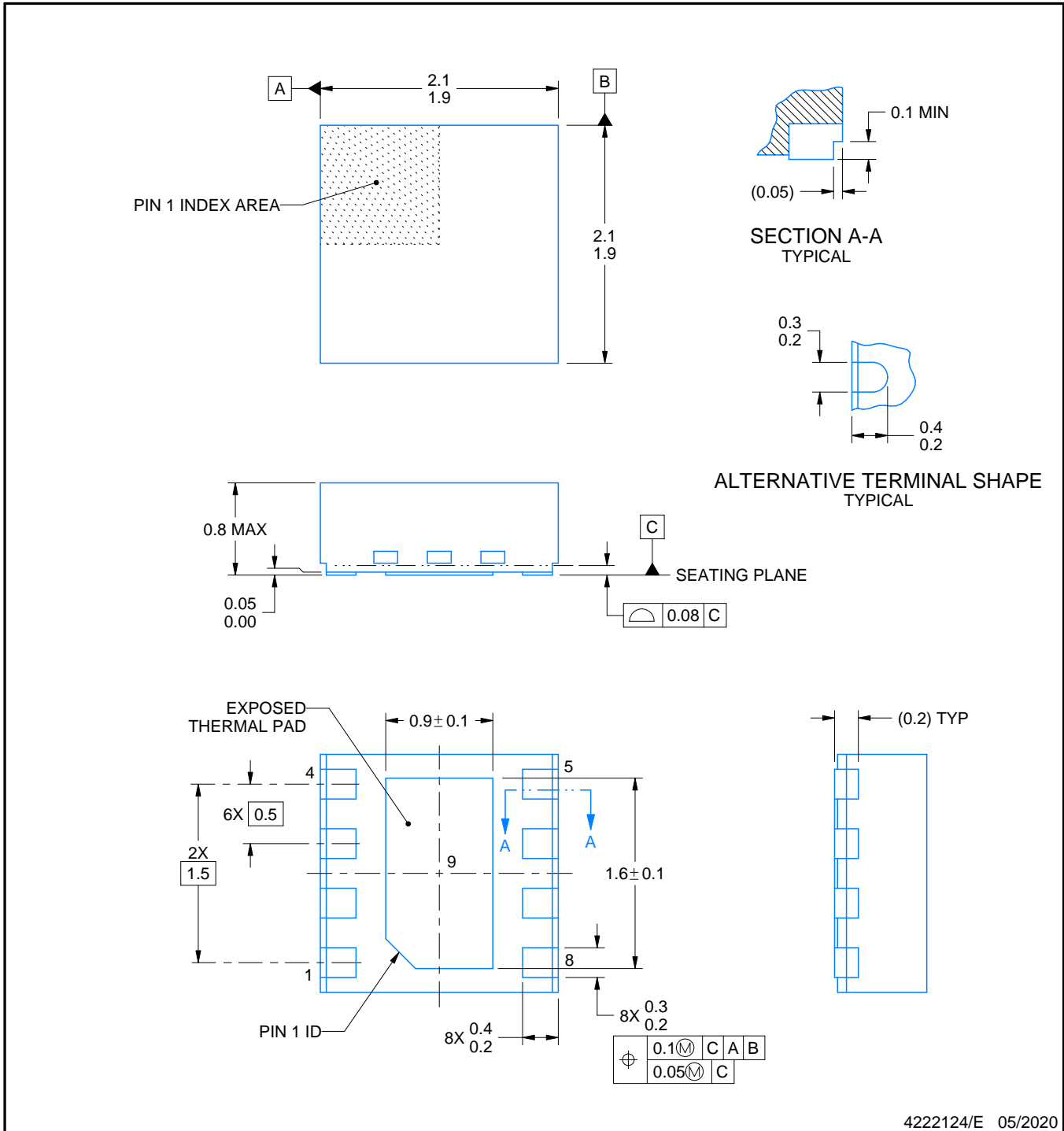

4222124/E 05/2020

**NOTES:**

1. All linear dimensions are in millimeters. Any dimensions in parenthesis are for reference only. Dimensioning and tolerancing per ASME Y14.5M.
2. This drawing is subject to change without notice.
3. The package thermal pad must be soldered to the printed circuit board for thermal and mechanical performance.



# EXAMPLE STENCIL DESIGN

DSG0008B

WSON - 0.8 mm max height

PLASTIC SMALL OUTLINE - NO LEAD

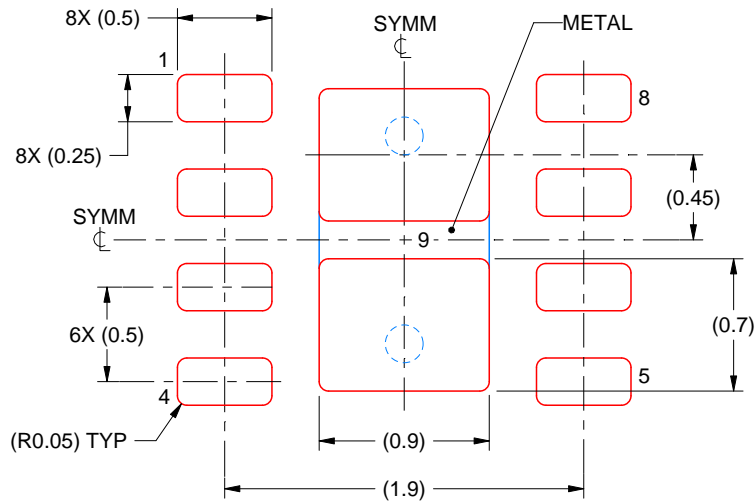

SOLDER PASTE EXAMPLE  
BASED ON 0.125 mm THICK STENCIL

EXPOSED PAD 9:  
87% PRINTED SOLDER COVERAGE BY AREA UNDER PACKAGE  
SCALE:25X

4222124/E 05/2020

NOTES: (continued)

6. Laser cutting apertures with trapezoidal walls and rounded corners may offer better paste release. IPC-7525 may have alternate design recommendations.

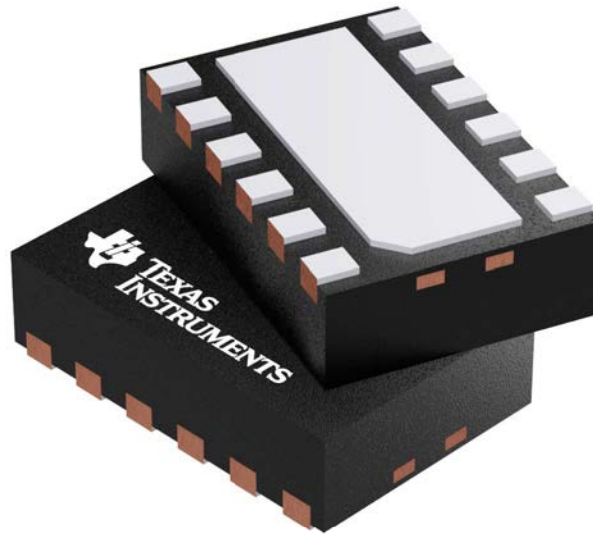

Images above are just a representation of the package family, actual package may vary.  
Refer to the product data sheet for package details.



# DSS0012C



# PACKAGE OUTLINE

## WSON - 0.8 mm max height

PLASTIC SMALL OUTLINE - NO LEAD

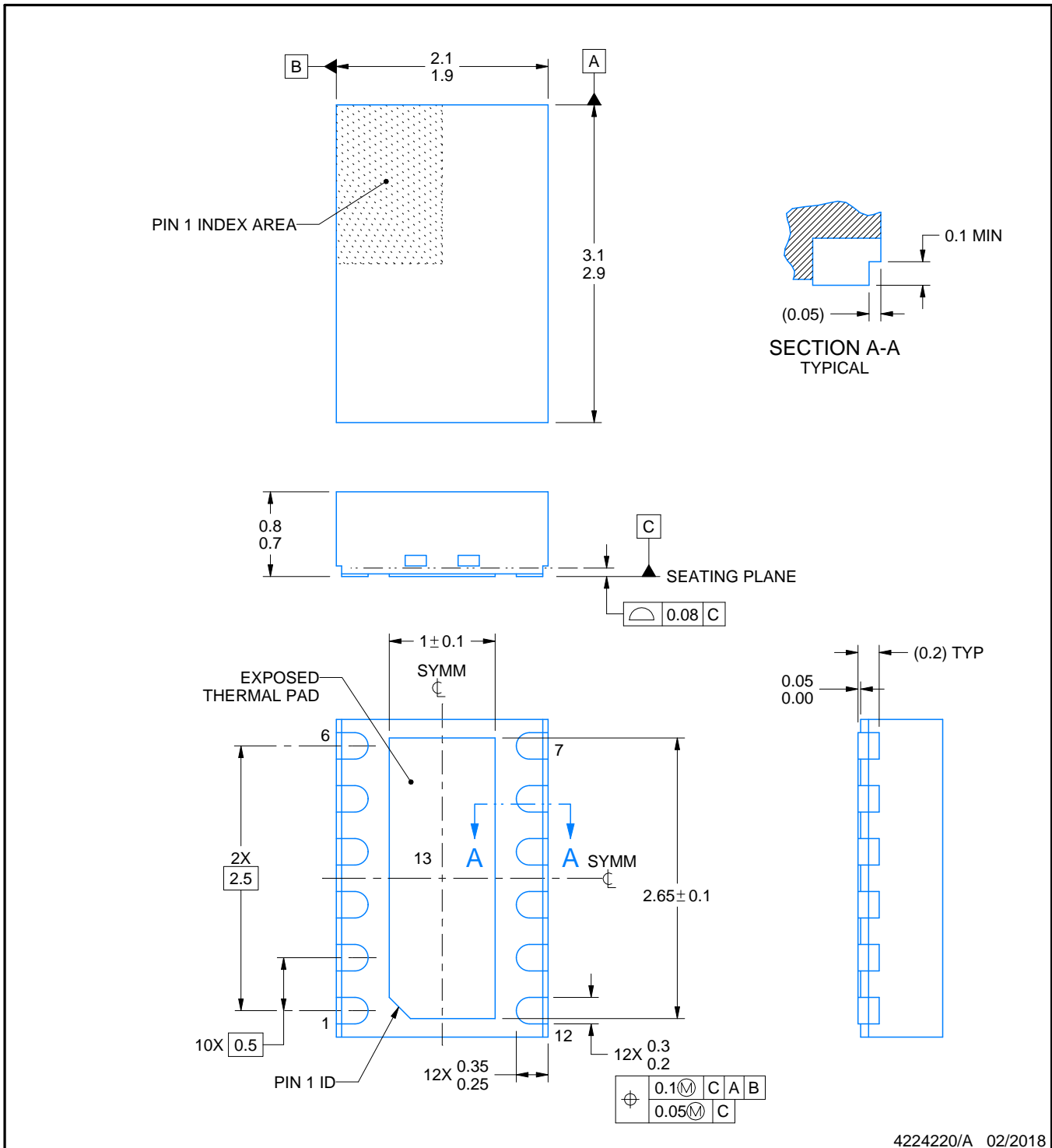

4224220/A 02/2018

### NOTES:

1. All linear dimensions are in millimeters. Any dimensions in parenthesis are for reference only. Dimensioning and tolerancing per ASME Y14.5M.
2. This drawing is subject to change without notice.
3. The package thermal pad must be soldered to the printed circuit board for optimal thermal and mechanical performance.

# EXAMPLE BOARD LAYOUT

DSS0012C

WSON - 0.8 mm max height

PLASTIC SMALL OUTLINE - NO LEAD

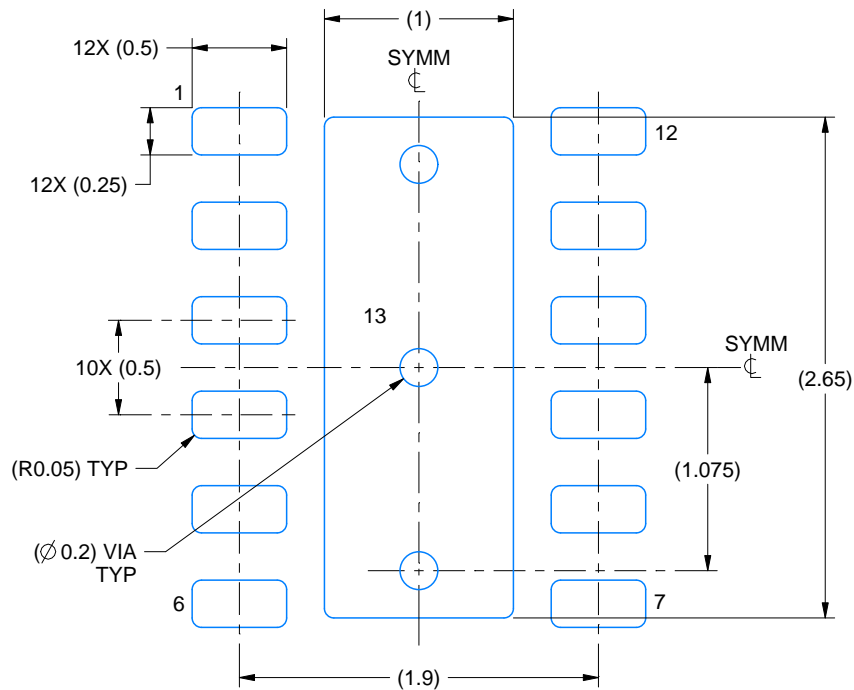

LAND PATTERN EXAMPLE  
EXPOSED METAL SHOWN  
SCALE:25X

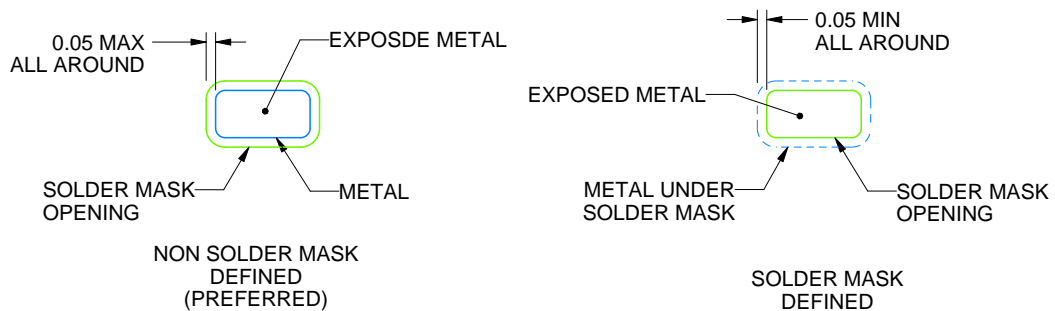

SOLDER MASK DETAILS

4224220/A 02/2018

NOTES: (continued)

- This package is designed to be soldered to a thermal pad on the board. For more information, see Texas Instruments literature number SLUA271 ([www.ti.com/lit/sluea271](http://www.ti.com/lit/sluea271)).
- Vias are optional depending on application, refer to device data sheet. If any vias are implemented, refer to their locations shown on this view. It is recommended that vias under paste be filled, plugged or tented.

# EXAMPLE STENCIL DESIGN

DSS0012C

WSON - 0.8 mm max height

PLASTIC SMALL OUTLINE - NO LEAD

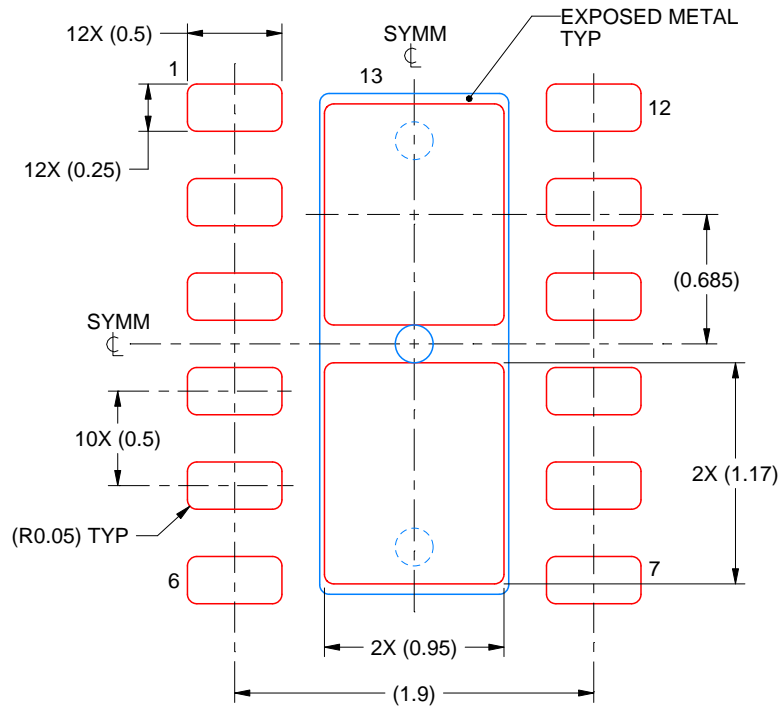

SOLDER PASTE EXAMPLE  
BASED ON 0.125 mm THICK STENCIL

EXPOSED PAD 13:  
83% PRINTED SOLDER COVERAGE BY AREA UNDER PACKAGE  
SCALE:25X

4224220/A 02/2018

NOTES: (continued)

6. Laser cutting apertures with trapezoidal walls and rounded corners may offer better paste release. IPC-7525 may have alternate design recommendations.



# EXAMPLE BOARD LAYOUT

YBG0006

DSBGA - 0.5 mm max height

DIE SIZE BALL GRID ARRAY

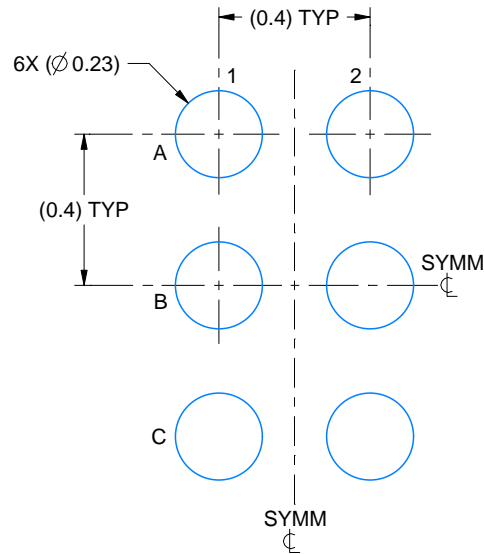

LAND PATTERN EXAMPLE  
EXPOSED METAL SHOWN  
SCALE: 50X

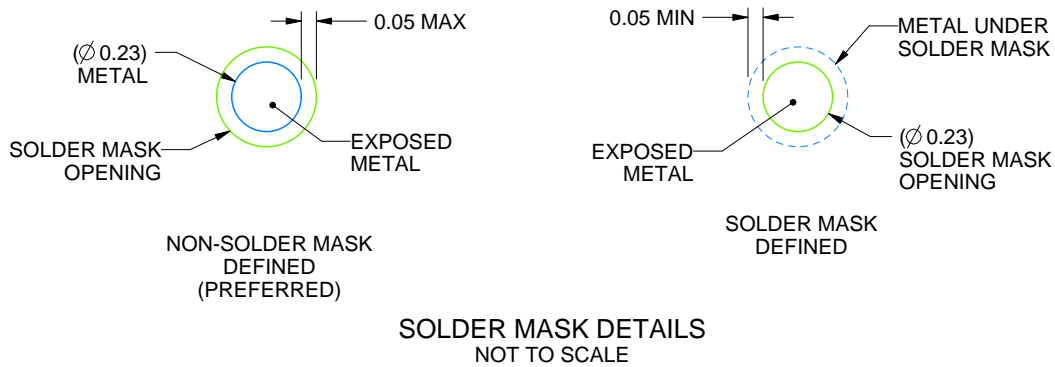

SOLDER MASK DETAILS  
NOT TO SCALE

4224328/A 05/2018

NOTES: (continued)

- Final dimensions may vary due to manufacturing tolerance considerations and also routing constraints. See Texas Instruments Literature No. SNVA009 ([www.ti.com/lit/snva009](http://www.ti.com/lit/snva009)).

# EXAMPLE STENCIL DESIGN

YBG0006

DSBGA - 0.5 mm max height

DIE SIZE BALL GRID ARRAY

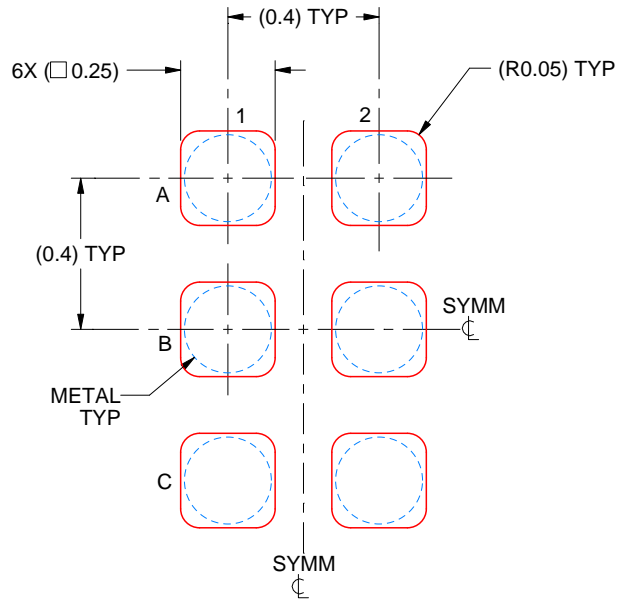

SOLDER PASTE EXAMPLE  
BASED ON 0.1 mm THICK STENCIL  
SCALE: 50X

4224328/A 05/2018

NOTES: (continued)

4. Laser cutting apertures with trapezoidal walls and rounded corners may offer better paste release.

## IMPORTANT NOTICE AND DISCLAIMER

TI PROVIDES TECHNICAL AND RELIABILITY DATA (INCLUDING DATA SHEETS), DESIGN RESOURCES (INCLUDING REFERENCE DESIGNS), APPLICATION OR OTHER DESIGN ADVICE, WEB TOOLS, SAFETY INFORMATION, AND OTHER RESOURCES "AS IS" AND WITH ALL FAULTS, AND DISCLAIMS ALL WARRANTIES, EXPRESS AND IMPLIED, INCLUDING WITHOUT LIMITATION ANY IMPLIED WARRANTIES OF MERCHANTABILITY, FITNESS FOR A PARTICULAR PURPOSE OR NON-INFRINGEMENT OF THIRD PARTY INTELLECTUAL PROPERTY RIGHTS.

These resources are intended for skilled developers designing with TI products. You are solely responsible for (1) selecting the appropriate TI products for your application, (2) designing, validating and testing your application, and (3) ensuring your application meets applicable standards, and any other safety, security, regulatory or other requirements.

These resources are subject to change without notice. TI grants you permission to use these resources only for development of an application that uses the TI products described in the resource. Other reproduction and display of these resources is prohibited. No license is granted to any other TI intellectual property right or to any third party intellectual property right. TI disclaims responsibility for, and you will fully indemnify TI and its representatives against, any claims, damages, costs, losses, and liabilities arising out of your use of these resources.

TI's products are provided subject to [TI's Terms of Sale](#) or other applicable terms available either on [ti.com](https://www.ti.com) or provided in conjunction with such TI products. TI's provision of these resources does not expand or otherwise alter TI's applicable warranties or warranty disclaimers for TI products.

TI objects to and rejects any additional or different terms you may have proposed.

Mailing Address: Texas Instruments, Post Office Box 655303, Dallas, Texas 75265  
Copyright © 2024, Texas Instruments Incorporated