

TPD1E6B06 Single-Channel ESD Protection Diode in 0201 Package

1 Features

- IEC 61000-4-2 Level 4 ESD Protection
 - ±15-kV Contact Discharge
 - ±15-kV Air-Gap Discharge
- IEC 61000-4-5 Surge: 3.8 A (8/20 μs)
- I/O Capacitance: 6 pF (Typical)
- R_{DYN} : 0.55 Ω (Typical)
- DC Breakdown Voltage: ±6 V (Minimum)
- Low Leakage Current: 10 nA (Typical)
- Low ESD Clamping Voltage
- Industrial Temperature Range: –40°C to 125°C
- Space-Saving 0201 Footprint (0.6 mm × 0.3 mm × 0.3 mm)

2 Applications

- End Equipment
 - Mobile Phones
 - Tablets
 - Wearables
 - Remote Controllers
 - Electronic Point of Sale (EPOS)
- Interfaces
 - Audio Lines
 - General-Purpose Input/Output (GPIO)
 - Pushbuttons

3 Description

The TPD1E6B06 device is a single-channel TVS diode for electrostatic discharge (ESD) protection in a small 0201 package. The TPD1E6B06 is rated to dissipate ESD strikes above the maximum level specified in the IEC 61000-4-2 international standard (Level 4), with ±15-kV contact discharge and ±15-kV air-gap ESD protection. The device has a back-to-back TVS diode configuration for bipolar or bidirectional signal support. The 6-pF line capacitance is suitable to provide transient voltage suppression circuit protection for a wide range of applications, supporting data rates up to 800 Mbps.

Typical application interfaces for the TPD1E6B06 are audio lines (microphone, earphone, and speakerphone), SD interfacing, keypad or other buttons, as well as the VBUS and ID pins of USB ports. With its industry-standard 0201 package, The TPD1E6B06 has an extremely small footprint, making it ideal for space-saving end equipment like mobile phones, tablets, and wearables.

Device Information⁽¹⁾

| PART NUMBER | PACKAGE | BODY SIZE (NOM) |
|-------------|-----------|-------------------|
| TPD1E6B06 | X2SON (2) | 0.60 mm × 0.30 mm |

(1) For all available packages, see the orderable addendum at the end of the data sheet.

Simplified Schematic

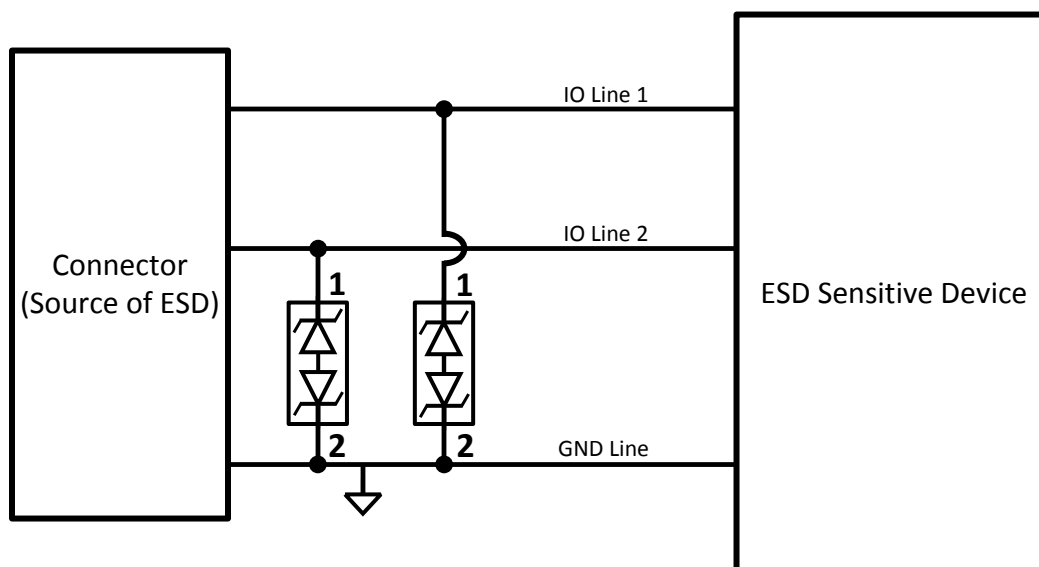

Table of Contents

| | | | |
|--|----------|--|-----------|
| 1 Features | 1 | 7.3 Feature Description | 7 |
| 2 Applications | 1 | 7.4 Device Functional Modes | 7 |
| 3 Description | 1 | 8 Application and Implementation | 8 |
| 4 Revision History | 2 | 8.1 Application Information | 8 |
| 5 Pin Configuration and Functions | 3 | 8.2 Typical Application | 8 |
| 6 Specifications | 3 | 9 Power Supply Recommendations | 10 |
| 6.1 Absolute Maximum Ratings | 3 | 10 Layout | 10 |
| 6.2 ESD Ratings | 3 | 10.1 Layout Guidelines | 10 |
| 6.3 Recommended Operating Conditions | 4 | 10.2 Layout Example | 10 |
| 6.4 Thermal Information | 4 | 11 Device and Documentation Support | 11 |
| 6.5 Electrical Characteristics | 4 | 11.1 Community Resources | 11 |
| 6.6 Typical Characteristics | 5 | 11.2 Trademarks | 11 |
| 7 Detailed Description | 7 | 11.3 Electrostatic Discharge Caution | 11 |
| 7.1 Overview | 7 | 11.4 Glossary | 11 |
| 7.2 Functional Block Diagram | 7 | 12 Mechanical, Packaging, and Orderable Information | 11 |

4 Revision History

NOTE: Page numbers for previous revisions may differ from page numbers in the current version.

Changes from Revision D (April 2015) to Revision E Page

- Added test condition frequency to capacitance
- Added [Community Resources](#)

Changes from Revision C (February 2013) to Revision D Page

- Added *Pin Configuration and Functions* section, *ESD Ratings* table, *Feature Description* section, *Device Functional Modes* section, *Application and Implementation* section, *Power Supply Recommendations* section, *Layout* section, *Device and Documentation Support* section, and *Mechanical, Packaging, and Orderable Information* section

Changes from Revision B (August 2012) to Revision C Page

- Updated TOP-SIDE MARKING in the ORDERING INFORMATION table.

Changes from Revision A (April 2012) to Revision B Page

- Updated IEC 61000-4-5 (Surge) value in FEATURES
- Updated R_{DYN} value in FEATURES
- Updated *Absolute Maximum Ratings*
- Updated TYPICAL CHARACTERISTICS section

Changes from Original (February 2012) to Revision A Page

- Changed 0402 Package to 0201 Package in title.
- Added R_{DYN} to FEATURES.
- Changed supporting data rates from 150Mbps to 800Mbps in the DESCRIPTION section
- Added I_{LEAK} parameter to the *Electrical Characteristics* table.
- Changed supporting data rates from 150Mbps to 800Mbps in the DESCRIPTION section

5 Pin Configuration and Functions

DPL Package
2-Pin X2SON
(Top View)

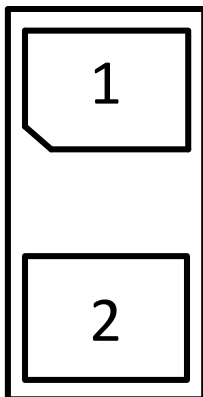

Pin Functions

| PIN | I/O | DESCRIPTION |
|-----|-----|-------------------|
| 1 | I/O | ESD-Protected I/O |
| 2 | | |

6 Specifications

6.1 Absolute Maximum Ratings

over operating free-air temperature range (unless otherwise noted) ⁽¹⁾

| | MIN | MAX | UNIT |
|--|-----|-----|------|
| V_{RWM} Maximum voltage allowed from pin 1 to pin 2, or pin 2 to pin 1 | -5 | 5 | V |
| I_{PP} Peak pulse current ($t_p = 8/20 \mu s$) | | 3.8 | A |
| P_{PP} Peak pulse power ($t_p = 8/20 \mu s$) | | 50 | W |
| T_A Operating temperature | -40 | 125 | °C |
| T_{stg} Storage temperature | -65 | 155 | °C |

- (1) Stresses beyond those listed under *Absolute Maximum Ratings* may cause permanent damage to the device. These are stress ratings only, which do not imply functional operation of the device at these or any other conditions beyond those indicated under *Recommended Operating Conditions*. Exposure to absolute-maximum-rated conditions for extended periods may affect device reliability.

6.2 ESD Ratings

| | VALUE | UNIT |
|-------------------------------------|--|--------|
| $V_{(ESD)}$ Electrostatic discharge | Human body model (HBM), per ANSI/ESDA/JEDEC JS-001 ⁽¹⁾ | ±2500 |
| | Charged-device model (CDM), per JEDEC specification JESD22-C101 ⁽²⁾ | ±1000 |
| | IEC 61000-4-2 contact discharge | ±15000 |
| | IEC 61000-4-2 air-gap discharge | ±15000 |

- (1) JEDEC document JEP155 states that 500-V HBM allows safe manufacturing with a standard ESD control process. Pins listed as ±2500 V may actually have higher performance.
- (2) JEDEC document JEP157 states that 250-V CDM allows safe manufacturing with a standard ESD control process. Pins listed as ±1000 V may actually have higher performance.

6.3 Recommended Operating Conditions

over operating free-air temperature range (unless otherwise noted)

| | | MIN | NOM | MAX | UNIT |
|---------------------------------------|--------------------------|-----|-----|-----|------|
| Operating free-air temperature, T_A | | -40 | | 125 | °C |
| Operating Voltage | Pin 1 to 2 or Pin 2 to 1 | -5 | | 5 | V |

6.4 Thermal Information

| THERMAL METRIC ⁽¹⁾ | | TPD1E6B06 | UNIT |
|-------------------------------|--|-------------|------|
| | | DPL (X2SON) | |
| | | 2 PINS | |
| $R_{\theta JA}$ | Junction-to-ambient thermal resistance | 567.1 | °C/W |
| $R_{\theta JC(top)}$ | Junction-to-case (top) thermal resistance | 253.2 | °C/W |
| $R_{\theta JB}$ | Junction-to-board thermal resistance | 31.6 | °C/W |
| Ψ_{JT} | Junction-to-top characterization parameter | 379.1 | °C/W |
| Ψ_{JB} | Junction-to-board characterization parameter | 31.6 | °C/W |

(1) For more information about traditional and new thermal metrics, see the *Semiconductor and IC Package Thermal Metrics* application report, [SPRA953](#).

6.5 Electrical Characteristics

over operating free-air temperature range (unless otherwise noted)

| PARAMETER | | TEST CONDITIONS | MIN | TYP | MAX | UNIT |
|----------------|---|---|-----|------|-----|----------|
| V_{RWM} | Reverse stand-off voltage | $I_{LEAK} = 100 \text{ nA}$ | | | ±5 | V |
| I_{LEAK} | Leakage current | Pin 1 = 5 V, Pin 2 = 0 V | | | 100 | nA |
| $V_{Clamp1,2}$ | Clamp voltage with ESD strike on pin 1, pin 2 grounded. | $I_{PP} = 1 \text{ A}$, $t_p = 8/20 \text{ }\mu\text{s}$ | | | 10 | V |
| | | $I_{PP} = 5 \text{ A}$, $t_p = 8/20 \text{ }\mu\text{s}$ | | | 14 | |
| $V_{Clamp2,1}$ | Clamp voltage with ESD strike on pin 2, pin 1 grounded. | $I_{PP} = 1 \text{ A}$, $t_p = 8/20 \text{ }\mu\text{s}$ | | | 10 | V |
| | | $I_{PP} = 5 \text{ A}$, $t_p = 8/20 \text{ }\mu\text{s}$ | | | 14 | |
| R_{DYN} | Dynamic resistance | Pin 1 to Pin 2 ⁽¹⁾ | | 0.55 | | Ω |
| | | Pin 2 to Pin 1 ⁽¹⁾ | | 0.55 | | |
| C_{IO} | I/O capacitance | $V_{IO} = 2.5 \text{ V}$; $f = 1 \text{ MHz}$ | | 6 | | pF |
| $V_{BR1,2}$ | Breakdown voltage, pin 1 to pin 2 | $I_{IO} = 1 \text{ mA}$ | 6 | | | V |
| $V_{BR2,1}$ | Breakdown voltage, pin 2 to pin 1 | $I_{IO} = 1 \text{ mA}$ | 6 | | | V |

(1) Extraction of R_{DYN} using least squares fit of TLP characteristics between $I_{PP} = 10 \text{ A}$ and $I_{PP} = 20 \text{ A}$.

6.6 Typical Characteristics

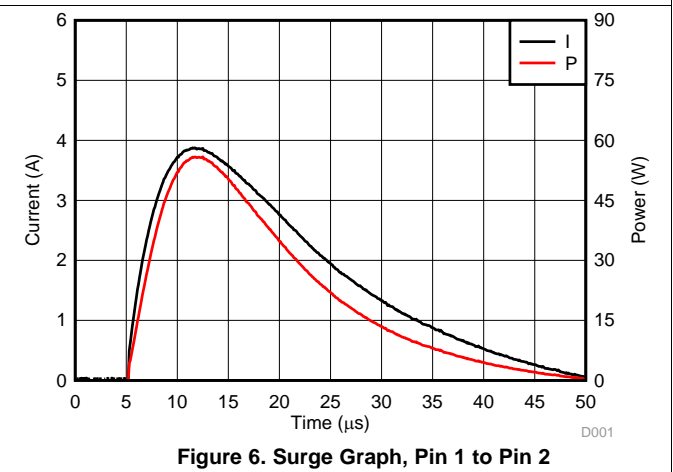
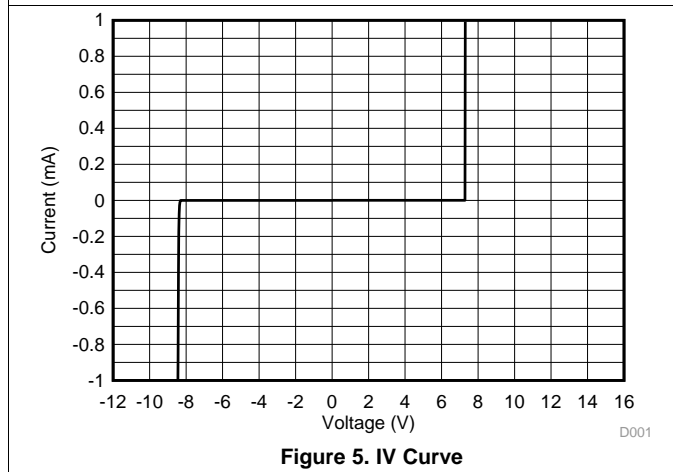
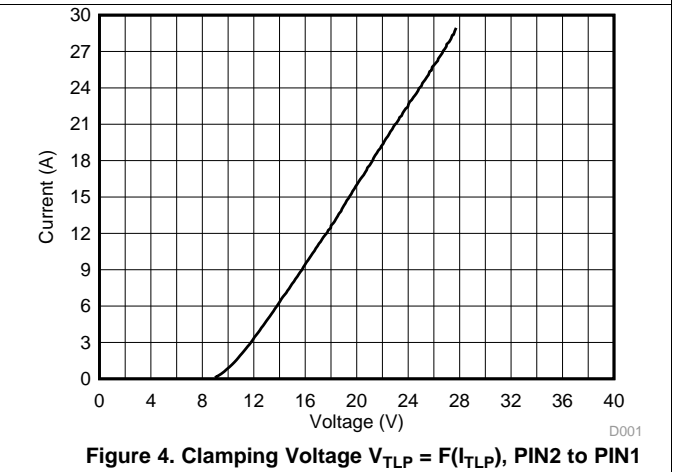
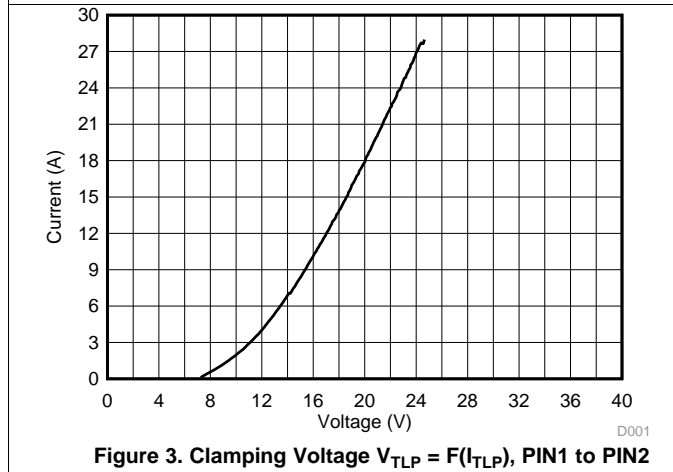
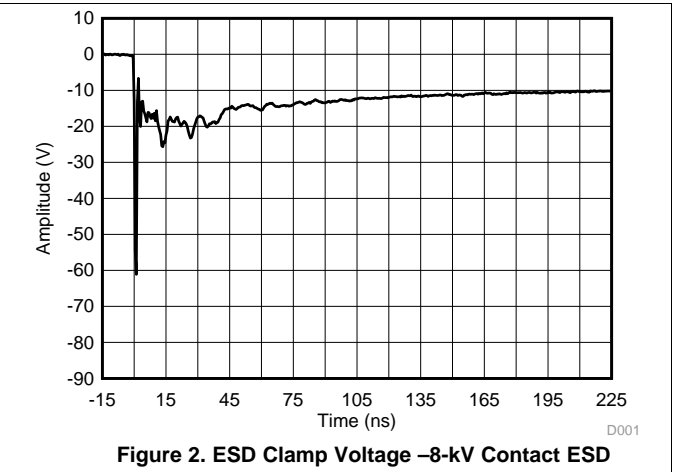
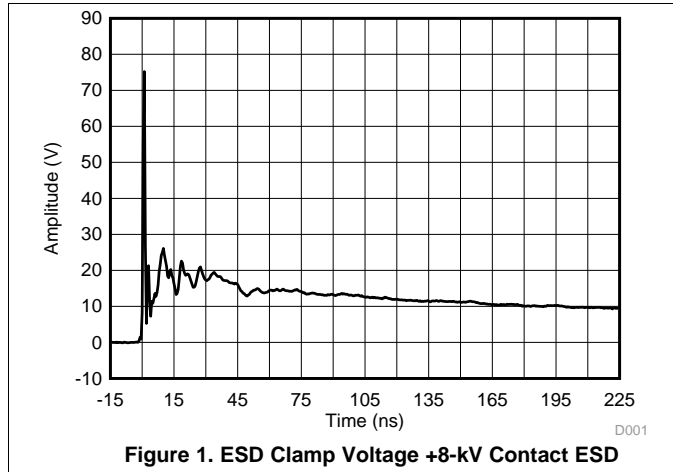

Typical Characteristics (continued)

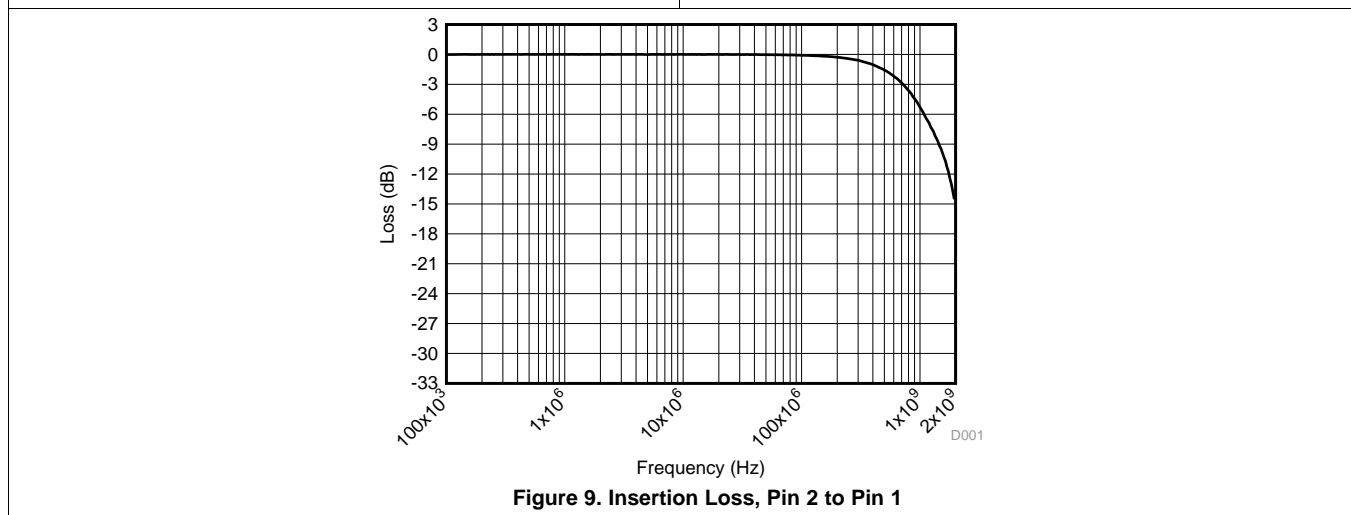
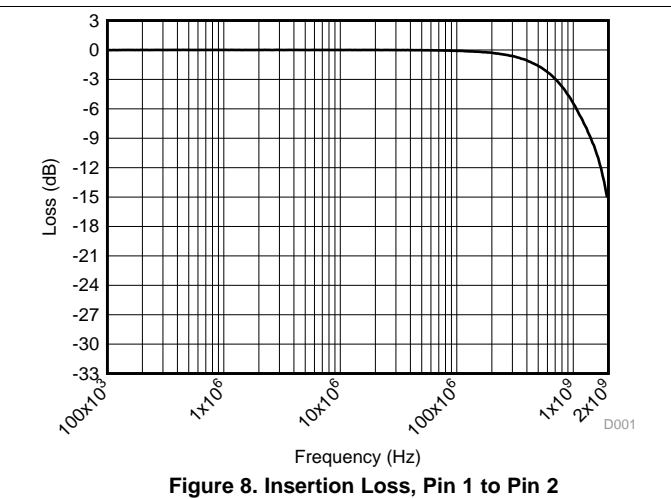
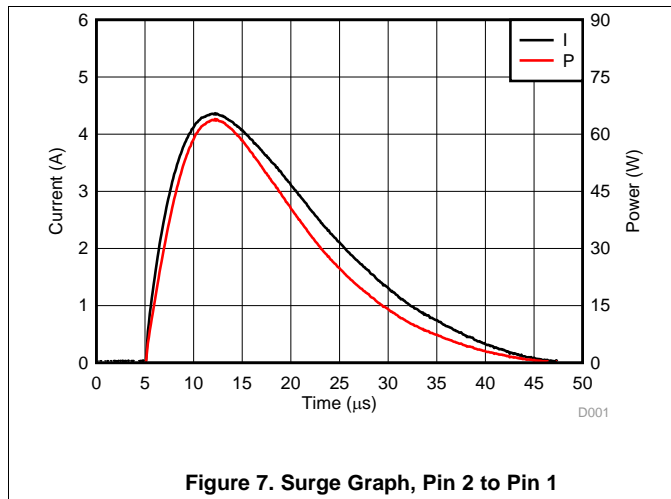

7 Detailed Description

7.1 Overview

The TPD1E6B06 is a single-channel TVS diode for ESD protection in a small 0201 package. The TPD1E6B06 is rated to dissipate ESD strikes above the maximum level specified in the IEC 61000-4-2 international standard (Level 4), with ± 15 -kV contact discharge and ± 15 -kV air-gap ESD protection. The device has a back-to-back TVS diode configuration for bipolar or bidirectional signal support. The 6-pF line capacitance is suitable to provide transient voltage suppression circuit protection for a wide range of applications, supporting data rates up to 800 Mbps. Typical application interfaces for the TPD1E6B06 are audio lines (microphone, earphone, and speakerphone), SD interfacing, keypad or other buttons, as well as the VBUS and ID pins of USB ports.

7.2 Functional Block Diagram



7.3 Feature Description

The TPD1E6B06 is a single-channel TVS diode for ESD protection. This device provides circuit protection from ESD strikes up to ± 15 -kV contact and ± 15 -kV air-gap as specified in the IEC 61000-4-2 international standard. The device can also handle up to 3.8 A of surge current (IEC61000-4-5 8/20 μ s). The TPD1E6B06 has 6 pF (typical) of capacitance which allows this device to support data rates up to 800 Mbps. Additionally, this low capacitance can even be necessary for an audio signal (for example, if a Class D amplifier is used). The TPD1E6B06 also has a small dynamic resistance of 0.55 Ω (typical). This makes the clamping voltage low when it is protecting other circuits, which is crucial for protecting ICs during ESD events. The breakdown is bidirectional so that this protection device is a good fit for GPIO and especially audio lines which carry bidirectional signals. Low leakage current allows the diode to conserve power when working below the V_{RWM} . The industrial temperature range of -40°C to 125°C makes this ESD device to work well at extensive temperatures in most environments. The space-saving 0201 package is designed for small electronic devices like mobile phones and wearables.

7.4 Device Functional Modes

The TPD1E6B06 is a passive clamp that has low leakage during normal operation and activates whenever the voltage between pin 1 and pin 2 goes above V_{RWM} or below $-V_{RWM}$. During IEC ESD events, transient voltages as high as ± 15 kV can be clamped between the two pins. When the voltages on the protected lines fall below the trigger voltage, the device reverts back to the low leakage passive state.

8 Application and Implementation

NOTE

Information in the following applications sections is not part of the TI component specification, and TI does not warrant its accuracy or completeness. TI's customers are responsible for determining suitability of components for their purposes. Customers should validate and test their design implementation to confirm system functionality.

8.1 Application Information

When a system contains a human interface connector, it becomes vulnerable to large system-level ESD strikes that standard ICs cannot survive. TVS ESD protection diodes are typically used to suppress ESD at these connectors. TPD1E6B06 is a single-channel ESD protection device containing back-to-back TVS diodes, which is typically used to provide a path to ground for dissipating ESD events on bidirectional signal lines between a human interface connector and a system. As the current from an ESD event passes through the TVS diode, only a small voltage drop is present across the diode structure. This is the voltage presented to the protected IC. The low R_{DYN} of the triggered TVS holds this voltage, V_{CLAMP} , to a tolerable level to the protected IC.

8.2 Typical Application

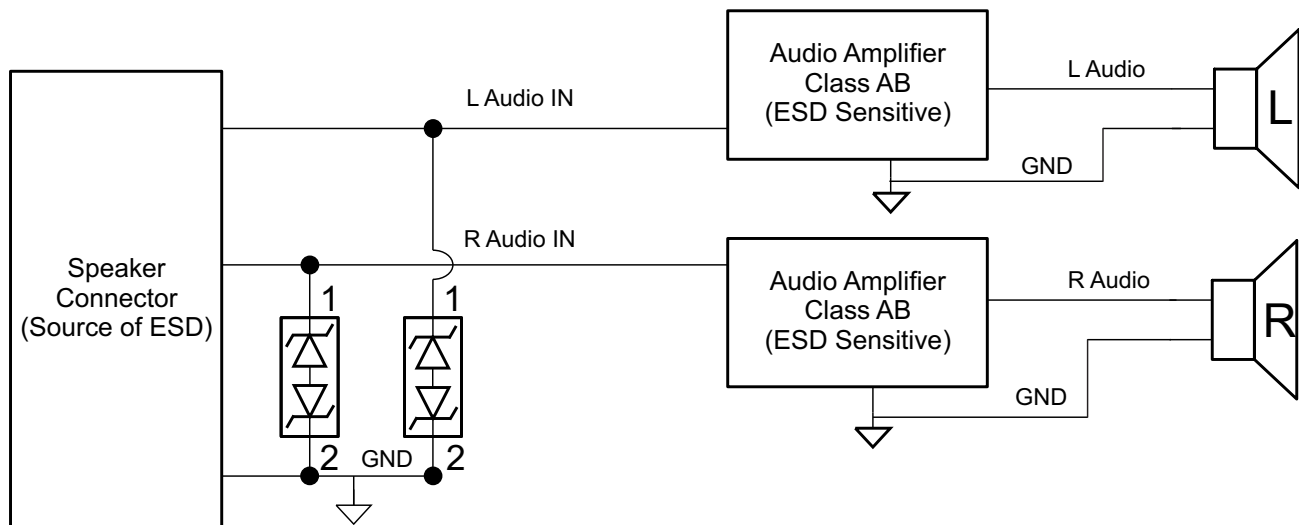

Figure 10. Audio Application Schematic

8.2.1 Design Requirements

For this design example, two TPD1E6B06s will be used to protect left and right audio channels. For this audio application, the following system parameters are known.

Table 1. Design Parameters

| DESIGN PARAMETER | VALUE |
|---------------------------------------|---------------------------------|
| Audio amplifier class | AB |
| Audio signal voltage range | –3 V to 3 V |
| Audio frequency content | 20 Hz to 20 kHz |
| Required IEC 61000-4-2 ESD protection | ±8 kV Contact and ±15kV Air-Gap |

8.2.2 Detailed Design Procedure

To begin the design process, some parameters must be decided upon; the designer should make sure:

- Voltage range on the protected line must not exceed the reverse standoff voltage of the TVS diode(s) (V_{RWM}).
- Operating frequency is supported by the I/O capacitance C_{IO} of the TVS diode.

- IEC 61000-4-2 protection requirement is covered by the IEC performance of the TVS diode.

For this application, the audio signal voltage range is -3 V to 3 V . The V_{RWM} for our TVS is -5 V to 5 V ; therefore, our bidirectional TVS will not break down during normal operation, and therefore normal operation of our audio signal will not be effected due to the signal voltage range. Note that in this application, a bidirectional TVS like TPD1E6B06 is required.

Next, consider the frequency content of this audio signal. In this application with the class AB amplifier, the frequency content is from 20 Hz to 20 kHz ; ensure that the TVS I/O capacitance will not distort this signal by filtering it. With TPD1E6B06 typical capacitance of 6 pF , which leads to a typical 3-dB bandwidth of 700 MHz , this diode has sufficient bandwidth to pass the audio signal without distorting it.

Finally, the human interface in this application requires standard Level 4 IEC 61000-4-2 system-level ESD protection ($\pm 8\text{-kV}$ Contact/ $\pm 15\text{-kV}$ Air-Gap). TPD1E6B06 can survive $\pm 15\text{-kV}$ Contact/ $\pm 15\text{-kV}$ Air-Gap, which indicates that our device can provide sufficient protection for the interface. For any TVS diode to provide its full range of ESD protection capabilities, as well as to minimize the noise and EMI disturbances the board will undergo during ESD events, it is crucial that a system designer uses proper board layout of their TVS ESD protection diodes. For instructions on properly laying out TPD1E6B06, see [Layout](#).

8.2.3 Application Curves

Figure 11 and Figure 12 are captures of the voltage clamping waveforms of TPD1E6B06 during a $+8\text{-kV}$ Contact IEC 61000-4-2 ESD strike and a -8-kV Contact IEC 61000-4-2 ESD strike, respectively, in a typical application with proper board layout.

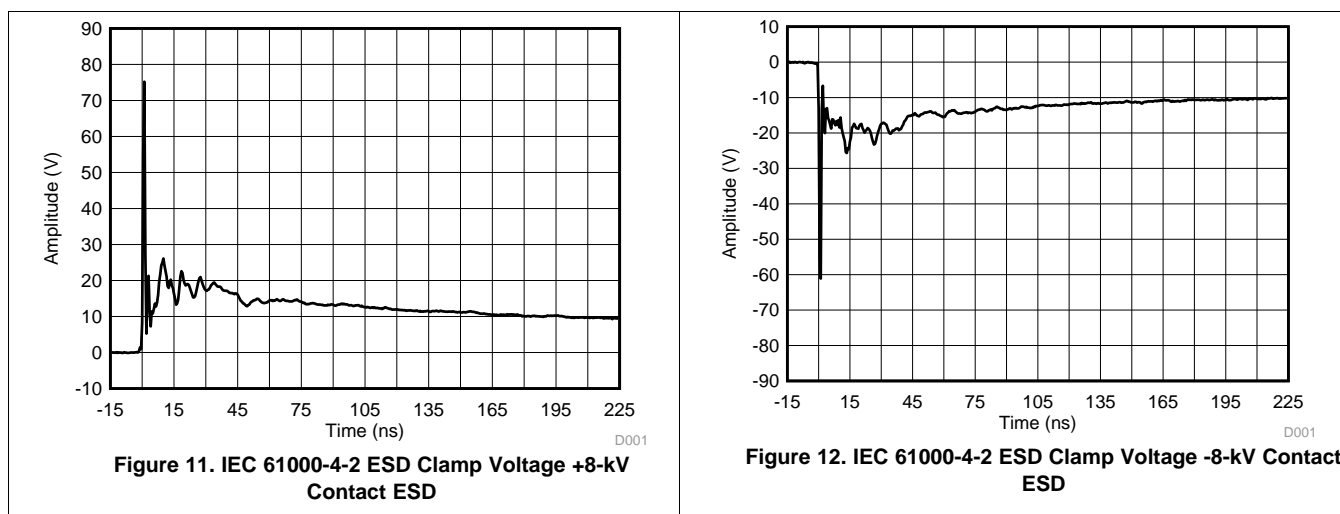

9 Power Supply Recommendations

This device is a passive TVS diode-based ESD protection device so there is no need to power it. Take care to make sure that the maximum voltage specifications for each pin are not violated.

10 Layout

10.1 Layout Guidelines

- The optimum placement is as close to the connector as possible.
 - EMI during an ESD event can couple from the trace being struck to other nearby unprotected traces, resulting in early system failures.
 - The PCB designer must minimize the possibility of EMI coupling by keeping any unprotected traces away from the protected traces which are between the TVS and the connector.
- Route the protected traces as straight as possible.
- Eliminate any sharp corners on the protected traces between the TVS and the connector by using rounded corners with the largest radii possible.
 - Electric fields tend to build up on corners, increasing EMI coupling.
- If pin 1 or pin 2 is connected to ground, use a thick and short trace for this return path

10.2 Layout Example

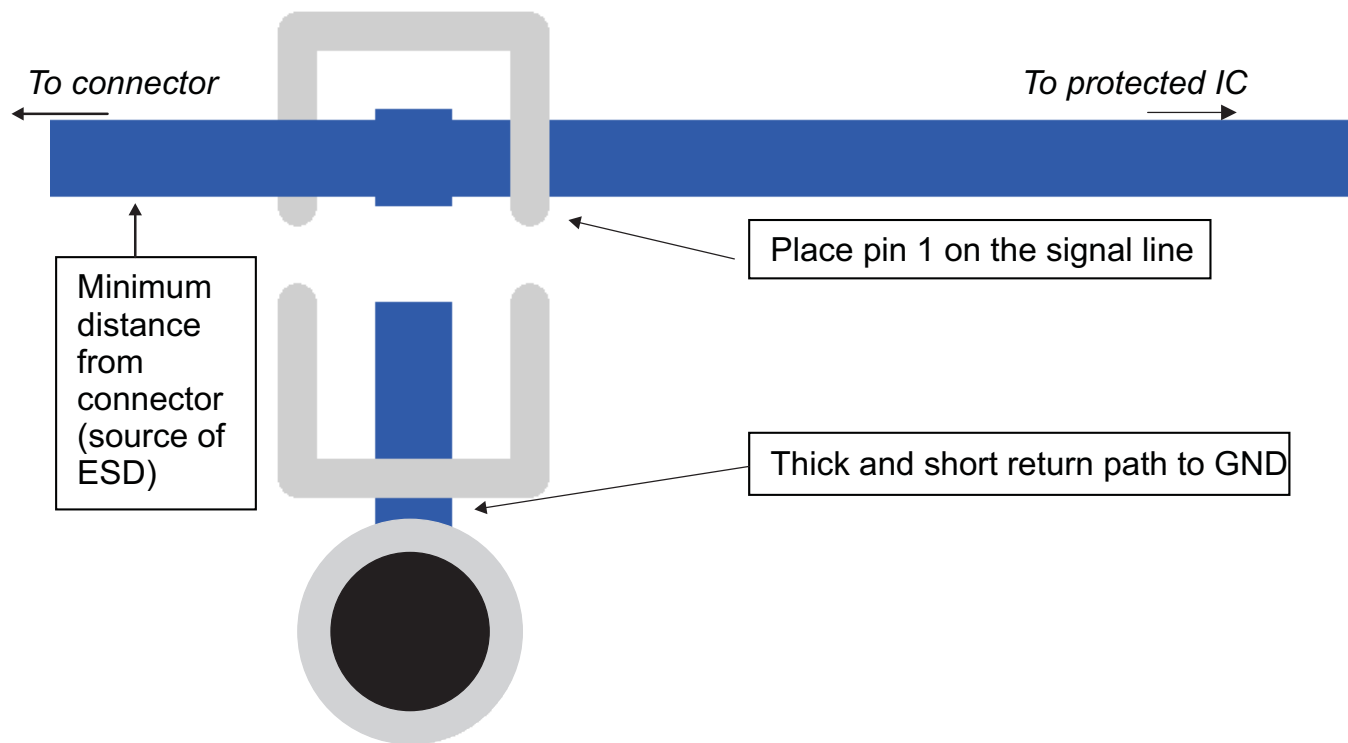

Figure 13. Layout Recommendation

11 Device and Documentation Support

11.1 Community Resources

The following links connect to TI community resources. Linked contents are provided "AS IS" by the respective contributors. They do not constitute TI specifications and do not necessarily reflect TI's views; see TI's [Terms of Use](#).

TI E2E™ Online Community *TI's Engineer-to-Engineer (E2E) Community*. Created to foster collaboration among engineers. At e2e.ti.com, you can ask questions, share knowledge, explore ideas and help solve problems with fellow engineers.

Design Support *TI's Design Support* Quickly find helpful E2E forums along with design support tools and contact information for technical support.

11.2 Trademarks

E2E is a trademark of Texas Instruments.
All other trademarks are the property of their respective owners.

11.3 Electrostatic Discharge Caution



These devices have limited built-in ESD protection. The leads should be shorted together or the device placed in conductive foam during storage or handling to prevent electrostatic damage to the MOS gates.

11.4 Glossary

[SLYZ022](#) — *TI Glossary*.

This glossary lists and explains terms, acronyms, and definitions.

12 Mechanical, Packaging, and Orderable Information

The following pages include mechanical, packaging, and orderable information. This information is the most current data available for the designated devices. This data is subject to change without notice and revision of this document. For browser-based versions of this data sheet, refer to the left-hand navigation.

PACKAGING INFORMATION

| Orderable Device | Status (1) | Package Type | Package Drawing | Pins | Package Qty | Eco Plan (2) | Lead finish/ Ball material (6) | MSL Peak Temp (3) | Op Temp (°C) | Device Marking (4/5) | Samples |
|------------------|---------------|--------------|-----------------|------|-------------|-----------------|--------------------------------------|----------------------|--------------|-------------------------|-------------------------|
| TPD1E6B06DPLR | ACTIVE | X2SON | DPL | 2 | 15000 | RoHS & Green | NIPDAU | Level-1-260C-UNLIM | -40 to 125 | H | Samples |
| TPD1E6B06DPLT | ACTIVE | X2SON | DPL | 2 | 250 | RoHS & Green | NIPDAU | Level-1-260C-UNLIM | -40 to 125 | H | Samples |

(1) The marketing status values are defined as follows:

ACTIVE: Product device recommended for new designs.

LIFEBUY: TI has announced that the device will be discontinued, and a lifetime-buy period is in effect.

NRND: Not recommended for new designs. Device is in production to support existing customers, but TI does not recommend using this part in a new design.

PREVIEW: Device has been announced but is not in production. Samples may or may not be available.

OBSOLETE: TI has discontinued the production of the device.

(2) **RoHS:** TI defines "RoHS" to mean semiconductor products that are compliant with the current EU RoHS requirements for all 10 RoHS substances, including the requirement that RoHS substance do not exceed 0.1% by weight in homogeneous materials. Where designed to be soldered at high temperatures, "RoHS" products are suitable for use in specified lead-free processes. TI may reference these types of products as "Pb-Free".

RoHS Exempt: TI defines "RoHS Exempt" to mean products that contain lead but are compliant with EU RoHS pursuant to a specific EU RoHS exemption.

Green: TI defines "Green" to mean the content of Chlorine (Cl) and Bromine (Br) based flame retardants meet JS709B low halogen requirements of <=1000ppm threshold. Antimony trioxide based flame retardants must also meet the <=1000ppm threshold requirement.

(3) MSL, Peak Temp. - The Moisture Sensitivity Level rating according to the JEDEC industry standard classifications, and peak solder temperature.

(4) There may be additional marking, which relates to the logo, the lot trace code information, or the environmental category on the device.

(5) Multiple Device Markings will be inside parentheses. Only one Device Marking contained in parentheses and separated by a "~" will appear on a device. If a line is indented then it is a continuation of the previous line and the two combined represent the entire Device Marking for that device.

(6) Lead finish/Ball material - Orderable Devices may have multiple material finish options. Finish options are separated by a vertical ruled line. Lead finish/Ball material values may wrap to two lines if the finish value exceeds the maximum column width.

Important Information and Disclaimer:The information provided on this page represents TI's knowledge and belief as of the date that it is provided. TI bases its knowledge and belief on information provided by third parties, and makes no representation or warranty as to the accuracy of such information. Efforts are underway to better integrate information from third parties. TI has taken and continues to take reasonable steps to provide representative and accurate information but may not have conducted destructive testing or chemical analysis on incoming materials and chemicals. TI and TI suppliers consider certain information to be proprietary, and thus CAS numbers and other limited information may not be available for release.

In no event shall TI's liability arising out of such information exceed the total purchase price of the TI part(s) at issue in this document sold by TI to Customer on an annual basis.

TAPE AND REEL INFORMATION

QUADRANT ASSIGNMENTS FOR PIN 1 ORIENTATION IN TAPE

*All dimensions are nominal

| Device | Package Type | Package Drawing | Pins | SPQ | Reel Diameter (mm) | Reel Width W1 (mm) | A0 (mm) | B0 (mm) | K0 (mm) | P1 (mm) | W (mm) | Pin1 Quadrant |
|---------------|--------------|-----------------|------|-------|--------------------|--------------------|---------|---------|---------|---------|--------|---------------|
| TPD1E6B06DPLR | X2SON | DPL | 2 | 15000 | 178.0 | 8.4 | 0.36 | 0.66 | 0.33 | 2.0 | 8.0 | Q3 |
| TPD1E6B06DPLT | X2SON | DPL | 2 | 250 | 178.0 | 8.4 | 0.36 | 0.66 | 0.33 | 2.0 | 8.0 | Q3 |

TAPE AND REEL BOX DIMENSIONS



*All dimensions are nominal

| Device | Package Type | Package Drawing | Pins | SPQ | Length (mm) | Width (mm) | Height (mm) |
|---------------|--------------|-----------------|------|-------|-------------|------------|-------------|
| TPD1E6B06DPLR | X2SON | DPL | 2 | 15000 | 205.0 | 200.0 | 33.0 |
| TPD1E6B06DPLT | X2SON | DPL | 2 | 250 | 205.0 | 200.0 | 33.0 |

MECHANICAL DATA

DPL (R-PX2SON-N2)

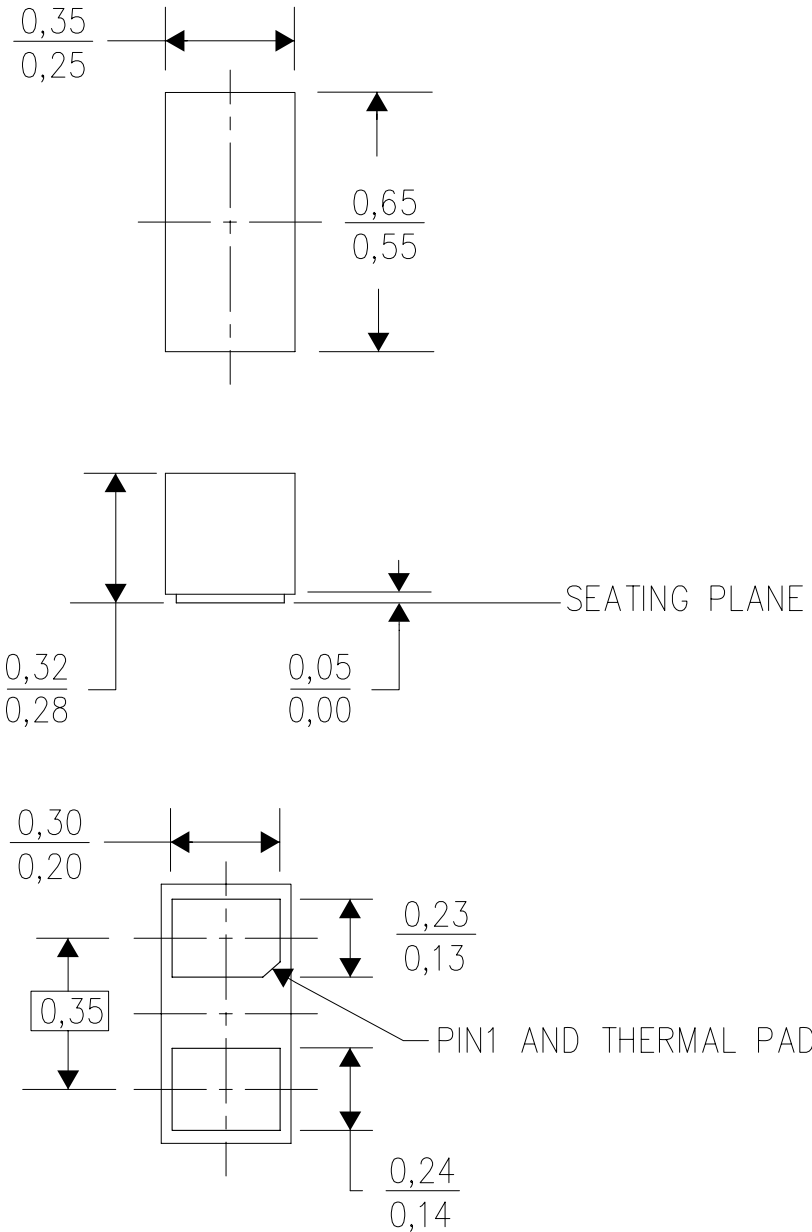
PLASTIC SMALL OUTLINE NO-LEAD



4212149/B 10/11

- NOTES:
- A. All linear dimensions are in millimeters. Dimensioning and tolerancing per ASME Y14.5M-1994.
 - B. This drawing is subject to change without notice.
 - C. Small Outline No-Lead (SON) package configuration.
 - D. The package thermal pad must be soldered to the board for thermal and mechanical performance.

Example Board Layout

Example Stencil Design
(Note E)

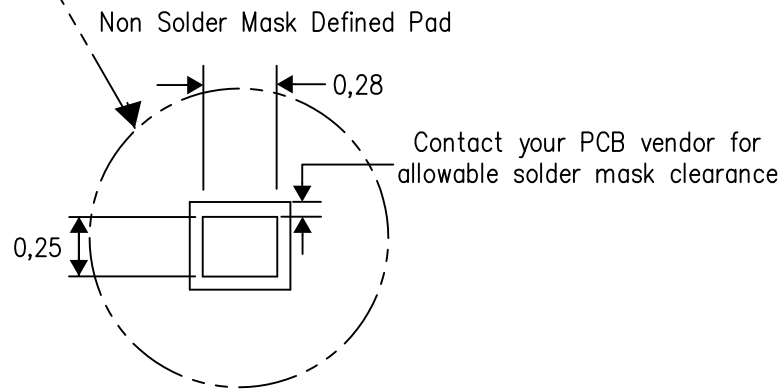
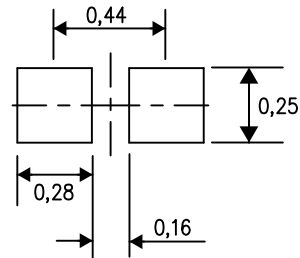
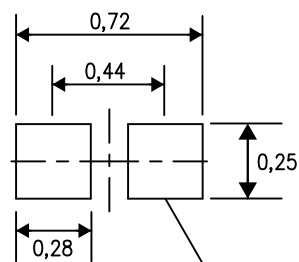

4217903/A 08/12

- NOTES:
- A. All linear dimensions are in millimeters.
 - B. This drawing is subject to change without notice.
 - C. Publication IPC-7351 is recommended for alternate designs.
 - D. Customers should contact their board fabrication site for minimum solder mask web tolerances between signal pads.
 - E. Maximum stencil thickness 0,127 mm (5 mils). All linear dimensions are in millimeters.
 - F. Laser cutting apertures with trapezoidal walls and also rounding corners will offer better paste release. Customers should contact their board assembly site for stencil design recommendations. Refer to IPC 7525 for stencil design considerations.
 - G. Side aperture dimensions over-print land for acceptable area ratio > 0.66. Customer may reduce side aperture dimensions if stencil manufacturing process allows for sufficient release at smaller opening.

IMPORTANT NOTICE AND DISCLAIMER

TI PROVIDES TECHNICAL AND RELIABILITY DATA (INCLUDING DATA SHEETS), DESIGN RESOURCES (INCLUDING REFERENCE DESIGNS), APPLICATION OR OTHER DESIGN ADVICE, WEB TOOLS, SAFETY INFORMATION, AND OTHER RESOURCES "AS IS" AND WITH ALL FAULTS, AND DISCLAIMS ALL WARRANTIES, EXPRESS AND IMPLIED, INCLUDING WITHOUT LIMITATION ANY IMPLIED WARRANTIES OF MERCHANTABILITY, FITNESS FOR A PARTICULAR PURPOSE OR NON-INFRINGEMENT OF THIRD PARTY INTELLECTUAL PROPERTY RIGHTS.

These resources are intended for skilled developers designing with TI products. You are solely responsible for (1) selecting the appropriate TI products for your application, (2) designing, validating and testing your application, and (3) ensuring your application meets applicable standards, and any other safety, security, regulatory or other requirements.

These resources are subject to change without notice. TI grants you permission to use these resources only for development of an application that uses the TI products described in the resource. Other reproduction and display of these resources is prohibited. No license is granted to any other TI intellectual property right or to any third party intellectual property right. TI disclaims responsibility for, and you will fully indemnify TI and its representatives against, any claims, damages, costs, losses, and liabilities arising out of your use of these resources.

TI's products are provided subject to [TI's Terms of Sale](#) or other applicable terms available either on [ti.com](https://www.ti.com) or provided in conjunction with such TI products. TI's provision of these resources does not expand or otherwise alter TI's applicable warranties or warranty disclaimers for TI products.

TI objects to and rejects any additional or different terms you may have proposed.

Mailing Address: Texas Instruments, Post Office Box 655303, Dallas, Texas 75265
Copyright © 2023, Texas Instruments Incorporated