

Dual-Synchronous, Step-Down Controller with Out-of-Audio™ Operation and 100-mA LDOs for Notebook System Power

Check for Samples: [TPS51123A](#)

FEATURES

- **Wide-Input Voltage Range: 5.5 V to 28 V**
- **Output Voltage Range: 2 V to 5.5 V**
- **Built-in 100-mA 5-V/3.3-V LDO with Switches**
- **Built-in 1% 2-V Reference Output**
- **With/Without Out-of-Audio™ Mode Selectable Light-Load and PWM-Only Operation**
- **Internal 1.6-ms Voltage Servo Soft-Start**
- **Adaptive On-Time Control Architecture with Four Selectable Frequency Setting**
- **4500 ppm/°C $R_{DS(on)}$ Current Sensing**
- **Built-In Output Discharge**
- **Power Good Output**
- **Built-in OVP/UVP/OC**
- **Thermal Shutdown (Non-latch)**
- **24-Pin QFN (RGE) Package**

APPLICATIONS

- **Notebook Computers**
- **I/O Supplies**
- **System Power Supplies**

DESCRIPTION

The TPS51123A is a cost effective, dual-synchronous buck controller targeted for notebook system power supply solutions. It provides 5-V and 3.3-V LDOs and requires few external components. The TPS51123A supports high-efficiency, fast transient responses and provides a combined power-good signal. Out-of-Audio™ mode light-load operation enables low acoustic noise at much higher efficiency than conventional forced PWM operation. Adaptive on-time D-CAP™ control provides convenient and efficient operation. The part operates with supply input voltages ranging from 5.5 V to 28 V and supports output voltages from 2 V to 5.5 V. The TPS51123A is available in a 24-pin QFN package and is specified from -40°C to 85°C ambient temperature range.

Table 1. Differences Between the TPS51123 and TPS51123A

	TPS51123	TPS51123A
LDO Output Capacitance Requirement	VREG5: at least 33 μ F	VREG5: 10 μ F or larger (X5R or X7R)
	VREG3: at most 10 μ F (1 μ F acceptable at no load)	VREG3: 10 μ F or larger (X5R or X7R) (1 μ F acceptable at no load)
	VREF: 0.22 μ F to 1 μ F	VREF: 0.22 μ F to 1 μ F (X5R or X7R)



Please be aware that an important notice concerning availability, standard warranty, and use in critical applications of Texas Instruments semiconductor products and disclaimers thereto appears at the end of this data sheet.

Out-of-Audio, D-CAP are trademarks of Texas Instruments.



This integrated circuit can be damaged by ESD. Texas Instruments recommends that all integrated circuits be handled with appropriate precautions. Failure to observe proper handling and installation procedures can cause damage.

ESD damage can range from subtle performance degradation to complete device failure. Precision integrated circuits may be more susceptible to damage because very small parametric changes could cause the device not to meet its published specifications.

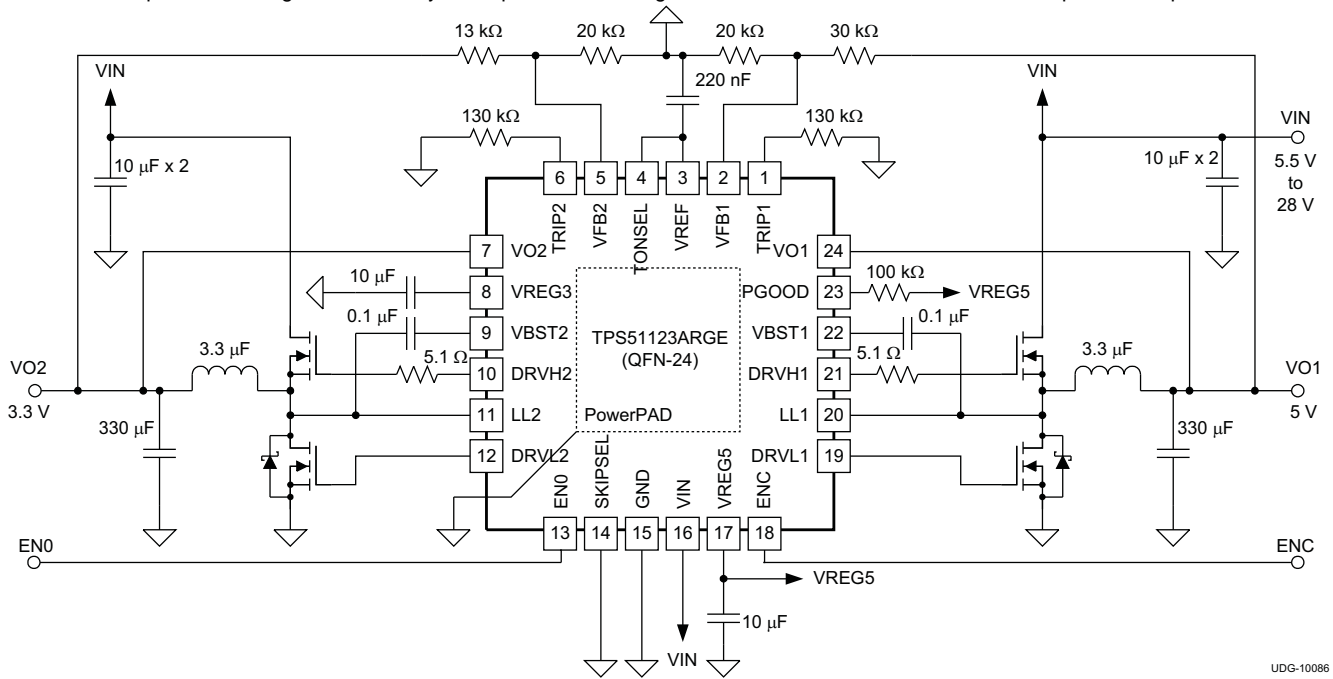

UDG-10086

ORDERING INFORMATION⁽¹⁾

T _A	PACKAGE	ORDERABLE DEVICE	PINS	OUTPUT SUPPLY	MINIMUM QUANTITY	ECO PLAN
-40°C to 85°C	Plastic Quad Flat Pack (QFN)	TPS51123ARGER	24	Tape/Reel	3000	Green (RoHS and no Sb/Br)
		TPS51123ARGET		Small Tape/Reel	250	

(1) For the most current specifications and package information, see the *Package Option Addendum* located at the end of this data sheet or refer to our web site at <http://www.ti.com>.

ABSOLUTE MAXIMUM RATINGS⁽¹⁾

over operating free-air temperature range (unless otherwise noted)

PARAMETER		VALUE		UNIT
		MIN	MAX	
Input voltage range ⁽¹⁾	VBST1, VBST2	-0.3	36	V
	VIN	-0.3	30	
	LL1, LL2	-2.0	30	
	LL1, LL2, pulse width < 20 ns	-5.0	30	
	VBST1, VBST2 ⁽²⁾	-0.3	6	
	EN0, ENC, TRIP1, TRIP2, VFB1, VFB2, VO1, VO2, TONSEL, SKIPSEL	-0.3	6	
Output voltage range ⁽¹⁾	DRVH1, DRVH2	-1.0	36	V
	DRVH1, DRVH2 ⁽²⁾	-0.3	6	
	PGOOD, VREG3, VREG5, VREF, DRVL1, DRVL2	-0.3	6	
Electrostatic discharge	Human body model QSS 009-105 (JESD22-A114A)		2	kV
	Charged device model QSS 009-147 (JESD22-C101B.01)		1.5	kV
Junction temperature range, T _J		-40	125	°C
Storage temperature, T _{stg}		-55	150	°C

(1) Stresses beyond those listed under "absolute maximum ratings" may cause permanent damage to the device. These are stress ratings only and functional operation of the device at these or any other conditions beyond those indicated under "recommended operating conditions" is not implied. Exposure to absolute-maximum-rated conditions for extended periods may affect device reliability.

(2) Voltage values are with respect to the corresponding LLx terminal.

DISSIPATION RATINGS

2-oz. trace and copper pad with solder.

PACKAGE	T _A < 25°C POWER RATING	DERATING FACTOR ABOVE T _A = 25°C	T _A = 85°C POWER RATING
24-pin RGE ⁽¹⁾	1.85 W	18.5 mW/°C	0.74 W

(1) Enhanced thermal conductance by 3 x 3 thermal vias beneath thermal pad.

RECOMMENDED OPERATING CONDITIONS

over operating free-air temperature range (unless otherwise noted)

PARAMETER		MIN	TYP	MAX	UNIT
Supply voltage	VIN	5.5		28	
Input voltage range	VBST1, VBST2	-0.1		34	V
	VBST1, VBST2 (wrt LLx)	-0.1		5.5	
	EN0, ENC, TRIP1, TRIP2, VFB1, VFB2, VO1, VO2, TONSEL, SKIPSEL	-0.1		5.5	
Output voltage range	DRVH1, DRVH2	-0.8		34	
	DRVH1, DRVH2 (wrt LLx)	-0.1		5.5	
	LL1, LL2	-1.8		28	
	VREF, VREG3, VREG5	-0.1		5.5	
	PGOOD, DRVL1, DRVL2	-0.1		5.5	
T _A	Operating free-air temperature	-40		85	°C

ELECTRICAL CHARACTERISTICS

over operating free-air temperature range, VIN = 12 V (unless otherwise noted)

PARAMETER		CONDITIONS	MIN	TYP	MAX	UNIT
SUPPLY CURRENT						
I _{VIN1}	VIN supply current1	VIN current, T _A = 25°C, no load, VO1 = 0 V, VO2 = 0 V, EN0=open, ENC = 5 V, TRIP1 = TRIP2 = 2 V, VFB1 = VFB2 = 2.05 V		0.55	1.00	mA
I _{VIN2}	VIN supply current2	VIN current, T _A = 25°C, no load, VO1 = 5 V, VO2 = 3.3 V, EN0=open, ENC = 5 V, TRIP1 = TRIP2 = 2 V, VFB1 = VFB2 = 2.05 V		4.0	6.5	μA
I _{VO1}	VO1 current	VO1 current, T _A = 25°C, no load, VO1 = 5 V, VO2 = 3.3 V, EN0=open, ENC = 5 V, TRIP1 = TRIP2 = 2 V, VFB1 = VFB2 = 2.05 V		0.8	1.5	mA
I _{VO2}	VO2 current	VO2 current, T _A = 25°C, no load, VO1 = 5 V, VO2 = 3.3 V, EN0=open, ENC = 5 V, TRIP1 = TRIP2 = 2 V, VFB1 = VFB2 = 2.05 V		12	100	μA
I _{VINSTBY}	VIN standby current	VIN current, T _A = 25°C, no load, EN0 = 1.2 V, ENC = 0 V		95	150	
I _{VINSDN}	VIN shutdown current	VIN current, T _A = 25°C, no load, EN0 = ENC = 0 V		10	25	
VREF OUTPUT						
V _{VREF}	VREF output voltage	I _{VREF} = 0 A	1.98	2.00	2.02	V
		-5 μA < I _{VREF} < 100 μA	1.97	2.00	2.03	
VREG5 OUTPUT						
V _{VREG5}	VREG5 output voltage	VO1 = 0 V, I _{VREG5} < 100 mA, T _A = 25°C	4.8	5	5.2	V
		VO1 = 0 V, I _{VREG5} < 100 mA, 6.5 V < VIN < 28 V	4.75	5	5.25	
		VO1 = 0 V, I _{VREG5} < 50 mA, 5.5 V < VIN < 28 V	4.75	5	5.25	
I _{VREG5}	VREG5 output current	VO1 = 0 V, VREG5 = 4.5 V	100	175	250	mA
V _{TH5VSW}	Switch over threshold	Turns on	4.55	4.7	4.85	V
		Hysteresis	0.15	0.25	0.3	
R _{5VSW}	5 V SW R _{ON}	VO1 = 5 V, I _{VREG5} = 100 mA		1	3	Ω
VREG3 OUTPUT						
V _{VREG3}	VREG3 output voltage	VO2 = 0 V, I _{VREG3} < 100 mA, T _A = 25°C	3.2	3.33	3.46	V
		VO2 = 0 V, I _{VREG3} < 100 mA, 6.5 V < VIN < 28 V	3.13	3.33	3.5	
		VO2 = 0 V, I _{VREG3} < 50 mA, 5.5 V < VIN < 28 V	3.13	3.33	3.5	
I _{VREG3}	VREG3 output current	VO2 = 0 V, VREG3 = 3 V	100	175	250	mA
V _{TH3VSW}	Switch over threshold	Turns on	3.05	3.15	3.25	V
		Hysteresis	0.1	0.2	0.25	
R _{3VSW}	3 V SW R _{ON}	VO2 = 3.3 V, I _{VREG3} = 100 mA		1.5	4	Ω
INTERNAL REFERENCE VOLTAGE						
V _{IREF}	Internal reference voltage	I _{VREF} = 0 A, beginning of ON state	1.95	1.98	2.01	V
V _{VFB}	VFB regulation voltage	FB voltage, I _{VREF} = 0 A, skip mode	1.98	2.01	2.04	
		FB voltage, I _{VREF} = 0 A, OOA mode ⁽¹⁾	2.00	2.035	2.07	
		FB voltage, I _{VREF} = 0 A, continuous conduction mode ⁽¹⁾		2.00		
I _{VFB}	VFB input current	VFBx = 2.0 V, T _A = 25°C	-20		20	nA
OUTPUT VOLTAGE, V_{OUT} DISCHARGE						
I _{Dischg}	V _{OUT} discharge current	ENC = 0 V, VOx = 0.5 V	10	60		mA

(1) Ensured by design. Not production tested.

ELECTRICAL CHARACTERISTICS (continued)over operating free-air temperature range, $V_{IN} = 12\text{ V}$ (unless otherwise noted)

PARAMETER		CONDITIONS	MIN	TYP	MAX	UNIT
OUTPUT DRIVERS						
R_{DRVH}	DRVH resistance	Source, $V_{BSTx} - DRVHx = 100\text{ mV}$		4	8	Ω
		Sink, $V_{DRVHx} - LLx = 100\text{ mV}$		1.5	4	
R_{DRVL}	DRVL resistance	Source, $V_{REG5} - DRVLx = 100\text{ mV}$		4	8	
		Sink, $V_{DRVLx} = 100\text{ mV}$		1.5	4	
t_{DEAD}	Dead time	DRVHx-off to DRVLx-on		10		ns
		DRVLx-off to DRVHx-on		30		
INTERNAL BST DIODE						
V_{FBST}	Forward voltage	$V_{REG5} - V_{BSTx}$, $I_F = 10\text{ mA}$, $T_A = 25\text{ }^\circ\text{C}$	0.7	0.8	0.9	V
I_{VBSTLK}	VBST leakage current	$V_{BSTx} = 34\text{ V}$, $LLx = 28\text{ V}$, $T_A = 25\text{ }^\circ\text{C}$		0.1	1	μA
DUTY AND FREQUENCY CONTROL						
t_{ON11}	CH1 on time 1	$V_{IN} = 12\text{ V}$, $VO1 = 5\text{ V}$, 200 kHz setting		2080		ns
t_{ON12}	CH1 on time 2	$V_{IN} = 12\text{ V}$, $VO1 = 5\text{ V}$, 245 kHz setting		1700		
t_{ON13}	CH1 on time 3	$V_{IN} = 12\text{ V}$, $VO1 = 5\text{ V}$, 300 kHz setting		1390		
t_{ON14}	CH1 on time 4	$V_{IN} = 12\text{ V}$, $VO1 = 5\text{ V}$, 365 kHz setting		1140		
t_{ON21}	CH2 on time 1	$V_{IN} = 12\text{ V}$, $VO2 = 3.3\text{ V}$, 250 kHz setting		1100		
t_{ON22}	CH2 on time 2	$V_{IN} = 12\text{ V}$, $VO2 = 3.3\text{ V}$, 305 kHz setting		900		
t_{ON23}	CH2 on time 3	$V_{IN} = 12\text{ V}$, $VO2 = 3.3\text{ V}$, 375 kHz setting		730		
t_{ON24}	CH2 on time 4	$V_{IN} = 12\text{ V}$, $VO2 = 3.3\text{ V}$, 460 kHz setting		600		
$t_{ON(min)}$	Minimum on time	$T_A = 25\text{ }^\circ\text{C}$		80		
$t_{OFF(min)}$	Minimum off time	$T_A = 25\text{ }^\circ\text{C}$		300		
SOFT-START						
t_{SS}	Internal SS time	Internal soft start	1.1	1.6	2.1	ms
POWERGOOD						
V_{THPG}	PG threshold	PG in from lower	92.50%	95%	97.50%	
		PG in from higher	102.50%	105%	107.50%	
		PG hysteresis	2.50%	5%	7.50%	
I_{PGMAX}	PG sink current	$PGOOD = 0.5\text{ V}$	5	12		mA
t_{PGDEL}	PG delay	Delay for PG in	350	510	670	μs
LOGIC THRESHOLD AND SETTING CONDITIONS						
V_{EN0}	EN0 setting voltage	Shutdown			0.4	V
		Enable	2.4			
I_{EN0}	EN0 current	$V_{EN0} = 0.2\text{ V}$	2	3.5	5	μA
V_{ENC}	ENC threshold voltage	Shutdown			0.6	V
		Enable	2			
$V_{EN(trip)}$	TRIP1, TRIP2 threshold	Shutdown	350	400	450	mV
		Hysteresis	10	30	60	
V_{TONSEL}	TONSEL setting voltage	200 kHz/250 kHz			1.5	V
		245 kHz/305 kHz	1.9		2.1	
		300 kHz/375 kHz	2.7		3.6	
		365 kHz/460 kHz	4.7			
$V_{SKIPSEL}$	SKIPSEL setting voltage	Auto skip			1.5	V
		PWM only	1.9		2.1	
		OOA auto skip	2.7			

ELECTRICAL CHARACTERISTICS (continued)

over operating free-air temperature range, VIN = 12 V (unless otherwise noted)

PARAMETER		CONDITIONS	MIN	TYP	MAX	UNIT
PROTECTION: CURRENT SENSE						
I _{TRIP}	TRIPx source current	V _{TRIPx} = 920 mV, T _A = 25°C	9.4	10	10.6	μA
T _{CITRIP}	TRIPx current temperature coefficient	On the basis of 25°C ⁽²⁾		4500		ppm/°C
V _{OCLoff}	OCP comparator offset	((V _{TRIPx-GND} /9)-24 mV -V _{GND-LLx}) voltage, V _{TRIPx-GND} = 920 mV	-8	0	8	mV
V _{OCL(max)}	Maximum OCL setting	V _{TRIPx} = 5 V	185	205	225	
V _{ZC}	Zero cross detection comparator offset	V _{GND-LLx} voltage	-5	0	5	
V _{TRIP}	Current limit threshold	V _{TRIPx-GND} voltage ⁽²⁾	0.515		2	
PROTECTION: UNDERVOLTAGE AND OVERVOLTAGE PROTECTION						
V _{OVP}	OVP trip threshold	OVP detect	110%	115%	120%	
t _{OVPDEL}	OVP prop delay			2		μs
V _{UVP}	Output UVP trip threshold	UVP detect	55%	60%	65%	
		Hysteresis		10%		
t _{UVPDEL}	Output UVP prop delay		20	32	40	μs
t _{UVPEN}	Output UVP enable delay		1.4	2	2.6	ms
UNDERVOLTAGE LOCKOUT (UVLO)						
V _{UVVREG5}	VREG5 UVLO threshold	Wake up	4.1	4.2	4.3	V
		Hysteresis	0.38	0.43	0.48	
V _{UVVREG3}	VREG3 UVLO threshold	Shutdown ⁽²⁾		VO2-1		
THERMAL SHUTDOWN						
T _{SDN}	Thermal shutdown threshold	Shutdown temperature ⁽²⁾		150		°C
		Hysteresis ⁽²⁾		10		

(2) Ensured by design. Not production tested.

DEVICE INFORMATION

Table 2.

TERMINAL		I/O	DESCRIPTION
NAME	NO.		
DRVH1	21	O	High-side N-channel MOSFET driver outputs. LL referenced drivers.
DRVH2	10		
DRVL1	19	O	Low-side N-channel MOSFET driver outputs. GND referenced drivers.
DRVL2	12		
EN0	13	I/O	Master enable input. Open : LDOs on, and ready to turn both switcher channels. GND : disable all circuit
ENC	18	I	Channel 1 and Channel 2 enable input. Pull up to the voltage ranging 3.3-V to 5-V to turn on both switcher channels. Short to ground to shutdown them.
GND	15	–	Ground.
LL1	20	I	Switch node connections for high-side drivers, current limit and control circuitry.
LL2	11		
PGOOD	23	O	Powergood window comparator output for channel 1 and 2. (Logical AND)
SKIPSEL	14	I	Selection pin for operation mode: OOA auto skip : Connect to VREG3 or VREG5 PWM only: Connect to VREF Auto skip: Connect to GND
TRIP1	1	I/O	Channel 1 and Channel 2 enable and OCL trip setting pins. Connect resistor from this pin to GND to set threshold for synchronous $R_{DS(on)}$ sense. Short to ground to shut down a switcher channel.
TRIP2	6		
TONSEL	4	I	On-time adjustment pin. 365 kHz/460 kHz setting: connect to VREG5 300 kHz/375 kHz setting: connect to VREG3 245 kHz/305 kHz setting: connect to VREF 200 kHz/250 kHz setting: connect to GND
VBST1	22	I	Supply input for high-side N-channel MOSFET driver (boost terminal).
VBST2	9		
VFB1	2	I	SMPS feedback inputs. Connect with feedback resistor divider.
VFB2	5		
VIN	16	I	High voltage power supply input for 5-V/3.3-V LDO.
VO1	24	I/O	Output connection to SMPS. These terminals work as fixed voltage inputs and output discharge inputs. VO1 and VO2 also work as 5-V and 3.3-V switch over return power input respectively.
VO2	7		
VREF	3	O	2-V reference voltage output. Connect a high-quality X5R or X7R ceramic capacitor with a value between 220-nF and 1- μ F to signal GND near the device.
VREG3	8	O	3.3-V power supply output. Connect a high-quality X5R or X7R ceramic capacitor with a value of 10- μ F or larger to power GND near the device. A 1- μ F ceramic capacitor is acceptable when not loaded.
VREG5	17	O	5-V power supply output. Connect a high-quality X5R or X7R ceramic capacitor with a value of 10- μ F or larger to power GND near the device.

Switcher Controller Block

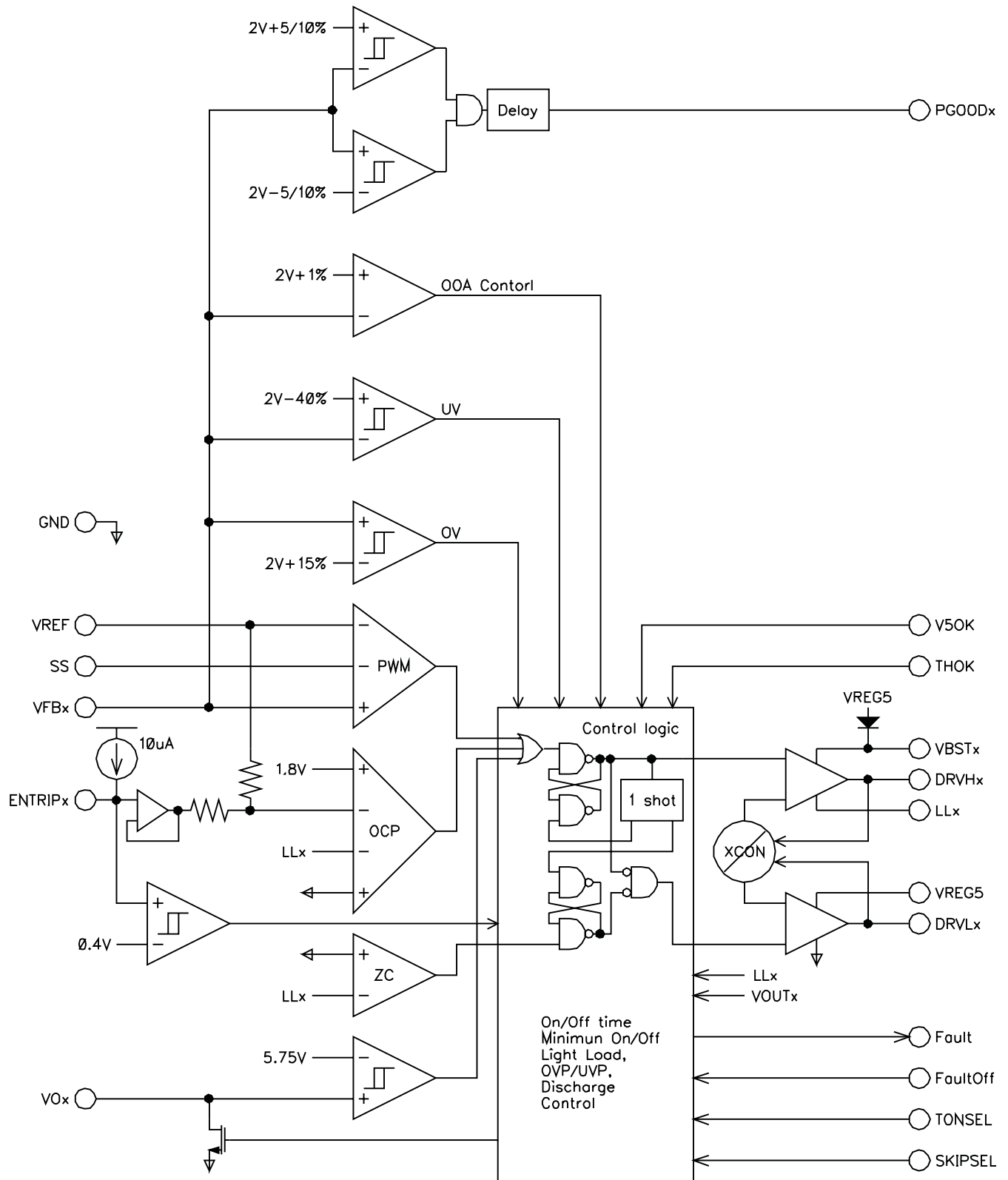

TYPICAL CHARACTERISTICS

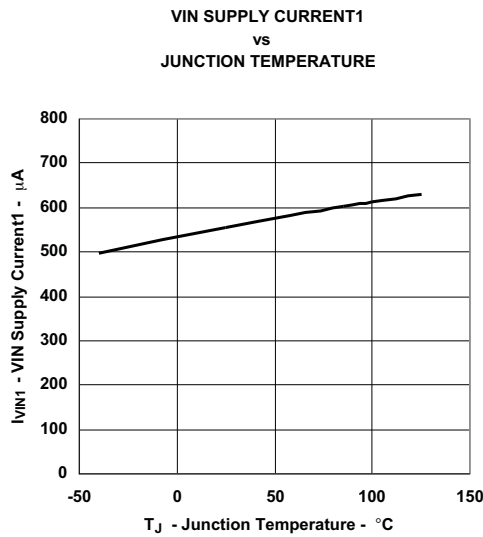

Figure 1.

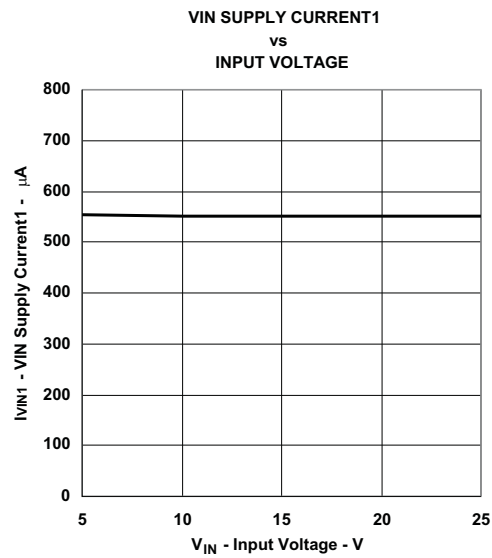

Figure 2.

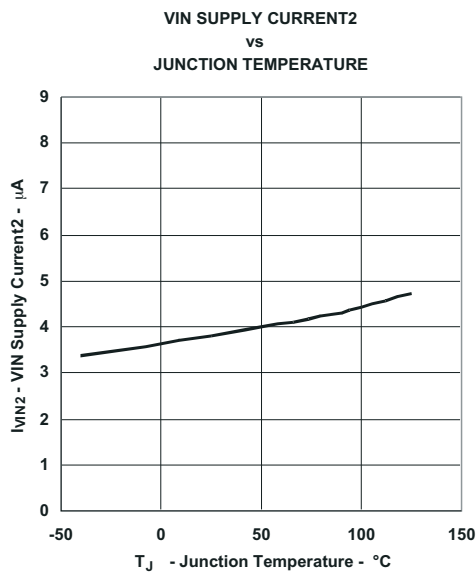

Figure 3.

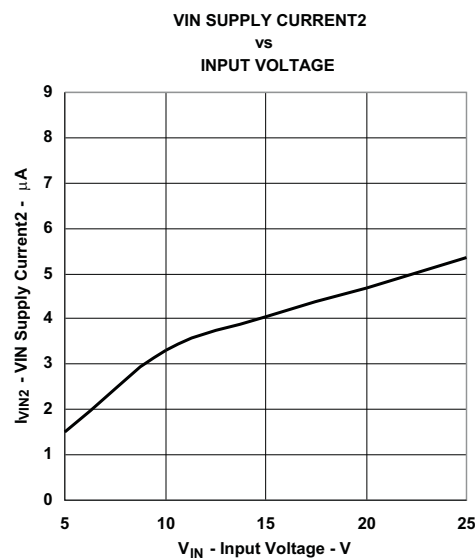

Figure 4.

TYPICAL CHARACTERISTICS (continued)

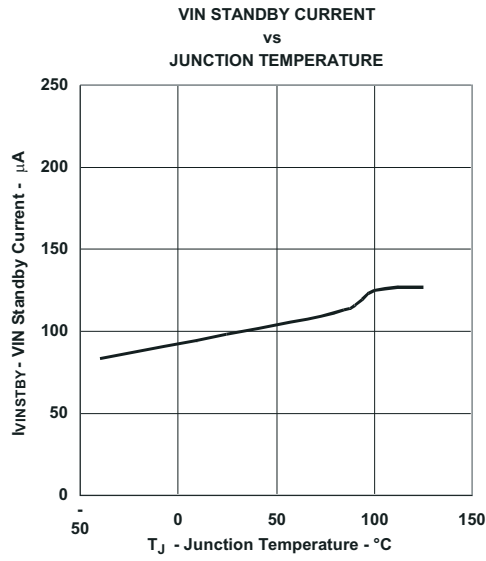

Figure 5.

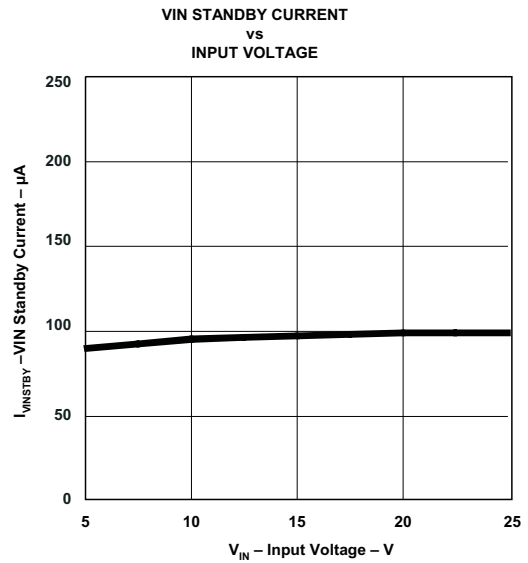

Figure 6.

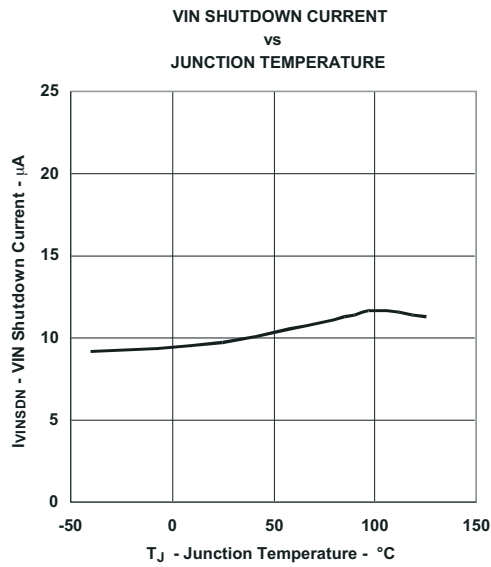

Figure 7.

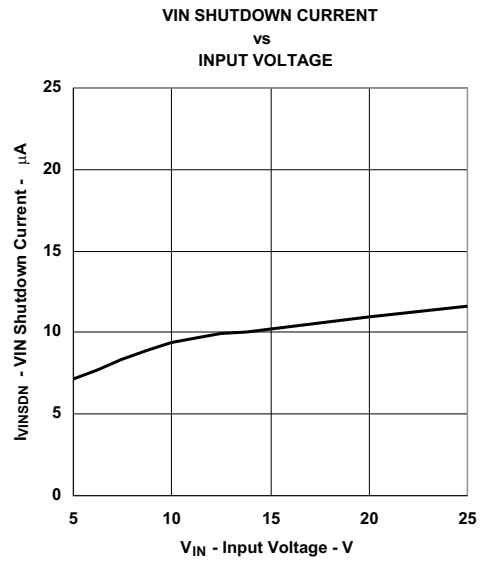

Figure 8.

TYPICAL CHARACTERISTICS (continued)

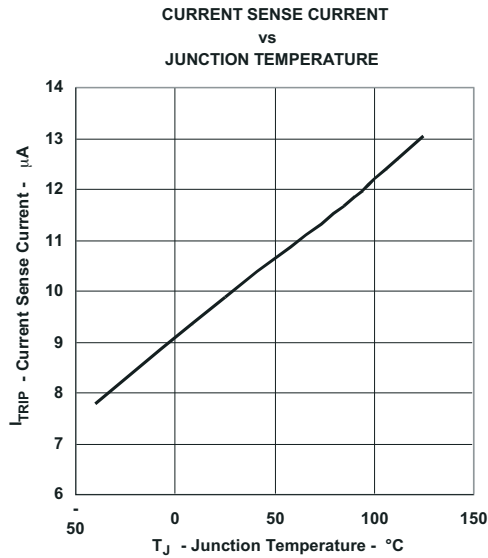

Figure 9.

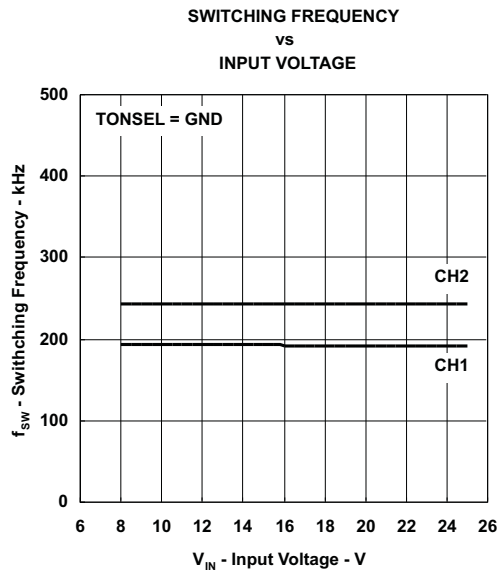

Figure 10.

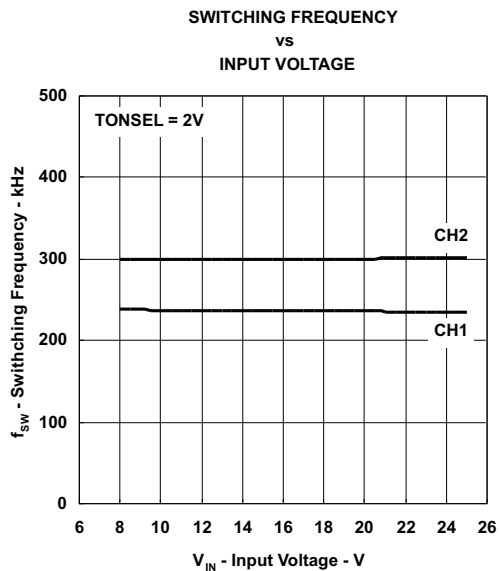

Figure 11.

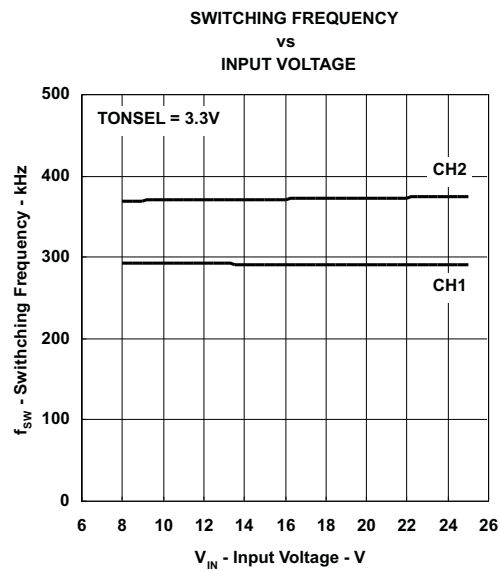

Figure 12.

TYPICAL CHARACTERISTICS (continued)

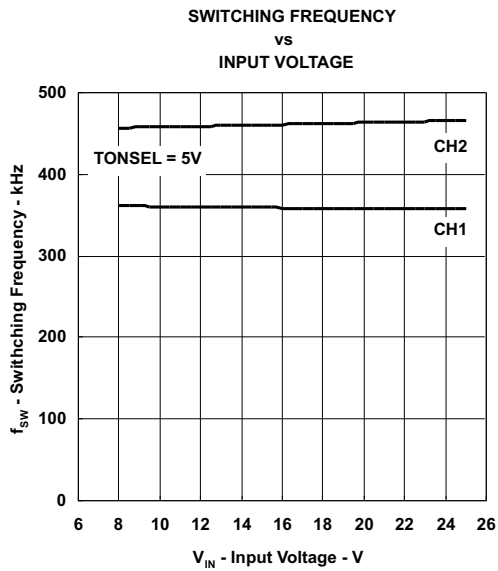

Figure 13.

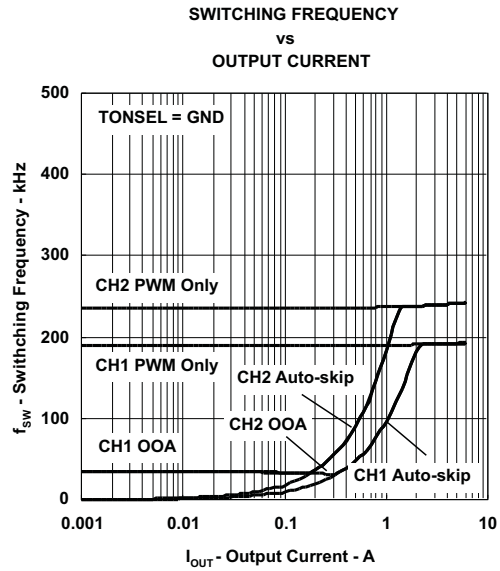

Figure 14.

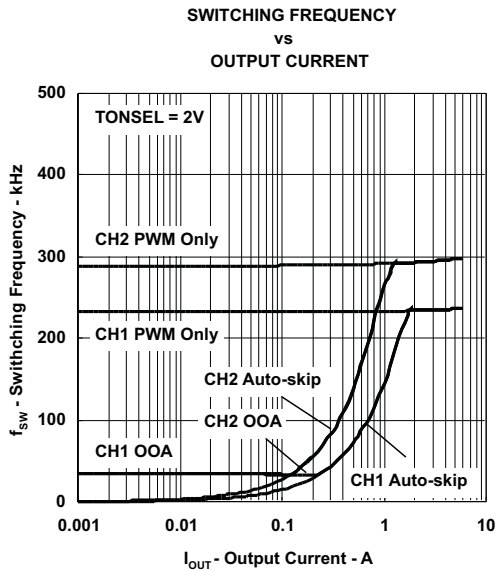

Figure 15.

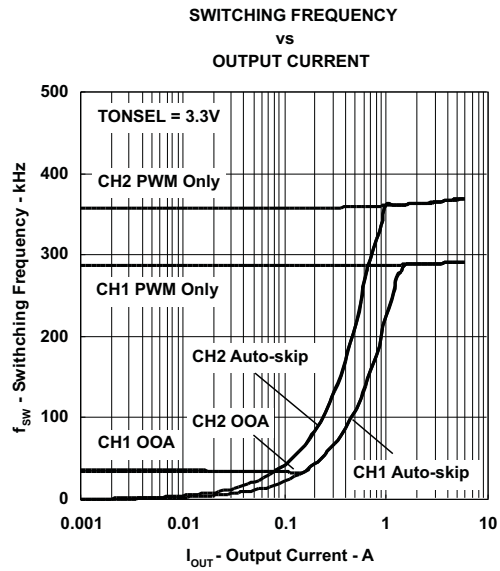

Figure 16.

TYPICAL CHARACTERISTICS (continued)

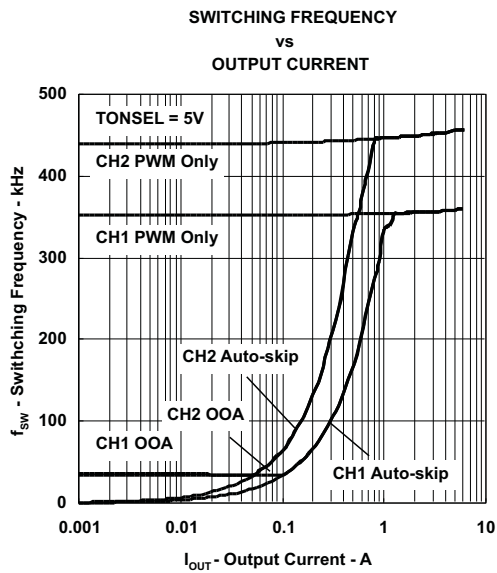

Figure 17.

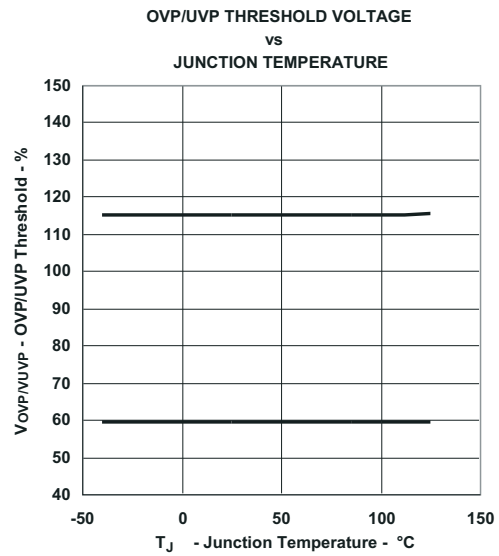

Figure 18.

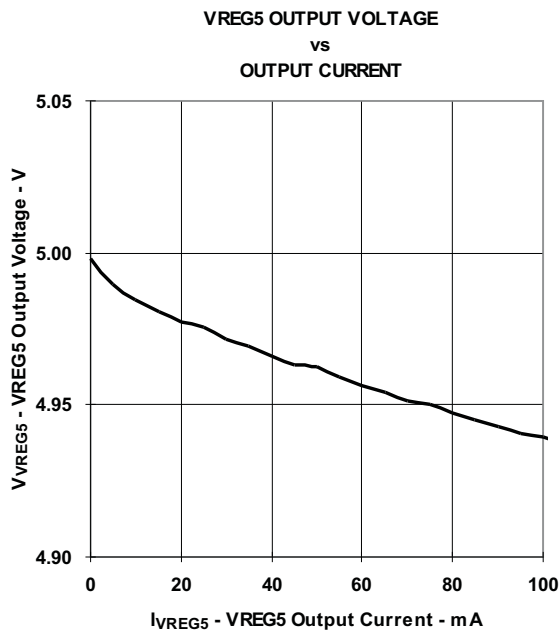

Figure 19.

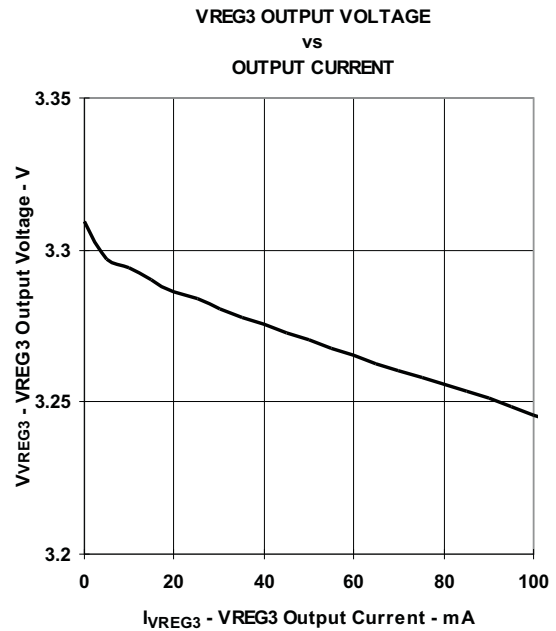

Figure 20.

TYPICAL CHARACTERISTICS (continued)

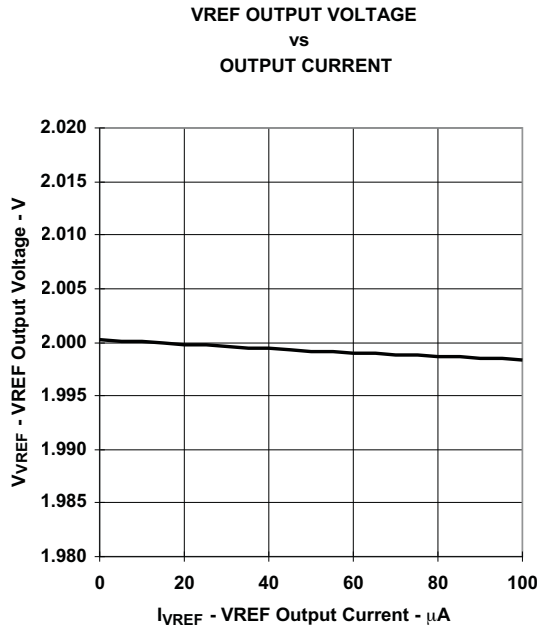

Figure 21.

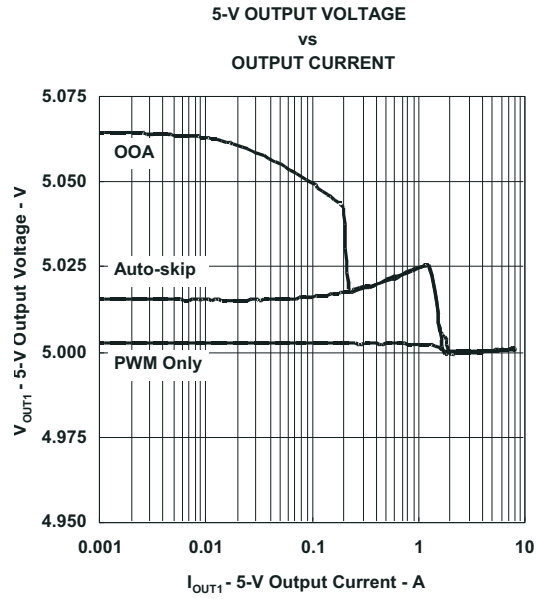

Figure 22.

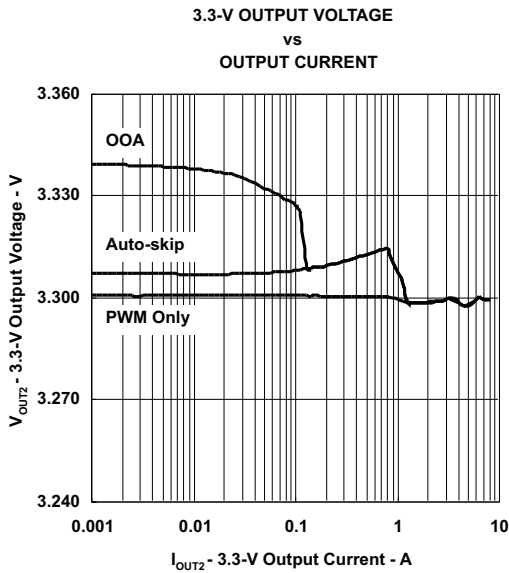

Figure 23.

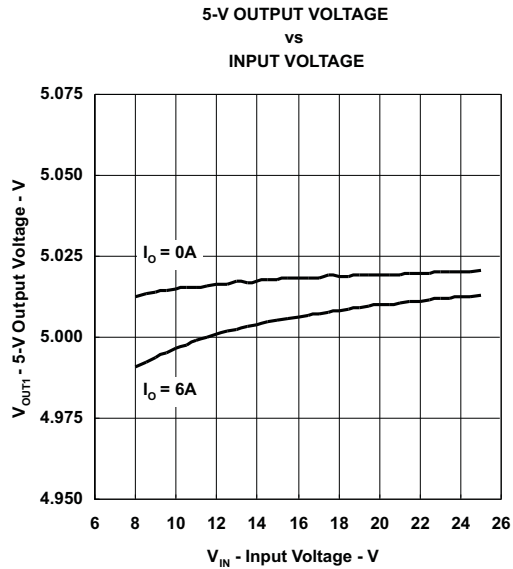

Figure 24.

TYPICAL CHARACTERISTICS (continued)

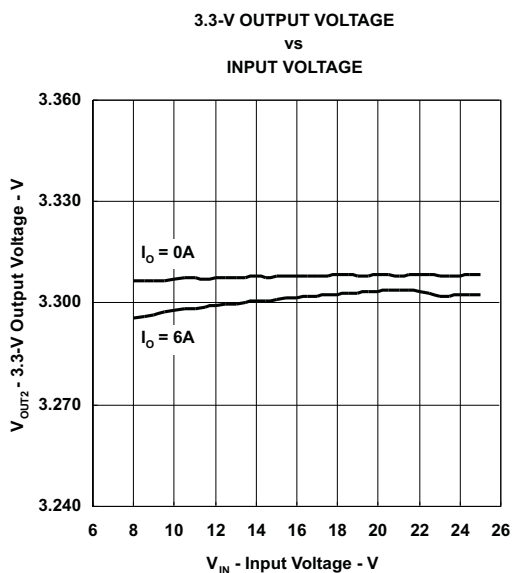

Figure 25.

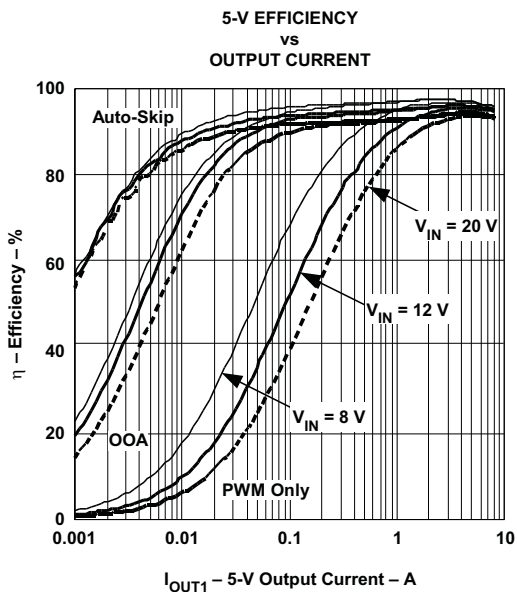

Figure 26.

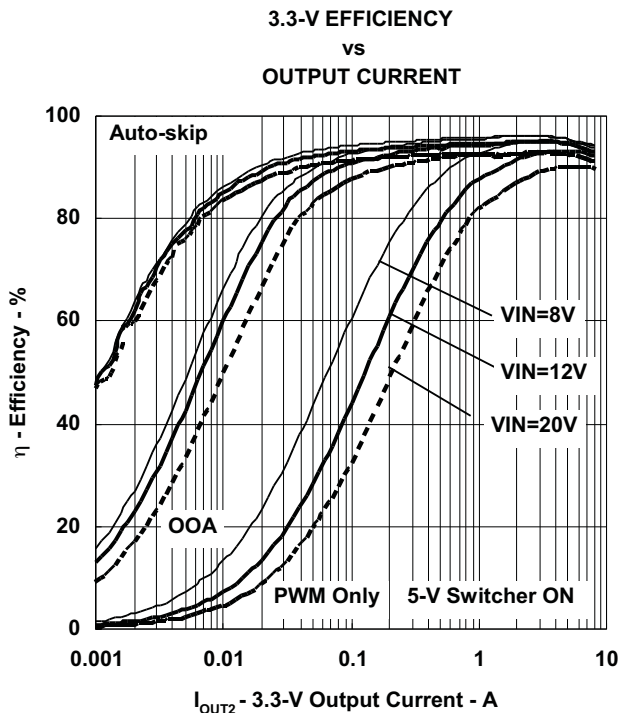

Figure 27.

TYPICAL CHARACTERISTICS (continued)

5-V Load Transient Response

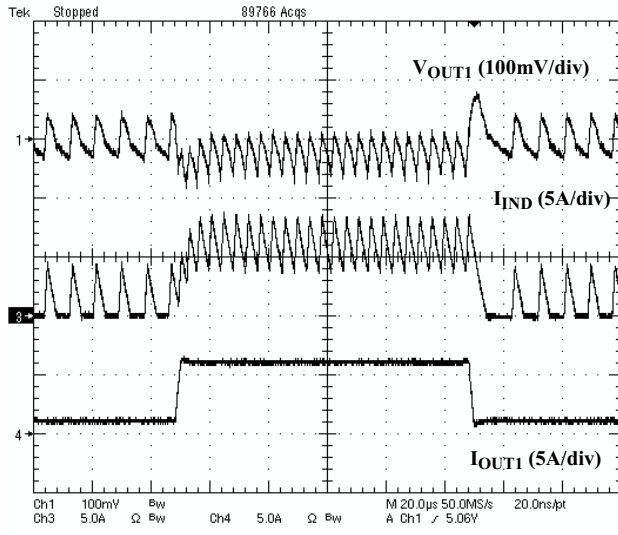

Figure 28.

3.3-V Load Transient Response

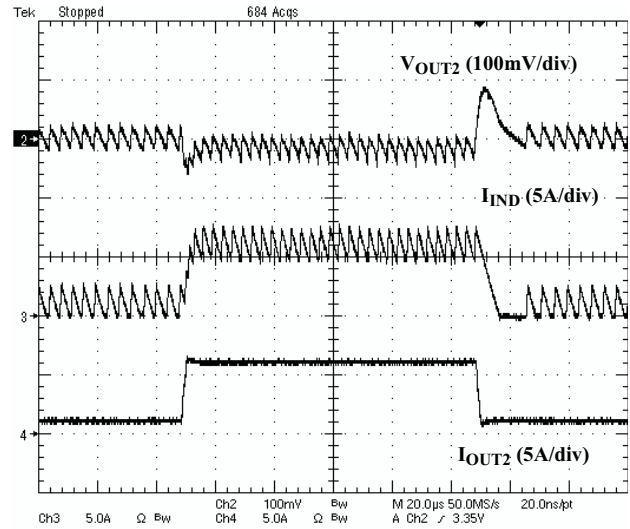

Figure 29.

5-V Startup Waveforms

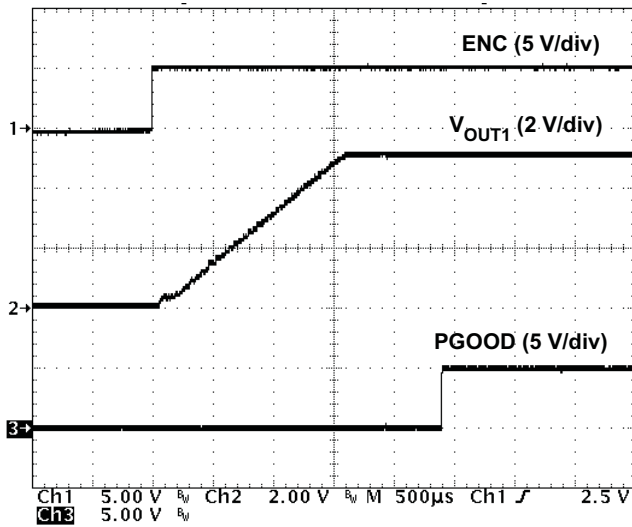

Figure 30.

3.3-V Startup Waveforms

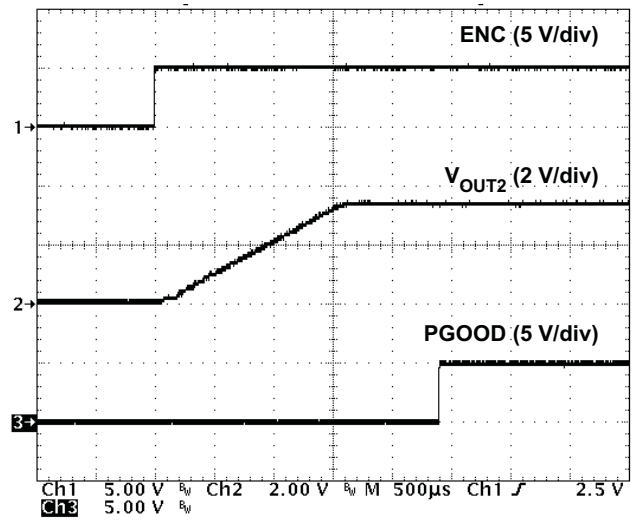

Figure 31.

TYPICAL CHARACTERISTICS (continued)

5-V Switchover Waveforms

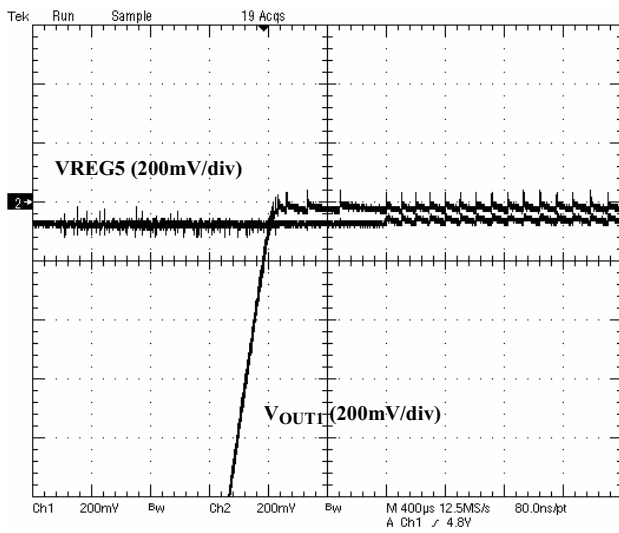

Figure 32.

3.3-V Switchover Waveforms

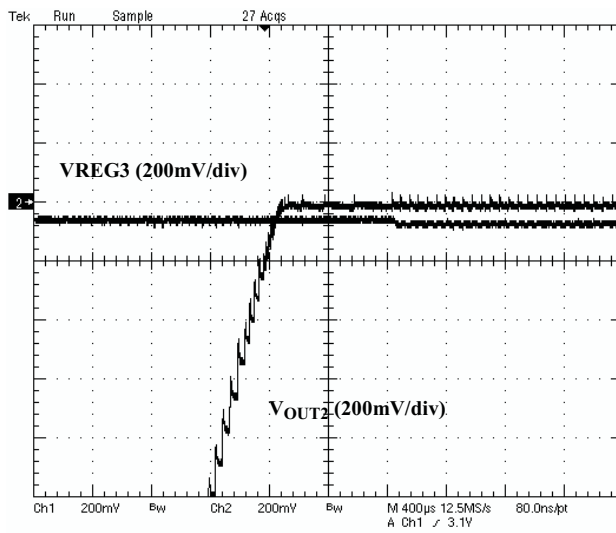

Figure 33.

5-V Soft-stop Waveforms

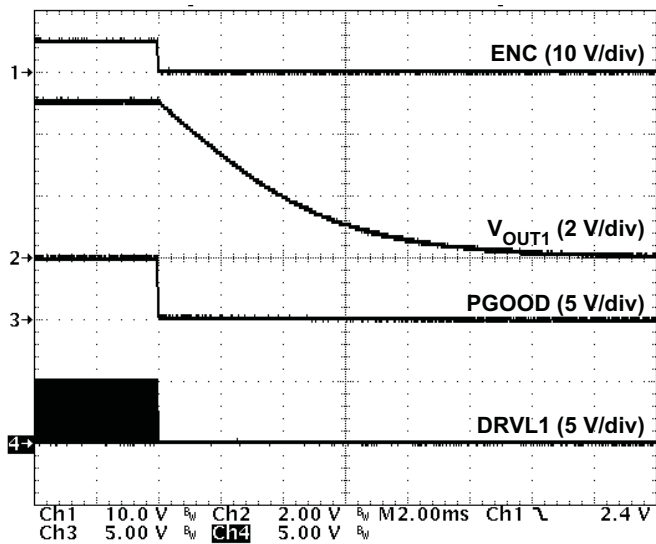

Figure 34.

3.3-V Soft-stop Waveforms

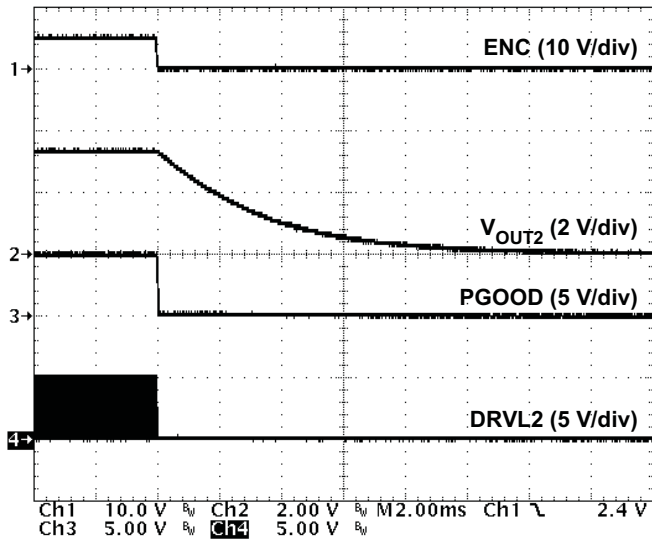

Figure 35.

APPLICATION INFORMATION

PWM Operations

The main control loop of the switch mode power supply (SMPS) is designed as an adaptive on-time pulse width modulation (PWM) controller. It supports a proprietary D-CAP™ mode. D-CAP™ mode does not require external compensation circuit and is suitable for low external component count configuration when used with appropriate amount of ESR at the output capacitor(s).

At the beginning of each cycle, the synchronous top MOSFET is turned on, or becomes 'ON' state. This MOSFET is turned off, or becomes OFF state, after internal one shot timer expires. This one shot is determined by V_{IN} and V_{OUT} to keep frequency fairly constant over input voltage range, hence it is called adaptive on-time control. The MOSFET is turned on again when the feedback point voltage, V_{VFBX} , decreased to match with internal 2-V reference. The inductor current information is also monitored and should be below the over current threshold to initiate this new cycle. Repeating operation in this manner, the controller regulates the output voltage. The synchronous bottom or the rectifying MOSFET is turned on at the beginning of each OFF state to keep the conduction loss minimum. The rectifying MOSFET is turned off before the top MOSFET turns on at next switching cycle or when inductor current information detects zero level. In the auto-skip mode or the OOA skip mode, this enables seamless transition to the reduced frequency operation at light load condition so that high-efficiency is kept over broad range of load current.

Adaptive On-Time Control and PWM Frequency

TPS51123A does not have a dedicated oscillator on board. However, the part runs with pseudo-constant frequency by feed-forwarding the input and output voltage into the on-time, one-shot timer. The on-time is controlled inverse proportional to the input voltage and proportional to the output voltage so that the duty ratio is kept as V_{OUT}/V_{IN} technically with the same cycle time. The frequencies are set by the TONSEL pin as shown in [Table 3](#).

Table 3. TONSEL Connection and Switching Frequency

TONSEL CONNECTION	SWITCHING FREQUENCY (kHz)	
	CH1	CH2
GND	200	250
VREF	245	305
VREG3	300	375
VREG5	365	460

Loop Compensation

From small-signal loop analysis, a buck converter using D-CAP™ mode can be simplified as below.

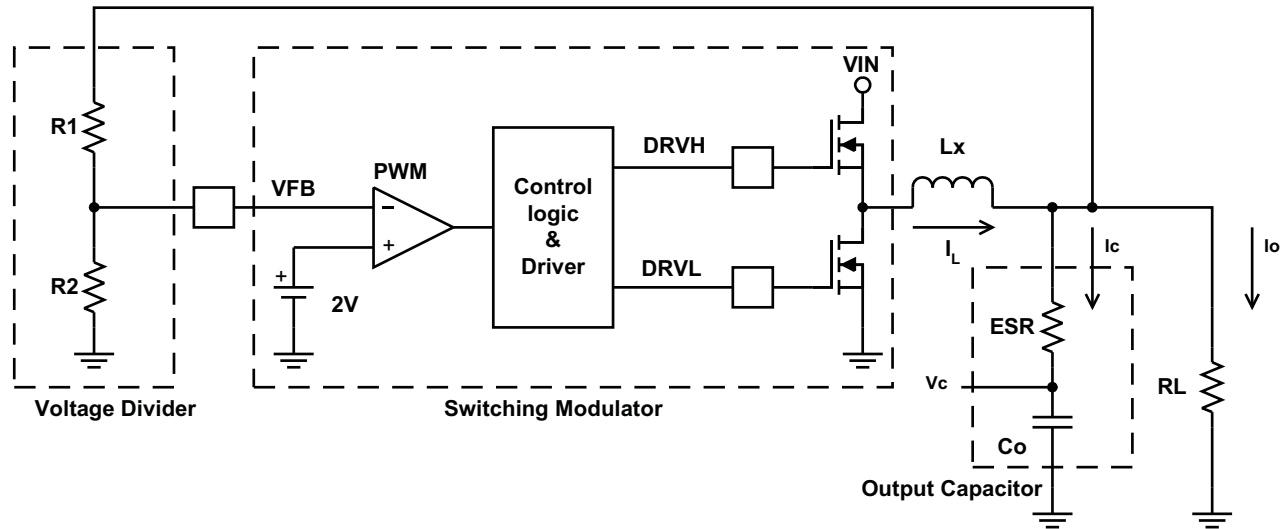

Figure 36. Simplifying the Modulator

The output voltage is compared with internal reference voltage after divider resistors, R1 and R2. The PWM comparator determines the timing to turn on high-side MOSFET. The gain and speed of the comparator is high enough to keep the voltage at the beginning of each on cycle substantially constant. For the loop stability, the 0dB frequency, f_0 , defined below need to be lower than 1/4 of the switching frequency.

$$f_0 = \frac{1}{2\pi \times \text{ESR} \times C_O} \leq \frac{f_{\text{SW}}}{4} \quad (1)$$

As f_0 is determined solely by the output capacitor's characteristics, loop stability of D-CAP™ mode is determined by the capacitor's chemistry. For example, specialty polymer capacitors (SP-CAP) have C_O in the order of several 100 μF and ESR in range of 10 m Ω . These make f_0 on the order of 100 kHz or less and the loop will be stable. However, ceramic capacitors have f_0 at more than 700 kHz, which is not suitable for this operational mode.

Ramp Signal

The TPS51123A adds a ramp signal to the 2-V reference in order to improve its jitter performance. As described in the previous section, the feedback voltage is compared with the reference information to keep the output voltage in regulation. By adding a small ramp signal to the reference, the signal-to-noise ratio at the onset of a new switching cycle is improved. Therefore the operation becomes less jitter and stable. The ramp signal is controlled to start with -20 mV at the beginning of ON-cycle and to become 0 mV at the end of OFF-cycle in steady state. By using this scheme, the TPS51123A improve jitter performance without sacrificing the reference accuracy.

Light Load Condition in Auto-Skip Operation

The TPS51123A automatically reduces switching frequency at light load conditions to maintain high-efficiency. This reduction of frequency is achieved smoothly and without increase of V_{OUT} ripple. Detail operation is described as follows. As the output current decreases from heavy load condition, the inductor current is also reduced and eventually comes to the point that its valley touches zero current, which is the boundary between continuous conduction and discontinuous conduction modes. The rectifying MOSFET is turned off when this zero inductor current is detected. As the load current further decreased, the converter runs in discontinuous conduction mode and it takes longer and longer to discharge the output capacitor to the level that requires next ON cycle. The ON time is kept the same as that in the heavy load condition. In reverse, when the output current increase from light load to heavy load, switching frequency increases to the preset value as the inductor current reaches to the continuous conduction. The transition load point to the light load operation $I_{OUT(LL)}$ (i.e. the threshold between continuous and discontinuous conduction mode) can be calculated as follows;

$$I_{OUT(LL)} = \frac{1}{2 \times L \times f} \times \frac{(V_{IN} - V_{OUT}) \times V_{OUT}}{V_{IN}} \quad (2)$$

where f is the PWM switching frequency.

Switching frequency versus output current in the light load condition is a function of L , V_{IN} and V_{OUT} , but it decreases almost proportional to the output current from the $I_{OUT(LL)}$ shown in [Equation 2](#). For example, it is 60 kHz at $I_{OUT(LL)}/5$ if the frequency setting is 300 kHz.

Out-of-Audio™ Light-Load Operation

Out-of-Audio™ (OOA) light-load mode is a unique control feature that keeps the switching frequency above acoustic audible frequencies toward virtually no load condition while maintaining best of the art high conversion efficiency. When the Out-of-Audio™ operation is selected, OOA control circuit monitors the states of both MOSFET and force to change into the ON state if both of MOSFETs are off for more than 32 μ s. This means that the top MOSFET is turned on even if the output voltage is higher than the target value so that the output capacitor is tends to be overcharged.

The OOA control circuit detects the over-voltage condition and begins to modulate the on time to keep the output voltage regulated. As a result, the output voltage becomes 0.5% higher than normal light-load operation.

Enable and Soft Start

EN0 is the control pin of VREG5, VREG3 and VREF regulators. Bring this node down to GND disables those three regulators and minimize the shutdown supply current to 10 μ A. Pulling this node up to 3.3 V or 5 V will turn the three regulators on to standby mode. The two switch mode power supplies (channel-1, channel-2) become ready to enable at this standby mode. The TPS51123A has an internal, 1.6 ms, voltage servo soft-start for each channel.

Both channel 1 and channel 2 can be enabled simultaneously with the ENC pin when only the OCL trip setting resistance is connected to TRIPx pin. Channel 1 and channel 2 can be disabled independently by shorting the TRIPx pin to ground when the ENC pin voltage is higher than its enable threshold, which is typically 1.26 V. After enabling channel 1 and/or channel 2, an internal DAC begins ramping up the reference voltage of the PWM comparator. Smooth control of the output voltage is maintained during start up. As TPS51123A shares one DAC with both channels, if TRIPx pin becomes higher than the enable threshold voltage while another channel is starting up, soft-start is postponed until another channel soft-start has completed. If both of TRIP1 and TRIP2 become higher than the enable threshold voltage at the same time (within 60 μ s), both channels start up simultaneously.

Table 4. Enabling State

EN0	ENC	TRIP1	TRIP2	VREF	VREG5	VREG3	CH1	CH2
GND	No effect ⁽¹⁾	No effect ⁽¹⁾	No effect ⁽¹⁾	Off	Off	Off	Off	Off
Open	Low	No effect ⁽¹⁾	No effect ⁽¹⁾	On	On	On	Off	Off
Open	High	Low	Low	On	On	On	Off	Off
Open	High	High	Low	On	On	On	On	Off
Open	High	Low	High	On	On	On	Off	On
Open	High	High	High	On	On	On	On	On

(1) Either high or low, does no affect the enable state.

VREG5/VREG3 Linear Regulators

There are two sets of 100-mA standby linear regulators which outputs 5 V and 3.3 V, respectively. The VREG5 serves as the main power supply for the analog circuitry of the device and provides the current for gate drivers. The VREG3 is intended mainly for auxiliary 3.3-V supply for the notebook system during standby mode.

Add a high-quality X5R or X7R ceramic capacitor with a value of 10- μ F or larger placed close to the VREG5 and VREG3 pins to stabilize LDOs. For VREG3, a 1- μ F ceramic capacitor is acceptable when not loaded.

VREG5 Switch Over

When the VO1 voltage becomes higher than 4.7 V AND channel-1 internal powergood flag is generated, internal 5-V LDO regulator is shut off and the VREG5 output is connected to VO1 by internal switch over MOSFET. The 510- μ s powergood delay helps a switch over without glitch.

VREG3 Switch Over

When the VO2 voltage becomes higher than 3.15 V AND channel-2 internal powergood flag is generated, internal 3.3-V LDO regulator is shut off and the VREG3 output is connected to VO2 by internal switch over MOSFET. The 510- μ s powergood delay helps a switch over without glitch.

Powergood

The TPS51123A has one powergood output that indicates a high state when both switcher outputs are within the targets (AND gated). The powergood function is activated with 2-ms internal delay after ENC goes high. If the output voltage becomes within $\pm 5\%$ of the target value, internal comparators detect power good state and the powergood signal becomes high after 510- μ s internal delay. Therefore PGOOD goes high around 2.5 ms after ENC goes high. If the output voltage goes outside of $\pm 10\%$ of the target value, the powergood signal becomes low after 2- μ s internal delay. The powergood output is an open drain output and is needed to be pulled up outside.

Also note that, in the case of Auto-skip or Out-of-Audio™ mode, if the output voltage goes +10% above the target value and the power-good signal flags low, then the loop attempts to correct the output by turning on the low-side driver (forced PWM mode). After the feedback voltage returns to be within +5% of the target value and the power-good signal goes high, the controller returns back to auto-skip mode or Out-of-Audio™ mode.

Output Discharge Control

When ENC is low, the TPS51123A discharges outputs using internal MOSFET which is connected to VOx and GND. The current capability of these MOSFETs is limited to discharge slowly.

Low-Side Driver

The low-side driver is designed to drive high current low $R_{DS(on)}$ N-channel MOSFET(s). The drive capability is represented by its internal resistance, which are 4 Ω for VREG5 to DRVLx and 1.5 Ω for DRVLx to GND. A dead time to prevent shoot through is internally generated between top MOSFET off to bottom MOSFET on, and bottom MOSFET off to top MOSFET on. 5-V bias voltage is delivered from VREG5 supply. The instantaneous drive current is supplied by an input capacitor connected between VREG5 and GND. The average drive current is equal to the gate charge at $V_{gs} = 5\text{ V}$ times switching frequency. This gate drive current as well as the high-side gate drive current times 5 V makes the driving power which need to be dissipated from TPS51123A package.

High-Side Driver

The high-side driver is designed to drive high current, low $R_{DS(on)}$ N-channel MOSFET(s). When configured as a floating driver, 5-V bias voltage is delivered from VREG5 supply. The average drive current is also calculated by the gate charge at $V_{gs} = 5\text{ V}$ times switching frequency. The instantaneous drive current is supplied by the flying capacitor between VBSTx and LLx pins. The drive capability is represented by its internal resistance, which are 4 Ω for VBSTx to DRVHx and 1.5 Ω for DRVHx to LLx.

Current Protection

TPS51123A has cycle-by-cycle over current limiting control. The inductor current is monitored during the 'OFF' state and the controller keeps the 'OFF' state during the inductor current is larger than the over current trip level. In order to provide both good accuracy and cost effective solution, TPS51123A supports temperature compensated MOSFET $R_{DS(on)}$ sensing. The TRIPx pin should be connected to GND through the trip voltage setting resistor, R_{TRIP} . TRIPx terminal sources I_{TRIP} current, which is 10 μA typically at room temperature, and the trip level is set to the OCL trip voltage V_{TRIP} as below. Note that the V_{TRIP} is limited up to about 205 mV internally.

$$V_{TRIP} (\text{mV}) = \frac{R_{TRIP} (\text{k}\Omega) \times I_{TRIP} (\mu\text{A})}{9} - 24 (\text{mV}) \quad (3)$$

Note that when TRIPx voltage is under a certain threshold (typically 0.4V), the switcher channel concerned is shut down. The inductor current is monitored by the voltage between GND pin and LLx pin so that LLx pin should be connected to the drain terminal of the bottom MOSFET properly. I_{trip} has 4500 ppm/°C temperature slope to compensate the temperature dependency of the $R_{DS(on)}$. GND is used as the positive current sensing node so that GND should be connected to the proper current sensing device, i.e. the source terminal of the bottom MOSFET.

As the comparison is done during the OFF state, V_{TRIP} sets valley level of the inductor current. Thus, the load current at over current threshold, I_{OCP} , can be calculated in Equation 4.

$$I_{OCP} = \frac{V_{TRIP}}{R_{DS(on)}} + \frac{I_{RIPPLE}}{2} = \frac{V_{TRIP}}{R_{DS(on)}} + \frac{1}{2 \times L \times f} \times \frac{(V_{IN} - V_{OUT}) \times V_{OUT}}{V_{IN}} \quad (4)$$

In an overcurrent condition, the current to the load exceeds the current to the output capacitor thus the output voltage tends to fall down. Eventually, it ends up with crossing the under voltage protection threshold and shutdown both channels.

Overvoltage and Undervoltage Protection

TPS51123A monitors a resistor divided feedback voltage to detect over and under voltage. When the feedback voltage becomes higher than 115% of the target voltage, the OVP comparator output goes high and the circuit latches as the top MOSFET driver OFF and the bottom MOSFET driver ON.

Also, TPS51123A monitors VOx voltage directly and if it becomes greater than 5.75 V the TPS51123A turns off the top MOSFET driver.

When the feedback voltage becomes lower than 60% of the target voltage, the UVP comparator output goes high and an internal UVP delay counter begins counting. After 32 μ s, TPS51123A latches OFF both top and bottom MOSFETs drivers, and shut off both drivers of another channel. This function is enabled after 2 ms following ENC has become high.

UVLO Protection

TPS51123A has VREG5 under voltage lock out protection (UVLO). When the VREG5 voltage is lower than UVLO threshold voltage both switch mode power supplies are shut off. This is non-latch protection. When the VREG3 voltage is lower than ($V_{OUT2} - 1\text{ V}$), both switch mode power supplies are also shut off

Thermal Shutdown

TPS51123A monitors the temperature of itself. If the temperature exceeds the threshold value (typically 150°C), TPS51123A is shut off including LDOs. This is non-latch protection.

External Parts Selection

The external components selection is much simple in D-CAP™ Mode.

1. Determine output voltage

The output voltage is programmed by the voltage-divider resistor, R1 and R2, as shown in [Figure 36](#). R1 is connected between VFBx pin and the output, and R2 is connected between the VFBx pin and GND.

Recommended R2 value is from 10 kΩ to 20 kΩ. Determine R1 using equation as below.

$$R1 = \frac{(V_{OUT} - 2.0)}{2.0} \times R2 \quad (5)$$

2. Choose the Inductor

The inductance value should be determined to give the ripple current of approximately 1/4 to 1/2 of maximum output current. Larger ripple current increases output ripple voltage and improves S/N ratio and helps stable operation.

$$L = \frac{1}{I_{IND(ripple)} \times f} \times \frac{(V_{IN(max)} - V_{OUT}) \times V_{OUT}}{V_{IN(max)}} = \frac{3}{I_{OUT(max)} \times f} \times \frac{(V_{IN(max)} - V_{OUT}) \times V_{OUT}}{V_{IN(max)}} \quad (6)$$

The inductor also needs to have low DCR to achieve good efficiency, as well as enough room above peak inductor current before saturation. The peak inductor current can be estimated as follows.

$$I_{IND(peak)} = \frac{V_{TRIP}}{R_{DS(on)}} + \frac{1}{L \times f} \times \frac{(V_{IN(max)} - V_{OUT}) \times V_{OUT}}{V_{IN(max)}} \quad (7)$$

3. Choose the Output Capacitor(s)

Organic semiconductor capacitor(s) or specialty polymer capacitor(s) are recommended. Determine ESR to meet required ripple voltage. A quick approximation is as shown in [Equation 8](#). This equation is based on that required output ripple slope is approximately 20 mV per T_{SW} (switching period) in terms of VFB terminal voltage.

$$ESR = \frac{V_{OUT} \times 20(\text{mV}) \times (1-D)}{2(\text{V}) \times I_{RIPPLE}} = \frac{20(\text{mV}) \times L \times f}{2(\text{V})}$$

where

- D is the duty cycle
 - the required output ripple slope is approximately 20 mV per t_{SW} (switching period) in terms of VFB terminal voltage
- (8)

4. Choose the Low-Side MOSFET

It is highly recommended that the low-side MOSFET should have an integrated Schottky barrier diode, or an external Schottky barrier diode in parallel to achieve stable operation.

Layout Considerations

Certain points must be considered before starting a layout work using the TPS51123A.

- TPS51123A has only one GND pin and special care of GND trace design makes operation stable, especially when both channels operate. Group GND terminals of output voltage divider of both channels and the VREF capacitor as close as possible, and connect them to an inner GND plane with PowerPad and the overcurrent setting resistor, as shown in the thin GND line of [Figure 37](#). This trace is named Signal Ground (SGND). Group ground terminals of VIN capacitor(s), VOUT capacitor(s) and source of low-side MOSFETs as close as possible, and connect them to another inner GND plane with GND pin of the device and the GND terminal of VREG3 and VREG5 capacitors, as shown in the bold GND line of [Figure 37](#). This trace is named Power Ground (PGND). SGND should be connected to PGND at the middle point between ground terminal of V_{OUT} capacitors.
- Inductor, V_{OUT} capacitor(s), V_{IN} capacitor(s) and MOSFETs are the power components and should be placed on one side of the PCB (solder side). Power components of each channel should be at the same distance from the TPS51123A. Other small signal parts should be placed on another side (component side). Inner GND planes should shield and isolate the small signal traces from noisy power lines.
- PCB trace defined as LLx node, which connects to source of high-side MOSFET, drain of low-side MOSFET and high-voltage side of the inductor, should be as short and wide as possible.
- A high-quality X5R or X7R ceramic bypass capacitor should be placed close to the device and traces should be no longer than 10 mm. Use the following capacitance values.
 - VREG5: 10 µF or larger
 - VREG3: 10 µF or larger (1 µF is acceptable when not loaded)
 - VREF: between 220 nF and 1 µF
- Connect the overcurrent setting resistors from TRIPx to SGND and close to the device, right next to the device if possible.
- The discharge path (VOx) should have a dedicated trace to the output capacitor; separate from the output voltage sensing trace. When LDO5 is switched over Vo1 trace should be 1.5 mm with no loops. When LDO3 is switched over and loaded VO2 trace should also be 1.5 mm with no loops. There is no restriction for just monitoring Vox. Make the feedback current setting resistor (the resistor between VFBx to SGND) close to the device. Place on the component side and avoid vias between this resistor and the device.
- Connections from the drivers to the respective gate of the high-side or the low-side MOSFET should be as short as possible to reduce stray inductance. Use 0.65-mm (25 mils) or wider trace and via(s) of at least 0.5 mm (20 mils) diameter along this trace.
- All sensitive analog traces and components such as VOx, VFBx, VREF, GND, EN0, TRIPx, PGOOD, TONSEL and SKIPSEL should be placed away from high-voltage switching nodes such as LLx, DRVLx, and DRVHx nodes to avoid coupling.
- Traces for VFB1 and VFB2 should be short and laid apart each other to avoid channel to channel interference.
- In order to effectively remove heat from the package, prepare thermal land and solder to the package's thermal pad. Three by three or more vias with a 0.33-mm (13 mils) diameter connected from the thermal land to the internal ground plane should be used to help dissipation. This thermal land underneath the package should be connected to SGND, and should NOT be connected to PGND.

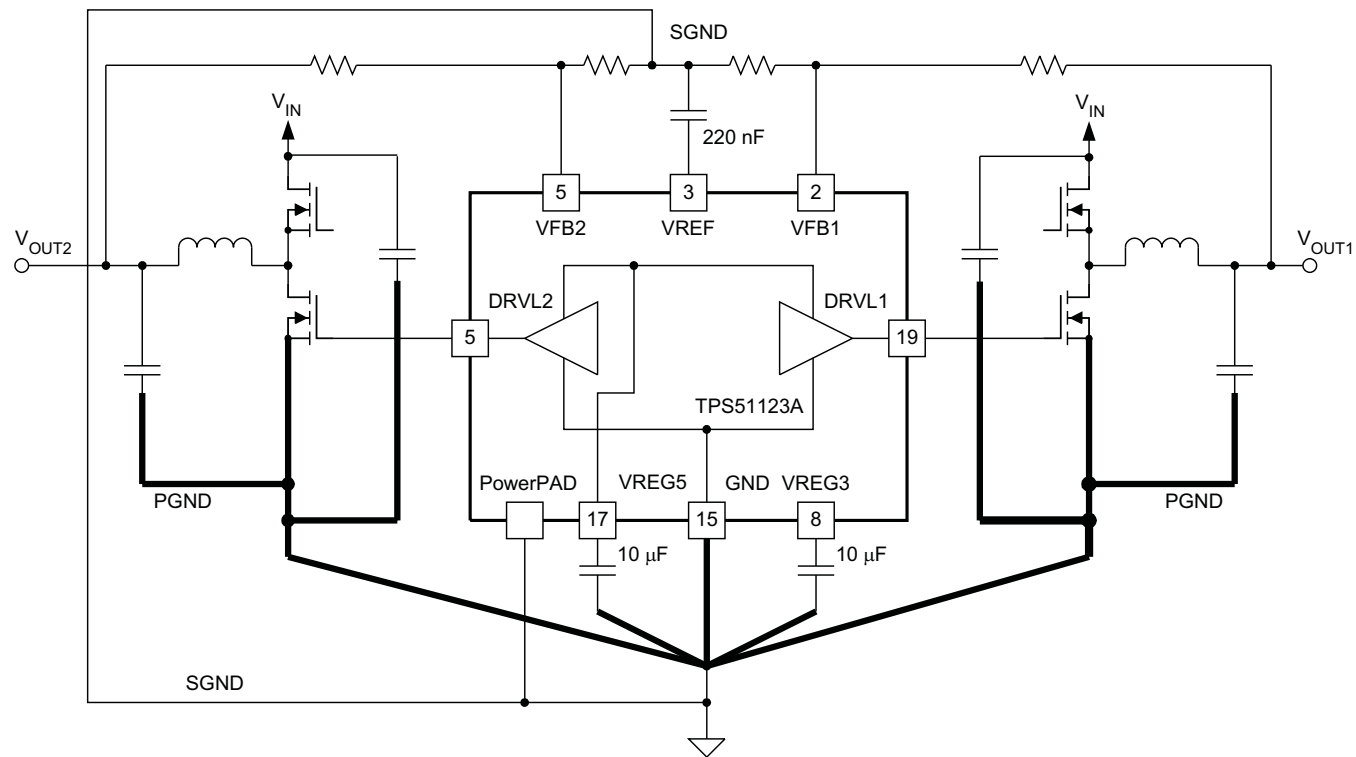

UDG-10087

Figure 37. Ground System

* Driver and switch node traces are shown for CH1 only.

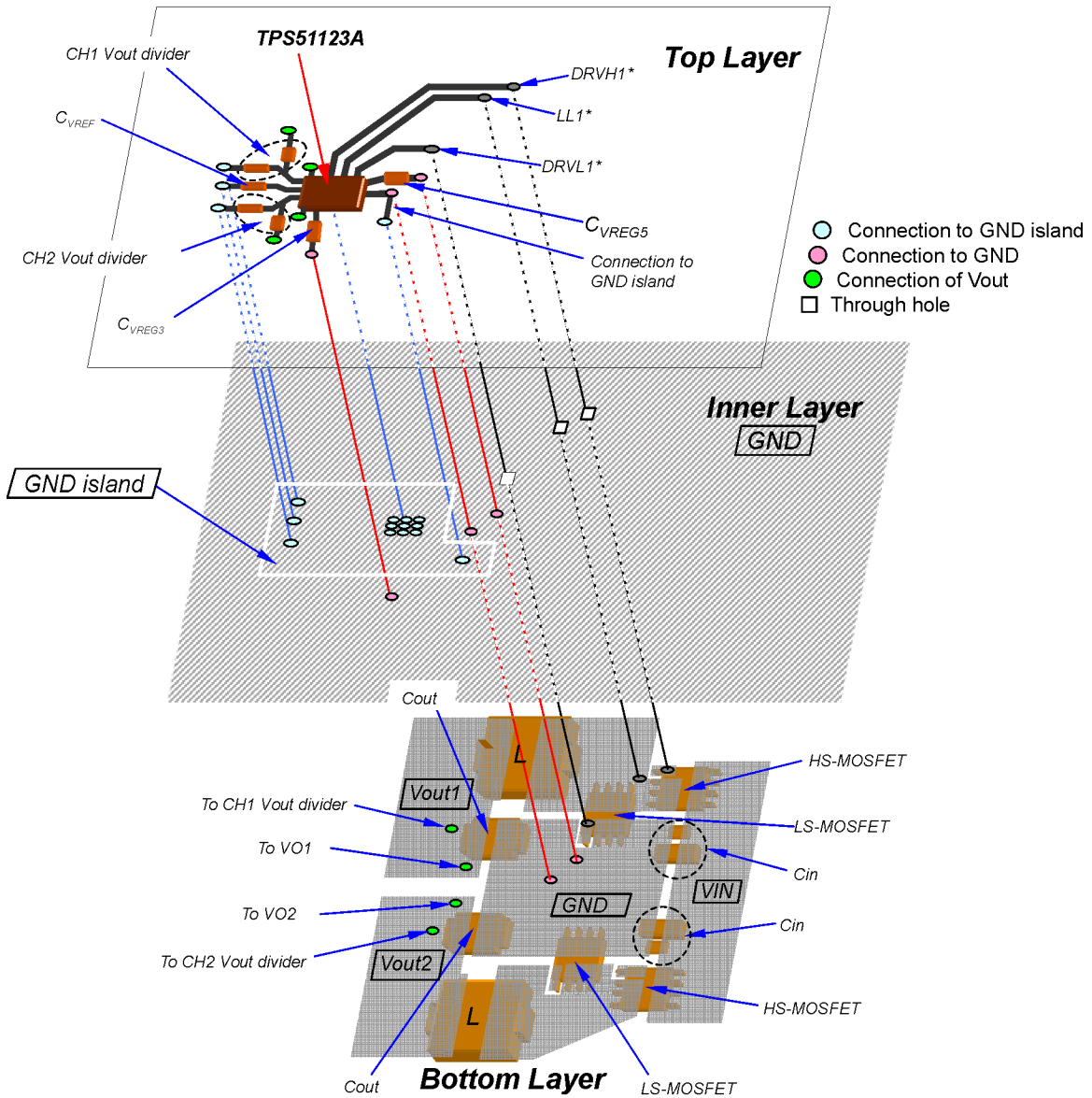

Figure 38. PCB Layout

Application Circuit

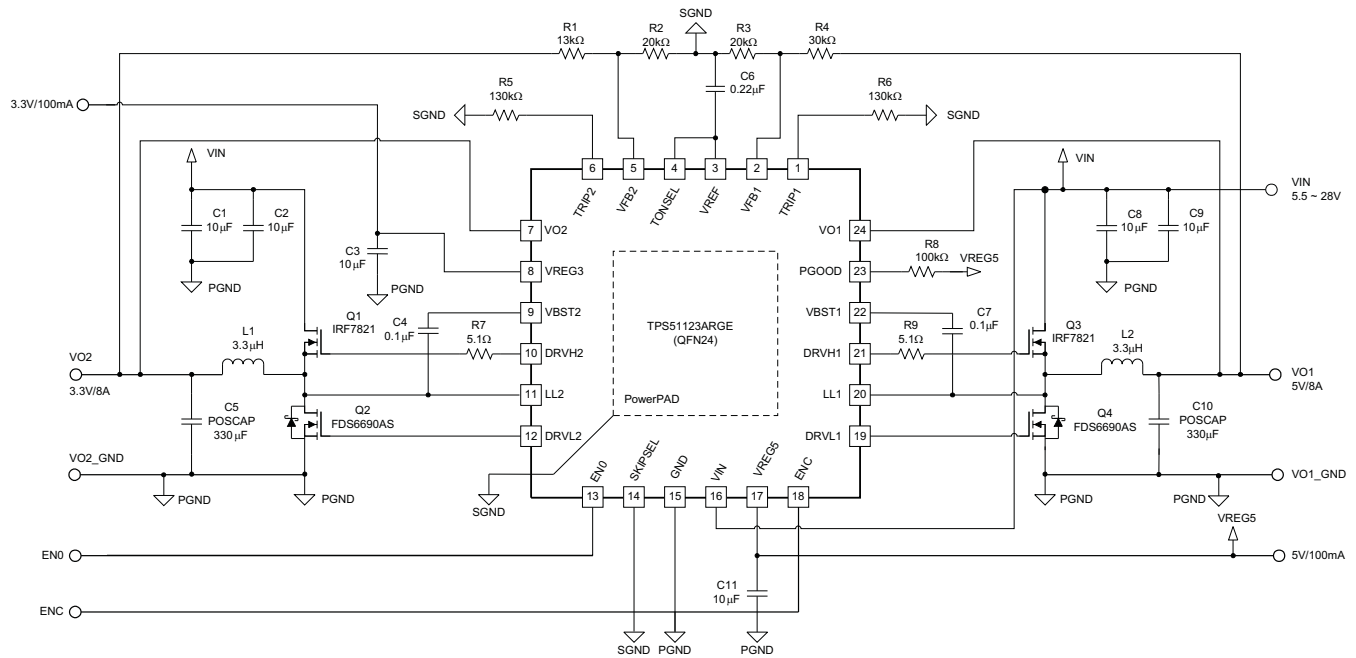

Figure 39. 5-V/8-A, 3.3-V/8-A Application Circuit (245-kHz/305-kHz Setting)

Table 5. List of Materials for 5-V/8-A, 3.3-V/8-A Application Circuit

REFERENCE DESIGNATOR	SPECIFICATION	MANUFACTURER	PART NUMBER
C1, C2, C8, C9	10 μ F/25 V	Taiyo Yuden	TMK325BJ106MM
C3, C11	10 μ F/6.3 V	TDK	C2012X5R0J106K
C5, C10	330 μ F/6.3 V/25 m Ω	Sanyo	6TPE330ML
L1, L2	3.3 μ H, 15.6 A, 5.92 m Ω	TOKO	FDA1055-3R3M
Q1, Q3	30 V, 9.5 m Ω	IR	IRF7821
Q2, Q4 ⁽¹⁾	30 V, 12 m Ω	Fairchild	FDS6690AS

(1) Use a MOSFET with an integrated Schottky barrier diode (SBD) for the low-side, or add an SBD in parallel with a normal MOSFET.

REVISION HISTORY

Changes from Revision A (May 2011) to Revision B **Page**

- Added LL1, LL2, pulse width < 20 ns parameters with a value of -5.0 V to 30 V. **3**
-

Changes from Revision B (MARCH 2012) to Revision C **Page**

- ESD ratings in ABSOLUTE MAXIMUM RATINGS table **3**
-

PACKAGING INFORMATION

Orderable Device	Status (1)	Package Type	Package Drawing	Pins	Package Qty	Eco Plan (2)	Lead finish/ Ball material (6)	MSL Peak Temp (3)	Op Temp (°C)	Device Marking (4/5)	Samples
TPS51123ARGER	ACTIVE	VQFN	RGE	24	3000	RoHS & Green	NIPDAU	Level-2-260C-1 YEAR	-40 to 85	51123A	Samples
TPS51123ARGET	ACTIVE	VQFN	RGE	24	250	RoHS & Green	NIPDAU	Level-2-260C-1 YEAR	-40 to 85	51123A	Samples

(1) The marketing status values are defined as follows:

ACTIVE: Product device recommended for new designs.

LIFEBUY: TI has announced that the device will be discontinued, and a lifetime-buy period is in effect.

NRND: Not recommended for new designs. Device is in production to support existing customers, but TI does not recommend using this part in a new design.

PREVIEW: Device has been announced but is not in production. Samples may or may not be available.

OBSOLETE: TI has discontinued the production of the device.

(2) **RoHS:** TI defines "RoHS" to mean semiconductor products that are compliant with the current EU RoHS requirements for all 10 RoHS substances, including the requirement that RoHS substance do not exceed 0.1% by weight in homogeneous materials. Where designed to be soldered at high temperatures, "RoHS" products are suitable for use in specified lead-free processes. TI may reference these types of products as "Pb-Free".

RoHS Exempt: TI defines "RoHS Exempt" to mean products that contain lead but are compliant with EU RoHS pursuant to a specific EU RoHS exemption.

Green: TI defines "Green" to mean the content of Chlorine (Cl) and Bromine (Br) based flame retardants meet JS709B low halogen requirements of <=1000ppm threshold. Antimony trioxide based flame retardants must also meet the <=1000ppm threshold requirement.

(3) MSL, Peak Temp. - The Moisture Sensitivity Level rating according to the JEDEC industry standard classifications, and peak solder temperature.

(4) There may be additional marking, which relates to the logo, the lot trace code information, or the environmental category on the device.

(5) Multiple Device Markings will be inside parentheses. Only one Device Marking contained in parentheses and separated by a "~" will appear on a device. If a line is indented then it is a continuation of the previous line and the two combined represent the entire Device Marking for that device.

(6) Lead finish/Ball material - Orderable Devices may have multiple material finish options. Finish options are separated by a vertical ruled line. Lead finish/Ball material values may wrap to two lines if the finish value exceeds the maximum column width.

Important Information and Disclaimer:The information provided on this page represents TI's knowledge and belief as of the date that it is provided. TI bases its knowledge and belief on information provided by third parties, and makes no representation or warranty as to the accuracy of such information. Efforts are underway to better integrate information from third parties. TI has taken and continues to take reasonable steps to provide representative and accurate information but may not have conducted destructive testing or chemical analysis on incoming materials and chemicals. TI and TI suppliers consider certain information to be proprietary, and thus CAS numbers and other limited information may not be available for release.

In no event shall TI's liability arising out of such information exceed the total purchase price of the TI part(s) at issue in this document sold by TI to Customer on an annual basis.

TAPE AND REEL INFORMATION

QUADRANT ASSIGNMENTS FOR PIN 1 ORIENTATION IN TAPE

*All dimensions are nominal

Device	Package Type	Package Drawing	Pins	SPQ	Reel Diameter (mm)	Reel Width W1 (mm)	A0 (mm)	B0 (mm)	K0 (mm)	P1 (mm)	W (mm)	Pin1 Quadrant
TPS51123ARGER	VQFN	RGE	24	3000	330.0	12.4	4.25	4.25	1.15	8.0	12.0	Q2
TPS51123ARGET	VQFN	RGE	24	250	180.0	12.4	4.25	4.25	1.15	8.0	12.0	Q2

TAPE AND REEL BOX DIMENSIONS

*All dimensions are nominal

Device	Package Type	Package Drawing	Pins	SPQ	Length (mm)	Width (mm)	Height (mm)
TPS51123ARGER	VQFN	RGE	24	3000	346.0	346.0	33.0
TPS51123ARGET	VQFN	RGE	24	250	210.0	185.0	35.0

RGE 24

GENERIC PACKAGE VIEW

VQFN - 1 mm max height

PLASTIC QUAD FLATPACK - NO LEAD



Images above are just a representation of the package family, actual package may vary.
Refer to the product data sheet for package details.

4204104/H

RGE0024B



PACKAGE OUTLINE

VQFN - 1 mm max height

PLASTIC QUAD FLATPACK - NO LEAD

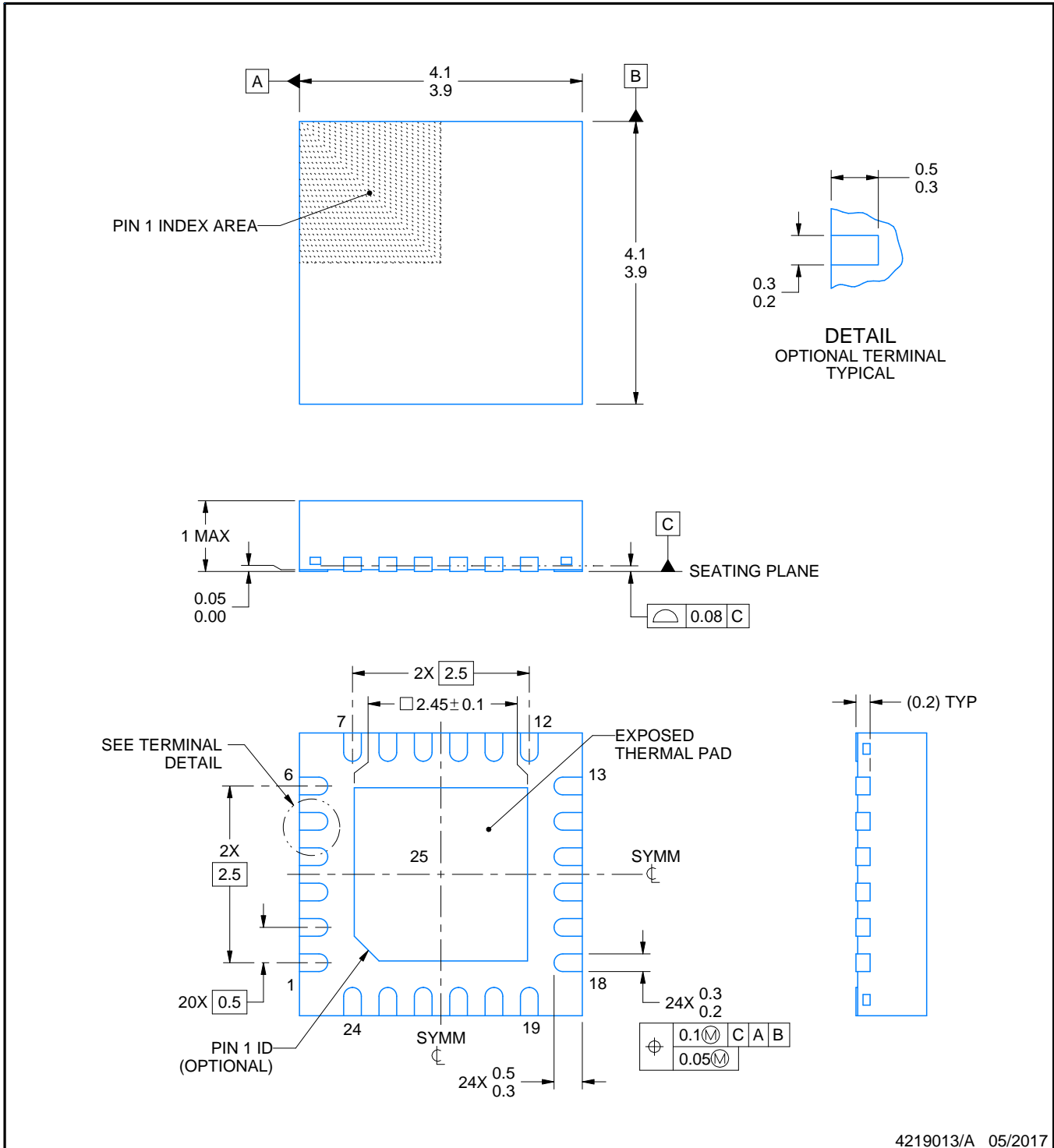

4219013/A 05/2017

NOTES:

1. All linear dimensions are in millimeters. Any dimensions in parenthesis are for reference only. Dimensioning and tolerancing per ASME Y14.5M.
2. This drawing is subject to change without notice.
3. The package thermal pad must be soldered to the printed circuit board for thermal and mechanical performance.

EXAMPLE BOARD LAYOUT

RGE0024B

VQFN - 1 mm max height

PLASTIC QUAD FLATPACK - NO LEAD

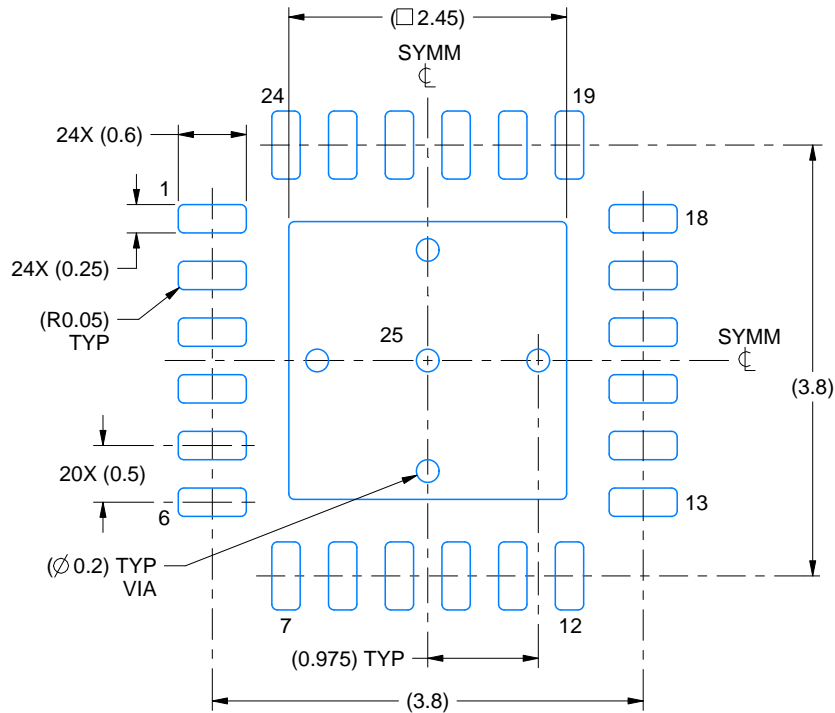

LAND PATTERN EXAMPLE
EXPOSED METAL SHOWN
SCALE:15X

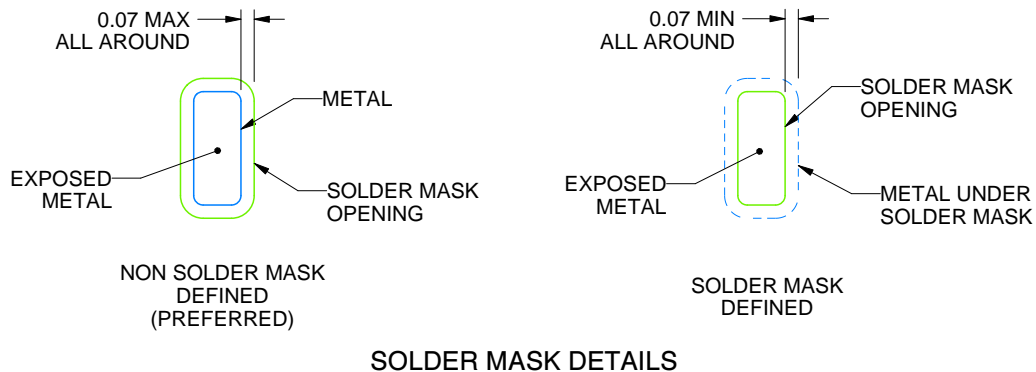

SOLDER MASK DETAILS

4219013/A 05/2017

NOTES: (continued)

4. This package is designed to be soldered to a thermal pad on the board. For more information, see Texas Instruments literature number SLUA271 (www.ti.com/lit/sluea271).
5. Vias are optional depending on application, refer to device data sheet. If any vias are implemented, refer to their locations shown on this view. It is recommended that vias under paste be filled, plugged or tented.

EXAMPLE STENCIL DESIGN

RGE0024B

VQFN - 1 mm max height

PLASTIC QUAD FLATPACK - NO LEAD

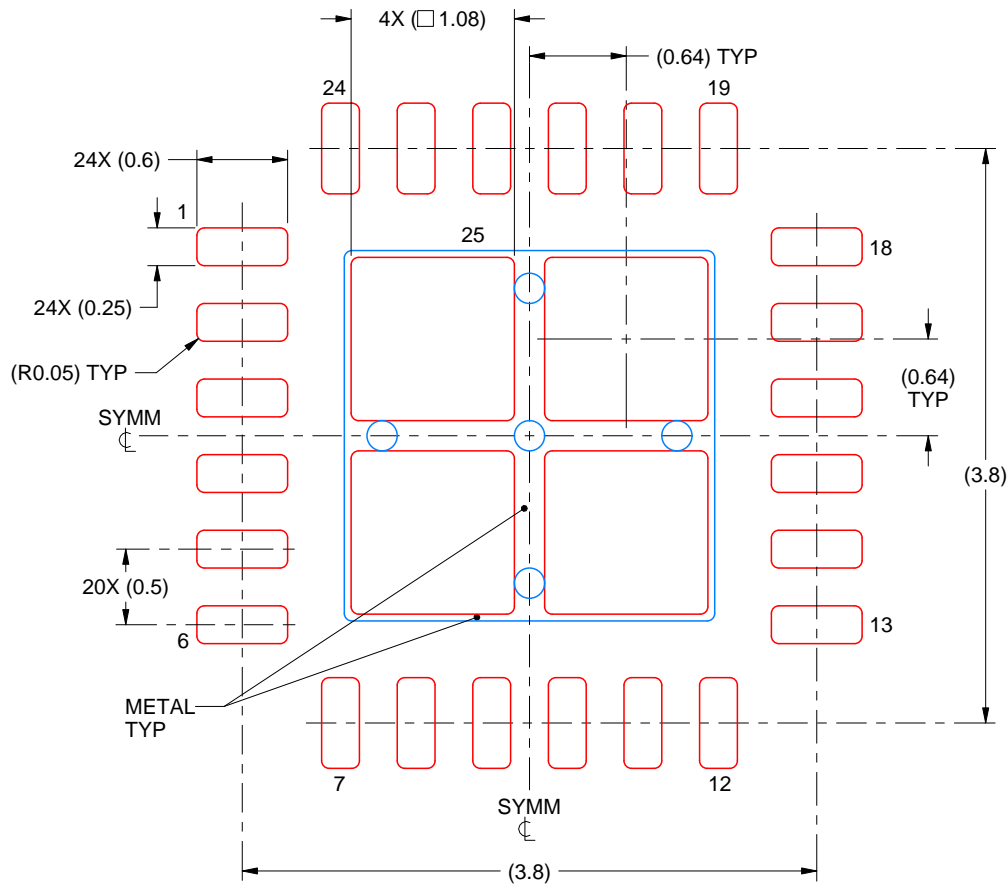

SOLDER PASTE EXAMPLE
BASED ON 0.125 mm THICK STENCIL

EXPOSED PAD 25
78% PRINTED SOLDER COVERAGE BY AREA UNDER PACKAGE
SCALE:20X

4219013/A 05/2017

NOTES: (continued)

6. Laser cutting apertures with trapezoidal walls and rounded corners may offer better paste release. IPC-7525 may have alternate design recommendations.

IMPORTANT NOTICE AND DISCLAIMER

TI PROVIDES TECHNICAL AND RELIABILITY DATA (INCLUDING DATA SHEETS), DESIGN RESOURCES (INCLUDING REFERENCE DESIGNS), APPLICATION OR OTHER DESIGN ADVICE, WEB TOOLS, SAFETY INFORMATION, AND OTHER RESOURCES "AS IS" AND WITH ALL FAULTS, AND DISCLAIMS ALL WARRANTIES, EXPRESS AND IMPLIED, INCLUDING WITHOUT LIMITATION ANY IMPLIED WARRANTIES OF MERCHANTABILITY, FITNESS FOR A PARTICULAR PURPOSE OR NON-INFRINGEMENT OF THIRD PARTY INTELLECTUAL PROPERTY RIGHTS.

These resources are intended for skilled developers designing with TI products. You are solely responsible for (1) selecting the appropriate TI products for your application, (2) designing, validating and testing your application, and (3) ensuring your application meets applicable standards, and any other safety, security, regulatory or other requirements.

These resources are subject to change without notice. TI grants you permission to use these resources only for development of an application that uses the TI products described in the resource. Other reproduction and display of these resources is prohibited. No license is granted to any other TI intellectual property right or to any third party intellectual property right. TI disclaims responsibility for, and you will fully indemnify TI and its representatives against, any claims, damages, costs, losses, and liabilities arising out of your use of these resources.

TI's products are provided subject to [TI's Terms of Sale](#) or other applicable terms available either on [ti.com](https://www.ti.com) or provided in conjunction with such TI products. TI's provision of these resources does not expand or otherwise alter TI's applicable warranties or warranty disclaimers for TI products.

TI objects to and rejects any additional or different terms you may have proposed.

Mailing Address: Texas Instruments, Post Office Box 655303, Dallas, Texas 75265
Copyright © 2023, Texas Instruments Incorporated